

The background features technical wireframe drawings of mechanical parts in shades of grey and orange. The Beta logo, a stylized orange 'B' inside a square, is positioned to the left of the word 'Beta' in a bold, orange, sans-serif font.

Beta



2 0 2 3
Catalogo generale

BETA È SINONIMO DI
AUDACIA. IMPEGNO. ARMONIA. TALENTO.



In Beta esiste un solo modo di fare le cose: farle bene.

Questo è il mondo di Beta, questo il principio che guida il nostro lavoro quotidiano in tutto il mondo, ispirati da quattro valori:

AUDACIA *di investire e rilanciare costantemente un'impresa creata da un artigiano italiano nel 1923, affermatasi nel mondo e in continua crescita da quattro generazioni.*

IMPEGNO *nel curare fino al minimo dettaglio la qualità dei nostri prodotti, perché ogni rivenditore sa di poter contare su un servizio efficiente, e ogni utilizzatore sulla precisione, l'affidabilità e la resistenza dei prodotti Beta.*

ARMONIA *delle linee, per un design di eccellenza, perché quando una cosa è fatta bene, esprime un perfetto equilibrio tra funzione e design.*

TALENTO *è la nostra risorsa più preziosa, quella che distingue le nostre persone e tutti coloro che scelgono Beta per non lasciare nulla al caso, nell'appassionante realizzazione delle proprie idee e dei propri sogni.*

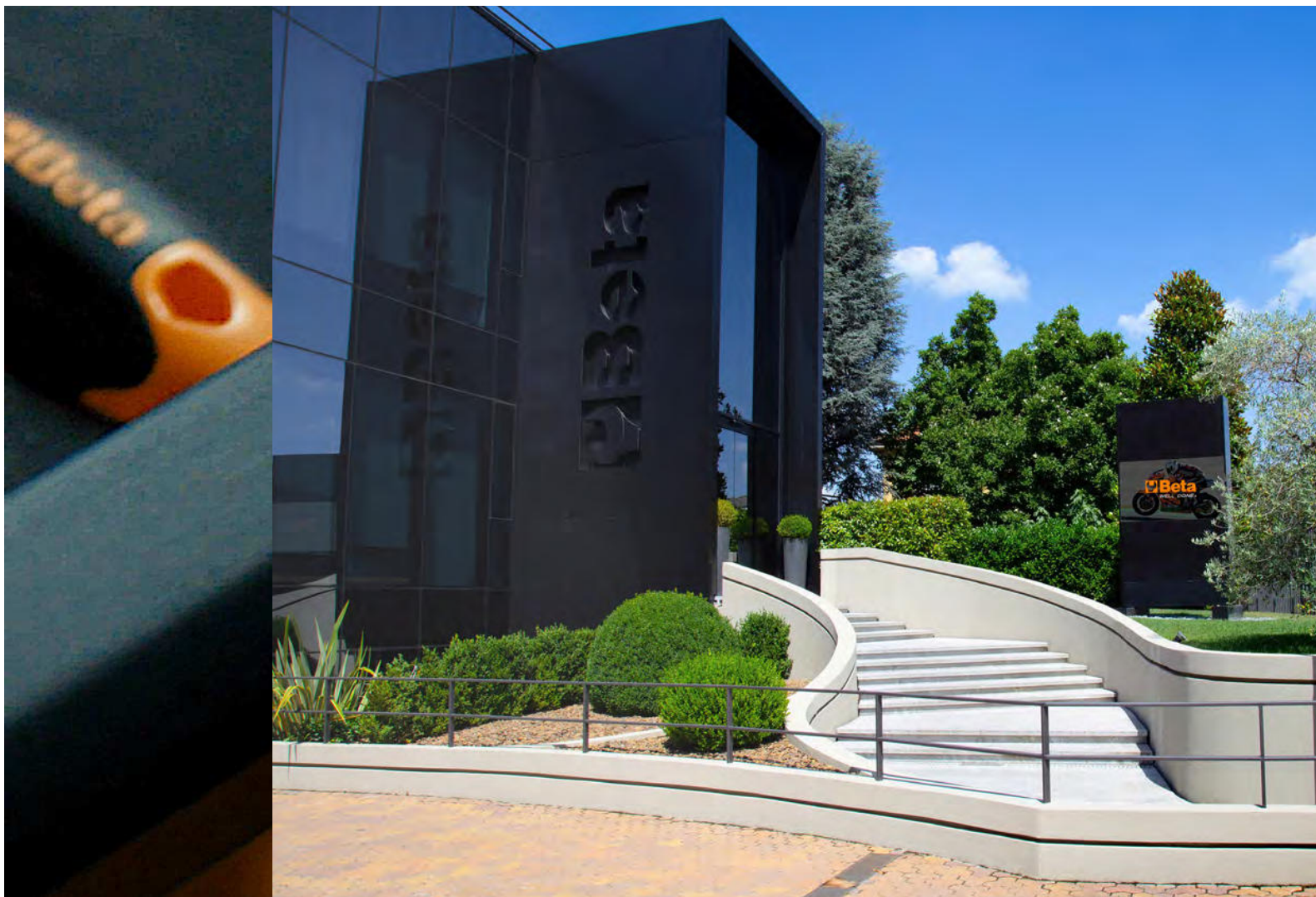

INDICE



	📖
Indice generale	4
Guida alla lettura	8
Campi di impiego chiavi dinamometriche	58-59
Tabella contenitori e assortimenti	341, 441-442
Servizio di taratura dinamometria	684
Articoli eliminati-articoli sostitutivi/consigliati	685÷687
Indice alfabetico	688÷692
Indice alfabetico Autoriparazione	693÷695
Indice alfanumerico	696÷710
Condizioni generali di vendita	711-712
Organizzazione di vendita	713
Il nostro servizio rapido	714
Numeri chiave Gruppo Beta.....	715
La storia dell'utensileria italiana	716
Qualità certificata	717
Controllo e qualità	718
Al servizio dell'industria	719
Logistica	720
Organizzazione del lavoro	721
Presenza competente	722

INDICE GENERALE

ARREDO OFFICINA RSC55



RSC55

398÷422

ARREDO OFFICINA C45PRO



Beta
C45PRO

423÷440

CONTENITORI E ASSORTIMENTI



341÷359

Beta
RSC



360÷370



371÷397



441÷520

CHIAVI DI MANOVRA



11÷17

24÷27

111÷117

CHIAVI A BUSSOLA E ACCESSORI



70÷78

85÷111

CHIAVI DINAMOMETRICHE E MOLTIPLICATORI



54÷56

57÷70

GIRAVITE, CHIAVI MASCHIO E INSERTI



18÷24

78÷85

115÷117

146÷159

PINZE E TRONCHESI



128÷132

140÷143

238

MARTELLI E SCALPELLI



9-10

166÷170

220

UTENSILI PER FORARE E FILETTARE



36÷41

41÷44

44÷51

51÷53

ESTRATTORI



170-171

201÷205

UTENSILI PER MISURARE E TRACCIARE



213÷220

UTENSILI PER TAGLIARE E MANUTENZIONI VARIE



123

133÷137

158-159

186



212

221÷230



239÷242

250÷251

ILLUMINAZIONE



243÷248

AVVOLGITORI



248÷250; 337

IDRAULICA



27÷35

ELETTRONICA E MICROMECCANICA



126-127

143÷145

149÷151

ELETTROTECNICA



137÷140

150

544÷546

234÷238

SALDATURA



252÷256

UTENSILI ISOLATI



287÷293

UTENSILI INOX



301÷305

UTENSILI ANTISCINTILLA



306÷314

AUTORIPARAZIONE



117÷126

160÷166



170÷201, 231÷233

234÷239

ATTREZZATURA DA OFFICINA



256÷275

UTENSILI PER MOTORIPARAZIONE



276÷281

UTENSILI PER BICICLETTA



282÷286

ELETTROUTENSILI



315÷317

UTENSILI PNEUMATICI E ACCESSORI



318÷340

UTENSILI ANTICADUTA



294÷300

PRODOTTI **CHIMICI**



521÷526

CALZATURE DI SICUREZZA (E CALZE TECNICHE)



583÷611

PRODOTTI **ABRASIVI**



527÷543

ABBIGLIAMENTO DA LAVORO



612÷630

PRODOTTI **ELETTRICI**



547÷553

GAMMA BLISTER



554÷568

ACCESSORI PER FUNI **ROBUR**



631÷671

SOLUZIONI PER IL PUNTO VENDITA



569÷582

BETA COLLECTION





672÷683

GUIDA ALLA LETTURA

numero articolo **1048N**
pinze regolabili cerniera chiusa
manici ricoperti con PVC antiscivolo

profilo utensile 

in confezione blister 

utensili per motoripazione 

utensili per biciclette 

★ articolo fornibile a richiesta
• misura principale
◻ bocca esagonale

misura

L	A max	L1	S	
mm	mm	mm	mm	
175	36	31	11	3 010480910
250	46	38	13	5 010480915
300	60	44	14.8	2 010480920

numero utensili nella confezione

numero codice

1048N/D3
serie di pinze regolabili cerniera chiusa
testa fosfatata

novità 2023

numero utensili nella serie

tipo confezione

contenuto della serie

1048N/D3
-175-250-300 mm
1 010480923

Interpretazione delle sigle più correnti

nelle serie		Esempio
B	= in busta di plastica	42/B9N
BV	= busta vuota	2002/BV9
C	= in cassetta	900/C11
D	= in confezione appendibile	1293/D6
S	= in scatola	42/S17
SP	= con supporto	42/SP25
SPV	= supporto vuoto	42/SPV7
SC	= con supporto compatto	96/SC9
SCV	= supporto compatto vuoto	96/SCV

negli assortimenti		Esempio
AS	= con chiavi in pollici	5915VU/AS
E	= versione Elettronica/Elettrotecnica	5980ET/A
I	= versione Idraulica	5980ID
MT	= versione Movimento Terra	5902MT
U	= versione Universale	5915VU/3
SBK	= versione Motoriparazione	5940SBK
VG	= versione Autoriparatori	5904VG/5T
VI	= versione Industria	5902VI

nelle chiavi a bussola		Esempio
A	= profilo esagonale	910A
B	= profilo poligonale	910B
ES	= profilo esascalato	920ES
FTX	= per viti TORX®	910FTX

Interpretazione delle sigle più correnti

PT	= per viti pentalobate	910PT
X	= cricchetto reversibile nelle cassette	920A/C12X

nei giravite e inserti per avvitatori

LP	= per viti con intaglio	920LP
PE	= per viti con impronta esagonale	920PE
PH	= per viti con impronta PHILLIPS®	920PH
PZ	= per viti con impronta POZIDRIV® - SUPADRIV®	1299PZ
RTX	= per viti con impronta TAMPER RESISTANT TORX®	1298RTX
SP	= per viti con impronta SPANNER	861SP
TRW	= per viti con impronta TRI-WING®	861TRW
TQS	= per viti con impronta TORQ-SET®	861TQS
TX	= per viti con impronta TORX®	920TX
XZN	= per viti con impronta XZN®	920XZN

in generale

AS	= misure in pollici	42AS
BA	= utensili anticintilla	42BA
BM	= impugnatura bimateriale	1150BM
C	= contenitore metallico vuoto	C25
HS	= utensili anticaduta	42HS
INOX	= utensili acciaio inossidabile	42 INOX
L	= modello lungo	952L
MQ	= utensili isolati a 1000V	1150MQ
MP	= finitura lucida	42MP
R	= ricambio	338R

Le immagini riprodotte sono indicative.

Beta Utensili S.p.A. si riserva il diritto di apportare aggiornamenti e migliorie alla propria gamma produttiva senza preavviso.



Beta **RACCOMANDA** il corretto utilizzo degli utensili ed il rispetto delle disposizioni per la sicurezza individuale.



UTENSILI A PERCUSSIONE

Gli utensili a percussione Beta sono progettati per ottenere le migliori performance garantendo sempre la massima sicurezza dell'operatore.

Per la produzione viene impiegato un acciaio speciale che contiene cromo, molibdeno e vanadio (65CrMoV2-2) che permette di ottenere durezza molto elevate mantenendo una notevole tenacità dell'utensile. Dove le geometrie lo consentono i prodotti sono realizzati partendo da barra trafilata, negli altri casi sono forgiati a caldo in atmosfera controllata per evitare la formazione di scoria.

1 I profili esagonali evitano all'utensile di rotolare sulla superficie di appoggio.

2 I cacciaspina hanno lo stelo molto lungo ma sempre perfettamente rettilineo per consentire l'accesso anche con poco spazio di manovra.

3 Per assicurare la corretta dimensione dei cacciaspina, effettuiamo l'intestatura di ogni singolo pezzo in modo che la parte cilindrica sia uniforme e l'estremità perfettamente piatta per una maggiore efficacia.

4 Tutti i battenti subiscono un processo di rinvenimento a induzione per escludere la propagazione di schegge; la deformazione del punto di battuta è una naturale conseguenza per salvaguardare la sicurezza dell'operatore.



L'affilatura di bulini e scalpelli avviene dopo il trattamento di cromatura per conferire maggiore capacità di incisione e taglio ma anche al fine di asportare il deposito galvanico dalla punta; occorre infatti eliminare il sovra deposito che tendenzialmente "arrotonda" gli spigoli e infragilisce il prodotto a causa dell'idrogeno prodotto durante l'elettrodeposizione. Le zone lavorate sono protette con uno strato protettivo anti ruggine.



30 punzoni

Ø mm	L mm	Icona	Icona
2	125	10	000300020
3	125	10	000300030
4	150	10	000300040
5	150	10	000300050
6	150	10	000300060

31 cacciaspina

Ø mm	L mm	L1 mm	Icona	Icona
2	110	22	10	000310002
3	128	35	10	000310003
4	146	45	10	000310004
5	164	55	10	000310005
6	182	65	5	000310006
8	200	80	5	000310008
10	220	95	5	000310010



31/B6N	2-3-4-5-6-8 mm	1	000310024
2002/BV6		1	020020000
31/SP6	2-3-4-5-6-8 mm	1	000310030
31/SPV		1	000310031

31BM cacciaspina con impugnatura

Ø mm	L mm	L1 mm	Icona	Icona
2	168	42	2	000310402
3	180	52	2	000310403
4	191	62	2	000310404
5	200	72	2	000310405
6	221	82	2	000310406
8	235	94	2	000310408

31BM/D6	2-3-4-5-6-8 mm	1	000310420
----------------	----------------	---	-----------

31L

cacciaspina tipo lungo



Ø mm	L mm	L1 mm	
4	175	80	5 000310104
5	175	80	5 000310105
6	175	80	5 000310106

31SE

cacciaspina per spine elastiche



Ø mm	D mm	L mm	L1 mm	
4	2,4	175	80	5 000310204
5	3,0	175	80	5 000310205
6	3,6	175	80	5 000310206



31/B6N-LSE	1 000310324
31L: 4-5-6 mm	
31SE: 4-5-6 mm	
2002/BV6	1 020020000

32

bulini



Ø mm	L mm	L1 mm	
3	100	44	10 000320100
4	125	52	10 000320125
5	150	62	10 000320150

32AU

bulino automatico



Ø mm	L mm	L1 mm	
3	150	23	2 000320160

32AUR

punta di ricambio



Ø mm	
3	5 000320170

34

scalpelli piatti



L mm	A mm	L1 mm	
125	14,5	45	5 000340001
150	17,0	58	5 000340002
175	21,5	68	5 000340003

35

scalpelli nervati



L mm	A mm	
100	14,5	5 000350001
125	17,0	5 000350002
150	20,5	5 000350003
200	23,0	5 000350004
250	28,5	2 000350005
300	34,0	2 000350006

35PM

scalpelli nervati con paramano



L mm	A mm	
200	23,0	2 000350014
250	28,5	2 000350015
300	34,0	2 000350016

35PMR

ricambi paramano



L mm	
200	1 000350024
250	1 000350025
300	1 000350026

36

ugnetti



L mm	A mm	L1 mm	
125	4	44	5 000360001
150	6	53	5 000360002

37

ugnetti nervati



L mm	A mm	L1 mm	
150	6	45	5 000370001
200	8	55	3 000370002

37PM

ugnetto nervato con paramano



L mm	A mm	
200	8	2 000370012

37PMR

ricambio paramano



L mm	
200	1 000370022



38/B6N	1 000380016
30: 2-3 mm	
32: 4 mm	
34: 125-150 mm	
36: 150 mm	
2002/BV6	1 020020000
38/SP6	1 000380009
30: 2-3 mm	
32: 4 mm	
34: 125-150 mm	
36: 150 mm	
38/SPV	1 000380019

LA ICONICA CHIAVE BETA

La forma della chiave 42 è perfettamente compatibile con tutti i contenitori e i moduli della chiave 42 storica

Una forma elegante e snella, alleggerita nelle linee e più leggera al tatto.

La forza, la resistenza e l'ergonomia della chiave Beta raggiungono valori ancora superiori per offrire la miglior chiave possibile alle mani degli utilizzatori. Il processo produttivo si svolge nei nostri stabilimenti di Sovico e Sulmona, avvalendosi delle tecnologie più avanzate in termini di automazione e degli operatori più preparati in termini di esperienza.

RAPIDITÀ

Angolo di 15° rispetto all'asse per ridurre l'angolo di ripresa

RESISTENZA

Grande resistenza: nel caso di uso improprio la chiave inizia a deformarsi, non si spezza in modo improvviso

OMOGENEITÀ

Lo stampaggio parte da un semilavorato a sezione tonda che garantisce alle fibre una distribuzione omogenea escludendo la formazione di pericolose tensioni interne

ACCESSIBILITÀ

Spessori ridotti per migliorare l'accessibilità

PROTEZIONE

La nichel-cromatura garantisce nel tempo la protezione dagli agenti esterni e supera le impegnative prove di aderenza della norma ISO 2819

OTTIMIZZAZIONE

La lunghezza della chiave, superiore alla maggior parte dei concorrenti, permette di ottenere coppie elevate con sforzo minore



ERGONOMIA

L'occhio poligonale è inclinato di 15° per proteggere la mano. La forma è ottenuta da stampo, non piegata successivamente



ATTENZIONE!

La forma della chiave 42 è perfettamente compatibile con tutti i contenitori e i moduli della chiave 42 storica

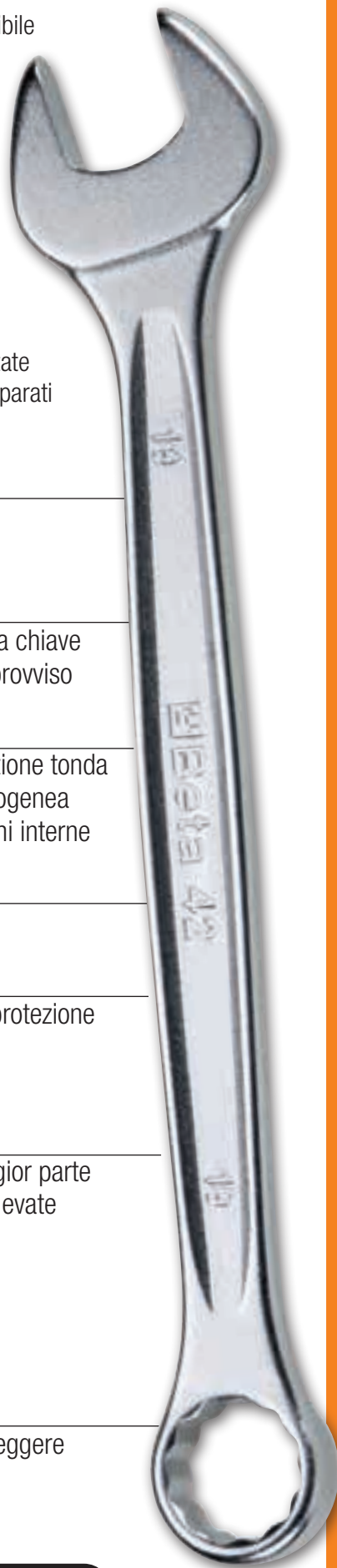

42

chiavi combinate

Coppie di serraggio più che doppie rispetto ai requisiti della norma ISO 1711



DIN 3113 UNI-ISO 7738

mm	L mm	S1 mm		
5,5x5,5	95	3,4	5	000421005
6x6	95	3,4	5	000421006
7x7	105	3,6	5	000421007
8x8	116	3,9	5	000421008
9x9	127	4,2	5	000421009
10x10	137	4,5	5	000421010
11x11	148	4,8	5	000421011
12x12	158	5,1	5	000421012
13x13	169	5,6	5	000421013
14x14	180	5,7	5	000421014
15x15	190	6,0	5	000421015
16x16	201	6,3	5	000421016
17x17	212	6,8	5	000421017
18x18	222	7,0	5	000421018
19x19	233	7,5	5	000421019
20x20	243	7,7	3	000421020
21x21	254	7,9	3	000421021
22x22	264	8,3	3	000421022
23x23	275	8,5	3	000421023
24x24	285	8,7	3	000421024
25x25	296	8,7	2	000421025
26x26	307	8,9	2	000421026
27x27	317	9,1	2	000421027
28x28	328	9,3	2	000421028
29x29	338	9,5	2	000421029
30x30	349	9,7	2	000421030
32x32	370	10,1	2	000421032
34x34	391	10,5	1	000421034
35x35	412	10,7	1	000421035
36x36	412	10,7	1	000421036
38x38	433	11,3	1	000421038
41x41	465	12,0	1	000421041



42/B9N	1	000421074
6-7-8-10-11-13-14-17-19 mm		
2002/BV9	1	020020030



42/S14	1	000421067
6-7-8-10-11-12-13-14		
-15-16-17-19-22-24 mm		
42/S17	1	000421065
6-7-8-9-10-11-12-13-14-15		
16-17-18-19-20-21-22 mm		
42/S15	1	000421066
6-7-8-10-11-12-13-14		
17-19-22-24-27-30-32 mm		
42/S17X	1	000421068
6-7-8-10-11-12-13-14-		
15-16-17-19-21-22-		
24-27-30 mm		
42/S26	1	000421070
6-7-8-9-10-11-12-13-14		
15-16-17-18-19-20-21		
22-23-24-25-26-27-28		
29-30-32 mm		

serie di 9 chiavi combinate con supporto compatto



42/SC9I	1	000421087
8-10-11-12-13-14-15-17-19 mm		
142/SCV9I	1	001420103
42/SC9E	1	000421088
8-10-11-12-13-16-17-18-19 mm		
142/SCV9E	1	001420104



42/SP25	1	000421085
6-7-8-9-10-11-12-13-14 15-16-17-18-19-20-21 22-23-24-25-26-27-28 30-32 mm		
42/SPV2	1	000420090



42/SP15

42/SPV...

42/SP15	1	000421078
6-7-8-9-10-11-12-13-14-15 16-17-19-22-24 mm		
42/SPV7	1	000420097
42: 8-10-11-13-14-17-19 mm 55: 6x7-8x9-10x11-12x13 14x15-16x17-18x19 mm		
42/SPV11	1	000420100
42MP: 8-9-10-11-12-13 14-15-16-17-19 mm 142-142SN: 8-9-10-11-12-13 14-15-16-17-19 mm		
42/SPV15	1	000420102
42: 6-7-8-9-10-11-12-13-14 15-16-17-19-22-24 mm		

42AS chiavi combinate



mm	L mm	
1/4x1/4	95	2 000420106
9/32X9/32	106	2 000420107
5/16x5/16	116	2 000420108
3/8x3/8	137	2 000420110
7/16x7/16	148	2 000420111
1/2x1/2	169	2 000420113
9/16x9/16	180	2 000420114
19/32X19/32	191	2 000420115
5/8x5/8	201	2 000420116
11/16x11/16	212	2 000420117
3/4x3/4	233	2 000420119
13/16x13/16	254	2 000420121
7/8x7/8	264	2 000420122
15/16x15/16	285	2 000420124
1x1	296	2 000420125
1.1/16x1.1/16	317	2 000420127
1.1/8x1.1/8	338	2 000420129
1.1/4x1.1/4	370	2 000420132
1.5/16x1.5/16	391	1 000420133
1.3/8x1.3/8	412	1 000420135
1.7/16x1.7/16	412	1 000420136
1.1/2x1.1/2	433	1 000420138



42AS/B9N	1	000420159
1/4-5/16-3/8-7/16-1/2 9/16-5/8-11/16-3/4		
2002/BV9	1	020020030

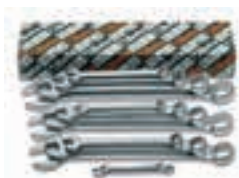

42AS/13	1	000420163
1/4-5/16-3/8-7/16-1/2-9/16-5/8 11/16-3/4-13/16-7/8-15/16-1		
42AS/16	1	000420166
1/4-5/16-3/8-7/16-1/2-9/16-5/8 11/16-3/4-13/16-7/8-15/16-1- 1.1/16-1.1/8-1.1/4		
42AS/17	1	000420168
1/4-9/32-5/16-3/8-7/16-1/2- 9/16-19/32-5/8-11/16-3/4- 13/16-7/8-15/16-1-1.1/16-1.1/8		



42MP chiavi combinate lucide



DIN 3113 UNI-ISO 7738

mm	L mm	
6x6	95	5 000420606
7x7	105	5 000420607
8x8	116	5 000420608
9x9	127	5 000420609
10x10	137	5 000420610
11x11	148	5 000420611
12x12	158	5 000420612
13x13	169	5 000420613
14x14	180	5 000420614
15x15	190	5 000420615
16x16	201	5 000420616
17x17	212	5 000420617
18x18	222	5 000420618
19x19	233	5 000420619
20x20	243	3 000420620
21x21	254	3 000420621
22x22	264	3 000420622
24x24	285	3 000420624
27x27	317	3 000420627
30x30	349	3 000420630
32x32	370	3 000420632



42MP/B9N	1	000420661
6-7-8-10-11-13-14-17-19 mm		
2002/BV9	1	020020030

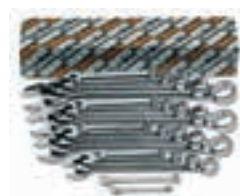

42MP/S17	1	000420652
6-7-8-9-10-11-12-13-14-15 16-17-18-19-20-21-22 mm		
42MP/S21	1	000420653
6-7-8-9-10-11-12-13-14 15-16-17-18-19-20-21-22 24-27-30-32 mm		

42LMP

chiavi combinate lunghe lucide



mm	L mm		
8x8	148	2	000420508
9x9	167	2	000420509
10x10	172	2	000420510
11x11	186	2	000420511
12x12	197	2	000420512
13x13	207	2	000420513
14x14	223	2	000420514
15x15	233	2	000420515
16x16	243	2	000420516
17x17	261	2	000420517
18x18	270	2	000420518
19x19	280	2	000420519
21x21	301	2	000420521
22x22	318	2	000420522
24x24	338	2	000420524
27x27	376	2	000420527
30x30	409	2	000420530
32x32	435	2	000420532



42LMP/S14
8-9-10-11-12-13-14
15-16-17-18-19-21-22 mm

1 000420551

42LMP/S18
8-9-10-11-12-13-14
15-16-17-18-19-21-22
24-27-30-32 mm

1 000420552

42SLIM

chiavi combinate a testa ribassata



DIN 3113 UNI-ISO 7738

mm	L mm	S1 mm		
8x8	116	3,4	5	000420408
10x10	137	3,8	5	000420410
11x11	148	3,8	5	000420411
12x12	158	4,2	5	000420412
13x13	169	4,4	5	000420413
14x14	180	4,6	5	000420414
15x15	190	4,7	5	000420415
16x16	201	4,7	5	000420416
17x17	212	5,1	5	000420417
18x18	222	5,1	5	000420418
19x19	233	5,6	5	000420419



42SLIM/B8NI
10-11-12-13-14-15-17-19 mm

1 000420478

42SLIM/B8NE
10-11-12-13-16-17-18-19 mm

1 000420479

2002/BV8

1 020020020



42SLIM/S11
8-10-11-12-13-14-15-
16-17-18-19 mm

1 000420471

45

chiavi combinate tipo pesante



DIN 3113 UNI-ISO 7738

mm	L mm		
46x46	500	1	000450046
50x50	540	1	000450050
55x55	560	1	000450055
60x60	600	1	000450060
65x65	675	1	000450065
70x70	675	1	000450070
75x75	720	1	000450075
80x80	720	1	000450080

52

chiavi a forchetta semplici



UNI 6733 DIN 3114

mm	L mm		
10	119	5	000520010
11	119	5	000520011
12	119	5	000520012
13	145	5	000520013
14	145	5	000520014
15	145	5	000520015
16	159	5	000520016
17	159	5	000520017
18	159	5	000520018
19	175	5	000520019
20	175	5	000520020
21	175	5	000520021
22	196	2	000520022
23	196	2	000520023
24	196	2	000520024
25	215	2	000520025
26	215	2	000520026
27	215	2	000520027
28	240	2	000520028
30	240	2	000520030
32	270	2	000520032
34	270	1	000520034
35	295	1	000520035
36	295	1	000520036
38	295	1	000520038
40	335	1	000520040
41	335	1	000520041
42	335	1	000520042
45	370	1	000520045
46	370	1	000520046
48	370	1	000520048
50	415	1	000520050
52	415	1	000520052
55	415	1	000520055
60	490	1	000520060
65	490	1	000520065
70	490	1	000520070

53

chiavi a forchetta DIN 894



mm	L mm		
36	317	1	000530036
38	320	1	000530038
41	342	1	000530041
46	396	1	000530046
50	412	1	000530050
55	457	1	000530055
60	492	1	000530060
65	528	1	000530065
70	572	1	000530070
75	608	1	000530075
80	645	1	000530080
85	690	1	000530085
90	690	1	000530090
95	847	1	000530095
100	847	1	000530100
105	1000	1	000530105
110	1000	1	000530110
115	1000	1	000530115
120	1000	1	000530120
125	1000	1	000530125
130	1000	1	000530130
135	1000	1	000530135

55

chiavi a forchetta doppie



UNI-ISO 10102 DIN 3110

mm	L mm		
4x5	101	5	000550003
5x5,5	101	5	000550006
5,5x7	120	5	000550009
6x7	120	5	000550012
7x8	140	5	000550018
8x9	140	5	000550021
8x10	140	5	000550024
10x11	155	5	000550030
10x12	155	5	000550033
10x13	170	5	000550035
12x13	170	5	000550042
12x14	170	5	000550045
13x14	185	5	000550047
13x17	189	5	000550051
14x15	185	5	000550054
14x17	189	5	000550057
16x17	202	5	000550060
17x19	220	2	000550063
18x19	220	2	000550066
19x22	236	2	000550069
20x22	236	2	000550075
21x23	245	2	000550078
22x24	245	2	000550081
24x26	262	2	000550087
24x27	262	2	000550090
25x28	272	2	000550096
27x29	284	2	000550099
27x30	284	2	000550102
27x32	297	2	000550105
30x32	297	2	000550108
32x36	325	1	000550114
34x36	325	1	000550117
35x38	375	1	000550120
36x41	375	1	000550123
41x46	425	1	000550129
46x50	475	1	000550132
50x55	500	1	000550135
55x60	500	1	000550138



55/B8N	1	000550160
6x7-8x9-10x11-12x13 14x15-16x17-18x19 20x22 mm		
2002/BV8	1	020020020
55/B12N	1	000550164
6x7-8x9-10x11-12x13 14x15-16x17-18x19 20x22-21x23-24x26 25x28-30x32 mm		
2002/BV12	1	020020040

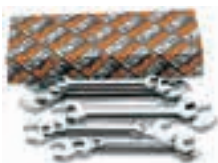

55/S8	1	000550174
6x7-8x9-10x11-12x13 14x15-16x17-18x19 20x22 mm		
55/S12	1	000550178
6x7-8x9-10x11-12x13 14x15-16x17-18x19 20x22-21x23-24x26 25x28-30x32 mm		
55/S12X	1	000550179
6x7-8x9-10x11-12x13 14x15-16x17-18x19 20x22-21x23-24x27 25x28-30x32 mm		
55/S13	1	000550182
6x7-8x9-10x11-12x13 14x15-16x17-18x19 20x22-21x23-24x26 25x28-27x29-30x32 mm		



55/SP7



55/SP13

55/SP7	1	000550167
6x7-8x9-10x11-12x13 14x15-16x17-18x19 mm		
42/SPV7	1	000420097
42: 8-10-11-13-14-17-19 mm		
55: 6x7-8x9-10x11-12x13		
14x15-16x17-18x19 mm		
55/SP13	1	000550186
6x7-8x9-10x11-12x13 14x15-16x17-18x19 20x22-21x23-24x26 25x28-27x29-30x32 mm		
55/SPV	1	000550190

55AS

chiavi a forchetta doppie



mm	L mm		
1/4x9/32	120	2	000550203
1/4x5/16	120	2	000550206
5/16x11/32	140	2	000550209
5/16x3/8	140	2	000550212
3/8x7/16	155	2	000550215
7/16x1/2	170	2	000550218
1/2x9/16	170	2	000550221
9/16x5/8	185	2	000550224
19/32x11/16	189	2	000550227
5/8x11/16	202	2	000550230
5/8x3/4	202	2	000550233
11/16x13/16	220	2	000550242
3/4x7/8	236	2	000550245
25/32x13/16	236	2	000550244
7/8x15/16	245	2	000550251
15/16x1	262	1	000550257
1x1.1/8	272	1	000550259
1.1/16x1.1/4	284	1	000550267
1.1/8x1.5/16	297	1	000550266
1.5/16x1.1/2	325	1	000550269
1.3/8x1.1/2	375	1	000550272
1.7/16x1.5/8	375	1	000550275

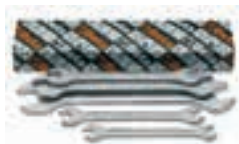

55AS/5	1	000550290
5/16x11/32-3/8x7/16 1/2x9/16-5/8x11/16 3/4x7/8		
55AS/8	1	000550296
1/4x9/32-5/16x11/32-3/8x7/16- 1/2x9/16-9/16x5/8-5/8x11/16- 11/16x13/16-3/4x7/8		
55AS/12	1	000550298
1/4x9/32-5/16x11/32-3/8x7/16-1 /2x9/16-9/16x5/8-5/8x11/16- 11/16x13/16-25/32x13/16-3/4x7/8- 15/16x1-1x1.1/8-1.1/16x1.1/4		

55MP

chiavi a forchetta doppie lucide



UNI-HISO 10102 DIN 3110

mm	L mm		
6x7	120	2	000550603
8x9	140	2	000550606
10x11	155	2	000550609
12x13	170	2	000550612
14x15	185	2	000550615
16x17	202	2	000550618
18x19	220	2	000550621
20x22	236	2	000550624
21x23	245	2	000550627
24x26	262	1	000550630
25x28	272	1	000550633
27x29	284	1	000550636
30x32	297	1	000550639

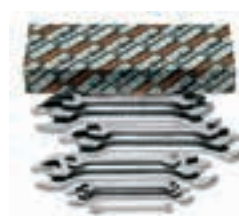

55MP/S8	1	000550650
6x7-8x9-10x11-12x13 14x15-16x17-18x19 20x22 mm		
55MP/S13	1	000550651
6x7-8x9-10x11-12x13 14x15-16x17-18x19 20x22-21x23-24x26 25x28-27x29-30x32 mm		
55MP/S12	1	000550653
6x7-8x9-10x11-12x13-14x15- 16x17-18x19-20x22-21x23-24x26- 25x28-30x32 mm		

58

chiavi a forchetta a percussione



DIN 133

mm	L mm		
24	177	1	000580024
27	180	1	000580027
30	190	1	000580030
32	190	1	000580032
34	200	1	000580034
36	215	1	000580036
41	235	1	000580041
46	255	1	000580046
50	275	1	000580050
55	300	1	000580055
60	320	1	000580060
65	342	1	000580065
70	375	1	000580070
75	375	1	000580075
80	408	1	000580080
85	408	1	000580085
90	445	1	000580090
95	445	1	000580095
100	485	1	000580100
105	485	1	000580105
110	510	1	000580110
115	510	1	000580115
120	545	1	000580120
125	545	1	000580125
130	575	1	000580130
135	575	1	000580135
*140	575	1	000580140
*145	640	1	000580145
*150	640	1	000580150
*155	640	1	000580155
*160	640	1	000580160
*165	715	1	000580165
*170	715	1	000580170
*175	715	1	000580175
*180	715	1	000580180
*185	715	1	000580185
*190	800	1	000580190
*195	800	1	000580195
*200	800	1	000580200
*210	800	1	000580210
*220	800	1	000580220
*230	800	1	000580230

73

chiavi a forchetta doppie piccole



UNI 6737

mm	L mm		
4x4	78	5	000730040
4,5x4,5	78	5	000730045
5x5	78	5	000730050
5,5x5,5	86	5	000730055
6x6	86	5	000730060
7x7	86	5	000730070
8x8	97	5	000730080
9x9	97	5	000730090
10x10	108	5	000730100
11x11	108	5	000730110
12x12	124	5	000730120
13x13	124	5	000730130
14x14	124	5	000730140



73/B13N
4-4,5-5-5,5-6-7-8-9
10-11-12-13-14 mm
2002/BV13

1 000730202
1 020020050



73/S13
4-4,5-5-5,5-6-7-8-9
10-11-12-13-14 mm

1 000730210



78

chiavi poligonali a percussione



DIN 7444

mm	L mm		
24	162	1	000780024
27	180	1	000780027
30	190	1	000780030
32	190	1	000780032
34	200	1	000780034
36	205	1	000780036
41	225	1	000780041
46	235	1	000780046
50	250	1	000780050
55	265	1	000780055
60	275	1	000780060
65	295	1	000780065
70	325	1	000780070
75	325	1	000780075
80	350	1	000780080
85	350	1	000780085
90	390	1	000780090
95	390	1	000780095
100	420	1	000780100
105	420	1	000780105
110	450	1	000780110
115	450	1	000780115
120	490	1	000780120
125	480	1	000780125
130	520	1	000780130
135	520	1	000780135
*140	520	1	000780140
*145	580	1	000780145
*150	580	1	000780150
*155	580	1	000780155
*160	650	1	000780160
*165	650	1	000780165
*170	650	1	000780170
*175	650	1	000780175
*180	650	1	000780180
*185	695	1	000780185
*190	695	1	000780190
*195	695	1	000780195
*200	695	1	000780200
*210	740	1	000780210
*215	740	1	000780215
*220	740	1	000780220
*230	740	1	000780230

78AS

chiavi poligonali a percussione



"	L mm		
*1.1/16	180	1	000780327
*1.1/8	190	1	000780329
*1.3/16	190	1	000780330
*1.1/4	197	1	000780332
*1.5/16	197	1	000780333
*1.3/8	223	1	000780335
*1.7/16	223	1	000780336
*1.1/2	223	1	000780338
*1.5/8	223	1	000780341
*1.11/16	225	1	000780343
*1.13/16	240	1	000780346
*1.7/8	250	1	000780348
*2	250	1	000780350
*2.1/16	250	1	000780352
*2.3/16	275	1	000780355
*2.3/8	270	1	000780360
*2.9/16	302	1	000780365
*2.3/4	350	1	000780370
*2.15/16	350	1	000780375
*3.1/8	354	1	000780380

80

chiavi a bussola poligonale snodate doppie



mm	L mm		
6x7	170	3	000800006
8x9	176	3	000800008
8x10	179	3	000800009
10x11	182	3	000800010
12x13	228	3	000800012
14x15	232	3	000800014
13x17	231	3	000800015
16x17	234	2	000800016
18x19	285	2	000800018
19x22	287	2	000800019
20x22	289	2	000800020
21x23	289	2	000800021
24x27	405	2	000800024
30x32	413	2	000800030



80/S8
6x7-8x9-10x11-12x13-14x15
16x17-18x19-20x22 mm
1 000800051

80/S11
6x7-8x9-10x11-12x13
14x15-16x17-18x19-20x22
21x23-24x27-30x32 mm
1 000800056

83

chiavi poligonali per starter



ISO 3318

mm	L mm		
8x10	126	3	000830008
10x12	137	3	000830010
11x13	138	3	000830011
14x17	183	3	000830014
15x17	184	2	000830015
16x18	196	2	000830016
19x22	231	2	000830019



83/S3
11x13-14x17-19x22 mm
1 000830081

83/S5
10x12-11x13-15x17
16x18-19x22 mm
1 000830085

83AS

chiavi poligonali per starter



mm	L mm		
7/16x1/2	138	2	000830111
9/16x5/8	183	2	000830114
3/4x7/8	230	2	000830119



83AS/3			
7/16x1/2-9/16x5/8	3/4x7/8	2	000830181

88

chiavi poligonali doppie diritte extralunghe



mm	L mm		
8x10	235	2	000880008
12x14	330	2	000880012
13x15	330	2	000880013
16x18	405	2	000880016
17x19	405	2	000880017
21x23	435	2	000880021
22x24	435	2	000880022



88/S7			
8x10-12x14-13x15-16x18-17x19-21x23-22x24 mm		2	000880107

90

chiavi poligonali doppie curve



DIN 838 ISO 10104

mm	L mm		
6x7	165	5	000900006
8x9	180	5	000900012
8x10	180	5	000900015
10x11	195	5	000900018
10x12	195	5	000900021
11x13	215	5	000900024
12x13	215	5	000900027
12x14	215	5	000900030
14x15	230	5	000900033
14x17	250	5	000900036
16x17	250	5	000900039
17x19	265	5	000900042
18x19	265	5	000900045
19x22	285	3	000900048
20x22	285	3	000900051
21x23	305	2	000900057
22x24	305	2	000900060
24x26	325	2	000900063
24x27	325	2	000900067
25x28	340	2	000900070
27x29	355	2	000900073
27x30	355	2	000900076
27x32	375	2	000900078
30x32	375	2	000900080
32x36	395	1	000900088
34x36	415	1	000900089
35x38	415	1	000900091
36x41	435	1	000900094
41x46	460	1	000900097
46x50	500	1	000900100



90/B8N			
6x7-8x9-10x11-12x13-14x15-16x17-18x19-20x22 mm		1	000900156

2002/BV8			
		1	020020020



90/S8			
6x7-8x9-10x11-12x13-14x15-16x17-18x19-20x22 mm		1	000900162

90/S12			
6x7-8x9-10x11-12x13-14x15-16x17-18x19-20x22-21x23-24x26-25x28-30x32 mm		1	000900166

90/S12X			
6x7-8x9-10x11-12x13-14x15-16x17-18x19-20x22-21x23-24x27-25x28-30x32 mm		1	000900167

90/S13			
6x7-8x9-10x11-12x13-14x15-16x17-18x19-20x22-21x23-24x26-25x28-27x29-30x32 mm		1	000900170



90/SP13			
6x7-8x9-10x11-12x13-14x15-16x17-18x19-20x22-21x23-24x26-25x28-27x29-30x32 mm		1	000900174

55/SPV			
		1	000550190

90AS

chiavi poligonali doppie curve



mm	L mm		
1/4x5/16	165	2	000900203
5/16x11/32	180	2	000900206
5/16x3/8	180	2	000900209
3/8x7/16	195	2	000900212
7/16x1/2	215	2	000900215
1/2x9/16	230	2	000900218
9/16x5/8	230	2	000900221
19/32x11/16	250	2	000900222
5/8x11/16	250	2	000900224
5/8x3/4	265	2	000900227
11/16x3/4	265	1	000900230
11/16x13/16	265	1	000900233
3/4x25/32	265	1	000900235
3/4x7/8	285	1	000900237
13/16x7/8	285	1	000900240
7/8x15/16	305	1	000900243
15/16x1	325	1	000900252
1.1/16x1.1/4	375	1	000900258
1.1/8x1.5/16	375	1	000900261



90AS/8			
1/4x5/16-5/16x11/32-3/8x7/16-1/2x9/16-5/8x11/16-11/16x3/4-13/16x7/8-15/16x1		1	000900298

90AS/10			
1/4x5/16-5/16x11/32-3/8x7/16-1/2x9/16-5/8x11/16-11/16x3/4-13/16x7/8-15/16x1-1.1/16x1.1/4-1.1/8x1.5/16		1	000900300

 Beta

 Beta

91

chiavi poligonali curve



mm	Ø		
mm	mm		
24	38	1	000910024
27	41	1	000910027
30	48	1	000910030
32	49	1	000910032
36	54	1	000910036
41	62	1	000910041
46	69	1	000910046
50	76	1	000910050
55	81	1	000910055
60	90	1	000910060
65	98	1	000910065
70	105	1	000910070
75	110	1	000910075
80	125	1	000910080
85	125	1	000910085
90	140	1	000910090
95	140	1	000910095
100	143	1	000910100
105	146	1	000910105

92

leve di manovra per art. 91



	L	91	Ø		
	mm	mm	mm		
92/1	460	24÷30	19	1	000920010
92/2	610	32÷41	22	1	000920020
92/3	760	46÷55	25	1	000920030
92/4	860	60÷105	30	1	000920040

93

chiave per ponteggi



mm	L		
mm	mm		
21x22	310	3	000930021

93C

chiavi a cricchetto per ponteggi



mm	L		
mm	mm		
17x19	310	1	000930117
19x22	310	1	000930119
19x24	310	1	000930120
21x22	365	1	000930121
36x38	445	1	000930136

94

chiavi per raccordi tubi



DIN 3118

mm	L		
mm	mm		
8x10	140	2	000940008
9x11	153	2	000940009
10x11	153	2	000940010
11x13	175	2	000940011
12x14	175	2	000940012
13x15	175	2	000940013
14x15	175	2	000940014
14x17	195	2	000940015
17x19	212	2	000940017
19x22	228	2	000940019
22x24	242	2	000940022
24x27	260	2	000940024
30x32	300	2	000940030
36x41	320	1	000940036



94/S6 1 000940050

8x10-10x11-11x13-12x14
17x19-19x22 mm

94/S10 1 000940052

8x10-9x11-10x11-11x13
12x14-17x19-19x22
22x24-24x27-30x32 mm

95

chiavi poligonali doppie diritte



DIN 837 ISO 10103

mm	L		
mm	mm		
6x7	120	3	000950161
8x9	135	3	000950162
10x11	150	3	000950163
12x13	165	3	000950164
14x15	185	3	000950165
16x17	210	3	000950166
17x19	225	3	000950167
18x19	225	2	000950168
20x22	240	2	000950169
21x23	255	2	000950170
24x26	270	2	000950171
25x28	285	2	000950172
27x29	315	2	000950173
30x32	335	2	000950174



95/S8 1 000950177

6x7-8x9-10x11-12x13
14x15-16x17-18x19
20x22 mm

95/S13 1 000950179

6x7-8x9-10x11-12x13
14x15-16x17-18x19
20x22-21x23-24x26
25x28-27x29-30x32 mm

95FTX

chiavi doppie diritte per viti con teste a profilo Torx®



	L		
	mm		
E6xE8	115	2	000950306
E10xE12	143	2	000950310
E14xE18	177	2	000950314
E20xE24	224	2	000950320



95FTX/S4 1 000950325

E6xE8-E10xE12
E14xE18-E20xE24



Beta

CHIAVI MASCHIO ESAGONALE

meglio note come chiavi a brugola

Le chiavi maschio Beta sono realizzate per operare a lungo e con precisione. L'ampia gamma copre qualunque necessità d'impiego: chiavi extra-corte, corte, lunghe, extra-lunghe, con testa sferica fino ad arrivare alle chiavi a T e a quelle con impugnatura, veri articoli distintivi del marchio Beta e senza paragoni sul mercato.

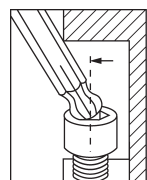

Le chiavi con estremità sferica consentono di operare fino a 30° rispetto all'asse della vite.

Il supporto con apertura a portafoglio permette di individuare rapidamente la misura necessaria. Una volta chiuso impedisce la fuoriuscita accidentale delle chiavi, anche delle più piccole.

La versione Color affianca alle ottime caratteristiche delle chiavi standard l'immediata individuazione della misura per velocizzare il lavoro quotidiano.

96

chiavi maschio esagonale piegate cromate



ISO 2936

mm	L mm	L1 mm	
0,9	35	8	20 000960013
1,3	39	10	20 000960014
1,5	45	15	20 000960015
2	50	17	20 000960020
2,5	57	20	20 000960025
3	64	22	20 000960030
3,5	68	25	20 000960035
4	72	28	20 000960040
4,5	78	30	20 000960045
5	83	32	20 000960050
5,5	88	35	20 000960055
6	94	37	20 000960060
7	99	40	10 000960070
8	105	43	10 000960080
9	111	46	10 000960090
10	119	49	10 000960100
11	126	52	10 000960110
12	134	56	10 000960120
13	142	62	10 000960130
14	151	69	10 000960140
16	165	75	5 000960160
17	174	79	5 000960170
19	196	88	5 000960190
22	216	100	3 000960220
24	242	112	1 000960240
27	271	125	1 000960270
30	309	140	1 000960300
32	341	155	1 000960312
36	385	174	1 000960316



96/ST6
2,5-3-4-5-6-8 mm
3 000960370



96/BGS7
1,5-2-2,5-3-4-5-6 mm
1 000960367



96/BG7
2,5-3-4-5-6-8-10 mm
1 000960368



96/B8
2-2,5-3-4-5-6-8-10 mm
5 000960386
96/B10
1,5-2-2,5-3-4-5-6-8-10-12 mm
5 000960380
96N/BV
1 000960651



96/SC9
1,5-2-2,5-3-4-5-6-8-10 mm
1 000960374
96/SCV
1 000960985



96/SC12
2-2,5-3-3,5-4-4,5-5-6-7-8-9-10 mm
1 000960395
96/SCV12
1 000960975

96N

chiavi maschio esagonale piegate brunate



ISO 2936

mm	L mm	L1 mm	
0,9	32	10	20 000960409
1,3	44	12	20 000960413
1,5	46	15	20 000960415
2	51	17	20 000960420
2,5	57	20	20 000960425
3	64	22	20 000960430
3,5	68	25	20 000960435
4	72	28	20 000960440
4,5	78	30	20 000960445
5	83	32	20 000960450
6	94	37	20 000960460
7	99	40	10 000960470
8	105	43	10 000960480
9	111	46	10 000960490
10	119	49	10 000960500
11	126	52	10 000960510
12	134	56	10 000960520
13	142	62	10 000960530
14	151	69	10 000960540
16	165	72	5 000960560
17	174	79	5 000960570
19	194	88	5 000960590
22	216	99	1 000960592
24	242	111	1 000960594



96N/ST6
2,5-3-4-5-6-8 mm

3 000960640



96N/G7
2,5-3-4-5-6-8-10 mm
96N/G7A
1,5-2-2,5-3-4-5-6 mm

3 000960645
3 000960643



96N/B10
1,5-2-2,5-3-4-5-6
8-10-12 mm
96N/BV

5 000960650
1 000960651



96N/SC9
1,5-2-2,5-3-4-5-6-8-10 mm
96N/SCV

1 000960644
1 000960986



96N/SC12
2-2,5-3-3,5-4-4,5-5
6-7-8-9-10 mm
96N/SCV12

1 000960661
1 000960976

96C/AS

chiavi maschio esagonale piegate cromate



"	L mm	L1 mm	g		
1/16	46	16	1,01	20	000961702
3/32	53	19	2,70	20	000961706
1/8	60	22	5,33	20	000961710
5/32	67	25	9,33	20	000961714
3/16	74	28	14,87	20	000961716
7/32	81	32	22,00	20	000961718
1/4	89	35	31,40	20	000961720
5/16	103	40	56,16	10	000961724
3/8	117	45	91,31	10	000961728



96C-AS/SC9
1/16-3/32-1/8-5/32-3/16-
7/32-1/4-5/16-3/8

1 000961753

96AS

chiavi maschio esagonale piegate brunite



"	L mm	L1 mm		
1/30 (0,035")	44	14	20	000960698
1/20 (0,050")	44	15	20	000960701
1/16	46	16	20	000960702
5/64	50	18	20	000960704
3/32	53	19	20	000960706
7/64	57	21	20	000960708
1/8	60	22	20	000960710
9/64	64	24	20	000960712
5/32	68	25	20	000960714
3/16	75	29	20	000960716
7/32	82	32	20	000960718
1/4	89	35	20	000960720
5/16	103	40	10	000960724
3/8	117	44	10	000960728
7/16	132	49	10	000960730
1/2	149	54	10	000960732
9/16	151	69	2	000960734
5/8	165	72	1	000960736
3/4	194	88	1	000960738



96AS/SC9
1/16-3/32-1/8-5/32-3/16
7/32-1/4-5/16-3/8

1 000960743

96AS/SCV 1 000960744



96AS/T7
3/32-1/8-5/32
3/16-7/32-1/4-5/16

3 000960740



96AS/BG7
3/32-1/8-5/32-3/16
1/4-5/16-3/8

1 000960747



96AS/B11
1/20-1/16-5/64-3/32
1/8-5/32-3/16-7/32
1/4-5/16-3/8
96N/BV

1 000960749

1 000960651



96LC

chiavi maschio esagonale piegate tipo lungo, cromate



ISO 2936

mm	L mm	L1 mm		
2	101	17	20	000960320
2,5	113	20	20	000960321
3	127	22	20	000960322
3,5	138	25	20	000960323
4	142	28	20	000960324
4,5	154	28	20	000960325
5	163	32	20	000960326
6	184	37	20	000960327
7	194	40	10	000960328
8	205	43	10	000960329
9	216	46	10	000960330
10	231	49	10	000960331
12	259	56	10	000960332





96LC/SC8
2-2,5-3-4-5-6-8-10 mm
96LC/SCV

1 000960334
1 000960983



96LC/SC12
2-2,5-3-3,5-4-4,5-5-6-7-8-9-10 mm
96LC/SCV12

1 000960337
1 000960977

96L

chiavi maschio esagonale piegate tipo lungo, brunite



ISO 2936

mm	L mm	L1 mm	
2	99	15	20 000960820
2,5	110	17	20 000960825
3	124	19	20 000960830
3,5	135	21	20 000960835
4	138	24	20 000960840
4,5	150	25	20 000960845
5	158	27	20 000960850
6	178	31	20 000960860
7	187	33	10 000960870
8	197	35	10 000960880
9	207	37	10 000960890
10	221	39	10 000960900
12	247	44	10 000960920



96L/SC8
2-2,5-3-4-5-6-8-10 mm
96L/SCV

1 000960924
1 000960987



96L/SC12
2-2,5-3-3,5-4-4,5-5-6-7-8-9-10 mm
96L/SCV12

1 000960929
1 000960978

96BP-CL

chiavi maschio esagonale piegate con estremità sferica, cromate colorate



mm	L mm	L1 mm	
1,5	91	16	5 000961600
2	102	17	5 000961601
2,5	113	21	5 000961602
3	128	23	5 000961603
4	143	28	5 000961604
5	163	33	5 000961605
6	185	37	5 000961606
8	206	43	2 000961608
10	231	50	2 000961610



96BP-CL/SC9
1,5-2-2,5-3-4-5-6-8-10 mm
96BP-CL/SCV

1 000961619
1 000961629

96BPC

chiavi maschio esagonale piegate con estremità sferica, cromate



mm	L mm	L1 mm	
1,5	79	13	10 000960340
2	84	15	10 000960341
2,5	89	17	10 000960342
3	99	19	10 000960343
4	108	24	10 000960344
5	126	27	10 000960345
6	148	31	10 000960346
7	157	33	5 000960353
8	168	35	5 000960347
10	187	39	5 000960348
12	220	55	5 000960352



96BPC/SC9
1,5-2-2,5-3-4-5-6-8-10 mm
96BPC/SCV

1 000960354
1 000960984

96BP

chiavi maschio esagonale piegate con estremità sferica, brunite

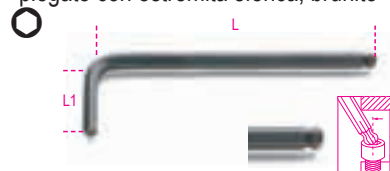

mm	L mm	L1 mm	
1,5	79	13	10 000960960
2	84	15	10 000960961
2,5	89	17	10 000960962
3	99	19	10 000960963
4	108	24	10 000960965
5	126	27	10 000960967
6	148	31	10 000960968
8	168	35	5 000960970
10	187	39	5 000960972
12	220	55	5 000960973



96BP/SC9
1,5-2-2,5-3-4-5-6-8-10 mm
96BP/SCV

1 000960974
1 000960988

96LBP

chiavi maschio esagonale piegate con estremità sferica, modello extralungo, cromate



mm	L mm	L1 mm	
1,5	90	15	5 000961340
2	100	17	5 000961341
2,5	112	20	5 000961342
3	127	22	5 000961343
4	144	27	5 000961344
5	163	32	5 000961345
6	184	37	5 000961346
8	204	44	2 000961348
10	230	49	2 000961350



96LBP/SC9
1,5-2-2,5-3-4-5-6-8-10 mm
96LBP/SCV

1 000961354
1 000961984

96BP/AS

chiavi maschio esagonale
piegate con estremità sferica, brunate



"	L mm	L1 mm		
3/32	89	17	10	000960989
1/8	98	18	10	000960990
5/32	108	24	10	000960991
3/16	126	26	10	000960992
7/32	139	28	10	000960993
1/4	152	31	10	000960994
5/16	168	34	5	000960995
3/8	190	39	5	000960996



96BP-AS/SC9	1	000961000
1/16-3/32-1/8-5/32-3/16		
7/32-1/4-5/16-3/8		
96BP-AS/SCV	1	000961001



96BP-AS/8	1	000960997
3/32-1/8-5/32-3/16-7/32		
1/4-5/16-3/8		
96BP-AS/BV	1	000960998

96BPA

chiavi maschio esagonale
piegate a 110° con estremità sferica,
modello lato extra corto, cromate



mm	L mm	L1 mm		
1,5	71	9	5	000961960
2	86	11	5	000961961
2,5	96	13	5	000961962
3	104	15	5	000961963
4	116	17	5	000961964
5	132	19	5	000961965
6	155	21	5	000961966
8	176	24	2	000961968
10	200	27	2	000961970



96BPA/SC9	1	000961974
1,5-2-2,5-3-4-5-6-8-10 mm		
96BPA/SCV	1	000961988

96T

CHIAVI MASCHIO ESAGONALE

con impugnatura

Rapida e maneggevole

L'impugnatura compatta è perfettamente bilanciata per ruotare rapidamente nel palmo della mano.

La forma ergonomica permette di applicare coppie molto elevate.

Le estremità esagonali sono calibrate per trasmettere la massima coppia possibile alla vite.

La barra a sezione tonda ha una struttura più omogenea rispetto alla sezione esagonale e offre una maggiore resistenza.



Lama passante all'interno dell'impugnatura

96T

chiavi maschio esagonale piegate
con impugnatura di manovra

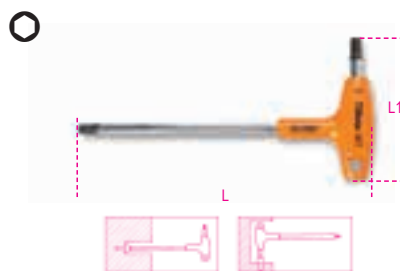

mm	L mm	L1 mm		
2	139	52	5	000960934
2,5	153	55	5	000960935
3	153	55	5	000960936
3,5	179	70	5	000960937
4	179	70	5	000960938
4,5	200	84	5	000960939
5	200	84	5	000960940
6	221	103	5	000960941
7	236	106	3	000960942
8	255	117	3	000960943
10	285	132	3	000960945



96T/S6	1	000960952
2-2,5-3-4-5-6 mm		
96T/S8	1	000960933
2-2,5-3-4-5-6-8-10 mm		
96T/S11	1	000960951
2-2,5-3-3,5-4-4,5-5-6-7-8-10 mm		



96T/SP11	1	000960957
2-2,5-3-3,5-4-4,5-5-6-7-8-10 mm		
96T/SPV	1	000960958
96T/S11		
97TTX/S11		

96T/AS

chiavi maschio esagonale piegate
con impugnatura di manovra



"	L mm	L1 mm		
3/32	153	55	2	000960669
7/64	153	55	2	000960670
1/8	179	70	2	000960671
9/64	179	70	2	000960672
5/32	200	84	2	000960673
3/16	200	84	2	000960674
7/32	221	103	2	000960675
1/4	236	106	2	000960676
5/16	255	117	2	000960678
3/8	285	132	2	000960680



96T/AS8	1	000960682
3/32-7/64-1/8-5/32-3/16-1/4-5/16-3/8		
96T/AS10	1	000960683
3/32-7/64-1/8-9/64-5/32-3/16-7/32-1/4-5/16-3/8		

96TBP

chiavi maschio esagonale piegate
con estremità sferica ed impugnatura
di manovra



mm	L mm	L1 mm		
2,5	153	55	3	000960685
3	153	55	3	000960686
4	179	70	3	000960687
5	200	84	3	000960688
6	221	103	3	000960689
8	255	117	2	000960690
10	285	132	2	000960692



96TBP/S6
2,5-3-4-5-6-8 mm

97TX

chiavi maschio piegate
per viti con impronta Torx®



	L mm	L1 mm		
T6	42	16	5	000970006
T7	48	16	5	000970007
T8	48	16	5	000970008
T9	48	16	5	000970009
T10	51	17	5	000970010
T15	54	18	5	000970015
T20	57	19	5	000970020
T25	60	20	5	000970025
T27	64	21	5	000970027
T30	70	24	5	000970030
T40	76	26	5	000970040
T45	83	29	5	000970045
T50	95	32	5	000970050
T55	108	35	5	000970055
T60	120	38	5	000970060



97TX/ST8
T9-T10-T15-T20-T25
T27-T30-T40



97TX/G8
T9-T10-T15-T20-T25
T27-T30-T40



97TX/BG8
T9-T10-T15-T20-T25-T27-T30-T40



97TX/SC8
T9-T10-T15-T20-T25
T27-T30-T40
97TX/SCV



97TX/B13
T6-T7-T8-T9-T10-T15-T20
T25-T27-T30-T40-T45-T50
96N/BV

97BTX

chiavi maschio piegate
con un'estremità sferica
per viti con impronta Torx®

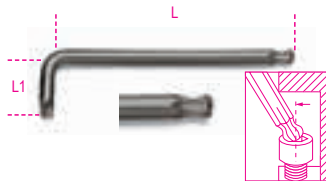

	L mm	L1 mm		
T9	62	16	5	000970109
T10	71	17	5	000970110
T15	81	18	5	000970115
T20	92	19	5	000970120
T25	94	20	5	000970125
T27	105	21	5	000970127
T30	114	24	5	000970130
T40	129	26	5	000970140
T45	133	28	5	000970145
T50	152	32	3	000970150
T55	164	35	3	000970155



97BTX/SC8
T9-T10-T15-T20-T25-T27-T30-T40
97BTX/SCV



97BTX/B8
T9-T10-T15-T20-T25
T27-T30-T40
96N/BV

97BTX-C

chiavi maschio piegate
con un'estremità sferica
per viti con impronta Torx®
colorate



	L mm	L1 mm		
T9	80	16	5	000971609
T10	86	17	5	000971610
T15	90	18	5	000971615
T20	95	19	5	000971620
T25	100	20	5	000971625
T27	105	21	5	000971627
T30	114	24	5	000971630
T40	124	26	5	000971640



97BTX-C/SC8
T9-T10-T15-T20-T25-T27-T30-T40
97BTX-C/SCV



97BTXL

chiavi maschio piegate con un'estremità sferica, modello lungo, per viti con impronta Torx®



	L mm	L1 mm		
T9	80	15	3	000970309
T10	86	17	3	000970310
T15	100	18	3	000970315
T20	110	19	3	000970320
T25	126	20	3	000970325
T27	140	24	3	000970327
T30	160	28	3	000970330
T40	176	32	3	000970340



97BTXL/SC8 T9-T10-T15-T20- T25-T27-T30-T40	1	000970364
97BTXL/SCV	1	000970982

97RTX

chiavi maschio piegate per viti con impronta Tamper Resistant Torx®



	L mm	L1 mm		
T6	40	15	5	000970206
T7	45	15	5	000970207
T8	50	16	5	000970208
T9	56	16	5	000970209
T10	62	17	5	000970210
T15	72	17	5	000970215
T20	83	18	5	000970220
T25	90	18	5	000970225
T27	100	20	5	000970227
T30	105	24	5	000970230
T40	112	26	5	000970240
T45	118	26	5	000970245
T50	122	28	3	000970250
T55	128	30	3	000970255



97RTX/SC8 T9-T10-T15-T20-T25 T27-T30-T40	1	000970263
97RTX/SCV	1	000970984



97RTX/B8 T9-T10-T15-T20-T25 T27-T30-T40	1	000970260
96N/BV	1	000960651

97TTX

chiavi maschio piegate con impugnatura per viti con impronta Torx®



	L mm	L1 mm		
T6	130	52	3	000970706
T7	130	52	3	000970707
T8	139	52	3	000970708
T9	139	52	3	000970709
T10	179	70	3	000970710
T15	179	70	3	000970715
T20	179	70	3	000970720
T25	179	70	3	000970725
T27	200	84	3	000970727
T30	200	84	3	000970730
T40	221	103	3	000970740
T45	236	106	2	000970745
T50	255	117	2	000970750



97TTX/S6 T10-T15-T20-T25-T30-T40	1	000970791
97TTX/S8 T8-T10-T15-T20-T25- T27-T30-T40	1	000970808
97TTX/S11 T8-T9-T10-T15-T20-T25 T27-T30-T40-T45-T50	1	000970800
97TTX/S13 T6-T7-T8-T9-T10-T15-T20-T25 T27-T30-T40-T45-T50	1	000970813



97TTX/SP11 T8-T9-T10-T15-T20-T25 T27-T30-T40-T45-T50	1	000970840
96T/SPV 96T/S11 97TTX/S11	1	000960958

98KZN

chiavi a profilo XZN®



DIN 65253

	L mm	L1 mm		
M5	83	25	5	000980005
M6	89	30	5	000980006
M8	97	32	5	000980008
M10	106	35	5	000980010
M12	116	37	5	000980012
M14	118	45	5	000980014
M16	125	45	5	000980016



98XZN/B5 M5-M6-M8-M10-M12	1	000980650
96N/BV	1	000960651

99

chiavi a settore con nasello quadro per ghiera



UNI 6752

	mm	A mm		
12-14	1,5	3	000990012	
16-18-20	1,8	3	000990016	
22-25-28	1,8	3	000990022	
30-32	2,1	3	000990030	
34-36-38	2,4	3	000990034	
40-42	2,4	3	000990040	
45-50	2,5	3	000990045	
52-55-58	2,5	3	000990052	
62-65	3,1	3	000990062	
68-70-75	3,1	3	000990068	
80-85-90	3,8	2	000990080	
92-95	4,3	2	000990092	
98-100	4,3	2	000990098	
105-110-115	4,4	1	000990105	
120-125-130	4,9	1	000990120	
135-145	6,0	1	000990135	
155-165	6,0	1	000990155	

99SQ

chiavi a settore articolate con nasello quadro



	mm	B mm		
15-35	2,7	2	000990215	
35-50	3,5	2	000990235	
50-80	4,7	2	000990250	
80-120	6,2	2	000990280	
120-180	7,8	2	000990290	

99ST

chiavi a settore articolate
con nasello tondo



Ø mm	Ø mm	B mm		
15-35	3,0	2,5	2	000990315
35-50	4,0	4,5	2	000990335
50-80	5,0	5,0	2	000990350
80-120	6,0	7,0	2	000990380
120-180	8,0	9,0	2	000990390

99 VN/...

nasello di ricambio per 99ST

	Ø mm			
99ST VN/15	15-35	1	000990295	
99ST VN/35	35-50	1	000990296	
99ST VN/50	50-80	1	000990297	
99ST VN/80	80-120	1	000990298	
99ST VN/120	120-180	1	000990299	

100

chiave a compasso con naselli tondi



Ø mm	L mm	Ø min-max mm		
4,9-5,9	250	18÷100	1	001000001
6,9-7,9				

100/KIT

naselli di ricambio per art. 100



100/KIT	1	001000010
---------	---	-----------

111E CHIAVI REGOLABILI A RULLINO

Le nuove chiavi a rullino **Beta 111E** consentono di avvitare e svitare dadi e bulloni di diverse dimensioni grazie alla ganaschia mobile, regolabile tramite il rullino posto al centro.

Testa inclinata di **15°** per manovrare anche negli spazi più difficili come le nostre iconiche chiavi combinate "42".



Apertura
della chiave
maggiorata.
Ingombro ridotto
della testa a
ganaschia
completamente
aperta.

Doppia marcatura
al laser in mm/pollici



Lo studio della nuova ergonomia ha permesso di avere un riduzione di peso del 20%.

Realizzata in acciaio legato ad alte prestazioni per un'elevata **resistenza** meccanica alle torsioni. Trattamenti termici dedicati per un'ottima resistenza all'usura. Foro su impugnatura per appendere la chiave.

111E

chiavi regolabili a rullino cromate
con scala graduata

- Rotazione destrorsa del rullino
- Scala in millimetri e in pollici



DIN 3117 ISO 6787

L mm	L "	A max mm		
100	4	15	3	001110110
150	6	24	3	001110115
200	8	29	3	001110120
250	10	34	3	001110125
300	12	40	3	001110130
380	15	45	3	001110138
450	18	54	2	001110145
600	24	62	1	001110160

111EN

chiavi regolabili a rullino fosfatate con scala graduata

- Rotazione sinistrorsa del rullino
- Scala in millimetri e in pollici



DIN 3117 ISO 6787

L mm	L "	A max mm		
100	4	15	3	001110410
150	6	24	3	001110415
200	8	29	3	001110420
250	10	34	3	001110425
300	12	40	3	001110430
380	15	45	3	001110438
450	18	54	2	001110445

111ER

chiavi regolabili a rullino cromate
con scala graduata a ganaschia reversibile

- Ganaschia reversibile
- Rotazione destrorsa del rullino
- Scala in millimetri e in pollici



L mm	L "	A max mm	Ø max "		
200	8	29	3/4	3	001110520
250	10	34	1	3	001110525
300	12	40	1.1/4	2	001110530

111CM

chiavi regolabili a rullino cromate corte
con apertura maggiorata

- Apertura maggiorata
- Rotazione destrorsa
- Scala in millimetri e in pollici



L mm	L "	A max mm		
170	6	32	2	001110770
220	8	38	3	001110722
270	10	46	3	001110727

Beta

120

chiavi poligonali aperte a cricchetto

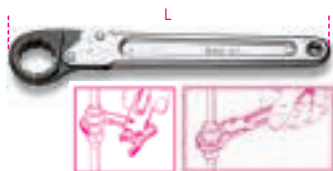

mm	L		
10	135	1	001200010
11	135	1	001200011
12	135	1	001200012
13	135	1	001200013
14	135	1	001200014
17	185	1	001200017
19	185	1	001200019
22	230	1	001200022
24	230	1	001200024
27	230	1	001200027
30	320	1	001200030
32	320	1	001200032



120/B6N	1	001200060
10-11-13		
17-19-22 mm		
2002/BVL6	1	020020010

123E1/4

adattatore portainseri 1/4" per chiavi a cricchetto 10 mm

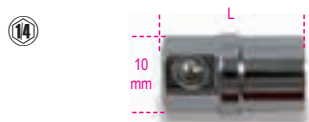

mm	L		
10	20,6	1	001230010

123Q1/4

adattatore a sgancio rapido 1/4" per chiavi a cricchetto 10 mm



mm	L		
10	17,5	1	001230310

123Q3/8

adattatore a sgancio rapido 3/8" per chiavi a cricchetto 13 mm

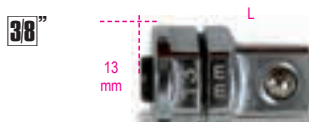

mm	L		
13	22,5	1	001230313

123Q1/2

adattatore a sgancio rapido 1/2" per chiavi a cricchetto 19 mm



mm	L		
19	30,5	1	001230319

123/K4

kit di 4 adattatori per chiavi a cricchetto:
1 adattatore per bits
3 adattatori a sgancio rapido



123/K4	1	001230504
--------	---	-----------

141

chiavi combinate dirette a cricchetto



ISO 21982:2020

mm	L		
8x8	136	3	001410008
9x9	143	3	001410009
10x10	160	3	001410010
11x11	168	3	001410011
12x12	174	3	001410012
13x13	180	3	001410013
14x14	193	2	001410014
15x15	200	2	001410015
16x16	216	2	001410016
17x17	233	2	001410017
18x18	239	2	001410018
19x19	250	2	001410019



141/B6	1	001410066
8-10-13-14-17-19 mm		
141/B9	1	001410069
8-10-11-12-13-14-15-17-19 mm		



141/S12	1	001410072
8-9-10-11-12-13-14-15-16-17-18-19 mm		

142

CHIAVI A CRICCHETTO

La rapidità del cricchetto a 72 denti offre un angolo di ripresa di soli 5° e permette serraggi veloci e precisi.

1 La bocca fissa permette forti serraggi grazie alla lunghezza elevata del gambo.

2 L'invertitore è incassato per evitare i rischi di inversione accidentale.

3 L'occhio poligonale è inclinato di 15° per proteggere la mano e consentire una migliore accessibilità.

4 La testa a bocca fissa è inclinata di 15° rispetto all'asse per ridurre l'angolo di ripresa.



142

chiavi combinate a cricchetto reversibile



ISO 21982:2020

mm	L		
6x6	136	3	001420006
7x7	136	3	001420007
8x8	136	3	001420008
9x9	143	3	001420009
10x10	159	3	001420010
11x11	168	3	001420011
12x12	174	3	001420012
13x13	180	3	001420013
14x14	190	2	001420014
15x15	200	2	001420015
16x16	216	2	001420016
17x17	233	2	001420017
18x18	239	2	001420018
19x19	248	2	001420019
21x21	285	1	001420021
22x22	285	1	001420022
24x24	325	1	001420024
27x27	355	1	001420027
30x30	420	1	001420030
32x32	420	1	001420032
34x34	482	1	001420034
36x36	482	1	001420036
38x38	482	1	001420038



142/B6 8-10-13-14-17-19 mm	1	001420066
142/BV6	1	001420076
142/B9 8-10-11-12-13-14-15-17-19 mm	1	001420069
142/BV9	1	001420079



142/S15 6-7-8-9-10-11-12-13 14-15-16-17-18-19-22 mm	1	001420074
142/S17 6-7-8-10-11-12-13-14-15- 16-17-18-19-21-22-24-27 mm	1	001420068
142/S19 6-7-8-9-10-11-12 13-14-15-16-17-18 19-22-24-27-30-32 mm	1	001420075

142/SC9I-E

serie di 9 chiavi combinate a cricchetto reversibile con supporto compatto



142/SC9I 8-10-11-12-13-14-15-17-19 mm	1	001420087
142/SCV9I	1	001420103
142/SC9E 8-10-11-12-13-16-17-18-19 mm	1	001420088
142/SCV9E	1	001420104

142MC

chiavi combinate a cricchetto reversibile colorate



ISO 21982:2020

mm	L mm		
8x8	136		3 001422008
10x10	159		3 001422010
11x11	168		3 001422011
12x12	174		3 001422012
13x13	180		3 001422013
14x14	190		2 001422014
15x15	200		2 001422015
16x16	216		2 001422016
17x17	233		2 001422017
18x18	239		2 001422018
19x19	248		2 001422019



142MC/SC9I 8-10-11-12-13-14-15-17-19 mm	1	001422087
142MC/SC9E 8-10-11-12-13-16-17-18-19 mm	1	001422088

142AS

chiavi combinate a cricchetto reversibile



mm	L mm	
5/16x5/16	136	2 001420308
3/8x3/8	159	2 001420310
7/16x7/16	168	2 001420311
1/2x1/2	180	2 001420313
9/16x9/16	190	2 001420314
5/8x5/8	216	2 001420316
11/16x11/16	233	2 001420317
3/4x3/4	248	2 001420319



142AS /8 5/16-3/8-7/16-1/2 9/16-5/8-11/16-3/4	1	001420330
--	---	-----------

142C

chiavi combinate corte diritte a cricchetto



ISO 21982:2020

mm	L mm	
8x8	88	2 001420108
9x9	96	2 001420109
10x10	96	2 001420110
11x11	100	2 001420111
12x12	104	2 001420112
13x13	108	2 001420113
14x14	114	2 001420114
15x15	118	2 001420115
16x16	122	2 001420116
17x17	128	2 001420117
18x18	132	2 001420118
19x19	138	2 001420119



142C/A12 8-9-10-11-12-13-14 15-16-17-18-19 mm	1	001420175
--	---	-----------

142SN

chiavi combinate a cricchetto snodate



ISO 21982:2020

mm	L mm	
7x7	136	2 001420207
8x8	136	2 001420208
9x9	143	2 001420209
10x10	160	2 001420210
11x11	168	2 001420211
12x12	174	2 001420212
13x13	180	2 001420213
14x14	193	2 001420214
15x15	200	2 001420215
16x16	216	2 001420216
17x17	233	2 001420217
18x18	239	2 001420218
19x19	250	2 001420219
22x22	285	1 001420222
24x24	325	1 001420224



142SN/S13 7-8-9-10-11-12-13-14 15-16-17-18-19 mm	1	001420263
---	---	-----------



142SN/SC9 8-10-11-12-13-14-15-17-19 mm	1	001420259
--	---	-----------

186

chiave autoserrante a ripresa automatica per esagoni da 8 a 32 mm

ideale per viti con testa a profilo: esagonale, Spline®, quadrato, Torx®; anche rovinate.



L mm	1	001860008
260	1	001860008

187

chiavi esagonali apribili snodate



mm	L mm	1	001870008
8x9	125	1	001870008
10x11	155	1	001870010
12x13	175	1	001870012
14x15	205	1	001870014
16x17	235	1	001870016



187/B5	1	001870050
8x9-10x11-12x13 14x15-16x17 mm	1	001870050

188

chiavi poligonali diritte e a cricchetto per pulegge libere alternatori



mm	L mm	2	001880010
10	240	2	001880010
15	322	2	001880015

192

chiavi poligonali doppie diritte a cricchetto reversibile 4 in 1



mm	L mm	1	001920008
8x10/12x13	160	1	001920008
16x17/18x19	230	1	001920016



192/S2	1	001920070
8x10/12x13 mm 16x17/18x19 mm	1	001920070

194

chiave portainserti a cricchetto reversibile



1/4x5/16	L mm	2	001940006
1/4x5/16	128	2	001940006

195

chiavi poligonali doppie diritte a cricchetto



mm	L mm	2	001950010
8x10	128	2	001950010
12x13	170	2	001950013
14x15	190	2	001950015
16x18	230	2	001950018
17x19	230	2	001950019



195/B5	1	001950066
8x10-12x13-14x15 16x18-17x19 mm	1	001950066

195AS

chiavi poligonali doppie diritte a cricchetto



mm	L mm	2	001950606
5/16x3/8	128	2	001950606
7/16x1/2	170	2	001950611
9/16x5/8	190	2	001950614
11/16x3/4	230	2	001950617



195AS/B4	1	001950654
5/16x3/8 - 7/16x1/2 - 9/16x5/8 - 11/16x3/4	1	001950654

195P

chiavi poligonali doppie piegate a 15° a cricchetto reversibile



ISO 21982:2020

mm	L mm	2	001950210
8x10	128	2	001950210
12x13	170	2	001950213
14x15	190	2	001950215
16x18	230	2	001950218
17x19	230	2	001950219



195P/B5	1	001950266
8x10-12x13-14x15 16x18-17x19 mm	1	001950266

310

polifusori per saldatura tubi e raccordi in materiale plastico PE, PP, PVC e PVDF

CE



230V-650 Watt
50 Hz+60Hz
Schuko (CEE 7/7)

310/1	16÷50	1	003100001
310/2	16÷63	1	003100002

310B

matrici per polifusore 310



mm	1	003100016
16	1	003100016
20	1	003100020
25	1	003100025
32	1	003100032
40	1	003100040
50	1	003100050
63	1	003100063



Beta

310/C4

polifusore con assortimento di 3 matrici



310/C4
310/1+310B: Ø 20-25-32

410x260x82 mm - 4,8 kg

1 003100104

310/C8

polifusore con assortimento di 7 matrici



310/C8
310/2+310B: Ø 16-20-25
32-40-50-63

440x270x120 mm - 7,7 kg

1 003100108

311

termopiastre per saldatura tubi in materiale plastico PE

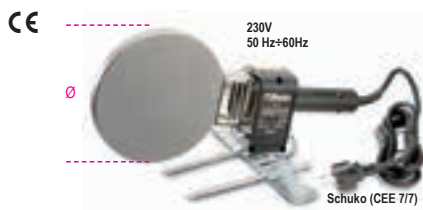

	Ø mm	Watt
311/1	120	300
311/2	190	900

1 003110001
1 003110002

CAMPO DI IMPIEGO DEI TAGLIATUBI BETA

I tagliatubi Beta coprono un campo di applicazione molto ampio. Consentono di effettuare tagli precisi e puliti su tutti i materiali impiegati per le tubature, grazie alla precisione e alla scorrevolezza dei rulli e dell'avanzamento che può essere a vite o telescopico.

Nella tabella seguente è possibile trovare l'associazione tra tagliatubi e coltello per ogni materiale.

	TUBI GAS ACCIAIO		
	10 mm	60 mm	115 mm
	1/8"	2"	4"
330/2			
330/4			

	TUBI GAS ACCIAIO INOX		
	10 mm	60 mm	115 mm
	1/8"	2"	4"
330/2+330R/12			
330/4+330R/14			

	TUBI IN RAME E LEGHE LEGGERE							
	3 mm	6 mm	8 mm	16 mm	28 mm	30 mm	38 mm	67 mm
	1/8"	1/4"	5/16"	5/8"	1"1/8"		1"1/2"	2"5/8"
332								
334								
336								
338								

	TUBI IN ACCIAIO INOX A PARETE SOTTILE							
	3 mm	6 mm	8 mm	16 mm	28 mm	30 mm	38 mm	67 mm
	1/8"	1/4"	5/16"	5/8"	1"1/8"		1"1/2"	2"5/8"
332 + 334R/1								
334 + 334R/1								
336 + 338R/1								
338 + 338R/1								

	TUBI IN PLASTICA							
	6 mm	8 mm	16 mm	30 mm	38 mm	50 mm	67 mm	127 mm
	1/4"	5/16"	5/8"	1"1/8"	1"1/2"	2"	2"5/8"	5"
336 + 338RP								
338 + 338RP								
339A								

330

tagliatubi per tubi gas in acciaio



	Ø mm -"	L mm
330/2	10÷60 1/8"÷ 2"	380
330/4	60÷115 2"÷ 4"	585

1 003300002
1 003300004

330R/1

coltello di ricambio per 330 per acciaio INOX



	Ø mm	S mm
330R/12	32	7
330R/14	32	9

1 003300024
1 003300034

331C

tagliatubi tascabile a c per rame e leghe leggere



	Ø mm	L mm
15÷22	78	

1 003310050

332

mini-tagliatubi per rame e leghe leggere

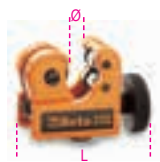

∅ mm - "	L mm		
3÷16 1/8"÷5/8"	59	2	003320001
3÷28 1/8"÷1"1/8"	63	2	003320003

334

tagliatubi per rame e leghe leggere

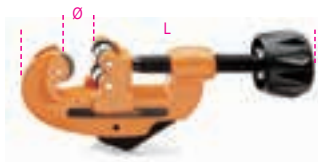

∅ mm - "	L mm		
3÷30 1/8"÷1"1/8"	150	1	003340001

334R

coltello di ricambio per 332-334 per rame e leghe leggere



∅ mm			
334R	18	1	003340021

334R/I

coltello di ricambio per 332-334 per acciaio INOX

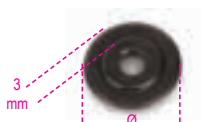

∅ mm			
334R/I	18	1	003340023

336

tagliatubi ad avanzamento telescopico per rame e leghe leggere



∅ mm - "	L mm		
6÷38 1/4"÷1"1/2"	160	1	003360001

338

tagliatubi ad avanzamento telescopico rapido per rame, leghe leggere e plastica



∅ mm - "	L mm		
6÷67 1/4"÷2"5/8"	290	1	003380001

338R

coltello di ricambio per 331L, 336 e 338 per rame e leghe leggere



∅ mm			
338R	18,5	1	003380022

338R/I

coltello di ricambio per 336 e 338 per acciaio INOX

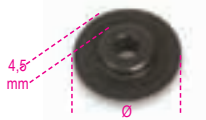

∅ mm			
338R/I	21,8	1	003380023

338RP

coltello di ricambio per 336 e 338 per plastica



∅ mm			
338RP	21,9	1	003380025

339A

tagliatubi ad avanzamento telescopico rapido per tubi di plastica



∅ mm - "	L mm		
50÷127 2"÷5"	345	1	003390011

339A/R

coltelli di ricambio per 339A



∅ mm			
339A/R	42	1	003390061

340

pinza tagliatubi per tubi multistrato

lama rivestita in PTFE
4 rulli di appoggio per facilitare la rotazione del tubo durante il taglio
sistema per il taglio dei tubi corrugati integrato nel manico
corpo leggero in magnesio



∅ max mm			
340	26	1	003400001

340RL

lama di ricambio per 340



∅ max mm			
340RL	26	1	003400010

340C

pinza tagliatubi per tubi corrugati

- pinza in lega di alluminio e magnesio
- compatta, tascabile e leggera
- seconda lama accessorio per il taglio longitudinale



Ø	L		
mm	mm		
14-45	134	1	003400050

340C/KRL

kit 3 lame di ricambio per 340C



340C/KRL	1	003400055
----------	---	-----------

341

pinza tagliatubi per tubi in materiale plastico

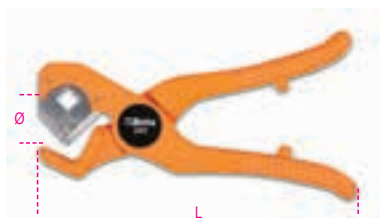

Ø	L		
mm	mm		
0÷25	190	1	003410001

341RL

lama di ricambio per 341



341RL	1	003410010
-------	---	-----------

341B

cesoia a cricchetto per tubi in materiale plastico



Ø	L		
mm	mm		
0÷35	195	1	003410051

341B/RM

molla di ricambio per 341B

341B/RM	1	003410061
---------	---	-----------

341B/RL

lama di ricambio per 341B



341B/RL	1	003410060
---------	---	-----------

342

cesoia a cricchetto per tubi in materiale plastico



Ø	L		
mm - "	mm		
0÷42	200	1	003420030
1"5/8			

342MOL

molla di ricambio per 342

342MOL	1	003420033
--------	---	-----------

342RL

lama di ricambio per 342



342RL	1	003420032
-------	---	-----------

342A

cesoia a cricchetto per tubi in materiale plastico

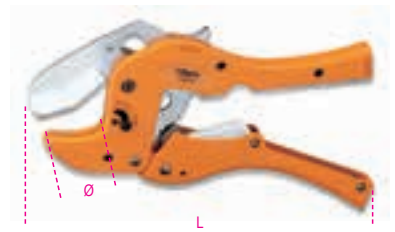

Ø	L		
mm - "	mm		
0÷50	270	1	003420101
2"			

342A/MOL

molla di ricambio per 342A

342A/MOL	1	003420111
----------	---	-----------

342A/RL

lama di ricambio per 342A



342A/RL	1	003420110
---------	---	-----------

342P

cesoia a cricchetto in lega di magnesio per tubi in materiale plastico



Ø	L		
mm - "	mm		
0÷50	260	1	003420121
2"			

342P/RL

lama di ricambio per 342P



342P/RL	1	003420130
---------	---	-----------

Beta

345

utensile sbavatubi
corpo in metallo

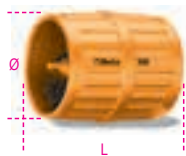

\emptyset	L	
mm - "	mm	
3÷42	58	5 003450001
1/8"÷1"5/8		

345U

utensile sbavatubi per inox, acciaio, rame e leghe leggere



\emptyset	L	
mm - "	mm	
4÷36	60	1 003450050
5/32÷1"7/16		

345U/A

adattatore per sbavatubi 345U
attacco esagonale 1/4" per avvitatori

1/4"



L	
mm	
90	3 003450055

345C

calibratore per tubi multistrato



\emptyset	
mm	
16-20-26-32	1 003450032

345SB

sbavatore a raschietto
a lama intercambiabile girevole



L	
mm	
150	5 003450010

345SB/R

lama di ricambio per 345SB



345SB/R	3 003450015
---------	-------------

345SB2

sbavatore a raschietto
a lama fissa



L	
mm	
140	5 003450022

345SC

scovolino 4 in 1
per diametri interni ed esterni
da 1/2" e da 3/4"



L	L1	L2	
mm	mm	mm	
195	28	32	2 003450060

345SI

sbavatore per interni
a lama intercambiabile girevole



L	\emptyset	
mm	mm	
168	16,5	1 003450040

345SI/R

lama di ricambio per 345SI



345SI/R	1 003450045
---------	-------------

349

attrezzo bordatubi con frizione per rame e leghe leggere

3/8"



\emptyset	
mm - "	
6-8-10-12-14-15-16-18	1 003490001
(1/8-3/16-1/4-5/16	
3/8-1/2-5/8-3/4)	

270x200x50 mm - 2,7 kg

349/SMM

slitta metrica per 349



\emptyset	
mm	
6-8-10-12-14-15-16-18	1 003490011

349/SMAS

slitta in pollici per 349



\emptyset	
mm	
1/8-3/16-1/4-5/16	1 003490012
3/8-1/2-5/8-3/4	

350

attrezzo bordatubi
per rame e leghe leggere

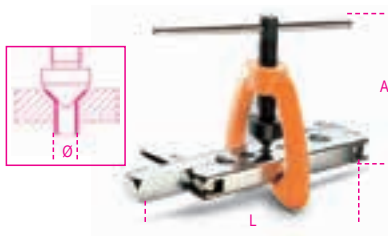

Ø mm	L mm	A mm	
4-4,75-6-8	175	104	1 003500001
10-12-14			

351C

tagliatubi ed attrezzo bordatubi



351C		
	1	003510010

334	Ø 3+30 mm (1/8"+1"1/8)
350	Ø 4+14 mm
351P	Ø 4-4,75-6-8-10-12-14 mm

225x150x45 mm - 1,6 kg

351P

puntali per 350



351P	Ø mm	
351P 4	4	3 003510101
351P 4,75	4,75	3 003510102
351P 6	6	3 003510103
351P 8	8	3 003510104
351P 10	10	3 003510105
351P 12	12	3 003510106
351P 14	14	3 003510107

352U

attrezzo bordatubi regolabile,
per rame e leghe leggere

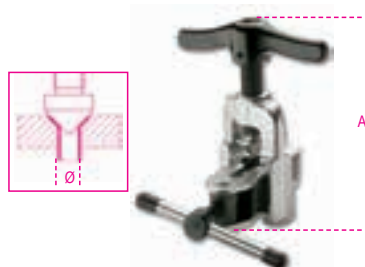

Ø mm - "	A mm	
5=16	130	1 003520101
3/16=5/8		

352C/U

tagliatubi, sbavatore
ed attrezzo bordatubi regolabile



352C/U		
	1	003520110

334 Ø 3+30 mm (1/8"+1"1/8)

345SB

352U Ø 5+16 mm (3/16"+5/8")

335x145x60 mm - 2120 g

353N

pinza allargatubi a matrici
ad espansione, intercambiabili



L mm		
380	1	003530201

353NM

matrici ad espansione per 353N

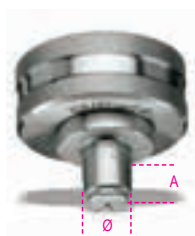

Ø mm	A mm	
10	7	1 003530210
12	10	1 003530212
14	10	1 003530214
16	12	1 003530216
18	12	1 003530218
22	13	1 003530222

353N/C6

pinza allargatubi 353N
con matrici ad espansione 353NM



353N/C6		
	1	003530300

353N

353NM Ø 10-12-14-16-18-22 mm

420x185x60 mm - 2,2 kg

355

chiave per raccordi radiatori
a cinque gradazioni



Ø "	L mm	
3/8"-1/2"	90	2 003550001
3/4"-1"		

357F3

dima a tre file
per installazione attacchi sanitari

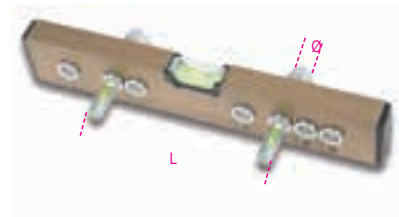

Ø "	L mm	
3/8" / 1/2"	90=220	1 003570100

357R/F3

fila di ricambio per 357F3



357R/F3		
	1	003570101

Beta

358

attrezzi per smussare esternamente
tubi in materiale plastico



	∅ mm		
358/1	16÷110	1	003580001
358/2	40÷250	1	003580002

358RL

lama di ricambio per 358/1 e 358/2



358RL	1	003580011
-------	---	-----------

359

chiave universale per pilette



∅ "	L mm	A mm	
1"÷1"1/4	160	140	1 003590001

359CH

adattatore per pilette
con grata a croce per 359



∅ "	L mm	
1"1/2	74	1 003590005

360

giratubi modello stillson



L mm	∅ max "	∅ max mm	
250	1" gas	34	1 003600025
350	1"1/2 gas	49	1 003600035
450	2" gas	60	1 003600045
600	2"1/2 gas	76	1 003600060
900	3"1/2 gas	102	1 003600090

360R/...

kit ricambio per 360
composto da ganascia mobile e ghiera.

360R250	1	003600225
360R350	1	003600235
360R450	1	003600245
360R600	1	003600260
360R900	1	003600290

361N

giratubi regolabile a leva

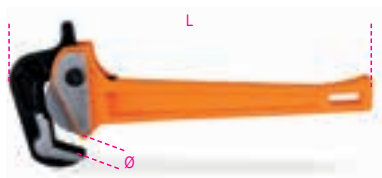

L mm	∅ max "	∅ max mm	
350	1" 1/2	49	1 003610014

362

giratubi modello americano



L mm	∅ max "	∅ max mm	
200	1" gas	34	1 003620020
250	1"1/2 gas	49	1 003620025
300	2" gas	60	1 003620030
350	2" gas	60	1 003620035
450	2"1/2 gas	76	1 003620045
600	3" gas	90	1 003620060
900	5" gas	140	1 003620090

362R/...

kit ricambi per 362
composto da: ganascia fissa; ganascia mobile;
ghiera; spina di fissaggio.

362R 200	1	003620220
362R 250	1	003620225
362R 300	1	003620230
362R 350	1	003620235
362R 450	1	003620245
362R 600	1	003620260
362R 900	1	003620290

363

giratubi modello americano
corpo in lega leggera



L mm	∅ max "	∅ max mm	
350	2" gas	60	1 003630035
450	2"1/2 gas	76	1 003630045
600	3" gas	90	1 003630060
900	5" gas	140	1 003630090
1200	6" gas	165	1 003630120

363R/...

kit ricambi per 363
composto da: ganascia fissa; ganascia mobile;
ghiera; spina di fissaggio.

363R 350	1	003630235
363R 450	1	003630245
363R 600	1	003630260
363R 900	1	003630290
363R 1200	1	003630320

365

giratubi modello frontale
corpo in lega leggera



L mm	∅ max "	∅ max mm	
350	2" gas	60	1 003650035
450	2"1/2 gas	76	1 003650045

365R/...

kit ricambi per 365
composto da: ganascia fissa; ganascia mobile;
ghiera; spina di fissaggio.

365R 350	1	003650235
365R 450	1	003650245

366

giratubi tipo leggero



L mm	∅ max "	∅ max mm	
175	1" gas	34	1 003660017
225	1"1/2 gas	49	1 003660022
275	2" gas	60	1 003660027
300	2"1/2 gas	76	1 003660030
350	3" gas	90	1 003660035

374

giratubi modello svedese
ganasse sottili a 45°



DIN 5234

L mm	∅ max "	∅ max mm	
240	1/2" gas	21	1 003740024
320	1" gas	34	1 003740032
410	1 1/2" gas	49	1 003740041
550	2" gas	60	1 003740055
630	3" gas	90	1 003740063

375

giratubi modello svedese
ganasse parallele a 45°



DIN 5234

L mm	∅ max "	∅ max mm	
320	1" gas	34	1 003750032
410	1 1/2" gas	49	1 003750041
550	2" gas	60	1 003750055

376

giratubi modello svedese
ganasse piane a 90°



DIN 5234

L mm	∅ max "	∅ max mm	
320	1" gas	34	1 003760032
410	1 1/2" gas	49	1 003760041
550	2" gas	60	1 003760055
630	3" gas	90	1 003760063

378

giratubi modello svedese
ganasse sottili a 45°



DIN 5234

L mm	∅ max "	∅ max mm	
250	1/2" gas	21	1 003780025
320	1" gas	34	1 003780032
410	1 1/2" gas	49	1 003780041
550	2" gas	60	1 003780055
650	3" gas	90	1 003780065

374R/...

KIT ricambi completi per 374 - 375 - 376 - 378
composto da ghiera e fermaghiera

374R 240 374/240-378/250	1	003740724
374R 320 374/320-375/320-376/320-378/320	1	003740732
374R 410 374/410-375/410-376/410-378/410	1	003740741
374R 550 374/550-375/550-376/550-378/550	1	003740755
374R 630 374/630-378/650	1	003740763

383

giratubi reversibili a nastro



	∅ max "	∅ max mm	L mm	
383/1	3" gas	90	300	1 003830001
383/2	8" gas	220	300	1 003830002

383R

nastri di ricambio per 383

	S mm	
383R/1	27	1 003830010
383R/2	27	1 003830015

384

giratubi reversibile a catena



	∅ max "	∅ max mm	L mm	
384	4" gas	115	300	1 003840032

384RC

catena di ricambio per 384

384RC	1	003840033
-------	---	-----------

386A/RC

catene di ricambio per 386A

386A3/RC	1	003860013
386A4/RC	1	003860014
386A5/RC	1	003860015
386A6/RC	1	003860016

387

pinza curvatubi per tubi in rame e metalli non
ferrosi con matrici intercambiabili
3/16"-1/4"-5/16"-3/8"



L mm	∅ mm	
255	3/16"-1/4"-5/16"-3/8"	1 003870001

387R

matrici di ricambio per 387

∅	
3/16"-1/4"	1 003870010
5/16"-3/8"	1 003870015

388

attrezzi curvatubi
per rame, lega leggera



∅ mm	L mm	R mm	
6	305	18,0	1 003880006
8	315	23,5	1 003880008
10	350	31,0	1 003880010
12	360	31,0	1 003880012
14	455	46,5	1 003880014
15	465	46,5	1 003880015
16	465	46,5	1 003880016

388A

pinza curvatubi
per rame e lega leggera



	∅ mm	L mm	
388A/1	6-8-10	220	1 003880051
388A/2	1/4"-5/16"-3/8"	220	1 003880055

388C/C8

attrezzo curvatubi con 7 matrici
per rame e lega leggera



	∅ mm	
388C/C8	10-12-14-16 18-20-22	1 003880200

400x330x110 mm - 3,6 kg

389/K4

kit molle curvatubi per tubi in rame per uso esterno



Ø"	L mm		
1/4-3/8-1/2-5/8	290	1	003890001

386A

giratubi reversibili a catena modello pesante



	Ø max	L mm		
386A/3	4" gas 115 mm	900	1	003860003
386A/4	6" gas 168 mm	900	1	003860004
386A/5	8" gas 220 mm	1100	1	003860005
386A/6	12" gas 324 mm	1300	1	003860006

392C

pinza regolabile per sifoni



Ø mm	L mm		
25÷65	260	1	003920100

392RG/C

coppia di copri-ganasce di ricambio per 392C



392RG/C	1	003920101
---------	---	-----------

393

pinza per dadi rubinetto



L mm			
270	1	003930001	

395

chiave per dadi rubinetto articolata

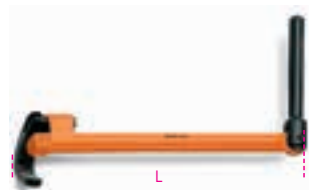

Ø	L mm		
15÷32 mm 5/8"÷1"1/4	240	1	003950001

395T

chiave per dadi rubinetto articolata, telescopica



Ø	L mm		
10÷32 mm 3/8"÷1"1/4	250÷430	1	003950100

398

morse a catena da banco



Ø	L mm		
1/2÷8"	250	1	003980008

399

morse ribaltabili da banco



Ø	L min mm		
10÷60 mm 1/8÷2"	220	1	003990005
10÷89 mm 1/8÷3"	290	1	003990010

399R/...

kit ricambio per 399 composto da due ganasce inferiori e una superiore



399RG1/8-2"	1	003990105
399RG1/8-3"	1	003990110



Beta

TABELLA PUNTE PER METALLO

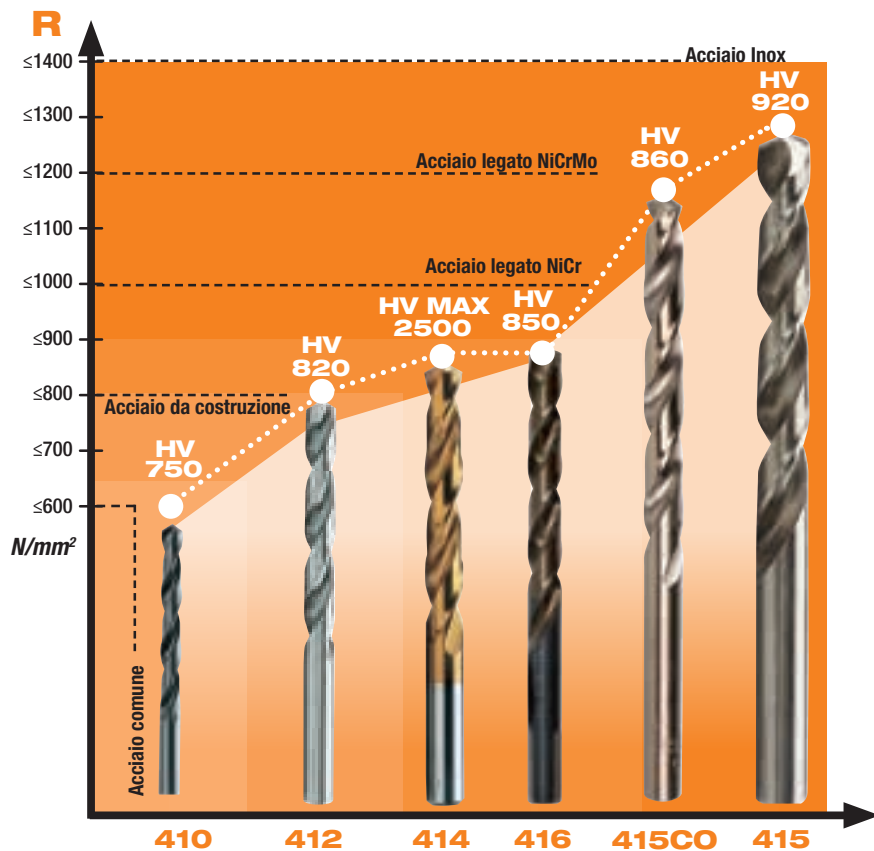

R N/mm² - resistenza meccanica del materiale da forare.

HV - durezza della punta secondo la scala Vickers: maggiore il valore, maggiore la durezza.

GUIDA ALLE PUNTE CILINDRICHE

Punte rullate - punte ottenute con un processo produttivo per laminazione a caldo. Buona qualità per impieghi non impegnativi quali la foratura di ferro, acciai dolci, leghe leggere e metalli non ferrosi in genere

Punte rettificate - punte ottenute interamente per rettifica da una barretta di acciaio trattata termicamente. Elevate prestazioni per la foratura di acciai e leghe leggere: rendimento costante, ottima evacuazione del truciolo e precisione dei fori.

HSS - acciaio super-rapido (high speed steel), ha elevata durezza e buona resistenza alle alte temperature; è il materiale migliore per la realizzazione di utensili da taglio e di utensili per la maschiatura e la filettatura.

Cobalto (Co) - componente di lega che aumenta la resistenza al calore dell'acciaio, diminuendo l'usura della punta anche a temperature elevate. Maggiore è la percentuale di cobalto, migliori saranno le prestazioni dell'utensile. Normalmente si utilizzano leghe con valori di cobalto al 5% e all'8%.

HSS-Co - acciaio super-rapido con presenza di cobalto in tenore del 5% o dell'8%.

TiN - sottilissimo rivestimento di nitruro di titanio grazie all'elevata durezza e al basso coefficiente di attrito aumenta la resistenza a fenomeni di usura e ossidazione. Migliora inoltre lo scorrimento dei trucioli di lavorazione.

Acciaio al cromo - gli utensili realizzati in acciaio al cromo sono indicati per l'utilizzo manuale nella filettatura su ferro, leghe leggere, acciai non trattati o trattati termicamente a bassa durezza. Trovano un'ampia applicazione nella pulizia e nel ripristino delle filettature danneggiate in tutti i lavori professionali e in particolare nel campo automotive.

Metallo duro - materiale con elevata resistenza all'usura, utilizzato nelle placchette delle punte per muratura.

Affilatura 118° - angolo di affilatura standard delle punte per metallo. Consente una rapida penetrazione nei metalli agevolando la centratura e ha un'ottima dissipazione del calore.

Affilatura 130° - angolo di affilatura ampio, offre una maggior precisione nelle fasi iniziali della foratura e richiede una minor forza di penetrazione.

Doppia affilatura 115°/135° - abbina i vantaggi di entrambi gli angoli, aggiungendo una funzione romptruciolo; per questo motivo è la scelta migliore per materiali con truciolo lungo.

SDS-Plus - codolo rapido e sicuro per martelli tassellatori.

410

punte elicoidali cilindriche
serie corta, in acciaio HSS
rullate

R ≤ 650 N/mm²
HV ~ 750÷820



DIN 338 ISO 235

Ø mm	L mm	L1 mm		
0,50	22	6	10	004100030
1,00	34	12	10	004100040
1,25	38	16	10	004100043
1,50	40	18	10	004100046
1,75	46	22	10	004100049
2,00	49	24	10	004100052
2,25	53	27	10	004100055
2,50	57	30	10	004100058
2,75	61	33	10	004100061
3,00	61	33	10	004100064
3,20	65	36	10	004100066
3,25	65	36	10	004100067
3,50	70	39	10	004100070
3,75	70	39	10	004100073
4,00	75	43	10	004100076
4,20	75	43	10	004100078
4,25	75	43	10	004100079
4,50	80	47	10	004100082
4,75	80	47	10	004100085
5,00	86	52	10	004100088
5,25	86	52	10	004100091
5,50	93	57	10	004100094
5,75	93	57	10	004100097
6,00	93	57	10	004100100
6,25	101	63	10	004100103
6,50	101	63	10	004100106
6,75	109	69	10	004100109
7,00	109	69	10	004100112
7,50	109	69	10	004100118
8,00	117	75	10	004100124
8,50	117	75	10	004100130
9,00	125	81	5	004100136
9,50	125	81	5	004100142
10,00	133	87	5	004100148
10,50	133	87	5	004100172
11,00	142	94	5	004100184
11,50	142	94	5	004100196
12,00	151	101	5	004100210
12,50	151	101	5	004100222
13,00	151	101	5	004100234
14,00	160	108	5	004100242
15,00	169	114	5	004100250
16,00	178	120	5	004100258
17,00	184	125	3	004100262
18,00	191	130	3	004100266
19,00	198	135	3	004100270
20,00	205	140	3	004100274



410/SP19	Ø 1÷10 x 0,5 mm	1	004100419
410/SPVP1		1	004100421
410/SP25	Ø 1÷13 x 0,5 mm	1	004100425
410/SPVP2		1	004100427



410/SEL19
Ø 1÷10 x 0,5 mm

1 004100418

410MIX/SEL19

serie di 13 punte 410
e 6 punte con inserto in metallo duro



410MIX/SEL19

1 004100417



Ø 1 - 1,5 - 2 - 2,5 - 3 - 3,5 - 4
4,5 - 5 - 5,5 - 6 - 8 - 10 mm

Ø 4 - 5 - 6 - 8 - 9 - 10 mm

410A

punte elicoidali cilindriche
serie corta, in acciaio HSS rullate
con codolo ridotto

R ≤ 650 N/mm²
HV ~ 750÷820



DIN 338 ISO 235

Ø mm	L mm	L1 mm	
13,50	160	108	5 004100281
14,00	160	108	5 004100283
14,50	169	114	5 004100285
15,00	169	114	5 004100287
15,50	178	120	5 004100289
16,00	178	120	5 004100291
16,50	184	125	3 004100292
17,00	184	125	3 004100293
17,50	191	130	3 004100294
18,00	191	130	3 004100295
18,50	198	135	3 004100296
19,00	198	135	3 004100297
19,50	205	140	3 004100298
20,00	205	140	3 004100299

410AS

punte elicoidali cilindriche
serie corta, in acciaio HSS
rullate,
in pollici

R ≤ 650 N/mm²
HV ~ 750÷820



ANSI B94

Ø"	L mm	L1 mm	
1/16	48	22	10 004100371
5/64	51	25	10 004100372
3/32	57	32	10 004100373
7/64	67	38	10 004100374
1/8	70	41	10 004100375
9/64	73	44	10 004100376
5/32	79	51	10 004100377
11/64	83	54	10 004100378
3/16	89	59	10 004100379
13/64	92	62	10 004100380
7/32	95	64	10 004100381
15/64	98	67	10 004100382
1/4	102	70	10 004100383
17/64	105	73	10 004100384
9/32	108	75	10 004100385
19/64	111	78	10 004100386
5/16	114	81	10 004100387
21/64	117	84	10 004100388
11/32	121	87	5 004100389
23/64	124	89	5 004100390
3/8	127	92	5 004100391



410AS/SP21

Ø 1/16-5/64-3/32-7/64
1/8-9/64-5/32-11/64-3/16
13/64-7/32-15/64-1/4
17/64-9/32-19/64-5/16
21/64-11/32-23/64-3/8

410AS/SPV1

1 004100429

1 004100430



410AS/SEL21

Ø 1/16-5/64-3/32-7/64
1/8-9/64-5/32-11/64-3/16
13/64-7/32-15/64-1/4
17/64-9/32-19/64-5/16
21/64-11/32-23/64-3/8

1 004100433

412

punte elicoidali cilindriche
serie corta, in acciaio HSS
rettificate lucide

R ≤ 800 N/mm²
HV ~ 750÷820

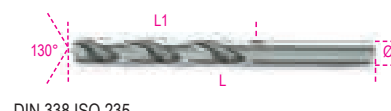

DIN 338 ISO 235

Ø mm	L mm	L1 mm	
0,50	22	6	10 004120030
1,00	34	12	10 004120040
1,25	38	16	10 004120043
1,50	40	18	10 004120046
1,75	46	22	10 004120049
2,00	49	24	10 004120052
2,25	53	27	10 004120055
2,50	57	30	10 004120058
2,75	61	33	10 004120061
3,00	61	33	10 004120064
3,25	65	36	10 004120067
3,50	70	39	10 004120070
3,75	70	39	10 004120073
4,00	75	43	10 004120076
4,25	75	43	10 004120079
4,50	80	47	10 004120082
4,75	80	47	10 004120085
5,00	86	52	10 004120088
5,25	86	52	10 004120091
5,50	93	57	10 004120094
5,75	93	57	10 004120097
6,00	93	57	10 004120100
6,25	101	63	10 004120103
6,50	101	63	10 004120106
6,75	109	69	10 004120109
7,00	109	69	10 004120112
7,25	109	69	5 004120115
7,50	109	69	5 004120118
7,75	117	75	5 004120121
8,00	117	75	5 004120124
8,25	117	75	5 004120127
8,50	117	75	5 004120130
8,75	125	81	5 004120133
9,00	125	81	5 004120136
9,25	125	81	5 004120139
9,50	125	81	5 004120142
9,75	133	87	5 004120145
10,00	133	87	5 004120148
10,25	133	87	5 004120149
10,50	133	87	5 004120150
10,75	142	94	5 004120151
11,00	142	94	5 004120152
11,25	142	94	5 004120153
11,50	142	94	5 004120154
11,75	142	94	5 004120155
12,00	151	101	5 004120156
12,25	151	101	5 004120157
12,50	151	101	5 004120158
12,75	151	101	5 004120159
13,00	151	101	5 004120160



412/SP19

Ø 1÷10 x 0,5 mm

410/SPVP1

412/SP25

Ø 1÷13 x 0,5 mm

410/SPVP2

412/SP49

Ø 1÷13 x 0,25 mm

412/SPV4

1 004120419

1 004100421

1 004120425

1 004100427

1 004120449

1 004120451

Beta

412/C150



412/C150  1 004120450

412	Ø 3 mm	n.
	Ø 1 - 1,5 - 2 - 2,5 - 3 - 3,5 - 4 - 4,5 - 5 mm	20
	Ø 5,5 - 6 - 6,5 - 7 - 7,5 - 8 - 8,5 - 9 - 9,5 - 10 mm	10
		5

365x230x47 mm - 3,3 kg



412/SP91  1 004120452

Ø 1=10 x 0,10 mm

412A

punte elicoidali cilindriche
serie corta, in acciaio HSS
rettificate brunite
con codolo ridotto

R ≤ 800 N/mm²
HV ~ 750÷820



DIN 338 ISO 235

Ø mm	L mm	L1 mm	n.
13,50	160	108	3
14,00	160	108	3
14,50	169	114	3
15,00	169	114	3
15,50	178	120	3
16,00	178	120	3
16,50	184	125	1
17,00	184	125	1
17,50	191	130	1
18,00	191	130	1
18,50	198	135	1
19,00	198	135	1
19,50	205	140	1
20,00	205	140	1

412C

punte elicoidali cilindriche
serie extra corta, in acciaio HSS
rettificate brunite

R ≤ 800 N/mm²
HV ~ 750÷820



DIN 1897 ISO 235

Ø mm	L mm	L1 mm	n.
3,00	46	16	10
3,25	49	18	10
3,50	52	20	10
4,00	55	22	10
4,50	58	24	10
5,00	62	26	10
5,50	66	28	10
6,00	66	28	10
6,5	70	31	10
7,00	74	34	10
7,5	74	34	5
8,00	79	37	5

412L

punte elicoidali cilindriche
serie lunga, in acciaio HSS
rettificate brunite

R ≤ 800 N/mm²
HV ~ 750÷820



DIN 340

Ø mm	L mm	L1 mm	n.
2,00	85	56	10
2,50	95	62	10
3,00	100	66	10
3,50	112	73	10
4,00	119	78	10
4,50	126	82	10
5,00	132	87	10
5,50	139	91	10
6,00	139	91	10
6,50	148	97	5
7,00	156	102	5
8,00	165	109	5
9,00	175	115	5
10,00	184	121	5

412XL

punte elicoidali cilindriche
serie extra lunga, in acciaio HSS
rettificate

R ≤ 800 N/mm²
HV ~ 750÷820



DIN 1869/1

Ø mm	L mm	L1 mm	n.
3,00	150	100	1
3,50	165	115	1
4,00	175	120	1
4,50	185	125	1
5,00	195	135	1
5,50	205	140	1
6,00	205	140	1

Ø mm	L mm	L1 mm	n.
6,50	215	150	1
7,00	225	155	1
7,50	225	155	1
8,00	240	165	1
8,50	240	165	1
9,00	250	175	1
9,50	250	175	1
10,00	265	185	1
10,50	265	185	1
11,00	280	195	1
12,00	295	205	1
13,00	295	205	1

414

punte elicoidali cilindriche
serie corta, in acciaio HSS-TiN
rettificate

R ≤ 900 N/mm²
HV 0,05 ~ 2500



DIN 338 ISO 235

Ø mm	L mm	L1 mm	n.
1,00	34	12	10
1,25	38	16	10
1,50	40	18	10
1,75	46	22	10
2,00	49	24	10
2,25	53	27	10
2,50	57	30	10
2,75	61	33	10
3,00	61	33	10
3,25	65	36	10
3,50	70	39	10
3,75	70	39	10
4,00	75	43	10
4,25	75	43	10
4,50	80	47	10
4,75	80	47	10
5,00	86	52	10
5,25	86	52	10
5,50	93	57	10
5,75	93	57	10
6,00	93	57	10
6,25	101	63	10
6,50	101	63	10
6,75	109	69	10
7,00	109	69	10
7,25	109	69	5
7,50	109	69	5
7,75	117	75	5
8,00	117	75	5
8,25	117	75	5
8,50	117	75	5
8,75	125	81	5
9,00	125	81	5
9,25	125	81	5
9,50	125	81	5
9,75	133	87	5
10,00	133	87	5
10,50	133	87	5
11,00	142	94	5
11,50	142	94	5
12,00	151	101	5
12,50	151	101	5
13,00	151	101	5





414/SP19	1	004140419
Ø 1÷10 x 0,5 mm		
410/SPVP1	1	004100421
414/SP25	1	004140425
Ø 1÷13 x 0,5 mm		
410/SPVP2	1	004100427
414/SP49	1	004140429
Ø 1÷13 x 0,25 mm		
414/SPV4	1	004140430

414/C116



414/C116	1	004140450
----------	---	-----------

414	Ø 1 - 1,5 - 2 - 2,5 - 3 - 3,5 - 4 - 4,5 - 5 mm	n.
	Ø 5,5 - 6 - 6,5 - 7 - 7,5 - 8 mm	3
	Ø 8,5 - 9 - 9,5 - 10 mm	2

365x230x47 mm - 2,7 Kg

415

punte elicoidali cilindriche
serie corta, in acciaio HSS-CO 8%
rettificate

R ≤ 1400 N/mm²
HV ~ 850+920



DIN 338 ISO 235

Ø mm	L mm	L1 mm		
0,50	22	6	10	004150029
1,00	34	12	10	004150040
1,25	38	16	10	004150043
1,50	40	18	10	004150046
1,75	46	22	10	004150049
2,00	49	24	10	004150052
2,25	53	27	10	004150055
2,50	57	30	10	004150058
2,75	61	33	10	004150061
3,00	61	33	10	004150064
3,25	65	36	10	004150067
3,50	70	39	10	004150070
3,75	70	39	10	004150073
4,00	75	43	10	004150076
4,25	75	43	10	004150079
4,50	80	47	10	004150082
4,75	80	47	10	004150085
5,00	86	52	10	004150088

Ø mm	L mm	L1 mm		
5,25	86	52	10	004150091
5,50	93	57	10	004150094
5,75	93	57	10	004150097
6,00	93	57	10	004150100
6,25	101	63	10	004150103
6,50	101	63	10	004150106
6,75	109	69	10	004150109
7,00	109	69	10	004150112
7,25	109	69	5	004150115
7,50	109	69	5	004150118
7,75	117	75	5	004150121
8,00	117	75	5	004150124
8,25	117	75	5	004150127
8,50	117	75	5	004150130
8,75	125	81	5	004150133
9,00	125	81	5	004150136
9,25	125	81	5	004150139
9,50	125	81	5	004150142
9,75	133	87	5	004150145
10,00	133	87	5	004150148
10,25	133	87	5	004150149
10,50	133	87	5	004150150
10,75	142	94	5	004150151
11,00	142	94	5	004150152
11,25	142	94	5	004150153
11,50	142	94	5	004150154
11,75	142	94	5	004150155
12,00	151	101	5	004150156
12,25	151	101	5	004150157
12,50	151	101	5	004150158
12,75	151	101	5	004150159
13,00	151	101	5	004150160
14,00	160	108	3	004150164
15,00	169	114	3	004150168
16,00	178	120	3	004150172
17,00	186	125	1	004150174
18,00	194	130	1	004150176
19,00	202	135	1	004150178
20,00	210	140	1	004150180



Co8%

415/SP19	1	004150419
Ø 1÷10 x 0,5 mm		
410/SPVP1	1	004100421
415/SP25	1	004150425
Ø 1÷13 x 0,5 mm		
410/SPVP2	1	004100427
415/SP49	1	004150431
Ø 1÷13 x 0,25 mm		
415/SPV4	1	004150432

415/C116



415/C116	1	004150450
----------	---	-----------

415	Ø 1 - 1,5 - 2 - 2,5 - 3 - 3,5 - 4 - 4,5 - 5 mm	n.
	Ø 5,5 - 6 - 6,5 - 7 - 7,5 - 8 mm	3
	Ø 8,5 - 9 - 9,5 - 10 mm	2

365x230x47 mm - 2,7 kg



415/SP91	1	004150460
Ø 1÷10 x 0,10 mm		

415CO

punte elicoidali cilindriche
serie corta, in acciaio HSS-CO 5%
rettificate

R ≤ 1200 N/mm²
HV ~ 800+860



DIN 338 ISO 235

Ø mm	L mm	L1 mm		
1,00	34	12	10	004150310
1,50	40	18	10	004150312
2,00	49	24	10	004150314
2,50	57	30	10	004150316
3,00	61	33	10	004150320
3,50	70	39	10	004150322
4,00	75	43	10	004150324
4,50	80	47	10	004150326
5,00	86	52	10	004150328
5,50	93	57	10	004150330
6,00	93	57	10	004150332
6,50	101	63	10	004150334
7,00	109	69	10	004150336
7,50	109	69	5	004150338
8,00	117	75	5	004150340
8,50	117	75	5	004150342
9,00	125	81	5	004150344
9,50	125	81	5	004150346
10,00	133	87	5	004150348
10,50	133	87	5	004150350
11,00	142	94	5	004150352
11,50	142	94	5	004150354
12,00	151	101	5	004150356
12,50	151	101	5	004150358
13,00	151	101	5	004150360

415CO-A

punte elicoidali cilindriche
serie corta, in acciaio HSS-CO 5%
rettificate

con codolo ridotto
R ≤ 1200 N/mm²
HV ~ 800+860



DIN 338

Ø mm	L mm	L1 mm		
14,00	160	108	3	004150364
15,00	169	114	3	004150366
16,00	178	120	3	004150368
17,00	184	125	1	004150370
18,00	191	130	1	004150372
19,00	198	135	1	004150374
20,00	205	140	1	004150376



Co5%

DIN 338

415CO/SP19
 Ø 1÷10 x 0,5 mm
 410/SPVP1

1 004150421
 1 004100421

415C

punte elicoidali cilindriche
 serie extra corta, in acciaio HSS-CO 5%
 rettificata
 R ≤ 1200 N/mm²
 HV ~ 800÷860



Co5%

DIN 1897 ISO 235

Ø mm	L mm	L1 mm	
3,00	46	16	10 004150288
3,25	49	18	10 004150289
3,50	52	20	10 004150290
4,00	55	22	10 004150292
4,50	58	24	10 004150294
5,00	62	26	10 004150296
5,50	66	28	10 004150298
6,00	66	28	10 004150300
6,50	70	31	10 004150301
7,00	74	34	10 004150302
7,50	74	34	5 004150303
8,00	79	37	5 004150304

415L

punte elicoidali cilindriche
 serie lunga, in acciaio HSS-CO 5%
 rettificata

R ≤ 1200 N/mm²
 HV ~ 800÷860



Co5%

DIN 340

Ø mm	L mm	L1 mm	
3,00	100	66	10 004150236
3,50	112	73	10 004150238
4,00	119	78	10 004150240
4,50	126	82	10 004150242
5,00	132	87	10 004150244
5,50	139	91	10 004150246
6,00	139	91	10 004150248
6,50	148	97	5 004150250
7,00	156	102	5 004150252
8,00	165	109	5 004150256
9,00	175	115	5 004150260
10,00	184	121	5 004150264

416

punta cilindrica con affilatura speciale
 a doppia coppia di taglienti, in acciaio HSS-G

R ≤ 900 N/mm²
 HV ~ 820÷850



VELOCITÀ DI TAGLIO
 SUPERIORE



DIN 338

Ø mm	L mm	L1 mm	
1,00	34	12	10 004160010
1,50	40	18	10 004160015
2,00	49	24	10 004160020
2,50	57	30	10 004160025
3,00	61	33	10 004160030
3,50	70	39	10 004160035
4,00	75	43	10 004160040
4,50	80	47	10 004160045
5,00	86	52	10 004160050
5,50	93	57	10 004160055
6,00	93	57	10 004160060
6,50	101	63	10 004160065
7,00	109	69	10 004160070
7,50	109	69	5 004160075
8,00	117	75	5 004160080
8,50	117	75	5 004160085
9,00	125	81	5 004160090
9,50	125	81	5 004160095
10,00	133	87	5 004160100

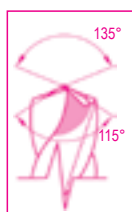

416/SP19
 Ø 1÷10 x 0,5 mm
 410/SPVP1

1 004160419
 1 004100421

417

punte elicoidali cilindriche per muratura
 serie corta, in acciaio fresato
 con placchetta in metallo duro



DIN 8039

Ø mm	L mm	
3	70	10 004170003
4	75	10 004170004
5	85	10 004170005
5L	150	5 004170105
6	100	10 004170007
6L	150	5 004170106
7	120	10 004170009
8	120	10 004170010
8L	200	5 004170113
9	120	10 004170011
10	120	10 004170012
10L	200	5 004170120
12	150	10 004170014
12L	200	5 004170125
14	150	5 004170016
16	150	5 004170018



417/SP8
 Ø 3-4-5-6-8-9-10-12 mm

1 004170100

419

punte per muratura
 corpo fresato con placchetta
 in metallo duro
 HVA~ 1650



DIN 8039

Ø mm	L mm	
4	110	10 004190002
5	110	10 004190004
5	160	10 004190006
6	110	10 004190012
6	160	10 004190014
6	210	10 004190016
7	160	10 004190028
8	110	10 004190030
8	160	10 004190032
8	210	10 004190034
8	260	10 004190036
8	310	10 004190038
8	460	10 004190042
9	160	5 004190044
10	160	5 004190050
10	210	5 004190052
10	260	5 004190054
10	310	5 004190056
10	460	5 004190060
12	160	5 004190064
12	210	5 004190066
12	260	5 004190068
12	460	5 004190074
14	160	3 004190086
14	260	3 004190090
14	310	3 004190092
14	460	3 004190096
16	210	3 004190112
16	250	3 004190114
16	300	3 004190116
16	450	3 004190120
18	250	1 004190124
20	310	1 004190128



419T

punte per muratura
corpo fresato con
4 eliche e 4 taglienti
HVA-1650

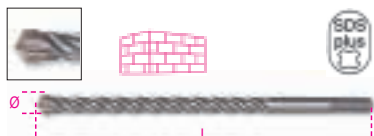

Ø mm	L mm		
5	110	5	004190604
5	160	5	004190606
6	110	5	004190612
6	160	5	004190614
6	210	5	004190616
7	160	5	004190628
8	110	5	004190630
8	160	5	004190632
8	210	5	004190634
8	260	5	004190636
8	310	5	004190638
9	160	3	004190644
10	160	3	004190650
10	210	3	004190652
10	260	3	004190654
10	310	3	004190656
10	460	3	004190660
12	160	3	004190664
12	210	3	004190666
12	260	3	004190668
12	460	3	004190674
14	160	2	004190686
14	260	2	004190690
14	310	2	004190692
14	460	2	004190696
16	210	2	004190712
16	260	2	004190714
16	310	2	004190716
16	460	2	004190720
18	260	1	004190724
20	310	1	004190728

420A

punte a gradino ad eliche indipendenti
per fori sedi viti 90°,
in acciaio HSS,
per fori passanti



DIN 8374

M	Ø mm	D mm	L1 mm	L2 mm	L mm		
3	3,2	6	9,00	57,00	93,00	1	004200003
4	4,3	8	11,00	75,00	117,00	1	004200004
5	5,3	10	13,00	87,00	133,00	1	004200005
6	6,4	11,5	15,00	94,00	142,00	1	004200006
8	8,4	15	19,00	114,00	169,00	1	004200008
10	10,5	19	23,00	135,00	198,00	1	004200010

420B

punte a gradino ad eliche indipendenti
per fori sedi viti 180°,
in acciaio HSS,
per fori passanti

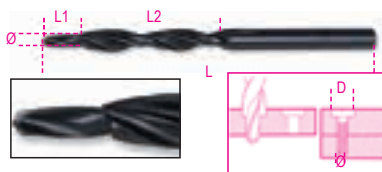

DIN 8376

M	Ø mm	D mm	L1 mm	L2 mm	L mm		
3	3,4	6	9,00	57,00	93,00	1	004200053
4	4,5	8	11,00	75,00	117,00	1	004200054
5	5,5	10	13,00	87,00	133,00	1	004200055
6	6,6	11	15,00	94,00	142,00	1	004200056
8	9	15	19,00	114,00	169,00	1	004200058
10	11	18	23,00	130,00	191,00	1	004200060

421

svasatori con perno guida
grado fine
in acciaio HSS



DIN 373

M	L mm	Ø mm	D1 mm	D mm		
3	71	6	3,2	5	1	004210003
4	71	8	4,3	5	1	004210004
5	80	10	5,3	8	1	004210005
6	80	11	6,4	8	1	004210006
8	100	15	8,4	12,5	1	004210008
10	100	18	10,5	12,5	1	004210010
12	100	20	13,0	12,5	1	004210012



421/SP6	1	004210019
M 3-4-5-6-8-10		
421/SPV	1	004210020

422

punte a centrare rettificata
angolo di svasatura 60°
in acciaio HSS

• Per l'esecuzione rapida e sicura dei fori di centraggio



DIN 333/A

Ø mm	D mm	L mm		
1,60	4,0	35,5	1	004220116
2,50	6,3	45,0	1	004220125
3,15	8,0	50,0	1	004220131

423

punte speciali
per punti di saldatura
in acciaio HSS, rettificate



Ø mm	L mm		
6	66	5	004230006
7	74	5	004230007
8	79	5	004230008
10	89	5	004230010

423A

frese speciali per punti
di saldatura, in acciaio HSS
rettificate



DIN 1412/E

Ø mm	L mm		
6,5	40	1	004230015
8,0	40	1	004230020

424

frese coniche per forare
ed allargare
in acciaio HSS



	L mm	Ø mm	D mm		
424/1	58	3÷14	6	2	004240001
424/2	63	6÷20	8	2	004240002
424/3	60	16÷30	10	2	004240003
424/4	80	3÷22	8	1	004240004
424/5	102	3÷31	10	1	004240005
424/6	86	26÷40	13	1	004240006
424/7	89	36÷50	13	1	004240007
424/8	90	40÷61	13	1	004240008



424/SP3	1	004240019
424/1+424/2+424/3		
Ø 3÷30 mm		
424/SPV	1	004240020

425

frese coniche a gradino
in acciaio HSS



	L	Ø	S	D		
	mm	mm	mm	mm		
425/1	70	4÷12	1	6	2	004250010
425/2	55	4÷12	2	6	2	004250012
425/3	85	4÷20	2	10	2	004250015
425/4	85	12÷20	1	10	1	004250016
425/5	97	20÷30	1	10	1	004250017
425/6	75	4÷30	2	10	1	004250020
425/7	97	30÷40	1	13	1	004250025
425/8	100	40÷50	1	13	1	004250029



425/SP3	1	004250030
425/1+425/3+425/6		
Ø 4÷30 mm		
425/SPV	1	004250035

426

frese a svasare ed incassare
a tre taglienti
in acciaio HSS



DIN 335-C

GR	Ø	L	Ø1		
	mm	mm	mm		
1	4,3	44	4	3	004260001
2	5,3	44	4	3	004260002
3	6,3	44	5	3	004260003
4	7,3	44	6	3	004260004
5	8,3	50	6	3	004260005
6	9,4	50	6	3	004260006
7	10,4	54	6	3	004260007
8	12,4	54	8	3	004260008
9	15,0	56	10	3	004260009
10	16,5	60	10	3	004260010
11	20,5	63	10	3	004260011
12	25,0	66	10	3	004260012
13	28,0	71	12	3	004260013
14	31,0	71	12	3	004260014



DIN 335-C

426/SP6	1	004260030
GR 3-5-7-8-10-11		
Ø 6,3÷20,5 mm		
426/SPV	1	004260035

426T

frese a svasare ed incassare
a tre taglienti
in acciaio HSS + TiN



DIN 335-C

GR	Ø	L	Ø1		
	mm	mm	mm		
1	4,3	44	4	3	004260061
2	5,3	44	4	3	004260062
3	6,3	44	5	3	004260063
4	7,3	44	6	3	004260064
5	8,3	50	6	3	004260065
6	9,4	50	6	3	004260066
7	10,4	54	6	3	004260067
8	12,4	54	8	3	004260068
9	15,0	56	10	3	004260069
10	16,5	60	10	3	004260070
11	20,5	63	10	3	004260071
12	25,0	66	10	3	004260072
13	28,0	71	12	3	004260073
14	31,0	71	12	3	004260074



DIN 335-C

426T/SP6	1	004260080
GR 3-5-7-8-10-11		
Ø 6,3÷20,5 mm		
426/SPV	1	004260035

426SB

frese a sbavare e svasare
in acciaio HSS

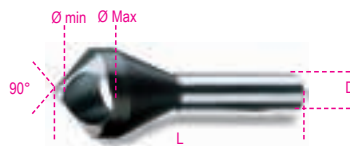

	GR	Ø	D	L		
		mm	mm	mm		
426/SB1	1	2÷5	6	45	1	004260101
426/SB2	2	5÷10	8	48	1	004260102
426/SB3	3	10÷15	10	65	1	004260103
426/SB4	4	15÷20	12	85	1	004260104
426/SB5	5	20÷25	15	102	1	004260105
426/SB6	6	25÷30	15	115	1	004260106



426SB/SP4	1	004260130
426/SB1-426/SB2		
426/SB3-426/SB4		
Ø 2÷20 mm		
426SB/SPV1	1	004260135

426MD-3/CP3

mini frese rotative in metallo duro

• Taglio incrociato tipo dolce con rompitruciolo



L	Ø		
mm	mm		
38,1	3	1	004260332

426MD-3/CT3

mini frese rotative in metallo duro

• Taglio incrociato tipo dolce con rompitruciolo



L	Ø		
mm	mm		
37,8	3	1	004260333

426MD-3/F3

mini frese rotative in metallo duro

• Taglio incrociato tipo dolce con rompitruciolo



L	Ø		
mm	mm		
38,3	3	1	004260334

426MD-3/FA3

mini frese rotative in metallo duro

• Taglio incrociato tipo dolce con rompitruciolo



L	Ø		
mm	mm		
38,2	3	1	004260339

426MD-3/OG3

mini frese rotative in metallo duro

• Taglio incrociato tipo dolce con rompitruciolo



L	Ø		
mm	mm		
38,1	3	1	004260337

426MD-3/OV3

mini frese rotative in metallo duro

• Taglio incrociato tipo dolce con rompitruciolo



L mm	Ø mm	
38,2	3	1 004260331

426MD-3/S3

mini frese rotative in metallo duro

• Taglio incrociato tipo dolce con rompitruciolo



L mm	Ø mm	
38,0	3	1 004260338

426MD-3/T3

mini frese rotative in metallo duro

• Taglio incrociato tipo dolce con rompitruciolo



L mm	Ø mm	
38,3	3	1 004260336

426MD-3/TA3

mini frese rotative in metallo duro

• Taglio incrociato tipo dolce con rompitruciolo



L mm	Ø mm	
38,3	3	1 004260335



426MD-3/A9		
426MD-3/OV3 - 426MD-3/CP3		1 004260349
426MD-3/CT3 - 426MD-3/F3		
426MD-3/TA3 - 426MD-3/T3		
426MD-3/OG3 - 426MD-3/S3		
426MD-3/FA3		

426MD/CP

lime rotative in metallo duro

taglio incrociato HM6



L mm	Ø mm	
50	6	1 004260532
63	8	1 004260512
63	9,5	1 004260542
69	12	1 004260522
69	16	1 004260552

426MD/CT

lime rotative in metallo duro

taglio incrociato HM6



L mm	Ø mm	
50	6	1 004260533
63	8	1 004260513
63	9,5	1 004260543
69	12	1 004260523
69	16	1 004260553

426MD/F

lime rotative in metallo duro

taglio incrociato HM6



L mm	Ø mm	
50	6	1 004260534
63	8	1 004260514
63	9,5	1 004260544
69	12	1 004260524
69	16	1 004260554

426MD/FA

lime rotative in metallo duro

taglio incrociato HM6



L mm	Ø mm	
50	6	1 004260539
63	8	1 004260519
63	9,5	1 004260549
69	12	1 004260529
69	16	1 004260559

426MD/OG

lime rotative in metallo duro

taglio incrociato HM6



L mm	Ø mm	
50	6	1 004260537
63	8	1 004260517
70	10	1 004260547
76	12	1 004260527
81	16	1 004260557

426MD/OV

lime rotative in metallo duro

taglio incrociato HM6



L mm	Ø mm	
50	6	1 004260531
61	9,5	1 004260541
67	12	1 004260521
69	16	1 004260551

426MD/S

lime rotative in metallo duro

taglio incrociato HM6



L mm	Ø mm	
50	6	1 004260538
51	8	1 004260518
53	9,5	1 004260548
56	12	1 004260528
59	16	1 004260558

426MD/T

lime rotative in metallo duro

taglio incrociato HM6



L mm	Ø mm	
50	6	1 004260536
63	8	1 004260516
63	9,5	1 004260546
69	12	1 004260526
70	16	1 004260556

426MD/TA

lime rotative in metallo duro

taglio incrociato HM6



L mm	Ø mm	
50	6	1 004260535
67	8	1 004260515
72	9,5	1 004260545
73	12	1 004260525
78	16	1 004260555



426MD/SP10		
426MD/CP-426MD/CT-426MD/F		1 004260510
426MD/T-426MD/S		
Ø 8-12 mm		

427

estrattori coni Morse



DIN 317

GR	L mm	A mm		
0	92	13	3	004270000
1-2	140	19	3	004270002
3	190	25	3	004270003
4	225	30	3	004270004
5-6	260	35	3	004270006

428FP

maschi a macchina per fori passanti
passo grosso
in acciaio HSS

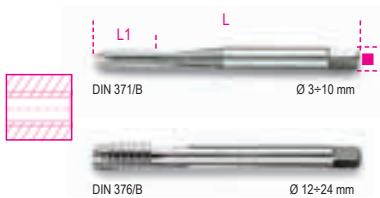

ISO 529

M	■ mm	L mm	L1 mm		
3x0,5	2,7	56	11	10	004280003
4x0,7	3,4	63	13	10	004280004
5x0,8	4,9	70	16	10	004280005
6x1	4,9	80	19	10	004280006
8x1,25	6,2	90	22	10	004280008
10x1,5	8,0	100	24	10	004280010
12x1,75	7,0	110	29	5	004280012
14x2	9,0	110	30	5	004280014
16x2	9,0	110	30	5	004280016
18x2,5	11,0	125	34	3	004280018
20x2,5	12,0	140	34	3	004280020
22x2,5	14,5	140	34	3	004280022
24x3	14,5	160	38	3	004280024

428FC

maschi a macchina per fori ciechi
passo grosso
in acciaio HSS



ISO 529

M	■ mm	L mm	L1 mm		
3x0,5	2,7	56	11	10	004280103
4x0,7	3,4	63	13	10	004280104
5x0,8	4,9	70	16	10	004280105
6x1	4,9	80	19	10	004280106
8x1,25	6,2	90	22	10	004280108
10x1,5	8,0	100	24	10	004280110
12x1,75	7,0	110	29	5	004280112
14x2	9,0	110	30	5	004280114
16x2	9,0	110	30	5	004280116
18x2,5	11,0	125	34	3	004280118
20x2,5	12,0	140	34	3	004280120
22x2,5	14,5	140	34	3	004280122
24x3	14,5	160	38	3	004280124

428/C14

assortimento di 14 maschi a macchina
428FP+428FC



428/C14	1	004280201
428FP M3÷12		
428FC M3÷12		
428/SPV	1	004280202

429FP

maschi a macchina per fori passanti
passo grosso
in acciaio HSS-CO 5%

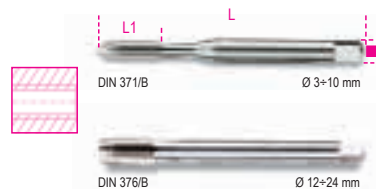

ISO 529

M	■ mm	L mm	L1 mm		
3x0,5	2,7	56	11	5	004290003
4x0,7	3,4	63	13	5	004290004
5x0,8	4,9	70	16	5	004290005
6x1	4,9	80	19	5	004290006
8x1,25	6,2	90	22	5	004290008
10x1,5	8,0	100	24	5	004290010
12x1,75	7,0	110	29	5	004290012
14x2	9,0	110	30	5	004290014

429FC

maschi a macchina per fori ciechi
passo grosso
in acciaio HSS-CO 5%

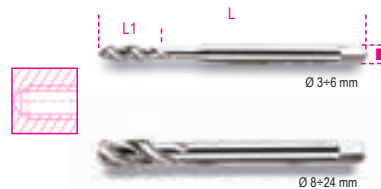

ISO 529

M	■ mm	L mm	L1 mm		
3x0,5	2,7	56	11	5	004290103
4x0,7	3,4	63	13	5	004290104
5x0,8	4,9	70	16	5	004290105
6x1	4,9	80	19	5	004290106
8x1,25	6,2	90	22	5	004290108
10x1,5	8,0	100	24	5	004290110
12x1,75	7,0	110	29	5	004290112
14x2	9,0	110	30	5	004290114

429/C14

assortimento di 14 maschi a macchina
429FP+429FC



429/C14	1	004290201
429FP M3÷12		
429FC M3÷12		
428/SPV	1	004280202

430

serie di 3 maschi a mano
sgrossatore, intermedio, finitore
passo grosso, in acciaio al cromo



DIN 352 UNI 4535

M	■ mm	L mm	L1 mm		
2x0,4	2,5	36	11	5	004300002
3x0,5	2,5	40	12	5	004300003
4x0,7	3,0	45	14	5	004300004
5x0,8	4,0	48	16	5	004300005
6x1	5,0	50	18	5	004300006
7x1	4,5	50	18	5	004300007
8x1,25	5,0	56	22	3	004300008
9x1,25	5,5	63	22	3	004300009
10x1,5	6,0	70	25	3	004300010
11x1,5	7,0	70	25	3	004300011
12x1,75	7,0	75	30	3	004300012
14x2	8,0	80	32	3	004300014
16x2	10,0	80	32	3	004300016
18x2,5	11,0	95	40	1	004300018
20x2,5	12,0	95	40	1	004300020
22x2,5	14,5	100	40	1	004300022
24x3	14,5	110	50	1	004300024



430/SP21	1	004300201
M 3-4-5-6-8-10-12		
430/SPV	1	004300202

430ASW

serie di 3 maschi a mano
sgrossatore, intermedio, finitore
Whitworth, in acciaio al cromo



DIN 352

BSW	mm	L	L1		
1/8x40	2,7	40	12	5	004300031
5/32x32	3,4	45	14	5	004300032
3/16x24	4,3	48	18	5	004300033
1/4x20	4,9	50	22	5	004300034
5/16x18	4,9	56	25	3	004300035
3/8x16	5,5	70	28	3	004300036
7/16x14	6,2	70	30	3	004300037
1/2x12	7,0	75	32	3	004300038
9/16x12	9,0	80	32	1	004300039
5/8x11	9,0	80	38	1	004300040
3/4x10	11,0	95	40	1	004300041
7/8x9	14,5	100	40	1	004300042
1"x8	16,0	110	50	1	004300043

430ASC

serie di 3 maschi a mano
sgrossatore, intermedio, finitore
UNC, in acciaio al cromo



ANSI B1.1

UNC	mm	L	L1		
1/4x20	4,9	70	30	5	004300051
5/16x18	4,9	70	30	5	004300052
3/8x16	5,5	75	35	3	004300053
7/16x14	6,2	80	40	3	004300054
1/2x13	7,0	85	45	3	004300055
9/16x12	9,0	90	45	3	004300056
5/8x11	9,0	100	47	3	004300057
3/4x10	11,0	110	50	3	004300058
7/8x9	14,5	120	60	1	004300059
1"x8	16,0	130	60	1	004300060

431

serie di 3 maschi a mano
sgrossatore, intermedio, finitore
passo grosso, in acciaio HSS



DIN 352 UNI 4535

M	mm	L	L1		
3x0,5	2,5	40	12	5	004310003
4x0,7	3,0	45	14	5	004310004
5x0,8	4,0	48	16	5	004310005
6x1	5,0	50	18	5	004310006

M	mm	L	L1		
7x1	5,0	50	18	5	004310007
8x1,25	5,0	56	22	3	004310008
10x1,5	6,0	70	25	3	004310010
12x1,75	7,0	75	30	3	004310012
14x2	9,0	80	32	1	004310014
16x2	9,0	80	32	1	004310016
18x2,5	11,0	95	40	1	004310018
20x2,5	12,0	95	40	1	004310020
22x2,5	12,0	100	40	1	004310022
24x3	14,5	110	50	1	004310024



431/SP21	1	004310201
M 3-4-5-6-8-10-12		
431/SPV	1	004310202

433

serie di 2 maschi a mano
sgrossatore e finitore
passo fine, in acciaio al cromo



DIN 2181 UNI 4535

M	mm	L	L1		
6x0,75	4,5	48	16	5	004330201
7x0,75	4,5	56	18	5	004330202
8x0,75	5,0	50	16	5	004330203
8x1	5,0	56	16	5	004330204
9x0,75	6,0	63	22	5	004330205
9x1	6,0	63	22	5	004330206
10x0,75	6,5	63	18	5	004330207
10x1	6,5	63	18	5	004330208
10x1,25	6,5	63	18	5	004330209
11x0,75	7,0	70	25	3	004330210
11x1	7,0	70	25	3	004330211
11x1,25	7,0	70	25	3	004330212
12x0,75	7,0	70	20	3	004330213
12x1	7,0	70	20	3	004330214
12x1,25	7,0	70	20	3	004330215
12x1,5	7,0	70	20	3	004330216
14x1	8,0	80	32	1	004330217
14x1,25	8,0	80	32	1	004330218
14x1,5	8,0	80	32	1	004330219
16x1	10,0	80	32	1	004330220
16x1,5	10,0	80	32	1	004330221
18x1,5	11,0	95	40	1	004330222
18x2	11,0	80	25	1	004330223
20x1,5	14,5	80	22	1	004330224
22x1,5	14,5	80	22	1	004330225
24x1,5	14,5	80	22	1	004330226
24x2	14,5	80	22	1	004330227



433ASF

serie di 2 maschi a mano
UNF, passo fine
in acciaio al cromo



ANSI B1.1

UNF	mm	L	L1		
1/4x28	4,9	70	30	5	004330301
5/16x24	4,9	70	30	5	004330302
3/8x24	5,5	75	35	3	004330303
7/16x20	6,2	80	40	3	004330304
1/2x20	7,0	85	45	3	004330305
9/16x18	9,0	90	45	3	004330306
5/8x18	9,0	100	47	3	004330307
3/4x16	11,0	110	50	3	004330308
7/8x14	14,5	120	60	1	004330309
1"x12	16,0	130	60	1	004330310

433ASG

serie di 2 maschi a mano
filettatura GAS cilindrica
in acciaio al cromo



DIN 5157

GAS	mm	L	L1		
1/8x28	5,5	65	18	1	004330401
1/4x19	9,0	70	24	1	004330402
3/8x19	9,0	75	25	1	004330403
1/2x14	12,0	80	31	1	004330405
3/4x14	16,0	90	33	1	004330408
1"x11	20,0	100	39	1	004330410

434

serie di 2 maschi a mano
sgrossatore e finitore
passo fine, in acciaio HSS



DIN 2181 UNI 4535

M	mm	L	L1		
6x0,75	4,5	48	16	5	004340001
8x0,75	5,0	56	16	5	004340003
8x1	5,0	56	16	5	004340004
10x0,75	6,5	63	18	5	004340007
10x1	6,5	63	18	5	004340008
10x1,25	6,5	63	18	5	004340009
12x1	7,0	70	20	3	004340014
12x1,25	7,0	70	20	3	004340015
12x1,5	7,0	70	20	3	004340016
13x1,5	9,0	70	20	1	004340017
14x1	9,0	70	20	1	004340018
14x1,25	9,0	70	20	1	004340019
14x1,5	9,0	70	20	1	004340020
15x1,5	9,0	70	20	1	004340021
16x1	9,0	70	20	1	004340022
16x1,5	9,0	70	20	1	004340023
18x1,5	11,0	80	22	1	004340024
18x2	11,0	90	25	1	004340025
20x1,25	12,0	80	22	1	004340026
20x1,5	12,0	80	22	1	004340027
20x2	12,0	90	25	1	004340028
22x1,5	14,5	80	22	1	004340029
24x1	14,5	80	22	1	004340030
24x1,5	14,5	80	22	1	004340031
24x2	14,5	80	22	1	004340032

435

giramaschi regolabili
corpo in acciaio



DIN 1814

	□ mm	L mm		
435/0	2÷5 M1÷M8	170	3	004350007
435/1	2÷6 M1÷M10	200	2	004350009
435/1,5	2,5÷6 M1÷M12	200	2	004350011
435/2	3÷7 M4÷M12	260	2	004350013
435/3	4÷12 M5÷M20	345	1	004350020
435/4	5,5÷16 M9÷M27	430	1	004350027
435/5	7÷18 M13÷M32	770	1	004350032

435G

giramaschi regolabili
corpo in lega leggera



DIN 1814

	□ mm	L mm		
435G/0	2÷5 M1÷M8	130	5	004350108
435G/1	2÷6 M1÷M10	190	5	004350110
435G/1,5	2÷7 M2÷M12	175	5	004350112
435G/2	3,4÷7 M4÷M12	280	5	004350114
435G/3	4,9÷12 M5÷M20	380	2	004350121
435G/4	7÷16 M11÷M27	500	2	004350127
435G/5	7÷18 M13÷M32	700	1	004350132
435G/6	11÷24 M18÷M42	800	1	004350142

436

giramaschi a cricchetto
reversibile

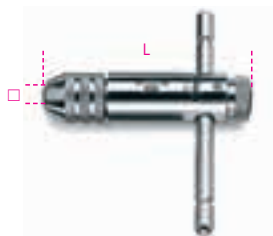

	□ mm	L mm		
436/1	2÷5 M3÷M8	85	5	004360002
436/2	4,6÷8 M5÷M12	110	5	004360004

436L

giramaschi a cricchetto
reversibile, tipo lungo



	□ mm	L mm		
436L/1	2÷5 M3÷M8	245	2	004360012
436L/2	4,6÷8 M5÷M12	295	2	004360014

436R

morsetti di ricambio per 436 e 436L

436R/1	1	004360022
436R/2	1	004360024

437P

ravvivafilette
per ripristino di filettature interne ed esterne,
destre e sinistre

P 0,80-1,00-1,25-1,50-1,75-2,00-2,50-3,00 mm



L mm		
230	1	004370003

437C

set ripristino filettature candela danneggiate,
M14x1,25 mm

• altezza elicoidi: 8,40 - 12,40 - 16,40 mm. (5 pz per misura)



437C	1	004370100
------	---	-----------

437C/...

elicoidi in acciaio inossidabile per 437C



H mm		
8.4	1	004370108
12.4	1	004370112
16.4	1	004370116

I prezzi indicati sono relativi a 10 pezzi

437C/RM14

maschi filetti candele M14x1,25



437C/RM14	1	004370124
-----------	---	-----------

437K/8

assortimento per ripristino
filetti semiassi

- permette di ripassare e ravvivare il filetto originale
- Incluse nel kit:
- misure metriche:
20x1,25 - 20x1,5 - 22x1,00 - 22x1,5 - 24x1,5 - 24x2,00
- misure in pollici
3/4x20 - 13/16x20



○ 32 mm

437K/8	1	004370020
--------	---	-----------

☞ 200x110x30 mm

437K/9

assortimento per ripristino filettature
maschio e femmina, viti fissaggio ruote

permette di ripassare e ravvivare il filetto originale

- Inclusi nel kit:
- maschi:
M12x1,25 - M12x1,5 - M12x1,75 - M14x1,5
- filiere:
M12x1,25 - M12x1,5 - M14x1,5



○ 12 - 24 mm

437K/9	1	004370029
--------	---	-----------

☞ 161x123x50 mm

Beta
QUALITY TOOLS



437K/10

assortimento per il ripristino delle filettature danneggiate dei sensori ossigeno M18x1,5

inclusi nel kit:

- 1 alesatore pilota M18
- 1 maschio M18x1,5
- 1 maschio M20x1,5
- 5 boccole filettate M18x1,5
- 1 utensile di manovra per boccole



∅ 13 - 27 mm

437K/10 1 004370030

210x105x40 mm

437K/12

assortimento per ripristino filetti semiassi

permette di ripassare e ravvivare il filetto originale

Incluse nel kit:

• misure metriche:

M16x1,0 - M16x1,5 - M20x1,0 - M20x1,5 - M22x1,5 - M24x1,5 - M24x2,0 - M27x2,0

• misure in pollici:

3/4x16 - 3/4x20 - 13/16x20 - 27/32x20



∅ 32 - 35 mm

437K/12 1 004370032

220x118x52 mm

437K/16

assortimento per il ripristino delle filettature danneggiate dei supporti pinze freno M9x1,25



437K/16 1 004370016

210x150x50 mm

437K/33

assortimento per il ripristino delle filettature candele danneggiate

Boccole:

M8x1,0 - M10x1,0 - M10x1,25 - M12x1,25

Maschi:

M8x1,0 - M10x1,0 - M10x1,25 - M12x1,0 - M12x1,25 - M14x1,25



437K/33 1 004370133

210x150x50 mm

437U/09

assortimento per il ripristino delle filettature danneggiate



25 x M5, M6, M8, M10
10 x M12

437U/09 1 004370550

M5X0,8
M6X1,0
M8X1,25
M10X1,5
M12X1,75

370x230x55 mm - 2 Kg

437U/E-M...

elicoidei in acciaio inossidabile



	H mm	
M5	7,5	1 004370555
M6	9	1 004370556
M8	12	1 004370558
M10	15	1 004370560
M12	18	1 004370562

I prezzi indicati sono relativi a 25 pezzi (10 per la misura M12)

437U/PM

punte e maschi per 437U/09



M5	1 004370565
M6	1 004370566
M8	1 004370568
M10	1 004370570
M12	1 004370572

438A

serie di punte per forare, filettare e svasare; in acciaio HSS

- M3 - M4 - M5 - M6 - M8 - M10
- con portainseri magnetico



1/4
S MAX mm = Ø mm

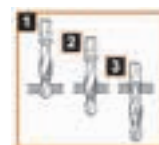

438A 1 004380010

438...

punte per forare, filettare e svasare

in acciaio HSS, attacco 1/4"

1/4



	S max mm	
M3	3	2 004380103
M4	4	2 004380104
M5	5	2 004380105
M6	6	2 004380106
M8	8	2 004380108
M10	10	2 004380110

440

filiere tonde passo grosso in acciaio al cromo

R ≤ 600 N/mm²
HRC ~ 60±61

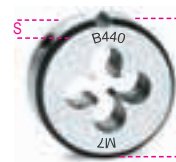

UNI 4535
DIN 223

M	Ø x S mm	
2x0,4	25,4 x 9	5 004400002
3x0,5	25,4 x 9	5 004400003
4x0,7	25,4 x 9	5 004400004
5x0,8	25,4 x 9	5 004400005
6x1	25,4 x 9	5 004400006
7x1	25,4 x 9	5 004400007
8x1,25	25,4 x 9	5 004400008
9x1,25	25,4 x 9	5 004400009
10x1,5	25,4 x 9	5 004400010
12x1,75	25,4 x 9	5 004400012

440A

filiere tonde **passo grosso**
in acciaio al cromo

R ≤ 600 N/mm²
HRC 60±61

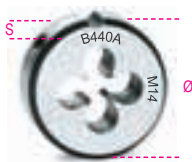

UNI 4535
DIN 223

M	Ø x S mm		
10x1,5	38,1 x 14	3	004400110
11x1,5	38,1 x 14	3	004400111
12x1,75	38,1 x 14	3	004400112
14x2	38,1 x 14	3	004400114
16x2	38,1 x 14	3	004400116
18x2,5	38,1 x 14	3	004400118
20x2,5	38,1 x 14	3	004400120

440B

filiere tonde **passo grosso**
in acciaio al cromo

R ≤ 600 N/mm²
HRC- 60±61

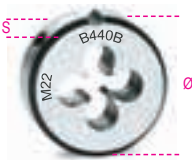

UNI 4535
DIN 223

M	Ø x S mm		
18x2,5	50,8 x 16	3	004400122
20x2,5	50,8 x 16	3	004400124
22x2,5	50,8 x 16	3	004400126
24x3	50,8 x 16	3	004400128

440ASW

filiere tonde **Whitworth**
in acciaio al cromo

R ≤ 600 N/mm²



UNI EN 22568
DIN 223

BSW	Ø x S mm		
1/8x40	25,4 x 9	5	004400201
5/32x32	25,4 x 9	5	004400202
3/16x24	25,4 x 9	5	004400203
1/4x20	25,4 x 9	5	004400204
5/16x18	25,4 x 9	5	004400205
3/8x16	38,1 x 14	3	004400206
7/16x14	38,1 x 14	3	004400207
1/2x12	38,1 x 14	3	004400208
9/16x12	38,1 x 14	3	004400209
5/8x11	50,8 x 16	3	004400210
3/4x10	50,8 x 16	3	004400211
7/8x9	50,8 x 16	3	004400212
1"x8	50,8 x 16	3	004400213

440ASC

filiere tonde, **UNC**
passo grosso, in acciaio al cromo

R ≤ 600 N/mm²



UNI EN 22568
DIN 223

UNC	Ø x S mm		
1/4x20	25,4 x 9	5	004400221
5/16x18	25,4 x 9	5	004400222
3/8x16	38,1 x 14	3	004400223
7/16x14	38,1 x 14	3	004400224
1/2x13	38,1 x 14	3	004400225
9/16x12	38,1 x 14	3	004400226
5/8x11	50,8 x 16	3	004400227
3/4x10	50,8 x 16	3	004400228
7/8x9	50,8 x 16	3	004400229
1"x8	50,8 x 16	3	004400230

440ASF

filiere tonde, **UNF**
passo fine, in acciaio al cromo

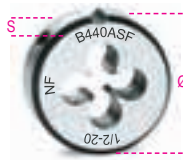

UNI EN 2258
DIN 223

UNF	Ø x S mm		
1/4x28	25,4 x 9	5	004400241
5/16x24	25,4 x 9	5	004400242
3/8x24	38,1 x 14	3	004400243
7/16x20	38,1 x 14	3	004400244
1/2x20	38,1 x 14	3	004400245
9/16x18	38,1 x 14	3	004400246
5/8x18	50,8 x 16	3	004400247
3/4x16	50,8 x 16	3	004400248
7/8x14	50,8 x 16	3	004400249
1"x12	50,8 x 16	3	004400250

440ASG

filiere tonde, filettatura **GAS** cilindrica
in acciaio al cromo

R ≤ 600 N/mm²



UNI EN 24231
DIN 223

GAS	Ø x S mm		
1/8x28	38,1 x 14	3	004400255
1/4x19	38,1 x 14	3	004400256
3/8x19	38,1 x 14	3	004400257
1/2x14	50,8 x 16	3	004400259
3/4x14	50,8 x 16	3	004400260
1"x11	63,5 x 19	3	004400261

441

filiere tonde **passo fine**
in acciaio al cromo

R ≤ 600 N/mm²
HRC ~ 60±61



UNI 4535
DIN 223

M	Ø x S mm		
6x0,75	25,4 x 9	5	004410004
7x0,75	25,4 x 9	5	004410005
8x0,75	25,4 x 9	5	004410006
8x1	25,4 x 9	5	004410007
9x0,75	25,4 x 9	5	004410008
9x1	25,4 x 9	5	004410009

441A

filiere tonde **passo fine**
in acciaio al cromo

R ≤ 600 N/mm²
HRC ~ 60±61



UNI 4535
DIN 223

M	Ø x S mm		
10x0,75	38,1 x 14	3	004410100
10x1	38,1 x 14	3	004410101
10x1,25	38,1 x 14	3	004410102
11x0,75	38,1 x 14	3	004410103
11x1	38,1 x 14	3	004410104
11x1,25	38,1 x 14	3	004410105
12x0,75	38,1 x 14	3	004410106
12x1	38,1 x 14	3	004410107
12x1,25	38,1 x 14	3	004410108
12x1,5	38,1 x 14	3	004410109
14x1	38,1 x 14	3	004410110
14x1,25	38,1 x 14	3	004410111
14x1,5	38,1 x 14	3	004410112
16x1	38,1 x 14	3	004410113
16x1,5	38,1 x 14	3	004410114
18x1,5	38,1 x 14	3	004410115



441B

filiere tonde **passo fine**
in acciaio al cromo

R ≤ 600 N/mm²
HRC ~ 60÷61



UNI 4535
DIN 223

M	Ø x S mm		
18x1,5	50,8 x 16	3	004410117
18x2	50,8 x 16	3	004410118
20x1,5	50,8 x 16	3	004410119
22x1,5	50,8 x 16	3	004410120
24x1,5	50,8 x 16	3	004410121
24x2	50,8 x 16	3	004410122

442

filiere tonde **passo grosso**
in acciaio HSS

HRC ~ 62÷63
AISI M2



UNI EN 22568
DIN 223

M	ØxS mm		
3x0,5	20x5	3	004420003
4x0,7	20x5	3	004420004
5x0,8	20x7	3	004420005
6x1	20x7	3	004420006
7x1	25x9	3	004420007
8x1,25	25x9	3	004420008
10x1,5	30x11	3	004420010
12x1,75	38x14	3	004420012
14x2	38x14	1	004420014
16x2	45x18	1	004420016
18x2,5	45x18	1	004420018
20x2,5	45x18	1	004420020

443

filiere tonde, **passo fine**
in acciaio HSS

HRC 62÷63
AISI M2



UNI EN 22568
DIN 223

M	ØxS mm		
6x0,75	20x7	1	004430107
8x0,75	25x9	1	004430110
8x1	25x9	1	004430111
10x0,75	30x11	1	004430113
10x1	30x11	1	004430114
10x1,25	30x11	1	004430115
12x1	38x10	1	004430116
12x1,25	38x10	1	004430117
12x1,5	38x10	1	004430118
13x1,5	38x10	1	004430119
14x1	38x10	1	004430120

M	ØxS mm		
14x1,25	38x10	1	004430121
14x1,5	38x10	1	004430122
15x1,5	38x10	1	004430123
16x1	45x14	1	004430124
16x1,5	45x14	1	004430125
18x1,5	45x14	1	004430127
20x1,25	45x14	1	004430129
20x1,5	45x14	1	004430130
20x2	45x14	1	004430131
22x1,5	55x16	1	004430132
24x1	55x16	1	004430133
24x1,5	55x16	1	004430135
24x2	55x16	1	004430136

444

girafilere, corpo in acciaio



EN 22568
DIN 225

	Ø mm	L mm		
444	20x5	190	5	004440005
444/0	20x7	190	5	004440007
444/1	25,4x9,5	210	5	004440025
444/1A	25x9	215	5	004440027
444/1B	30x11	250	5	004440030
444/C	38x10	310	3	004440033
444/1C	38x14	310	3	004440035
444/2	38,1x12,7	300	3	004440038
444/1D	45x14	445	1	004440045
444/2D	45x18	445	1	004440046
444/3	50,8x15,9	520	1	004440050
444/4	55x16	495	1	004440055
444/5A	63,5x19	520	1	004440057

444G

girafilere, corpo in lega leggera



UNI EN 22568
DIN 225

	Ø mm	L mm		
444G/A	16x5	160	5	004440103
444G	20x5	185	5	004440105
444G/0	20x7	185	5	004440107
444G/1	25,4x9,5	215	5	004440125
444G/1A	25x9	215	5	004440127
444G/1B	30x11	265	5	004440130
444G/C	38x10	315	3	004440133
444G/1C	38x14	315	3	004440135
444G/2	38,1x12,6	310	3	004440138
444G/1D	45x14	450	1	004440145
444G/2D	45x18	450	1	004440146
444G/3	50,8x16	485	1	004440150
444G/4	55x16	560	1	004440155
444G/5A	63,5x19	630	1	004440163
444G/6	65x18	630	1	004440165

446/C30

assortimento di maschi e filiere
in acciaio al cromo e accessori
in cassetta di legno



446/C30

325x220x35 mm - 3,2 Kg

430 M mm	440 M mm		
3x0,5	3x0,5	435/1,5	444/1
4x0,7	4x0,7		
5x0,8	5x0,8		
6x1	6x1		
8x1,25	8x1,25		
10x1,5	10x1,5		
12x1,75	12x1,75		

446/C48

assortimento di maschi e filiere
in acciaio al cromo e accessori
in cassetta di legno



446/C48

580x300x50 mm - 5 Kg

430 M mm	440 M mm	440A M mm		
3x0,5	3x0,5	10x1,5	435/1	444/1
4x0,7	4x0,7	12x1,75	435/3	444/2
5x0,8	5x0,8	14x2		
6x1	6x1	16x2		
8x1,25	8x1,25	18x2,5		
10x1,5		20x2,5		
12x1,75				
14x2				
16x2				
18x2,5				
20x2,5				



446/C110

assortimento di maschi e filiere in acciaio al cromo e accessori per autoriparazione in cassetta di legno



446/C110 1 004460060

500x337x60 mm - 8,1 Kg

430		433		440/440A, 441/441A	
M	M	M	M	M	M
mm	mm	mm	mm	mm	mm
2x0,4	6x0,75	2x0,4	6x0,75		
3x0,5	7x0,75	3x0,5	7x0,75		
4x0,7	8x0,75	4x0,7	8x0,75		
5x0,8	8x1	5x0,8	8x1		
6x1	9x0,75	6x1	9x0,75		
7x1	9x1	7x1	9x1		
8x1,25	10x0,75	8x1,25	10x0,75		
9x1,25	10x1	9x1,25	10x1		
10x1,5	10x1,25	10x1,5	10x1,25		
11x1,5	11x0,75	11x1,5	11x0,75		
12x1,75	11x1	12x1,75	11x1		
14x2	11x1,25	14x2	11x1,25		
16x2	12x0,75	16x2	12x0,75		
	12x1		12x1		
	12x1,25		12x1,25		
	12x1,5		12x1,5		
	14x1		14x1		
	14x1,25		14x1,25		
	14x1,5		14x1,5		
	16x1		16x1		
	16x1,5		16x1,5		
	18x1,5		18x1,5		

435/0	444/1	436/1
435/3	444/2	

446ASF/C29

assortimento di maschi e filiere in acciaio al cromo e accessori filettatura UNF in cassetta di legno



446ASF/C29 1 004460070

660x410x50 mm - 6 Kg

433ASF	440ASF		
1/4	1/4	435/1,5	444/1
5/16	5/16	435/3	444/2
3/8	3/8		444/3
7/16	7/16		
1/2	1/2		
9/16	9/16		
5/8	5/8		
3/4	3/4		

446ASW/C36

assortimento di maschi e filiere in acciaio al cromo e accessori filettatura Whitworth in cassetta di legno



446ASW/C36 1 004460075

525x310x50 mm - 3,4 Kg

430ASW	440ASW		
1/8	1/8	435/1,5	444/1
5/32	5/32	435/2	444/2
3/16	3/16		
1/4	1/4		
5/16	5/16		
3/8	3/8		
7/16	7/16		
1/2	1/2		

446ASC/C37

assortimento di maschi e filiere in acciaio al cromo e accessori filettatura UNC in cassetta di legno



446ASC/C37 1 004460080

660x410x50 mm - 6,7 Kg

430ASC	440ASC		
1/4	1/4	435/1,5	444/1
5/16	5/16	435/3	444/2
3/8	3/8		444/3
7/16	7/16		
1/2	1/2		
9/16	9/16		
5/8	5/8		
3/4	3/4		

446ASG/C23

assortimento di maschi e filiere in acciaio al cromo e accessori filettatura GAS cilindrica in cassetta di legno



446ASG/C23 1 004460085

700x430x70 mm - 9,8 Kg

433ASG	440ASG		
1/8	1/8	435/3	444/2
1/4	1/4	435/5	444/3
3/8	3/8		444/5A
1/2	1/2		
3/4	3/4		
1"	1"		



447/C37

assortimento di maschi e filiere in acciaio HSS e accessori in cassetta di metallo



447/C37

1 004470055

≡ 380x185x35 mm - 📦 3,9 Kg

431 M mm	442 M mm		
3x0,5	3x0,5	435/0	444
4x0,7	4x0,7	435/2	444/0
5x0,8	5x0,8		444/1A
6x1	6x1		444/1B
8x1,25	8x1,25		444/1C
10x1,5	10x1,5		
12x1,75	12x1,75		



436/1 0,5x3x75

447/C53

assortimento di maschi e filiere in acciaio HSS e accessori in cassetta di metallo



447/C53

1 004470060

≡ 500x235x50 mm - 📦 9 Kg

431 M mm	442 M mm			
3x0,5	3x0,5	435/1,5	444	436/1
4x0,7	4x0,7	435/3	444/0	436/2
5x0,8	5x0,8		444/1A	
6x1	6x1		444/1B	
8x1,25	8x1,25		444/1C	
10x1,5	10x1,5		444/2D	
12x1,75	12x1,75			
14x2	14x2			
16x2	16x2			
18x2,5	18x2,5			
20x2,5	20x2,5			

447/C70

assortimento di maschi e filiere in acciaio HSS e accessori per autoriparazione ed industria in cassetta di legno



447/C70

1 004470065

≡ 510x340x70 mm - 📦 7,5 Kg

431 M mm	434 M mm	442 M mm	443 M mm
3x0,5	8x1	3x0,5	8x1
4x0,7	10x1,25	4x0,7	10x1,25
5x0,8	12x1,25	5x0,8	12x1,25
6x1	12x1,5	6x1	12x1,5
7x1	14x1,25	7x1	14x1,25
8x1,25	14x1,5	8x1,25	14x1,5
10x1,5	16x1,5	10x1,5	16x1,5
12x1,75	12x1,75		
14x2	14x2		
16x2	16x2		

435/0	444	436/1
435/3	444/0	
	444/1A	
	444/1B	
	444/C	
	444/1C	
	444/1D	
	444/2D	

450

seghe a tazza in acciaio HSS-Co 8%

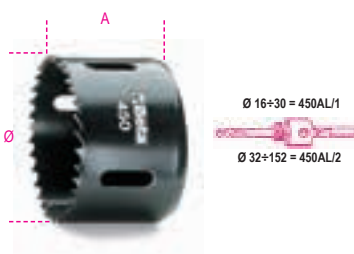

HSS-Co 8%

Ø mm	Ø	A mm	
16	(5/8)	57	1 004500016
17	(11/16)	57	1 004500017
19	(3/4)	51	1 004500019
20	-	51	1 004500020
21	(13/16)	51	1 004500021
22	(7/8)	51	1 004500022
24	(15/16)	51	1 004500024
25	(1")	51	1 004500025
27	(1"1/16)	51	1 004500027
29	(1"1/8)	51	1 004500029
30	(1"3/16)	51	1 004500030
32	(1"1/4)	51	1 004500032
33	(1"5/16)	51	1 004500033
35	(1"3/8)	51	1 004500035

Ø mm	Ø	A mm	
37	(1"7/16)	51	1 004500037
38	(1"1/2)	44	1 004500038
40	(1"9/16)	44	1 004500040
41	(1"5/8)	44	1 004500041
43	(1"11/16)	44	1 004500043
44	(1"3/4)	44	1 004500044
46	(1"13/16)	44	1 004500046
48	(1"7/8)	44	1 004500048
51	(2")	44	1 004500051
52	(2"1/16)	44	1 004500052
54	(2"1/8)	44	1 004500054
57	(2"1/4)	44	1 004500057
59	(2"5/16)	44	1 004500059
60	(2"3/8)	44	1 004500060
64	(2"1/2)	44	1 004500064
65	(2"9/16)	44	1 004500065
67	(2"5/8)	44	1 004500067
68	-	44	1 004500068
70	(2"3/4)	44	1 004500070
73	(2"7/8)	44	1 004500073
76	(3")	44	1 004500076
79	(3"1/8)	44	1 004500079
83	(3"1/4)	44	1 004500083
86	(3"3/8)	44	1 004500086
89	(3"1/2)	44	1 004500089
92	(3"5/8)	44	1 004500092
95	(3"3/4)	44	1 004500095
98	(3"7/8)	44	1 004500098
102	(4")	44	1 004500102
105	(4"1/8)	44	1 004500105
108	(4"1/4)	44	1 004500108
111	(4"3/8)	44	1 004500111
114	(4"1/2)	44	1 004500114
121	(4"3/4)	44	1 004500121
127	(5")	44	1 004500127
140	(5"1/2)	44	1 004500140
152	(6")	44	1 004500152

450AL

alberi per seghe a tazza

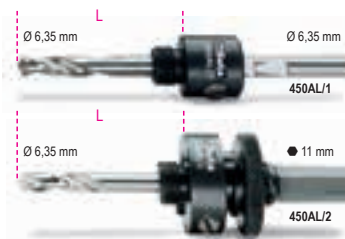

	Ø mm	L mm	
450AL/1	16÷30	54	1 004500210
450AL/2	32÷152	70	1 004500215

450AD

adattatore per alberi 450AL/1



	Ø mm	
450AD	32÷51	1 004500230



450PA/1

punta per centrare
in acciaio HSS
per alberi 450AL/1



ØxL
mm
6,35x105

1 004500252

450PA/2

punta per centrare
in acciaio HSS
per alberi 450AL/2



ØxL
mm
6,35x80

1 004500253

450PR

prolunga per seghe a tazza



L
mm
305

1 004500255

450/C9

assortimento di seghe a tazza
ed accessori per elettricisti



HSS-Co 8%

450/C9

1 004500305

450 Ø 22 - 29 - 35 - 44 - 51 - 64 mm

450AL /1 - /2

450AD

220x160x60 mm - 1,6 Kg

450/C13

assortimento di seghe a tazza
ed accessori per installatori



HSS-Co 8%

450/C13

1 004500310

450 Ø 19 - 22 - 29 - 35 - 38

44 - 51 - 57 - 64 mm

450AL /1 - /2

450PA/1

450AD

215x180x65 mm - 1,8 Kg

450/C15

assortimento di seghe a tazza
e accessori per elettricisti



450/C15

1 004500313

450 Ø 16 - 20 - 25 - 32 - 40

51 - 60 - 65 - 70 mm

450AL /1 - /2

450PA /1 - /2

450PR

450AD

420x185x60 mm - 3,2 Kg

450/C21

assortimento di seghe a tazza
ed accessori per uso industriale



HSS-Co 8%

450/C21

1 004500315

450 Ø 19 - 22 - 29 - 35 - 38

44 - 51 - 57 - 64 - 76

83 - 92 - 95 - 105 - 114 mm

450AL /1 - /2

450PA /1 - /2

450PR

450AD

420x280x60 mm - 7 Kg

451

fresse a tazza
in acciaio HSS
interamente rettificate

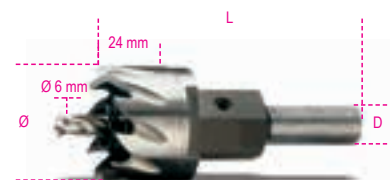

Ø mm	L mm	D mm	
12	85	8	1 004510012
13	85	8	1 004510013
14	85	8	1 004510014
15	85	10	1 004510015
16	85	10	1 004510016
17	85	10	1 004510017
18	85	10	1 004510018
19	85	10	1 004510019
20	85	10	1 004510020
21	85	10	1 004510021
22	85	10	1 004510022
23	85	10	1 004510023
24	85	10	1 004510024
25	85	10	1 004510025
26	90	10	1 004510026
27	90	10	1 004510027
28	90	10	1 004510028
29	90	10	1 004510029
30	90	10	1 004510030
31	90	10	1 004510031
32	90	10	1 004510032
33	90	10	1 004510033
34	90	10	1 004510034
35	90	10	1 004510035
36	85	10	1 004510036
37	85	10	1 004510037
38	85	10	1 004510038
39	85	10	1 004510039
40	85	10	1 004510040
41	85	10	1 004510041
42	85	10	1 004510042
43	85	10	1 004510043
44	85	10	1 004510044
45	85	10	1 004510045
46	85	10	1 004510046
47	85	10	1 004510047
48	85	10	1 004510048
49	85	10	1 004510049
50	85	10	1 004510050

451GA

gambi per frese a tazza 451



M	Ø mm	L mm	D mm		
10x1,25	12÷14	57	8	1	004510101
12x1,25	15÷34	57	10	1	004510102
14x1,5	35÷50	57	10	1	004510105

451PA

punta pilota per frese a tazza 451
in acciaio HSS



Ø mm	L mm		
6	53	1	004510103

451PR

prolunga per frese a tazza 451



M	Ø mm	L mm	Ø1 mm		
12x1,25	15÷34	400	13	1	004510104
14x1,5	35÷50	400	13	1	004510108

452

frese a tazza
con inserti in metallo duro

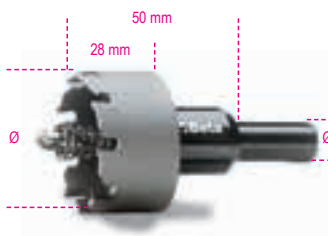

Ø mm	Ø1 mm		
15	10	1	004520015
16	10	1	004520016
17	10	1	004520017
18	10	1	004520018
19	10	1	004520019
20	10	1	004520020
21	10	1	004520021
22	10	1	004520022
23	10	1	004520023
24	10	1	004520024
25	10	1	004520025
26	10	1	004520026
27	10	1	004520027
28	10	1	004520028
29	10	1	004520029
30	10	1	004520030
31	10	1	004520031
32	10	1	004520032
33	10	1	004520033
34	10	1	004520034
35	10	1	004520035
36	10	1	004520036
37	10	1	004520037
38	10	1	004520038
39	13	1	004520039
40	13	1	004520040
41	13	1	004520041
42	13	1	004520042
43	13	1	004520043
44	13	1	004520044
45	13	1	004520045
46	13	1	004520046
47	13	1	004520047
48	13	1	004520048
49	13	1	004520049
50	13	1	004520050
55	13	1	004520055
60	13	1	004520060
65	13	1	004520065
70	13	1	004520070
75	13	1	004520075
80	13	1	004520080
85	13	1	004520085
90	13	1	004520090

452GA

gambi per frese a tazza 452



	Ø mm		
452GA/1	15÷21	1	004520125
452GA/2	22÷38	1	004520126
452GA/3	39÷100	1	004520127

460

frese perforatrici a tazza per edilizia

- Per calcestruzzo, cemento, pietre naturali e artificiali
- Profondità massima di foratura 60 mm



Ø mm	L mm	Z		
50	75	6	1	004600050
60	75	6	1	004600060
65	75	6	1	004600065
80	75	6	1	004600080
90	75	6	1	004600090
100	75	8	1	004600100
112	75	8	1	004600112
125	80	10	1	004600125
150	80	12	1	004600150

460PP

punta pilota per frese a tazza per edilizia 460



Ø mm	L mm		
8	120	1	004600201

460G

gambi per frese perforatrici a tazza 460



L mm			
220	1	004600222	
370	1	004600237	
460	1	004600246	



MOLTIPLICATORI DI COPPIA

I moltiplicatori di coppia sono strumenti indispensabili per serrare dadi e viti con momenti torcenti più alti di quelli consentiti dalla forza dell'operatore in spazi limitati o poco accessibili. Evitano l'uso di ingombranti e rischiose prolunghie offrendo assoluta sicurezza.

La gamma di moltiplicatori Beta offre soluzioni e capacità diverse fino a un valore massimo di **9500 Nm**, con rapporti di moltiplicazione che arrivano fino a 135:1. Molti modelli, soprattutto quelli di maggior potenza, sono dotati di un dispositivo antiritorno in due sensi, per evitare che le tensioni accumulate si scarichino pericolosamente sull'operatore. Ogni moltiplicatore Beta è accompagnato da un **certificato** che ne attesta il collaudo al valore massimo in condizioni ottimali d'impiego.



Istruzioni per un corretto impiego

Il moltiplicatore di coppia **deve essere utilizzato con una chiave dinamometrica** per poter sempre avere il controllo della coppia di uscita, inoltre occorre sempre utilizzare **chiavi a bussola macchina**.

I rapporti di ciascun moltiplicatore definiscono il **fattore di moltiplicazione** tra coppia di ingresso e coppia in uscita. Esempio: moltiplicatore con rapporto 5:1. Applicando 100 Nm in ingresso, impostati sulla chiave dinamometrica, troveremo in uscita 500 Nm come valore trasmesso al dado o alla vite.

Assicurarsi in ogni caso che tutti gli elementi coinvolti nel serraggio agiscano con un buon allineamento.

Evitare di usare **prolunghe**, che si torcono producendo un effetto molla che modifica i valori di coppia applicati.

Assicurarsi sempre che la **barra di reazione** del moltiplicatore sia fissata o appoggiata su una struttura resistente, in grado di sopportare la forza di reazione. Normalmente si utilizzano pareti sufficientemente rigide o viti vicine a quella su cui si agisce. La barra di reazione ruota sempre in direzione **opposta** al senso di serraggio.



Effettuare la manovra con azione fluida e continua.

La tensione accumulata nel serraggio deve essere scaricata ruotando in senso inverso il moltiplicatore, prima di disimpegnarlo; nel caso dei moltiplicatori con dispositivo antiritorno, azionando la leva di inversione.

Tutte queste prescrizioni sono da adottare anche nel caso di **svitamento**.

560/C3

moltiplicatore di coppia destrorso/sinistrorso
in valigetta di materiale plastico
rapporto 3,8:1
con dispositivo antiritorno



Nm	kgfm	lbf.ft	□	■	kg
1500	150	1110	1/2"	3/4"	3,9

560/C3 1 005600030
400x260x110 mm

560/C3PLUS

moltiplicatore di coppia destrorso/sinistrorso
in valigetta di materiale plastico
rapporto 3,8:1
con dispositivo antiritorno



Nm	kgfm	lbf.ft	□	■	kg
2700	270	1991	3/4"	1"	7,5

560/C3PLUS 1 005600038
470x240x160 mm

560/C2

moltiplicatore di coppia destrorso/sinistrorso e
accessori
rapporto 5:1
in cassetta di plastica
per uso intensivo



Nm	Kgfm	lbf.ft	□	■	kg
1300	130	960	1/2	3/4	3,8

560/C2 1 005600020
560/2 1 005600002
560/18 1 005600018
560/19 1 005600019
560/22 1 005600022
310x275x120 mm

560/C4+

moltiplicatore di coppia destrorso/sinistrorso e
accessori
rapporto 5:1
con piede di reazione
per uso intensivo



Nm	Kgfm	lbf.ft	□	■	kg
2700	270	2000	3/4	1"	5

560/C4PLUS 1 005600042
560/4 1 005600004
560/18 1 005600018
560/22 1 005600022
310x275x120 mm

560/C6

moltiplicatore di coppia destrorso/sinistrorso
in valigetta di materiale plastico
rapporto 6,5:1



Nm	kgfm	lbf.ft	□	■	kg
1500	150	1106	1/2"	3/4"	6

560/C6 1 005600160
400x260x110 mm

560/C12

moltiplicatore di coppia destrorso/sinistrorso
in valigetta di materiale plastico
rapporto 12:1



Nm	kgfm	lbf.ft	□	■	kg
2500	250	1844	1/2"	1"	7

560/C12 1 005600210
400x260x110 mm

561/1

moltiplicatore di coppia destrorso/sinistrorso
rapporto 5:1
con due piedi di reazione

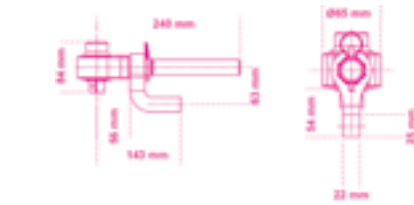

Nm	kgfm	lbf.ft	□	■	kg
1000	100	740	1/2	3/4	2,7

561/1 1 005610010
270x210x70 mm

562-1/VA - 562-2/VA

moltiplicatori di coppia destrorsi/sinistrorsi
rapporto 5,2:1
in valigia 562VV-A

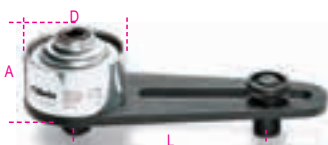

Nm	Kgfm	lbf.ft	□	■	D	A	L min	L max	█
1700	170	1250	3/4	1"	108	95	85	220	8,8

562-1/VA 1 005620601

Nm	Kgfm	lbf.ft	□	■	D	A	L min	L max	█
3400	340	2500	3/4	1"	119	115	85	265	10,5

562-2/VA 1 005620602

564-3R/V - 564-4R/V

moltiplicatori di coppia destrorsi/sinistrorsi
rapporto 25:1
con dispositivo antiritorno
in valigia



Nm	Kgfm	lbf.ft	□	■	D	A	L	█
4000	400	3000	1/2	1"	92	185	205	7,6

564-3R/V 1 005640613

390x310x145 mm

Nm	Kgfm	lbf.ft	□	■	D	A	L	█
7000	700	5000	1/2	1 1/2"	120	200	210	13,2

564-4R/V 1 005640614

500x435x170 mm

565-1R/VA - 565-2R/VA - 565-3R/VA

moltiplicatori di coppia destrorsi/sinistrorsi
rapporto 27:1
con dispositivo antiritorno
in valigia 562VV-A



Nm	Kgfm	lbf.ft	□	■	D	A	L min	L max	█
1700	170	1250	1/2	1"	108	125	80	215	11,2

565-1R/VA 1 005650611

Nm	Kgfm	lbf.ft	□	■	D	A	L min	L max	█
3400	340	2500	1/2	1"	119	145	85	265	13,6

565-2R/VA 1 005650612

Nm	Kgfm	lbf.ft	□	■	D	A	L min	L max	█
3400	340	2500	1/2	1 1/2"	119	145	85	265	14,2

565-3R/VA 1 005650613

565-4R/VB

moltiplicatore di coppia destrorso/sinistrorso
rapporto 27:1
con dispositivo antiritorno
in valigia 565VV-B

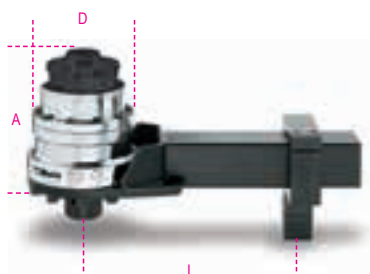

Nm	Kgfm	lbf.ft	□	■	D	A	L min	L max	█
6000	600	4500	1/2	1 1/2"	144	180	125	335	22,4

565-4R/VB 1 005650614

565-5R/VB

moltiplicatore di coppia destrorso/sinistrorso
rapporto 27:1
con dispositivo antiritorno
in valigia 565VV-B

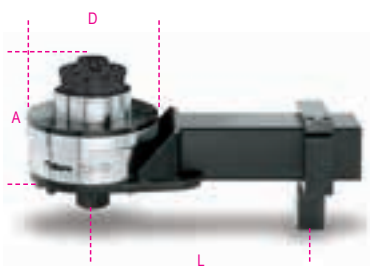

Nm	Kgfm	lbf.ft	□	■	D	A	L min	L max	█
9500	950	7000	3/4	1 1/2"	184	180	155	355	30,4

565-5R/VB 1 005650615

567-4R/VB

moltiplicatore di coppia destrorso/sinistrorso
rapporto 135:1
con dispositivo antiritorno
in valigia 565VV-B

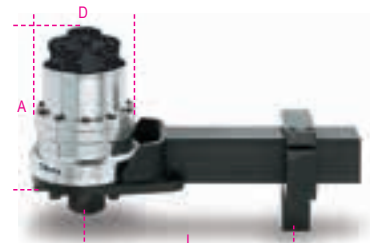

Nm	Kgfm	lbf.ft	□	■	D	A	L min	L max	█
6000	600	4500	1/2	1 1/2"	144	210	125	335	24,4

567-4R/VB 1 005670614

567-5R/VB

moltiplicatore di coppia destrorso/sinistrorso
rapporto 135:1
con dispositivo antiritorno
in valigia 565VV-B

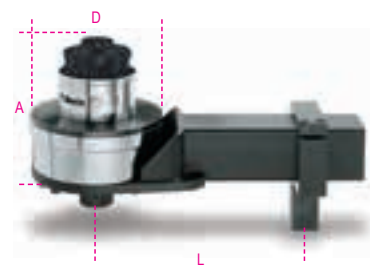

Nm	Kgfm	lbf.ft	□	■	D	A	L min	L max	█
9500	950	7000	1/2	1 1/2"	184	210	155	350	32,4

567-5R/VB 1 005670615

562VV-A

valigia per moltiplicatori,
in polipropilene ad alta resistenza con spugna

Misure interne 380x270x180 mm



562VV-A 1 005620501

562/1-562/2-564/3R
564/4R-565/1R-565/2R
565/3R

410x340x205 mm - █ 3,5 kg

565VV-B

valigia per moltiplicatori,
in polipropilene ad alta resistenza con spugna

Misure interne 480x370x205 mm



565VV-B 1 005650502

565/4R-565/5R
567/4R-567/5R

520x435x230 mm - █ 5,4 kg



Le chiavi dinamometriche devono sempre essere manovrate impugnandole al centro dell'impugnatura, per non modificare il rapporto di leva. Devono essere utilizzate applicando una azione fluida e continua, evitando strappi.



La scala di regolazione deve essere riportata a zero dopo l'utilizzo per non compromettere la precisione di serraggio.



Beta offre una vasta gamma di chiavi con **quattro funzionamenti** differenti.

MODELLI A LETTURA DIRETTA

La coppia di serraggio esercitata viene trasmessa direttamente all'indice di lettura tramite la compressione di una molla elicoidale. La coppia applicata può essere letta in tempo reale grazie a una lancetta indicatrice. Una seconda lancetta può essere posizionata sul valore della coppia obiettivo. Al raggiungimento della coppia obiettivo, la seconda lancetta viene agganciata dalla lancetta principale e registra il picco massimo raggiunto. Garantiscono assoluta precisione e durata nel tempo

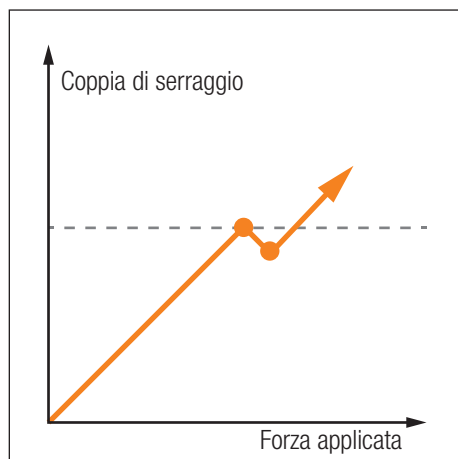

MODELLI A SCATTO

Sono i modelli più diffusi grazie alla loro praticità d'uso. La preselezione della coppia avviene rapidamente caricando la molla. La coppia aumenta all'aumentare della forza applicata. Al raggiungimento della coppia desiderata si ha un improvviso cedimento e per circa 3-5° la chiave non esercita alcuna coppia di serraggio. Se l'operatore non interrompe il movimento, la coppia continua a crescere, superando i valori desiderati.

MODELLI A DISINNESTO

Funzionano come i modelli a scatto, ma quando viene raggiunta la coppia si ha un vistoso cedimento (circa 20°) del braccio-leva. L'operatore ha quindi molto più margine per cessare l'applicazione della forza. Sono utilizzate normalmente per valori di coppia elevati con bracci di leva molto lunghi.

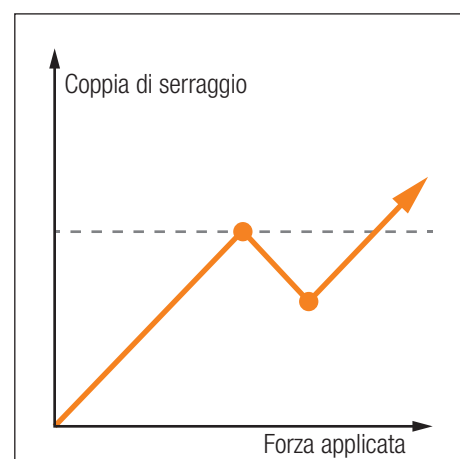
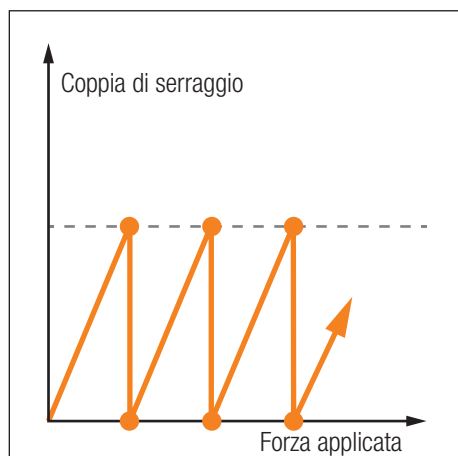

MODELLI A SLITTAMENTO

Al raggiungimento della coppia preselezionata, lo slittamento del meccanismo interrompe l'applicazione della coppia, provocando la rotazione "a vuoto" dell'utensile. In questo modo è impossibile effettuare serraggi con coppie superiori al desiderato. Continuando ad applicare la forza si ripete il medesimo ciclo. Sono ideali per operazioni in serie nel campo delle basse coppie (elettronica e micromeccanica), dove è necessario evitare di rompere componenti fragili o di piccole dimensioni.

CAMPI DI IMPIEGO CHIAVI DINAMOMETRICHE

$$1 \text{ Nm} = 0,10197 \text{ Kgfm} = 0,7375 \text{ lbf.ft}$$



3/4"	596/40SL										80	400							
	596/80SL											160	800						
	667N/40										80	400							
	677/600 677C/600											120	600						
	677/800 677C/800											200	800						
	677/1000 677C/1000												300	1000					
	677C/1500													700	1500				
	678C/65												130	650					
	678C/100													300	1000				
	678C/150														500	1500			
1"	598/200SL														400	2000			
	677/CP2000															900	2000		
ø8	604B/5		1	5															
	604B/10		2	10															
ø11	668N/2			5	25														
	668N/5			10	50														
	668N/10				20	100													
	668N/20					40	200												
	668N/30						60	300											
	668RG/6			8	60														
	668RG/10				20	100													
	668RG/20					40	200												
668RG/30						60	300												
9x12	669N/2			5	25														
	669N/5			10	50														
	669N/10				20	100													
	669N/20					40	200												
14x18	669N/20X					40	200												
	669N/30						60	300											
	669N/40							80	400										
ø22	674/C50												100	500					
	674/C80													160	800				
	674/C100														200	1000			

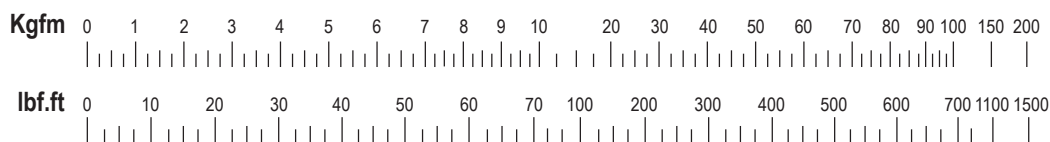

Calcolo della corretta coppia di serraggio

Il braccio di leva cambia per accessori che hanno lunghezza diversa da quella standard ($L_A \neq L_S$). Per il calcolo della corretta coppia da impostare applicare la seguente formula

$$C = \frac{M \cdot (L_B + L_S)}{L_B + L_A} \text{ [N} \cdot \text{m]}$$

- C = coppia da impostare
- M = coppia desiderata
- L_A = lunghezza accessorio (vedi tabella caratteristiche accessori)
- L_B = lunghezza barra (vedi tabella caratteristiche barra dinamometrica)
- L_S = lunghezza accessorio standard (vedi tabella caratteristiche barra dinamometrica)

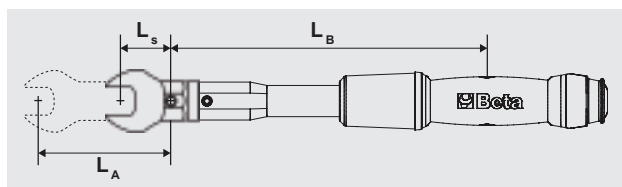

Beta

581

giravite dinamometrico a slittamento non graduato
adatto a serraggi destrorsi
precisione di serraggio +/-6%
(per il settaggio della coppia usare gli artt. 588 - 682)



UNI EN ISO 6789

Nm	gfm	lbf.ft	A	L	kg
1,2÷6	120÷600	1/4"	275		

581 1 005810001

583

giravite dinamometrico a slittamento
adatto a serraggi destrorsi
precisione di serraggio +/-6%



UNI EN ISO 6789

Nm	gfm	lbf.ft	A	L	kg
0,3÷1,5	30÷150	1/4"	240		

583/1,5 1 005830015

Nm	gfm	lbf.ft	A	L	kg
0,6÷3	60÷300	1/4"	240		

583/3 1 005830030

Nm	gfm	lbf.ft	A	L	kg
1,2÷6	120÷600	1/4"	350		

583/6 1 005830060

583/C31

1 giravite dinamometrico, 8 chiavi a bussola esagonali, 20 inserti per avvitatori e 2 accessori

1/4



583/C31 1 005830931

583/6	1.2 - 6 Nm
900	4-5-5,5-6-7-8-9-10 mm
860LP	0,6x4,5 - 1x5,5 - 1,2x6,5 mm
860PH	PH1 - PH2 (x2) - PH3
860PE	2-2,5-3-4-5 mm
860TX	T9-T10-T15-T20-T25-T27-T30-T40
882P/80	80 mm
892/0	1/4" 1/4"

270x120x45 mm - 1,2 kg

590 - 592

chiavi dinamometriche a lettura diretta
adatte a serraggi destrorsi e sinistrorsi
precisione di serraggio ± 4%



UNI EN ISO 6789

Nm	Kgfm	lbf.in	A	L	kg
0,3÷4	0,03÷0,4	3÷35	1/4	60	253

590 1 005900001

Nm	Kgfm	lbf.in	A	L	kg
0,5÷13,5	0,05÷1,35	4÷120	1/4	60	253

590/1 1 005900003

Nm	Kgfm	lbf.in	A	L	kg
1÷27	0,1÷2,7	10÷240	3/8	70	253

592/3 1 005920005

Nm	Kgfm	lbf.in	A	L	kg
3÷40	0,3÷4	20÷360	3/8	70	253

592/4 1 005920007

594

chiavi dinamometriche a lettura diretta
adatte a serraggi destrorsi e sinistrorsi
precisione di serraggio ± 4%

12"

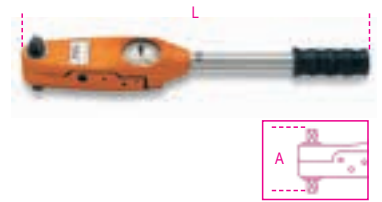

UNI EN ISO 6789

Nm	Kgfm	lbf.ft	A	L	kg
6÷80	0,6÷8	5÷60	1/2	85	455

594/8 1 005940011

Nm	Kgfm	lbf.ft	A	L	kg
20÷215	2÷21,5	15÷160	1/2	85	530

594/21 1 005940015

Servizio di taratura
dinamometria
a fine listino

596 - 598

chiavi dinamometriche a lettura diretta
adatte a serraggi destrorsi e sinistrorsi
precisione di serraggio ± 4%

Il raggiungimento della coppia prefissata
viene segnalato da una luce
e da un suono intermittente



UNI EN ISO 6789

Nm	Kgfm	lbf.ft	A	L	kg
80÷400	8÷40	60÷300	3/4	111	710

596/40SL 1 005960010

Nm	Kgfm	lbf.ft	A	L	kg
160÷800	16÷80	120÷600	3/4	115	1025

596/80SL 1 005960020

Nm	Kgfm	lbf.ft	A	L	kg
400÷2000	40÷200	300÷1500	1"	135	1930

598/200SL 1 005980022

Beta

QUALITY TOOLS

599DGT-AN

chiave dinamometrica elettronica a lettura di coppia e angolo con cricchetto reversibile per serraggi destrorsi (precisione $\pm 2\%$) e sinistrorsi (precisione $\pm 3\%$)

- Tipologie di serraggio: coppia, angolo, coppia + angolo
- Doppia modalità di misura: picco e traccia
- Il raggiungimento della coppia o dell'angolo prefissati vengono segnalati da avvisatori luminosi e da un suono intermittente
- Memorizzazione dei dati di serraggio (fino a 1600 valori)
- 9 valori di coppia/angolo preimpostabili
- Blocco di sicurezza dei tasti
- Possibilità di associare la chiave a 16 utilizzatori tramite ID utente
- Tracciabilità dei dati di serraggio. Il software permette di memorizzare data e ora, numero di serie dell'utensile, valore di serraggio impostato, valore raggiunto, e di associarli all'ID utente
- Impugnatura bimatereale antiscivolo
- Inclusi: 2 batterie AA - 1,5V, cavo USB e software

599DGT

chiave dinamometrica elettronica con cricchetto reversibile per serraggi destrorsi e sinistrorsi precisione di serraggio $\pm 2\%$ destrorso $\pm 3\%$ sinistrorso

- Doppia modalità di misura: picco e traccia
- Il raggiungimento della coppia prefissata viene segnalato da avvisatori luminosi e da un suono intermittente
- Alimentazione con 2 batterie da 1,5V (incluse)



UNI EN ISO 6789



UNI EN ISO 6789

Nm	Kgfm	lbf.ft	■	D	A	L	kg
12÷60	1,2÷6	8÷44	3/8	30	33	413	0,9

599DGT/6 1 005990003

Nm	Kgfm	lbf.ft	■	D	A	L	kg
20÷100	2÷10	15÷80	1/2	30	37	413	0,9

599DGT/10X 1 005990010

Nm	Kgfm	lbf.ft	■	D	A	L	kg
40÷200	4÷20	30÷150	1/2	40	43	520	2

599DGT/20 1 005990020

Nm	Kgfm	lbf.ft	■	D	A	L	kg
68÷340	6,8÷34	58÷280	1/2	40	43	640	2,35

599DGT/30 1 005990030



12V

CE

UNI EN 26789

ISO 6789

UNI EN 26789
ISO 6789

Nm	Kgfm	lbf.ft	■	D	A	L	kg
20÷100	2÷10	15÷80	1/2	30	33	413	0,9

599DGT-AN/10 1 005990610

Nm	Kgfm	lbf.ft	■	D	A	L	kg
40÷200	4÷20	30÷150	1/2	40	43	520	1,3

599DGT-AN/20 1 005990620

Servizio di taratura
dinamometria
a fine listino



600

attrezzi per serraggi angolari

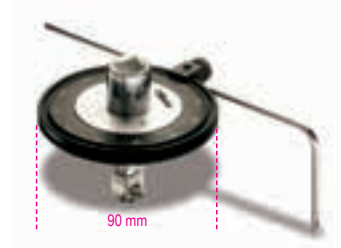

Model	□	■	1	006000001
600/1	1/2	1/2	1	006000001
600/2	3/4	3/4	1	006000002

601C

goniometro digitale per serraggi angolari, magnetico il raggiungimento dell'angolo prefissato viene segnalato da avvisatori luminosi e da un suono intermittente

CE



Model	85x80x87 mm	■	1	006010100
601C	85x80x87 mm	70 g	1	006010100

601CA

goniometro digitale per serraggi coppia ed angolo il raggiungimento della coppia o dell'angolo prefissati viene segnalato da avvisatori luminosi e da un suono intermittente

12V

CE



Model	□	■	Nm	1	006010120
601CA	1/2"	1/2"	10÷200	1	006010120

120x90x120 mm - ■ 240 g

603

chiavi dinamometriche a slittamento
per serraggi destrorsi
precisione di serraggio $\pm 6\%$



UNI EN ISO 6789

Nm	Kgfm	lbf.in	Drive	A mm	L mm	Weight g
1÷5	0,1÷0,5	10÷45	1/4	35	195	235

603/5 1 006030005

Nm	Kgfm	lbf.in	Drive	A mm	L mm	Weight g
2÷10	0,2÷1,0	18÷90	1/4	35	195	235

603/10 1 006030010

604B

barre dinamometriche a disinnesto
per serraggi destrorsi e sinistrorsi
precisione di serraggio $\pm 6\%$



UNI EN ISO 6789

Nm	kgfm	lbf.in	Ø mm	L mm	Weight g
1÷5	0,1÷0,5	10÷45	8	220	290

604B/5 1 006040015

Nm	Kgfm	lbf.in	Ø mm	L mm	Weight g
2÷10	0,2÷1,0	18÷90	8	220	300

604B/10 1 006040020

605E

chiavi dinamometriche a scatto
con cricchetto reversibile
per serraggi destrorsi e sinistrorsi
precisione di serraggio $\pm 6\%$



UNI EN ISO 6789

Nm	Kgfm	lbf.in	Drive	A mm	L mm	Weight g
1÷5	0,1÷0,5	10÷45	1/4	20	190	180

605E/5 1 006050105

Nm	Kgfm	lbf.in	Drive	A mm	L mm	Weight g
2÷10	0,2÷1,0	18÷90	1/4	20	190	180

605E/10 1 006050110

610/5

chiave dinamometrica a scatto
per cricchetto reversibile
per serraggi destrorsi
con 5 valori preregolati
precisione di serraggio $\pm 4\%$

Coppie selezionabili
90 - 100 - 110 - 120 - 130 Nm



UNI EN ISO 6789

Nm	Drive	D mm	A mm	L mm	Weight g
90÷130	1/2	42	39	490	1330

610/5 1 006100025

610L/5

chiave dinamometrica a scatto
con leva a L
per serraggi destrorsi
con 5 valori preregolati
precisione di serraggio $\pm 4\%$

Coppie selezionabili
90 - 100 - 110 - 120 - 130 Nm



UNI EN ISO 6789

Nm	Drive	L mm	L1 mm	Weight g
90÷130	1/2	470	80	1350

610L/5 1 006100125

610L/5L

chiave dinamometrica a scatto
con leva a L
per serraggi destrorsi
con 5 valori preregolati
precisione di serraggio $\pm 4\%$

Coppie selezionabili
120 - 140 - 160 - 180 - 200 Nm



UNI EN ISO 6789

Nm	Drive	L mm	L1 mm	Weight g
120÷200	1/2	470	80	1400

610L/5L 1 006100150

611

cricchetti reversibili
per barre dinamometriche 604B/5 e 604B/10



1/4 L mm 42,5 1 006110001

Servizio di taratura
dinamometria
a fine listino

612 ÷ 614

cricchetti reversibili
per barre dinamometriche



Gli articoli 612 e 612X non devono
essere utilizzati con coppie di serraggio
superiori a 100 Nm

Article	Drive	L mm	LA mm	Weight g
612	3/8	66	32	2 006120000
612X	1/2	66	32	2 006120010
614	1/2	71	32	2 006140000
614X	3/4	71	32	2 006140004

614/50

cricchetto semplice
per barre dinamometriche



614/50 1/2 L mm 71 LA mm 32 2 006140002

Meccanismi rotanti
di ricambio dei cricchetti,
vedi tabella dopo l'art. 929/C8

615

cricchetti reversibili
per barre dinamometriche
con attacco rettangolare



mm	mm	L mm	LA mm		
9x12	3/8	53	28,8	1	006150010
9x12	1/2	53	28,8	1	006150020
14x18	1/2	70	39,8	1	006150120

616 - 617 - 619

quadri maschi
per barre dinamometriche



mm	mm	L mm	LA mm		
616	1/4	61	32	1	006160000
617	3/8	61	32	1	006170000
619	1/2	63	32	1	006190000

621

accessori portainseriti
per barre dinamometriche
con attacco rettangolare
con magnete



mm	mm	L mm	LA mm		
P 1/4	9x12	1/4	43 28,8	1	006210000
* P 5/16	14x18	5/16	52,5 32,5	1	006210110

*Attenzione! Ricalcolare il valore di coppia da impostare
come indicato nella tabella in fondo al listino

622

cricchetti reversibili
per barre dinamometriche
con attacco tondo Ø 22 mm



mm	mm	L mm	LA mm		
622 3/4	3/4	110	56	1	006220019
622 1	1	110	56	1	006220024

641

chiavi a forchetta
per barre dinamometriche 604B/5 e 604B/10



mm	L mm		
4	37	1	006410003
5	37	1	006410004
5,5	37	1	006410005
6	37	1	006410006
7	37	1	006410007
8	42	1	006410008
9	42	1	006410009
10	42	1	006410010

642

chiavi a forchetta
per barre dinamometriche



mm	L mm	LA mm	A mm		
8	54	32	22	1	006420008
10	57	32	26	1	006420010
12	58	32	30	1	006420012
13	58	32	30	1	006420013
14	59	32	32	1	006420014
15	59	32	35	1	006420015
16	59	32	38	1	006420016
17	60	32	39	1	006420017
18	61	32	42	1	006420018
19	61	32	43	1	006420019
20	61	32	50	1	006420020
21	62	32	53	1	006420021
22	62	32	53	1	006420022
23	65	32	53	1	006420023
24	63	32	53	1	006420024
26	64	32	59	1	006420026
27	65	32	59	1	006420027
28	66	32	64	1	006420028
30	66	32	66	1	006420030
32	67	32	66	1	006420032
* 36	76	42	80	1	006420036
* 40	77	52	95	1	006420040
* 41	78	52	95	1	006420041
* 46	90	52	95	1	006420046

*Attenzione! Ricalcolare il valore di coppia da impostare
come indicato nella tabella in fondo al listino

643

chiavi a forchetta
per barre dinamometriche
con attacco rettangolare



mm	mm	L mm	LA mm		
7	9x12	37	28,8	1	006430007
8	9x12	37	28,8	1	006430008
10	9x12	39	28,8	1	006430010
12	9x12	39	28,8	1	006430012
13	9x12	39	28,8	1	006430013
14	9x12	43	28,8	1	006430014
15	9x12	43	28,8	1	006430015

*Attenzione! Ricalcolare il valore di coppia da impostare
come indicato nella tabella in fondo al listino

mm	mm	L mm	LA mm		
16	9x12	43	28,8	1	006430016
17	9x12	43	28,8	1	006430017
* 18	9x12	47	36,3	1	006430018
* 19	9x12	51	36,3	1	006430019
* 21	9x12	52	36,3	1	006430021
* 22	9x12	52	36,3	1	006430022

*Attenzione! Ricalcolare il valore di coppia da impostare
come indicato nella tabella in fondo al listino

mm	mm	L mm	LA mm		
13	14x18	60	39,8	1	006430113
14	14x18	58	39,8	1	006430114
15	14x18	60	39,8	1	006430115
16	14x18	60	39,8	1	006430116
17	14x18	60	39,8	1	006430117
18	14x18	61	39,8	1	006430118
19	14x18	61	39,8	1	006430119
21	14x18	61	39,8	1	006430121
22	14x18	62	39,8	1	006430122
24	14x18	64	39,8	1	006430124
* 27	14x18	68	44,8	1	006430127
* 30	14x18	77	49,8	1	006430130
* 32	14x18	77	49,8	1	006430132
* 34	14x18	80	54,8	1	006430134
* 36	14x18	83	54,8	1	006430136
* 38	14x18	83	54,8	1	006430138
* 41	14x18	91	64,8	1	006430141

*Attenzione! Ricalcolare il valore di coppia da impostare
come indicato nella tabella in fondo al listino

644

chiavi a forchetta
per barre dinamometriche
con attacco tondo Ø 22 mm



mm	L mm	LA mm	A mm		
22	91	56	52	1	006440022
24	91	56	52	1	006440024
27	94	56	64	1	006440027
30	94	56	64	1	006440030
32	97	56	75,5	1	006440032
34	97	56	75,5	1	006440034
36	97	56	75,5	1	006440036
41	103,5	56	94	1	006440041
46	115,5	56	94	1	006440046

650A

chiavi a rullino per barre dinamometriche
con attacco rettangolare



A min-max mm	mm	L mm	LA mm		
* 5-27	9x12	93	74,3	1	006500027
* 5-30	9x12	106	85,3	1	006500030
* 5-30	14x18	115	89	1	006500130
* 10-41	14x18	127	100	1	006500141

*Attenzione! Ricalcolare il valore di coppia da impostare
come indicato nella tabella in fondo al listino

650H

chiavi a settore
per barre dinamometriche
con attacco rettangolare



mm	mm	L mm	LA mm		
* 28-36	14x18	122	92	1	006500928
* 40-45	14x18	129	92	1	006500940
* 50-55	14x18	129	92	1	006500950
* 58-62	14x18	135	92	1	006500958
* 68-75	14x18	139	92	1	006500968
* 80-90	14x18	145	92	1	006500980

*Attenzione! Ricalcolare il valore di coppia da impostare come indicato nella tabella in fondo al listino

652

chiavi poligonali
per barre dinamometriche



mm	L mm	LA mm		
8	58	32	1	006520008
10	58	32	1	006520010
12	58	32	1	006520012
13	58	32	1	006520013
14	58	32	1	006520014
15	62	32	1	006520015
16	63	32	1	006520016
17	64	32	1	006520017
18	65	32	1	006520018
19	65	32	1	006520019
21	67	32	1	006520021
22	68	32	1	006520022
24	69	32	1	006520024
26	71	32	1	006520026
27	71	32	1	006520027
30	73	32	1	006520030
32	74	32	1	006520032

653

chiavi poligonali
per barre dinamometriche
con attacco rettangolare



mm	mm	L mm	LA mm		
7	9x12	40	28,8	1	006530007
8	9x12	40	28,8	1	006530008
10	9x12	43	28,8	1	006530010
12	9x12	44	28,8	1	006530012
13	9x12	44	28,8	1	006530013
14	9x12	45	28,8	1	006530014
15	9x12	46	28,8	1	006530015
16	9x12	47	28,8	1	006530016
17	9x12	47	28,8	1	006530017
18	9x12	48	28,8	1	006530018
19	9x12	49	28,8	1	006530019
21	9x12	51	28,8	1	006530021
22	9x12	51	28,8	1	006530022

mm	mm	L mm	LA mm		
13	14x18	61	39,8	1	006530113
14	14x18	61	39,8	1	006530114
15	14x18	62	39,8	1	006530115
16	14x18	63	39,8	1	006530116

*Attenzione! Ricalcolare il valore di coppia da impostare come indicato nella tabella in fondo al listino

mm	mm	L mm	LA mm		
17	14x18	64	39,8	1	006530117
18	14x18	64	39,8	1	006530118
19	14x18	66	39,8	1	006530119
21	14x18	66	39,8	1	006530121
22	14x18	67	39,8	1	006530122
24	14x18	69	39,8	1	006530124
* 27	14x18	76	44,8	1	006530127
* 30	14x18	77	44,8	1	006530130
* 32	14x18	79	44,8	1	006530132
* 34	14x18	80	44,8	1	006530134
* 36	14x18	80	44,8	1	006530136
* 38	14x18	90	49,8	1	006530138
* 41	14x18	90	49,8	1	006530141

*Attenzione! Ricalcolare il valore di coppia da impostare come indicato nella tabella in fondo al listino

654

chiavi poligonali
per barre dinamometriche
con attacco tondo Ø 22 mm



mm	L mm	LA mm	A mm		
22	98,5	56	38	1	006540022
24	98,5	56	38	1	006540024
27	102,8	56	46,5	1	006540027
30	102,8	56	46,5	1	006540030
32	106,5	56	55	1	006540032
34	106,5	56	55	1	006540034
36	106,5	56	55	1	006540036
41	115,5	56	72	1	006540041
46	115,5	56	72	1	006540046

659/15

raccordo con attacco rettangolare
femmina 14x18 mm e maschio 9x12 mm



mm	mm	mm	LA mm		
* 56	14x18	9x12	39	1	006590815

*Attenzione! Ricalcolare il valore di coppia da impostare come indicato nella tabella in fondo al listino



E' assolutamente necessario commisurare la coppia di serraggio alla capacità del quadro maschio per evitare rotture o danni accidentali

659/16

raccordo con attacco rettangolare
femmina 9x12 mm e maschio 14x18 mm



mm	mm	mm	LA mm		
* 52	9x12	14x18	31	1	006590816

*Attenzione! Ricalcolare il valore di coppia da impostare come indicato nella tabella in fondo al listino

Beta

665 CHIAVI DINAMOMETRICHE MECCANICHE A LETTURA DIGITALE

Le chiavi dinamometriche 665 uniscono la robustezza e l'affidabilità del collaudato meccanismo e dello storico cricchetto Beta alla rapidità di lettura e alla precisione del sistema digitale.



AFFIDABILITÀ

Il robusto cricchetto Beta garantisce fluidità di movimento e una ripresa di soli 5°

PRECISIONE

±3% maggiore precisione rispetto ai requisiti di norma

FLUIDITÀ

Il meccanismo di scatto alleggerisce il movimento e migliora la precisione

LETTURA DIGITALE

Facilita l'impostazione del valore di serraggio e la sua lettura

elevata autonomia

TARATURA

Verifica su più punti, per correggere il comportamento non lineare della molla, ottenibile, con l'ausilio dei misuratori di coppia Beta 682, senza smontare la chiave

RAPIDITÀ

Regolazione della coppia veloce ed efficiente

regolazione digitale della coppia rapida e precisa

665

chiave dinamometrica meccanica a lettura digitale con cricchetto reversibile, per serraggi destrorsi, precisione di serraggio $\pm 3\%$

- Impostazione e lettura semplice della coppia tramite valore visualizzato sul display
- Il display rimane acceso con valore di coppia impostato
- Lettura della coppia con cifra decimale
- Spegnimento automatico dopo 10 sec. con impostazione della coppia inferiore alla soglia minima
- Alimentazione con 1 batteria da 3 V (inclusa)



UNI EN ISO 6789

Nm	■	D mm	A mm	L mm	g
10÷60	3/8	30	33	335	655
665/6 1 006650006					
20÷100	3/8	30	33	375	725
665/10 1 006650010					
20÷100	1/2	30	37	375	725
665/10X 1 006650011					
40÷200	1/2	40	43	470	995
665/20 1 006650020					
60÷330	1/2	40	43	590	1260
665/30 1 006650030					



665LB

chiave dinamometrica meccanica a lettura digitale con cricchetto reversibile, per serraggi destrorsi, precisione di serraggio $\pm 3\%$

- Unità di misura: lbf.ft
- Impostazione e lettura semplice della coppia tramite valore visualizzato sul display
- Il display rimane acceso con valore di coppia impostato
- Lettura della coppia con cifra decimale
- Spegnimento automatico dopo 10 sec. con impostazione della coppia inferiore alla soglia minima
- Alimentazione con 1 batteria da 3 V (inclusa)



UNI EN ISO 6789

lbf.ft	mm	D	A	L	g
7÷45	3/8	30	33	335	655

665LB/6 1 006650106

lbf.ft	mm	D	A	L	g
15÷75	3/8	30	33	375	725

665LB/10 1 006650110

lbf.ft	mm	D	A	L	g
15÷75	1/2	30	37	375	725

665LB/10X 1 006650111

lbf.ft	mm	D	A	L	g
30÷150	1/2	40	43	470	995

665LB/20 1 006650120

lbf.ft	mm	D	A	L	g
45÷240	1/2	40	43	590	1260

665LB/30 1 006650130

665SW

dispositivo di calibrazione

- Il dispositivo permette la calibrazione delle chiavi serie 665 con l'ausilio dei misuratori di coppia Beta 680 e 682, senza la necessità di smontare la chiave.
- La calibrazione avviene su più punti per compensare il comportamento non lineare della molla.
- Dotato di presa Micro USB per consentire futuri aggiornamenti firmware.



665SW 1 006650100

666N CHIAVI DINAMOMETRICHE A SCATTO



Il dentello ha 17 denti sempre in presa che garantiscono un'ottima distribuzione dello sforzo



Scala più grande per garantire una migliore visibilità e un settaggio più accurato



Materiale dell'impugnatura e lente resistenti a olii, carburanti e liquidi industriali



La banda colorata (o-ring rosso posto all'estremità dell'impugnatura) indica che la chiave è sbloccata ed è possibile regolare la coppia di serraggio

666N

chiavi dinamometriche a scatto con cricchetto reversibile per serraggi destrorsi precisione di serraggio $\pm 3\%$



UNI EN ISO 6789

Nm	Kgfm	lbf.ft	mm	D	A	L	g
5÷25	0,5÷2,5	4÷18	1/4	25	29	220	300

666N/2 1 006660002

Nm	Kgfm	lbf.ft	mm	D	A	L	g
5÷25	0,5÷2,5	4÷18	3/8	25	29	220	300

666N/2X 1 006660003

Nm	Kgfm	lbf.ft	mm	D	A	L	g
10÷50	1÷5	7÷37	3/8	30	33	325	660

666N/5 1 006660005

Nm	Kgfm	lbf.ft	mm	D	A	L	g
20÷100	2÷10	15÷75	3/8	30	33	367	730

666N/10 1 006660010

Nm	Kgfm	lbf.ft	mm	D	A	L	g
20÷100	2÷10	15÷75	1/2	30	37	367	800

666N/10X 1 006660011

Nm	Kgfm	lbf.ft	mm	D	A	L	g
40÷200	4÷20	30÷150	1/2	40	43	465	1010

666N/20 1 006660020

Nm	Kgfm	lbf.ft	mm	D	A	L	g
60÷300	6÷30	50÷220	1/2	40	43	581	1380

666N/30 1 006660030



666N LBF.IN

chiavi dinamometriche a scatto con cricchetto reversibile per serraggi destrorsi precisione di serraggio $\pm 3\%$

• Scala in libbre-forza per pollice



UNI EN ISO 6789

lbf.in	mm	D	A	L	g
90÷440	3/8	30	33	325	660

666N-LBF.IN/5 1 006660055

lbf.in	mm	D	A	L	g
200÷900	3/8	30	33	367	730

666N-LBF.IN/10 1 006660070

lbf.in	mm	D	A	L	g
200÷900	1/2	30	37	367	800

666N-LBF.IN/10X 1 006660071

lbf.in	mm	D	A	L	g
400÷1800	1/2	40	43	465	1010

666N-LBF.IN/20 1 006660072

lbf.in	mm	D	A	L	g
500÷3000	1/2	40	43	581	1380

666N-LBF.IN/30 1 006660073

667N

chiavi dinamometriche a scatto con cricchetto semplice per serraggi destrorsi e sinistrorsi precisione di serraggio $\pm 3\%$



UNI EN ISO 6789

Nm	Kgfm	lbf.ft	mm	D	A	L	g
40÷200	4÷20	30÷150	1/2	40	43	465	1010

667N/20 1 006670020

Nm	Kgfm	lbf.ft	mm	D	A	L	g
60÷300	6÷30	50÷220	1/2	40	43	581	1380

667N/30 1 006670030

Nm	Kgfm	lbf.ft	mm	D	A	L	g
80÷400	8÷40	60÷295	3/4	50	50	687	2090

667N/40 1 006670040

Meccanismi rotanti di ricambio dei cricchetti, vedi tabella dopo l'art. 929/C8

668N

barre dinamometriche a scatto per serraggi destrorsi e sinistrorsi precisione di serraggio $\pm 3\%$



UNI EN ISO 6789

Nm	Kgfm	lbf.ft	Ø	L	LB	LS	g
5÷25	0,5÷2,5	4÷18	16	220	148	32	300

668N/2 1 006680002

Nm	Kgfm	lbf.ft	Ø	L	LB	LS	g
10÷50	1÷5	7÷37	16	332	229	32	590

668N/5 1 006680005

Nm	Kgfm	lbf.ft	Ø	L	LB	LS	g
20÷100	2÷10	15÷75	16	362	269	32	670

668N/10 1 006680010

Nm	Kgfm	lbf.ft	Ø	L	LB	LS	g
40÷200	4÷20	30÷150	16	445	352,6	32	795

668N/20 1 006680020

Nm	Kgfm	lbf.ft	Ø	L	LB	LS	g
60÷300	6÷30	50÷220	16	569	475,9	32	1230

668N/30 1 006680030

668RG

barra dinamometrica a scatto non graduata adatta a serraggi destrorsi e sinistrorsi precisione di serraggio $\pm 4\%$ (per il settaggio della coppia usare gli art. 680/40 - 682)



UNI EN ISO 6789

Nm	Kgfm	lbf.ft	Ø	L	g
8÷60	0,8÷6	6÷44	16	288	550

668RG/6 1 006680206

Nm	Kgfm	lbf.ft	Ø	L	g
20÷100	2÷10	15÷80	16	315	600

668RG/10 1 006680210

Nm	Kgfm	lbf.ft	Ø	L	g
40÷200	4÷20	30÷150	16	405	780

668RG/20 1 006680220

Nm	Kgfm	lbf.ft	Ø	L	g
60÷300	6÷30	50÷220	16	645	1130

668RG/30 1 006680230

668RGC

chiave dinamometrica a scatto non graduata con cricchetto reversibile adatta a serraggi destrorsi precisione di serraggio $\pm 4\%$ (per il settaggio della coppia usare gli art. 680/40 - 682)



UNI EN ISO 6789

Nm	Kgfm	lbf.ft	mm	D	A	L	g
12÷60	1,2÷6	5÷45	3/8	30	33	295	600

668RGC/6 1 006680406

Nm	Kgfm	lbf.in	mm	D	A	L	g
20÷100	2÷10	15÷75	3/8	30	33	335	700

668RGC/10 1 006680410

Nm	Kgfm	lbf.in	mm	D	A	L	g
20÷100	2÷10	15÷75	1/2	40	43	342	700

668RGC/10X 1 006680411

Nm	Kgfm	lbf.in	mm	D	A	L	g
40÷200	4÷20	30÷150	1/2	40	43	425	1000

668RGC/20 1 006680420



669N

barre dinamometriche a scatto
attacco rettangolare
per serraggi destrorsi e sinistrorsi
precisione di serraggio $\pm 3\%$



UNI EN ISO 6789

Nm	Kgfm	lbf.ft	□ mm	L mm	LB mm	LS mm	g
5÷25	0,5÷2,5	4÷18	9x12	215	140	28,8	300

669N/2  1 006690202

Nm	Kgfm	lbf.ft	□ mm	L mm	LB mm	LS mm	g
10÷50	1÷5	7÷37	9x12	322	226,8	28,8	590

669N/5  1 006690205

Nm	Kgfm	lbf.ft	□ mm	L mm	LB mm	LS mm	g
20÷100	2÷10	15÷75	9x12	362	266,8	28,8	670

669N/10  1 006690210

Nm	Kgfm	lbf.ft	□ mm	L mm	LB mm	LS mm	g
40÷200	4÷20	30÷150	9x12	445	345,6	28,8	795

669N/20  1 006690220

Nm	Kgfm	lbf.ft	□ mm	L mm	LB mm	LS mm	g
40÷200	4÷20	30÷150	14x18	452	351	39,8	795

669N/20X  1 006690221

Nm	Kgfm	lbf.ft	□ mm	L mm	LB mm	LS mm	g
60÷300	6÷30	50÷220	14x18	569	468,5	39,8	1230

669N/30  1 006690230

Nm	Kgfm	lbf.ft	□ mm	L mm	LB mm	LS mm	g
80÷400	8÷40	60÷295	14x18	664	563	39,8	2100





669N/40  1 006690240

671B/C5

barra dinamometrica 604B/5 e accessori



671B/C5  1 006710001

	604B/5	1+5 Nm
	611	1/4
	641	5-6-7-8 mm
	900	4-5-5,5-6-7-8-9-10 mm

 270x120x45 mm -  1,3 kg

671B/C10

barra dinamometrica 604B/10 e accessori



671B/C10  1 006710002

	604B/10	2+10 Nm
	611	1/4
	641	6-7-8-10 mm
	900	4-5-5,5-6-7-8-9-10 mm









 270x120x45 mm -  1,4 kg

671N/C10

barra dinamometrica 668N/10
e accessori



671N/C10  1 006710110

	668N/10	100 Nm
	612	3/8
	617	3/8
	642	10-13-14-17-19 mm
	652	10-13-14-17-19 mm
	910A	3/8 8-10-11-13-14-17-19 mm
	910/21	125 mm
	910/22	250 mm









 400x180x45 mm -  4,3 kg

671N/C20

barra dinamometrica 668N/20
e accessori



671N/C20  1 006710120

	668N/20	200 Nm
	614	1/2
	619	1/2
	642	10-13-14-17-19 mm
	652	10-13-14-17-19 mm
	920A	1/2 10-11-13-14-17-19-22 mm
	920/20	75 mm
	920/21	125 mm
	920/22	255 mm









 510x180x45 mm -  5,5 kg

671N/C30

barra dinamometrica 668N/30
e accessori



671N/C30  1 006710130

	668N/30	300 Nm
	614	1/2
	619	1/2
	642	13-14-17-19 mm
	652	13-14-17-19 mm
	920A	1/2 13-14-17-19-22-24-27 mm
	920/20	75 mm
	920/21	125 mm
	920/22	255 mm

 620x180x45 mm -  5,8 kg











674/C

barre dinamometriche a scatto
attacco tondo Ø 22 mm
per serraggi destrorsi e sinistrorsi
precisione di serraggio ± 4%
in cassetta



UNI EN ISO 6789

Nm	Kgfm	lbf.ft	Ø mm	L mm	LB mm	LS mm	kg
100÷500	10÷50	80÷400	22	786	725	56	3,4

674/C50 1 006740005

Nm	Kgfm	lbf.ft	Ø mm	L mm	LB mm	LS mm	kg
160÷800	16÷80	120÷600	22	997	915	56	4,5

674/C80 1 006740008

Nm	Kgfm	lbf.ft	Ø mm	L mm	LB mm	LS mm	kg
200÷1000	20÷100	150÷750	22	997	915	56	4,5

674/C100 1 006740010

677

chiavi dinamometriche a disinnesto
con cricchetto semplice
per serraggi destrorsi e sinistrorsi
precisione di serraggio ± 4%



UNI EN ISO 6789

Nm	Kgfm	lbf.ft	D mm	A mm	L mm	kg
120÷600	12÷60	100÷450	69	55	1059	6,0

677/600 1 006770006

Nm	Kgfm	lbf.ft	D mm	A mm	L mm	kg
200÷800	20÷80	150÷600	69	55	1319	6,7

677/800 1 006770008

Nm	Kgfm	lbf.ft	D mm	A mm	L mm	kg
300÷1000	30÷100	200÷750	69	55	1554	7,4

677/1000 1 006770010

677/C

chiavi dinamometriche a disinnesto
con cricchetto semplice
per serraggi destrorsi e sinistrorsi
precisione di serraggio ± 4%
in cassetta



UNI EN ISO 6789

Nm	Kgfm	lbf.ft	D mm	A mm	L mm	kg
120÷600	12÷60	100÷450	69	55	1059	6,0

677/C600 1 006770607

Nm	Kgfm	lbf.ft	D mm	A mm	L mm	kg
200÷800	20÷80	150÷600	69	55	1319	6,7

677/C800 1 006770612

Nm	Kgfm	lbf.ft	D mm	A mm	L mm	kg
300÷1000	30÷100	200÷750	69	55	1554	7,4

677/C1000 1 006770616

Nm	Kgfm	lbf.ft	D mm	A mm	L mm	kg
700÷1500	70÷150	500÷1000	69	55	1869	9,6

677/C1500 1 006770621

677/CP2000

chiavi dinamometriche a disinnesto
con cricchetto semplice
per serraggi destrorsi e sinistrorsi
precisione di serraggio ± 4%
in cassetta



UNI EN ISO 6789

Nm	Kgfm	lbf.ft	D mm	A mm	L mm	kg
900÷2000	90÷200	700÷1500	69	63	1940	12,75

677/CP2000 1 006770721

678/C

chiavi dinamometriche a scatto
con cricchetto semplice
per serraggi destrorsi e sinistrorsi
precisione di serraggio ± 4%
in cassetta

• Modelli 678/C100 e 678/C150 forniti di prolunga.

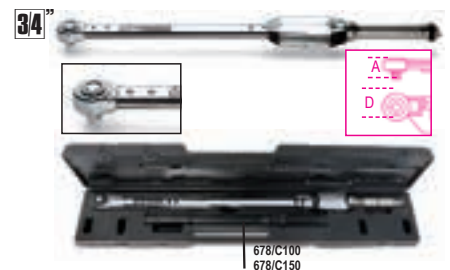

UNI EN ISO 6789

Nm	Kgfm	lbf.ft	D mm	A mm	L mm	kg
130÷650	13÷65	100÷480	63	55	885	3,9

678/C65 1 006780607

Nm	Kgfm	lbf.ft	D mm	A mm	L mm	kg
300÷1000	30÷100	220÷750	75	60	1250	6,0

678/C100 1 006780611

Nm	Kgfm	lbf.ft	D mm	A mm	L mm	kg
500÷1500	50÷150	370÷1100	75	60	1570	8,5

678/C150 1 006780615

677/CV - 678/CV

cassette vuote
per chiavi dinamometriche 677 e 678



677/CVN1 1 006770455

677/C600-677/C800-677/C1000

677/CVN2 1 006770460

677/C1500-677/CP2000

678/CV1 1 006780455

678/C65

678/CV2 1 006780500

678/C100

678/CV3 1 006780415

677/C100-677/C150-678/C150

680

misuratore di coppia elettronico digitale
Dynatester 680

per verifica tarature
funzionamento destrorso e sinistrorso

- Precisione di lettura: $\pm 1\%$ del valore letto
- Display LCD a colori, 4 digit
- Fino a 12 unità di misura (Nm - lbf.ft. - lbf.in...)

CE



	Nm	kg		
680/3	0,1÷3	1,4	1	006800000
680/30	1,5÷30	1,4	1	006800003
680/350	10÷350	2,6	1	006800035
680/2100	200÷2100	3,5	1	006800210

682

misuratore di coppia elettronico digitale
con trasduttori porziometrici

Dynatester 682
funzionamento destrorso e sinistrorso

Alta precisione di lettura
Fornito di uscita seriale RS 232

CE



CARATTERISTICHE TECNICHE:

Precisione di lettura: $\pm 1\%$ del valore letto
Unità di misura selezionabili
Nm-dNm-cNm-Lbf.ft-Lbf.in-Ozf.in-Kgf.m-Kgf.cm-gf.cm
Alimentazione: 90 a 264V AC a 50/60 Hz
Dimensioni: 235x185x185 mm
Verifica di tolleranza secondo norma ISO6789
Indicazione dell'intervallo di accettabilità specifico
per ogni chiave dinamometrica testata
Display: Menu selezionabile in 11 lingue
Documentazione allegata
Certificato di calibrazione con rintracciabilità UKAS

	Nm	kg		
682/60	1,2÷60	5,9	1	006820006
682/400	8÷400	6,1	1	006820040
682/1500	30÷1500	6,4	1	006820150

BUSSOLE MACCHINA



Le chiavi a bussola macchina sono realizzate con acciai e trattamenti termici tali da garantire la migliore resistenza all'impatto e alle vibrazioni.

Il nuovo **profilo poligonale** permette di ottenere un immediato accoppiamento sul dado. Nel loro impiego è assolutamente necessario l'uso di spine e anelli di tenuta per impedire il distacco dal quadro di manovra.

Ai classici modelli standard, serie lunga e lunga sottile si affiancano il **nuovo profilo XZN®** e un ampliamento di gamma degli accessori per bussole macchina.



710

chiavi a bussola Macchina
serie normale



UNI/ISO 2725 DIN 3129

Ø	L	Ø1		
mm	mm	mm		
7	12,5	28	19	3 007100007
8	13,8	28	19	3 007100008
9	15,0	28	19	3 007100009
10	16,3	28	19	3 007100010
11	17,5	30	19	3 007100011
12	19,0	30	19	3 007100012
13	20,0	30	22	3 007100013
14	21,3	30	22	3 007100014
16	23,8	30	22	3 007100016
17	25,0	30	22	3 007100017
18	26,3	30	22	3 007100018
19	27,5	30	22	3 007100019
21	30,0	32	22	3 007100021
22	32,0	32	22	3 007100022

710/C10

10 chiavi a bussola Macchina

CE



710/C10

7-8-10-11-12-13
14-17-19-22 mm

1 007100910

130x55x40 mm - 800 g

710/16

raccordo Macchina con attacco quadro
femmina 3/8" e maschio 1/2"

CE



L	Ø			
mm	mm	3/8	1/2	
32	22			3 007100810

710/20

prolunga Macchina con attacchi quadri
maschio e femmina 3/8"

CE



L	Ø		
mm	mm		
75	22		2 007100821

710/21

prolunga Macchina con attacchi quadri maschio e femmina 3/8"



L	Ø		
mm	mm		
125	22	2	007100823

710/22

prolunga Macchina con attacchi quadri maschio e femmina 3/8"



L	Ø		
mm	mm		
150	22	2	007100825

710/25

snodo Macchina con attacchi quadri maschio e femmina 3/8"



L	Ø		
mm	mm		
58	24	2	007100830

710/OR... - 710/SP...

anelli e spine per bussola e accessori Macchina



	710	710/16		
	mm	L mm		
710/OR1	7+12		10	007100921
710/OR2	13+22	32	10	007100922
710/SP1	7+12		10	007100911
710/SP2	13+22	32	10	007100912

720

chiavi a bussola Macchina serie normale



UNI/ISO 2725 DIN 3129

Ø	Ø	L	Ø1		
mm	mm	mm	mm		
8	15,0	38	25	5	007200008
9	16,0	38	25	5	007200009
10	17,0	38	25	5	007200010
11	18,5	38	25	5	007200011
12	20,0	38	25	5	007200012
13	21,0	38	25	5	007200013
14	22,5	38	25	5	007200014
15	23,0	38	30	5	007200015
16	25,0	38	30	5	007200016
17	26,0	38	30	5	007200017
18	27,5	38	30	5	007200018
19	28,5	38	30	5	007200019
20	30	38	30	5	007200020
21	31,0	38	30	5	007200021
22	32,5	38	30	5	007200022
23	34,0	38	30	5	007200023
24	35,0	38	30	5	007200024
27	38,5	45	30	3	007200027
29	41	47	30	3	007200029
30	42,0	50	30	3	007200030
32	44,0	50	30	3	007200032
36	50,0	50	30	3	007200036

720/C6

6 chiavi a bussola Macchina



720/C6	13-14-17-19-22-24 mm	1	007200910

195x80x55 mm - 1100 g

720/C12

12 chiavi a bussola Macchina



720/C12	10-11-12-13-14-17-19-22-24-27-30-32 mm	1	007200912

195x80x55 mm - 2000 g

720/C24

24 chiavi a bussola Macchina



720/C24		1	007200904

	720	10 - 12 - 13 - 14 - 15 - 16 - 17 - 18 - 19 - 21 - 22 - 24 - 27 - 30 - 32 mm
	720L	13 - 17 - 19 - 21 - 22 - 24 mm
	720LC	17 - 19 - 21 mm

420x185x60 mm - 6,2 kg

720MC

chiavi a bussola Macchina serie normale colorate



Ø	Ø	L		
mm	mm	mm		
10	17,0	38		3 007202010
11	18,5	38		3 007202011
12	20,0	38		3 007202012
13	21,0	38		3 007202013
14	22,5	38		3 007202014
15	23,0	38		3 007202015
16	25,0	38		3 007202016
17	26,0	38		3 007202017
18	27,5	38		3 007202018
19	28,5	38		3 007202019
21	31,0	38		2 007202021
22	32,5	38		2 007202022
24	35,0	38		2 007202024

720MC/C13

13 chiavi a bussola Macchina colorate



720MC/C13	10-11-12-13-14-15-16-17-18-19-21-22-24 mm	1	007202913

335x145x60 mm - 2,4 kg



720B

chiavi a bussola Macchina
bocca poligonale



UNI/ISO 2725 DIN 3129

mm	Ø	L	Ø1	
10	17	38	25	5 007201010
11	18	38	25	5 007201011
12	19	38	25	5 007201012
13	20	38	25	5 007201013
14	22	38	25	5 007201014
15	23	38	30	5 007201015
16	24	38	30	5 007201016
17	26	38	30	5 007201017
18	27	38	30	5 007201018
19	28	38	30	5 007201019
21	30	38	30	5 007201021
22	31,8	38	30	5 007201022
23	31,8	38	30	5 007201023
24	33,8	40	30	5 007201024
27	37,8	43	30	3 007201027
30	41,8	43	30	3 007201030
32	43,8	43	30	3 007201032
36	49,8	50	30	3 007201036

720AS

chiavi a bussola Macchina
serie normale



mm	Ø	L	Ø1	
3/8	17,0	38	25	2 007200210
7/16	18,2	38	25	2 007200211
1/2	20,7	38	25	2 007200213
9/16	22,0	38	25	2 007200214
5/8	24,5	38	30	2 007200216
11/16	25,7	38	30	2 007200217
3/4	28,2	38	30	2 007200219
13/16	30,7	38	30	2 007200221
7/8	32,0	38	30	2 007200222
15/16	34,5	38	30	2 007200224
1	35,7	38	30	2 007200225
1.1/16	38,2	40	30	1 007200227
1.1/8	40,7	42	30	1 007200229
1.1/4	44,5	42	30	1 007200232

720S

chiavi a bussola Macchina
serie compatta



mm	Ø	L	Ø1	
13	20,0	28,0	23,8	3 007200113
15	23,0	28,0	23,8	3 007200115
17	25,8	28,0	25,8	3 007200117
19	27,8	28,0	27,8	3 007200119
22	31,8	28,0	30,0	3 007200122
24	33,8	28,0	30,0	3 007200124



720S/SB6
13-15-17-19-22-24 mm
1 007200906

720L

chiavi a bussola Macchina
serie lunga



UNI/ISO 2725

mm	Ø	L	Ø1	
10	17,0	80	25	2 007200310
11	18,5	80	25	2 007200311
12	20,0	80	25	2 007200312
13	21,0	80	25	2 007200313
14	22,5	80	25	2 007200314
15	23,0	80	30	2 007200315
16	25,0	80	30	2 007200316
17	26,0	80	30	2 007200317
18	27,5	80	30	2 007200318
19	28,5	80	30	2 007200319
21	31,0	80	30	2 007200321
22	32,5	80	30	2 007200322
24	35,0	80	30	2 007200324
27	38,5	80	30	2 007200327
30	42,0	80	30	2 007200330
32	44,0	80	30	2 007200332
36	50,0	80	30	2 007200336

720L/S3

serie di 3 chiavi a bussola 720L



17-19-21
1 007200355

720LS

chiavi a bussola Macchina
serie lunga sottile



mm	Ø	L	Ø1	
10	15,5	78	24	2 007200360
11	16,7	78	24	2 007200361
12	18,0	78	24	2 007200362
13	19,2	78	24	2 007200363
14	20,5	78	24	2 007200364
15	21,7	78	24	2 007200365
16	23,0	78	24	2 007200366
17	24,2	78	29	2 007200367
18	25,5	78	29	2 007200368
19	26,7	78	29	2 007200369
21	29,2	78	29	2 007200371
22	30,5	78	29	2 007200372
24	33,0	78	29	2 007200374
27	36,7	78	29	2 007200377
30	40,5	78	29	2 007200380
32	43,0	78	29	2 007200382
36	48,0	78	29	2 007200386

720LC

chiavi a bussola Macchina per dadi ruote
con inserti polimerici colorati



mm	Ø		
17	26,5		2 007200637
19	28,5		2 007200639
21	30,3		2 007200641
22	32,4		2 007200642
24	34,6		2 007200644



720LC/C3
17-19-21 mm
1 007200653
148x132x44 mm - 860 g



720LC/S5
17-19-21-22-24 mm
1 007200645



720LC/PM5
17-19-21-22-24 mm
1 007200646

PM 1/2-Q5

guida magnetica portabussolle



PM 1/2-Q5
1 088880233

720IC

inserti di ricambio polimerici colorati per chiavi a bussola 720LC-720LCL



	mm			
720IC 17	17		1	007200687
720IC 19	19		1	007200689
720IC 21	21		1	007200691
720IC 22	22		1	007200692
720IC 24	24		1	007200694



720LCL

chiavi a bussola Macchina per dadi ruote con inserti polimerici colorati serie lunga



mm	Ø mm			
17	26,5		1	007200737
19	28,5		1	007200739
21	30,3		1	007200741



720LCL/C3				
17-19-21 mm		1	007200753	
210x50x150 mm - 1,65 kg				

720MRC

chiave a bussola Macchina con inserto polimerico per vite ruota con profilo Mercedes



mm	Ø mm	L mm		
17	27	85	1/2	1 007200631

720FRD

chiave a bussola per dadi ruota Ford con rivestimento in alluminio danneggiato

indispensabile quando le creste del dado risultano danneggiate dall'avvitatore ad impulsi



mm	L mm			
18,5+19,5	63	1	007200633	

720TC

barre di torsione Macchina colorate per dadi ruote autoveicoli con attacchi quadri maschio e femmina 1/2"

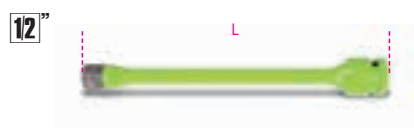

Nm	L mm			
90	200		1	007200769
100	200		1	007200770
110	200		1	007200771
120	200		1	007200772
135	200		1	007200773



720TC/S5				
90-100-110-120-135 Nm		1	007200779	
260x50x175 mm - 1,35 kg				

720FTX

chiavi a bussola Macchina per viti con testa a profilo Torx®



	Ø mm	L mm	Ø1 mm		
E10	14,0	38	25	2	007200410
E12	15,9	38	25	2	007200412
E14	17,7	38	25	2	007200414
E16	20,0	38	25	2	007200416
E18	22,0	38	25	2	007200418
E20	25,0	40	25	2	007200420
E24	30,0	40	30	2	007200424



720FTX/SB6				
E10-E12-E14 E16-E18-E20		1	007200450	

720TX

chiavi a bussola maschio Macchina per viti con impronta Torx®



	Ø mm	L mm	L1 mm		
T30	25	78	54	3	007200460
T40	25	78	54	3	007200470
T45	25	78	54	3	007200472
T50	25	78	54	3	007200474
T55	25	78	54	3	007200476
T60	25	78	54	3	007200478

720TX/C6

6 chiavi a bussola maschio Macchina per viti con impronta Torx®



720TX/C6				
T30-T40-T45 T50-T55-T60		1	007200483	
275x120x65 mm - 5700 g				

720ME

chiavi a bussola Macchina maschio esagonale



mm	Ø mm	L mm	L1 mm		
5	25	78	54	3	007200505
6	25	78	54	3	007200506
8	25	78	54	3	007200508
10	25	78	54	3	007200510
12	25	78	54	3	007200512
14	25	78	54	3	007200514
17	25	78	54	3	007200517
19	25	78	54	3	007200519

720ME/C8

8 chiavi a bussola Macchina maschio esagonale



720ME/C8				
5-6-8-10-12 14-17-19 mm		1	007200525	
270x120x45 mm - 1710 g				

9899 720ME/C8		1	098990130	
termoformato vuoto				

720XZN

chiavi a bussola maschio Macchina per viti con impronta XZN®



Ø	Ø mm	L mm	L1 mm		
M4	25	77	53	3	007201504
M5	25	77	53	3	007201505
M6	25	77	53	3	007201506
M8	25	77	53	3	007201508
M10	25	77	53	3	007201510
M12	25	77	53	3	007201512
M14	25	77	53	3	007201514
M16	25	77	53	3	007201516
M18	25	77	53	3	007201518

720/15

raccordo Macchina con attacco quadro femmina 1/2" e maschio 3/8"



L mm	Ø mm	□	■		
37,5	25	1/2	3/8	3	007200810



E' assolutamente necessario commisurare la coppia di serraggio alla capacità del quadro maschio per evitare rotture o danni accidentali

720/16

raccordo Macchina con attacco quadro femmina 1/2" e maschio 3/4"

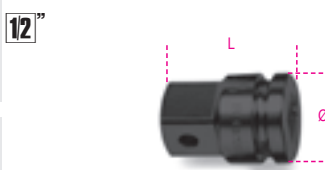

L mm	Ø mm	□	■		
44	30	1/2	3/4	3	007200814

720/20

prolunga Macchina con attacchi quadri maschio e femmina 1/2"



L mm	Ø mm				
75	25			3	007200818

720/21

prolunga Macchina con attacchi quadri maschio e femmina 1/2"



L mm	Ø mm				
125	25			3	007200822

720/22

prolunga Macchina con attacchi quadri maschio e femmina 1/2"

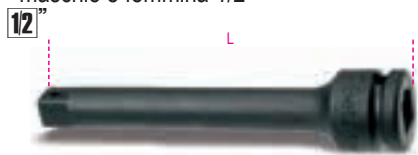

L mm	Ø mm				
250	25			3	007200824

720/25

snodo Macchina con attacchi quadri maschio e femmina 1/2"



L mm	Ø mm				
64	28			2	007200831

720/OR... - 720/SP...

anelli e spine per bussole e accessori Macchina



	720	720TX		
	mm	mm		
720/OR1	10+14	T30+T60	10	007200923
720/OR2	15+36		10	007200924
720/SP1	10+14	T30+T60	10	007200913
720/SP2	15+36		10	007200914

727PI/16 1/2

bussola portainseri Macchina per 727/ES16 e 727/ES16TX

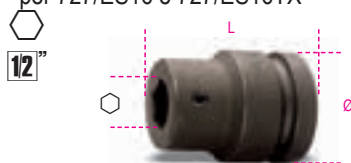

Ø mm	L mm	□ mm	□		
28	42	16	1/2	2	007270015

727PI/16

bussola portainseri Macchina per 727/ES16 e 727/ES16TX



Ø mm	L mm	□ mm	□		
44	52	16	3/4	2	007270016

727/ES16

inserti Macchina maschio esagonale attacco 16 mm



mm	● mm	L mm		
10	16	40	2	007270110
12	16	40	2	007270112
13	16	40	2	007270113
14	16	40	2	007270114
16	16	40	2	007270116
17	16	40	2	007270117
18	16	40	2	007270118
19	16	40	2	007270119
22	16	40	2	007270122

727/ES16TX

inserti Macchina maschio per viti con impronta Torx®, attacco 16 mm



□	● mm	L mm		
T55	16	50	2	007270355
T60	16	50	2	007270360
T70	16	50	2	007270370



727PI/22

bussola portainseri Macchina
per 727/ES22 e 727/ES22TX



Ø	L	Ø	
mm	mm	mm	
54	70	22	2 007270022

727/ES22

inserti Macchina maschio esagonale,
attacco 22 mm



mm	Ø	L	
mm	mm	mm	
19	22	50	2 007270219
22	22	50	2 007270222
24	22	50	2 007270224
27	22	50	2 007270227
30	22	50	2 007270230
32	22	50	2 007270232

727/ES22TX

inserti Macchina maschio per viti
con impronta Torx®, attacco 22 mm



Ø	mm	L	
mm	mm	mm	
T80	22	60	2 007270480
T90	22	60	2 007270490
T100	22	60	2 007270500

727/C16

12 inserti Macchina maschio
e 4 accessori



727/C16	1 007270900
---------	-------------

727PI/16	
727/ES16	14-17-19 mm
727/ES16TX	T55-T60-T70
727PI/22	
727/ES22	22-24-27 mm
727/ES22TX	T80-T90-T100
96BPC	3-4 mm

335x145x60 mm - 3,6 kg

727PI/32

bussola portainseri Macchina
per 727/ES32

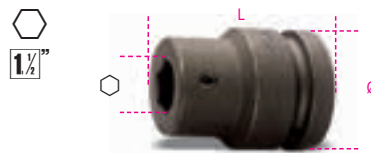

Ø	L	Ø	
mm	mm	mm	
86	66	32	1 007270032

727/ES32

inserti Macchina maschio esagonale
attacco 32 mm



mm	Ø	L	
mm	mm	mm	
19	32	44	2 007270519
22	32	44	2 007270522
24	32	44	2 007270524
27	32	44	2 007270527
30	32	44	2 007270530
32	32	44	2 007270532
36	32	44	2 007270536

728

chiavi a bussola Macchina
serie normale



UNI/ISO 2725 DIN 3129

Ø	Ø	L	Ø1	
mm	mm	mm	mm	
17	30,0	51	44	2 007280017
18	31,0	51	44	2 007280018
19	32,5	51	44	2 007280019
21	35,0	51	44	2 007280021
22	36,0	51	44	2 007280022
23	37,5	51	44	2 007280023
24	38,5	51	44	2 007280024
27	42,5	53	44	2 007280027
28	44,0	53	44	2 007280028
30	46,0	53	44	2 007280030
32	48,5	57	44	2 007280032
33	50,0	57	44	2 007280033
34	51,0	57	44	2 007280034
35	52,5	57	44	2 007280035
36	53,5	57	44	2 007280036
38	56,0	57	44	1 007280038
40	58,5	58	44	1 007280040
41	60,0	58	44	1 007280041
44	64,0	62	44	1 007280044
45	65,0	62	44	1 007280045
46	66,0	62	44	1 007280046
50	71,0	68	54	1 007280050
55	77,5	71	54	1 007280055
60	83,0	73	54	1 007280060
65	88,0	78	54	1 007280065

728/C10

10 chiavi a bussola Macchina



728/C10	1 007280910
---------	-------------

17-19-22-24-27-30
32-36-41-46 mm

275x120x65 mm - 5,7 kg

728B

chiavi a bussola Macchina
bocca poligonale



UNI/ISO 2725 DIN 3129

Ø	Ø	L	Ø1	
mm	mm	mm	mm	
17	28,5	50	38	2 007280117
19	30	52	38	2 007280119
21	32	52	38	2 007280121
22	34	52	38	2 007280122
23	35	52	38	2 007280123
24	36	52	38	2 007280124
27	40	52	40	2 007280127
29	42	52	42	2 007280129
30	44	52	44	2 007280130
32	48	52	44	2 007280132
33	50	56	44	2 007280133
34	51	56	44	2 007280134
35	52	56	44	2 007280135
36	53,5	56	44	2 007280136
38	56	56	44	1 007280138
41	60	58	44	1 007280141
46	67	63	44	1 007280146

728AS

chiavi a bussola Macchina
serie normale



Ø	Ø	L	Ø1	
mm	mm	mm	mm	
3/4	32,0	51	41	1 007280219
13/16	35,0	51	41	1 007280221
7/8	36,0	51	41	1 007280222
15/16	38,5	51	41	1 007280224
1	40,0	53	41	1 007280225
1.1/16	42,5	53	44	1 007280227
1.1/8	44,0	53	44	1 007280230
1.1/4	48,5	57	44	1 007280232
1.5/16	50,0	57	44	1 007280233
1.7/16	53,5	57	44	1 007280236
1.1/2	56,0	57	44	1 007280238
1.5/8	60,0	58	44	1 007280241



728FTX

chiavi a bussola Macchina
per viti con testa a profilo Torx®

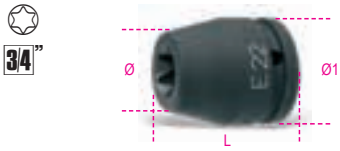

	Ø mm	L mm	Ø1 mm		
E20	28,5	50	44	2	007280420
E22	30,0	50	44	2	007280422
E24	32,5	50	44	2	007280424

728ME

chiavi a bussola Macchina
maschio esagonale



mm	Ø mm	L mm	L1 mm		
12	44	100	67	3	007280712
14	44	100	67	3	007280714
17	44	100	67	3	007280717
19	44	100	67	3	007280719
22	44	100	67	3	007280722
24	44	100	67	3	007280724

728L

chiavi a bussola Macchina
serie lunga



mm	Ø mm	L mm	Ø1 mm		
17	30	90	44	2	007280317
19	32,5	90	44	2	007280319
21	35,0	90	44	2	007280321
22	36,0	90	44	2	007280322
24	38,5	90	44	2	007280324
26	41,0	90	44	2	007280326
27	42,5	90	44	2	007280327
30	46,0	90	44	2	007280330
32	48,5	90	44	2	007280332
33	50,0	90	44	1	007280333
34	51,0	90	44	1	007280334
36	53,5	90	44	1	007280336
38	56,0	90	44	1	007280338
41	60,0	90	44	1	007280341
44	64,0	90	44	1	007280344
46	66,0	90	44	1	007280346
50	71,0	90	44	1	007280350
55	77,5	100	54	1	007280355



728L/S3				1	007280393
30-32-36 mm					

728LS

chiavi a bussola Macchina
serie lunga sottile



mm	Ø mm	L mm	Ø1 mm		
17	28,0	100	43	2	007280517
19	30,5	100	43	2	007280519
22	34,3	100	43	2	007280522
24	36,8	100	43	2	007280524
27	40,5	100	43	2	007280527
30	44,3	100	43	2	007280530
32	46,8	100	43	2	007280532
33	48,0	100	43	2	007280533
36	51,8	100	43	1	007280536

728LQ

chiavi a bussola Macchina
serie lunga
(per dadi ruote ISUZU)



mm	L mm	Ø mm	Ø1 mm		
19	90	35	43,5	1	007280619
21	90	42	43,5	1	007280621

728/15

raccordo Macchina con attacco quadro
femmina 3/4" e maschio 1/2"



L mm	Ø mm	□	■		
58	38	3/4	1/2	2	007280810



E' assolutamente necessario commisurare la coppia di serraggio alla capacità del quadro maschio per evitare rotture o danni accidentali

728/16

raccordo Macchina con attacco quadro
femmina 3/4" e maschio 1"



L mm	Ø mm	□	■		
62	44	3/4	1	2	007280813

728/21

prolunga Macchina con attacchi quadri
maschio e femmina 3/4"



L mm	Ø mm				
175	44			2	007280815

728/22

prolunga Macchina con attacchi quadri
maschio e femmina 3/4"



L mm	Ø mm				
250	44			2	007280825

728/22L

prolunga Macchina con attacchi quadri
maschio e femmina 3/4"



L mm	Ø mm				
330	44			1	007280826

728/25

snodo Macchina con attacchi quadri
maschio e femmina 3/4"



L mm	Ø mm				
107,5	44			1	007280830

728/OR - 728/SP

anelli e spine per bussole e accessori
Macchina



	728 mm	728FTX mm			
728/OR	728/15		5		007280925
728/OR	17+46	E20+E24	10		007280926
728/SP	17+46	E20+E24	10		007280916

729

chiavi a bussola Macchina
serie normale



UNI/ISO 2725 DIN 3129

mm	Ø mm	L mm	Ø1 mm		
24	41,5	58	54	1	007290024
27	45,0	60	54	1	007290027
30	49,0	62	54	1	007290030
32	51,5	63	54	1	007290032
33	52,5	63	54	1	007290033
34	54,0	63	54	1	007290034
36	56,5	66	54	1	007290036
38	59,0	66	54	1	007290038
41	62,5	68	54	1	007290041
46	69,0	72	54	1	007290046
50	74,0	76	54	1	007290050
55	80,0	84	54	1	007290055
60	86,5	88	54	1	007290060
65	92,5	92	54	1	007290065
70	99,0	96	54	1	007290070
75	105,0	102	63	1	007290075
80	111,5	102	63	1	007290080

729L

chiavi a bussola Macchina serie lunga



Ø mm	Ø mm	L mm	Ø1 mm		
24	41,5	108	54	1	007290324
27	45,0	108	54	1	007290327
30	49,0	108	54	1	007290330
32	51,5	108	54	1	007290332
33	52,2	108	54	1	007290333
34	54,0	108	54	1	007290334
36	56,5	108	54	1	007290336
41	62,5	108	54	1	007290341
46	69,0	108	54	1	007290346
50	74,0	108	54	1	007290350
55	80,0	108	54	1	007290355
60	86,5	108	54	1	007290360
65	92,5	108	54	1	007290365
70	99,0	108	54	1	007290370
75	105,0	108	63	1	007290375
80	111,5	108	63	1	007290380

729LS

chiavi a bussola Macchina serie lunga sottile



Ø mm	Ø mm	L mm	Ø1 mm		
22	36,0	108	53	1	007290522
24	38,5	108	53	1	007290524
27	46,0	108	53	1	007290527
30	50,0	108	53	1	007290530
32	50,0	108	53	1	007290532
33	52,0	108	53	1	007290533
36	56,0	108	53	1	007290536

729T

barre di torsione Macchina per dadi ruote



Ø mm	Nm	L mm		
24	350	300	1	007290724
27	450	300	1	007290757
30	500	300	1	007290730
32	450	300	1	007290732
32	600	300	1	007290762
33	600	300	1	007290763
36	600	300	1	007290736

729/15

raccordo Macchina con attacco quadro femmina 1" e maschio 3/4"



L mm	Ø mm	□	■		
66,5	54	1	3/4	1	007290810



E' assolutamente necessario commisurare la coppia di serraggio alla capacità del quadro maschio per evitare rotture o danni accidentali

729/16

raccordo Macchina con attacco quadro femmina 1" e maschio 1.1/2"



L mm	Ø mm	□	■		
88	54,0	1	1.1/2	1	007290813

729/21

prolunga Macchina con attacchi quadri maschio e femmina 1"



L mm	Ø mm				
175	54	1		1	007290815

729/21L

prolunga Macchina con attacchi quadri maschio e femmina 1"



L mm	Ø mm				
250	54	1		1	007290826

729/22

prolunga Macchina con attacchi quadri maschio e femmina 1"

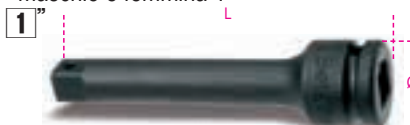

L mm	Ø mm				
330	54	1		1	007290825

729/25

snodo Macchina con attacchi quadri maschio e femmina 1"



L mm	Ø mm				
130	54	1		1	007290830

729/OR... - 729/SP...

anelli e spine per bussole e accessori Macchina

3/4"

1"

1 1/2"



	728 mm	729-730 mm		
729/OR1	50+60	24+70	5	007290927
729/OR2	75+125		5	007290928
729/SP1	50+60	24+70	5	007290917
729/SP2	75+125		5	007290918

730

chiavi a bussola Macchina serie normale



UNI/ISO 2725 DIN 3129

Ø mm	Ø mm	L mm	Ø1 mm		
50	81	87	84	1	007300050
55	88	90	86	1	007300055
60	94	95	86	1	007300060
65	100	100	86	1	007300065
70	106	105	86	1	007300070
75	113	110	86	1	007300075
80	119	115	86	1	007300080
85	125	120	86	1	007300085
90	132	125	86	1	007300090
95	138	125	96	1	007300095
100	144	130	96	1	007300100
105	150	135	96	1	007300105
110	157	140	96	1	007300110
115	163	140	96	1	007300115
120	169	145	96	1	007300120
125	175	145	96	1	007300125

730L

chiavi a bussola Macchina serie lunga



Ø mm	Ø mm	L mm	Ø1 mm		
50	81	135	86	1	007300350
55	87	140	86	1	007300355
60	93	150	86	1	007300360
65	97	150	86	1	007300365
70	105	160	86	1	007300370
75	110	170	86	1	007300375
80	116	170	86	1	007300380
85	125	170	86	1	007300385
90	130	170	86	1	007300390
95	137	180	95	1	007300395
100	144	190	95	1	007300400
105	150	190	95	1	007300405
110	156	200	95	1	007300410
115	160	200	95	1	007300415
120	168	210	95	1	007300420

730/15

raccordo Macchina riduttore



E' assolutamente necessario commisurare la coppia di serraggio alla capacità del quadro maschio per evitare rotture o danni accidentali

730/21

prolunga Macchina con attacchi quadri maschio e femmina 1.1/2"



730/25

snodo Macchina con attacchi quadri maschio e femmina 1.1/2"



733/15

raccordo Macchina riduttore

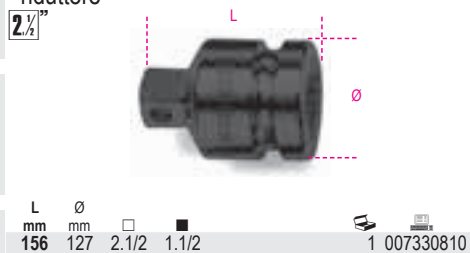

INSERTI PER AVVITATORI

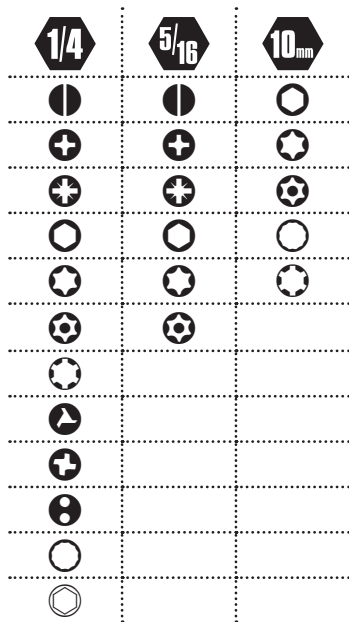

ISO 1173-C 6,3



sede per molla di tenuta

ISO 1173-E 6,3



cava per sfera di tenuta

851

portainserti magnetico con impugnatura



L1 mm	L mm	
45	165	2 008510165
125	245	2 008510245

851SR

portainserti a sgancio rapido con impugnatura



L mm	L1 mm	
230	110	2 008510001

852

portainserti a T snodato

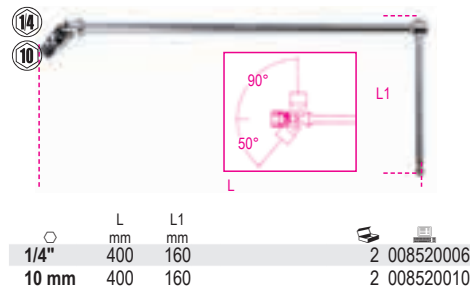

Ø mm	L mm	L1 mm	
1/4"	400	160	2 008520006
10 mm	400	160	2 008520010

855P

Giravite portainserti a cricchetto reversibile con impugnatura snodata 7 inserti integrati

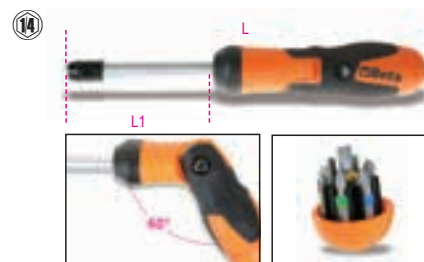

L mm	L1 mm	
240	100	1 008550010

➕ 860PH	PH1 - PH2
➕ 860PZ	PZ1 - PZ2
● 860LP	LP 0,8x5,5 mm
○ 860PE	4 - 5 mm

860LP

inserti colorati per avvitatori per viti a testa con intaglio



ISO 2351-1
ISO 1173 C 6,3

SxA mm	L mm	
0,5x3	25	5 008600005
0,6x4,5	25	5 008600010
0,8x5,5	25	5 008600015
1x5,5	25	5 008600020
1,2x6,5	25	5 008600025

860PH

inserti colorati per avvitatori per viti con impronta a croce Phillips®



ISO 2351-2
ISO 1173 C 6,3

PH	L mm	
0	25	5 008600220
1	25	5 008600225
2	25	5 008600230
3	25	5 008600245
4	25	5 008600250



860PZ

inserti colorati per avvitatori
per viti con impronta a croce
Pozi driv® - Supadriv®



ISO 2351-2
ISO 1173 C 6,3

PZ	L mm	n.	008600320
1	25	5	008600320
2	25	5	008600325
3	25	5	008600330
4	25	5	008600335

860PE

inserti colorati maschio esagonale
per avvitatori



ISO 2351-3
ISO 1173 C 6,3

mm	L mm	n.	008600101
2	25	5	008600101
2,5	25	5	008600102
3	25	5	008600103
4	25	5	008600104
5	25	5	008600105
6	25	5	008600106
8	25	5	008600108
10	25	5	008600110

860TX

inserti colorati per avvitatori
per viti con impronta Torx®



ISO 1173 C 6,3

T	L mm	n.	008600704
T6	25	5	008600704
T7	25	5	008600705
T8	25	5	008600710
T9	25	5	008600715
T10	25	5	008600720
T15	25	5	008600725
T20	25	5	008600730
T25	25	5	008600735
T27	25	5	008600740
T30	25	5	008600745
T40	25	5	008600750

860RTX

inserti colorati per avvitatori
per viti con impronta Tamper Resistant Torx®



ISO 1173 C 6,3

T	L mm	n.	008600550
T9	25	5	008600550
T10	25	5	008600555
T15	25	5	008600560
T20	25	5	008600565
T25	25	5	008600570
T27	25	5	008600575
T30	25	5	008600580
T40	25	5	008600585

860/55

cricchetto reversibile portainseri



L mm 100
Ø mm 1/4
n. 3 008600870

860/58

cricchetto portainseri con impugnatura rotante

- L'inserto si può inserire su entrambi i lati per avvitare o svitare
- Impugnatura bimeriale

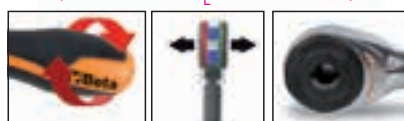

L mm 126
Ø mm 1/4
A mm 27
n. 1 008600884

860/C27

25 inserti per avvitatori, 1 raccordo
e 1 cricchetto reversibile in astuccio tascabile



860/C27 n. 1 008600880

860/55	100 mm
860LP	0,5x3-1,0x5,5-1,2x6,5 mm
860PH	PH1-PH2(x2)-PH3
860PZ	PZ1-PZ2(x2)-PZ3
860PE	2-2,5-3-4-5-6 mm
860TX	T6-T8-T10-T15-T20-T25-T30-T40
892/0	● 1/4 ■ 1/4

860PHZ/A10

10 inserti con portainseri magnetico in
astuccio tascabile



860PHZ/A10 n. 1 008600910

860PH	PH1 PH2 PH3	n. 1 3 1
860PZ	PZ1 PZ2 PZ3	1 3 1
882M1	○ 1/4 ● 1/4	1

860PE/A10

10 inserti con portainseri magnetico in
astuccio tascabile



860PE/A10 n. 1 008600920

860PE	2-2,5 mm	n. 1
882M1	3-4-5-6 mm ○ 1/4 ● 1/4	2

860TX/A10

10 inserti con portainseri magnetico in
astuccio tascabile



860TX/A10 n. 1 008600970

860TX	T7 - T8 - T9 - T10 - T15 - T20 T25 - T27 - T30 - T40	n. 1
882M1	○ 1/4 ● 1/4	

860MIX/A10

10 inserti con portainseri magnetico in
astuccio tascabile



860MIX/A10 n. 1 008600900

860LP	0,5x3 - 1x5,5 - 1,2x6,5 mm	n. 1
860PH	PH1 PH2 PH3	1 2 1
860PZ	PZ1 - PZ2 - PZ3	1
882M1	○ 1/4 ● 1/4	1



860MIX/A31

30 inserti con portainseri magnetico a sgancio rapido in astuccio tascabile



860MIX/A31

1 008600902

	860LP	0,5x3 - 0,6x4,5 - 0,8x5,5 1,0x5,5 - 1,2x6,5 mm
	860PE	2 - 2,5 - 3 - 4 - 5 - 6 8 - 10 mm
	860PH	PH0 - PH1 - PH2 - PH3 - PH4
	860PZ	PZ1 - PZ2 - PZ3 - PZ4
	860RTX	T9 - T10 - T15 - T20 T25 - T27 - T30 - T40
	882MSR 50	1/4 ● 1/4

860/C38P

1 portainseri con impugnatura a criccheto reversibile, 27 inserti per avvitatori, 8 bussole esagonali e 2 accessori



860/C38P

1 008600878

	860LP	0,6x4,5-0,8x5,5-1,0x5,5- 1,2x6,5 mm
	860PE	2-2,5-3-4(x2)-5(x2) mm
	860PH	PH1(x2)-PH2(x2)-PH3
	860PZ	PZ1(x2)-PZ2(x2)-PZ3
	860TX	T10-T15-T20-T25-T30-T40
	900	5-5,5-6-7-8-9-10-13 mm
	892/0	● 1/4 ■ 1/4
	892/3	● 1/4 ■ 1/4
	855P	240 mm

270x120x45 mm

861LP

inserti per avvitatori per viti a testa con intaglio



ISO 2351-1

ISO 1173 C 6,3

SxA mm	L mm		
0,5x3	25	10	008610005
0,6x4	25	10	008610007
0,6x4,5	25	10	008610010
0,8x5,5	25	10	008610015
1x5,5	25	10	008610020
1,2x6,5	25	10	008610025
1,2x8	25	10	008610028
1,6x8	25	10	008610030

861PH

inserti per avvitatori per viti con impronta a croce Phillips®



ISO 2351-2

ISO 1173 C 6,3

PH	L mm		
0	25	10	008610200
1	25	10	008610205
2	25	10	008610210
2L	50	10	008610213
3	25	10	008610215
4	25	10	008610220

861PH/C

inserti per avvitatori per viti con impronta a croce Phillips®



ISO 2351-2

ISO 1173 C 6,3

PH	L mm		
0	25	200	008610250
1	25	200	008610255
2	25	200	008610260
2L	50	100	008610263
3	25	200	008610265
4	25	100	008610270

861PZ

inserti per avvitatori per viti con impronta a croce Pozidriv® - Supadriv®



ISO 2351-2

ISO 1173 C 6,3

PZ	L mm		
1	25	10	008610300
2	25	10	008610305
2L	50	10	008610308
3	25	10	008610310
4	25	10	008610315

861PZ/C

inserti per avvitatori per viti con impronta a croce Pozidriv® - Supadriv®



ISO 2351-2

ISO 1173 C 6,3

PZ	L mm		
1	25	200	008610350
2	25	200	008610355
2L	50	100	008610358
3	25	200	008610360
4	25	100	008610365

861PE

inserti maschio esagonale per avvitatori



ISO 2351-3

ISO 1173 C 6,3

mm	L mm		
2	25	10	008610100
2,5	25	10	008610105
3	25	10	008610110
4	25	10	008610115
5	25	10	008610120
6	25	10	008610125
8	25	10	008610130
10	25	10	008610135

861TX

inserti per avvitatori per viti con impronta Torx®



ISO 1173 C 6,3

	L mm		
T5	25	10	008610399
T6	25	10	008610400
T7	25	10	008610405
T8	25	10	008610410
T9	25	10	008610415
T10	25	10	008610420
T15	25	10	008610425
T20	25	10	008610430
T25	25	10	008610435
T27	25	10	008610440
T30	25	10	008610445
T40	25	10	008610450



861TX/C

inserti per avvitatori
per viti con impronta Torx®



1/4

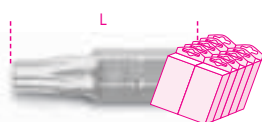

ISO 1173 C 6,3

	L mm		
T10	25	200	008610470
T15	25	200	008610475
T20	25	200	008610480
T25	25	200	008610485
T27	25	200	008610490
T30	25	200	008610495
T40	25	200	008610499

861RTX

inserti per avvitatori per viti
con impronta Tamper Resistant Torx®



1/4



ISO 1173 C 6,3

	L mm		
T6	25	10	008610537
T7	25	10	008610538
T8	25	10	008610540
T9	25	10	008610500
T10	25	10	008610505
T15	25	10	008610510
T20	25	10	008610515
T25	25	10	008610520
T27	25	10	008610525
T30	25	10	008610530
T40	25	10	008610535
T45	25	10	008610539

861RIBE

inserti per avvitatori
per viti con impronta RIBE®



1/4



ISO 1173 C 6,3

	L mm		
M5	25	10	008610705
M6	25	10	008610706
M7	25	10	008610707
M8	25	10	008610708
M9	25	10	008610709

861TRW

inserti per avvitatori
per viti con impronta Tri-Wing®



1/4



ISO 1173 C 6,3

GR	L mm		
1	25	10	008610601
2	25	10	008610602
3	25	10	008610603
4	25	10	008610604
5	25	10	008610605
6	25	10	008610606

861TQS

inserti per avvitatori
per viti con impronta Torq-Set®



1/4



ISO 1173 C 6,3

GR	L mm		
0	25	10	008610620
1	25	10	008610621
2	25	10	008610622
3	25	10	008610623
4	25	10	008610624
5	25	10	008610625
6	25	10	008610626
8	25	10	008610628
10	25	10	008610630

861SP

inserti per avvitatori per viti con impronta
Spanner



1/4



ISO 1173 C 6,3

SP	D mm	L mm		
4	1,5	25	10	008610650
6	2,4	25	10	008610653
8	2,8	25	10	008610656
10	3,3	25	10	008610658
12	3,9	25	10	008610660

1483KV-PT/S7



1/4



1483KV PT/S7

188

861XZN

inserti per avvitatori
per viti con impronta XZN®



1/4



ISO 1173 C 6,3

	L mm		
M5	25	10	008610725
M6	25	10	008610726
M8	25	10	008610728

861/C61P

61 inserti per avvitatori e 1 portainseriti a
sgancio rapido

1/4



861/C61P

1 008610978

	● 861LP	0,5x3 - 0,6x4,5 - 0,8x5,5 - 1,0x5,5 1,2x6,5 - 1,2x8 - 1,6x8 mm
	○ 861PE	2 - 2,5 - 3 - 4 - 5 - 6 - 8 - 10 mm
	⊕ 861PH	PH0 - PH1 - PH2 - PH3
	⊕ 861PZ	PZ1 - PZ2 - PZ3
	⊕ 861TX	T6 - T7 - T8 - T9 - T10 - T15 T20 - T25 - T27 - T30 - T40
	⊕ 861RTX	T9 - T10 - T15 - T20 - T25 T27 - T30 - T40
	⊕ 861TRW	1 - 2 - 3 - 4 - 5 - 6
	⊕ 861TQS	0 - 1 - 2 - 3 - 4 - 5 - 6 - 8 - 10
	⊕ 861SP	4 - 6 - 8 - 10 - 12
	○ 851SR	1/4"

270x120x45 mm - 975 g

862LP

inserti per avvitatori
per viti a testa con intaglio



1/4



ISO 2351-1

ISO 1173 E 6,3

SxA mm	L mm		
0,5x3	50	5	008620005
0,6x4,5	50	5	008620010
0,8x5,5	50	5	008620015
1x5,5	50	5	008620020
1,2x6,5	50	5	008620025
1,2x8	50	5	008620030
1,6x8	50	5	008620035

862PH

inserti per avvitatori
per viti con impronta a croce Phillips®



1/4



ISO 2351-2

ISO 1173 E 6,3

PH	L mm		
1	50	5	008620200
2	50	5	008620205
3	50	5	008620210



862PH/L

inserti per avvitatori per viti con impronta a croce Phillips®



ISO 2351-2

ISO 1173 E 6,3

PH	L mm	
1	70	5 008620230
2	70	5 008620232
3	70	5 008620234

862PH-XL

inserti per avvitatori per viti con impronta a croce Phillips®



ISO 2351-2/ISO 1173 E 6,3

PH	L mm	
1	100	5 008620250
2	100	5 008620252
3	100	5 008620254

862PZ

inserti per avvitatori per viti con impronta a croce Pozidriv® - Supadriv®



ISO 2351-2

ISO 1173 E 6,3

PZ	L mm	
1	50	5 008620300
2	50	5 008620305
3	50	5 008620310

862PE

inserti maschio esagonale per avvitatori

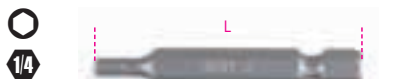

ISO 2351-3

ISO 1173 E 6,3

mm	L mm	
3	50	5 008620103
4	50	5 008620104
5	50	5 008620105
6	50	5 008620106
8	50	5 008620108

862TX

inserti per avvitatori per viti con impronta Torx®



ISO 1173 E 6,3

	L mm	
T6	50	5 008620506
T7	50	5 008620507
T8	50	5 008620508
T9	50	5 008620509
T10	50	5 008620510
T15	50	5 008620515
T20	50	5 008620520
T25	50	5 008620525
T27	50	5 008620527
T30	50	5 008620530
T40	50	5 008620540

862TX/L

inserti per avvitatori per viti con impronta Torx®



ISO 1173 E 6,3

	L mm	
T6	70	5 008620556
T7	70	5 008620557
T8	70	5 008620558
T9	70	5 008620559
T10	70	5 008620560
T15	70	5 008620565
T20	70	5 008620570
T25	70	5 008620575
T27	70	5 008620577
T30	70	5 008620580
T40	70	5 008620590

862TX-XL

inserti per avvitatori per viti con impronta Torx®



ISO 1173 E 6,3

	L mm	
T9	100	5 008620659
T10	100	5 008620660
T15	100	5 008620665
T20	100	5 008620670
T25	100	5 008620675
T27	100	5 008620677
T30	100	5 008620680
T40	100	5 008620690

862F

inserti per avvitatori chiavi a bussola esagonale magnetici



ISO 1173 E 6,3

mm	L mm	Ø mm	
5,5	65	11	5 008620405
6	65	11	5 008620406
7	65	11	5 008620407
8	65	13	5 008620408
10	65	15	5 008620410
12	65	18	5 008620412
13	65	18	5 008620413

862F/A7

7 inserti per avvitatori chiavi a bussola esagonale magnetici, in astuccio tascabile



862F/A7

1 008620950

862F 5,5-6-7-8-10-12-13 mm

866LP

inserti per avvitatori per viti a testa con intaglio



ISO 2351-1
ISO 1173 C 8

SxA mm	L mm	
1x5,5	41	10 008660005
1,2x6,5	41	10 008660010
1,6x8	41	10 008660015
1,6x10	41	10 008660020
2x12	41	10 008660025

866PH

inserti per avvitatori per viti con impronta a croce Phillips®



ISO 2351-2

ISO 1173 C 8

PH	L mm	
1	32	10 008660200
2	32	10 008660205
3	32	10 008660210
4	38	10 008660215

866PZ

inserti per avvitatori per viti con impronta a croce Pozidriv® - Supadriv®



ISO 2351-2

ISO 1173 C 8

PZ	L mm	
1	32	10 008660300
2	32	10 008660305
3	32	10 008660310
4	38	10 008660315

866PE

inserti maschio esagonale
per avvitatori



ISO 2351-3

ISO 1173 C 8

mm	L mm		
3	30	10	008660100
4	30	10	008660105
5	30	10	008660110
6	30	10	008660115
7	30	10	008660117
8	30	10	008660120
10	30	10	008660125
12	30	10	008660132
14	30	10	008660134

866TX

inserti per avvitatori
per viti con impronta Torx®



ISO 1173 C 8

	L mm		
T20	30	10	008660400
T25	30	10	008660405
T27	30	10	008660410
T30	30	10	008660415
T40	30	10	008660420
T45	30	10	008660425
T50	30	10	008660430
T55	30	10	008660435
T60	30	10	008660440
T70	30	10	008660445

866RTX

inserti per avvitatori
per viti con impronta
Tamper Resistant Torx®



ISO 1173 C 8

	L mm		
T40	30	10	008660520
T45	30	10	008660525
T50	30	10	008660530
T55	30	10	008660535
T60	30	10	008660540
T70	30	10	008660545

867PE

inserti maschio esagonale



mm	L mm		
4	30	5	008670104
5	30	5	008670105
6	30	5	008670106
7	30	5	008670107
8	30	5	008670108
10	30	5	008670110
12	30	5	008670112

867PE/L

inserti maschio esagonale



mm	L mm		
4	75	5	008670154
5	75	5	008670155
6	75	5	008670156
7	75	5	008670157
8	75	5	008670158
10	75	5	008670160
12	75	5	008670162

867XZN

inserti a profilo XZN®



	L mm		
M4	30	5	008670204
M5	30	5	008670205
M6	30	5	008670206
M8	30	5	008670208
M10	30	5	008670210
M12	30	5	008670212

867XZN/L

inserti a profilo XZN®



	L mm		
M5	75	5	008670255
M6	75	5	008670256
M8	75	5	008670258
M10	75	5	008670260
M12	75	5	008670262

867TX

inserti per viti con impronta Torx®



	L mm		
T20	30	5	008670400
T25	30	5	008670405
T30	30	5	008670410
T40	30	5	008670415
T45	30	5	008670420
T50	30	5	008670425
T55	30	5	008670430

867TX/L

inserti per viti con impronta Torx®



	L mm		
T20	75	5	008670450
T25	75	5	008670455
T30	75	5	008670460
T40	75	5	008670465
T45	75	5	008670470
T50	75	5	008670475
T55	75	5	008670480

867RTX

inserti per viti con impronta
Tamper Resistant Torx®



	L mm		
T20	30	5	008670500
T25	30	5	008670505
T30	30	5	008670510
T40	30	5	008670515
T45	30	5	008670520
T50	30	5	008670525
T55	30	5	008670530

867RTX/L

inserti per viti con impronta
Tamper Resistant Torx®



	L mm		
T20	75	5	008670550
T25	75	5	008670555
T30	75	5	008670560
T40	75	5	008670565
T45	75	5	008670570
T50	75	5	008670575
T55	75	5	008670580

867RIBE

inserti per avvitatori
per viti con impronta RIBE®



	L mm		
M5	30	5	008670705
M6	30	5	008670706
M7	30	5	008670707
M8	30	5	008670708
M9	30	5	008670709
M10	30	5	008670710
M11	30	5	008670711
M12	30	5	008670712
M13	30	5	008670713

867/RIBE/L

inserti per avvitatori
per viti con impronta RIBE®



	L		
mm	mm		
M5	75	5	008670755
M6	75	5	008670756
M7	75	5	008670757
M8	75	5	008670758
M9	75	5	008670759
M10	75	5	008670760
M11	75	5	008670761
M12	75	5	008670762
M13	75	5	008670763

867/...

bussole portainseri per 867



	mm	mm	L	Ø	
	mm	mm	mm	mm	
867/1	10	3/8"	38	17	5 008670600
867/2	10	1/2"	38	22	5 008670601

867/C20

18 inserti con impronta RIBE® con attacco esagonale 10 mm e 2 accessori



867/C20 1 008670920

- 867/RIBE 5-6-7-8-9-10-11-12-13 mm
- 867/RIBE/L 5-6-7-8-9-10-11-12-13 mm
- 867/1
- 867/2

335x145x60 mm - 1,7 kg

867/C38

38 inserti con attacco esagonale 10 mm e 1 portainseri a T snodato



867/C38 1 008670938

- 852 10 mm
- 867PE 4-5-6-7-8-10-12mm
- 867PE/L 4-5-6-7-8-10-12mm
- 867XZN M5-M6-M8-M10-M12
- 867XZN/L M5-M6-M8-M10-M12
- 867TX T20-T25-T30-T40-T45-T50-T55
- 867TX/L T20-T25-T30-T40-T45-T50-T55
- 882

420x185x60 mm - 3 kg

867/C52

52 inserti con attacco esagonale 10 mm e 2 accessori

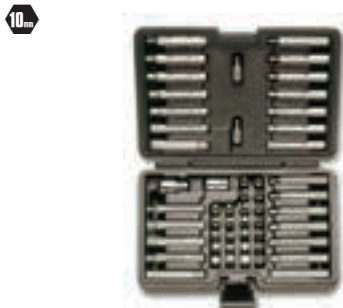

867/C52 1 008670901

- 867PE 4-5-6-7-8-10-12 mm
- 867PE/L 4-5-6-7-8-10-12 mm
- 867XZN M5-M6-M8-M10-M12
- 867XZN/L M5-M6-M8-M10-M12
- 867TX T20-T25-T30-T40-T45-T50-T55
- 867TX/L T20-T25-T30-T40-T45-T50-T55
- 867RTX T20-T25-T30-T40-T45-T50-T55
- 867RTX/L T20-T25-T30-T40-T45-T50-T55
- 867/1 10 mm - □ 3/8"
- 867/2 10 mm - □ 1/2"

250x170x70 mm - 2,1 kg

852



852 78,116

882

portainseri con anello di ritegno per avvitatori



ISO 1173 E 6,3

L	mm	mm	mm	mm	
57	1/4	1/4	11	5	008820001

882AN

rinvio angolare attacco esagonale 1/4"

- Per trapani elettrici con mandrino da 10 e 13 mm e avvitatori con attacco da 1/4"
- Velocità max 3600 giri/min.
- Coppia massima 30 Nm
- Con porta-inserti a cambio rapido
- Rapporto di trasmissione 1:1
- Collegamento all'utensile mediante esagono 1/4" D6.3



ISO 1173 E 6,3
ISO 1173 C 6,3

L	mm	mm	mm	mm	
137	1/4	1/4	11	1	008820090

882M1

portainseri magnetico per avvitatori



ISO 1173 E 6,3

L	mm	mm	mm	mm	
50	1/4	1/4	11	5	008820006

882M

portainseri magnetico per avvitatori



ISO 1173 E 6,3

L	mm	mm	mm	mm	
75	1/4	1/4	11	5	008820005

Beta

882MSR

portainseri magnetico a sgancio rapido per avvitatori



ISO 1173 E 6,3

L mm	○	●	Ø mm		
50	1/4	1/4	11	5	008820205
75	1/4	1/4	11	5	008820207

882P

prolunga portainseri magnetica



L mm	●	○	Ø mm		
80	1/4	1/4	10	5	008820080

892

raccordi per avvitatori



	■	●	L mm		
892/0	1/4	1/4	25	5	008920000
* 892/1	1/4	5,5	50	5	008920001
* 892/2	3/8	5,5	50	5	008920002
° 892/3	1/4	1/4	50	5	008920003
° 892/4	3/8	1/4	50	5	008920004
892/5	1/4	5/16	75	5	008920005
892/6	3/8	5/16	75	5	008920006
892/7	1/2	1/4	75	5	008920007

* ISO 1173 A 5,5
° ISO 1173 C 6,3



895

bussole portainseri per 860, 861, 862, 866



DIN 7427

	○	□	L mm	Ø mm		
895/1	1/4	1/4	25,4	12	5	008950000
895/3	1/4	3/8	29	16,8	5	008950001
895/4	5/16	3/8	29	16,8	5	008950002
895/5	1/4	1/2	38	22	5	008950005
895/6	5/16	1/2	38	22	5	008950003

897

portainseri flessibile con impugnatura



L mm	L1 mm		
280	154	2	008970010

897L

portainseri flessibile con impugnatura modello lungo



L mm	L1 mm		
500	380	2	008970015

CRICCHETTI 9XX/55

Ingombro minimo della testa

72

Spazio limitato di manovra, solo 5° grazie ai 72 denti della corona



Nessuna possibilità di slittamento o sganciamento sotto sforzo

- La pressione della mano sulla testa non provoca l'inversione e permette sempre il ritorno libero della leva
- Inversione con una sola mano
- Ottime caratteristiche meccaniche



Riduzione del carico di lavoro, 17 denti sempre in presa

900

chiavi a bussola a mano
bocca esagonale



UNI/ISO 2725 DIN 3124

mm	Ø	L	Ø1	
3,2	6,6	25	11,8	10 009000032
4	6,8	25	11,8	10 009000040
4,5	7,4	25	11,8	10 009000045
5	8,0	25	11,8	10 009000050
5,5	8,7	25	11,8	10 009000055
6	9,3	25	11,8	10 009000060
7	10,4	25	11,8	10 009000070
8	11,8	25	12,7	10 009000080
9	12,7	25	11,8	10 009000090
10	14,2	25	12,0	10 009000100
11	15,8	25	12,5	10 009000110
12	17,2	25	13,5	10 009000120
13	18,0	25	13,5	10 009000130
14	20,0	25	15,0	10 009000140



900/SB13
4-4,5-5-5,5-6-7-8-9
10-11-12-13-14 mm
1 009000150

900MC

chiavi a bussola a mano
bocca esagonale
colorate

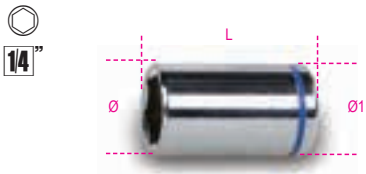

mm	L	Ø	Ø1	
4	24,8	6,7	11,8	5 009002040
5	24,8	8,0	11,8	5 009002050
6	24,8	9,2	11,8	5 009002060
7	24,8	10,7	11,8	5 009002070
8	24,8	11,8	11,8	5 009002080
9	24,8	12,8	12,8	5 009002090
10	24,8	14,8	14,8	5 009002100
11	24,8	15,8	15,8	5 009002110
12	24,8	16,8	16,8	5 009002120
13	24,8	17,8	17,8	5 009002130
14	24,8	19,5	19,5	5 009002140

900MB

chiavi a bussola a mano
bocca poligonale



UNI/ISO 2725 DIN 3124

mm	Ø	L	Ø1	
4	6,7	22	11,2	5 009000160
5	7,7	25	11,2	5 009000161
5,5	8,3	25	11,2	5 009000162
6	9,0	25	11,2	5 009000163
7	10,2	25	11,2	5 009000164
8	11,3	25	12,0	5 009000165
9	13,0	25	12,0	5 009000166
10	14,3	25	12,9	5 009000167
11	16,0	25	14,3	5 009000168
12	17,4	25	16,0	5 009000169
13	18,0	25	16,4	5 009000170
14	19,3	25	17,9	5 009000171



900MB/SB12
4-5-5,5-6-7-8-9-10
11-12-13-14 mm
1 009000179

900L

chiavi a bussola a mano lunghe
bocca esagonale



UNI/ISO 2725 DIN 3124

mm	Ø	L	Ø1	
4	6,5	50	12,0	5 009000181
4,5	7,0	50	12,0	5 009000182
5	7,5	50	12,0	5 009000183
5,5	8,5	50	12,0	5 009000184
6	9,5	50	12,0	5 009000185
7	10,5	50	12,0	5 009000186
8	12,0	50	12,0	5 009000187
9	13,0	50	13,0	5 009000188
10	14,0	50	14,0	5 009000189
11	16,0	50	16,0	5 009000190
12	17,5	50	17,5	5 009000191
13	17,5	50	17,5	5 009000192
14	20,0	50	20,0	5 009000193



900L/SB13
4-4,5-5-5,5-6-7-8-9-10-11-12-13-14 mm
1 009000203

900MB/L

chiavi a bussola a mano lunghe
bocca poligonale



UNI/ISO 2725 DIN 3124

mm	Ø	L	Ø1	
5	8,0	50	12,0	3 009000211
6	9,3	50	12,0	3 009000212
7	10,9	50	12,0	3 009000213
8	11,6	50	12,0	3 009000214
9	13,0	50	12,0	3 009000215
10	14,3	50	12,8	3 009000216
11	16,0	50	14,2	3 009000217
12	17,4	50	15,5	3 009000218
13	18,0	50	16,2	3 009000219
14	19,0	50	17,1	3 009000220

900AS

chiavi a bussola a mano
bocca esagonale



mm	Ø	L	Ø1	
5/32	8,8	25	11,9	5 009000349
3/16	7,7	25	11,9	5 009000340
7/32	8,8	25	11,9	5 009000345
1/4	9,6	25	11,9	5 009000350
9/32	10,2	25	11,9	5 009000355
5/16	11,3	25	11,9	5 009000360
11/32	12,7	25	11,6	5 009000365
3/8	14,0	25	12,9	5 009000370
7/16	15,3	25	14,5	5 009000375
1/2	17,5	25	16,4	5 009000380
9/16	19,0	25	17,9	5 009000385



900AS/SB11
3/16-7/32-5/32-1/4-9/32-5/16-11/32-3/8-
7/16-1/2-9/16
1 009000389

900AS/MB

chiavi a bussola a mano
bocca poligonale



SAE AS 954E

mm	Ø	L	Ø1	
3/16	7,7	22	10,9	2 009000390
7/32	8,5	22	10,9	2 009000391
1/4	9,4	22	10,9	2 009000392
9/32	10,2	22	10,9	2 009000393
5/16	11,3	22	11,7	2 009000394
11/32	12,5	22	12,0	2 009000395
3/8	13,7	22	12,9	2 009000396
7/16	15,6	22	14,3	2 009000397
1/2	17,2	22	16,4	2 009000398
9/16	18,8	24	17,9	2 009000399



900AS/L

chiavi a bussola a mano lunghe
bocca esagonale

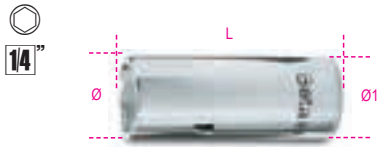

SAE AS 954E

"	Ø	L	Ø1		
mm	mm	mm	mm		
3/16	7,0	50	12,0	2	009000301
7/32	8,5	50	12,0	2	009000303
1/4	9,8	50	12,0	2	009000305
9/32	10,5	50	12,0	2	009000307
5/16	12,0	50	12,0	2	009000309
11/32	13,0	50	13,0	2	009000311
3/8	14,0	50	14,0	2	009000313
7/16	16,0	50	16,0	2	009000315
1/2	17,5	50	17,5	2	009000317
9/16	20,0	50	20,0	2	009000319

900AS/MBL

chiavi a bussola a mano lunghe
bocca poligonale



"	Ø	L	Ø1		
mm	mm	mm	mm		
5/32	6,8	50	12,0	2	009000325
3/16	8,0	50	12,0	2	009000326
7/32	8,5	50	12,0	2	009000327
1/4	9,8	50	12,0	2	009000328
9/32	10,9	50	12,0	2	009000329
5/16	11,6	50	12,0	2	009000330
11/32	13,0	50	12,0	2	009000331
3/8	14,3	50	12,8	2	009000332
7/16	16,0	50	14,2	2	009000333
1/2	18,0	50	16,2	2	009000334
9/16	19,0	50	17,1	2	009000335

900U

chiavi a bussola a mano
bocca multimpronta



mm	"	Ø	Ø1		
4	5/32	E5	M5	5	009001702
4,5	3/16	E6		5	009001703
5	13/64		M6	5	009001704
5,5	7/32	E7		5	009001705
6	1/4	E8	M8	5	009001706
7	9/32			5	009001707
8	5/16	E10	M10	5	009001708
9	11/32			5	009001709
10	3/8	E12	M12	5	009001710
11	7/16	E14	M14	5	009001711
12	15/32	E16		5	009001712
13	1/2	M16		5	009001713
14	9/16	E18	M18	5	009001714

1/4"



900U/SB13

4-4,5-5-5,5-6-7-8-9
10-11-12-13-14 mm

1 009001750

900FTX

chiavi a bussola a mano per viti
con teste a profilo Torx®

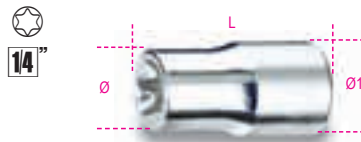

"	Ø	L	Ø1		
mm	mm	mm	mm		
E4	5,4	22	11,2	5	009000404
E5	6,7	22	11,2	5	009000405
E6	7,7	22	11,2	5	009000406
E7	8,3	22	11,2	5	009000407
E8	9,6	22	11,2	5	009000408
E10	11,3	22	12,0	5	009000410
E11	12,1	22	12,5	5	009000411
E12	12,9	23	12,9	5	009000412
E14	14,0	25	14,0	5	009000414

1/4"



900FTX/SB9

E4-E5-E6-E7-E8
E10-E11-E12-E14

1 009000419

900LP

chiavi a bussola a giravite
per viti con intaglio



SxA	Ø	L	L1		
mm	mm	mm	mm		
0,8x4	12	28	9	5	009000605
1x5,5	12	28	9	5	009000610
1,2x6,5	12	28	9	5	009000615
1,2x8	13	28	8	5	009000620
1,6x10	14	28	8	5	009000625

900MC/LP

chiavi a bussola a giravite
per viti con intaglio colorate



SxA	Ø	L	L1		
mm	mm	mm	mm		
0,8x4	12	28	9	3	009002605
1,2x6,5	12	28	9	3	009002615
1,2x8	13	28	8	3	009002620

900PH

chiavi a bussola a giravite
per viti con impronta a croce Phillips®



PH	Ø	L	L1		
mm	mm	mm	mm		
1	12	28	12	5	009000701
2	12	28	12	5	009000702
3	12	28	12	5	009000703
4	13	28	11	5	009000704



900PH/SB4

PH1-PH2-PH3-PH4

1 009000708

900MC/PH

chiavi a bussola a giravite
per viti con impronta a croce Phillips® colorate

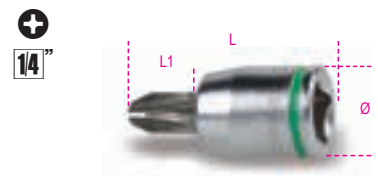

PH	Ø	L	L1		
mm	mm	mm	mm		
1	12	28	12	3	009002701
2	12	28	12	3	009002702
3	12	28	12	3	009002703

900PZ

chiavi a bussola a giravite
per viti con impronta a croce Pozidriv®-
Supadriv®



PZ	Ø	L			
mm	mm	mm			
1	12	28	3	009000711	
2	12	28	3	009000712	
3	12	28	3	009000713	

900ME

chiavi a bussola a giravite
maschio esagonale



mm	Ø mm	L mm	L1 mm	
2,5	12	25	4,5	5 009000502
3	12	25	5,0	5 009000503
4	12	25	5,6	5 009000504
5	12	25	6,3	5 009000505
6	12	25	7,6	5 009000506
7	13	25	7,2	5 009000507
8	13	25	8,0	5 009000508
10	13	25	8,7	5 009000510



900ME/SB8
2,5-3-4-5-6-7-8-10 mm

900PE/AS

chiavi a bussola maschio esagonale



"	Ø mm	L mm	
1/8	11,9	25	5 009000521
5/32	11,9	25	5 009000522
3/16	11,9	25	5 009000523
7/32	11,9	25	5 009000524
1/4	11,9	25	5 009000525
9/32	13,1	25	5 009000526
5/16	13,1	25	5 009000527

900PT

chiavi a bussola a giravite per viti con
impronta pentalobata



PT	Ø mm	L mm	L1 mm	
PT10	12	28	12	5 009000750
PT15	12	28	12	5 009000755
PT20	12	28	12	5 009000760
PT25	12	28	12	5 009000765
PT27	12	28	12	5 009000767
PT30	12	28	12	5 009000770

900TX

chiavi a bussola a giravite maschio
per viti con impronta Torx®



T	Ø mm	L mm	L1 mm	
T6	12	28	12	5 009000717
T7	12	28	12	5 009000718
T8	12	28	12	5 009000719
T9	12	28	12	5 009000720
T10	12	28	12	5 009000721
T15	12	28	12	5 009000722
T20	12	28	12	5 009000723
T25	12	28	12	5 009000724
T27	12	28	12	5 009000725
T30	12	28	12	5 009000726
T40	12	28	12	5 009000727



900TX/SB8
T9-T10-T15-T20
T25-T27-T30-T40

900MC/TX

chiavi a bussola a giravite maschio
per viti con impronta Torx® colorate



T	Ø mm	L mm	L1 mm	
T10	12	28	12	3 009002721
T15	12	28	12	3 009002722
T20	12	28	12	3 009002723
T25	12	28	12	3 009002724
T27	12	28	12	3 009002725
T30	12	28	12	3 009002726
T40	12	28	12	3 009002727

900/16

raccordo con attacco quadro
femmina 1/4" e maschio 3/8"



UNI/ISO 3316 DIN 3123

L mm	Ø mm			
28	13,0	1/4	3/8	5 009000814

900/...

prolunghe con attacchi quadri
maschio e femmina 1/4"

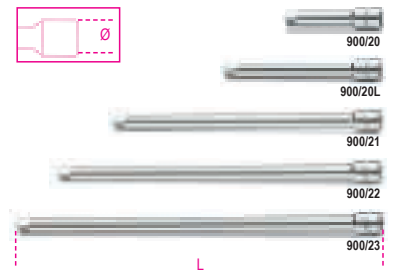

UNI/ISO 3316 DIN 3123

	L mm	Ø mm	
900/20	50	11,5	5 009000818
900/20L	100	11,5	5 009000819
900/21	150	11,5	5 009000822
900/22	250	11,5	5 009000823
900/23	350	11,5	5 009000824

900AN

prolunghe con attacchi quadri
maschio e femmina 1/4"
angolari

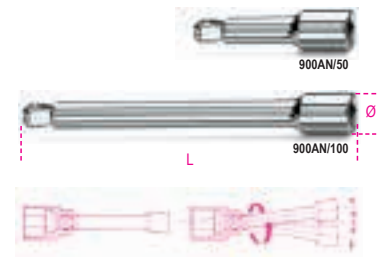

	L mm	Ø mm	
900AN/50	50	11,5	3 009000825
900AN/100	100	11,5	3 009000826

900FL

prolunga flessibile con attacchi quadri
maschio e femmina 1/4"

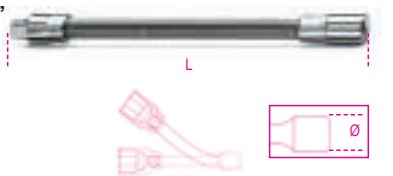

L mm	Ø mm	
150	12	3 009000828

900/25

snodo con attacchi quadri
maschio e femmina 1/4"



UNI/ISO 3316 DIN 3123

L mm	Ø mm	
41	12,5	5 009000830

900BG/30C

quadro maschio 1/4"
con impugnatura



UNI/ISO 3315 DIN 3122

L	L1		
mm	mm		
128	20	5	009000833

900BG/30

quadro maschio 1/4"
con impugnatura



UNI/ISO 3315 DIN 3122

L	L1		
mm	mm		
176	68	5	009000834

900/32

quadro maschio 1/4" flessibile
con impugnatura

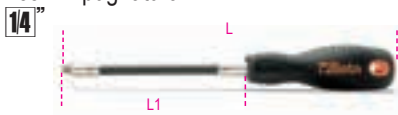

L	L1		
mm	mm		
280	154	2	009000839

900/35A

quadro maschio 1/4" snodato
con impugnatura



UNI/ISO 3315 DIN 3122

L	L1		
mm	mm		
148	84	5	009000840

900M/35

quadro maschio 1/4" snodato
con impugnatura in metallo

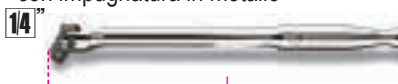

UNI/ISO 3315
DIN 3122

L			
mm			
130		3	009000845



900/40

quadro maschio 1/4" snodato a T

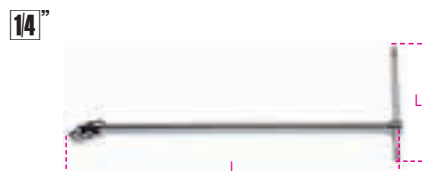

L	L1		
mm	mm		
390	145	3	009000843

900/42

quadro maschio 1/4"
con spina scorrevole



UNI/ISO 3315 DIN 3122

L	A		
mm	mm		
115	22	5	009000854

900T/44

quadro maschio 1/4" piegato
con impugnatura di manovra



L	L1		
mm	mm		
238	105	2	009000860

900/55

cricchetto reversibile
con attacco quadro maschio 1/4"
meccanismo a 48 denti



UNI/ISO 3315 DIN 3122

L	Ø	A		
mm	mm	mm		
125	25	29	5	009000870

900/55Z

72



Il cricchetto 900/55Z è stato sviluppato dall'Ufficio Tecnico Beta con un nuovo meccanismo a 72 denti di cui 15 sempre in presa.

Il carico di lavoro è pertanto suddiviso su un grande numero di denti, in modo da diminuire l'usura del singolo elemento e offrire una vita di lavoro molto lunga.



I 72 denti garantiscono, un angolo di ripresa di soli 5° e una testa molto compatta, per agire rapidamente anche negli spazi più ristretti.

L'impugnatura bimatériale ergonomica Beta permette di utilizzare il cricchetto sia in modo rapido che applicando maggiore forza.

900/55Z

cricchetto reversibile
con attacco quadro maschio 1/4"
meccanismo a 72 denti



L	Ø	A		
mm	mm	mm		
126	25	23	3	009000882

900M/55

cricchetto reversibile
con attacco quadro maschio 1/4"
con impugnatura in metallo



UNI/ISO 3315 DIN 3122		
L	Ø	A
mm	mm	mm
110	22	18

3 009000905

**Meccanismi rotanti
di ricambio dei cricchetti,
vedi tabella dopo l'art. 929/C8**

900/58

cricchetto reversibile
con impugnatura rotante
con attacco quadro maschio 1/4"
meccanismo a 52 denti

- Pulsante di rilascio della bussola
- Sistema di inversione a ghiera sulla testa del cricchetto
- Impugnatura bimatériale



L	Ø	A
mm	mm	mm
126	28	28,5

2 009000884

900/C39N

11 chiavi a bussola esagonali, 21 inserti e 7 accessori



900/C39N 1 009000947

861LP	0,6x4,5 - 1,2x6,5 - 1,2x8 mm
861PH	PH1-PH2-PH3
861PZ	PZ1-PZ2-PZ3
861PE	2,5-3-4-5-6 mm
861RTX	T10-T15-T20-T25-T27-T30-T40
900	5-5,5-6-7-8-9-10-11-12-13-14 mm
900/20	50 mm
900/20L	100 mm
900/25	
900BG/30C	128 mm
892/0	
895/1	
900/55Z	126 mm

900/C39U

11 chiavi a bussola multimpronta, 21 inserti e 7 accessori



900/C39U 1 009001947

861LP	0,6x4,5 - 1,2x6,5 - 1,2x8 mm
861PH	PH1-PH2-PH3
861PZ	PZ1-PZ2-PZ3
861PE	2,5-3-4-5-6 mm
861RTX	T10-T15-T20-T25-T27-T30-T40
900U	5-5,5-6-7-8-9-10-11-12-13-14 mm * 3/16-13/64-7/32-1/4-9/32-5/16- 11/32-3/8-7/16-15/32-1/2-9/16 E6-E7-E8-E10-E12-E14-E16-E18 M6-M8-M10-M12-M14-M16-M18
900/20	50 mm
900/20L	100 mm
900/25	
900BG/30C	128 mm
892/0	
895/1	
900/55Z	126 mm

900/C11

11 chiavi a bussola esagonali,
20 inserti per avvitatori e 8 accessori



900/C11 1 009000971

861LP	0,5x3 - 0,8x5,5 1x5,5 - 1,2x6,5 mm
861PE	3 - 4 - 5 - 6 - 8 mm
861PH	0 - 1 - 2 - 3
861TX	T8 - T10 - T15 - T20 T25 - T30 - T40
895/1	
900	5 - 5,5 - 6 - 7 - 8 - 9 - 10 11 - 12 - 13 - 14 mm
900/16	□ 1/4 - ■ 3/8
900/20	50 mm
900/21	150 mm
900/25	
900BG/30	176 mm
900/42	
900/55	

270x120x45 mm - 1,2 kg

9899 900C11 1 098990132
termoformato vuoto

900/C11Z

11 chiavi a bussola esagonali,
20 inserti per avvitatori e 8 accessori



900/C11Z 1 009000984

861LP	0,5x3 - 0,8x5,5 - 1x5,5 - 1,2x6,5 mm
861PE	3 - 4 - 5 - 6 - 8 mm
861PH	0 - 1 - 2 - 3
861TX	T8 - T10 - T15 - T20 T25 - T30 - T40
895/1	
900	5 - 5,5 - 6 - 7 - 8 - 9 - 10 11 - 12 - 13 - 14 mm
900/16	□ 1/4 - ■ 3/8
900/20	50 mm
900/21	150 mm
900/25	
900BG/30	176 mm
900/42	
900/55Z	

350x150x50 mm - 1,2 kg

9899 900C11 1 098990132
termoformato vuoto

900/C12MR

12 chiavi a bussola esagonali,
20 inserti per avvitatori e 7 accessori
in termoformato morbido,
in cassetta di lamiera

- cricchetto con impugnatura rotante



900/C12MR 1 009000962

900	4-5-5,5-6-7-8-9-10-11-12-13-14 mm
900/20	50 mm
900/21	150 mm
900/25	
900/42	115 mm
900BG/30	128 mm
900/58	
895/1	
861TX	T8-T10-T15-T20-T25-T30-T40
861PH	PH0-PH1-PH2-PH3
861LP	0,5-0,8-1-1,2 mm
861PE	3-4-5-6-8 mm

350x150x50 mm 1,3 kg

900/C12MZ

12 chiavi a bussola esagonali,
20 inserti per avvitatori e 7 accessori
in termoformato morbido

1/4"

1/4"



900/C12MZ

1 009000983

- 900 4-5-5,5-6-7-8-9-10-11-12-13-14 mm
- 900/20 50 mm
- 900/21 150 mm
- 900/25
- 900/42 115 mm
- 900BG/30 176 mm
- 900/55Z
- 895/1
- 861TX T8-T10-T15-T20-T25-T30-T40
- 861PH PH0-PH1-PH2-PH3
- 861LP 0,5x3 - 0,8x5,5 - 1x5,5 - 1,2x6,5 mm
- 861PE 3-4-5-6-8 mm

350x150x50 mm - 1,2 kg

900/C13-5

13 chiavi a bussola esagonali
e 5 accessori

1/4"



900/C13-5

1 009000953

- 900 4 - 4,5 - 5 - 5,5 - 6 - 7 - 8 - 9
10 - 11 - 12 - 13 - 14 mm
- 900/21 150 mm
- 900/25
- 900BG/30
- 900/42
- 900/55

270x120x45 mm - 1 kg

9899 900/C13-5
termoformato vuoto

1 098990131

900/C13-8

13 chiavi a bussola esagonali
e 8 accessori

1/4"



900/C13-8

1 009000954

- 900 4 - 4,5 - 5 - 5,5 - 6 - 7 - 8 - 9
10 - 11 - 12 - 13 - 14 mm
- 900/16 □ 1/4 - ■ 3/8
- 900/20 50 mm
- 900/21 150 mm
- 900/25
- 900BG/30
- 900/35A
- 900/42
- 900/55

270x120x45 mm - 1,1 kg

900MB/C19

11 chiavi a bussola poligonali
e 8 accessori

1/4"



900MB/C19

1 009000977

- 900MB 5 - 5,5 - 6 - 7 - 8 - 9 - 10 - 11
12 - 13 - 14 mm
- 900/16 □ 1/4 - ■ 3/8
- 900/20 50 mm
- 900/21 150 mm
- 900/25
- 900BG/30
- 900/35A
- 900/42
- 900/55

270x120x45 mm - 1,1 kg

900/C24

13 chiavi a bussola esagonali
e 11 a giravite e 6 accessori

1/4"



900/C24

1 009000956

- 900 4 - 4,5 - 5 - 5,5 - 6 - 7 - 8 - 9
10 - 11 - 12 - 13 - 14 mm
- 900LP 0,8x4 - 1,2x6,5 - 1,2x8 mm
- 900PH PH1 - PH2 - PH3
- 900ME 3 - 4 - 5 - 6 - 8 mm
- 900/20 50 mm
- 900/21 150 mm
- 900/25
- 900BG/30
- 900/42
- 900/55

270x120x45 mm - 1,1 kg

900MB/C28

11 chiavi a bussola poligonali
11 a giravite e 6 accessori

1/4"



900MB/C28

1 009000979

- 900MB 5 - 5,5 - 6 - 7 - 8 - 9 - 10 - 11
12 - 13 - 14 mm
- 900LP 0,8x4 - 1,2x6,5 - 1,2x8 mm
- 900PH PH1 - PH2 - PH3
- 900ME 3 - 4 - 5 - 6 - 8 mm
- 900/20 50 mm
- 900/21 150 mm
- 900/25
- 900BG/30
- 900/42
- 900/55

270x120x45 mm - 1,1 kg



900MC/C24

11 chiavi a bussola esagonali colorate
13 a giravite colorate e 6 accessori

1/4"



900MC/C24

1 009002960

	900MC	4 - 5 - 6 - 7 - 8 - 9 10 - 11 - 12 - 13 - 14 mm
	900MC/PH	PH1 - PH2 - PH3
	900MC/TX	T10 - T15 - T20 - T25 - T27 - T30 - T40
	900MC/LP	0,8x4 - 1,2x6,5 - 1,2x8 mm
	900/20	50 mm
	900/21	150 mm
	900/25	
	900BG/30	
	900/42	
	900/55	
270x120x45 mm - 1,1 kg		

900MC/C32

11 chiavi a bussola esagonali colorate,
20 inserti colorati per avvitatori e 7 accessori

1/4"



900MC/C32

1 009002963

	900MC	4 - 5 - 6 - 7 - 8 - 9 - 10 - 11 - 12 - 13 - 14 mm
	860LP	0,5x3 - 0,8x5,5 - 1,0x5,5 - 1,2x6,5 mm
	860PH	0 - 1 - 2 - 3
	860PE	3 - 4 - 5 - 6 - 8 mm
	860TX	T8 - T10 - T15 - T20 - T25 - T30 - T40
	895/1	
	900/20	
	900/21	
	900/25	
	900BG/30	
	900/42	
	900/55	
270x120x45 mm - 1,2 kg		

900U/C12M

12 chiavi a bussola mutimpronta,
20 inserti per avvitatori e 7 accessori
in termoformato morbido

1/4"

1/4"



900U/C12M

1 009001792

	900U	○ 4-5-5,5-6-7-8-9-10-11-12-13-14 mm * 5/32-3/16-13/64-7/32-1/4-9/32-5/16 11/32-3/8-7/16-15/32-1/2-9/16 ○ E5-E6-E7-E8-E10-E12-E14-E16-E18 ○ M5-M6-M8-M10-M12-M14-M16-M18
	900/20	50 mm
	900/21	150 mm
	900/25	
	900/42	115 mm
	900BG/30	176 mm
	900/55	125 mm
	895/1	○ 1/4 - □ 1/4
	861LP	0,5x3 - 0,8x5,5 - 1,0x5,5 - 1,2x6,5 mm
	861PE	3-4-5-6-8 mm
	861PH	PH0-PH1-PH2-PH3
	861TX	T8-T10-T15-T20-T25-T30-T40
350x150x50 mm - 1,2 kg		



900AS/C10 - /MB-C17

10 chiavi a bussola
e 7 accessori

1/4"



900AS/C10

1 009000961

	900AS	3/16 - 7/32 - 1/4 - 9/32 - 5/16 11/32 - 3/8 - 7/16 - 1/2 - 9/16
	900/20	50 mm
	900/21	150 mm
	900/25	
	900BG/30	
	900/35A	
	900/42	
	900/55	
270x120x45 mm - 1,1 kg		

900AS/MB-C17

1 009000981

	900AS/MB	3/16 - 7/32 - 1/4 - 9/32 - 5/16 11/32 - 3/8 - 7/16 - 1/2 - 9/16
	900/20	50 mm
	900/21	150 mm
	900/25	
	900BG/30	
	900/35A	
	900/42	
	900/55	
270x120x45 mm - 1,1 kg		

900AS/C17-MBM

10 chiavi a bussola poligonali
e 7 accessori
per manutenzioni aeronautiche

1/4"



900AS/C17-MBM

1 009000982

	900AS/MB	3/16 - 7/32 - 1/4 - 9/32 - 5/16 11/32 - 3/8 - 7/16 - 1/2 - 9/16
	900/20	50 mm
	900/21	150 mm
	900/25	
	900BG/30	
	900M/35	
	900/42	
	900M/55	
270x120x45 mm - 1,2 kg		

900/C11HR

11 chiavi a bussola esagonali,
20 inserti per avvitatori e 7 accessori
in termoformato rigido,
in cassetta di lamiera

• cricchetto con impugnatura rotante

1/4

1/4



900/C11HR

1 009000980

	861LP	0,5x3-0,8x5,5-1x5,5-1,2x6,5 mm
	861PH	PH0-PH1-PH2-PH3
	861PE	3-4-5-6-8 mm
	861TX	T8-T10-T15-T20-T25-T30-T40
	895/1	
	900	5-5,5-6-7-8-9-10-11-12-13-14 mm
	900/16	□ 1/4 - ■ 3/8
	900/20	50 mm
	900/21	150 mm
	900/25	
	900/42	
	900BG/30	
	900/58	

350x150x50 mm - 1,3 kg

902R/C6

6 raccordi per chiavi a bussola



902R/C6

1 009020814

	900/16	□ 1/4 - ■ 3/8
	910/15	□ 3/8 - ■ 1/4
	910/16	□ 3/8 - ■ 1/2
	920/15	□ 1/2 - ■ 3/8
	920/16	□ 1/2 - ■ 3/4
	928/15	□ 3/4 - ■ 1/2

170x100x35 mm - 600 g

902A/C22

22 chiavi a bussola esagonali e 6 accessori in
cassetta di lamiera

1/4

1/2



902A/C22

1 009020807

	900	5-5,5-6-7-8-9-10-11-12-13 mm
	900/20	50 mm
	900/25	
	1/4 900/55	
	920A	10-13-14-15-17-18-19-22-24-27-30-32 mm
	920/21	125 mm
	920/25	
	1/2 920/55	

420x185x60 mm - 3,5 kg

9899 902A/C22

1 098990133

termoformato vuoto

910A

chiavi a bussola a mano
bocca esagonale

3/8

3/8



UNI/ISO 2725 DIN 3124

mm	Ø	L	Ø1	
6	9,5	28	16,7	5 009100006
7	10,7	28	16,7	5 009100007
8	12,1	28	16,7	5 009100008
9	13,2	28	16,7	5 009100009
10	14,6	29	16,7	5 009100010
11	15,8	29	16,7	5 009100011
12	17,2	30	17,7	5 009100012
13	18,4	31	17,0	5 009100013
14	19,7	32	17,5	5 009100014
15	20,9	32	18,0	5 009100015
16	22,2	33	18,5	5 009100016
17	23,2	33	19,0	5 009100017
18	24,7	34	20,0	5 009100018
19	25,8	35	21,0	5 009100019
20	27,2	35	22,0	5 009100020
21	28,2	36	23,0	5 009100021
22	29,7	37	24,0	5 009100022

3/8

3/8



910A/SB17

1 009100030

6-7-8-9-10-11-12
13-14-15-16-17
18-19-20-21-22 mm

910B

chiavi a bussola a mano
bocca poligonale

3/8

3/8



UNI/ISO 2725 DIN 3124

mm	Ø	L	Ø1	
6	9,5	28	16,7	5 009100106
7	10,7	28	16,7	5 009100107
8	12,1	28	16,7	5 009100108
9	13,2	28	16,7	5 009100109
10	14,6	29	16,7	5 009100110
11	15,8	29	16,7	5 009100111
12	17,2	30	17,7	5 009100112
13	18,4	31	17,0	5 009100113
14	19,7	32	17,5	5 009100114
15	20,9	32	18,0	5 009100115
16	22,2	33	18,5	5 009100116
17	23,2	33	19,0	5 009100117
18	24,7	34	20,0	5 009100118
19	25,8	35	21,0	5 009100119
20	27,2	35	22,0	5 009100120
21	28,2	36	23,0	5 009100121
22	29,7	37	24,0	5 009100122

3/8

3/8



910B/SB17

1 009100130

6-7-8-9-10-11-12
13-14-15-16-17
18-19-20-21-22 mm

910AL

chiavi a bussola a mano lunghe
bocca esagonale

3/8

3/8



UNI/ISO 2725 DIN 3124

mm	Ø	L	Ø1	
8	12,0	55	17	3 009100158
9	13,0	55	17	3 009100159
10	14,5	55	17	3 009100160
11	16,0	55	17	3 009100161
12	17,0	55	17	3 009100162
13	18,0	55	17	3 009100163
14	20,0	55	18	3 009100164
15	21,0	55	20	3 009100165
16	22,0	55	20	3 009100166
17	23,5	55	22	3 009100167
18	24,5	55	23	2 009100168
19	25,0	55	24	2 009100169
21	27,0	65	26	2 009100171
22	29,0	65	28	2 009100172

3/8

3/8



910AL/SB14

1 009100174

8-9-10-11-12-13-14
15-16-17-18-19-21-22 mm

910BL

chiavi a bussola a mano lunghe
bocca poligonale

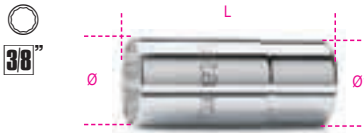

UN/ISO 2725 DIN 3124

mm	Ø	L	Ø1	
8	12,0	55	17	3 009100308
9	13,0	55	17	3 009100309
10	14,5	55	17	3 009100310
11	16,0	55	17	3 009100311
12	17,0	55	17	3 009100312
13	18,0	55	17	3 009100313
14	20,0	55	18	3 009100314
15	21,0	55	20	3 009100315
16	22,0	55	20	3 009100316
17	23,5	55	22	3 009100317
18	24,5	55	23	2 009100318
19	25,0	55	24	2 009100319
21	27,0	65	26	2 009100321
22	29,0	65	28	2 009100322



910BL/SB14
8-9-10-11-12-13
14-15-16-17-18
19-21-22 mm

910B/SN

chiavi a bussola a mano snodate
bocca poligonale

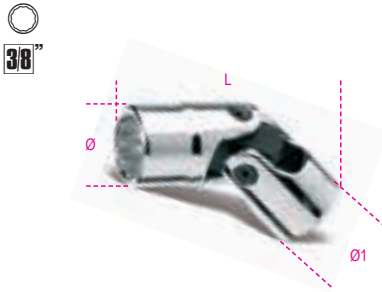

mm	Ø	L	Ø1	
10	14,5	48,5	19	2 009100230
11	15,8	49,5	19	2 009100231
12	17,0	50,0	19	2 009100232
13	18,3	51,0	19	2 009100233
14	19,5	51,0	19	2 009100234
15	20,8	53,5	19	2 009100235
16	22,0	53,5	19	2 009100236
17	23,3	54,5	19	2 009100237
18	24,5	54,5	19	2 009100238
19	25,8	56,5	19	2 009100239

910A/AS

chiavi a bussola a mano
bocca esagonale

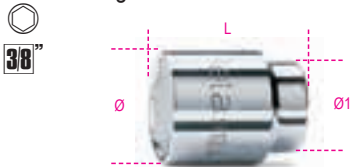

mm	Ø	L	Ø1	
1/4	10,3	26	17,3	5 009100276
5/16	11,9	26	17,3	5 009100278
11/32	13,3	26	17,3	5 009100279

"	Ø	L	Ø1	
3/8	13,9	26	17,3	5 009100280
7/16	15,8	26	17,3	5 009100281
1/2	17,9	26	17,3	5 009100283
9/16	19,5	27	18,5	5 009100284
19/32	20,6	27	19,5	5 009100285
5/8	21,9	28	20,0	5 009100286
11/16	24,6	30	22,5	5 009100287
3/4	25,9	30	23,5	5 009100289
13/16	27,9	32	26,0	5 009100291
7/8	29,6	32	26,5	5 009100292



910A-AS/SB13
1/4-5/16-11/32-3/8-7/16
1/2-9/16-19/32-5/8-11/16
3/4-13/16-7/8

910AS

chiavi a bussola a mano
bocca poligonale

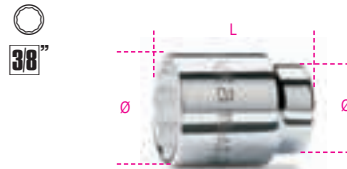

"	Ø	L	Ø1	
1/4	9,5	28	16,7	5 009100201
5/16	12,1	28	16,7	5 009100202
11/32	13,2	28	16,7	5 009100203
3/8	14,6	29	16,7	5 009100204
7/16	15,8	29	16,7	5 009100205
1/2	18,4	31	17,0	5 009100206
9/16	19,7	32	17,5	5 009100207
19/32	20,9	32	18,0	5 009100208
5/8	22,2	33	18,5	5 009100209
11/16	24,7	34	20,0	5 009100210
3/4	25,8	35	21,0	5 009100211
13/16	28,2	36	23,0	5 009100212
7/8	29,7	37	24,0	5 009100213



910AS/SB13
1/4-5/16-11/32-3/8-7/16
1/2-9/16-19/32-5/8-11/16
3/4-13/16-7/8

910AS/L

chiavi a bussola a mano lunghe
bocca poligonale



"	Ø	L	Ø1	
1/4	10	55	17	3 009100350
5/16	12	55	17	3 009100351
3/8	14	55	17	3 009100352
7/16	16	55	17	3 009100353
1/2	18	55	17	3 009100354
9/16	20	55	18	3 009100355

"	Ø	L	Ø1	
19/32	21	55	20	3 009100356
5/8	22	55	20	3 009100357
11/16	23	55	22	3 009100359
3/4	25	55	24	3 009100360
13/16	27	65	26	3 009100362
7/8	29	65	28	3 009100363



910ASL/SB12
1/4-5/16-3/8-7/16
1/2-9/16-19/32-5/8-11/16
3/4-13/16-7/8

910AS/SN

chiavi a bussola a mano snodate
bocca poligonale

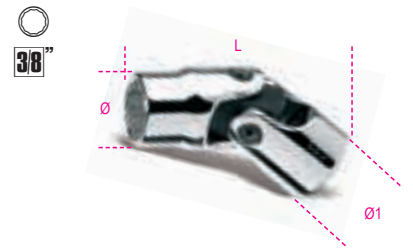

* SAE AS 954E

"	Ø	L	Ø1	
* 3/8	14,0	48,0	19	2 009100260
* 7/16	15,8	51,0	19	2 009100261
* 1/2	18,3	51,0	19	2 009100262
* 9/16	19,5	51,0	19	2 009100263
* 5/8	22,0	53,5	19	2 009100264
11/16	24,5	54,5	19	2 009100265
3/4	25,8	56,5	19	2 009100266

910FTX

chiavi a bussola a mano per viti
con testa a profilo Torx®



"	Ø	L	Ø1	
E4	6,2	26	17,3	5 009100404
E5	7,0	26	17,3	5 009100405
E6	8,3	26	17,3	5 009100406
E7	8,9	26	17,3	5 009100407
E8	9,9	26	17,3	5 009100408
E10	12,0	26	17,3	5 009100410
E11	13,3	26	17,3	5 009100411
E12	14,5	26	17,3	5 009100412
E14	15,8	26	17,3	5 009100414
E16	18,0	26	17,3	5 009100416
E18	19,5	26	18,5	3 009100418
E20	21,9	26	20,0	3 009100420



910FTX/SB9
E4-E5-E6-E7-E8
E10-E12-14-E16

910FTX/L

chiavi a bussola a mano lunghe per viti con testa a profilo Torx®



	Ø mm	L mm	Ø1 mm		
E4	6,2	55	17,3	3	009100440
E5	7,0	55	17,3	3	009100441
E6	8,3	55	17,3	3	009100442
E7	8,9	55	17,3	3	009100443
E8	9,9	55	17,3	3	009100444
E10	12,0	55	17,3	3	009100445



910FTX-L/SB6
E4-E5-E6
E7-E8-E10
1 009100449

910FTX/XL

chiavi a bussola a mano extra-lunghe per viti con testa a profilo Torx®



	Ø mm	L mm	Ø1 mm		
E6	8,0	200	18	2	009100766
E7	8,0	200	18	2	009100767
E8	10,0	200	18	2	009100768
E10	14,0	200	18	2	009100770
E11	14,0	200	18	2	009100771
E12	14,0	200	18	2	009100772
E14	17,0	200	18	2	009100774
E16	18,6	200	18	2	009100776
E18	21,5	200	18	2	009100778
E20	21,5	200	18	2	009100780

910FTX-XL/C10

10 chiavi a bussola per viti con impronta Torx® tipo lungo in cassetta di plastica



910FTX-XL/C10
E6-E7-E8-E10-E11-
E12-E14-E16-E18-E20
1 009100976

255x195x62 mm - 2,3 kg

910LP

chiavi a bussola a giravite per viti con intaglio



	SxA mm	Ø mm	L mm	L1 mm		
1x5,5	18,5	54	24	2	009100452	
1,2x6,5	18,5	54	24	2	009100453	
1,2x8	18,5	54	24	2	009100454	
1,6x9	18,5	54	24	2	009100456	

910PH

chiavi a bussola a giravite per viti con impronta a croce Phillips®



	PH	Ø mm	L mm	L1 mm		
1	1	18,5	48	18	2	009100471
2	2	18,5	48	18	2	009100472
3	3	18,5	48	18	2	009100473
4	4	18,5	48	18	2	009100474



910PH/SB4
PH1-PH2-PH3-PH4
1 009100478

910PE

chiavi a bussola maschio esagonale

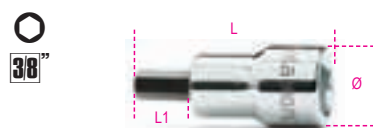

DIN 7422

	mm	Ø mm	L mm	L1 mm		
3	3	18,5	50	20	5	009100490
4	4	18,5	50	20	5	009100492
5	5	18,5	50	20	5	009100494
6	6	18,5	50	20	5	009100496
7	7	18,5	50	20	5	009100497
8	8	18,5	50	20	5	009100498
9	9	18,5	50	20	5	009100499
10	10	18,5	50	20	5	009100500



910PE/SB7
3-4-5-6-7-8-10 mm
1 009100503

910BP

chiavi a bussola maschio esagonale con estremità sferica



	mm	L mm	L1 mm		
4L	4	92	62	3	009100584
5L	5	92	62	3	009100585
6L	6	92	62	3	009100586
7L	7	92	62	3	009100587
8L	8	92	62	3	009100588
10L	10	132	102	3	009100590



910BP/SB6L
4L-5L-6L-7L-8L-10L mm
1 009100596

910ME

chiavi a bussola maschio esagonale



	mm	Ø mm	L mm	L1 mm		
4	4	18	62	15	5	009100504
5	5	18	62	15	5	009100505
6	6	18	62	15	5	009100506
7	7	18	62	15	5	009100507
8	8	19	62	15	5	009100508
10	10	20	62	15	5	009100510
12	12	20	62	15	5	009100512



910ME/SB5
4-5-6-8-10 mm
1 009100515

910PE/AS

chiavi a bussola maschio esagonale

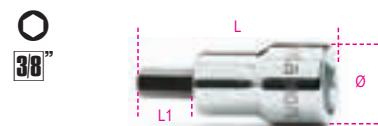

	mm	Ø mm	L mm	L1 mm		
1/8	1/8	18,5	50	20	2	009100531
5/32	5/32	18,5	50	20	2	009100532
3/16	3/16	18,5	50	20	2	009100533
7/32	7/32	18,5	50	20	2	009100534
1/4	1/4	18,5	50	20	2	009100535
5/16	5/16	18,5	50	20	2	009100536
3/8	3/8	18,5	50	20	2	009100537

910PT

chiavi a bussola a giravite per viti con impronta pentalobata

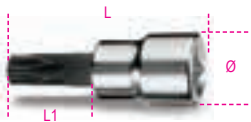

	Ø mm	L mm	L1 mm		
PT40	20	50	20	3	009100540
PT45	20	50	20	3	009100545
PT50	20	50	20	3	009100550



910PT/SB8	1	009100558
PT10-PT15-PT20-PT25		
PT30-PT40-PT45-PT50		

910TX

chiavi a bussola maschio per viti con impronta Torx®



	Ø mm	L mm	L1 mm		
T15	18,5	50	20	5	009100519
T20	18,5	50	20	5	009100520
T25	18,5	50	20	5	009100521
T27	18,5	50	20	5	009100522
T30	18,5	50	20	5	009100523
T40	18,5	50	20	5	009100524
T45	18,5	50	20	3	009100525
T50	18,5	50	20	3	009100526



910TX/SB6	1	009100530
T15-T20-T25		
T27-T30-T40		

910XZN

chiavi a bussola maschio a profilo XZN®



	L mm		
M4	50	3	009100559
M5	50	3	009100560
M6	50	3	009100561
M8	50	3	009100563
M10	50	3	009100565

910CF

chiavi a zampa di gallo



mm	A mm	L mm		
10	21,3	32,3	2	009100135
11	23,1	34,3	2	009100136
12	25,5	36,2	2	009100137
13	26,9	37,4	2	009100138
14	30,2	40,0	2	009100139
15	33,3	41,3	2	009100140
16	33,3	41,3	2	009100141
17	38,1	46,5	2	009100142
18	38,1	46,5	2	009100143
19	39,6	48,0	2	009100144



910CF/SB10	1	009100147
10-11-12-13-14-15		
16-17-18-19 mm		

910/15

raccordo con attacco quadro femmina 3/8" e maschio 1/4"



UNI/ISO 3316 DIN 3123

L mm	Ø mm	□	■		
30	17,0	3/8	1/4	5	009100810



E' assolutamente necessario commisurare la coppia di serraggio alla capacità del quadro maschio per evitare rotture o danni accidentali

910/16

raccordo con attacco quadro femmina 3/8" e maschio 1/2"



UNI/ISO 3316 DIN 3123

L mm	Ø mm	□	■		
32	18,0	3/8	1/2	5	009100814



910/20 - 910/21 - 910/22

prolunghe con attacchi quadri maschio e femmina 3/8"



UNI/ISO 3316 DIN 3123

	L mm	Ø mm		
910/20	75	17	5	009100820
910/21	125	17	5	009100822
910/22	250	17	5	009100826

910AN

prolunghe con attacchi quadri maschio e femmina 3/8" angolari

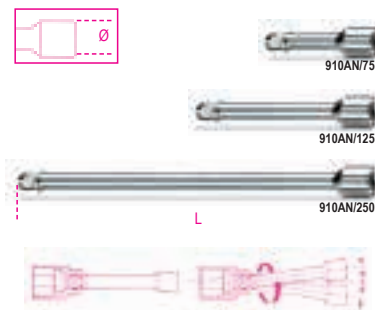

	L mm	Ø mm		
910AN/75	75	17	3	009100827
910AN/125	125	17	3	009100828
910AN/250	250	17	3	009100829

910/25

snodo con attacchi quadri maschio e femmina 3/8"



UNI/ISO 3316 DIN 3123

L mm	Ø mm		
54,6	19	5	009100830

910M/35

quadro maschio 3/8" snodato con impugnatura in metallo



UNI/ISO 3315 DIN 3122

L mm			
250	3	009100839	

910/36A

quadro maschio 3/8" snodato con impugnatura



UNI/ISO 3315 DIN 3122

L mm 255
L1 mm 154

3 009100845

910/40

quadro maschio 3/8" snodato a T



L mm 420
L1 mm 175

3 009100850

910/42

quadro maschio 3/8" con spina scorrevole

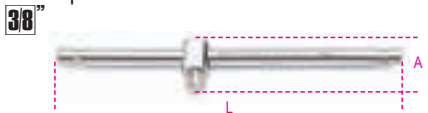

UNI/ISO 3315 DIN 3122

L mm 210
A mm 30,5

5 009100854

910/46

quadro maschio 3/8" con manovella

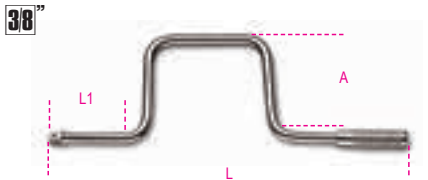

UNI/ISO 3315 DIN 3122

L mm 315
L1 mm 80
A mm 115

1 009100862

910/55

cricchetto reversibile con attacco quadro maschio 3/8" meccanismo a 72 denti



UNI/ISO 3315 DIN 3122

L mm 200
Ø mm 30
A mm 33

3 009100882

910/55Q

cricchetto reversibile con attacco quadro maschio 3/8" meccanismo a 48 denti



UNI/ISO 3315 DIN 3122

L mm 200
Ø mm 30
A mm 33

3 009100885

Meccanismi rotanti di ricambio dei cricchetti, vedi tabella dopo l'art. 929/C8

910M/55

cricchetto reversibile con attacco quadro maschio 3/8" con impugnatura in metallo



DIN 3122 - UNI ISO 3315

L mm 178
Ø mm 30
A mm 26

2 009100875

910M/56

cricchetto reversibile snodato con attacco quadro maschio 3/8" con impugnatura in metallo



L mm 265
Ø mm 31
A mm 29

2 009100887

910/58

cricchetto reversibile con impugnatura rotante con attacco quadro maschio 3/8" meccanismo a 52 denti

- Pulsante di rilascio della bussola
- Sistema di inversione a ghiera sulla testa del cricchetto
- Impugnatura bimateriale



L mm 222
Ø mm 37
A mm 38,5

1 009100884

910.../C10

10 chiavi a bussola e 2 accessori



910A/C10

1 009100909

- 910A 6 - 7 - 8 - 10 - 11 - 12
13 - 14 - 17 - 19 mm
- 910/21 125 mm
- 910/55
- 270x120x45 mm - 1,3 kg

910B/C10

1 009100910

- 910B 6 - 7 - 8 - 10 - 11 - 12
13 - 14 - 17 - 19 mm
- 910/21 125 mm
- 910/55
- 270x120x45 mm - 1,3 kg

910A/C16...

16 chiavi a bussola esagonali e 5 accessori



910A/C16

1 009100936

- 910A 6 - 7 - 8 - 9 - 10 - 11 - 12 - 13
14 - 15 - 16 - 17 - 18 - 19
21 - 22 mm
- 910/21 125 mm
- 910/22 250 mm
- 910/25
- 910/42
- 910/55
- 335x145x60 mm - 2,3 kg

9899 910C16

termoformato vuoto

1 098990134

910A/C16Q

1 009100932

- 910A 6 - 7 - 8 - 9 - 10 - 11 - 12 - 13
14 - 15 - 16 - 17 - 18 - 19
21 - 22 mm
- 910/21 125 mm
- 910/22 250 mm
- 910/25
- 910/42
- 910/55Q
- 335x145x60 mm - 2,3 kg

9899 910C16

termoformato vuoto

1 098990134

910B/C16...

16 chiavi a bussola poligonali e 5 accessori

38



910B/C16 1 009100937

	○ 910B	6 - 7 - 8 - 9 - 10 - 11 - 12 - 13 14 - 15 - 16 - 17 - 18 - 19 21 - 22 mm
	910/21	125 mm
	910/22	250 mm
	910/25	
	910/42	
	910/55	
335x145x60 mm - 2,3 kg		

9899 910C16 1 098990134
termoformato vuoto

910B/C16Q 1 009100933

	○ 910B	6 - 7 - 8 - 9 - 10 - 11 - 12 - 13 14 - 15 - 16 - 17 - 18 - 19 21 - 22 mm
	910/21	125 mm
	910/22	250 mm
	910/25	
	910/42	
	910/55Q	
335x145x60 mm - 2,3 kg		

9899 910C16 1 098990134
termoformato vuoto

910A/C17

17 chiavi a bussola esagonali e 9 accessori

38



910A/C17 1 009100938

	○ 910A	6 - 7 - 8 - 9 - 10 - 11 - 12 - 13 14 - 15 - 16 - 17 - 18 - 19 - 20 21 - 22 mm
	910/15	□ 3/8 - ■ 1/4
	910/16	□ 3/8 - ■ 1/2
	910/21	125 mm
	910/22	250 mm
	910/25	
	910/36A	
	910/42	
	910/46	
	910/55	
420x280x60 mm - 4,0 kg		

910.../C29

17 chiavi a bussola
12 a gravite e 5 accessori

38



910A/C29 1 009100944

	○ 910A	6 - 7 - 8 - 9 - 10 - 11 - 12 - 13 14 - 15 - 16 - 17 - 18 - 19 - 20 21 - 22 mm
	910LP	1x5,5 - 1,2x6,5 - 1,2x8 mm
	910PH	PH1 - PH2 - PH3
	910PE	3 - 4 - 5 - 6 - 8 - 10 mm
	910/21	125 mm
	910/22	250 mm
	910/25	
	910/42	
	910/55	
420x185x60 mm - 3,5 kg		

910B/C29 1 009100945

	○ 910B	6 - 7 - 8 - 9 - 10 - 11 - 12 - 13 14 - 15 - 16 - 17 - 18 - 19 - 20 21 - 22 mm
	910LP	1x5,5 - 1,2x6,5 - 1,2x8 mm
	910PH	PH1 - PH2 - PH3
	910PE	3 - 4 - 5 - 6 - 8 - 10 mm
	910/21	125 mm
	910/22	250 mm
	910/25	
	910/42	
	910/55	
420x185x60 mm - 3,5 kg		

910AS/C13...

13 chiavi a bussola poligonali e 5 accessori

38



910AS/C13 1 009100925

	○ 910AS	1/4 - 5/16 - 11/32 - 3/8 - 7/16 1/2 - 9/16 - 19/32 - 5/8 - 11/16 3/4 - 13/16 - 7/8
	910/21	125 mm
	910/22	250 mm
	910/42	
	910/25	
	910/55	
335x145x60 mm - 2,3 kg		

910AS/MBM-C18

13 chiavi a bussola poligonali e 5 accessori per manutenzioni aeronautiche

38



910AS/MBM-C18 1 009100926

	○ 910AS	1/4 - 5/16 - 11/32 - 3/8 - 7/16 1/2 - 9/16 - 19/32 - 5/8 - 11/16 3/4 - 13/16 - 7/8
	910/21	125 mm
	910/22	250 mm
	910/25	
	910/42	
	910M/55	
335x145x60 mm - 2,5 kg		

910A/C16HR

16 chiavi a bussola esagonali e 5 accessori

• cricchetto con impugnatura rotante

38



910A/C16HR 1 009100935

	○ 910A	6 - 7 - 8 - 9 - 10 - 11 - 12 - 13 14 - 15 - 16 - 17 - 18 - 19 21 - 22 mm
	910/21	125 mm
	910/22	250 mm
	910/25	
	910/42	210 mm
	910/58	
335x145x60 mm - 2,4 kg		



920A

chiavi a bussola a mano
bocca esagonale

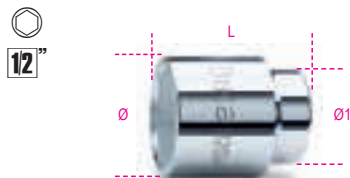

UNI/ISO 2725 DIN 3124

Ø	Ø	L	Ø1		
mm	mm	mm	mm		
8	12,4	38	21,7	10	009200008
9	13,5	38	21,7	10	009200009
10	14,9	38	21,7	10	009200010
11	16,1	38	21,7	10	009200011
12	17,5	38	21,7	10	009200012
13	18,7	38	21,7	10	009200013
14	20,1	38	21,7	10	009200014
15	21,5	38	22,5	10	009200015
16	22,7	38	23,7	10	009200016
17	24,1	38	23,1	10	009200017
18	25,3	39	24,0	10	009200018
19	26,6	39	24,0	10	009200019
20	27,8	40	25,0	5	009200020
21	28,8	40	25,0	5	009200021
22	29,9	41	26,0	5	009200022
23	30,8	42	26,0	5	009200023
24	32,2	43	27,0	5	009200024
25	33,2	44	27,0	5	009200025
26	34,7	45	28,0	5	009200026
27	36,2	46	29,0	5	009200027
28	37,2	47	30,0	5	009200028
29	38,6	48	31,0	5	009200029
30	40,2	48	32,0	5	009200030
32	42,3	49	34,0	5	009200032



920A/SB13
10-11-12-13-14-15-16
17-18-19-20-21-22 mm



920A/SB8
23-24-25-26-27-28-30-32 mm



920MC

chiavi a bussola a mano
bocca esagonale
colorate



Ø	Ø	L	Ø1		
mm	mm	mm	mm		
8	13,2	38	22		5 009202008
10	15,3	38	22		5 009202010
11	16,5	38	22		5 009202011
12	17,8	38	22		5 009202012
13	19,0	38	22		5 009202013
14	20,3	38	22		5 009202014
15	21,6	38	22		5 009202015
16	23,0	38	23		5 009202016
17	23,9	38	24		5 009202017
18	25,0	38	25		5 009202018
19	26,5	38	24		5 009202019
21	28,8	38	27		3 009202021
22	29,9	40	28		3 009202022
24	32,8	40	30		3 009202024

920B

chiavi a bussola a mano
bocca poligonale

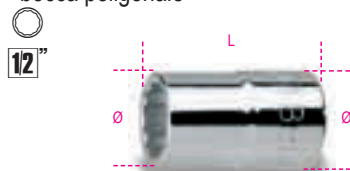

UNI/ISO 2725 DIN 3124

Ø	Ø	L	Ø1		
mm	mm	mm	mm		
8	12,4	38	21,7	10	009200108
9	13,5	38	21,7	10	009200109
10	14,9	38	21,7	10	009200110
11	16,1	38	21,7	10	009200111
12	17,5	38	21,7	10	009200112
13	18,7	38	21,7	10	009200113
14	20,1	38	21,7	10	009200114
15	21,5	38	22,5	10	009200115
16	22,7	38	23,7	10	009200116
17	24,1	38	23,1	10	009200117
18	25,3	39	24,0	10	009200118
19	26,6	39	24,0	10	009200119
20	27,8	40	25,0	5	009200120
21	28,8	40	25,0	5	009200121
22	29,9	41	26,0	5	009200122
23	30,8	42	26,0	5	009200123
24	32,2	43	27,0	5	009200124
25	33,2	44	27,0	5	009200125
26	34,7	45	28,0	5	009200126
27	36,2	46	29,0	5	009200127
28	37,2	47	30,0	5	009200128
29	38,6	48	31,0	5	009200129
30	40,2	48	32,0	5	009200130
32	42,3	49	33,9	5	009200132



920B/SB13
10-11-12-13-14-15-16
17-18-19-20-21-22 mm



920B/SB8
23-24-25-26-27
28-30-32 mm

920AL

chiavi a bussola a mano lunghe
bocca esagonale



UNI/ISO 2725 DIN 3124

Ø	Ø	L	Ø1		
mm	mm	mm	mm		
10	14,7	77	21	5	009200626
12	17,8	77	21	5	009200627
13	19,0	77	22	5	009200628
14	20,3	77	22	5	009200629
15	21,5	77	22	5	009200630
16	22,8	77	22	5	009200631
17	24,0	77	23	5	009200632
18	25,0	77	24	5	009200633
19	26,5	77	25	5	009200634
21	29,0	77	27	5	009200635
22	30,0	77	28	5	009200636
23	31,5	77	29	5	009200637
24	32,8	77	30	5	009200638
27	36,5	77	33	3	009200639
30	40,0	77	36	3	009200640
32	42,8	77	38	3	009200641
36	48,0	77	41	3	009200642



920AL/SB11
10-12-13-14-15-16
17-18-19-21-22 mm

920BL

chiavi a bussola a mano lunghe
bocca poligonale

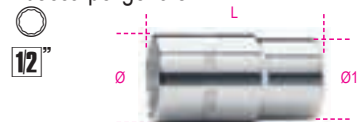

UNI/ISO 2725 DIN 3124

Ø	Ø	L	Ø1		
mm	mm	mm	mm		
10	14,7	77	21	5	009200310
12	17,8	77	21	5	009200312
13	19,0	77	22	5	009200313
14	20,3	77	22	5	009200314
15	21,5	77	22	5	009200315
16	22,8	77	22	5	009200316
17	24,0	77	23	5	009200317
18	25,0	77	24	5	009200318
19	26,5	77	25	5	009200319
21	29,0	77	27	5	009200321
22	30,0	77	28	5	009200322
23	31,5	77	29	5	009200323
24	32,8	77	30	5	009200324
27	36,5	77	33	3	009200327
30	40,0	77	36	3	009200330
32	42,8	77	38	3	009200332
36	48,0	77	41	3	009200336



920BL/SB11
10-12-13-14-15-16-17-18
19-21-22 mm

920A/AS

chiavi a bussola a mano
bocca esagonale

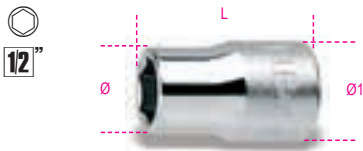

"	Ø mm	L mm	Ø1 mm		
3/8	14,6	37	21	2	009200270
7/16	16,5	37	21	3	009200272
1/2	19,0	37	22	3	009200273
9/16	20,3	37	22	3	009200274
19/32	21,0	37	22	3	009200275
5/8	22,8	37	22	3	009200276
11/16	25,0	37	24	3	009200277
3/4	26,5	38	25	3	009200279
25/32	28,0	38	26	3	009200280
13/16	29,0	38	27	3	009200281
7/8	30,0	40	28	3	009200282
15/16	32,8	42	30	3	009200284
1	35,0	42	32	3	009200285
1.1/16	36,5	43	33	2	009200287
1.1/8	39,0	43	35	2	009200289
1.3/16	41,0	46	36	2	009200290
1.1/4	42,8	46	38	2	009200292



920A-AS/SB11
3/8-7/16-1/2-9/16-5/8
11/16-3/4-13/16-7/8
15/16-1

920AS

chiavi a bussola a mano
bocca poligonale

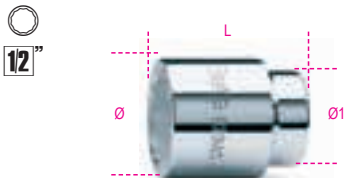

"	Ø mm	L mm	Ø1 mm		
3/8	14,9	38	21,7	3	009200201
7/16	16,1	38	21,7	3	009200202
1/2	18,7	38	21,7	3	009200203
9/16	20,1	38	21,7	3	009200204
5/8	22,7	38	22,5	3	009200206
19/32	21,5	38	23,7	3	009200207
11/16	25,3	39	24,0	3	009200208
3/4	26,6	39	24,0	3	009200209
25/32	27,8	40	25,0	3	009200210
13/16	28,8	40	25,0	3	009200211
7/8	29,9	41	26,0	3	009200212
15/16	32,2	43	27,0	3	009200214
1	34,2	45	28,0	3	009200216
1.1/16	36,2	46	29,0	2	009200217
1.1/8	38,6	48	31,0	2	009200218
1.3/16	40,2	48	32,0	2	009200219
1.1/4	42,3	49	33,5	2	009200220



920AS/SB11
3/8-7/16-1/2-9/16-5/8
11/16-3/4-13/16-7/8
15/16-1

920AS/L

chiavi a bussola a mano lunghe
bocca poligonale



"	Ø mm	L mm	Ø1 mm		
1/2	19,0	77	22	2	009200352
9/16	20,3	77	22	2	009200353
5/8	22,8	77	22	2	009200355
11/16	25,0	77	24	2	009200357
3/4	26,5	77	25	2	009200358
13/16	29,0	77	27	2	009200360
7/8	30,0	77	28	2	009200361
15/16	32,8	77	30	2	009200362
1	35,0	77	32	2	009200363
1.1/16	36,5	77	33,0	2	009200364
1.1/8	37,8	77	34	2	009200365



920ASL/SB11
1/2-9/16-5/8-11/16
3/4-13/16-7/8-15/16
1-1.1/8-1.1/16

920U

chiavi a bussola a mano
bocca multimponta



mm	"	Ø	M	L mm		
10	3/8	E12	M12	38	5	009201710
11	7/16	E14	M14	38	5	009201711
12	15/32	E16		38	5	009201712
13	1/2		M16	38	5	009201713
14	9/16	E18	M18	38	5	009201714
15	19/32			38	5	009201715
16	5/8	E20		38	5	009201716
17				38	5	009201717
18		E22		38	5	009201718
19	3/4	E24		38	5	009201719
20	25/32			38	3	009201720
21				38	3	009201721
22	7/8			38	3	009201722
24	15/16			38	3	009201724
27	1.1/16			42	3	009201727
30	1.1/8			44	3	009201730
32	1.1/4			44	3	009201732



920U/SB13
10-11-12-13-14-15-16
17-18-19-20-21-22 mm



920U/SB4
24-27-30-32 mm

920FTX

chiavi a bussola a mano per viticon testa a
profilo Torx®

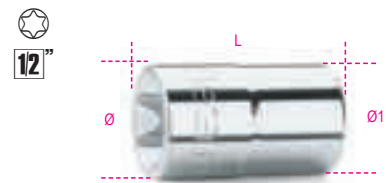

"	Ø mm	L mm	Ø1 mm		
E10	13,2	36	21	5	009200380
E12	15,0	37	21	5	009200381
E14	16,3	37	21	5	009200382
E16	18,8	37	22	5	009200383
E18	20,4	37	22	5	009200384
E20	22,9	37	22	5	009200385
E22	25,0	37	24	3	009200387
E24	26,5	40	25	3	009200388



920FTX/SB6
E10-E12-E14
E16-E18-E20



920FTX/C8
E10-E12-E14-E16
E18-E20-E22-E24
270X120X45 mm - 1 kg

920FTX/L

chiavi a bussola a mano lunghe
per viti con testa a profilo Torx®



"	Ø mm	L mm	Ø1 mm		
E10	13,2	77	21,0	5	009200400
E12	15,0	77	21,0	5	009200401
E14	16,3	77	21,0	5	009200402
E16	18,8	77	21,8	3	009200403
E18	20,4	77	21,8	3	009200404
E20	22,9	77	22,0	3	009200405



920FTX-LSB6
E10-E12-E14
E16-E18-E20

920LP

chiavi a bussola a giravite per viti con intaglio



SxA	Ø	L	L1		
mm	mm	mm	mm		
1x5,5	22,5	62	24	3	009200452
1,2x6,5	22,5	62	24	3	009200453
1,2x8	22,5	62	24	3	009200454
1,6x9	22,5	62	24	3	009200456
2x12	22,5	62	24	3	009200458

920PH

chiavi a bussola a giravite per viti con impronta a croce Phillips®



PH	Ø	L	L1		
	mm	mm	mm		
1	22,5	56	18	3	009200471
2	22,5	56	18	3	009200472
3	22,5	56	18	3	009200473
4	22,5	56	18	3	009200474



920PH/SB4
PH1-PH2-PH3-PH4 1 009200479

920LH/SB7

chiavi a bussola a giravite per viti con impronta a croce Phillips®



920LH/SB7 1 009200478

920LP	1,2x6,5 - 1,2x8
920PH	1,6x9 - 2x12 mm
	PH2 - PH3 - PH4

920PE

chiavi a bussola maschio esagonale

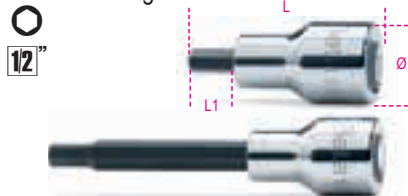

DIN 7422

mm	Ø	L	L1		
mm	mm	mm	mm		
3	22,5	58	20	5	009200410
4	22,5	58	20	5	009200412
5	22,5	58	20	5	009200414

mm	Ø	L	L1		
mm	mm	mm	mm		
5L	22,5	100	62	5	009200415
6	22,5	58	20	5	009200417
6L	22,5	100	62	5	009200418
7	22,5	58	20	5	009200420
7L	22,5	100	62	5	009200421
8	22,5	58	20	5	009200423
8L	22,5	100	62	5	009200424
9	22,5	58	20	5	009200425
9L	22,5	140	102	5	009200426
10	22,5	58	20	5	009200428
10L	22,5	140	102	5	009200429
12	23,0	58	20	5	009200432
12L	22,5	140	102	5	009200433
14	23,0	58	20	5	009200434
14L	22,5	140	102	5	009200435
17	29,5	60	22	5	009200437
19	29,5	60	22	5	009200439



920PE/SB9
4-5-6-8-10 mm
5L-6L-8L-10L mm 1 009200441



920PE/C10
4-5-6-7-8-10
12-14-17-19 mm 1 009200443

270X120X45 mm - 1,5 kg

9899 920PE/C10
termoformato vuoto 1 098990135

920PE/AS

chiavi a bussola maschio esagonale



"	Ø	L	L1		
mm	mm	mm	mm		
1/8	22,5	58	20	2	009200460
3/16	22,5	58	20	2	009200461
1/4	22,5	58	20	2	009200463
3/8	22,5	58	20	2	009200464
1/2	22,5	60	20	2	009200465
3/4	22,5	60	20	1	009200468



920PE/AS/SB6
1/8-3/16-1/4-3/8-1/2-3/4 1 009200469

920BP

chiavi a bussola maschio esagonale con estremità sferica

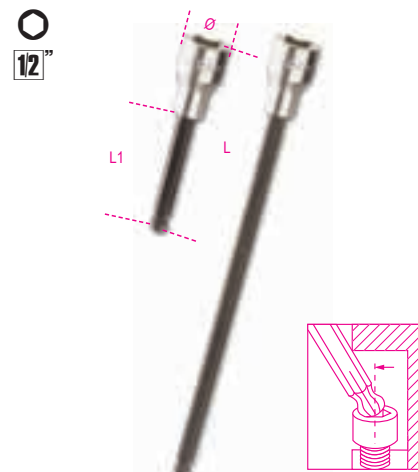

mm	Ø	L	L1		
mm	mm	mm	mm		
5L	22,5	100	62	5	009200490
5XL	22,5	240	202	1	009200495
6L	22,5	100	62	5	009200491
6XL	22,5	240	202	1	009200496
7L	22,5	100	62	5	009200492
8L	22,5	100	62	5	009200493
8XL	22,5	240	202	1	009200497
10L	22,5	140	102	5	009200494



920BP/SB8
5L-6L-7L-8L-10L mm
5XL-6XL-8XL mm 1 009200500

920ME

chiavi a bussola maschio esagonale



mm	Ø	L	L1		
mm	mm	mm	mm		
5	21	75	15,5	5	009200505
6	21	75	15,5	5	009200506
7	21	75	15,5	5	009200507
8	21	75	15,5	5	009200508
10	23	75	15,5	5	009200510
12	24	75	15,5	5	009200512
14	24	75	15,5	5	009200514
17	24	75	15,5	5	009200517



920ME/SB7
5-6-8-10-12-14-17 mm 1 009200519

12"



920ME/C7
5-6-8-10-12-14-17 mm
1 009200518
250X100X35 mm - 1,4 kg

920TX
chiavi a bussola maschio
per viti con impronta Torx®

12"



	Ø mm	L mm	L1 mm	
T20	22,5	58	20	5 009200520
T20L	22,5	120	82	3 009200530
T25	22,5	58	20	5 009200521
T25L	22,5	120	82	3 009200531
T27	22,5	58	20	5 009200522
T27L	22,5	120	82	3 009200532
T30	22,5	58	20	5 009200523
T30L	22,5	120	82	3 009200534
T40	22,5	58	20	5 009200524
T40L	22,5	120	82	3 009200535
T45	22,5	58	20	5 009200525
T45L	22,5	120	82	3 009200537
T50	22,5	58	20	5 009200526
T50L	23,0	140	102	3 009200538
T55	23,0	58	20	3 009200527
T55L	23,0	140	102	3 009200539
T60	23,0	58	20	3 009200528
T60L	23,0	140	102	3 009200540
T70L	23,0	120	82	3 009200541

12"



920TX-SB9
T20-T25-T27-T30
T40-T45-T50-T55-T60
1 009200532



920TX-L/SB10
T20L-T25L-T27L-T30L-T40L-
T45L-T50L-T55L-T60L-T70L
1 009200545

12"



920TX/C9
T20-T25-T27-T30-T40
T45-T50-T55-T60
1 009200546
270X120X45 mm - 1,2 kg

9899 920TX/C9
termoformato vuoto
1 098990136

920RTX

chiavi a bussola maschio per viti
con impronta Tamper Resistant Torx®

12"



	Ø mm	L mm	L1 mm	
T20	22,5	58	20	5 009200370
T25	22,5	58	20	5 009200371
T27	22,5	58	20	5 009200372
T30	22,5	58	20	5 009200373
T40	22,5	58	20	5 009200374

12"



920RTX/SB5
T20-T25-T27-T30-T40
1 009200378

920XZN

chiavi a bussola maschio
a profilo XZN®

12"

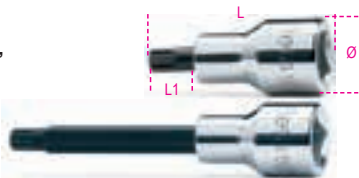

DIN 2324

	Ø mm	L mm	L1 mm	
M4	22,5	58	20	3 009200559
M5	22,5	58	20	3 009200560
M6	22,5	58	20	3 009200561
M6L	22,5	100	62	3 009200562
M8	22,5	58	20	3 009200563
M8L	22,5	100	62	3 009200564
M9	22,5	58	20	3 009200582
M9L	22,5	100	62	3 009200583
M10	22,5	58	20	3 009200565
M10L	22,5	100	62	3 009200566
M12	22,5	58	20	3 009200568
M12L	22,5	100	62	3 009200569
M14	23,0	58	20	3 009200571
M14L	23,0	100	62	3 009200572
M16	23,0	58	20	3 009200573
M18	23,0	58	20	3 009200574

12"



920XZN/SB7
M4-M5-M6-M8
M10-M12-M14
1 009200579

12"



920XZN/SB12
M5-M6-M8-M10-M12
M14-M16-M6L-M8L
M10L-M12L-M14L
1 009200577

12"



920XZN-L/S5
M6L-M8L-M10L
M12L-M14L
1 009200578

920ES

chiavi a bussola per viti
con impronta esascalanata

12"



UNI 9326

Ø mm		L mm	L1 mm	
7	(6R)	58	20	5 009200587
7XL	(6R)	240	202	1 009200607
9	(8R)	58	20	5 009200589
9XL	(8R)	240	202	1 009200609
10	(8S)	58	20	5 009200590
10XL	(8S)	240	202	1 009200610
11	(10R)	58	20	5 009200591
11XL	(10R)	240	202	1 009200611
12L	(10S)	100	62	3 009200592
12XL	(10S)	240	202	1 009200612
14L	(12S)	100	62	3 009200594
14XL	(12S)	240	202	1 009200614
16L	(14R)	100	62	3 009200596
16XL	(14R)	240	202	1 009200616

12"



920ES/SB7
7-9-10-11-12L-14L-16L
1 009200598

12"



920ES-XL/SB7
7XL-9XL-10XL-11XL
12XL-14XL-16XL
1 009200618

PM 1/2-Q5

12"



PM 1/2-Q5 72,519

920/15

raccordo con attacco quadro femmina 1/2" e maschio 3/8"

12"



UNI/ISO 3316 DIN 3123

L	□	■	Ø		
mm	1/2	3/8	mm	5	009200810
42			22,0		



E' assolutamente necessario commisurare la coppia di serraggio alla capacità del quadro maschio per evitare rotture o danni accidentali

920/16

raccordo con attacco quadro femmina 1/2" e maschio 3/4"

12"



UNI/ISO 3316 DIN 3123

L	□	■	Ø		
mm	1/2	3/4	mm	5	009200814
46			26		

920/20÷920/23

prolunghe con attacchi quadri maschio e femmina 1/2"

12"



UNI/ISO 3316 DIN 3123

	L	Ø		
	mm	mm	5	009200818
920/20	75	22		
920/21	125	22		5 009200822
920/22	255	22		5 009200826
920/23	375	22		2 009200827

920AN

prolunghe con attacchi quadri maschio e femmina 1/2" angolari

12"

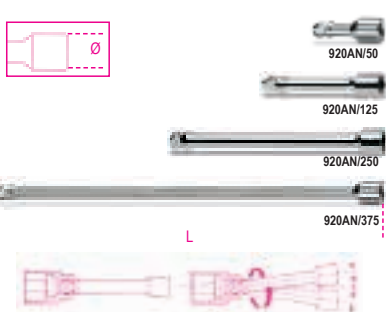

	L	Ø		
	mm	mm	5	009200833
920AN/50	50	22		
920AN/125	125	22		5 009200834
920AN/250	250	22		3 009200835
920AN/375	375	22		3 009200836

920/25

snodo con attacchi quadri maschio e femmina 1/2"

12"



UNI/ISO 3316 DIN 3123

L	Ø		
mm	mm	5	009200830
75	27		

920/35A

quadro maschio 1/2" snodato con impugnatura

12"

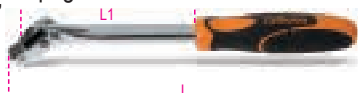

UNI/ISO 3315 DIN 3122

L	L1		
mm	mm	3	009200846
285	160		

920M/35

quadro maschio 1/2" snodato con impugnatura in metallo

12"



UNI/ISO 3315 DIN 3122

L			
mm	2	009200845	
380			

920M/35L

quadro maschio 1/2" snodato con impugnatura in metallo, lungo

12"

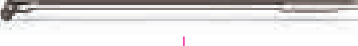

UNI/ISO 3315 DIN 3122

L			
mm	1	009200843	
600			



È assolutamente necessario applicare il carico di torsione adeguatamente e progressivamente per evitare rotture o danni accidentali.

920/36A

quadro maschio 1/2" snodato con impugnatura

12"



UNI/ISO 3315 DIN 3122

L	L1		
mm	mm	2	009200847
408	283		

920/38

quadro maschio estensibile 1/2" snodato con impugnatura

12"



L	L max		
mm	mm	1	009200839
262	402		

920/40

quadro maschio 1/2" snodato a T

12"



L	L1		
mm	mm	2	009200850
490	230		

920/42

quadro maschio 1/2" con spina scorrevole

12"

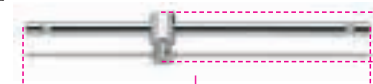

UNI/ISO 3315 DIN 3122

L	A		
mm	mm	5	009200854
305	42		

920/44

quadro maschio 1/2" ad angolo

12"



UNI/ISO 3315 DIN 3122

L	L1		
mm	mm	3	009200858
230	60		

920/46

quadro maschio 1/2" con manovella

12"



UNI/ISO 3315 DIN 3122

L	L1	A		
mm	mm	mm	1	009200862
385	110	160		

920/50

cricchetto semplice
con attacco quadro scorrevole 1/2"
meccanismo a 72 denti



UNI/ISO 3315 DIN 3122

L	Ø	A	
mm	mm	mm	
275	40	42	3 009200871

920/50F

cricchetto semplice
con attacco quadro femmina 1/2"
meccanismo a 72 denti



UNI/ISO 3315 DIN 3122

L	Ø	A	
mm	mm	mm	
275	40	27	2 009200889

920/55

cricchetto reversibile
con attacco quadro maschio 1/2"
meccanismo a 72 denti



UNI/ISO 3315 DIN 3122

L	Ø	A	
mm	mm	mm	
275	40	43	3 009200882

920/55Q

cricchetto reversibile
con attacco quadro maschio 1/2"
meccanismo a 48 denti



UNI/ISO 3315 DIN 3122

L	Ø	A	
mm	mm	mm	
275	40	43	3 009200885

920/55X

cricchetto reversibile
con attacco quadro maschio 1/2"
meccanismo a 72 denti



UNI/ISO 3315 DIN 3122

L	Ø	A	
mm	mm	mm	
200	30	33	3 009200895

920/55LC

cricchetto reversibile
con attacco quadro maschio 1/2"
"Locking System"
meccanismo a 72 denti



UNI/ISO 3315 DIN 3122

L	Ø	A	
mm	mm	mm	
275	40	43	2 009200896

920M/55

cricchetto reversibile
con attacco quadro maschio 1/2"
con impugnatura in metallo



L	Ø	A	
mm	mm	mm	
253	38	35	1 009200893

920/56A

cricchetto reversibile snodato
con attacco quadro maschio 1/2"
meccanismo a 72 denti



L	Ø	A	
mm	mm	mm	
315	40	43	1 009200911

920M/56

cricchetto reversibile snodato
con attacco quadro maschio 1/2"
con impugnatura in metallo



L	Ø	A	
mm	mm	mm	
330	38	35,7	2 009200894

920/58

cricchetto reversibile
con impugnatura rotante
con attacco quadro maschio 1/2"
meccanismo a 52 denti

- Pulsante di rilascio della bussola
- Sistema di inversione a ghiera sulla testa del cricchetto
- Impugnatura bimatériale

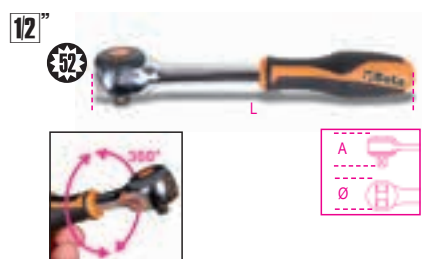

L	Ø	A	
mm	mm	mm	
281	42,5	45	1 009200926

Meccanismi rotanti
di ricambio dei cricchetti,
vedi tabella dopo l'art. 929/C8



920.../C11

11 chiavi a bussola e 2 accessori

12"



920A/C11

1 009200921

- 920A 10 - 12 - 13 - 14 - 15 - 16
17 - 18 - 19 - 21 - 22 mm
 - 920/22 255 mm
 - 920/50
- 420x145x60 mm - 2,5 kg

920B/C11

1 009200922

- 920B 10 - 12 - 13 - 14 - 15 - 16
17 - 18 - 19 - 21 - 22 mm
 - 920/22 255 mm
 - 920/50
- 420x145x60 mm - 2,5 kg

920.../C12...

12 chiavi a bussola e 5 accessori

12"



920A/C12X

1 009200933

- 920A 10 - 11 - 12 - 13 - 14 - 17 - 19
22 - 24 - 27 - 30 - 32 mm
 - 920/21 125 mm
 - 920/22 255 mm
 - 920/25
 - 920/42
 - 920/55
- 420x185x60 mm - 4,2 kg

9899 920C12

1 098990116

termoformato vuoto

920A/C12

1 009200931

- 920A 10 - 11 - 12 - 13 - 14 - 17 - 19
22 - 24 - 27 - 30 - 32 mm
 - 920/21 125 mm
 - 920/22 255 mm
 - 920/25
 - 920/42
 - 920/50
- 420x185x60 mm - 4,2 kg

9899 920C12

1 098990116

termoformato vuoto

920B/C12X

1 009200934

- 920B 10 - 11 - 12 - 13 - 14 - 17 - 19
22 - 24 - 27 - 30 - 32 mm
 - 920/21 125 mm
 - 920/22 255 mm
 - 920/25
 - 920/42
 - 920/55
- 420x185x60 mm - 4,0 kg

9899 920C12

1 098990116

termoformato vuoto

920B/C12

1 009200932

- 920B 10 - 11 - 12 - 13 - 14 - 17 - 19
22 - 24 - 27 - 30 - 32 mm
 - 920/21 125 mm
 - 920/22 255 mm
 - 920/25
 - 920/42
 - 920/50
- 420x185x60 mm - 4,0 kg

9899 920C12

1 098990116

termoformato vuoto

920MC/C14

14 chiavi a bussola esagonali colorate e 5 accessori

12"



920MC/C14

1 009202964

- 920MC 8 - 10 - 11 - 12 - 13 - 14 - 15 - 16 - 17
- 18 - 19 - 21 - 22 - 24 mm
 - 920/21 125 mm
 - 920/22 255 mm
 - 920/25
 - 920/42
 - 920/55
- 420x185x60 mm - 4,2 kg

920.../C20...

20 chiavi a bussola e 5 accessori

12"



920A/C20X

1 009200950

- 920A 10 - 11 - 12 - 13 - 14 - 15 - 16
17 - 18 - 19 - 20 - 21 - 22 - 23
24 - 26 - 27 - 28 - 30 - 32 mm
 - 920/21 125 mm
 - 920/22 255 mm
 - 920/25
 - 920/42
 - 920/55
- 420x185x60 mm - 5,1 kg

9899 920C20

1 098990121

termoformato vuoto

920A/C20

1 009200948

- 920A 10 - 11 - 12 - 13 - 14 - 15 - 16
17 - 18 - 19 - 20 - 21 - 22 - 23
24 - 26 - 27 - 28 - 30 - 32 mm
 - 920/21 125 mm
 - 920/22 255 mm
 - 920/25
 - 920/42
 - 920/50
- 420x185x60 mm - 5,1 kg

9899 920C20

1 098990121

termoformato vuoto

920A/C20Q

1 009200955

- 920A 10 - 11 - 12 - 13 - 14 - 15 - 16
17 - 18 - 19 - 20 - 21 - 22 - 23
24 - 26 - 27 - 28 - 30 - 32 mm
 - 920/21 125 mm
 - 920/22 255 mm
 - 920/25
 - 920/42
 - 920/55Q
- 420x185x60 mm - 5,1 kg

9899 920C20

1 098990121

termoformato vuoto

920B/C20

1 009200949

- 920B 10 - 11 - 12 - 13 - 14 - 15 - 16
17 - 18 - 19 - 20 - 21 - 22 - 23
24 - 26 - 27 - 28 - 30 - 32 mm
 - 920/21 125 mm
 - 920/22 255 mm
 - 920/25
 - 920/42
 - 920/50
- 420x185x60 mm - 5,0 kg

9899 920C20

1 098990121

termoformato vuoto



920B/C20X 1 009200951

- 920B 10 - 11 - 12 - 13 - 14 - 15 - 16
17 - 18 - 19 - 20 - 21 - 22 - 23
24 - 26 - 27 - 28 - 30 - 32 mm
 - 920/21 125 mm
 - 920/22 255 mm
 - 920/25
 - 920/42
 - 920/55
- 420x185x60 mm - 5,0 kg

9899 920C20 1 098990121
termoformato vuoto

920.../C21...

21 chiavi a bussola
e 6 accessori

12"



920A/C21 1 009200952

- 920A 10 - 11 - 12 - 13 - 14 - 15 - 16
17 - 18 - 19 - 20 - 21 - 22 - 23
24 - 25 - 26 - 27 - 28 - 30 - 32 mm
 - 920/21 125 mm
 - 920/22 255 mm
 - 920/25
 - 920/42
 - 920/46
 - 920/50
- 420x280x60 mm - 6,5 kg

920A/C21X 1 009200983

- 920A 10 - 11 - 12 - 13 - 14 - 15 - 16
17 - 18 - 19 - 20 - 21 - 22 - 23
24 - 25 - 26 - 27 - 28 - 30 - 32 mm
 - 920/21 125 mm
 - 920/22 255 mm
 - 920/25
 - 920/42
 - 920/46
 - 920/55
- 420x280x60 mm - 6,4 kg

920B/C21 1 009200953

- 920B 10 - 11 - 12 - 13 - 14 - 15 - 16
17 - 18 - 19 - 20 - 21 - 22 - 23
24 - 25 - 26 - 27 - 28 - 30 - 32 mm
 - 920/21 125 mm
 - 920/22 255 mm
 - 920/25
 - 920/42
 - 920/46
 - 920/50
- 420x280x60 mm - 6,4 kg

920B/C21X 1 009200984

- 920B 10 - 11 - 12 - 13 - 14 - 15 - 16
17 - 18 - 19 - 20 - 21 - 22 - 23
24 - 25 - 26 - 27 - 28 - 30 - 32 mm
 - 920/21 125 mm
 - 920/22 255 mm
 - 920/25
 - 920/42
 - 920/46
 - 920/55
- 420x280x60 mm - 6,4 kg

920B/C30Q

30 chiavi a bussola poligonali
e 5 accessori

12"



920B/C30Q 1 009200975

- 920B 8 - 9 - 10 - 11 - 12 - 13 - 14
15 - 16 - 17 - 18 - 19 - 20 - 21
22 - 23 - 24 - 26 - 27 - 30 mm
 - 920BL 12 - 13 - 14 - 17 - 19 - 21
22 - 24 - 27 - 30 mm
 - 920/21 125 mm
 - 920/22 255 mm
 - 920/25
 - 920/42
 - 920/55Q
- 420x280x60 mm - 7,6 kg



920.../C33

20 chiavi a bussola
13 a giravite e 5 accessori

12"



920A/C33 1 009200985

- 920A 10 - 11 - 12 - 13 - 14 - 15 - 16
17 - 18 - 19 - 20 - 21 - 22 - 23
24 - 26 - 27 - 28 - 30 - 32 mm
 - 920LP 1,2x8 - 1,6x9 - 2x12 mm
 - ⊕ 920PH PH2 - PH3 - PH4
 - 920PE 4 - 5 - 6 - 8 - 10 - 12 - 14 mm
 - 920/21 125 mm
 - 920/22 255 mm
 - 920/25
 - 920/42
 - 920/55
- 420x280x60 mm - 6,7 kg

920B/C33 1 009200986

- 920B 10 - 11 - 12 - 13 - 14 - 15 - 16
17 - 18 - 19 - 20 - 21 - 22 - 23
24 - 26 - 27 - 28 - 30 - 32 mm
 - 920LP 1,2x8 - 1,6x9 - 2x12 mm
 - ⊕ 920PH PH2 - PH3 - PH4
 - 920PE 4 - 5 - 6 - 8 - 10 - 12 - 14 mm
 - 920/21 125 mm
 - 920/22 255 mm
 - 920/25
 - 920/42
 - 920/55
- 420x280x60 mm - 6,7 kg

920A/C17M - 920A/C17MR

assortimento di 17 chiavi a bussola esagonali e 5 accessori in termoformato morbido, in cassetta di lamiera

12"



920A/C17M

1 009200924

	920A	10-11-12-13-14-15-16-17-18-19-20-21-22-24-27-30-32 mm
	920/21	125 mm
	920/22	255 mm
	920/25	
	920/42	305 mm
	920/55	

420x185x60 mm - 5 kg

9899 920C17
modulo soft vuoto

1 098990137

920A/C17MR

1 009200937

	920/21	125 mm
	920/22	255 mm
	920/25	
	920/42	305 mm
	920/58	

420x185x60 mm 5,1 kg

920/C37

37 chiavi a bussola poligonali e 5 accessori

12"



920/C37

1 009200988

	920B	10 - 11 - 12 - 13 - 14 - 15 - 16 17 - 18 - 19 - 20 - 21 - 22 - 23 24 - 26 - 27 - 28 - 30 - 32 mm
	920AS	3/8 - 7/16 - 1/2 - 9/16 - 19/32 5/8 - 11/16 - 3/4 - 25/32 - 13/16 7/8 - 15/16 - 1 - 1.1/16 - 1.1/8 1.3/16 - 1.1/4
	920/21	125 mm
	920/22	255 mm
	920/25	
	920/42	
	920/55	

420x280x60 mm - 7,5 kg

920AS/C10

10 chiavi a bussola poligonali e 2 accessori

12"



920AS/C10

1 009200919

	920AS	3/8 - 7/16 - 1/2 - 9/16 - 5/8 11/16 - 3/4 - 13/16 - 7/8 - 15/16
	920/22	255 mm
	920/50	

335x145x60 mm - 2,6 kg

920AS/C15

15 chiavi a bussola poligonali e 6 accessori

12"



920AS/C15

1 009200947

	920AS	3/8 - 7/16 - 1/2 - 9/16 - 5/8 - 11/16 3/4 - 13/16 - 7/8 - 15/16 - 1 1.1/16 - 1.1/8 - 1.3/16 - 1.1/4
	920/21	125 mm
	920/22	255 mm
	920/25	
	920/42	
	920/46	
	920/50	

420x280x60 mm - 5,9 kg

Beta

920AS/C17X

17 chiavi a bussola poligonali e 5 accessori

12"



920AS/C17X

1 009200942

	920AS	3/8 - 7/16 - 1/2 - 9/16 - 19/32 - 5/8 11/16 - 3/4 - 25/32 - 13/16 - 7/8 15/16 - 1 - 1.1/16 - 1.1/8 - 1.3/16 - 1.1/4
	920/21	125 mm
	920/22	255 mm
	920/25	
	920/42	
	920/55	

420x185x60 mm - 4,8 kg

920AS/MBM-C21

16 chiavi a bussola poligonali e 5 accessori per manutenzioni aeronautiche

12"



920AS/MBM-C21

1 009200944

	920AS	3/8 - 7/16 - 1/2 - 9/16 19/32 - 5/8 - 11/16 - 3/4 25/32 - 13/16 - 7/8 - 15/16 1 - 1.1/16 - 1.3/16 - 1.1/4
	920M/55	
	920/21	125 mm
	920/22	255 mm
	920/25	
	920/42	

420x185x60 mm - 5,0 kg

Beta

920TX/C17

6 inserti per avvitatori
6 chiavi a bussola
5 chiavi a bussola maschio
e 4 accessori, per viti con impronta Torx®

12"



920TX/C17 1 009200989

	861TX	T8 - T10 - T15 - T20 - T25 - T27
	897	
	920TX	T27 - T30 - T40 - T45 - T50
	920FTX	E10 - E12 - E14 - E16 - E18 - E20
	920/20	75 mm
	920/22	255 mm
	920/55	
	420x185x60 mm	- 2,9 kg

920A/C17HR

17 chiavi a bussola esagonali e 5 accessori
in termoformato rigido, in cassetta di lamiera

• cricchetto con impugnatura rotante

12"



920A/C17HR 1 009200939

	920A	10-11-12-13-14-15-16-17-18-19-20-21-22-24-27-30-32 mm
	920/21	125 mm
	920/22	255 mm
	920/25	
	920/42	
	920/58	
	420x185x60 mm	- 5,1 kg

920U/C17M

17 chiavi a bussola multimpronta,
e 5 accessori
in termoformato morbido

12"



920U/C17M 1 009201797

	920U	○ 10-11-12-13-14-15-16-17-18-19-20-21-22-24-27-30-32 mm * 3/8-7/16-15/32-1/2-9/16-19/32-5/8-3/4-25/32-7/8-15/16-1.1/16-1.1/8-1.1/4 ○ M12-M14-M16-M18 ◎ E12-E14-E16-E18-E20-E22-E24
	920/21	125 mm
	920/22	255 mm
	920/25	
	920/42	305 mm
	920/55	275 mm
	420x185x60 mm	- 5 kg

9899 920C17 1 098990137
modulo soft vuoto

928A

chiavi a bussola a mano
bocca esagonale

3/4"



UNI/ISO 2725
DIN 3124

mm	Ø mm	L mm	Ø1 mm	
19	29,2	50	34	5 009280019
21	30,0	51	34	5 009280021
22	31,3	53	34	5 009280022
23	33,3	53	34	5 009280023
24	34,5	53	34	5 009280024
26	36,8	55	35	5 009280026
27	38,0	56	35	5 009280027
28	39,0	57	35	3 009280028
29	40,2	58	35	3 009280029
30	41,5	58	37	3 009280030
32	44,3	60	37	3 009280032
33	45,8	60	37	3 009280033
34	46,8	60	37	3 009280034
35	48,1	62	38	3 009280035
36	49,5	64	38	3 009280036
38	52,0	68	40	3 009280038
41	56,0	71	40	3 009280041
46	62,3	75	43	3 009280046
50	67,4	80	43	3 009280050
55	73,7	84	48	1 009280055
60	80,0	87	48	1 009280060

928B

chiavi a bussola a mano
bocca poligonale

3/4"



UNI/ISO 2725
DIN 3124

mm	Ø mm	L mm	Ø1 mm	
19	29,2	50	34	5 009280119
21	30,0	51	34	5 009280121
22	31,3	53	34	5 009280122
23	33,3	53	34	5 009280123
24	34,5	53	34	5 009280124
26	36,8	55	35	5 009280126
27	38,0	56	35	5 009280127
28	39,0	57	35	3 009280128
29	40,2	58	35	3 009280129
30	41,5	58	37	3 009280130
32	44,3	60	37	3 009280132
33	45,8	60	37	3 009280133
34	46,8	60	37	3 009280134
35	48,1	62	38	3 009280135
36	49,5	64	38	3 009280136
38	52,0	68	40	3 009280138
41	56,0	71	40	3 009280141
46	62,3	75	43	3 009280146
50	67,4	80	43	3 009280150
55	73,7	84	48	1 009280155
60	80,0	87	48	1 009280160

928AS

chiavi a bussola a mano
bocca esagonale

3/4"



mm	Ø mm	L mm	Ø1 mm	
7/8	32,0	53	34	1 009280202
15/16	34,5	53	34	1 009280203
1	36,2	55	35	1 009280204
1.1/16	38,0	56	35	1 009280205
1.1/8	40,2	58	35	1 009280206
1.1/4	44,2	60	37	1 009280208
1.5/16	45,8	60	37	1 009280209
1.3/8	48,1	62	38	1 009280210
1.7/16	49,5	64	38	1 009280211
1.1/2	52,0	68	40	1 009280212
1.5/8	56,0	71	40	1 009280214
1.11/16	58,8	74	40	1 009280215
1.13/16	62,3	75	43	1 009280217
1.7/8	65,0	78	43	1 009280218
2	68,3	80	43	1 009280219
2.1/16	71,5	83	48	1 009280220

928ME

chiavi a bussola
maschio esagonale

3/4"

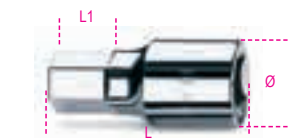

mm	Ø mm	L mm	L1 mm	
14	35	75	15,5	2 009280514
17	35	75	15,5	2 009280517
19	35	75	15,5	2 009280519
22	35	75	22,5	2 009280522

928/15

raccordo con attacco quadro femmina 3/4" e maschio 1/2"



UNI/ISO 3316
DIN 3123

L	Ø	□	■	
mm	mm	mm	mm	
51,5	34	3/4	1/2	5 009280801

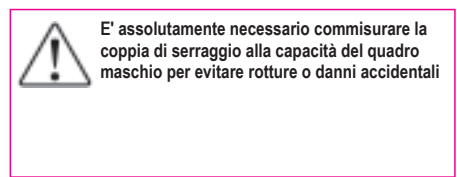

928/16

raccordo con attacco quadro femmina 3/4" e maschio 1"



UNI/ISO 3316
DIN 3123

L	Ø	□	■	
mm	mm	mm	mm	
65	34	3/4	1"	5 009280807

928/20 - 928/21 - 928/22

prolunghe con attacchi quadri maschio e femmina 3/4"

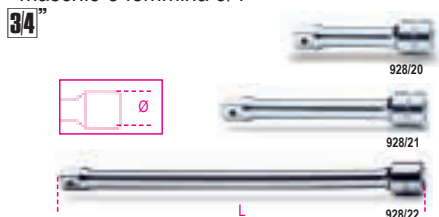

UNI/ISO 3316
DIN 3123

	L	Ø	
	mm	mm	
928/20	100	34	3 009280810
928/21	200	34	3 009280815
928/22	380	34	3 009280825

928/25

snodo con attacchi quadri maschio e femmina 3/4"



UNI/ISO 3316 DIN 3123

L	Ø	
mm	mm	
108	40	1 009280830

928/36A

quadro maschio 3/4" snodato con impugnatura



DIN 3122 - UNI ISO 3315

L	
mm	
545	1 009280844

928/42

quadro maschio 3/4" con spina scorrevole

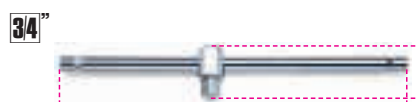

UNI/ISO 3315 DIN 3122

L	A	
mm	mm	
450	62,5	3 009280850

928/55

cricchetto reversibile con attacco quadro maschio 3/4" meccanismo a 72 denti



DIN 3122 - UNI ISO 3315

L	Ø	A	
mm	mm	mm	
510	58	59	2 009280862

Meccanismi rotanti di ricambio dei cricchetti, vedi tabella dopo l'art. 929/C8

928.../C12

12 chiavi a bussola esagonali e 5 accessori in cassetta di lamiera



928A/C12 1 009280955

	Ø	
	mm	
928A	22 - 24 - 27 - 30 - 32 - 34 - 36 38 - 41 - 46 - 50 - 55 mm	
928/21	200 mm	
928/22	380 mm	
928/25		
928/42		
928/55		

530x220x80 mm - 13,5 kg

928B/C12 1 009280957

	Ø	
	mm	
928B	22 - 24 - 27 - 30 - 32 - 34 - 36 38 - 41 - 46 - 50 - 55 mm	
928/21	200 mm	
928/22	380 mm	
928/25		
928/42		
928/55		

530x220x80 mm - 13,5 kg

928AS/C12

12 chiavi a bussola esagonali e 5 accessori in cassetta di lamiera



928AS/C12 1 009280968

	Ø	
	mm	
928AS	7/8-15/16-1.1/16-1.1/8-1.1/4 1.5/16-1.7/16-1.1/2-1.11/16 1.13/16-1.7/8-2.1/16	
928/21	200 mm	
928/22	380 mm	
928/25		
928/42		
928/55		

530x220x80 mm - 13,5 kg

929

chiavi a bussola a mano bocca esagonale



UNI/ISO 2725 DIN 3124

Ø	Ø	L	Ø1	
mm	mm	mm	mm	
36	51	65	48	1 009290036
41	57	70	48	1 009290041
46	65	75	48	1 009290046
50	70	80	48	1 009290050
55	76	85	54	1 009290055
60	82	90	54	1 009290060
65	88	95	54	1 009290065
70	92	100	60	1 009290070
75	99	110	60	1 009290075
80	106	120	60	1 009290080

929/15

raccordo con attacco quadro femmina 1" e maschio 3/4"

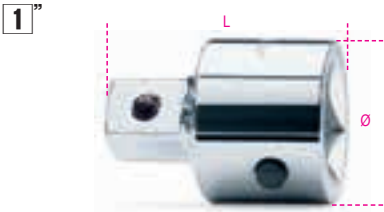

UNI/ISO 3316 DIN 3123

L	Ø			
mm	mm	1"	3/4"	
65	47			2 009290801



E' assolutamente necessario commisurare la coppia di serraggio alla capacità del quadro maschio per evitare rotture o danni accidentali

929/21 - 929/22

prolunghe con attacchi quadri maschio e femmina 1"



UNI/ISO 3316 DIN 3123

	L	Ø	
	mm	mm	
929/21	200	47	1 009290815
929/22	400	47	1 009290825

929/42

quadro maschio 1" con spina scorrevole



UNI/ISO 3315 DIN 3122

L	
mm	
535	1 009290850

929/55

cricchetto reversibile con attacco quadro maschio 1" meccanismo a 72 denti



UNI/ISO 3315 DIN 3122

L	Ø	A
mm	mm	mm
770	62	63

929/55PR

prolunghe per cricchetti 929/55



L	Ø	Ø1
mm	mm	mm
540	32	26

929/C8

8 chiavi a bussola esagonali e 5 accessori



929/C8

1 009290925

	929	46 - 50 - 55 - 60 - 65 70 - 75 - 80 mm
	929/15	□ 1" - ■ 3/4"
	929/21	200 mm
	929/22	400 mm
	929/42	
	929/55	

560x290x120 mm - 29 kg

9899 CV/A

ricambio cassetta vuota



9899 CV/A

1 098990001

583/C31-671B/C5-671B/C10-720ME/C8
860/C38P-861/C61P-900/C11-900AS/C10-/MB-C17
900/C24-900/C13-8-900/C13-5-900MB/C19-900MB/C28
900/C11HR-900AS/C10-/MB-C17-900AS/C17-MBM
900/C11Z-900MC/C24-900MC/C32-910.../C10
971/C8-920TX/C-920PE/C-920FTX/C-910.../C10

270x120x45 mm

9899 CV/B

ricambio cassetta vuota



9899 CV/B

1 098990002

352C/U-720MC/C13-727/C16-867/C20-900/C12MR
900/C12MZ-900U/C12M-910AS/C13...-910AS/MBM-C18
910A/C16...-910B/C16...-910A/C16HR-910A/C16...
910B/C16...-920AS/C10-920.../C11-1433/C11
1494/C14A-1529-1545/C5M

335x145x60 mm

9899 CV/C

ricambio cassetta vuota



9899 CV/C

1 098990003

920A/C17HR-920A/C17MR-920.../C12...-920A/
C17M-910.../C29-902A/C22-867/C38-720/C24-
450/C15-353N/C6-960KPC-920MC/C14-920U/
C17M-920TX/C17-920.../C20...-920AS/MBM-C21
920AS/C17X-1547/C6-1495/C6-1489/C14-1461/
C11A-1608/C9-1606A/C9-1602/C9

420x185x60 mm

900/R55



900/R55

1 009000871

666N/2-900/55-666/2

900/R55-Z



900/R55-Z

1 009000872

900M/R55



900M/R55
900M/55

1 009000888

910/R55

38"
72



910/R55
599DGT/6-606/6-606/10-612
665/6-665/10-665LB/6-665LB/10
666N/5-666N/10-666N LBF.IN/5-666N
LBF.IN/10
666/6-666/10-666RGC/6-
668RGC/10-910/55
666/5-666HS/5-666HS/10-666 LBF.FT/2
666 LBF.FT/5-666 LBF.FT/10

1 009100879

910M/R55

38"



910M/R55
910M/55-910M/56

1 009100888

910/R55Q

38"
48



910/R55Q
910/55Q

1 009100877

910/R55X

38"
48



910/R55X
666N/2X-666/2X-666 LBF.FT/2X

1 009100897

920/R50

12"
72



920/R50
614/50-667/20-667/30
667N/20-667N/30-920/50

1 009200866

920/R55

12"
72



920/R55
606/20-606/30-666/20-666/30-920/55
920/56A- 599DGT/20-599DGT/30
599DGT-AN/20-665/20-665/30-665LB/20
665LB/30-666N/20-666N/30
666N LBF.IN/20-666N LBF.IN/30-668RGC/20
666 LBF.FT/20-666 LBF.FT/30

1 009200879

920M/R55

12"



920M/R55
920M/55-920M/56

1 009200888

920/R55Q

12"
48



920/R55Q
920/55Q

1 009200877

920/R55X

12"
72



920/R55X
606/10X-612X
666/10X-920/55X-599DGT/10X-599DGT-
AN/10
665/10X-665LB/10X-666N10X-666N
LBF.IN/10X
668RGC/10X-666 LBF.FT/10X
666HS/20LC-666HS/30LC

1 009200878

920/R55LC

12"
72



920/R55LC
920/55LC "Locking System"

1 009200887

928/R55

34"
72



928/R55
928/55

1 009280859

928/R55X

34"
72



928/R55X
614X

1 009280858

929/R55

1"
72



929/R55
929/55

1 009290859

930

chiavi a tubo doppie poligonali
serie pesante



UNI 6745

Ø	L	Ø	Ø1		
mm	mm	mm	mm		
6x7	100	9,5	11,0	3	009300006
8x9	108	12,5	14,0	3	009300010
10x11	116	15,0	16,5	3	009300014
12x13	124	17,5	19,0	3	009300018
14x15	132	20,0	21,5	3	009300023
16x17	140	23,0	24,0	3	009300027
18x19	148	25,0	26,5	3	009300032
20x22	156	28,0	30,0	2	009300036
21x23	163	29,0	31,5	2	009300040
24x26	173	33,0	35,5	2	009300044
25x28	182	34,5	38,0	2	009300048
27x29	191	37,0	39,5	2	009300052
30x32	200	40,5	43,0	2	009300056



930/S8

6x7-8x9-10x11
12x13-14x15-16x17
18x19-20x22 mm

940/1 - /2

930/S13

6x7-8x9-10x11-12x13
14x15-16x17-18x19
20x22-21x23-24x26
25x28-27x29-30x32 mm

940/1 - /2 - /3

1 009300081

1 009300083



930/C13

6x7-8x9-10x11-12x13
14x15-16x17-18x19
20x22-21x23-24x26
25x28-27x29-30x32 mm

940/1 - /2 - /3

1 009300098

932

chiavi a pipa doppie
esagonali-poligonali
cromate lucide

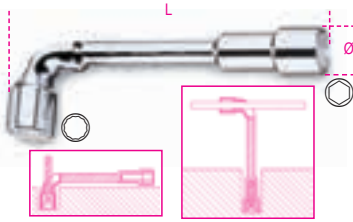

NF E 74.303

mm	Ø mm	L mm		
6x6	11,5	110	5	009320006
7x7	12,5	116	5	009320007
8x8	13,0	120	5	009320008
9x9	14,0	125	5	009320009
10x10	16,5	133	5	009320010
11x11	17,5	143	5	009320011
12x12	19,0	148	5	009320012
13x13	19,5	154	5	009320013
14x14	21,5	167	5	009320014
15x15	22,5	182	5	009320015
16x16	24,5	193	5	009320016
17x17	26,0	198	5	009320017
18x18	26,5	215	5	009320018
19x19	29,0	220	5	009320019
20x20	30,5	222	3	009320020
21x21	30,5	236	3	009320021
22x22	32,5	250	2	009320022
23x23	33,5	256	2	009320023
24x24	35,0	272	2	009320024
25x25	36,5	282	2	009320025
26x26	37,5	296	2	009320026
27x27	39,0	296	2	009320027
28x28	39,0	314	2	009320028
30x30	42,5	348	2	009320030
32x32	45,5	364	2	009320032



932/S11	1	009320080
6-7-8-10-11-12		
13-14-17-19-22 mm		
932/S17	1	009320081
6-7-8-9-10-11-12		
13-14-15-16-17		
18-19-20-21-22 mm		
932/S25	1	009320082
6-7-8-9-10-11-12-13		
14-15-16-17-18-19		
20-21-22-23-24-25		
26-27-28-30-32 mm		

933

chiavi a pipa doppie
esagonali
cromate lucide

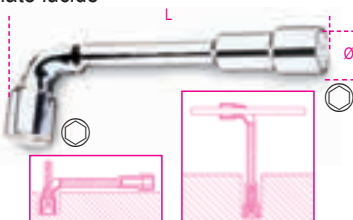

NF E 74.303

mm	Ø mm	L mm		
6x6	11,5	110	5	009330006
7x7	12,5	116	5	009330007
8x8	13,0	120	5	009330008

mm	Ø mm	L mm		
9x9	14,0	125	5	009330009
10x10	16,5	133	5	009330010
11x11	17,5	143	5	009330011
12x12	19,0	148	5	009330012
13x13	19,5	154	5	009330013
14x14	21,5	167	5	009330014
15x15	22,5	182	5	009330015
16x16	24,5	193	5	009330016
17x17	26,0	198	5	009330017
18x18	26,5	215	5	009330018
19x19	29,0	220	5	009330019
20x20	30,5	222	3	009330020
21x21	30,5	236	3	009330021
22x22	32,5	250	2	009330022
23x23	33,5	256	2	009330023
24x24	35,0	272	2	009330024
25x25	36,5	282	2	009330025
26x26	37,5	296	2	009330026
27x27	39,0	296	2	009330027
28x28	39,0	314	2	009330028
30x30	42,5	348	2	009330030
32x32	45,5	364	2	009330032



933/S11	1	009330080
6-7-8-10-11-12		
13-14-17-19-22 mm		
933/S17	1	009330081
6-7-8-9-10-11-12		
13-14-15-16-17		
18-19-20-21-22 mm		
933/S25	1	009330082
6-7-8-9-10-11-12-13		
14-15-16-17-18-19		
20-21-22-23-24-25		
26-27-28-30-32 mm		

935

chiavi a tubo doppie
esagonali
serie leggera



UNI 6746 DIN 896

mm	L mm		
6x7	100	5	009350105
8x9	110	5	009350111
10x11	120	5	009350115
12x13	130	5	009350117
14x15	140	5	009350126
16x17	150	5	009350128
18x19	160	5	009350131
20x22	170	3	009350138
21x23	180	3	009350141
24x26	190	3	009350144
25x28	200	2	009350150
27x29	210	2	009350153
30x32	220	2	009350156

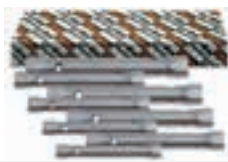

935/S8	1	009350181
6x7-8x9-10x11		
12x13-14x15-16x17		
18x19-20x22 mm		
940/1 - /2		
935/S13	1	009350183
6x7-8x9-10x11		
12x13-14x15-16x17		
18x19-20x22-21x23		
24x26-25x28-27x29		
30x32 mm		
940/1 - /2 - /3		

937

chiavi a pipa doppie
esagonali-poligonali
cromate

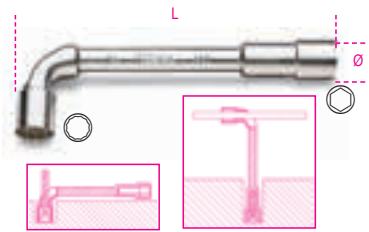

mm	Ø mm	L mm		
6x6	11,5	110	5	009370006
7x7	12,5	116	5	009370007
8x8	13,0	120	5	009370008
9x9	14,0	125	5	009370009
10x10	16,5	133	5	009370010
11x11	17,5	143	5	009370011
12x12	19,0	148	5	009370012
13x13	19,5	154	5	009370013
14x14	21,5	167	5	009370014
15x15	22,5	182	5	009370015
16x16	24,5	193	5	009370016
17x17	26,0	198	5	009370017
18x18	26,5	215	5	009370018
19x19	29,0	220	5	009370019
20x20	30,5	222	3	009370020
21x21	30,5	236	3	009370021
22x22	32,5	250	2	009370022
23x23	33,5	256	2	009370023
24x24	35,0	272	2	009370024
25x25	36,5	282	2	009370025
26x26	37,5	296	2	009370026
27x27	39,0	296	2	009370027
28x28	39,0	314	2	009370028
30x30	42,5	348	2	009370030
32x32	45,5	364	2	009370032



937/S11	1	009370080
6-7-8-10-11-12		
13-14-17-19-22 mm		
937/S17	1	009370081
6-7-8-9-10-11-12		
13-14-15-16-17		
18-19-20-21-22 mm		

940

spine di manovra per 930-935



mm	Ø mm	L mm		
940/1	6+13	100	5	009400001
940/2	14+22	170	5	009400002
940/3	21+32	290	5	009400003

941

chiavi a pipa esagonali-poligonali con impugnatura di manovra



mm	L	L1	A1		
7x7	200	91	35	2	009410107
8x8	220	107	50	2	009410108
9x9	220	109	50	2	009410109
10x10	236	111	50	2	009410110
11x11	236	114	50	2	009410111
12x12	255	122	50	2	009410112
13x13	255	124	55	2	009410113



941/S7
7-8-9-10-11-12-13 mm

1 009410170

CHIAVI A BUSSOLA CON IMPUGNATURA

Adatte per avvitamenti rapidi e ripetitivi. Lo spessore minimo delle bocche esagonali consente accessi in spazi ristretti.

Il foro di scarico interno agevola la manovra su dadi con parti filettate sporgenti, in particolare nel modello 944BX e 949 a bussola profonda.

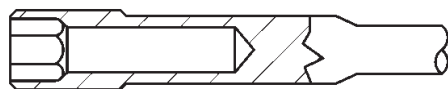

La triplice marcatura sulla testa facilita l'individuazione della misura.

Lo stelo flessibile del modello 943FL, costituito da un'anima d'acciaio protetta da guaina, consente la trasmissione della coppia in condizioni di disallineamento con la vite.

942BX

chiavi a bussola esagonale tipo corto



UNI 6750

mm	L	L1	A1		
4	190	70	13,0	5	009420003
5	190	70	14,0	5	009420004
5,5	190	70	12,5	5	009420005
6	190	70	14,5	5	009420006
7	190	70	15,5	5	009420007
8	202	70	18,5	5	009420008
9	202	70	19,5	5	009420009
10	202	70	20,5	3	009420010
11	202	70	21,5	3	009420011
12	202	70	22,5	3	009420012
13	202	70	23,5	3	009420013
14	202	70	24,5	3	009420014



942BX/S12
4-5-5,5-6-7-8-9
10-11-12-13-14 mm

1 009420030

943BX

chiavi a bussola esagonale tipo lungo



ISO 2236 UNI 6750

mm	L	L1	A1		
4	270	150	13,0	5	009430003
5	270	150	14,0	5	009430004
5,5	270	150	12,5	5	009430005
6	270	150	14,5	5	009430006
7	270	150	15,5	5	009430007
8	282	150	18,5	5	009430008
9	282	150	19,5	5	009430009
10	282	150	20,5	3	009430010
11	282	150	21,5	3	009430011
12	282	150	22,5	3	009430012
13	282	150	23,5	3	009430013
14	282	150	24,5	3	009430014



943BX/S12
4-5-5,5-6-7-8-9
10-11-12-13-14 mm

1 009430030



943BX/D6
5-6-7-8-10-13 mm

1 009430026

943FL

chiavi a bussola esagonale flessibili con impugnatura



mm	L	L1	Ø		
5	265	150	8	2	009430304
5,5	265	150	8	2	009430305
6	265	150	9	2	009430306
7	265	150	11	2	009430307
8	265	150	12	2	009430308
10	290	175	14	2	009430310



943FL/S6
5-5,5-6-7-8-10 mm

1 009430320

944BX

chiavi a bussola esagonale profonda
tipo lungo



ISO 2236 UNI 6750

mm	L	L1	A1	
4	245	125	20	3 009440003
5	245	125	25	3 009440004
5,5	245	125	30	3 009440005
6	245	125	35	3 009440006
7	245	125	35	3 009440007
8	257	125	50	3 009440008
9	257	125	50	3 009440009
10	257	125	50	3 009440010
11	257	125	50	3 009440011
12	257	125	50	3 009440012
13	257	125	55	3 009440013
14	257	125	55	3 009440014



944BX/S12
4-5-5,5-6-7-8-9
10-11-12-13-14 mm



944BX/D6
5-6-7-8-10-13 mm

949

chiavi a T semplici
con bussola esagonale profonda

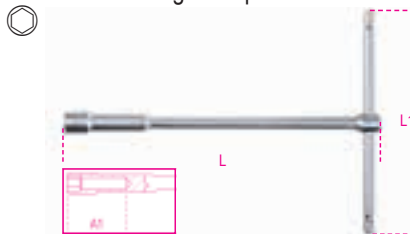

mm	L	L1	A1	
8	220	160	50	2 009490008
10	230	160	50	2 009490010
12	240	175	50	2 009490012
13	244	175	55	2 009490013
14	250	190	55	2 009490014
17	264	200	60	2 009490017

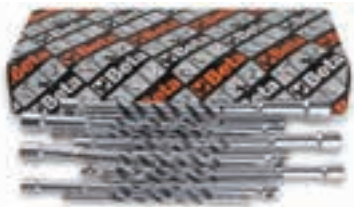

949/S6
8-10-12-13-14-17mm

950

chiavi a T semplici
esagonali

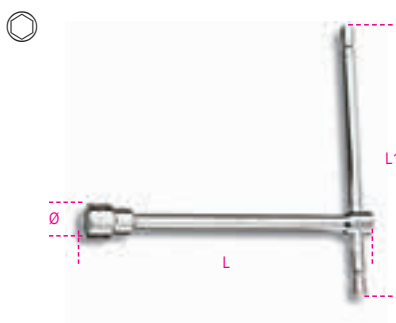

UNI 6742 DIN 3112

mm	L	Ø	L1	
6	210	10,1	145	3 009500006
7	212	11,2	145	3 009500007
8	220	12,4	160	3 009500008
9	223	13,5	160	3 009500009
10	230	14,9	160	3 009500010
11	233	16,1	160	3 009500011
12	240	17,5	175	3 009500012
13	244	19,7	175	3 009500013
14	250	20,1	190	3 009500014
15	254	21,5	190	3 009500015
16	260	22,7	200	3 009500016
17	264	24,1	200	3 009500017
19	274	26,6	230	3 009500019
22	290	29,9	290	2 009500022
24	300	32,2	320	2 009500024
27	315	36,2	370	2 009500027



950/S9
7-8-10-11-12
13-14-17-19 mm

950/S14
6-7-8-9-10-11-12-13
14-15-16-17-19-22 mm



951 CHIAVI A T CON TRE ESTREMITÀ MASCHIO ESAGONALE



Quando nacque questa chiave rappresentò una rivoluzione. Nata per lavorare su viti ad alta resistenza, offre rapidità di manovra, precisione dell'accoppiamento con la vite e flessibilità d'impiego. L'astina scorrevole esagonale può essere regolata a piacimento. Le estremità esagonali sono calibrate per trasmettere la massima coppia possibile alla vite. La lunghezza dello stelo permette di applicare notevoli coppie alle viti senza eccessivo sforzo. I continui miglioramenti produttivi portano oggi ad avere finitura sabbata ed estremità esagonali a spigolo vivo, che permettono un accoppiamento migliore anche su viti rovinate. La marcatura eseguita a laser permette di aumentare la resistenza dello stelo.

951

chiavi a T con tre estremità maschio esagonale

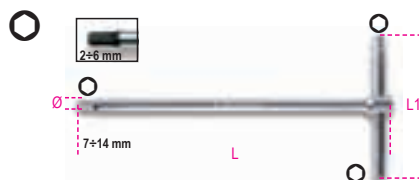

mm	L mm	L1 mm	Ø mm		
2	125	63	4,0	5	009510521
2,5	150	63	4,0	5	009510525
3	150	63	4,0	5	009510530
3,5	175	76	5,5	5	009510535
4	175	76	5,5	5	009510540
4,5	195	87	6,5	5	009510545
5	195	87	6,5	5	009510550
6	215	99	8,0	5	009510560
7	230	109	9,0	5	009510570
8	250	122	10,0	5	009510580
9	265	132	11,0	5	009510590
10	280	142	12,0	5	009510610
12	305	160	15,0	3	009510620
14	330	178	17,0	3	009510640

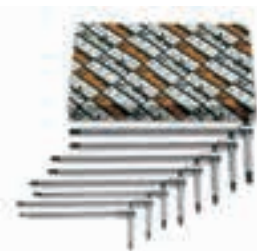

951/S6 2,5-3-4-5-6-8 mm	1	009510687
951/S8 2-2,5-3-3,5-4-4,5-5-6 mm	1	009510693
951/S14 2-2,5-3-3,5-4-4,5-5-6-7-8-9-10-12-14 mm	1	009510695



951/SP6 3-4-5-6-8-10 mm	1	009510696
951/SPV	1	009510697



951AS

chiavi a T con tre estremità maschio esagonale

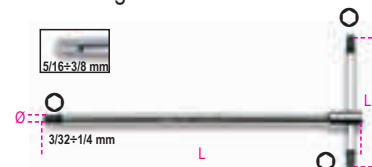

"	L mm	L1 mm	Ø mm		
3/32	125	63	4,0	2	009510750
7/64	150	63	4,0	2	009510751
1/8	150	63	4,0	2	009510752
9/64	175	76	5,5	2	009510753
5/32	175	76	5,5	2	009510754
3/16	195	86	6,5	2	009510755
7/32	215	99	8,0	2	009510757
1/4	230	109	9,0	2	009510758
5/16	250	122	10,0	2	009510759
3/8	280	142	12,0	2	009510760

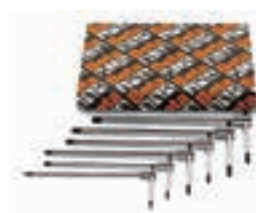

951AS/S6X 1/8-3/16-7/32-1/4-5/16-3/8	1	009510771
--	---	-----------

951TX

chiavi a T con tre estremità maschio per viti con impronta Torx®



Ø	L mm	L1 mm	Ø mm		
T6	125	63	4	3	009510806
T7	125	63	4	3	009510807
T8	125	63	4	3	009510808
T9	125	63	4	3	009510809
T10	150	63	4	3	009510810
T15	150	63	4	3	009510815
T20	175	76	5	3	009510820
T25	175	76	5	3	009510825
T27	195	87	6	3	009510827
T30	195	87	6	3	009510830
T40	215	99	7	3	009510840
T45	230	109	8	3	009510845
T50	250	122	9	3	009510850

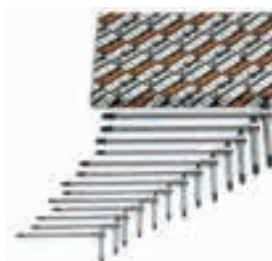

951TX/S6 T8-T10-T15-T20-T25-T30	1	009510866
951TX/S13 T6-T7-T8-T9-T10-T15-T20-T25-T27-T30-T40-T45-T50	1	009510863

952 CHIAVI CON BUSSOLA SNODATA

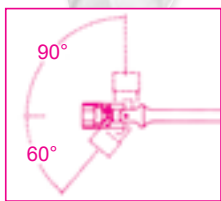

L'affidabilità e la precisione del pre-posizionamento sono le **ragioni** del successo di queste **chiavi**. Lo snodo mantiene la propria funzione nel corso degli anni, senza bisogno di alcuna regolazione.

Angolo di rotazione della bussola 60°. Possibilità di utilizzo a 90° in posizione fissa. L'asta di manovra è scorrevole ed è arrestabile nella posizione desiderata su tutta la lunghezza. La triplice marcatura della misura sulla testa ne facilita l'identificazione.

952

chiavi a T con bussola esagonale snodata

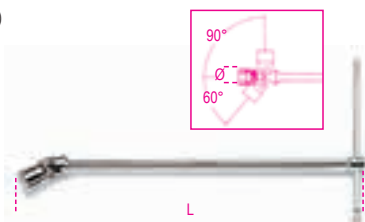

UNI 6743

Ø mm	Ø mm	L mm	Hand Icon	Part Number
6	9,5	395	5	009520006
7	10,7	395	5	009520007
8	12,1	395	5	009520008
9	13,2	395	5	009520009
10	14,6	400	5	009520010
11	15,8	400	5	009520011
12	17,0	400	5	009520012
13	18,7	432	5	009520013
14	19,7	432	5	009520014
15	20,9	450	3	009520015
16	22,0	450	3	009520016
17	23,4	450	3	009520017
18	24,7	450	3	009520018
19	26,0	500	3	009520019
20	27,4	500	3	009520020
21	28,5	500	3	009520021
22	29,7	500	3	009520022
24	32,4	500	3	009520024



952/S7 8-10-11-13-14-17-19 mm	1	009520074
952/S10 7-8-10-11-12-13-14-15-17-19 mm	1	009520080
952/S18 6-7-8-9-10-11-12-13-14-15-16-17-18-19-20-21-22-24 mm	1	009520083

852



852

78,84



952AS

chiavi a T con bussola esagonale snodata

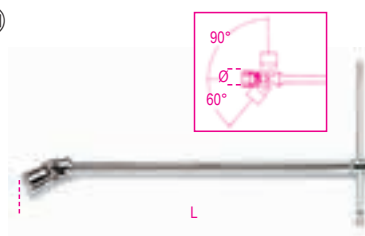

Ø "	Ø mm	L mm	Hand Icon	Part Number
1/4	9,5	395	2	009520256
5/16	12,1	395	2	009520258
3/8	14,6	400	2	009520260
7/16	15,8	400	2	009520261
1/2	18,7	432	2	009520263
9/16	19,7	432	2	009520264
5/8	22,0	450	2	009520266
11/16	23,4	450	2	009520267
3/4	26,0	500	2	009520269

952L

chiavi a T con bussola esagonale snodata, tipo lungo

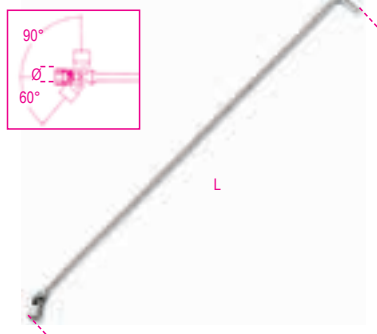

Ø mm	Ø mm	L mm	Hand Icon	Part Number
10	14,6	930	1	009520410
12	17,0	1063	1	009520412
13	18,7	1100	1	009520413
14	19,7	1100	1	009520414
15	20,9	1100	1	009520415
16	22,0	1100	1	009520416
17	23,4	1100	1	009520417
18	24,7	1100	1	009520418
19	26,0	1100	1	009520419

952FTX

chiavi a T con bussola snodata per viti con testa a profilo Torx®

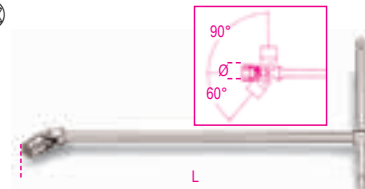

Ø mm	Ø mm	L mm	Hand Icon	Part Number
E6	8	392	2	009520106
E7	9	392	2	009520107
E8	10	395	2	009520108
E10	13	400	2	009520110
E12	15	440	2	009520112
E14	17	490	2	009520114
E16	19	490	2	009520116
E18	21	490	2	009520118
E20	23	490	2	009520120



952FTX/S9
E6-E7-E8-E10-E12
E14-E16-E18-E20

1 009520141

953

chiavi a T con maschio esagonale
snodato

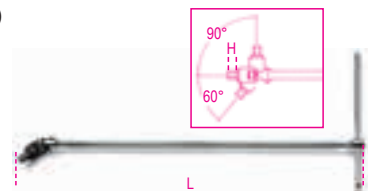

UNI 6754

mm	H mm	L mm	
3	5	395	5 009530130
3,5	6	395	3 009530135
4	6	395	5 009530140
4,5	7	395	3 009530145
5	7	395	5 009530150
6	9	400	5 009530160
7	10	425	3 009530170
8	11	425	5 009530180
10	13	440	5 009530200



953/S5
3-4-5-6-8 mm
953/S9
3-3,5-4-4,5
5-6-7-8-10 mm

1 009530305

1 009530301

953TX

chiavi a T con maschio snodato
per viti con impronta Torx®

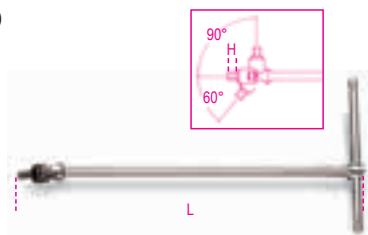

mm	H mm	L mm	
T20	11	396	2 009530020
T25	11	396	2 009530025
T27	11	396	2 009530027
T30	13	400	2 009530030
T40	13	400	2 009530040
T45	13	426	2 009530045
T50	14	442	2 009530050
T55	14	442	2 009530055



953TX/S8
T20-T25-T27-T30
T40-T45-T50-T55

1 009530060

AUTORIPARAZIONE

I nostri utensili per autoriparazione, usati dai professionisti più esigenti, sono sviluppati e prodotti per soddisfare gli standard più elevati al mondo e testati continuamente nelle condizioni di utilizzo più stressanti.

Da oltre 50 anni, siamo orgogliosamente a fianco dei più grandi campioni, che ci aiutano a migliorare costantemente i nostri prodotti e ne confermano il livello di qualità più assoluta.

Gli utensili dedicati all'autoriparazione si trovano in queste sezioni:

Diagnostica

da 1438 a 1499
da 1758VT a 1760TMC

Motore

da 955 a 989A
da 1438 a 1499

Olio e filtri

da 1438 a 1499
da 1877 a 1885

Impianto elettrico

da 1438 a 1499

Avviatori

da 1498BC/12 a 1498/40A

Trasmissione

da 1438 a 1499

Sospensioni

da 1549 a 1569CP

Freni

da 1438 a 1499

Ruote

da 955 a 989A

Carrozzeria

da 1302 a 1369
da 1763 a 1767A

Altre attrezzature

da 1878 a 3067

Sollevatori

da 3029/2T a 3067/70-13T



955

chiave a tubo semplice
per candele d'accensione

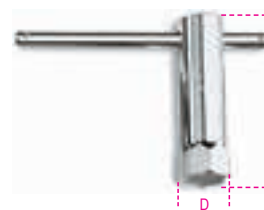

mm -"	D mm	L mm	
16	21	86	3 009550016
5/8			
20,8	29	86	3 009550021
13/16			

956C

chiavi a bussola
con attacco quadro femmina 1/2"
per candele d'accensione



12"



ISO 11168

mm -"	Ø mm	L mm	
14	18,8	70	3 009560008
9/16			
16	21,4	70	3 009560010
5/8			
17,8	23,6	70	3 009560011
11/16			
20,8	27,0	70	3 009560012
13/16			

956E

chiavi a bussola
con attacco quadro femmina 3/8"
per candele d'accensione



3/8"



ISO 11168

mm -"	Ø mm	L mm	
14	18,8	70	3 009560018
9/16			
16	21,4	70	3 009560020
5/8			
17,8	23,6	70	3 009560021
11/16			
20,8	27,0	70	3 009560022
13/16			

956F

chiavi a bussola
con attacco quadro femmina 3/8"
per candele d'accensione



3/8"



mm -"	Ø mm	L mm	
14	18,8	70	1 009560114
9/16			
16	20,5	70	1 009560116
5/8			

Beta

956L

chiavi a bussola poligonale con attacco quadro femmina 1/2" tipo lungo, per candele d'accensione



mm - "	Ø mm	L mm	
14	19,0	250	2 009560214
9/16	21,0	250	2 009560216
5/8	17,8	250	2 009560217
11/16	20,8	250	2 009560221
13/16			

957

chiavi a T con bussola snodata per candele d'accensione

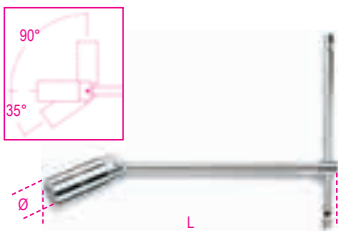

ISO 11168

mm - "	Ø mm	L mm	
16	21,4	275	3 009570000
5/8	20,8	275	3 009570001
13/16			

959

chiavi a T con bussola snodata tipo normale, per candele d'accensione

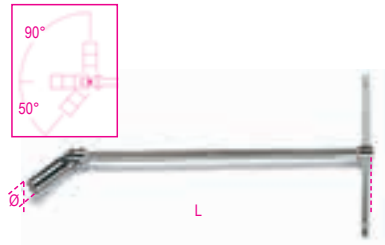

ISO 11168

mm - "	Ø mm	L mm	
14	18,8	483	3 009590009
9/16	21,4	483	3 009590010
5/8	20,8	527	3 009590011
13/16			

959R

gommino e molla di ricambio per 956C - 956E - 957 - 959

959R/14	956C/14-956E/14	3 009590223
959R/16	956C/16-956E/16	3 009590224
959R/17,8	956C/17,8-956E/17,8	3 009590225
959R/20,8	956C/20,8-956E/20,8	3 009590226
	957/20,8-959/20,8-959L	

960

chiavi a bussola con attacco quadro femmina 1/2" per iniettori motori Diesel

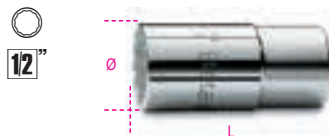

mm	Ø mm	L mm	
27	36,5	77	2 009600027

960A

chiavi a bussola con attacco quadro femmina 1/2" per iniettori motori Diesel

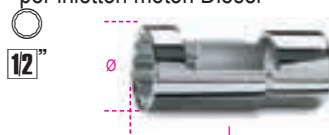

mm	Ø mm	L mm	
27	36,5	77	2 009600017

960BC/C5

serie di 5 chiavi a bussola per connessione elettrica iniettori

incluse nel kit:

- 1 bussola esagonale aperta da 25 mm
- 1 bussola esagonale aperta da 27 mm
- 1 bussola esagonale aperta da 29 mm
- 1 bussola esagonale aperta da 30 mm
- 1 bussola poligonale da 28 mm



960BC/C5 1 009600280

280x160x55 mm - 1,9 kg

960BC

chiavi a bussola esagonali aperte per le connessioni elettriche degli iniettori



mm		
25	1	009600285
27	1	009600287
29	1	009600289
30	1	009600290

960BC/P 28

chiave a bussola poligonale per la connessione elettrica degli iniettori



960BC/P 28 1 009600288

960BT/B

chiavi a bussola per le connessioni elettriche degli iniettori

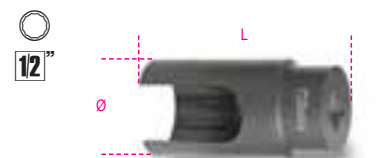

mm	Ø mm	L mm	
29	38,5	77	1 009600128

960ER

estrattore a percussione per rondelle iniettori

punta conica a gradini



L
mm
350

1 009600726

960F

chiave a bussola
per ghiere portainiettori



Ø	Ø1	Ø2	Ø1	Ø2
mm	mm	mm	mm	mm
28,3	22	32	22	22

1 009600148

960G

chiave a bussola
per ghiere portainiettori



Ø	Ø1	Ø2	L
mm	mm	mm	mm
28,5	22	32	122

1 009600151

960L

chiave a bussola
per ghiere portainiettori



Ø	Ø1	L
mm	mm	mm
30	22	122

1 009600153

960M

chiave a bussola
per ghiere portainiettori

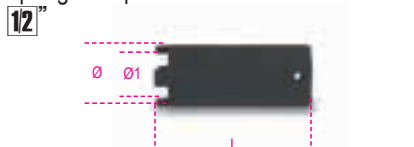

Ø	Ø1	L
mm	mm	mm
28,5	22	72

1 009600154

960H/C4

serie di bussole per ghiere portainiettori



960H/C4

1 009600152

960S

chiavi a bussola
con attacco quadro femmina 1/2"
per iniettori motori Diesel

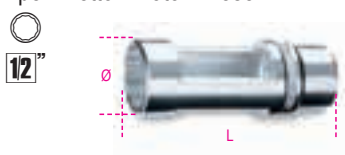

Ø	Ø	L
mm	mm	mm
22	30	82

1 009600022

960SL

chiavi a bussola per sonda Lambda
con attacco quadro femmina 1/2"

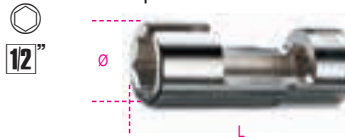

	Ø	
960SL85	mm	33
	○ 22xL=	85 mm
960SL110	mm	33
	○ 22xL=	110 mm

2 009600085

2 009600110

960SN

chiavi per candele
di preriscaldamento motori Diesel



Ø	Ø	□	L
mm	mm		mm
8	12,0	1/4	60
9	13,3	1/4	60
10	14,5	3/8	70
11	15,8	3/8	70
12	17,0	3/8	70

2 009600834

2 009600835

2 009600836

2 009600837

2 009600838

960T/C11

assortimento bussole
per rimozione/installazione
sensori

incluse nel kit:

- 1 bussola esagonale doppia misura 1" - 1 1/16" per sensori di pressione olio
- 1 bussola esagonale aperta 29 mm per sensori ossigeno
- 1 bussola poligonale aperta 27 mm per iniettori
- 1 bussola esagonale aperta 22 mm per vacuostato
- 1 bussola esagonale aperta 22 mm lunga 80 mm per sensori ossigeno
- 1 bussola esagonale aperta 22 mm lunga 98 mm per sensori ossigeno
- 1 bussola esagonale aperta 22 mm compatta lunga 30 mm per sensori ossigeno
- 1 bussola esagonale aperta 22 mm compatta lunga 50 mm per sensori ossigeno
- 1 bussola aperta 22 mm compatta lunga 34 mm ad impronta esagonale e poligonale, per sensori ossigeno
- 1 bussola esagonale aperta 22 mm con geometria a tubo
- 1 maschio M18x1,5



○ 22 - 29 mm

960T/C11

1 009600031

330x270x25 mm

960T/A

bussola esagonale aperta 29 mm
per sensori ossigeno



Ø	L
mm	mm
29	90

1 009600032

960T/B

bussola poligonale aperta 27 mm
per iniettori



Ø	L
mm	mm
27	85

1 009600033



960T/C

bussola esagonale aperta 22 mm
per vacuostato



mm 22 L mm 88
1 009600034

960T/D

bussola esagonale aperta 22 mm lunga 90
mm
per sensori ossigeno



mm 22 L mm 90
1 009600035

960T/E

bussola esagonale aperta 22 mm lunga 80
mm
per sensori ossigeno



mm 22 L mm 80
1 009600036

960T/F

bussola esagonale doppia misura 1" - 1 1/16"
per sensori di pressione olio



1 - 1 1/16 mm 28 L mm 74
1 009600037

960T/G

bussola esagonale aperta 22 mm
con geometria a tubo



mm 22 L mm 98
1 009600038

960T/H

bussola aperta 22 mm compatta lunga 34 mm
ad impronta esagonale e poligonale, per
sensori ossigeno

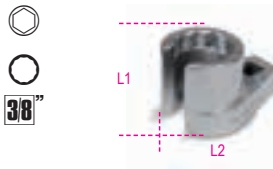

mm 22 L1 mm 34 L2 mm 55
1 009600039

960T/I

bussola esagonale aperta 22 mm compatta
lunga 30 mm
per sensori ossigeno



mm 22 L1 mm 30 L2 mm 81
1 009600040

960T/L

bussola esagonale aperta 22 mm compatta
lunga 50 mm
per sensori ossigeno



mm 22 L1 mm 50 L2 mm 58
1 009600041

960T/M

maschio M18x1,5



mm 21 L mm 50
1 009600042

960/22EP

chiave snodata a doppia impronta
per sonde Lambda
grande versatilità d'uso grazie alla doppia impronta
esagonale/poligonale e allo snodo a 180°



L mm 300 mm 22 mm 22
1 009600052

960/C6

chiavi esagonali con attacco quadro femmina
3/8"

per rimozione/installazione sensori di
temperatura gas di scarico

Incluse nel kit:

- 3 misure in versione corta 13, 14, 17 mm
- 3 misure in versione lunga 13,14,17 mm



960/C6 1 009600055

170x120x50 mm

960/D

chiavi esagonali aperte versione lunga
per rimozione/installazione sensori di
temperatura gas di scarico



mm 13 L mm 14 mm 17
1 009600073
1 009600074
1 009600077

960YP

chiavi esagonali aperte versione piegata per rimozione/installazione sensori di temperatura gas di scarico

3/8"



mm	
13	1 009600063
14	1 009600064
17	1 009600067

960AVE

attrezzo verifica elettroiniettori Diesel Common Rail BOSCH, SIEMENS, DENSO e DELPHI.



960AVE 1 009600245

430x310x50 mm - 2,0 kg

960CMB

strumento per controllo compressione su motori a benzina



Bar 4÷17 1 009600250

440x370x100 mm - 2,2 kg

960CMB/R2

n° 48 schede di ricambio per 960CMB



960CMB/R2 1 009600252

960CMD

strumento per controllo compressione su motori Diesel



Bar 8÷40 1 009600270

440x370x100 mm - 2,4 kg

960CMD/R1

n° 48 schede di ricambio per 960CMD



960CMD/R1 1 009600271

960EPC

set di utensili per l'estrazione dell'elettrodo delle candele di preriscaldamento M8x1 - M9x1 - M10x1 - M10x1,25



960EPC 1 009600790

270x230x80 mm - 900 g

960EPC/L

set di utensili per l'estrazione della punta elettrodo delle candele di preriscaldamento M8x1 - M9x1 - M10x1 - M10x1,25 versione lunga



960EPC/L 1 009600890

270x230x80 mm - 2 kg

960E-PI/P

estrattore per rondelle iniettori

• filetto maschio M10 per utilizzo con estrattore a massa battente (Beta 1540)



960E-PI/P 1 009600706

300x90x60 mm

960KC-M8/M9/M10

assortimento di utensili per la rimozione delle candele di preriscaldamento spezzate o danneggiate

• Per candele con filetto M8-M9-M10



960KC-M8/9/10 1 009600801

380x290x50 mm - 2,3 kg

960KPC

estrattore reversibile ad impulsi
con coppia regolabile
per candele di preriscaldamento
Coppia regolabile in 4 posizioni:
10-20-30-40 Nm

14

CE



960KPC

8-9-10-11-12 mm

420x185x60 mm - 2,8 kg

1 009600780

960UC

set di utensili per estrazione candele
bloccate
con punta deformata
M8-M9-M10



960UC

270x230x80 mm - 2,6 kg

1 009600900

960P

tester per controllo pressione/depressione
con accessori e adattatori



960P

350x320x95 mm - 1,9 kg

1 009600777

960PI

assortimento di alesatori per la pulizia della
sede iniettori
in cassetta di plastica
Per pulire i residui all'interno della sede iniettori

- Alesatore piatto da \varnothing 19 - 15 mm per iniettori universali
- Alesatore piatto da \varnothing 17 - 17 mm per iniettori Delphi/Bosch (BMW/PSA/Renault/Ford)
- Alesatore piatto da \varnothing 19 - 17 mm per iniettori Bosch (Mercedes CDI).
- Alesatore ad angolo da \varnothing 21 - 17 mm per iniettori Fiat/Iveco.
- Impugnatura



960PI

250x130x50 mm - 600 g

1 009600215

960PI/C19

assortimento di 19 utensili
per la pulizia sedi iniettori

- Inclusi nel kit:
- 11 alesatori piatti \varnothing :
14/14 mm - 15,5/15,5 mm - 15/19 mm - 17/19 mm - 17/17,5 mm
17/17 - 17/19,5 mm - 17/20 mm - 18/21 mm - 19 mm - 20/21 mm
 - 4 alesatori ad angolo \varnothing :
15,5/15,5 mm - 17/17 mm - 17,5/20,5 mm - 17/21 mm
 - Impugnatura ed accessori per utilizzo frese



960PI/C19

360x230x60 mm

1 009600217

960PI/S

kit per pulizia sedi iniettori

- Il kit include:
- 3 spazzole in acciaio \varnothing 18, 22, 25 mm per pulizia sedi iniettori
 - 2 spazzole \varnothing 14 e 16 mm per pulizia fondo sedi iniettori
 - 6 tappi per occlusione foro collegamento camera di combustione
 - 1 scovolino per pulizia foro collegamento camera di combustione
 - 1 portainserti flessibile con impugnatura

14



960PI/S

360x140x50 mm - 700 g

1 009600214

960VTC

strumento per controllo
perdite cilindri su motori benzina
a seguito dell'inserimento di aria compressa all'interno del
cilindro,
il manometro consente di verificare la presenza
di eventuali perdite di compressione



960VTC

373x295x70,6 mm - 2,3 kg

1 009600261

960RPI

attrezzo soffiatore per pulizia sede iniettori

Per motori con candele
M8x1 - M9x1 - M10x1 - M10x1.25



960RPI

373x295x70,6 mm - 2,3 kg

1 009600940

960PMC

pompa manuale per taratura
e controllo iniettori Diesel



Bar Max.
600

373x295x70,6 mm - 2,3 kg

1 009600200

960AVL

aspiratore di vapori



Bar Max.
6

373x295x70,6 mm - 2,3 kg

1 009600210



961P6

videoscopio elettronico
con sonda flessibile



CE

- Schermo TFT LCD 3.2"
- Supporta l'utilizzo di SD CARD (8 GB)
- Supporta memorie flash (8 GB)
- Memoria interna da 64M
- Uscita TV-OUT
- Supporta i formati video (MP4, AVI, 3GP)
- 4 led di illuminazione
- Alimentazione tramite presa USB (batteria incorporata)

CARATTERISTICHE TECNICHE

- Pixel del sensore: 640x480
- Risoluzione massima: 320x240
- Lunghezza sonda: 1 mt.
- Diametro camera: 6 mm
- Formati video: MPEG4, 3GP, AVI, ASF.
- Formati foto: JPEG
- Angolo di ripresa: 0+180°
- Uscita dati: cavo USB e SD card
- Alimentazione: batteria 3,7V 2000 mAh

961P6

1 009610000

961P6/S

sonde flessibili 6 mm



	L mm		
961P6/S1	1000	1	009610006
961P6/S2	2000	1	009610262
961P6/S3	3000	1	009610263

962

levagomme



L mm	A mm		
300	21	5	009620003
400	25	5	009620004
500	27	3	009620005
600	27	3	009620006

962C



962C

279

962P

levagomme con protezione
in gomma antigraffio



L mm	A mm		
490	25	1	009620049

962M

attrezzo per smontaggio/montaggio pneumatici

particolarmente indicato per Runflat e modelli
con spalle ribassate

- ganasce antigraffio per bloccaggio su cerchi
- sede per inserimento leve smontagomme



962M

1 009620501

963

leva con estremità a punta
e piatta curva



L mm	A mm		
400	23	5	009630001



964

leva con estremità a punta
e a becco



L mm	A mm		
400	46	5	009640001

965

leve con estremità piatta curva



L mm	A mm	L1 mm		
300	16	185	2	009650013
450	20	312	2	009650014
600	20	462	2	009650016



965/S3

1 009650019

966/C3

serie di 3 leve con testa snodata piatta curva



966/C3

L=200-250-300 mm

≡ 355x140x65 mm - 1,8 kg

1 009660103

720LS

chiavi a bussola Macchina
serie lunga sottile

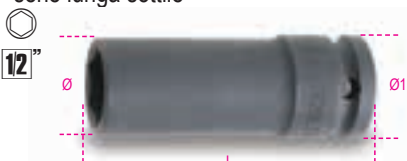

UNI/ISO 2725

	Ø	L	Ø1		
	mm	mm	mm	mm	
720LS 36	36	48,0	78	29	2 007200386

969B

chiave a bussola per serraggio dado mozzo

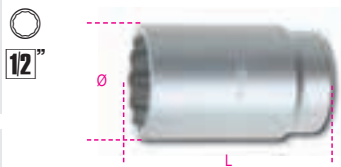

mm	Ø mm	L mm	
24	36,0	76	1 009690124
27	36,0	76	1 009690127
30	40,0	76	1 009690130
31	42,0	76	1 009690131
32	42,5	76	1 009690132
34	45,0	76	1 009690134
35	46,0	76	1 009690135
36	49,0	76	1 009690136

969/C5

serie di 5 chiavi a bussola per serraggio dado mozzo in valigetta di plastica



969/C5 1 009690201

969B 30-32-34-35-36

970B

chiave a bussola per serraggio dadi mozzo Fiat Daily

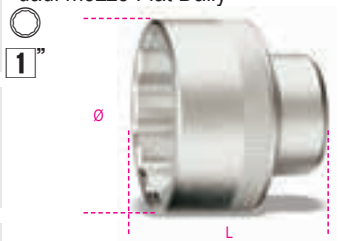

mm	Ø mm	L mm	
65	88	75	1 009700010

970IVECO

chiave a bussola a settori per dadi mozzo Iveco Daily per versioni dall'anno 2014

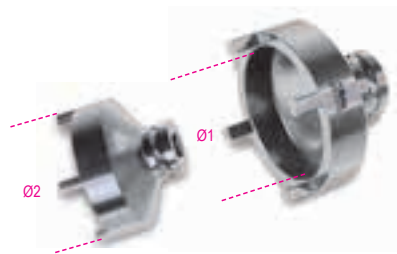

Ø1 mm	Ø2 mm	
61,5	74,8	1 009700011

971/C8

giravite dinamometrico con accessori per il serraggio controllato delle valvole dei pneumatici con sistema di controllo della pressione



971/C8 1 009710108

583/6	1,2+6 Nm
892/0	
862TX	T10-T15-T20
900L	11-12 mm
986 78	

972/C4BMW

kit per rimozione bulloni antifurto con anello libero, tipo BMW e Mini



972/C4BMW 1 009720004

516x145x66 mm - 3,8 kg

972/C10

kit per rimozione dadi ruota danneggiati

utilizzabile su dadi antifurto e tradizionali



972/C10 1 009720010

290x250x60 mm - 2,4 kg

973

kit di 4 protezioni in nylon per ruote

Idoneo per cerchi da:
14" a 18" codice 009730014
19" a 22" codice 009730019



Caratteristiche:

- Conserva e protegge la ruota da eventuali graffi e polvere
- Durante lo stoccaggio, previene il precoce deterioramento dei polimeri della gomma del pneumatico estivo o invernale
- Attraverso un'icona identificativa, permette la facile individuazione della posizione ruota (anteriore destra/sinistra o posteriore destra/sinistra)
- Dotate di impugnatura per un comodo trasporto
- Tessuto: nylon, lavabile

973 14"±18" 1 009730014

973 19"±22" 1 009730019

978 - 979

chiavi a croce per dadi ruote

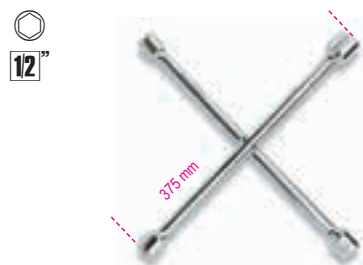

UNI/ISO 6788 DIN 3119

978 2 009780001

17x19x21x22 mm

979 2 009790001

17x19x22x1/2 mm

Beta

982

chiavi a croce per dadi ruote

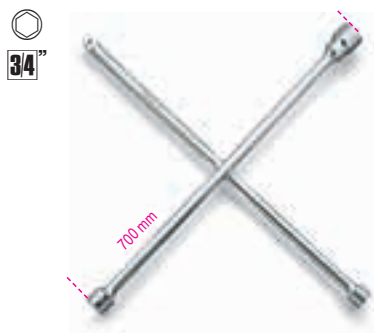

UNI/ISO 6788 DIN 3119

24x27x32x3/4 mm

1 009820001

983PM

spazzola abrasiva per pulizia mozzi



Ø1
mm
90

Ø2
mm
150

1 009830010

983 PM/R-DA

coppia dischi abrasivi per 983PM



Ø
mm
150

2 009830050

984

pinza per coperture plastiche dadi ruote



L
mm
195

H
mm
4

1 009840005

985/B7

assortimento di 7 perni guida per montaggio ruote

Misure incluse:

- M12X1,25 maschio
- M12x1,25 femmina
- M12x1,5 maschio
- M12x1,5 femmina
- M14x1,25 maschio
- M14x1,5 maschio
- M16x1,5 maschio



985/B7

1 009850007

985M

perni guida maschio per montaggio ruote



	L mm	
985M M12X1,25	150	1 009850101
985M M12X1,50	150	1 009850102
985M M14X1,25	150	1 009850103
985M M14X1,50	150	1 009850104
985M M16X1,50	150	1 009850105

985F

perni guida femmina per montaggio ruote



	L mm	
985F M12X1,25	150	1 009850106
985F M12X1,50	150	1 009850107



Beta

QUALITY TOOLS

986 48

giravite per valvole pneumatiche modello corto

ritenzione automatica della valvola



L
mm
18

L1
mm
48

1 009860048

986 78

giravite per valvole pneumatiche

ritenzione automatica della valvola



L
mm
18

L1
mm
78

1 009860078

986PT

giravite prearato 0,4 Nm per valvole pneumatiche

ritenzione automatica della valvola il meccanismo di slittamento permette di non danneggiare la guarnizione del nucleo della valvola



L
mm
19

L1
mm
120

1 009860140

987

leva per valvole pneumatiche con protezione in gomma



L
mm
310

1 009870001

987AR

leva per valvole pneumatici
con fulcro antigraffio

- fulcro in gomma e Nylon per cerchi in lega ed in ferro
- attacco rapido della valvola, non necessita di essere avvitata



L
mm
305

1 009870021

987P

leva per valvole pneumatici
in materiale plastico

nel manico è incluso il giravite per agire sul
meccanismo interno alla valvola



L
mm
335

1 009870011

988/K4

serie di 4 scalpelli in plastica anti graffio



988/K4
A= 19-21-25-38 mm

1 009880104

989

pinza combinata
per equilibratura ruote

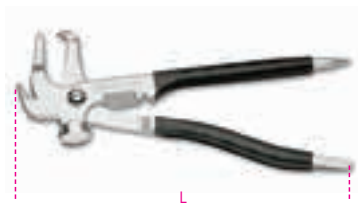

L
mm
250

2 009890001

989A

pinza per rimozione piombi adesivi
equilibratura ruote



Profilo dei becchi appositamente studiato per una
rimozione dei piombi senza contatto col cerchione

989A

L
mm
220

1 009890011

989B

pinza universale per piombi
equilibratura ruote

funzioni:

- rimozione piombi adesivi per cerchi in lega
- rimozione piombi per cerchi in ferro
- martello con copertura in PE-HD removibile per piombi adesivi e per cerchi in ferro
- ganascia per chiusura piombi per cerchi in ferro



L
mm
230

1 009890015

990

pinzetta a molla a punte fini diritte
arrotondate, zigrinate
in acciaio inossidabile



L
mm
130

5 009900001

991

pinzetta a molla a punte fini curve
arrotondate, zigrinate
in acciaio inossidabile



L
mm
130

5 009910001

992

pinzetta a molla con perno
a punte fini diritte arrotondate
zigrinate, in acciaio inossidabile



L
mm
150

5 009920001

993

pinzetta a molla con perno
a punte fini curve arrotondate
zigrinate, in acciaio inossidabile



L
mm
145

5 009930001

993PL

pinzetta a molla a punte fini curve
arrotondate, zigrinate
in acciaio inossidabile



L
mm
150

3 009930010

Beta

Beta

QUALITY TOOLS

993G

pinzetta a molla con perno, a punte curve a gomito arrotondate, zigrinate in acciaio inossidabile



L
mm
160

3 009930030

994

pinzetta a molla a punte larghe diritte arrotondate, zigrinate in acciaio inossidabile



L
mm
150

5 009940001

994PL

pinzetta a molla a punte larghe diritte arrotondate, zigrinate in acciaio inossidabile



L
mm
150

3 009940010

994TF

pinzetta a molla, antiacido antimagnetica, a punte larghe diritte arrotondate, zigrinate in acciaio inossidabile



L
mm
150

3 009940020

996

pinzetta a molla a becchi diritti a spatola in acciaio inossidabile



L
mm
150

5 009960001

998

pinzetta a molla a becchi larghi diritti incrociati, zigrinati in acciaio inossidabile



L
mm
155

5 009980001

999

pinzetta a molla antiacido antimagnetica, a punte piatte arrotondate in acciaio inossidabile



L
mm
115

3 009990011

999A

pinzette a molla, antiacido antimagnetica, a punte corte finissime in acciaio inossidabile



L
mm
120

3 009990015

999B

pinzetta a molla, antiacido antimagnetica, a punte forti diritte in acciaio inossidabile



L
mm
120

3 009990017

999C

pinzetta a molla, antiacido antimagnetica, a punte finissime diritte in acciaio inossidabile



L
mm
110

3 009990019

999D

pinzetta a molla, antiacido antimagnetica, a punte finissime angolate, in acciaio inossidabile



L
mm
115

3 009990021

999E

pinzetta a molla, antiacido antimagnetica, a punte finissime curve in acciaio inossidabile



L
mm
120

3 009990023

999G

pinzetta a molla, antiacido, antimagnetica con dispositivo di bloccaggio, a punte finissime diritte in acciaio inossidabile



L
mm
140

3 009990027

999/B6N

serie di 6 pinzette a molla antiacido ed antimagnetiche



999/B6N
999-999A-999B
999C-999D-999E

1 009990060



1002

pinzetta autobloccante a becchi arrotondati, zigrinati in acciaio inossidabile

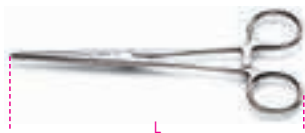

L
mm
160

2 010020001

1008

pinze a becchi piatti lunghi zigrinati
manici ricoperti con 2 strati
di PVC antiscivolo



ISO 5745

L L1
mm mm
160 51,5

5 010080006

1008BM

pinze a becchi piatti lunghi zigrinati
impugnatura bimatereale



ISO 5745

L L1
mm mm
160 51,5

3 010080036

1009

pinze a becchi mezzotondi lunghissimi
zigrinati
manici ricoperti con 2 strati
di PVC antiscivolo



ISO 5745

L L1
mm mm
160 56,5

2 010090006

1009L/A

pinza a becchi mezzotondi lunghissimi
diritti zigrinati, per impieghi speciali
manici ricoperti con 2 strati
di PVC antiscivolo



L L1
mm mm
283 80

2 010090008

1009L/B

pinza a becchi mezzotondi lunghissimi
zigrinati piegati a 45°
per impieghi speciali
manici ricoperti con 2 strati
di PVC antiscivolo



L L1
mm mm
273 73

2 010090009

1009L/C

pinza a becchi mezzotondi lunghissimi
zigrinati piegati a 90°
per impieghi speciali
manici ricoperti con 2 strati
di PVC antiscivolo



L L1
mm mm
253 45

2 010090010

1009L/D

pinza a becchi mezzotondi lunghissimi
diritti zigrinati, con doppio snodo
manici ricoperti con 2 strati
di PVC antiscivolo



L L1
mm mm
342 71

1 010090058

1009L/DP

pinza a becchi mezzotondi lunghissimi
zigrinati piegati a 45°, con doppio snodo
manici ricoperti con 2 strati
di PVC antiscivolo



L L1
mm mm
336 66

1 010090059

1009L/DP-S2

serie di 2 pinze a becchi mezzotondi
lunghissimi zigrinati
con doppio snodo



1009L/DP-S2

1 010090060

1010

pinze a becchi tondi lunghi
manici ricoperti con 2 strati
di PVC antiscivolo



ISO 5745

L L1
mm mm
160 51,5

2 010100006

1010BM

pinze a becchi tondi lunghi
impugnatura bimatereale



ISO 5745

L L1
mm mm
160 51,5

2 010100036



PINZE PER ANELLI ELASTICI DI SICUREZZA (SEEGER)

PERFETTO ALLINEAMENTO

I test hanno dimostrato che le pinze Beta garantiscono un ottimo allineamento del seeger (anello elastico) grazie alla speciale geometria a cono inverso delle punte, ottenibile solamente attraverso l'esclusivo stampaggio a freddo impiegato da Beta.



RIDOTTA ROTTURA PUNTE

Le pinze Beta hanno punte monolitiche non riportate, realizzate con stampaggio a freddo, che garantiscono una resistenza maggiore rispetto ai concorrenti sia in fase di utilizzo che di caduta accidentale.

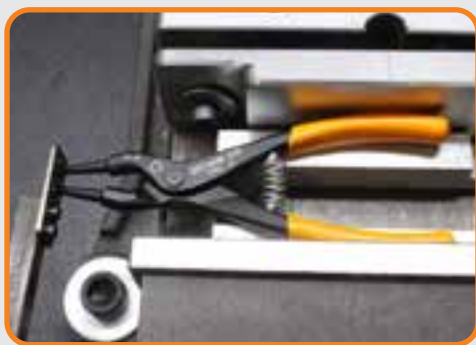

1031/S4

serie di 4 pinze per anelli elastici di sicurezza



1031/S4
1032 180 \odot 19 ÷ 60 mm
1034 170 \odot 19 ÷ 60 mm
1036 175 \bullet 19 ÷ 60 mm
1038 175 \bullet 19 ÷ 60 mm

1 010330000

1032

pinze a becchi dritti per anelli elastici di sicurezza, per fori manici ricoperti in PVC



UNI 7914 DIN 5256

L mm	\odot mm		
140x0,9	8÷12	5	010320013
140x1,3	12÷25	5	010320014
180	19÷60	5	010320017
225	40÷100	3	010320021
300	85÷200	2	010320028

1033

pinze a becchi piegati a 45° per anelli elastici di sicurezza, per fori manici ricoperti in PVC



UNI 7914 DIN 5256

L mm	\odot mm		
140x0,9	8÷12	5	010330013
140x1,3	12÷25	5	010330014
180	19÷60	5	010330017
225	40÷100	3	010330021

1034

pinze a becchi piegati a 90° per anelli elastici di sicurezza, per fori manici ricoperti in PVC



UNI 7914 DIN 5256

L mm	\odot mm		
130x0,9	8÷12	5	010340013
130x1,3	12÷25	5	010340014
170	19÷60	5	010340017
210	40÷100	3	010340021
290	85÷200	2	010340028

1034L

pinza a becchi piegati a 90° lunghi per anelli elastici di sicurezza, per fori manici ricoperti in PVC



L mm	\odot mm		
190	40÷100	2	010340320

1036

pinze a becchi dritti per anelli elastici di sicurezza per alberi manici ricoperti in PVC



UNI 7915 DIN 5254

L mm	\odot mm		
140x0,9	3÷10	5	010360013
140x1,3	10÷25	5	010360014
175	19÷60	5	010360017
225	40÷100	3	010360021
300	85÷200	2	010360028

1037

pinze a becchi piegati a 45° per anelli elastici di sicurezza per alberi manici ricoperti in PVC



UNI 7915 DIN 5254

L mm	\odot mm		
140x0,9	3÷10	5	010370013
140x1,3	10÷25	5	010370014
175	19÷60	5	010370017
225	40÷100	3	010370021

1038

pinze a becchi piegati a 90° per anelli elastici di sicurezza per alberi manici ricoperti in PVC



UNI 7915 DIN 5254

L mm	\odot mm		
135x0,9	3÷10	5	010380013
135x1,3	10÷25	5	010380014
175	19÷60	5	010380017
220	40÷100	3	010380021
300	85÷200	2	010380028

1039

pinza reversibile a becchi dritti
per anelli elastici di sicurezza per fori
e alberi, manici ricoperti in PVC



L mm	Ø mm	Ø mm	
150	10÷15	6÷25	2 010390015

1558/C4

attrezzo per anelli seeger interni ed esterni
con azionamento a vite

grazie all'attacco quadro si applica una forza elevata
in entrambe le condizioni d'utilizzo
Puntali in dotazione:
Ø 2,5-3-3,5 mm



1558/C4	5,5 ÷ 77	5,5 ÷ 77	
	Ø mm	Ø mm	1 015580100

330x220x50 mm - 900 g

1044

pinza regolabile
cerniera sovrapposta
manici ricoperti con 2 strati di PVC antiscivolo

· modello a nove posizioni



ISO 8976

L mm	A max mm	L1 mm	
250	48	39	5 010440250

1044F

pinza regolabile, fosfatata
cerniera sovrapposta
manici ricoperti in PVC
· modello a nove posizioni



ISO 8976

L mm	A max mm	L1 mm	
250	48	39	5 010440015

1047

pinza regolabile a pulsante,
manici ricoperti con due strati
di PVC antiscivolo



L mm	A max mm	L1 mm	
180	30	29	2 010470180
240	36	35	2 010470240
300	50	48	1 010470300

1047BM

pinza regolabile a pulsante con impugnatura
bimateriale



L mm	A max mm	L1 mm	
240	36	35	2 010470340

POLIGRIP - 1048N PINZA REGOLABILE A CERNIERA CHIUSA

PRESA ECCEZIONALE E SORPRENDENTE
MANEGGEVOLEZZA

- Geometria e angolo dei denti studiati per una presa efficace e sicura sia su profili esagonali che cilindrici
- Denti temprati ad induzione per una maggiore durata
- Maggiore ampiezza dell'angolo testa-impugnatura per una migliore ergonomia
- Fermo di contrasto per evitare lo schiacciamento accidentale della mano
- Manici ricoperti con innovativo PVC antiscivolo
- Maneggevolezza e comfort straordinari grazie alla ampliata superficie di contatto dell'impugnatura



1048N

pinze regolabili cerniera chiusa
manici ricoperti con PVC antiscivolo



ISO 8976

L mm	A max mm	L1 mm	S mm	
175	36	31	11	3 010480910
250	46	38	13	5 010480915
300	60	44	14.8	2 010480920

1048N/D3

serie di pinze regolabili cerniera chiusa

testa fosfatata



1048N/D3
175-250-300 mm

1 010480923

1048BM

pinza regolabile a cerniera chiusa,
impugnatura bimateriale

· modello a nove posizioni



ISO 8976

L mm	A max mm	L1 mm	
250	48	39	3 010480215

1048VN

pinze regolabili cerniera chiusa
verniciate arancio



ISO 8976

L mm	A max mm	L1 mm	
175	36	31	3 010480111
250	46	38	5 010480116
300	60	44	2 010480121

1050

pinza autobloccante a doppia regolazione

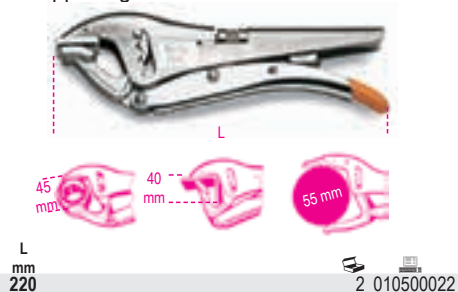

1051

pinza autobloccante a doppia regolazione, ganasce lunghe



1051GM

pinza autobloccante a doppia regolazione, ganascia oscillante

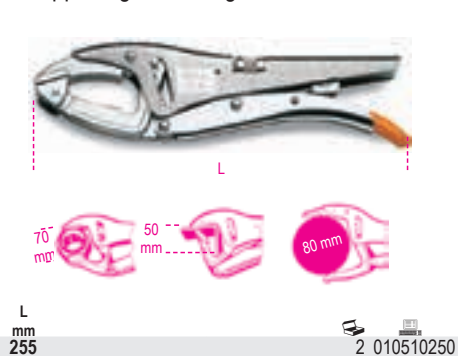

1051L

pinza autobloccante a doppia regolazione a grande capacità



1051XL

pinza autobloccante a doppia regolazione a grande capacità, ganasce extra lunghe

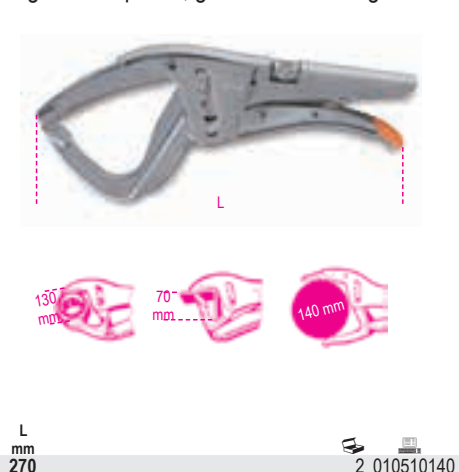

1052

pinze regolabili autobloccanti ganasce concave

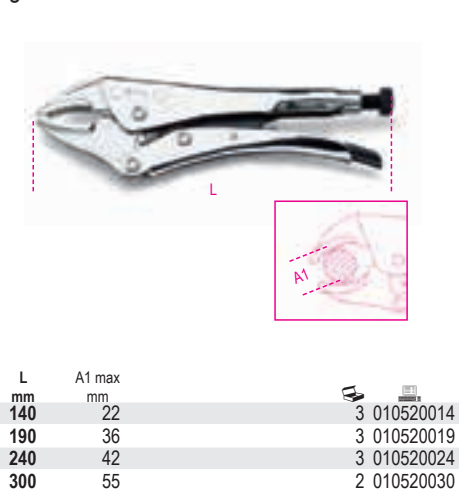

1053

pinza regolabile autobloccante ganascia oscillante



1054

pinza regolabile autobloccante ganasce diritte

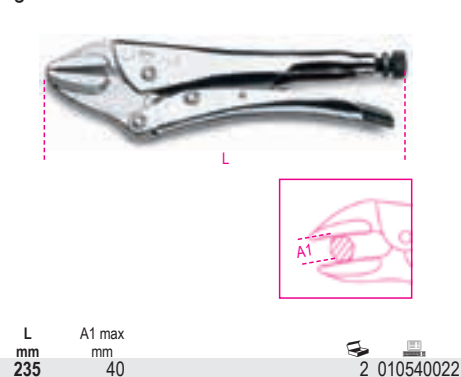

1055

pinza regolabile autobloccante ganasce sagomate

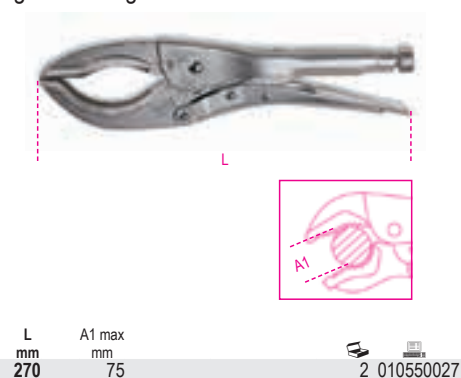

1055D

pinze regolabili autobloccanti per dadi e profili cilindrici

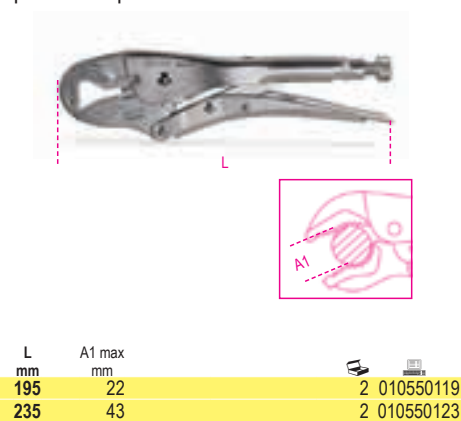

1056

pinza regolabile autobloccante per frigoristi



1057A

pinza automatica autobloccante con regolazione della forza



L			
mm			
240	2	010570124	

1058

pinze regolabili autobloccanti becchi lunghi

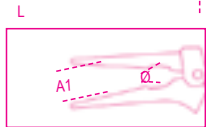

L	A1 max	Ø max	
mm	mm	mm	
175	34	26	2 010580017
225	46	31	2 010580025

1059

pinze regolabili autobloccanti con una ganaschia parallela mobile

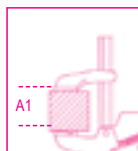
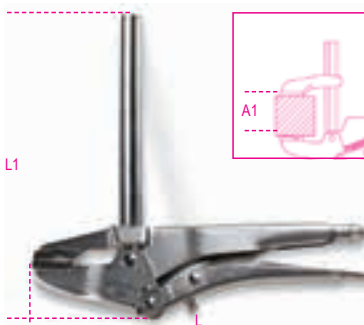

L1	L	A1	
mm	mm	mm	
160	255	120	1 010590016
270	255	220	1 010590027



1060

pinze regolabili autobloccanti ganasce a forcella

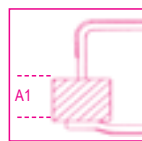

L	A1 max		
mm	mm		
200	50	2	010600020
280	80	2	010600028

1061

pinza regolabile autobloccante ganasce a forcella

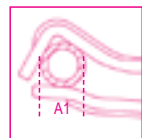

L	A1 max		
mm	mm		
275	80	2	010610027

1062

pinze regolabili autobloccanti ganasce a collo di cigno

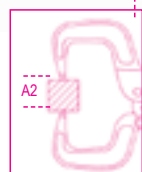

L	A2 max		
mm	mm		
170	50	2	010620017
290	120	2	010620029
460	255	1	010620045

1062AL

pinza regolabile autobloccante ganasce a collo di cigno in alluminio

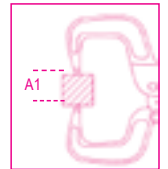

L	A1 max		
mm	mm		
275	88	2	010620327

1062GM

pinze regolabili autobloccanti ganasce a collo di cigno oscillanti

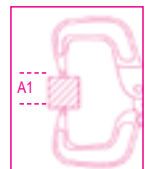

L	A1 max		
mm	mm		
170	45	2	010620217
290	88	2	010620229
460	255	1	010620245

1063

pinza regolabile autobloccante per lattonieri



L	A1 max		
mm	mm		
200	31	2	010630021



1064

pinza regolabile autobloccante
a catena



L	Ø		
mm	mm		
230	150	2	010640023

1065F

pinza foralamiera



Ø	L		
mm	mm		
5	228	1	010650010
6	228	1	010650015

1065P

pinza piegalamiera



L			
mm			
228	15 mm	1	010650020

1066

pinza regolabile autobloccante
bloccaggio a 90°



L	A1 max	g	
mm	mm		
210	55	500	1 010660021

1067

pinze regolabili autobloccanti per tubolari,
ganasse blocca tubo snodabili



L	A1 max		
mm	mm		
285	76	1	010670285
380	89	1	010670380

1077

pinza a becchi larghi dritti
per lattonieri
manici ricoperti in PVC



L	A	L1	
mm	mm	mm	
280	60	53	1 010770026

1078

pinza a becchi larghi piegati a 45°
per lattonieri
manici ricoperti in PVC



L	A	L1	
mm	mm	mm	
280	60	77	1 010780026

1080D

tronchesi a taglienti diagonali rasi
manici ricoperti con 2 strati
di PVC antiscivolo

Per taglio di materiali plastici

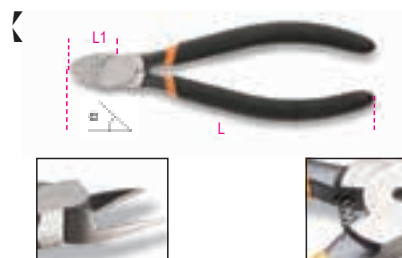

α	L	L1	
°	mm	mm	
15°	160	22	3 010800015
45°	160	22	3 010800045

1081

tronchese a tagliente semiraso
manici ricoperti con 2 strati
di PVC antiscivolo

• Per micromeccanica ed elettronica gravosa



L	L1		
mm	mm		
125	16	3	010810130

1082

tronchesi a taglienti diagonali,
cromati
manici ricoperti con 2 strati di PVC antiscivolo



UNI/ISO 5749

L	L1	≠	
mm	mm	mm	
140	20	1,6	5 010820004
160	22	1,6	5 010820006

1082G

tronchesi a taglienti diagonali
manici ricoperti con 2 strati
di PVC antiscivolo
finitura industriale

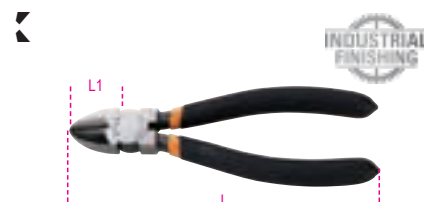

UNI/ISO 5749

L	L1	≠	
mm	mm	mm	
140	20	1,6	5 010820064
160	22	1,6	5 010820066

1082BM

tronchesi a taglienti diagonali
impugnatura bimateriale



UNI/ISO 5749

L	L1	≠	
mm	mm	mm	
140	20	1,6	3 010820034
160	22	1,6	3 010820036

1082GBM

tronchesi a taglianti diagonali
impugnatura bimatereale
finitura industriale



UNI/ISO 5749

L mm	L1 mm	≠ mm	🔧	📦
140	20	1,6	3	010820264
160	22	1,6	3	010820266

1084

tronchesi a grande effetto
a taglianti diagonali,
cromati,
manici ricoperti con 2 strati di PVC antiscivolo



UNI/ISO 5749

L mm	L1 mm	≠ mm	🔧	📦
160	22	1,6	5	010840006
200	28	2,0	3	010840010

1084G

tronchesi a grande effetto
a taglianti diagonali, manici ricoperti
con 2 strati di PVC antiscivolo
finitura industriale



UNI/ISO 5749

L mm	L1 mm	≠ mm	🔧	📦
160	22	1,6	5	010840066
200	28	2,0	3	010840070

1084BM

tronchesi a grande effetto
a taglianti diagonali,
cromati,
impugnatura bimatereale



UNI/ISO 5749

L mm	L1 mm	≠ mm	🔧	📦
160	22	1,6	3	010840036
200	28	2,0	3	010840040

1084GBM

tronchesi a grande effetto
a taglianti diagonali,
impugnatura bimatereale,
finitura industriale



UNI/ISO 5749

L mm	L1 mm	≠ mm	🔧	📦
160	22	1,6	3	010840266
200	28	2,0	3	010840270

1088

tronchesi a grande effetto
a taglianti frontali
manici ricoperti con 2 strati
di PVC antiscivolo



UNI/ISO 5748

L mm	L1 mm	≠ mm	🔧	📦
160	9	1,6	2	010880006
200	11	2,0	2	010880010

1088BM

tronchesi a grande effetto
a taglianti frontali
impugnatura bimatereale



UNI/ISO 5748

L mm	L1 mm	≠ mm	🔧	📦
160	9	1,6	2	010880036
200	11	2,0	2	010880040

1092V

tronchesi a doppia leva
a taglianti frontali
tipo pesante



UNI/ISO 5748

L mm	L1 mm	≠ mm	🔧	📦
180	8	2,0	2	010920280
200	9	2,5	2	010920310

1094V

tronchesi a doppia leva
taglianti diagonali
tipo pesante



UNI/ISO 5749

L mm	L1 mm	≠ mm	🔧	📦
200	23	2,5	2	010940200

1095N

tronchesi a doppia leva
a taglianti diagonali



L mm	L1 mm	≠ mm	🔧	📦
195	26	1,6	2	010950010

1096

tenaglie per falegnami



ISO 9243

L mm	L1 mm	🔧	📦
160	21	5	010960016
200	23	5	010960020
250	30	5	010960025



1098

tenaglie per cementisti



ISO 9242 DIN 5242

L	L1		
mm	mm		
190	12	5	010980190
220	13	5	010980220
250	15	5	010980250
280	18	5	010980280

1098PL

tenaglie per cementisti
manici ricoperti in PVC



ISO 9242 DIN 5242

L	L1		
mm	mm		
220	13	5	010980320
250	15	5	010980350
280	18	5	010980380

1101

troncabulloni



L	L1		
mm	mm		
300	12	2	011010030
350	14	2	011010035
450	18	1	011010045
600	24	1	011010060
750	30	1	011010075
900	36	1	011010090

L	R = 80	R = 140	i	
mm	Kgf/mm ²	Kgf/mm ²	g	
	Ø mm	Ø mm		
300	5	4	745	
350	6	5	1043	
450	7	6	1537	
600	9	7	2540	
750	11	8	3870	
900	12	9	6170	



1101R

lame di ricambio per 1101



mm	1101		
300	300	1	011010130
350	350	1	011010135
450	450	1	011010145
600	600	1	011010160
750	750	1	011010175
900	900	1	011010190

1102

minitroncabulloni

R = 80 Kgf/mm²



L			
mm	mm		
230	4	3	011020020

1103

troncabulloni a testa piatta
per rondini, bulloni e reti elettrosaldate per
cemento

Ømax = 12 mm
Ømax (HRC 48) = 6 mm

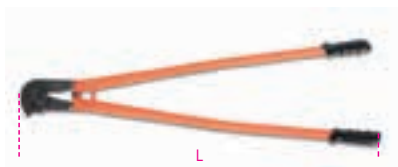

L			
mm	mm		
950		1	011030090

1103R

testa di ricambio per 1103



1103R 950		1	011030190

1104

tagliafuni per funi flessibili in acciaio
impugnatura in materiale plastico



L			
mm	mm		
420	12	1	011040004
600	16	1	011040006

1104R

lame di ricambio per 1104



mm			
420		1	011040014
600		1	011040016

1105

fustelle in acciaio
brunite



D	L		
mm	mm		
2	27	1	011050002
3	27	1	011050003
4	27	1	011050004
5	27	1	011050005
6	27	1	011050006
7	27	1	011050007
8	27	1	011050008
9	27	1	011050009
10	27	1	011050010
12	27	1	011050012
14	27	1	011050014
16	27	1	011050016
18	27	1	011050018
20	27	1	011050020
22	32	1	011050022
24	32	1	011050024
26	32	1	011050026
28	32	1	011050028
30	32	1	011050030
32	37	1	011050032
34	37	1	011050034
36	37	1	011050036
38	37	1	011050038
40	37	1	011050040
42	42	1	011050042
44	42	1	011050044
46	42	1	011050046
48	42	1	011050048
50	42	1	011050050

1105T20

battifustella per fustelle 1105
da 2 a 20 mm



L
mm
110

1 011050200

1105T30

battifustella per fustelle 1105
da 2 a 30 mm



L
mm
175

1 011050205

1105T50

battifustella per fustelle 1105
da 2 a 50 mm



L
mm
175

1 011050207

1105AD-50

adattatore per battifustella 1105T50



∅
mm
57

1 011050210

1105/C10T

assortimento di 10 fustelle
da 3 a 20 mm e 1 accessorio



L
mm
110

1 011050250

1105/C10T

1105 3 - 4 - 6 - 8 - 10 - 12 - 14 - 16 - 18 - 20 mm
1105T20
135x92x32 mm

1105/C16T

assortimento di 15 fustelle
da 3 a 30 mm e 1 accessorio



1105/C16T

1105 3 - 4 - 6 - 8 - 10 - 12 - 14 - 16 - 18 - 20 - 22 - 24 - 26 - 28 - 30 mm
1105T30
240x210x60 mm

1105/C32T

assortimento di 29 fustelle
da 2 a 50 mm e 3 accessori



1105/C32T

1105 2 - 3 - 4 - 5 - 6 - 7 - 8 - 9 - 10 - 12 - 14 - 16 - 18 - 20 - 22 - 24 - 26 - 28 - 30 - 32 - 34 - 36 - 38 - 40 - 42 - 44 - 46 - 48 - 50 mm
1105T50
1105AD-50
455x380x115 mm

1112

cesoie modello americano
lame larghe diritte

R = 60 Kg/mm²



L L1 S A
mm mm mm mm
200 50 0,5 26
250 62 0,8 33
300 76 1,0 37
375 76 1,2 44

1114

cesoie modello americano
lame strette diritte
R = 60 Kg/mm²

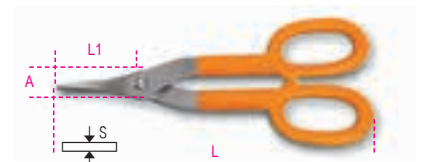

L L1 S A
mm mm mm mm
250 58 0,5 15
350 76 1 22

1118

cesoia antinfortunistica per taglio reggia

Fe = acciaio comune
Inox = acciaio inossidabile



L L1 Fe S Inox S
mm mm mm mm mm
310 42 1 0,8

1120A

cesoia roditrice

Fe = acciaio comune



L Fe S
mm mm mm
280 1,2

1120ARL - ARG

ricambi per 1120A



1120ARL 1 011200110
1120ARG 1 011200120

1122

cesoia a doppia leva
lame diritte

Inox = acciaio inossidabile



L L1 Inox S A
mm mm mm mm
250 40 1 24

1123

cesoia a doppia leva destrorsa
lame curve

Inox = acciaio inossidabile



L	L1	Inox	A		
mm	mm	S mm	mm		
250	40	1	24	2	011230020

1124

cesoia a doppia leva sinistrorsa
lame curve

Inox = acciaio inossidabile



L	L1	Inox	A		
mm	mm	S mm	mm		
250	40	1	24	2	011240020

1125

cesoia a doppia leva
per tagli dritti e destrorsi

Inox = acciaio inossidabile

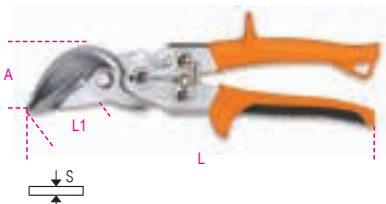

L	L1	Inox	A		
mm	mm	S mm	mm		
250	35	1	46	2	011250020

1126

cesoia a doppia leva
per tagli dritti e sinistrorsi

Inox = acciaio inossidabile

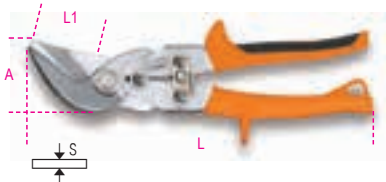

L	L1	Inox	A		
mm	mm	S mm	mm		
250	35	1	46	2	011260020

1122 - 1125MOL



1122 MOL	1122 - 1124	1	011220010
1123 MOL	1123	1	011230010
1125 MOL	1125 - 1126	1	011250040

1127

forbici per telefonisti lame dritte



L	L1		
mm	mm		
150	35	5	011270001

1128BAX

forbici per elettricisti a **doppio effetto**,
con profili a fresa in acciaio inossidabile
rivestito in DLC

taglio a doppio effetto: attraverso una speciale camma sul fulcro si ottiene uno scorrimento longitudinale delle lame che, nella fase di chiusura, ne aumenta la potenza di taglio.

profilo a fresa: studiate per allargare fori su plastica da 13 a 25 mm.

rivestimento DLC: Il DLC (diamond-like carbon) è un rivestimento innovativo a base di carbonio: l'elevata durezza ed il basso coefficiente d'attrito nascono dalla simultanea presenza di carbonio depositato sulla superficie in forma di grafite e diamante.

- alta durezza superficiale delle lame (resistenza all'abrasione e mantenimento dell'affilatura nel tempo)
- basso coefficiente di attrito (scorrevolezza e potenza di taglio)
- perno eccentrico antiallentamento
- manici ampi con gole strozzatubi



L	L1	≠		
mm	mm	mm ²		
150	50	50	5	011280088

1128BMX

forbici per elettricisti
lame dritte in acciaio inossidabile
con microdentatura



L	L1		
mm	mm		
147	58,2	5	011280051

1128BMX/F

custodia in plastica
per 1128BMX



1128BMX/F		1	011280059
-----------	--	---	-----------



Beta

1128FXS FORBICI PER ELETTRICISTI CON SVASATORE

Abbiamo ridisegnato la forbice per elettricisti osservando il lavoro quotidiano degli utilizzatori. L'abbiamo resa un utensile universale, inglobando le 4 funzioni principali in un unico oggetto.

TAGLIO rapido e netto per cavi fino a 50 mm² grazie alla gola trancia-cavo e a una lama microdentata per una maggior presa.

SPELLATURA la sensibilità del perno anti-allentamento permette di spellare con precisione anche i cavi più fini.

CRIMPATURA sicura e resistente nel tempo per terminali a tubetto.

SVASATURA l'esclusivo profilo a fresa consente di svasare i fori delle cassette di derivazione in maniera precisa e pulita.



1128BAX FORBICI PER ELETTRICISTI A DOPPIO EFFETTO, CON PROFILI A FRESA IN ACCIAIO INOSSIDABILE RIVESTITO IN DLC

Le forbici 1128BAX si caratterizzano per la finitura delle lame in DLC. Il DLC (diamond-like carbon) è un rivestimento innovativo a base di carbonio. L'elevata durezza ed il basso coefficiente d'attrito nascono dalla simultanea presenza di carbonio depositato sulla superficie in forma di Grafite e Diamante.

- Alta durezza superficiale delle lame - resistenza all'abrasione e mantenimento dell'affilatura nel tempo
- Basso coefficiente di attrito - scorrevolezza e potenza di taglio

Profilo a fresa: studiato per allargare fori su plastica da 13 a 25 mm.



+DUREZZA
-COEFFICIENTE D'ATTRITO



1128BSX

forbici per elettricisti con svasatore
lame dritte in acciaio inossidabile

- studiate per allargare fori su plastica e chiudere tubi corrugati
- con custodia plastica



L	L1	
mm	mm	
148	58,2	5 011280061

1128FX

forbici per elettricisti
lame dritte in acciaio inossidabile con microdentatura, gola trancia-cavo e crimpatore per terminali a tubetto.

- Custodia agganciabile alla cintura
- Impugnatura bimatereale
- Perno anti-allentamento



L	L1	$\#$
mm	mm	mm ²
145	52	50
5 011280090		

1128FXS

forbici per elettricisti con svasatore
lame in acciaio inossidabile con microdentatura, gola trancia-cavo e crimpatore per terminali a tubetto.

- Custodia agganciabile alla cintura
- Impugnatura bimatereale
- Perno anti-allentamento
- profilo e fresa: studiate per allargare fori su plastica da 13 a 21 mm.



L	L1	$\#$
mm	mm	mm ²
145	52	50
5 011280095		

1128BM

forbici per elettricisti
lame dritte



L	L1	
mm	mm	
145	50	5 011280000

1129BM

forbici per elettricisti
lame curve



L	L1	
mm	mm	
145	44	5 011290000

1130BMX

forbici multuso
lame dritte in acciaio inossidabile con microdentatura



L	L1	
mm	mm	
185	60	1 011300002

1131CK

forbici per Kevlar® e fibre ottiche

in acciaio specificatamente studiato per operare su materiali antitaglio come fibre aramidiche
Anche per fibre ottiche



L	L1	
mm	mm	
203	75	1 011310001

1132

tagliacavi
manici ricoperti con 2 strati
di PVC antiscivolo per taglio di cavi isolati
di rame e alluminio



UNI 8791

L	mm	mm ²		
170	14	50	2	011320107
230	18	95	2	011320113

1132BM

tagliacavi
impugnatura bimateriale
per cavi isolati in rame e alluminio



UNI 8791

L	mm	mm ²		
170	14	50	2	011320137
230	18	95	2	011320143

1133

tagliacavi
per cavi in rame flessibile



L	mm	mm ²		
600	32	300	1	011330001

1133RL

lama di ricambio per 1133



1133RL 1 011330011

1134

tagliacavi a cricchetto



L	mm	mm	mm ²		
260	35	400	1	011340032	

1134RL

lama di ricambio per 1134



1134RL 1 011340132

1134A

tagliacavi a cricchetto



L	mm	mm	mm ²		
240	45	500	1	011340045	

1134A/RL

lama di ricambio per 1134A



1134A/RL 1 011340145



1142BM

pinza spellafili
impugnatura bimateriale



UNI 7923

L	mm	mm ²	mm		
160	0,5÷6	0-2,8	3	011420036	

1143

pinza spellafili



L	mm	mm ²	mm		
165	0,5÷6	1-3,2	1	011430001	

1143R

lama di ricambio per 1143

1143R 1 011430011

1144D

spellacavi con lama regolabile per tagli
trasversali e longitudinali



L	mm	mm ²	mm		
170	4,5÷240	2,5-18	1	011440010	

1144D/RG

gancio di ricambio per 1144D



1144D/RG 1 011440012

1144D/RL

lama di ricambio per 1144D

1144D/RL 1 011440011

1144G

spellacavi con lama regolabile per tagli
trasversali e longitudinali



L	mm	mm ²	mm		
140	6÷75	2.8-12	1	011440004	

1144G/RL

lama di ricambio per 1144G



1144G/RL 1 011440005

1144L

spellacavi con lama regolabile per tagli trasversali e longitudinali

con lama retrattile liscia ed a uncino



L mm 145
mm² 6-150
mm 4-28
1 011440050

1144T

spellacavi tascabile regolabile, con dispositivo di taglio



L mm 112
mm 3,5 ÷ 9
g 40
1 011440060

1148A

pinza spellafili autoregolabile con dispositivo di taglio



L mm 190
mm² 0,02÷10
mm 0-4
1 011480100

1148A/R

lama di ricambio per 1148A



1148A/R 1 011480102



1148B

pinza spellafili autoregolabile con dispositivo di taglio



L mm 190
mm² 4÷16
mm 2-5
1 011480200

1148B/R

lama di ricambio per 1148B



1148B/R 1 011480202

1148P

pinza spellafili autoregolabile con dispositivo di taglio



L mm 165
mm² 0.2-6
mm 0-3.5
1 011480300

1149F

pinza spellafili frontale autoregolabile, con dispositivo di taglio



L mm 175
mm² 0,2 ÷ 6
1 011490010

1150

pinze universali a grande effetto, cromate
manici ricoperti con 2 strati di PVC antiscivolo

• Il perno decentrato aumenta l'effetto leva, riducendo lo sforzo, per un taglio di grande potenza.

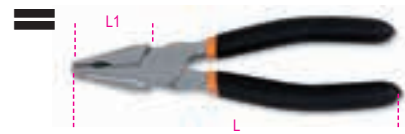

ISO 5746

L mm	L1 mm	mm		
160	42	1,6	5	011500046
180	46	1,8	5	011500048
200	50	2,0	5	011500050
220	50	2,0	2	011500052

1150G

pinze universali a grande effetto
manici ricoperti con 2 strati di PVC antiscivolo
finitura industriale

• Il perno decentrato aumenta l'effetto leva, riducendo lo sforzo, per un taglio di grande potenza.



ISO 5746

L mm	L1 mm	mm		
160	42	1,6	5	011500066
180	46	1,8	5	011500068
200	50	2,0	5	011500070
220	50	2,0	2	011500072



1150HPC PINZA UNIVERSALE HYPERCUT CON TAGLIENTI IN ACCIAIO SINTERIZZATO M2

- Il perno decentrato avvicina il fulcro al punto di taglio, aumentando l'effetto leva
- Il perfetto allineamento dei becchi e il profilo assottigliato garantiscono presa sicura anche in spazi molto ristretti
- Il corpo della pinza utilizza l'affidabile acciaio al molibdeno lavorato termicamente per essere flessibile e resistente e garantire una presa sicura in ogni condizione

Sforzo di taglio prova statica = **-73%**

Vita media dei taglienti = (test ISO 5744) **+127%**

Durezza dei taglienti M2 = **65HRC**

- **INNOVAZIONE ASSOLUTA**
- **FINITURA CROMATA PERLATA**
- **GRANDE FORZA DI TAGLIO**



1150HPC

pinza universale a **grande effetto** con tagliente a inserto, perno decentrato, cromata perlata, impugnatura bi-materiale, cassetta aperta

tagliente a inserto
acciaio: M2
spessore: 0.20 mm
angolo: 62°
durezza: 65 HRC



ISO 5746

L	L1	≠		
mm	mm	mm		
180	42	1,8	2	011500618

1150BM

pinze universali a **grande effetto**, cromate, impugnatura bimateriale

- Il perno decentrato aumenta l'effetto leva, riducendo lo sforzo, per un taglio di grande potenza.



ISO 5746

L	L1	≠		
mm	mm	mm		
160	42	1,6	3	011500146
180	46	1,8	3	011500148
200	50	2,0	3	011500150
220	50	2,0	2	011500152

1150GBM

pinze universali a **grande effetto** impugnatura bimateriale finitura industriale

- Il perno decentrato aumenta l'effetto leva, riducendo lo sforzo, per un taglio di grande potenza.



ISO 5746

L	L1	≠		
mm	mm	mm		
160	42	1,6	3	011500266
180	39	1,8	3	011500268
200	50	2,0	3	011500270
220	50	2,0	2	011500272

1153

pinza regolabile a due posizioni manici ricoperti con 2 strati di PVC antiscivolo



UNI ISO 9343

L	L1			
mm	mm			
200	34		2	011530120

1162

pinze a becchi piatti lunghissimi diritti zigrinati cromate manici ricoperti con 2 strati di PVC antiscivolo



ISO 5745

L	L1	≠		
mm	mm	mm		
160	58	1,6	5	011620006
200	86	1,6	5	011620010



1162G

pinze a becchi piatti
lunghe e dritte zigrinate
manici ricoperti con 2 strati di PVC antiscivolo
finitura industriale



ISO 5745

L	L1	≠		
mm	mm	mm		
160	58	1,6	5	011620066
200	86	1,6	5	011620070

1162BM

pinze a becchi piatti
lunghe e dritte zigrinate
cromate
impugnatura bimatereale



ISO 5745

L	L1	≠		
mm	mm	mm		
160	58	1,6	3	011620036
200	86	1,6	3	011620040

1162GBM

pinze a becchi piatti
lunghe e dritte zigrinate
impugnatura bimatereale
finitura industriale



ISO 5745

L	L1	≠		
mm	mm	mm		
160	58	1,6	3	011620266
200	86	1,6	3	011620270

1164

pinze a becchi piatti
lunghe e piegate zigrinate
manici ricoperti con 2 strati
di PVC antiscivolo



ISO 5745

L	L1	≠		
mm	mm	mm		
160	54	1,6	5	011640006
200	76	1,6	5	011640010

1164BM

pinze a becchi piatti
lunghe e piegate zigrinate
impugnatura bimatereale



ISO 5745

L	L1	≠		
mm	mm	mm		
160	54	1,6	3	011640036
200	76	1,6	3	011640040

1166

pinze a becchi mezzotondi
lunghe e dritte zigrinate
cromate
manici ricoperti con 2 strati
di PVC antiscivolo



ISO 5745

L	L1	≠		
mm	mm	mm		
160	56	1,6	5	011660006
200	76	1,6	5	011660010

1166G

pinze a becchi mezzotondi
lunghe e dritte zigrinate
manici ricoperti con 2 strati
di PVC antiscivolo
finitura industriale

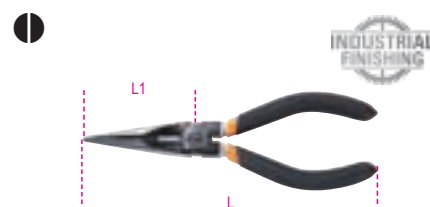

ISO 5745

L	L1	≠		
mm	mm	mm		
160	56	1,6	5	011660066
200	76	1,6	5	011660070

1166BM

pinze a becchi mezzotondi
lunghe e dritte zigrinate
cromate
impugnatura bimatereale



ISO 5745

L	L1	≠		
mm	mm	mm		
160	56	1,6	3	011660036
200	76	1,6	3	011660040

1166GBM

pinze a becchi mezzotondi
lunghe e dritte zigrinate
impugnatura bimatereale
finitura industriale



ISO 5745

L	L1	≠		
mm	mm	mm		
160	56	1,6	3	011660266
200	76	1,6	3	011660270

1168

pinze a becchi mezzotondi
lunghe e piegate zigrinate
cromate
manici ricoperti con 2 strati
di PVC antiscivolo



ISO 5745

L	L1	≠		
mm	mm	mm		
160	54	1,6	5	011680006
200	76	1,6	5	011680010

1168G

pinze a becchi mezzotondi
lunghe e piegate zigrinate
manici ricoperti con 2 strati
di PVC antiscivolo
finitura industriale



ISO 5745

L	L1	≠		
mm	mm	mm		
160	54	1,6	5	011680066
200	76	1,6	5	011680070

1168BM

pinze a becchi mezzotondi lunghissimi
piegati zigrinati
cromate
impugnatura bimatereale



ISO 5745

L	L1	mm		
mm	mm	mm		
160	54	1,6	3	011680036
200	70	1,6	3	011680040

1168GBM

pinze a becchi mezzotondi lunghissimi
piegati zigrinati
impugnatura bimatereale
finitura industriale



ISO 5745

L	L1	mm		
mm	mm	mm		
160	54	1,6	3	011680266
200	70	1,6	3	011680270

1169/D3

assortimento di 1 pinza universale,
1 pinza becchi mezzotondi lunghi
e 1 tronchese, con 2 strati di PVC
antiscivolo
cromati



1169/D3	
1082 160mm	1 011690053
1150 180mm	
1166 160mm	

1169G/D3

assortimento di 1 pinza universale,
1 pinza becchi mezzotondi lunghi
e 1 tronchese, con 2 strati di PVC
antiscivolo
con finitura industriale



1169G/D3	
1082G 160mm	1 011690073
1150G 180mm	
1166G 160mm	

1169BM/D3

assortimento di 1 pinza universale,
1 pinza becchi mezzotondi lunghi
e 1 tronchese, impugnatura bimatereale
cromati



1169BM/D3	
1082BM 160mm	1 011690133
1150BM 180mm	
1166BM 160mm	

1169GBM/D3

assortimento di 1 pinza universale,
1 pinza becchi mezzotondi lunghi
e 1 tronchese, impugnatura bimatereale,
con finitura industriale



1169GBM/D3	
1082GBM 160mm	1 011690273
1150GBM 180mm	
1166GBM 160mm	

1171BM

pinza per elettronica
a becchi piatti corti lisci
impugnatura bimatereale

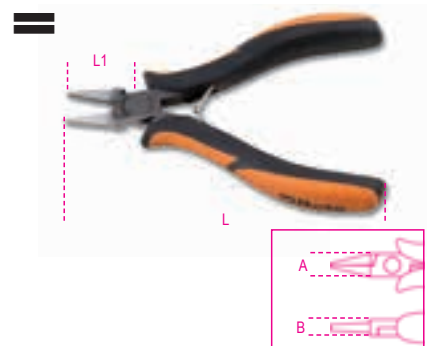

ISO 9655

L	L1	A	B		
mm	mm	mm	mm		
130	18	12	8	2	011710101

1172BM

pinza per elettronica
a becchi piatti lunghi lisci
impugnatura bimatereale

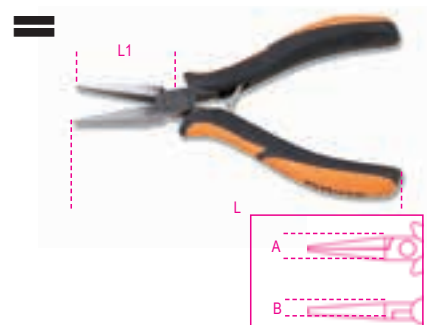

ISO 9655

L	L1	A	B		
mm	mm	mm	mm		
140	40	12	8	2	011720101

1172BM/P

pinza per elettronica
a becchi piatti lunghi piegati lisci
impugnatura bimatereale

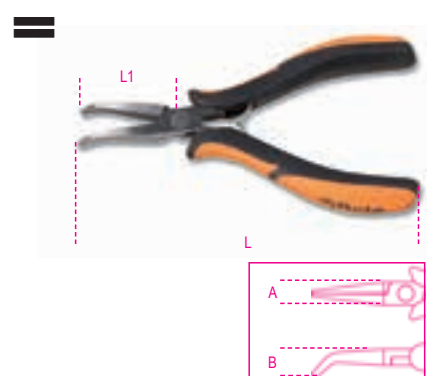

L	L1	A	B		
mm	mm	mm	mm		
140	38	12	13	2	011720102



1173BM

pinza per elettronica
a becchi tondi corti
impugnatura bimateriale



ISO 9655

L	L1	A	B
~ 125	mm 22	mm 12	mm 8

2 011730101

1175BM

pinza per elettronica
a becchi mezzotondi corti lisci
impugnatura bimateriale

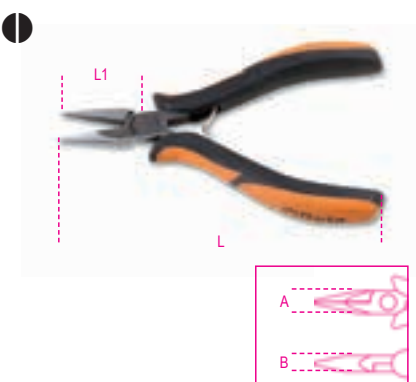

ISO 9655

L	L1	A	B
~ 140	mm 29	mm 12	mm 8

2 011750101

1177BM

pinza per elettronica
a becchi mezzotondi lunghi lisci
impugnatura bimateriale

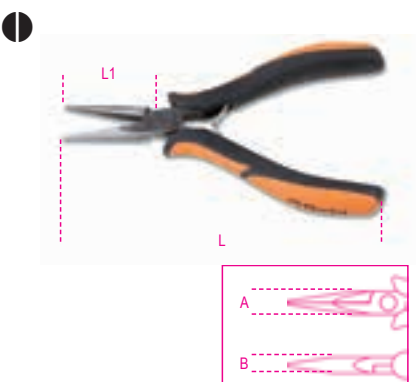

ISO 9655

L	L1	A	B
~ 140	mm 38	mm 12	mm 8

2 011770101

1177BM/Z

pinza per elettronica
a becchi mezzotondi lunghi zigrinati
impugnatura bimateriale

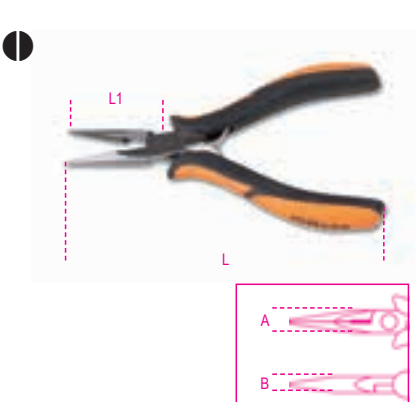

ISO 9655

L	L1	A	B
~ 140	mm 39	mm 12	mm 8

2 011770113

1178BM

pinza per elettronica
a becchi mezzotondi lunghi lisci rastremati
impugnatura bimateriale

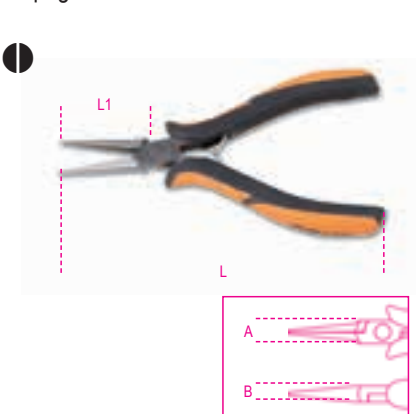

ISO 9655

L	L1	A	B
~ 140	mm 37	mm 12	mm 8

2 011780101

1178BM/P

pinza per elettronica
a becchi mezzotondi lunghi lisci rastremati
piegati
impugnatura bimateriale

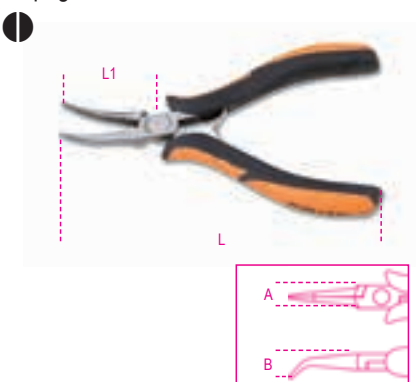

L	L1	A	B
~ 140	mm 36,5	mm 12	mm 12

2 011780102

Seguono tronchesi per rame.
Per usi più gravosi vedere l'articolo 1081

1182BM

tronchese per elettronica
a taglienti diagonali semirasi
becchi assottigliati
impugnatura bimateriale



ISO 9654

L	L1	A	Cu
mm 120	mm 11	mm 10	mm 1

2 011820101

1183BM

tronchese per elettronica
a taglienti diagonali semirasi
becchi arrotondati
impugnatura bimateriale



ISO 9654

L	L1	A	Cu
mm 120	mm 11	mm 10	mm 1

2 011830101



1184BM

tronchese per elettronica
a taglienti diagonali rasi
becchi arrotondati
impugnatura bimatereale



ISO 9654

L	L1	A	Cu		
mm	mm	mm	mm		
120	11	10	1	2	011840101
130	13	12,5	1,25	2	011840102

1185BM

tronchese per elettronica
a taglienti diagonali rasi
becchi assottigliati
impugnatura bimatereale



ISO 9654

L	L1	A	Cu		
mm	mm	mm	mm		
120	11	10	1	2	011850101
130	13	12,5	1,25	2	011850102

1186BM

tronchese per elettronica
a taglienti diagonali rasi
becchi assottigliati scaricati
impugnatura bimatereale



ISO 9654

L	L1	A	Cu		
mm	mm	mm	mm		
120	11	10	1	2	011860101
130	13	12,5	1,25	2	011860102

1188BM

tronchese per elettronica
a taglienti diagonali normali
impugnatura bimatereale



ISO 9654

L	L1	A	Cu		
mm	mm	mm	mm		
125	12	12	1,25	2	011880101
130	17	15	2	2	011880102

1190BM

tronchese per elettronica
a taglienti frontali normali
impugnatura bimatereale



ISO 9654

L	L1	A	Cu		
mm	mm	mm	mm		
120	12	12	1,25	2	011900113

1191BM

tronchese per elettronica
a taglienti obliqui rasi
becchi lunghi sottili
impugnatura bimatereale



ISO 9654

L	L1	A	Cu		
mm	mm	mm	mm		
130	8	12	0,8	2	011910101

1191BM/L

tronchese per elettronica
a taglienti obliqui rasi e spellafilo
impugnatura bimatereale



ISO 9654

L	L1	A	Cu		
mm	mm	mm	mm		
130	18	12	1	2	011910110

1191R/5-M

kit molle di ricambio per pinze e tronchesi per
elettronica, 5 coppie (Artt.: 1171...1191)

1191R/5-M

1 011910995

1200MS

magnetizzatore-smagnetizzatore

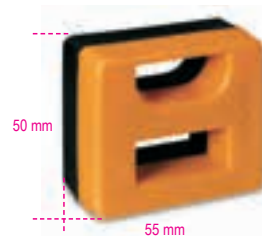

1200MS

5 012000000



Beta **EVOLX**

L'EVOLUZIONE DEL GIRAVITE!

Il design ergonomico si adatta perfettamente al palmo della mano. L'ampia superficie di contatto permette di trasmettere il massimo della forza con il minore sforzo.

Le collaudate lame Beta offrono elasticità, durezza e resistenza all'usura ai vertici della categoria dei giravite professionali.

La sezione ottagonale evita il fastidioso rotolamento sul piano di lavoro. L'area di precisione permette al giravite di girare rapidamente tra le dita.

Facilmente appendibile grazie al foro sull'impugnatura.

La nuova gomma termoplastica rende ancora più confortevole ogni utilizzo, anche il più gravoso.

Impronta e misura sono riportate sulla calotta sferica per una rapida individuazione

● Le collaudate lame Beta offrono **elasticità, durezza e resistenza** all'usura ai vertici della categoria dei giravite professionali

● Il **design ergonomico** si adatta perfettamente al palmo della mano. L'ampia superficie di contatto permette di trasmettere il massimo della forza con il minore sforzo

● La **sezione ottagonale** evita il fastidioso rotolamento sul piano di lavoro

● La nuova gomma termoplastica rende ancora più **confortevole** ogni utilizzo, anche il più gravoso

● Novità assoluta è la sua **appendibilità**, grazie al foro sull'impugnatura



● Impronta e misura sono riportate sulla **calotta sferica** per una rapida individuazione

● L'**area di precisione** permette al giravite di girare rapidamente tra le dita



1201E

giravite per viti a testa con intaglio



ISO 2380

SxAxL mm	L1 mm	Ø mm		
0,4x2,5x50	146	2,5	5	012011003
0,4x2,5x75	166	2,5	5	012011006
0,5x3x75	171	3,0	5	012011009
0,5x3x100	196	3,0	5	012011012
0,6x3,5x75	171	3,5	5	012011018
0,6x3,5x100	196	3,5	5	012011021
0,8x4x100	196	4,0	5	012011030
0,8x4x125	221	4,0	5	012011033
0,8x4x150	246	4,0	5	012011036
1,0x5,5x100	209	5,0	5	012011039
1,0x5,5x125	234	5,0	5	012011040
1,0x5,5x150	259	5,0	5	012011042
1,2x6,5x100	220	6,0	5	012011048
1,2x6,5x125	234	6,0	5	012011050
1,2x6,5x150	270	6,0	5	012011051
1,2x8x150	282	8,0	3	012011057
1,2x8x200	332	8,0	3	012011060
1,6x10x200	332	9,5	3	012011066



1201E/S6

0,5x3x75-0,6x3,5x100
0,8x4x100-1,0x5,5x100
1,2x8x150-1,6x10x200 mm

1 012011206

1201EN

giravite per viti a testa con intaglio tipo cortissimo



ISO 2380

SxAxL mm	L1 mm	Ø mm		
0,8x4x30	86,5	4	3	012011103
1,2x6,5x30	86,5	6	3	012011106

1201E/DZ

giravite per viti con impronta Dzus®



L mm	L1 mm		
53	173	2	012011501

1202E

giravite per viti con impronta a croce Phillips®



UNI-ISO 8764

PHxDxL mm	L1 mm		
0x3x60	156	5	012021003
0x3x100	200	5	012021006
1x4,5x80	189	5	012021009
1x4,5x120	229	5	012021012
2x6x100	220	5	012021018
2x6x150	270	5	012021021
3x8x150	282	3	012021024
4x9,5x200	332	3	012021027



1202E/S4	1	012021204
PH0x3x60-PH1x4,5x120 PH2x6x150-PH3x8x150 mm		

1202EN

giravite per viti con impronta a croce Phillips® tipo cortissimo



UNI-ISO 8764

PHxDxL mm	L1 mm		
1x4,5x30	86,5	3	012021103
2x6x30	86,5	3	012021106

1202EL

giravite per viti con impronta a croce Phillips®, tipo lungo



UNI-ISO 8764-1

PHxDxL mm	L1 mm		
0x3x300	400	3	012021303
1x4,5x300	400	3	012021305
1x4,5x400	508	3	012021306
2x6x400	519	3	012021309

1203E/D

serie giravite



1203E/D5	1	012031001	
1201E	0,6x3,5x100-1,0x5,5x150 1,2x6,5x150 mm		
1202E	PH1x4,5x80-PH2x6x100 mm		

1203E/D5PZ	1	012031003	
1201E	0,5x3x75-0,8x4x125 1,0x5,5x150 mm		
1209E/PZ	PZ1x4,5x80-PZ2x6x100 mm		

1203E/D6	1	012031006	
1202E	PH1x4,5x80-PH2x6x100 mm		
1204E	0,4x2,5x60-0,5x3x100 0,8x4x100-1,0x5x125 mm		

1203E/D7	1	012031007	
1201E	0,5x3x75-0,8x4x100 1,0x5,5x100-1,2x6,5x150 mm		
1202E	PH0x3x60-PH1x4,5x80 PH2x6x100 mm		

1203E/D8	1	012031008	
1201E	0,5x3x75-0,8x4x125 1,0x5,5x150-1,2x6,5x150 mm		
1202E	PH0x3x60-PH1x4,5x80 PH2x6x100-PH3x8x150 mm		

1203E/D8P	1	012031018	
1201E	2,5x50-3x75-4x100-5,5x100- 6,5x150 mm		
1202E	PH0x60-PH1x80-PH2x100 mm		

1203E/D10	1	012031010	
1201E	0,4x2,5x50-0,5x3x75 0,8x4x100-1,0x5,5x100 1,2x6,5x150-1,2x8x150 mm		
1202E	PH0x3x60-PH1x4,5x80 PH2x6x100-PH3x8x150 mm		

1203E/D10N	1	012031019	
1201E	0,4x2,5x50-0,5x3x75-0,8x4x100- 1,0x5,5x150-1,2x6,5x150 mm		
1201EN	0,8x4x30 mm		
1202E	PH0x3x60-PH1x4,5x80- PH2x6x100 mm		
1202EN	PH1x4,5x30 mm		



1203E/S

Beta evorx



1203E/S8	1	012031009	
1201E	2,5x50-3x75-4x100-5,5x125- 6,5x150 mm		
1202E	PH0x3x60-PH1x4,5x80- PH2x6x100 mm		

1203E/S10	1	012031021	
1201E	0,4x2,5x50-0,5x3x75 0,8x4x125-1,0x5,5x150 1,2x6,5x150-1,2x8x150 mm		
1202E	PH0x3x60-PH1x4,5x80 PH2x6x100-PH3x8x150 mm		

1204E

giravite per viti senza testa con intaglio



ISO 2380

SxDxL mm	L1 mm		
0,4x2,5x60	156	5	012041003
0,6x3x75	175	5	012041006
0,5x3x100	196	5	012041009
0,8x4x100	196	5	012041012
0,8x4x125	233	5	012041015
1x5x125	234	5	012041018
1x5x150	258	5	012041021
1,2x6,5x150	270	5	012041024



1204E/S5	1	012041205
0,4x2,5x60-0,5x3x100 0,8x4x100-1x5x125 1,2x6,5x150 mm		

1204EL

giravite per viti senza testa con intaglio tipo lungo



ISO 2380

SxDxL mm	L1 mm		
0,5x2,5x200	300	3	012041303
0,5x3x300	400	3	012041306
0,8x4x400	508	3	012041309
1x5x400	508	3	012041315
1,2x6,5x400	519	3	012041318

1205E/ES

chiavi maschio esagonale con impugnatura



mm	L mm	L1 mm		
1,5	100	200	3	012051315
2	100	200	3	012051320
2,5	100	200	3	012051325
3	100	200	3	012051330
4	100	208	3	012051340
5	100	219	3	012051350
6	125	244	3	012051360
8	150	277	2	012051380



1205E/ES-S8
1,5-2-2,5-3-4-5-6-8 mm

1206E/BP

chiavi maschio esagonale ad estremità sferica con impugnatura



mm	L mm	L1 mm	Ø mm		
2	100	198	2,5	3	012061320
2,5	100	198	3,0	3	012061325
3	100	198	3,5	3	012061330
4	100	209	5,0	3	012061340
5	100	220	6,0	3	012061350
6	125	245	7,0	3	012061360
8	150	287	9,5	2	012061380



1206E/BP-S7
2-2,5-3-4-5-6-8 mm

1207E/TX

chiavi maschio con impugnatura per viti con impronta Torx®



	L mm	L1 mm	Ø mm		
T5	50	150	3	5	012071005
T6	60	156	4	5	012071006
T7	60	156	4	5	012071007
T8	60	156	4	5	012071008
T9	60	156	4	5	012071009
T10	80	189	5	5	012071010
T15	80	189	5	5	012071015
T20	100	209	5	5	012071020
T25	100	209	5	5	012071025
T27	100	220	6	5	012071027
T30	100	220	6	5	012071030
T40	130	262	7	2	012071040
T45	130	262	8	2	012071045



1207E/TX-D7
T6-T8-T10-T15
T20-T25-T30

1207E/TX-D13
T5-T6-T7-T8-T9-T10-T15
T20-T25-T27-T30-T40-T45

1208E/RTX

chiavi maschio con impugnatura per viti con impronta Tamper Resistant Torx®



	L mm	L1 mm	Ø mm		
T9	60	156	4	5	012081009
T10	80	189	5	5	012081010
T15	80	189	5	5	012081015
T20	100	209	5	5	012081020
T25	100	209	5	5	012081025
T27	100	220	6	5	012081027
T30	100	220	6	5	012081030
T40	130	262	7	2	012081040



1208E/RTX-D7
T9-T10-T15-T20
T25-T27-T30

1209E/PZ

giravite per viti con impronta a croce Pozidriv®-Supadriv®



UNI-ISO 8764

PZ	L mm	L1 mm		
0	60	156	5	012091000
1	80	189	5	012091003
2	100	220	5	012091006
3	150	282	3	012091009
4	200	327	3	012091012



1209E/PZ-S4
PZ0-PZ1-PZ2-PZ3

1209EN/PZ

giravite per viti con impronta a croce Pozidriv®-Supadriv® tipo cortissimo



ISO 8764

PZ	L mm	L1 mm		
1	30	87	3	012091103
2	30	87	3	012091106



1229LP

microgiravite per viti senza testa con intaglio

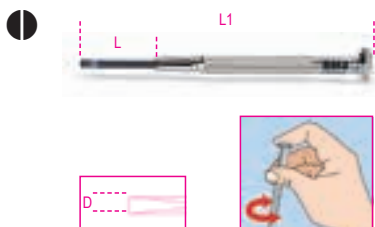

D mm	L mm	L1 mm		
1,0	17	75	5	012290210
1,2	21	85	5	012290212
1,4	21	89	5	012290214
1,8	23	94	5	012290218
2,0	23	98	5	012290220
2,4	26	103	5	012290224
3,0	28	108	5	012290230



1229LP/A6	1	012290300
1,2-1,4-1,8-2,2-4-3 mm		

1229PH

microgiravite per viti con impronta a croce Phillips®

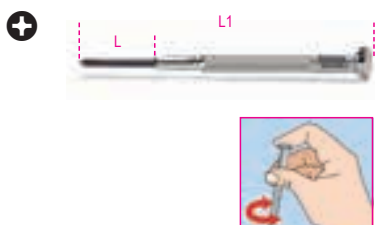

PH	L mm	L1 mm		
0	26	102	5	012290250
1	29	107	5	012290251

1229LPH/A6

serie di 6 microgiravite
1229LP - 1229PH



1229LPH/A6	1	012290310
1229LP	1,4-2,0-2,4-3 mm	
1229PH	PH0-PH1	

1236B

giravite a squadra per viti a testa con intaglio

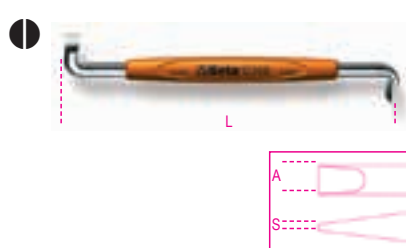

UNI 7079 DIN 5200

SxA	L		
mm	mm		
0,8x4	100	5	012360201
1x5,5	125	5	012360202
1,2x8	150	5	012360204

1238B

giravite a squadra per viti con impronta a croce Phillips®



UNI 7083 DIN 5208

PH	L		
	mm		
1-2	125	5	012380201
3-4	200	5	012380203

1241

giravite a battere per viti a testa con intaglio

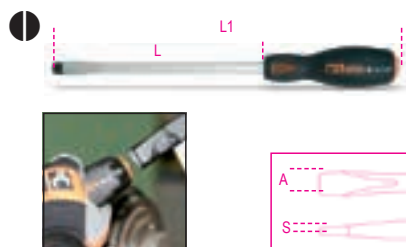

ISO 2380

SxAxL	L1		
mm	mm		
1x5,5x100	202	5	012410039
1,2x6,5x125	240	5	012410050
1,2x8x150	268	3	012410057
1,6x10x175	300	2	012410065
1,6x10x200	325	2	012410066
2,0x12x200	325	2	012410067
2,5x14x250	375	2	012410076



1242

giravite a battere per viti con impronta a croce Phillips®

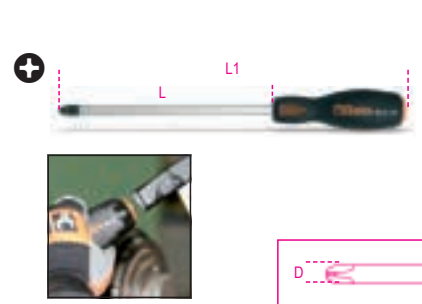

UNI/ISO 8764

PHxDxL	L1		
mm	mm		
1x4,5x100	202	5	012420209
2x6x100	215	5	012420218
3x8x150	268	3	012420221
4x11x200	325	2	012420224

1243LP/D6

serie di 6 giravite a battere per viti a testa con intaglio



1243LP/D6	1	012430016
1241	1x5,5x100-1,2x6,5x125-3x8x150-1,6x10x175-2,0x12x200-2,5x14x250 mm	

1243/D7

serie di 7 giravite a battere



1243/D7	1	012430017
1241	1x5,5x100-1,2x6,5x125-1,2x8x150-1,6x10x200 mm	
1242	PH1x4,5x100-PH2x6x100-PH3x8x150 mm	

1243/S11

serie di 11 giravite a batteria



1243/S11 1 012430021

1241	1x5,5x100-1,2x6,5x125 3x8x150-1,6x10x175
1242	1,6x10x200-2,0x12x200-2,5x14x250 PH1x4,5x100-PH2x6x100-PH3x8x150 PH4x11x200 mm

1250

giravite prensili per viti a testa con intaglio



SxDxL mm	L1 mm	
0,5x3x125	190	5 012500030
0,6x4x125	225	5 012500040
0,7x5x150	255	5 012500050

1251

giravite prensili per viti con impronta a croce Phillips®



PHxDxL mm	L1 mm	
0x4x125	225	5 012510000
1x5x125	225	5 012510010
2x6x175	280	5 012510020

1252/S5



1252/S5 1 012520001

1250	0,5x3x125-0,6x4x125 0,7x5x150 mm
1251	PH1x5x150-PH2x6x175 mm

1253

giravite cercafase 150/250V

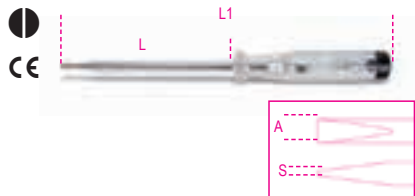

SxAxL mm	L1 mm	
0,5x3,5x100	190	5 012530001

1253A

giravite cercafase 125/250V doppio isolamento

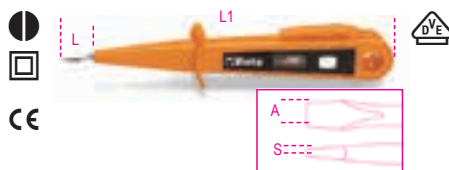

SxAxL mm	L1 mm	
0,5x3x15	150	5 012530010

1254

giravite provacircuito 6÷24V

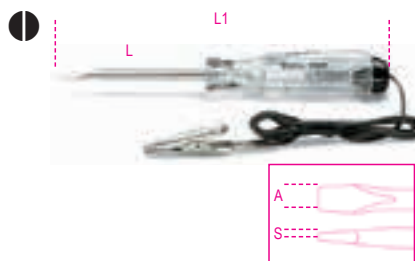

SxAxL mm	L1 mm	
0,5x3x44	123	5 012540001

1256/C36-2

microgiravite con 36 inserti intercambiabili da 4 mm e prolunga magnetica



1256/C36-2 1 012560100

	1256TX	T3 - T4 - T5 - T6 - T7 T8 - T9 - T10 - T15
	1256RTX	T6 - T7 - T8 - T9 - T10
	1256LP	0,8 - 1,2 - 1,5 - 1,8 - 2 - 2,5 3 - 3,5 - 4 mm
	1256PE	0,7 - 0,9 - 1,3 - 1,5 - 2 mm
	1256PH	PH000 - PH00 - PH0 - PH1
	1256PZ	PZ000 - PZ00 - PZ0 - PZ1
	1256/20	
	1256/30	

130x60x35 mm - 200 g

1256LP

inserti 4 mm per viti a testa con intaglio

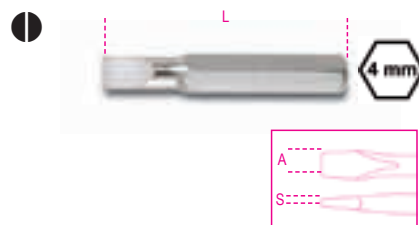

SxA mm	L mm	
0.25x0.8	27	5 012560001
0.25x1.2	27	5 012560002
0.3x1.5	27	5 012560003
0.35x1.8	27	5 012560004
0.4x2.0	27	5 012560005
0.4x2.5	27	5 012560006
0.5x3.0	27	5 012560007
0.6x3.5	27	5 012560008
0.8x4.0	27	5 012560009

1256PH

inserti 4 mm per viti con impronta Phillips®



PH	L mm	
000	27	5 012560011
00	27	5 012560012
0	27	5 012560013
1	27	5 012560014

1256PZ

inserti 4 mm per viti con impronta Pozidriv® - Supradriv®



PZ	L mm	
000	27	5 012560061
00	27	5 012560062
0	27	5 012560063
1	27	5 012560064

1256PE

inserti 4 mm per viti con impronta esagonale



mm	L mm	
0.7	27	5 012560021
0.9	27	5 012560022
1.3	27	5 012560023
1.5	27	5 012560024
2.0	27	5 012560025

1256TX

inserti 4 mm
per viti con impronta Torx®



	L mm		
T3	27	5	012560041
T4	27	5	012560042
T5	27	5	012560043
T6	27	5	012560044
T7	27	5	012560045
T8	27	5	012560046
T9	27	5	012560047
T10	27	5	012560048
T15	27	5	012560049

1256RTX

inserti 4 mm
per viti con impronta Tamper Resistant Torx®



	L mm		
T6	27	5	012560051
T7	27	5	012560052
T8	27	5	012560053
T9	27	5	012560054
T10	27	5	012560055

1256/20

prolunga con attacchi esagonali
maschio e femmina da 4 mm



1256/20 5 012560092

1256/30

portainseri da 4 mm con impugnatura



L mm 110 2 012560097

1257LP

microgiravite per viti senza testa
con intaglio



SxD mm	L mm		
0,25x1,2	60	5	012570012
0,23x1,5	60	5	012570015
0,3x1,8	60	5	012570018
0,4x2	60	5	012570020
0,4x2,5	60	5	012570024
0,5x3	60	5	012570030
0,6x3,5	60	5	012570035
0,8x4	60	5	012570040



1257LP/S8 1 012570200
0,2x1,2-0,25x1,5
0,3x1,8-0,4x2-0,4x2,5
0,5x3-0,6x3,5-0,8x4 mm

1257PH

microgiravite per viti
con impronta a croce Phillips®



PH	L mm		
00	60	5	012570060
0	60	5	012570063
1	60	5	012570066

1257LPH/S8



1257LPH/S8 1 012570210
1257PH PH00-PH0-PH1
1257LP 0,4x2-0,4x2,5-0,5x3
0,6x3,5-0,8x4 mm

1257ES

microgiravite a chiave maschio
esagonale



mm	L mm		
0,9	60	5	012570045
1,3	60	5	012570046
1,5	60	5	012570047
2	60	5	012570048
2,5	60	5	012570049
3	60	5	012570050

1257ESB/S8



1257ESB/S8 1 012570230
1257ES 0,9-1,3-1,5-2-2,5-3 mm
1257BE 4-5 mm

1257TX

microgiravite a chiave maschio
per viti con impronta Torx®



	L mm		
T5	60	5	012570075
T6	60	5	012570076
T7	60	5	012570077
T8	60	5	012570078
T9	60	5	012570079
T10	60	5	012570080
T15	60	5	012570081
T20	60	5	012570082



1257TX/S8 1 012570220
T5-T6-T7-T8
T9-T10-T15-T20

1257BE

microgiravite
chiave bussola esagonale



mm	L mm		
3,2	60	5	012570085
4	60	5	012570086
5	60	5	012570087
5,5	60	5	012570088



I giravite Beta Grip nascono dalla pluriennale esperienza di Beta nella progettazione di giravite e dalla stretta collaborazione con i meccanici dei team delle competizioni motoristiche. Per raggiungere i più alti obiettivi di ergonomia, resistenza e qualità dei materiali sono state utilizzate nuove ed esclusive soluzioni tecniche in grado di soddisfare anche le richieste dei professionisti più esigenti.

- La **lama** è realizzata con un acciaio speciale a elevato tenore di silicio, cromo e vanadio per garantire maggiori prestazioni in termini di resistenza alla torsione e flessione. La cromatura è di tipo satinato antiriflesso.

- La **geometria della punta** è stata studiata per garantire un accoppiamento perfetto tra la lama e la testa della vite. La finitura fosfatata evita l'ossidazione della punta e ne conserva la precisione dei profili.

- La **texture** è stata realizzata prendendo di ispirazione il battistrada dei pneumatici Racing, studiati per massimizzare la tenuta su diverse tipologie di terreno. Permette dunque un'efficace presa sul cacciavite in qualsiasi condizione di lavoro, migliorando la precisione e il controllo nella fase di centraggio della punta sulla vite.



1260

giravite per viti a testa con intaglio



ISO 2380

SxAxL mm	L1 mm	Ø mm		
0,4x2,5x50	150	2,5	5	012600003
0,4x2,5x75	175	2,5	5	012600006
0,5x3x75	175	3,0	5	012600009
0,5x3x100	200	3,0	5	012600012
0,6x3,5x75	175	3,5	5	012600018
0,6x3,5x100	200	3,5	5	012600021
0,8x4x100	208	4,0	5	012600030
0,8x4x125	233	4,0	5	012600033
0,8x4x150	258	4,0	5	012600036
1x5,5x100	208	5,0	5	012600039
1x5,5x125	233	5,0	5	012600040
1x5,5x150	258	5,0	5	012600042
1,2x6,5x100	219	6,0	5	012600048
1,2x6,5x125	244	6,0	5	012600050
1,2x6,5x150	269	6,0	5	012600051
1,2x8x150	277	8,0	3	012600057
1,2x8x200	327	8,0	3	012600060
1,6x10x200	327	9,5	3	012600066
2x12x250	377	10	3	012600069
2x14x250	377	10	2	012600073



1260/S6

0,4x2,5x75-0,5x3x75-0,8x4x125
1x5,5x150-1,2x6,5x150-1,2x8x200 mm

1 012600306

1260N

giravite per viti a testa con intaglio
tipo cortissimo



ISO 2380

SxAxL mm	L1 mm	Ø mm		
0,8x4x30	87	4	5	012600103
1,2x6,5x30	87	6	5	012600106



1260E

giravite con esagono di manovra per viti a testa con intaglio



ISO 2380

SxAxL mm	L1 mm	Ø mm		
1,2x6,5x150	269	6,0	3	012600156
1,2x8x175	301	8,0	3	012600157
1,6x10x200	327	9,5	2	012600159
2x12x250	377	9,5	2	012600162

1260MC

giravite per viti a testa con intaglio colorato



SxAxL mm	L1 mm	Ø mm		
0,4x2,5x50	150	2,5	3	012602003
0,6x3,5x75	175	3,5	3	012602018
0,8x4x100	208	4,0	3	012602030
1x5,5x125	233	5,0	5	012602040
1,2x6,5x150	269	6,0	5	012602051

1262

giravite per viti con impronta a croce Phillips®



UNI/ISO 8764

PHxDxL mm	L1 mm		
0x3x60	160	5	012620003
0x3x100	200	5	012620006
1x4,5x80	188	5	012620009
1x4,5x120	228	5	012620012
2x6x100	219	5	012620018
2x6x150	269	5	012620021
3x8x150	277	3	012620024
4x10x200	327	3	012620027



1262/S4

PH0x3x60-PH1x4,5x80
PH2x6x100-PH3x8x150 mm

1 012620304

1262N

giravite per viti con impronta a croce Phillips® tipo cortissimo



UNI/ISO 8764

PHxDxL mm	L1 mm		
1x4,5x30	87	5	012620103
2x6x30	87	5	012620106

1262E

giravite con esagono di manovra per viti con impronta a croce Phillips®



UNI/ISO 8764

PHxDxL mm	L1 mm		
2x6x150	269	3	012620153
3x8x175	302	3	012620156
4x10x200	327	2	012620159

1262L

giravite per viti con impronta a croce Phillips®, tipo lungo



UNI/ISO 8764-1

PHxDxL mm	L1 mm		
0x3x300	400	3	012620203
1x4,5x300	400	3	012620205
1x4,5x400	508	3	012620206
2x6x400	519	3	012620209

1262MC

giravite per viti con impronta a croce Phillips® colorato



PHxDxL mm	L1 mm		
0x3x60	160	3	012622003
1x4,5x80	188	3	012622009
2x6x100	219	3	012622018

1263/D...

serie giravite



1263/D6			
1260	0,5x3x75-0,8x4x100 1x5,5x125-1,2x6,5x150 mm	1	012630006
1262	PH1x4,5x80-PH2x6x100 mm		



1263/D7			
1262	PH0x3x60 PH1x4,5x80 PH2x6x100 mm	1	012630017
1264	0,5x2,5x60-0,6x3x100 0,8x4x125-1x5x125 mm		



1263/D7PZ			
1260	0,5x3x75-0,8x4x100 1x5,5x150-1,2x6,5x150 mm	1	012630007
1269PZ	PZ0 - PZ1 - PZ2		



1263/D8			
1260	0,4x2,5x50-0,5x3x75 0,8x4x100-1x5,5x125 1,2x6,5x150 mm	1	012630008
1262	PH0x3x60-PH1x4,5x80 PH2x6x100 mm		



1263/D10			
1260	0,5x3x75-0,6x3,5x100 0,8x4x125-1x5,5x150 1,2x6,5x150 mm	1	012630010
1260N	0,8x4x30		
1262	PH0x3x60-PH1x4,5x80 PH2x6x100 mm		
1262N	PH1x4,5x30		

1263/S12

serie di 12 giravite



1263/S12



1 012630112

1260	0,4x2,5x50-0,5x3x75 0,6x3,5x100-0,8x4x125 1x5,5x125-1,2x6,5x150 1,2x8x200-1,6x10x200 mm
1262	PH0x3x60-PH1x4,5x80 PH2x6x100-PH3x8x150 mm

1263MC/D8

serie 8 giravite colorati



1263MC/D8



1 012632008

1260MC	0,4x2,5x50-0,5x3x75 0,8x4x100-1x5,5x125 1,2x6,5x150 mm
1262MC	PH0x3x60-PH1x4,5x80 PH2x6x100 mm

1264

giravite per viti senza testa con intaglio tipo lungo



SxDxL mm	L1 mm		
0,5x2,5x60	160	5	012640003
0,6x3x75	175	5	012640006
0,6x3x100	200	5	012640009
0,8x4x100	208	5	012640012
0,8x4x125	233	5	012640015
1x5x125	233	5	012640018
1x5x150	258	5	012640021
1,2x6,5x150	269	5	012640024



1264/S5

0,5x2,5x60-0,6x3x75
0,8x4x100-1x5x125-1,2x6,5x150 mm



1 012640305

1264L

giravite per viti senza testa con intaglio tipo lungo



SxDxL mm	L1 mm		
0,5x2,5x200	300	3	012640203
0,6x3x300	400	3	012640206
0,8x4x400	508	3	012640209
1x5x400	508	3	012640215
1,2x6,5x400	519	3	012640218

1265ES

chiavi maschio esagonale con impugnatura



mm	L mm	L1 mm		
1,5	100	200	3	012650015
2	100	200	3	012650020
2,5	100	200	3	012650025
3	100	200	3	012650030
4	100	208	3	012650040
5	100	219	3	012650050
6	125	244	3	012650060
8	150	277	2	012650080



1265ES/S8

1,5-2-2,5-3-4-5-6-8 mm



1 012650308

1266BP

chiavi maschio esagonale ad estremità sferica con impugnatura



mm	L mm	L1 mm		
2	100	200	3	012660020
2,5	100	200	3	012660025
3	125	225	3	012660030
4	125	233	3	012660040
5	120	239	3	012660050
6	140	259	3	012660060
8	160	287	2	012660080
10	160	287	2	012660100



1266BP/S8

2-2,5-3-4-5-6-8-10 mm



1 012660308

1267TX

chiavi maschio con impugnatura per viti con impronta Torx®



mm	L mm	L1 mm	Ø mm		
T5	50	150	3	5	012670005
T6	50	150	3	5	012670006
T7	50	150	3	5	012670007
T8	60	160	3	5	012670008
T9	60	167	4	5	012670009
T10	80	188	4	5	012670010
T15	80	188	4	5	012670015
T20	100	208	4,5	5	012670020
T25	100	208	5	5	012670025
T27	115	234	6	5	012670027
T30	115	234	6	5	012670030
T40	130	257	7	2	012670040
T45	130	257	8	2	012670045



1267TX/D7
T6-T8-T10-T15
T20-T25-T30

1 012670307



1267TX/S13
T5-T6-T7-T8-T9
T10-T15-T20-T25
T27-T30-T40-T45

1 012670312

1267MC/TX

chiavi maschio con impugnatura per viti con impronta Torx® colorate



	L mm	L1 mm	Ø mm		
T6	50	150	3	5	012672006
T8	60	160	3	5	012672008
T10	80	188	4	5	012672010
T15	80	188	4	5	012672015
T20	100	208	4,5	5	012672020
T25	100	208	5	3	012672025
T30	115	234	6	3	012672030



1267MC/TX-D7
T6-T8-T10-T15
T20-T25-T30

1 012672307

1268RTX

chiavi maschio con impugnatura per viti con impronta Tamper Resistant Torx®



	L mm	L1 mm	Ø mm		
T9	60	167	4,0	3	012680009
T10	80	188	4,0	3	012680010
T15	80	188	4,0	3	012680015
T20	100	208	4,5	3	012680020
T25	100	208	5,0	3	012680025
T27	115	234	6,0	3	012680027
T30	115	234	6,0	3	012680030
T40	130	257	7,0	2	012680040



1268RTX/S8
T9-T10-T15-T20
T25-T27-T30-T40

1 012680307

1269PZ

giravite per viti con impronta a croce Pozidriv®-Supadriv®



UNI/ISO 8764

	L mm	L1 mm		
PZ 0	60	160	5	012690000
1	80	188	5	012690001
2	100	219	5	012690002
3	150	277	3	012690003
4	200	327	3	012690004



1269PZ/S4
PZ0-PZ1-PZ2-PZ3

1 012690304

1269N/PZ

giravite per viti con impronta a croce Pozidriv®-Supadriv® tipo cortissimo



UNI/ISO 8764

	L mm	L1 mm		
PZ 1	30	87	5	012690011
2	30	87	5	012690012

1281BG

impugnatura porta lame giravite



L mm	Ø mm		
118	10	5	012810280

1281PM

portainseri magnetico ad innesto rapido



L mm		
165	5	012810292

1281PB

portabussole quadro maschio 1/4"



L mm		
175	5	012810293

1281LP

giravite bivalenti per viti a testa con intaglio



1281LP/1 0,8x4-1,2x6,5 mm	5 012810302
1281LP/2 1x5,5-1,2x6,5 mm	5 012810304

1281PH

giravite bivalenti per viti con impronta a croce Phillips®



PH	
1-2	5 012810310
2-3	5 012810312

1281LPH

giravite bivalenti per viti a testa con intaglio e Phillips®



1281LPH/1	5 012810321
PH0-0,8x4 mm	
1281LPH/2	5 012810322
PH1-1x5,5 mm	
1281LPH/3	5 012810323
PH2-1,2x6,5 mm	

1281PZ

giravite bivalenti per viti con impronta a croce Pozidriv®-Supadriv®



PZ	
1-2	5 012810330
2-3	5 012810332

1281PE

chiavi maschio esagonale bivalenti con un'estremità sferica



mm	
2,5	5 012810342
3	5 012810343
4	5 012810344
5	5 012810345
6	5 012810346

1281TX

chiavi maschio bivalenti per viti con impronta Torx®

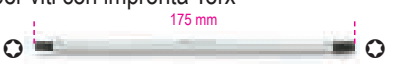

1281TX/1	5 012810349
T6-T8	
1281TX/2	5 012810350
T7-T9	
1281TX/3	5 012810351
T10-T15	
1281TX/4	5 012810352
T20-T25	
1281TX/5	5 012810353
T30-T40	

1281RTX

chiavi maschio bivalenti per viti con impronta Tamper Resistant Torx®



1281RTX/3	5 012810361
T10-T15	
1281RTX/4	5 012810362
T20-T25	
1281RTX/5	5 012810363
T30-T40	

1281BG/A9

assortimento di 9 giravite bivalenti e 1 impugnatura di manovra, in astuccio



1281BG/A9	1 012810520
-----------	-------------

1281BG	
1281LPH/1	PH0-0,8x4 mm
1281LPH/2	PH1-1x5,5 mm
1281LPH/3	PH2-1,2x6,5 mm
1281PZ/1	PZ1-PZ2
1281PE	2,5 mm
1281PE	3 mm
1281PE	4 mm
1281PE	5 mm
1281PE	6 mm

1281BG-TX/A8

assortimento di 8 giravite bivalenti e 1 impugnatura di manovra, in astuccio



1281BG-TX/A8	1 012810530
--------------	-------------

1281BG	
1281LPH/1	PH0-0,8x4 mm
1281LPH/2	PH1-1x5,5 mm
1281LPH/3	PH2-1,2x6,5 mm
1281TX/1	T6-T8
1281TX/2	T7-T9
1281TX/3	T10-T15
1281TX/4	T20-T25
1281TX/5	T30-T40

1281BG/B28NA

assortimento di 16 giravite bivalenti, 9 chiavi bussola 1/4", 2 accessori e 1 impugnatura di manovra, in busta di poliestere resistente



1281BG/B28NA	1 012810511
--------------	-------------

900	4 - 4,5 - 5 - 5,5 6 - 7 - 8 - 9 - 10 mm
1281BG	
1281PB	■ 1/4
900/25	
1281LP/1	0,8x4 - 1,2x6,5 mm
1281LP/2	1,0x5,5 - 1,2x6,5 mm
1281PH/1	PH1 - PH2
1281PH/2	PH2 - PH3
1281PZ/1	PZ1 - PZ2
1281PZ/2	PZ2 - PZ3
1281PE	2,5 - 3 - 4 - 5 - 6 mm
1281TX/1	T6 - T8
1281TX/2	T7 - T9
1281RTX/3	T10 - T15
1281RTX/4	T20 - T25
1281RTX/5	T30 - T40

2002/BV7-ZIP	1 020020060
--------------	-------------



I giravite BetaMax presentano molteplici caratteristiche tecniche per agevolare le operazioni di lavoro.

- L'impugnatura si ispira alla sezione triangolare che offre il vantaggio di un ottimale avvitamento, infatti la ripresa della manovra avviene con successione di 120°, in conformità alla massima rotazione ottenibile dal polso.
- Il design assicura una notevole ergonomia, sia in fase di avvitamento rapido che di serraggio.
- La punta priva di cromatura garantisce un perfetto accoppiamento con la vite ed è protetta dall'ossidazione con un trattamento di fosfatazione.



1290

giravite per viti a testa con intaglio

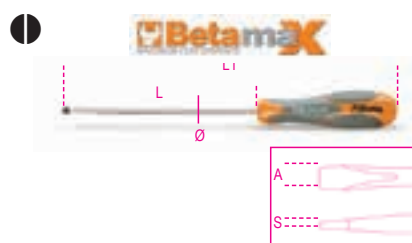

ISO 2380

SxAxL mm	L1 mm	Ø mm		
0,4x2,5x50	146	2,5	5	012900003
0,4x2,5x75	171	2,5	5	012900006
0,5x3x75	171	3,0	10	012900009
0,5x3x100	196	3,0	10	012900012
0,6x3,5x75	171	3,5	10	012900018
0,6x3,5x100	196	3,5	10	012900021
0,8x4x100	196	4,0	10	012900030
0,8x4x125	221	4,0	10	012900033
0,8x4x150	246	4,0	10	012900036
1x5,5x100	209	5,0	10	012900039
1x5,5x150	259	5,0	10	012900042
1,2x6,5x100	220	6,0	10	012900048
1,2x6,5x150	270	6,0	10	012900051
1,2x8x150	282	7,0	3	012900057
1,2x8x200	332	7,0	3	012900060
1,6x10x200	332	8,0	3	012900066
2x12x250	382	10	2	012900069

1290/S

serie giravite



1290/S5			1 012900305

1290	0,5x3x75-0,8x4x100 -1x5,5x150 1,2x6,5x150 -1,2x8x150 mm
------	--

1290/S9X			1 012900319

1290	0,4x2,5x75 - 0,5x3,5x100 0,8x4x125 - 1x5,5x150 1,2x6,5x150 - 1,2x8x200 1,6x10x200 mm
------	---

1290N	0,8x4x30 -1,2x6,5x30 mm
-------	-------------------------

1290N

giravite per viti a testa con intaglio tipo cortissimo



ISO 2380

SxAxL mm	L1 mm	Ø mm		
0,8x4x30	86	4	5	012900103
1,2x6,5x30	86	6	5	012900106

1292

giravite per viti con impronta a croce Phillips®

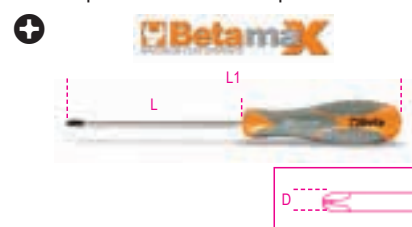

UNI/ISO 8764

PHxDxL mm	L1 mm		
0x3x60	156	10	012920003
0x3x100	196	5	012920006
1x4,5x80	189	10	012920009
1x4,5x120	229	10	012920012
2x6x100	220	10	012920018
2x6x150	270	10	012920021
3x8x150	282	3	012920024
4x10x200	332	3	012920027



1292/S4			1 012920304

PH0x3x60-PH1x4,5x80
PH2x6x100-PH3x8x150 mm

1292N

giravite per viti con impronta a croce Phillips® tipo cortissimo



UNI/ISO 8764

PHxDxL mm	L1 mm		
1x4,5x30	86	5	012920103
2x6x30	86	5	012920106

1292L

giravite per viti con impronta a croce Phillips®, tipo lungo

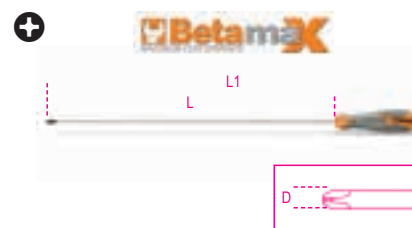

UNI/ISO 8764-1

PHxDxL mm	L1 mm		
0x3x300	396	3	012920203
1x4,5x400	509	3	012920206
2x6x400	520	3	012920209

1293/D...

serie giravite

Betamax



1293/D6 1 012930401

1290 0,6x3,5x75-1x5,5x150
1,2x6,5x150 mm
1292 PH0x3x60 -PH1x4,5x80
PH2x6x100 mm



1293/D8 1 012930403

1290 0,5x3x75-0,8x4x100
1x5,5x150-1,2x6,5x150
1,2x8x150 mm
1292 PH0x3x60 -PH1x4,5x80
PH2x6x100 mm

1293/S...

serie giravite

Betamax

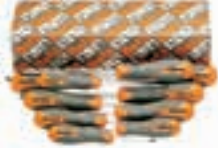

1293/S8 1 012930208

1290 2,5x50-3x75-4x100-5,5x150
6,5x150 mm
1292 PH0x3x60-PH1x4,5x80
PH2x6x100 mm



1293/S10 1 012930201

1290 0,4x2,5x50 -0,6x3,5x100
1x5,5x100-1,2x6,5x150
1,2x8x150-1,6x10x200 mm
1292 PH0x3x60 -PH1x4,5x80
PH2x6x100-PH3x8x150 mm



1293/S12 1 012930203

1290 0,5x3x75-0,8x4x125
1x5,5x150-1,2x6,5x150
1,2x8x200 mm
1290N 0,8x4x30 mm
1292 PH0x3x60 -PH1x4,5x80
PH2x6x100-PH3x8x150 mm
1292N PH1x4,5x30-PH2x6x30 mm



1293/S7 1 012930207

1292 PH0x3x60 -PH1x4,5x80
PH2x6x100 mm
1294 0,5x2,5x60-0,6x3x75
0,8x4x100-1x5x125 mm



1293ES

chiavi maschio esagonale
con impugnatura



mm	L mm	L1 mm	Ø mm	
2	100	196	3	5 012930001
2,5	100	196	4	5 012930002
3	100	196	4	5 012930003
4	100	196	5	5 012930004
5	100	209	6	5 012930005
6	125	245	7	5 012930006
8	150	282	10	2 012930008



1293ES/S7 1 012930057
2-2,5-3-4-5-6-8 mm

1293BP

chiavi maschio esagonale
ad estremità sferica con impugnatura



mm	L mm	L1 mm	
2	100	196	5 012930501
2,5	100	196	5 012930502
3	100	196	5 012930503
4	100	196	5 012930506
5	100	209	5 012930509
6	125	245	5 012930512
8	150	282	2 012930515



1293BP/S7 1 012930558
2-2,5-3-4-5-6-8 mm

1294

giravite per viti senza testa
con intaglio

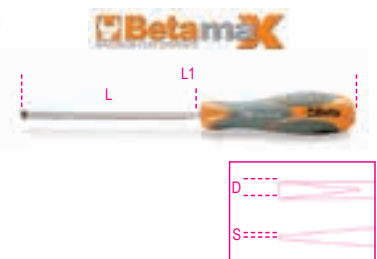

SxDxL mm	L1 mm	
0,5x2,5x60	156	5 012940003
0,6x3x75	171	5 012940006
0,6x3x100	196	5 012940009
0,8x4x100	196	5 012940012
0,8x4x150	246	5 012940015
1x5x125	234	5 012940018
1,2x6,5x150	282	5 012940027



1294/S5 1 012940305
0,5x2,5x60-0,6x3x100
0,8x4x100-1x5x125
1,2x6,5x150 mm

1294L

giravite per viti senza testa con intaglio
tipo lungo

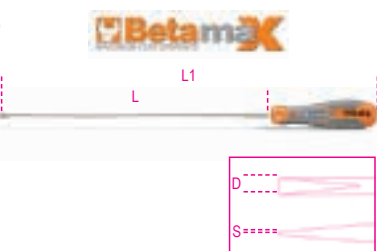

SxDxL mm	L1 mm	
0,6x3x300	396	3 012940206
0,8x4x400	496	3 012940209
1x5x400	509	3 012940215
1,2x6,5x400	532	3 012940218

1295

giravite a percussione



L
mm
130 1 012950001

Beta
QUALITY TOOLS

1295/C14

giravite a percussione
con 14 inserti e bussola portainseri



1295/C14 1 012950108

	866LP	1,2x6,5 - 1,6x10 mm
	866PH	PH2 - PH3
	866PZ	PZ2 - PZ3
	866PE	5 - 6 mm
	866TX	T27 - T30 - T40 - T45 - T50 - T55
	895/6	□ 1/2 - ○ 5/16
	1295	■ 1/2

170x100x35 mm - 1,3 kg

1297TX

chiavi maschio con impugnatura
per viti con impronta Torx®



Ø	L	L1	Ø	
mm	mm	mm	mm	
T6	50	146	3,0	5 012970006
T7	50	146	3,0	5 012970007
T8	60	156	3,0	5 012970008
T9	60	169	4,0	5 012970009
T10	80	189	4,0	5 012970010
T15	80	189	4,0	5 012970015
T20	100	209	4,5	5 012970020
T25	100	209	5,0	5 012970025
T27	115	235	6,0	5 012970027
T30	115	235	6,0	5 012970030
T40	130	262	7,0	2 012970040
T45	130	262	8,0	2 012970045



1297TX/S12 1 012970312

T6-T7-T8-T9-T10
T15-T20-T25-T27
T30-T40-T45



Betamax



1297TX/D6 1 012970409
T10-T15-T20
T25-T27-T30

1297TX/L

chiavi maschio con impugnatura
per viti con impronta Torx®, tipo lungo

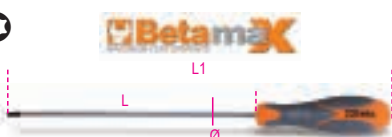

Ø	L	L1	Ø	
mm	mm	mm	mm	
T15	210	319	4,0	2 012970115
T20	210	319	4,5	2 012970120
T25	210	319	5,0	2 012970125
T30	210	330	6,0	2 012970130
T45	210	342	8,0	2 012970145



Betamax

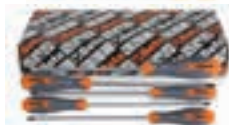

1297TX/L-S5 1 012970325
TX/L15-TX/L20-TX/L25-
TX/L30-TX/L45

1298RTX

chiavi maschio con impugnatura
per viti con impronta
Tamper Resistant Torx®

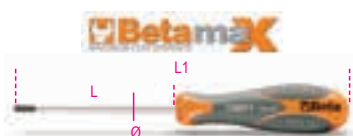

Ø	L	L1	Ø	
mm	mm	mm	mm	
T9	60	169	4,0	5 012980009
T10	80	189	4,0	5 012980010
T15	80	189	4,0	5 012980015
T20	100	209	4,0	5 012980020
T25	100	209	4,5	5 012980025
T27	115	235	5,5	5 012980027
T30	115	235	6,0	5 012980030
T40	130	262	7,0	2 012980040



Betamax



1298RTX/S8 1 012980308
T9-T10-T15-T20
T25-T27-T30-T40

1299PZ

giravite per viti con impronta
a croce Pozidriv®-Supadriv®



UNI/ISO 8764

PZ	L	L1	
Ø	mm	mm	
0	60	156	5 012990000
1	80	189	5 012990003
2	100	220	5 012990006
3	150	282	2 012990009
4	200	332	2 012990012



Betamax



1299PZ/S6 1 012990306
1299PZ PZ0-PZ1-PZ2-PZ3
1299N/PZ PZ1-PZ2

1299N/PZ

giravite per viti con impronta
a croce Pozidriv®-Supadriv®
tipo cortissimo



UNI/ISO 8764

PZ	L	L1	
Ø	mm	mm	
1	30	86	5 012990021
2	30	86	5 012990024

Beta
QUALITY TOOLS

AUTORIPARAZIONE

I nostri utensili per autoriparazione, usati dai professionisti più esigenti, sono sviluppati e prodotti per soddisfare gli standard più elevati al mondo e testati continuamente nelle condizioni di utilizzo più stressanti.

Da oltre 50 anni, siamo orgogliosamente a fianco dei più grandi campioni, che ci aiutano a migliorare costantemente i nostri prodotti e ne confermano il livello di qualità più assoluta.

Gli utensili dedicati all' autoriparazione si trovano in queste sezioni:

Diagnostica	da 1438 a 1499 da 1758VT a 1760TMC
Motore	da 955 a 989A da 1438 a 1499
Olio e filtri	da 1438 a 1499 da 1877 a 1885
Impianto elettrico	da 1438 a 1499
Avviatori	da 1498BC/12 a 1498/40A
Trasmissione	da 1438 a 1499
Sospensioni	da 1549 a 1569CP
Freni	da 1438 a 1499
Ruote	da 955 a 989A
Carrozzeria	da 1302 a 1369 da 1763 a 1767A
Altre attrezzature	da 1878 a 3067
Sollevatori	da 3029/2T a 3067/70-13T



1302

tasso con impugnatura testa tonda convessa e a penna

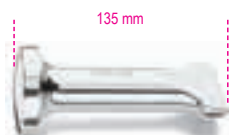

770 g 1 013020001

1303

tasso a virgola



1350 g 1 013030001

1304

tasso a suola



875 g 1 013040001

1305

tasso curvo



1190 g 1 013050001

1305Z

tasso curvo zigrinato



1065 g 1 013050002

1306

tasso a tacco bombato



1040 g 1 013060001

1307

tasso rettangolare bombato

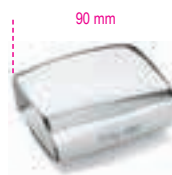

1100 g 1 013070001

1308

tasso ovoidale



1100 g 1 013080001

1310

tasso a rotaia



1225 g 1 013100001

1312

tasso a incudine



1220 g 1 013120001

1314

tasso a teste tonde
convessa e piana



g 760 1 013140001

1326

leva a cazzuola



g 560 1 013260001

1327

leva a cucchiaio
pesante



g 1075 1 013270001

1328

leva a cucchiaio
leggera



g 935 1 013280001

1329

leva curva e piana



g 1800 1 013290001

1330

leva a gomito e piana



g 2125 1 013300001

1331

leva a gola con linguetta in cuoio



g 1100 1 013310001

1335BM

battilamiera con impugnatura
in materiale plastico



g 500 2 013350010

1337/S5

serie di 5 spatoline per carrozzieri in acciaio
inox tipo giapponese



L mm 25-50-75-100-125 1 013370015

1338A - 1338B

portalima con lima
a dentatura radiale, piatta flessibile



1338A 9 360 2 013380001
1338B 12 360 2 013380002

1338

portalima per 1338R



1338 2 013380003

1338R9 - 1338R12

lime di ricambio per 1338A e 1338B



1338R9 9 2 013380004
1338R12 12 2 013380005

1342

scalpello extrapiatto
con tagliente diritto



L mm 235 5 013420001

1342PM

scalpello extrapiatto con tagliente diritto
con paramano



L mm 235 L1 mm 118 2 013420002

1342PMR

paramano di ricambio per 1342



1342PMR 1 013420003

1343

scalpello piatto con tagliente laterale



L mm 200 5 013430001

1344

coppia di spessimetri per carrozzieri
a 10 lame con ventosa di fissaggio

indicati per:

- posizionamento lunotti
- mantenimento della posizione durante i montaggi



1344

1 013440010

1344A/VW

attrezzo per rimozione gancio di fissaggio
maniglie Volkswagen



L
mm
260

1 013440100

1345

martello con testa tonda convessa
e penna
manico in legno



1345

2 013450010

1351

martello con testa tonda piana
e penna sferica
manico in legno



1351

2 013510010

1353

martello con testa tonda piana
e penna a punta
manico in legno



1353

2 013530010

1357Z/45

martelli con teste piane
tonda zigrinata e quadra liscia
manico in legno



1357Z/45

2 013570045

1359T

martello con testa tonda convessa
e penna orizzontale
manico in legno

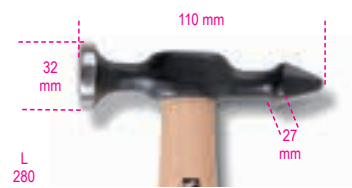

1359 T

2 013590010

1360G

martello in gomma morbida antirimbalo,
per montaggio guarnizioni e componenti
delicati

l'estrema morbidezza del battente permette di non
danneggiare
le parti lavorate, in quanto assorbe l'urto deformandosi



L
mm
280

Ø
mm
72

1 013600000

1360/K6

martello in alluminio con testa tonda piana,
puntali di plastica intercambiabili e bulino

fornito con:

- 4 puntali di plastica
- 1 bulino regolabile in 2 differenti lunghezze applicabile al martello



L
mm
320

Ø
mm
34

1 013600006

1360/KP3

martelli con teste sferiche e penna a punta
più punzone, in materiale plastico

Contenuto del kit:

- 1 martello da 210 g con testa Ø 30 mm
- 1 martello da 290 g con testa Ø 40 mm
- 1 punzone da 75 g con punta da 5 mm



1360/KP3

1 013600503

1361/C12

serie di puntali in Teflon®
per carrozzeria



1361/C12

1 013610012

275x160x57 mm

1361/K9

kit 8 leve per tirabolli carrozzeria

il kit comprende:

- leva con testa a palla tonda Ø 31 mm lunghezza 110 cm
- leva con punta lunghezza 62 cm
- leva con punta a coda di balena lunghezza 112 cm
- leva con punta ad uncino lunghezza 27 cm
- leva con testa tonda piatta lunghezza 50 cm
- leva con testa a palla tonda Ø 19 mm lunghezza 52 cm
- leva con testa a coda di balena lunghezza 27 cm
- leva con testa a coda di balena arrotondata lunghezza 28 cm
- borsa in tessuto con manici



1361/K9

1 013610030



1362B

disco in tessuto per riscontro bolli

- superficie interamente rivestita in materiale antigraffio
- fornito in custodia



1362B	Ø mm	1	013620011
	755		

1364SE

supporto estensibile per carrozzeria

caratteristiche tecniche:

- 4 ruote pivotanti, 2 dotate di freno
- pantografo estensibile fino a 1400 mm
- regolabile in altezza fino a 1315 mm
- blocco delle posizioni
- superficie di appoggio rivestita in gomma removibile
- portata massima 226 kg



	L mm	H mm	P mm	1	013640001
	215÷1400	780÷1315	890		

1364SV

supporto per carrozzeria con vassoio centrale

caratteristiche tecniche:

- superficie di appoggio rivestita in polietilene
- dimensioni vassoio: 340x845x40 mm
- richiudibile



	H mm	1	013640002
	1000		

1364SCP

supporto orientabile per carrozzeria

particolarmente idoneo per cofani, parafranghi e portiere dotato di 4 ruote, 2 girevoli con freno orientabile di 180°



	H mm	L mm	P mm	1	013640003
	1300	1100	680		

1364SP

supporto con ventose per carrozzeria

particolarmente indicato per utilizzo con cristalli dotato di 4 ventose Ø 95 mm estensione regolabile mediante catena tubolare rivestita in polietilene



	H mm	L mm	1	013640004
	1250	950		



1365/K13

pompa oleodinamica 10 t e kit accessori per carrozzeria in trolley

Inclusi nel kit:

- pompa oleodinamica 10 tonnellate con tubo flessibile da 1,5 m attacco 1/2"
- pistone corsa 205 mm
- pinza divarica-parafranghi capacità 500 kg
- piastra di appoggio 150x90 mm
- base a "L" 50x50 mm
- punzone a 4 punti
- punzone zigrinato tondo Ø 50 mm
- punzone a cuneo 43 mm
- prolunga 240 mm
- prolunga 450 mm
- prolunga 475 mm
- testa in gomma
- raccordo maschio maschio per montaggio accessori



1365/K13	1	013650013
----------	---	-----------

900x420x180 mm

1365P10

pompa oleodinamica

Tubo da 1,5 m attacco 1/2"
Max 690 bar



1365P10	1	013650110
---------	---	-----------

1366A

attrezzo levabolli

con kit di 19 funghetti di plastica da utilizzare con colla a caldo per superfici verniciate 1851VK-12V

ideale per:

- bolli da grandine
- ammaccature causate da portiera
- piccole ammaccature in genere



1366A	1	013660200
-------	---	-----------

1366B

massa battente per funghetti
tirabolli in plastica

peso massa battente 500 g



L
mm
440

1 013660250

1366KF

kit 19 funghetti di plastica
per articolo 1366A



1851VK-12V - 018510072

1366KF

1 013660205

1366/K5

tirabolli pneumatico a massa battente
da 1,1 kg

Inclusi nel kit:

- 1 ventosa Ø 75 mm
- 1 ventosa Ø 100 mm
- 1 ventosa Ø 125 mm
- 1 gancio



1366/K5

1 013660010

610x240x90 mm

1366S

spotter carrellato per carrozzeria

- microprocessore per la gestione dei parametri di saldatura
- regolazione di potenza e tempo di saldatura
- campo di regolazione 400+2200 Ah
- selettore punto singolo, pulsato, continuo
- tabella parametri di saldatura
- indicatore protezione termica
- pistola con attacco rapido
- tensione 230 V

CE



1366S

1 013660000

1366S KIT

kit accessori per spotter

- 10 rondelle asolate
- 10 rondelle asolate a 90°
- 100 perni filettati 5x18 mm
- 100 perni autofilettanti 5x18 mm
- 100 perni autofilettanti 5x25 mm
- gancio per rondelle Ø 8x16x1,5 mm
- elettrodo per viti M5-M6
- elettrodo per rondelle asolate



1366S KIT

1 013660001

250x170x35

1366SL

leva a tirare
per ripristino lamiera

testina multigancio snodata
per utilizzo con filo ondulato



L
mm
700

1 013660002

1366ST

traversa di tiro
per ripristino lamiera

testina multigancio snodata
per utilizzo con filo ondulato



L
mm
850

1 013660003

1366S/R1

mandrino per rondelle
a 3 punte



1366S/R1

1 013660501

1366S/R2

rondella a 3 punte
per tiraggio lamiera



1366S/R2

1 013660502

I prezzi indicati sono relativi a 20 pezzi

1366S/R3

elettrodo per rondelle
Ø 8x16x1,5 mm



1366S/R3

1 013660503

1366S/R4

gancio per rondelle Ø 8x16x1,5 mm



1366S/R4

1 013660504

1366S/R5

rondelle Ø 8x16x1,5 mm



1366S/R5

1 013660505

I prezzi indicati sono relativi a 100 pz

Beta

1366S/R6

elettrodo per viti M5-M6



1366S/R6 1 013660506

1366S/R7

100 perni autofilettanti 5x18 mm



1366S/R7 1 013660507

1366S/R8

100 perni autofilettanti 5x25 mm



1366S/R8 1 013660508

1366S/R9

100 perni filettati M 5x18 mm



1366S/R9 1 013660509

1366S/R10

10 rondelle asolate



1366S/R10 1 013660510

1366S/R11

elettrodo per rondelle asolate



1366S/R11 1 013660511

1366S/R12

10 rondelle asolate a 90°



1366S/R12 1 013660512

1366S/R13

elettrodo carbone
calda-lamiere



1366S/R13 1 013660513

I prezzi indicati sono relativi a 5 pezzi

1366S/R14

elettrodo per puntatuta filo



1366S/R14 1 013660514

1366S/R21

fili ondulati per utilizzo
leva e traversa di tiro



1366S/R21 1 013660551

I prezzi indicati sono relativi a 10 pz

1366S/R22

supporto magnetico
per filo ondulato



1366S/R22 1 013660552

1366S/R24

anello di tiro M4



1366S/R24 1 013660554

I prezzi indicati sono relativi a 5 pezzi

1366S/R25

anello di tiro M5



1366S/R25 1 013660555

I prezzi indicati sono relativi a 5 pezzi

1366S/R26

anello di tiro M6



1366S/R26 1 013660556

I prezzi indicati sono relativi a 5 pezzi

1367/S4

serie di fustelle per installazione
sensori di parcheggio

misure:
23 - 24 - 27 - 28 mm



1367/S4 1 013670104

1367/K10

kit di fustelle per installazione
sensori di parcheggio

Incluse nel kit:
• misure: 17 - 18 - 18,2 - 19 - 20 - 22,5 - 24 - 26 - 26,7 - 32 mm



∅ 12 mm



1367/K10 1 013670200

≡ 190x130x58 mm



1368

kit ripara plastiche

- permette di riparare velocemente crepe e rotture di parti in plastica

Alimentazione: 220+240 V con presa Shuko
 Lunghezza cavo pistola termica: 3,5 m
 Lunghezza cavo alimentazione: 1,35 m
 2 regolazioni di potenza: 35-75 W
 Pistola termica con terminali in ottone a 2 angolazioni di inserimento graffetta: 0°-90°
 Protezione input: disgiuntore termico
 Protezione output: fusibile 10 A
 Tasca metallica per riporre la pistola
 Fornito senza graffette

CE



1368

1 013680001

1368G/K400

assortimento di 400 graffette per 1368



1368G/K400

1 013680140

1368G/OD

graffette ondulate diritte per 1368



1368G/OD

1 013680100

I prezzi indicati sono relativi a 100 pezzi

1368G/SD

graffette a spirale diritte per 1368



1368G/SD

1 013680110

I prezzi indicati sono relativi a 100 pezzi

1368G/CV

graffette per angoli convessi per 1368



1368G/CV

1 013680120

I prezzi indicati sono relativi a 100 pezzi

1368G/C2U

graffette per angoli concavi per 1368



1368G/C2U

1 013680130

I prezzi indicati sono relativi a 100 pezzi

MANICI DEI MARTELLI

Manici in legno hickory

L'hickory è un legno con ottime qualità, perfette per il manico di un martello. La sua struttura a fibre lunghe assorbe le vibrazioni e lo rende molto resistente alla rottura. Nel remoto caso di rottura di alcune fibre il rischio di distacco improvviso della testa è comunque molto ridotto.

I manici in legno possono essere sostituiti quando usurati.

Dato che il legno è un materiale naturale, è necessario che conservi la propria umidità. Si raccomanda pertanto di non conservare il martello in un luogo troppo secco.

Manici in fibra di vetro

I manici con anima in fibra di vetro sono resistenti e sicuri; riducono ai minimi termini i rischi di rotture e infortuni.

Resistono agli agenti atmosferici e agli agenti chimici più diffusi.



- Anima indistruttibile in fibre di vetro

- Struttura ergonomica in polipropilene

- Rivestimento antiscivolo in confortevole elastomero

1369/C11

assortimento di 11 utensili



1369/C11

1 013690033

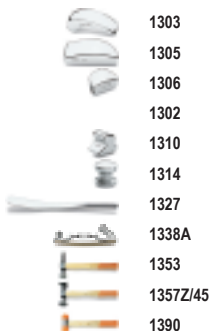

470x340x70 mm - 15,2 kg

1370

martelli tipo tedesco per meccanici manico in legno



HICKORY

UNI 778 DIN 1041

	A	L	L1	
g	mm	mm	mm	
100	15	260	82	5 013700051
200	19	280	95	5 013700052
300	23	300	105	5 013700053
400	25	310	112	5 013700054
500	27	320	118	5 013700055
600	30	330	122	5 013700056
800	33	350	130	4 013700058
1000	36	360	135	4 013700060
1500	42	380	145	2 013700065
2000	47	400	155	1 013700070



1370/MR...

manici di ricambio per 1370



Model	Quantity	Part Number
1370MR 100 1370/100	4	013700081
1370MR 200 1370/200	4	013700082
1370MR 300 1370/300	4	013700083
1370MR 400 1370/400	4	013700084
1370MR 500 1370/500	4	013700085
1370MR 600 1370/600	4	013700086
1370MR 800 1370/800	4	013700088
1370MR 1000 1370/1000	4	013700090
1370MR 1500 1370/1500	4	013700095
1370MR 2000 1370/2000	4	013700100

1370T

martelli tipo tedesco
per meccanici
manico in fibra



g	A mm	L mm	L1 mm	Quantity	Part Number
200	19	280	95	5	013700620
300	23	300	105	5	013700630
500	27	320	118	5	013700650
800	33	350	130	4	013700680
1000	36	360	135	4	013700700
1500	42	365	145	2	013700750

1370F

martelli tipo francese
per meccanici
manico in legno



NF E 71.014

A mm	L mm	L1 mm	Quantity	Part Number
24	260	77	2	013700424
26	260	80	2	013700426
28	280	86	2	013700428
30	280	92	2	013700430
32	300	100	2	013700432
36	300	104	2	013700436
40	330	110	2	013700440
42	330	116	2	013700442
50	380	138	2	013700450
60	380	160	2	013700460

1370F/MR...

manici di ricambio per 1370F



Model	Quantity	Part Number
1370F/MR 24 1370F/24-26	2	013700474
1370F/MR 28 1370F/28-30	2	013700478
1370F/MR 32 1370F/32-36	2	013700482
1370F/MR 40 1370F/40-42	2	013700490
1370F/MR 50 1370F/50	2	013700495
1370F/MR 60 1370F/60	2	013700496

1370FT

martelli tipo francese per meccanici,
manico in fibra



A mm	L mm	L1 mm	Quantity	Part Number
28	280	86	1	013700528
30	280	92	1	013700530
32	300	100	1	013700532
36	300	104	1	013700536
40	330	110	1	013700540
42	330	116	1	013700542
50	380	138	1	013700550
60	380	160	1	013700560

1374F

martelli tipo francese
per falegnami
manico in legno



NF E 71.012

A mm	L mm	L1 mm	Quantity	Part Number
16	250	80	2	013740416
20	270	86	2	013740420
22	290	92	2	013740422
26	290	103	2	013740426
28	310	108	2	013740428
30	310	117	2	013740430

1374F/MR...

manici di ricambio per 1374F



Model	Quantity	Part Number
1374F/MR 16 1374F/16	2	013740456
1374F/MR 20 1374F/20	2	013740460
1374F/MR 22 1374F/22-26	2	013740462
1374F/MR 28 1374F/28	2	013740468
1374F/MR 30 1374F/30	2	013740470

1375

martello con penna
a granchio
manico in legno



g	L1 mm	Ø mm	L mm	Quantity	Part Number
300	95	25	300	3	013750000

1375/MR

manici di ricambio per 1375



Model	Quantity	Part Number
1375/MR	2	013750003

1375A

martelli con penna
a granchio
manico in materiale plastico e fibra di vetro



oz	g	L mm	L1 mm	Quantity	Part Number
16	450	330	130	3	013750016
20	570	330	130	3	013750020

1375B

martelli con penna
a granchio
manico in acciaio

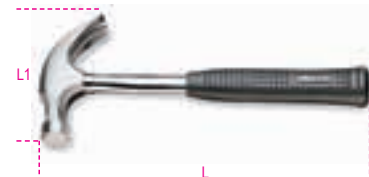

oz	g	L mm	L1 mm	Quantity	Part Number
16	450	330	130	3	013750026
20	570	330	130	3	013750030

1376X

martelli a testa quadra,
con sede portachiodo e calamita,
penna a granchio, per carpentieri
manico in legno



g	A mm	L1 mm	L mm	Quantity	Part Number
250	20	125	450	3	013760125
300	25	130	450	3	013760130
400	27	132	450	3	013760140

1376X/MR

manico di ricambio
per 1376X



1376X/MR 2 013760161

1376XT

martelli a testa quadra,
con sede portachiodo e calamita,
penna a granchio, per carpentieri
manico in materiale plastico



g	A	L1	L	
mm	mm	mm	mm	
250	20	125	500	3 013760525
300	25	130	500	3 013760530
400	27	132	500	3 013760540

1376XT/MR

manico di ricambio
per 1376XT



1376MR/XT 2 013760585

1377

martelli con testa tonda
e penna sferica
per calderai e lattonieri
manico in legno



HICKORY

g	L	L1	
mm	mm	mm	
340	330	95	2 013770134
450	350	102	2 013770145
570	350	110	2 013770157
680	360	116	2 013770168
900	380	120	2 013770190

1377/MR...

manici di ricambio per 1377



1377MR 340 2 013770234

1377MR 450 2 013770245

1377MR 570 2 013770257

1377MR 680 2 013770268

1377MR 900 2 013770290

1377/900

1377T

martelli con testa tonda e penna sferica per
calderai e lattonieri manico in fibra



g	L	L1	
mm	mm	mm	
340	330	95	2 013770534
450	350	102	2 013770545
570	350	110	2 013770557
680	360	116	2 013770568
900	380	120	2 013770590

1378

martelli con testa tonda
e penna simmetrica
per calderai e lattonieri
manico in legno



HICKORY

g	L	L1	Ø	
mm	mm	mm	mm	
340	330	100	27	2 013780134
570	350	115	32	2 013780157

1378/MR...

manici di ricambio per 1378



1378MR 340 2 013780234

1378MR 570 2 013780257

1378/570

1379F

martelli tipo francese
per elettricisti
manico in legno



NF E 71.011

A	L	L1	
mm	mm	mm	
16	250	126	2 013790416
18	250	135	2 013790418
20	260	142	2 013790420

1379F/MR...

manici di ricambio per 1379F



1379F/MR 16 2 013790426

1379F/16-18

1379F/MR 20 2 013790430

1379F/20

1380

mazzette
manico in legno



HICKORY

UNI 7777 DIN 6475

g	A	L	L1	
mm	mm	mm	mm	
800	38	260	90	2 013800208
1000	40	260	95	2 013800210
1250	43	260	100	2 013800212
1500	45	280	110	2 013800215
2000	50	300	120	2 013800220

1380/MR...

manici di ricambio per 1380



1380MR 800 2 013800238

1380/800-1000-1250

1380MR 1500 2 013800245

1380/1500

1380MR 2000 2 013800250

1380/2000

1380S

mazzette con collare salvamanico
manico in legno
collare in materiale plastico



g	A	L	L1	
mm	mm	mm	mm	
800	36	260	90	2 013800400
1000	39	260	95	2 013800405
1250	43	260	100	2 013800410
1500	45	260	110	2 013800415

1380S/MR...

manici di ricambio per 1380S



1380S/MR 800 2 013800417

1380S/800-1000-1250

1380S/MR 1500 2 013800419

1380S/1500

1380T

mazzette
manico in fibra



g	A mm	L mm	L1 mm		
800	35	260	85	2	013800308
1000	40	260	100	2	013800310
1250	42	260	110	2	013800312
1500	45	260	120	2	013800315
2000	49	295	120	1	013800320

1381

mazze a coppia
manico in legno hickory



g	A mm	L mm	L1 mm		
3000	55	800	142	1	013810030
4000	60	900	152	1	013810040
5000	70	900	162	1	013810050
8000	80	900	185	1	013810080

1381/MR...

manici di ricambio per 1381



1381MR 3-4 1381/3000-4000	2	013810730
1381MR 5 1381/5000	2	013810750
1381MR 8 1381/8000	2	013810780

1381T

mazze a coppia
manico in fibra



g	A mm	L mm	L1 mm		
3000	55	900	142	1	013810330
4000	60	900	152	1	013810340
5000	70	900	162	1	013810350
8000	82	920	180	1	013810380

1385

mazzuole
con testa in rame
manico in legno



g	A mm	L mm	L1 mm		
400	26	260	75	2	013850404
600	32	270	80	2	013850406
800	34	280	90	2	013850408
1000	37	280	100	2	013850410
1500	43	280	110	2	013850415
2000	48	300	120	1	013850420

1385/MR

manici di ricambio per 1385



1385MR 400 1385 400	2	013850464
1385MR 600 1385 600	2	013850466
1385MR 800 1385 800	2	013850468
1385MR 1000 1385 1000	2	013850470
1385MR 1500 1385 1500	1	013850475
1385MR 2000 1385 2000	1	013850480

1390

mazzuole con battenti intercambiabili
in materiale plastico
manico in legno



UNI 7784

Ø mm	L mm	L1 mm		
22	260	70	5	013900022
28	280	85	5	013900028
35	310	95	5	013900035
45	320	107	4	013900045
60	380	128	2	013900060

1390/MR...

manici di ricambio per 1390



1390MR 22 1390/22	2	013900222
1390MR 28 1390/28	2	013900228
1390MR 35 1390/35	2	013900235
1390MR 45 1390/45	2	013900245
1390MR 60 1390/60	2	013900260

1390R

battenti di ricambio per 1390



Ø mm		
22	4	013900122
28	4	013900128
35	4	013900135
45	4	013900145
60	4	013900160

1390N

mazzuole con battenti intercambiabili in nylon,
manico in legno

Battenti medio-duri: 75 Shore

Resistente all'olio e all'usura

Particolarmente indicato per lavorazioni su lamiera e metalli



UNI 7784

Ø mm	L mm	L1 mm		
22	260	70	3	013900522
28	280	85	3	013900528
35	310	95	3	013900535
45	320	107	2	013900545
60	380	128	2	013900560

1390NR

battenti di ricambio in nylon per 1390N



Ø mm		
22	4	013900622
28	4	013900628
35	4	013900635
45	4	013900645
60	4	013900660

1391

mazzuole antirimbalo
interamente rivestite in gomma



Ø mm	L mm	L1 mm		
35	280	90	2	013910135
50	320	105	2	013910150
55	355	110	2	013910155
65	380	130	2	013910165

1391A

mazzuole per piastrellisti
interamente rivestite in gomma



g	Ø mm	L mm	L1 mm		
500	45	290	100	2	013910205
1000	60	300	120	2	013910210

1392

mazzuole antirimbalo
con battenti intercambiabili
in materiale plastico
manico in acciaio



Ø mm	L mm	L1 mm		
30	300	105	2	013920030
35	305	115	2	013920035
40	310	125	2	013920040
50	325	135	2	013920050
60	385	155	2	013920060

1392R

battenti di ricambio per 1392



Ø mm			
30	4	013920230	
35	4	013920235	
40	4	013920240	
50	4	013920250	
60	4	013920260	

1393

mazzuole con testa
in gomma dura



Ø mm	L mm	L1 mm		
50	315	90	3	013930050
60	340	110	3	013930060
70	370	130	2	013930070

AUTORIPARAZIONE

I nostri utensili per autoriparazione, usati dai professionisti più esigenti, sono sviluppati e prodotti per soddisfare gli standard più elevati al mondo e testati continuamente nelle condizioni di utilizzo più stressanti.

Da oltre 50 anni, siamo orgogliosamente a fianco dei più grandi campioni, che ci aiutano a migliorare costantemente i nostri prodotti e ne confermano il livello di qualità più assoluta.

Gli utensili dedicati all' autoriparazione si trovano in queste sezioni:

Diagnostica	da 1438 a 1499 da 1758VT a 1760TMC
Motore	da 955 a 989A da 1438 a 1499
Olio e filtri	da 1438 a 1499 da 1877 a 1885
Impianto elettrico	da 1438 a 1499
Avviatori	da 1498BC/12 a 1498/40A
Trasmissione	da 1438 a 1499
Sospensioni	da 1549 a 1569CP
Freni	da 1438 a 1499
Ruote	da 955 a 989A
Carrozzeria	da 1302 a 1369 da 1763 a 1767A
Altre attrezzature	da 1878 a 3067
Sollevatori	da 3029/2T a 3067/70-13T



1410/M

attrezzo ad uncino
per trazionamento molle



Ø mm		
3,5	2	014100051

1428

estrattori per dadi destrorsi danneggiati
con attacco quadro



Ø mm	□ mm	L mm	○ mm		
8	3/8	36	17	2	014280008
10	3/8	36	17	2	014280010
11	3/8	36	17	2	014280011
12	3/8	36	19	2	014280012
13	3/8	36	19	2	014280013
14	3/8	36	19	2	014280014
15	1/2	38	21	2	014280015
16	1/2	38	21	2	014280016
17	1/2	38	21	2	014280017
18	1/2	38	26	2	014280018
19	1/2	38	26	2	014280019
20	1/2	38	26	2	014280020
21	1/2	38	26	2	014280021
22	1/2	38	26	2	014280022
24	1/2	38	26	2	014280024
27	1/2	38	26	2	014280027

1428L

estrattori a bussola lunghi
per dadi destrorsi danneggiati
con attacco quadro



Ø mm		
17	1	014280217
19	1	014280219
21	1	014280221

1428L/B3



17-19-21 mm	1	014280303
-------------	---	-----------

1428/SB11



8-10-11-12-13-14	1	014280111
15-16-17-18-19 mm		
1428/SB5	1	014280115
20-21-22-24-27 mm		

1429

estrattori per viti e prigionieri danneggiati con attacco quadro



mm	□	L mm		
2	3/8	60	3	014290002
3	3/8	60	3	014290003
4	3/8	60	3	014290004
5	3/8	60	2	014290005
6	3/8	60	2	014290006
8	1/2	70	2	014290008
10	1/2	70	2	014290010



1429/SB7 1 014290107
2-3-4-5-6-8-10 mm

1430/...

estrattori conici per viti e prigionieri spezzati in acciaio legato

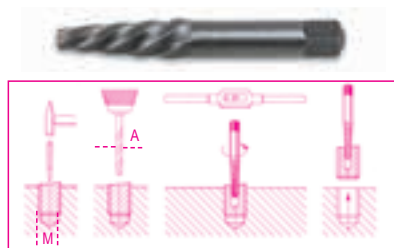

	M	A mm		
1430/1	3÷6	2,5	10	014300006
1430/2	6÷8	3,0	10	014300008
1430/3	8÷11	4,5	10	014300011
1430/4	11÷14	6,0	10	014300014
1430/5	14÷18	8,0	10	014300018
1430/6	18÷24	11,0	5	014300024
1430/7	24÷33	14,0	5	014300033
1430/8	33÷50	21,0	5	014300050



1430/S5	1	014300105
1430/1-1430/2-1430/3		
1430/4-1430/5		
1430/S6	1	014300106
1430/1-1430/2-1430/3		
1430/4-1430/5-1430/6		
1430/S8	1	014300108
1430/1-1430/2-1430/3		
1430/4-1430/5-1430/6		
1430/7-1430/8		

1431/...

estrattori conici per viti e prigionieri spezzati

per la rimozione di viti e prigionieri che non offrono possibilità di presa
inserimento a percussione

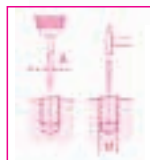

	M	A	L	□		
	mm	mm	mm	mm		
1431/3	3÷6	2,5	59	5	10	014310051
1431/5	6÷8	5,0	68	5	10	014310052
1431/6	8÷11	6,0	72	6	10	014310053
1431/8	11÷14	8,0	77	8	10	014310054
1431/9	14÷18	9,0	82	9	10	014310055

1431/C5

estrattori conici per viti e prigionieri spezzati

Inserimento a percussione



	M	A		
	mm	mm		
1431/C5	6÷18	3÷9	1	014310005

1433

estrattori a rulli per viti prigioniere

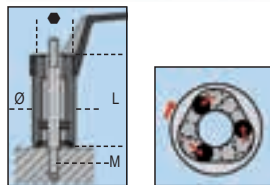

M	Ø	L	●	□		
mm	mm	mm	mm			
5	21	60	19	3/8	2	014330005
6	24	60	21	1/2	2	014330006
7	24	60	21	1/2	2	014330007
8	24	60	21	1/2	2	014330008
9	28	70	21	1/2	2	014330009
10	28	70	21	1/2	2	014330010
10,5	28	70	21	1/2	2	014330021
11	28	70	21	1/2	2	014330011
12	28	70	21	1/2	2	014330012
14	36	72	24	-	2	014330014
16	36	72	24	-	2	014330016

1433/C11

estrattori a rulli per viti prigioniere



1433/C11 1 014330311
M5 - M6 - M7 - M8 - M9 - M10 - M10,5
M11 - M12 - M14 - M16
340x135x56 mm - 3,0 kg

1435

estrattore ad eccentrico per viti prigioniere



Ø
mm
4÷20 1 014350001

1435R

rotella di ricambio per 1435



1435R 1 014350010

1435/1

estrattore ad eccentrico per viti prigioniere



Ø
mm
19÷26 1 014350002

1435/1R

rotella di ricambio per 1435/1



1435/1R 1 014350011

1437/C12

assortimento 12 utensili per rimozione air bag



1437/C12 1 014370001
260x160x55 mm - 1,0 kg

1438

attrezzo universale per centraggio frizioni completo di 3 coni ad espansione



1438 1 014380001

1438R

coni ad espansione di ricambio per 1438



∅ mm 5 014380101
14÷18 5 014380102
18÷21 5 014380103
22÷25 5 014380103

1438DCT

attrezzo per smontaggio, montaggio frizione cambio DCT a 6 rapporti utilizzabile su Volvo, Ford, Chrysler, Dodge

38"



1438DCT 1 014380300

1438EVO

kit universale per centraggio frizioni

Componentistica interamente in metallo



1438EVO 1 014380011
290x200x60 mm - 2 kg

1438DSG

leva per bloccaggio/sbloccaggio cambio DSG a doppia frizione del gruppo VAG



1438DSG 1 014380200

1438K/DSG-2

kit per ripristino frizione DSG a 6 e 7 rapporti

utilizzabile per cambi 6 marce DSG e manuale, DSG 7 marce prima, seconda serie e S-tronic.



1438K/DSG-2 1 014380260
350x370x117 mm - 10 kg

1438K/PWR

kit per rimozione ed installazione doppia frizione cambio Powershift



1438K/PWR 1 014380270
440x400x85 mm - 10 kg

1438DCT/S

kit di ripristino doppie frizioni Ford a secco

necessario per il riallineamento della frizione dopo aver effettuato interventi tipo sostituzione paraoli del cambio



1438DCT/S 1 014380305
440x400x85 mm - 8 kg

1439/K7

cassetta giravite angolare 90° tipo lungo con lame

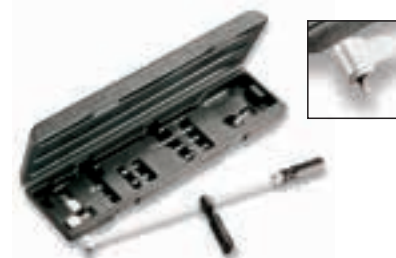

Dotazione valigetta:
- Giravite angolare
- 1 Testa per viti ad intaglio
- 1 Testa per bits 1/4
- 1 Testa per lame speciali
- 7 lame speciali

1439K7 1 014390101
500x120x60 mm - 825 g

1440/...

attrezzi per inserimento pistoni



	Ø mm	L mm		
1440/0	40÷75	50	1	014400000
1440/1	57÷125	80	1	014400010
1440/1A	57÷125	100	1	014400011
1440/2	90÷175	80	1	014400020
1440/2A	90÷175	100	1	014400021
1440/3	90÷175	165	1	014400030

1445/1 - 1445/2

attrezzi per segmenti di pistoni



	Ø mm		
1445/1	50÷100	1	014450001
1445/2	90÷150	1	014450002

1452K

morsetto alzavalvole con tre flange



1452K	1	014520100
-------	---	-----------

1452PN/K

attrezzo pneumatico per molle valvole motore

pressione di spinta 1400 N



Ø mm	L mm	L1 mm		
16-19-23	230	185	1	014520110
25-30-42				

1454P

raschietto per rimozione residui di guarnizioni e sigillanti

particolarmente indicato per pulire testate e superfici piane da accoppiare



L mm	L1 mm	±		
210	32	3,3	1	014540010

1455SVP

smerigliavalvole pneumatico

• Pressione di utilizzo 6 Bar

CE



1455SVP	1	014550001
---------	---	-----------

1455SVP/R...

ventose in gomma di ricambio per 1455SVP



1455SVP/R1	5	014550501
1455SVP/R2	5	014550502
1455SVP/R3	5	014550503

1457/B4

serie di attrezzi per lo sbloccaggio dei connettori Rilsan

Misure incluse:

- 6x8
- 10x12
- 15x16
- 18x12



1457/B4	1	014570024
---------	---	-----------

1458

pinza per anelli elastici di sicurezza SP per alberi



DIN 5417		
Ø mm		
30÷100	2	014580001

1460F

pinza per anelli di tenuta valvole



1460F	1	014600010
-------	---	-----------

1461/C5G

attrezzi per la messa in fase motori Fiat/Alfa/Lancia/Opel/Suzuki/Ford Diesel

Motori: 1.3 Multijet



1461/C5G	1	014610053
----------	---	-----------

280x245x75 mm 2,6 kg

1461/C6B

attrezzi per la messa in fase motori Peugeot/Citroën benzina

Motori: 1.0-1.1-1.4-1.6-1.6 16v-1.6Gti-1.6 18V-1.8-1.8 16v-1.9-2.0-2.0 16v-2.0T-2.0 Hpi-2.2 16v



1461/C6B	1	014610063
----------	---	-----------

310x290x120 mm 3,5 kg

1461/C6G

attrezzi per la messa in fase motori
Peugeot/Citroën Diesel

Motori: 1.4-1.6-2.0D, 1.4-1.6TDCI, 1.4-1.6-2.0-2.2Hdi,
1.5-1.9-2.5D





1461/C6G   1 014610064
≡ 385x290x100 mm  3,8 kg

1461/C7B

attrezzi per la messa in fase motori
Renault/Nissan benzina

Motori: 1.4-1.6-1.8-2.0 16V





1461/C7B   1 014610072
≡ 280x245x75 mm  3,2 kg

1461/C8B

attrezzi per la messa in fase motori Ford
benzina

Motori: 1.25-1.4-1.6-1.6 SCTI-1.6 Ti-VCT-1.6 16V





1461/C8B   1 014610083
≡ 240x210x50 mm  1,8 kg

1461/C9B

attrezzi messa in fase motori Opel benzina

Motori: 1.0 12V, 1.0-1.2-1.4 16V





1461/C9B   1 014610092
≡ 335x145x60 mm  2 kg

1461/C11A

attrezzi per messa in fase
motori Renault Diesel

Motori: 2.0 dCi



1461/C11A   1 014610111
≡ 420x280x60 mm -  1,2 kg

1461/C12A

attrezzi messa in fase
motori Fiat benzina e Diesel

Motori: 1.9-2.2 JTS e 1.9 JTD Euro 4





1461/C12A   1 014610123
≡ 280x245x75 mm -  1,8 kg

1461/C13B

attrezzi per messa in fase motori
Fiat benzina

Motori: 1.4 Multiair





1461/C13B   1 014610134
≡ 240x210x50 mm  2,8 kg

1461/C18B

attrezzi per la messa in fase motori
Volkswagen/Audi/Seat e Skoda benzina

Motori: 1.6-1.8-1.8T, 1.4-1.6-1.8-2.0 16V,
1.4-1.6-2.0 FSI



1461/C18B   1 014610182
≡ 310x290x120 mm  2,5 kg

1461/C20G

attrezzi per la messa in fase motori
Fiat Iveco/Peugeot/Citroën/Ford Diesel

Motori: 2.2-2.3-3.0 Multijet



1461/C20G   1 014610221
≡ 385x290x100 mm  5,5 kg

1461/C21G

attrezzi per la messa in fase motore Renault Diesel

Motori: 1.6 dCi



1461/C21G

1 014610222

310x290x120 mm 3 kg

1461/C23B

attrezzi per la messa in fase motori Opel benzina

Motori: 1.0 - 1.2 - 1.4 ecoflex



1461/C23B

1 014610224

280x245x75 mm 2,5 kg

1461/C24B

attrezzi per la messa in fase motori Mini-Peugeot/Citroën benzina

Motori: 1.4 - 1.6 (N12-N14)



1461/C24B

1 014610225

280x245x75 mm 2,8 kg

1461/C25G

attrezzi per la messa in fase motori Mini Diesel

Motori: 1.6 diesel (W16D)



1461/C25G

1 014610226

270x120x45 mm 1 kg

1461/C27G

attrezzi per la messa in motori Bmw Diesel

Motori: 1.6-2.0D (N47-N47S)



1461/C27G

1 014610228

280x245x75 mm 2 kg

1461/C28B

attrezzi per la messa in fase motori Volkswagen, Seat, Skoda benzina

motori: 1.0 - 1.0 Bluemotion Tech
1.0 Ecofuel/Ecomotive - 1.0 Green Tech



1461/C28B

1 014610229

280x245x75 mm - 1,7 kg



1461/C29B

attrezzi per la messa in fase motori Ford benzina

motori: 1.0 EcoBoost



1461/C29B

1 014610209

280x245x75 mm - 2,6 kg

1461/C30G

attrezzi per la messa in fase motori Volkswagen/Audi/Seat e Skoda Diesel

motori: 1.6-2.0 CR TDI
per motori a partire dall'anno 2012



1461/C30G

1 014610231

280x245x75 mm - 2 kg

1461/C32G

attrezzi per la messa in fase motori Opel Diesel

Motori: 1.6 CDTi (B16)



1461/C32G

1 014610233

270x230x80 mm - 1,3 kg

1461/C33B

attrezzi per la messa in fase motori Opel benzina

Motori: 1.0 - 1.0 Turbo SIDI Ecoflex



1461/C33B

1 014610234

1462CF/C6

serie di 6 chiavi poligonali aperte per raccordi carburante iniettori

misure:

12-14-16-17-18-19 mm

12"



1462CF/C6

1 014620006

260x145x60 mm - 1,2 kg

1462CF

chiavi poligonali aperte per raccordi carburante iniettori

12"



mm
12
14
16
17
19
18

1 014620012
1 014620014
1 014620016
1 014620017
1 014620019
1 014620018

1462CF-SN/C6

serie di 6 chiavi snodate esagonali aperte per raccordi carburante iniettori

misure:

12-14-16-17-18-19

3/8"



1462CF-SN/C6

1 014620026

275x182x64 mm

1462CF-SN

chiavi snodate esagonali aperte per raccordi carburante iniettori

3/8"



mm
12
14
16
17
18
19

1 014620032
1 014620034
1 014620036
1 014620037
1 014620038
1 014620039

1462/KD

assortimento utensili per estrazione iniettori Denso completo di massa battente



1462/KD

1 014620060

335x210x80 mm - 4,8 kg

1462/KI

assortimento utensili per estrazione iniettori Diesel Common Rail

Permette la rimozione degli iniettori DELPHI-BOSCH-SIEMENS-DENSO



1462/KI

1 014620235

530x470x140 mm - 2,0 kg

1462/KMRC

assortimento utensili per estrazione iniettori su motori Mercedes 2.1L, 2.2L, 3.0 V6 e Chrysler

Per iniettori Bosch (2.1 e 2.2L) e Delphi (3.0) Si può procedere alla rimozione degli iniettori senza rimuovere il motore.

Particolarmente indicato per i modelli:

Mercedes Vito, Vario, CLK, Sprinter, Viano, Classe M, GL, C, GLK, E, CLS, S, R, G
Chrysler 300 C



1462/KMRC

1 014620070

310x300x118 mm - 3,5 kg

1462/KU

assortimento utensili universale per estrazione iniettori diesel common rail completo di pinza e massa battente



1462/KU

1 014620100

390x290x100 mm - 4,5 kg

1462/MB

kit a massa battente per estrazione iniettori incluso nel kit:

- 1 massa battente da 4 kg con asta da 400 mm
- 1 adattatore snodato maschio M10x1,5 femmina M22x1,5 mm
- 1 adattatore maschio M22x1,5 femmina M13x1,4 mm
- 1 adattatore maschio M14x1,5 femmina M27x1 mm
- 1 adattatore maschio M14x1,5 maschio M25x1 mm
- 1 adattatore maschio M14x1,5 maschio M27x1 mm
- 1 adattatore maschio M14x1,5 femmina M14x1,5 mm
- 1 adattatore maschio M14x1,5 maschio M20x1 mm
- 1 adattatore maschio M14x1,5 maschio M17x1 mm



1462/MB

1 014620110

500x250x80 mm - 7,2 kg



1462AD/BSC

adattatore per estrazione iniettori
Bosch Common Rail

da utilizzare con articoli Beta 960KI, 1462KI e Beta 1462/KU



1462AD/BSC

1 014620435

1462AD/SMN

kit di adattatori per estrazione iniettori
Siemens e Denso

da utilizzare con articolo Beta 960KI/1462KI



1462AD/SMN

1 014620436

1462/EI

attrezzo universale a vibrazioni per estrazione
iniettori

- Favorisce la rimozione di iniettori fortemente grippati dall'alloggiamento, senza arrecare danni alla testata ed evitando possibili rotture
- Utilizzabile con qualsiasi set di estrazione iniettori con o senza massa battente
- L'attrezzo agisce direttamente con vibrazioni e impulsi sul tirante di estrazione, che è accoppiato con l'iniettore
- Attraverso la valvola di regolazione è possibile adeguare l'intensità della vibrazione in base al tipo di intervento da eseguire.

CE



1462/EI

1 014620240

1462PIM

coppia di piastre per
manutenzione iniettori

bloccaggio in morsa

sezioni:

Ø 11-12-13-14-16-19-20 mm



1462PIM

1 014620502

1463/KIT

kit attrezzatura per blocco pulegge
distribuzione



1463/KIT

1 014630001

280x140x75 mm - 1,2 kg

1464T

tester digitale per la misurazione
di pressione e compressione

CARATTERISTICHE

- display touch screen da 5"
- batteria ai polimeri di litio ricaricabile
- completo di sensore da 80 bar (basse pressioni) e cavo USB



CE

Caratteristiche:

- Display touch screen da 5"
- Batteria ai polimeri di litio ricaricabile
- Completo di sensore da 80 bar (basse pressioni) e cavo USB
- Dotato di memoria interna per memorizzare i dati rilevati affinché possano essere successivamente trasmessi a un computer

Un importante vantaggio dell'art. 1464T è che si possono acquistare diversi kit supplementari, con cui è possibile effettuare altri test:

- 1464ADB set per la verifica della pressione dell'impianto AdBlue®
- 1464FAP set per la verifica della pressione del filtro antiparticolato DPF
- 1464VD set per la verifica della depressione/vuoto
- 1464APB set per la verifica dell'impianto alta pressione benzina nei motori FSI
- 1464PF set per la verifica dell'impianto frenante
- 1464PT set per verifica della pressione del turbo
- 1464TDI set per la verifica della pressione della pompa nei motori TDI
- 1464FG set di falsi regolatori per la verifica del sistema diesel common rail
- 1464PB set di 9 connessioni per la verifica della bassa pressione carburante
- 1464CBD set completo di adattatori per la verifica della compressione nei motori benzina e diesel
- 1464IC set di finti iniettori e finte candele per la verifica della compressione nei motori diesel
- 960AD/TP2 set di adattatori per la verifica della compressione nei motori diesel e benzina, della pressione olio e carburante

1464T

1 014640050

1464T/SP80

sensore di pressione da 80 bar
per 1464T e 960TP



1464T/SP80

1 014640053

960AD/TP2

set di adattatori per 1464T e 960TP
in valigetta di plastica



960AD/TP2

1 009600510

430x310x50 mm - 3,2 kg

1464CBD

set completo di adattatori per la verifica della
compressione nei motori benzina e diesel
con 1464T

Permette di collegarsi al motore per la verifica della compressione benzina e diesel attraverso lo strumento 1464T Include:

- n° 7 false candele con valvola di non ritorno
- n° 44 false candele
- n° 1 falso iniettore regolabile universale per auto, truck, motori marini e macchine agricole
- n° 1 adattatore a 90°, valvola di scarico pressione e tubo di collegamento
- spazio per poter alloggiare lo strumento 1464T all'interno della valigetta



1464CBD

1 014640300

510x410x140 mm - 5,5 kg

1464IC

set completo di finti iniettori e finte candele,
per 1464T

Permette di collegarsi al motore per la verifica della compressione nei motori diesel con tester digitale 1464T.

Include:

- n° 22 false candele
- n° 5 falsi iniettori
- n° 1 kit falso iniettore universale per auto, truck, motori marini e macchine agricole



1464IC

1 014640350

559x312x50 mm - 4,5 kg

1464IC/RK

kit falso iniettore universale per auto, truck, motori marini e macchine agricole

incluso in art. 1464IC



1464IC/RK 1 014640377

200x110x30 mm - 885 g

1464AP

set per la verifica dell'impianto alta pressione dei motori diesel common rail, per 1464T

Fornito con:

- set tubi alta pressione
- raccordi di collegamento
- sensore da 2.000 bar



1464AP 1 014640450

430x310x50 mm - 1,8 kg

1464APT

tubo alta pressione per 1464AP e 960TAP



1464AP T12X12 1 014640453

1464AP T12X14 1 014640454

1464AP T14X12-M1,0 1 014640455

1464AP T16X12

tubo alta pressione 16x12 per sistema Bosch CP4, da utilizzare con 1464AP



1464AP T16X12 1 014640456

1464FG

set di falsi regolatori per la verifica del sistema diesel common rail (da utilizzare con Beta 1464T-1464AP)

Utilizzato con il tester e gli adattatori idonei, permette di stabilire se il problema risiede nella pompa alta pressione o nel regolatore in caso di assenza di pressione nel circuito di alta pressione nei motori diesel common rail.

Indicato per regolatori di pressione Bosch, Delphi, Denso e Siemens



1464FG 1 014640470

350x250x80 mm - 1,8 kg

1464FG/CP4

falso regolatore per pompa Bosch CP4 non incluso in 1464FG



1464FG/CP4 1 014640475

1464APB

set per la verifica dell'impianto alta pressione benzina dei motori FSI, per 1464T

Include sensore da 200 bar e raccordi di collegamento



1464APB 1 014640500

240x210x50 mm - 0,5 kg

1464PB

set di 9 connessioni per la verifica della bassa pressione carburante (da utilizzare con 1464T)

Attraverso le connessioni rapide collegate al tester 1464T si effettua rapidamente la verifica della bassa pressione carburante nei motori diesel e benzina



1464PB 1 014640700

530x440x120 mm - 3,8 kg

1464ADB

set per la verifica della pressione dell'impianto AdBlue® per 1464T

Fornito con adattatori da utilizzare con il sensore standard da 80 bar presente nel 1464T



1464ADB 1 014640620

240x210x50 mm - 0,5 kg

1464FAP

set per la verifica della pressione del filtro antiparticolato DPF per 1464T

Fornito con:

- sensore da 500 mbar
- adattatore da 8 mm con attacco rapido e raccordo a T
- cavo RJ45 da 3 metri



Dati tecnici:

- Test della pressione: 0÷500 mbar
- Risoluzione: 1 mbar

1464FAP 1 014640610

240x210x50 mm - 0,5 kg

1464PT

set per la verifica della pressione del turbo, per 1464T

Include sensore da 3bar e cavo di collegamento



1464PT 1 014640550

240x210x50 mm - 380 g

1464TDI

set per la verifica della pressione della pompa nei motori TDI, per 1464T

Include raccordo di collegamento



1464TDI 1 014640600

240x210x50 mm - 400 g

1464VD

set per verifica della depressione/vuoto per 1464T

Permette la misurazione e memorizzazione del valore massimo della depressione

Fornito con:

- sensore da 800 mbar
- adattatori da 6 e 8 mm
- cavo RJ45 da 3 metri

Dati tecnici:

- Test del vuoto: 0+800 mbar
- Risoluzione: 1 mbar
- Memorizzazione del valore massimo



1464VD 1 014640570

240x210x50 mm

1464PF

set per la verifica della pressione nell'impianto frenante, per 1464T

Include adattatori e raccordi



1464PF 1 014640650

400x280x60 mm - 3 kg

1465

strumento di verifica dell'efficienza del motore

Permette di verificare in pochi secondi la compressione dei motori endotermici senza doversi collegare al motore, prelevando l'alimentazione dalla batteria del veicolo, attraverso un software dedicato



- 1° Fase: calcolo giri/motore
- 2° Fase: analisi andamento tensione batteria durante ogni singolo giro
- 3° Fase: visualizzazione potenza elettrica assorbita e compressione relativa calcolata attraverso il lavoro del motorino di avviamento per ogni pistone
- 4° Fase: verifica stato di carica ed efficienza della batteria

Dati tecnici:

- Tensione di funzionamento: 12V DC (batteria veicolo)
- Dimensioni: 140x75x30 mm
- Lunghezza cavo pinze: 1300 mm
- Peso: 365 g

1465 1 014650010

1466/C5

kit 5 chiavi per spurgo freni

inclusi nel kit:

- 5 chiavi misura 7-8-9-10-11 mm
- 1 tubo di scarico con valvola di non ritorno



1466/C5 1 014660100

260x170x50 mm - 600 g

1466L 11

chiave 11 mm per spurgo freni versione lunga



1466L 11 1 014660211

11 mm L 60 mm

1466TLF

tanica per recupero olio freni capacità 1,5 litri

Attacco rapido per tubo di spurgo Ø 5,5 mm



1466TLF 1 014660201

1467

strumento estrazione liquido freni



Pressione min 5 bar, Max 11,5 bar

1467 1,5 1 014670001

1467/RK1

kit tubo di ricambio per 1467



1467/RK1

1 014670501

1467/RK2

rabboccatore di ricambio per 1467



1467/RK2

1 014670502

1467LF/2

strumento elettrico per sostituzione liquido freni dotato di "effetto pulsante"



- stop automatico con tanica vuota, che impedisce l'inserimento di aria
 - volume massimo tanica: 20L
 - pressione di esercizio: 0,4+3,5 bar
 - alimentazione 230V
- Dotazione inclusa:
- tanica di recupero olio dai freni
 - 1 tappo E20 standard

1467LF/2

1 014670099

1467LF/RC

contenitore con tubo di recupero per 1467LF



1467LF RC

1 014670125

1467TU

tappo per vaschette liquido freni

- adattabile al 90% delle vaschette del parco circolante
- utilizzabile con articolo Beta 1467LF



1467TU

1 014670090

1467T/C6

kit di tappi adattatori per vaschette liquido freni utilizzabile con BETA 1476LF e 1467LF/2

inclusi nel kit:

- 1 tappo per Toyota
- 1 tappo Ford, Hyundai, Mazda, Mitsubishi, Nissan, Subaru
- 1 tappo Honda
- 1 tappo Mazda e Suzuki
- 1 tappo Nissan
- 1 tappo adattatore per spurgo freni veicoli europei



1467T/C6

1 014670080

350x240x85 mm - 1,8 kg

1468N

attrezzi per sostituzione piattelli valvole

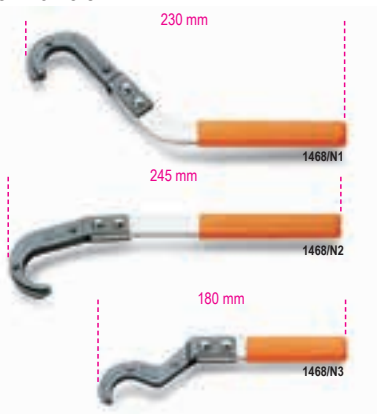

1468N/1

1 014680011

1468N/2

1 014680012

1468N/3

1 014680013

1470

pinze per molle freni a tamburo



L

mm

210

330

540

1 014700001
1 014700002
1 014700010

1470FT

pinza per fermi molle ceppi freni a tamburo

Becchi inclinati a 40°
Accesso facilitato nei punti scomodi



L

mm

184

1 014700000

1470PF

attrezzo per la sostituzione dei cilindri nei freni a tamburo

le ganasce restano divaricate, ed il cilindro viene facilmente sostituito



38"



17 mm

A

mm

25÷140

1 014700200

1471

pinza per molle freni a tamburo



L

mm

330

1 014710001

1471A

pinza per cavo freno a mano



A max

mm

45

B

mm

5

2 014710010

1471GF

coppia di ganci modellabili per il sostegno della pinza freno durante la sostituzione delle pastiglie



1471GF Max kg 5 1 014710310

1471M/C22

utensile pneumatico per arretrare e ruotare i pistoncini dei freni a disco destrorsi e sinistrorsi con accessori

- martinetto automatico
- 150 Kg di spinta
- pressione di utilizzo 5+8 bar



1471M/C22 1 014710101

350x310x85 mm - 3,5 kg

1471M/50

martinetto pneumatico per arretrare e ruotare i pistoncini dei freni a disco destrorsi e sinistrorsi

- martinetto automatico
- 150 Kg di spinta
- pressione di utilizzo 5+8 bar

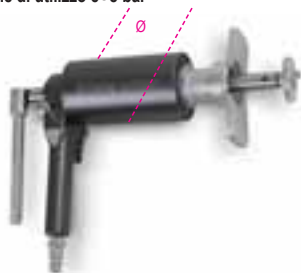

Ø mm 50 Kg 150 Bar 5+8 1 014710069

1471M/P

adattatore per pastiglie usurate e pinze TRW-Mégane



1471M/P 1 014710080

1471M/W50

adattatore per freno stazionamento VW Passat ≥ 2005

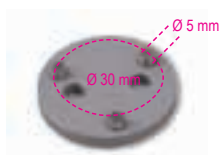

1471M/W50 1 014710079

1471PN/B1

adattatore per freno stazionamento Ford



1471PN/B1 1 014710081

1471PN/B2

adattatore per freno stazionamento Daily



1471PN/B2 1 014710082

1471PN/B3

adattatore per freno stazionamento BMW



1471PN/B3 1 014710083

1471PN/B4

adattatore per freno stazionamento BMW

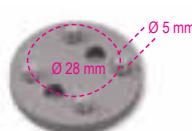

1471PN/B4 1 014710084

1471PN/B5

adattatore per freno stazionamento Mini/ BMW



1471PN/B5 1 014710085

1471CF

chiavi a bussola a mano bocca pentagonale per dadi pinze freno



mm 14 19 1 014710314 1 014710319

1471CM

chiave a bussola maschio pentagonale per viti pinze freno



mm 10 1 014710360

1471CM/E11

chiave a bussola maschio esagonale 11 mm per viti pinze freno Mercedes ML (serie 166)



mm 11 Ø mm 24 L mm 75 L1 mm 15,5 1 014710361

1471PT/C5

kit bussole a Macchina per dadi pinze freno

- Per vetture Volkswagen, Audi e Porsche
- 3 bussole a 10 denti: 11,5 mm - 15 mm - 20 mm
- 1 bussola a 7 denti



1471PT/C5 1 014710367

1471D2

arretratore pistoncini freni a disco anteriori con pinze chiuse

doppia coppia di piastre per operare su pinze a 2 e 4 pistoncini



mm
10

1 014710301

250x170x60 mm 1,5 kg

1471T/C5

5 chiavi a battere per pinze freno truck

in fase di serraggio sono utilizzabili con chiave dinamometrica

misure incluse:

- Torx femmina E18, E20, E24
- poligonali M24, M26



3/4"



1471T/C5

1 014710400

275x220x60 mm - 3,1 kg

1472

pinza per anelli stringitubo



1472

1 014720001

1472AU

pinza automatica per anelli stringitubo



mm
18+53

1 014720100

1472R/AU

puntali di ricambio per pinza 1472AU



1472AU/R

1 014720101

1472AU/P

pinza automatica con prolunga per anelli stringitubo



mm
18+54

L
mm
630

1 014720105

1472AU/RP

cavo di ricambio per pinza 1472AU/P



1472AUP/R

1 014720106

1472B/RNLT

bussola con doppia impronta, dedicata per fascette manicotto aspirazione montate su motori gruppo Renault

mm
9



1472B/RNLT

1 014720250

1472FC

pinza con teste orientabili, per fascette Clic®



1472FC

1 014720090

1472FC/GE

pinza a grande effetto, per fascette Clic®

particolarmente indicata per fascette di grandi dimensioni



L
mm
230

1 014720093

1472FC/L

pinza con prolunga flessibile a testa orientabile a 360°, per fascette Clic®



L
630 mm

1 014720095

1472FCL/RP

cavo di ricambio per pinza 1472FC/L



1472FCL/RP

1 014720096

1472FCA

pinza per rimozione fascette con cremagliera tipo Visa®



1472FCA

1 014720041

1472H

attrezzo per rimozione fascette Henn



L
mm
1472H 100 1 014720000

1472MT/VW

coppia di graffe per
scollamento collettori
di aspirazione gruppo VAG
Utilizzabile su motori turbo benzina 1.0 - 1.2 - 1.4



1472MT/VW 1 014720500

1472TM

pinza per scollegare
i raccordi rapidi
dei filtri multijet



1472TM 1 014720200

1472VW

pinza con teste orientabili
per fascette stringitubo
per vetture del gruppo Volkswagen e Mercedes



1472VW 1 014720051

1473

pinza per collari OETIKER®



1473 275 1 014730001

1473A

pinza con reggiasola
per collari OETIKER®

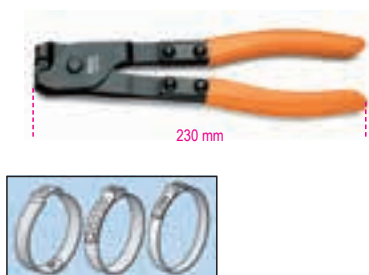

1473A 1 014730010

1473P

pinza per collari OETIKER® pinzabili
a basso profilo



A Max
mm
1473P 53 1 014730020

1473FN

attrezzo per serraggio e taglio
fascette a nastro in acciaio inox

utilizzabile con fascette Panduit® e similari



A mm
4,7÷9,5 1 014730501

1473T

tronchese per rimozione
fascette in acciaio
permette di tagliare le fascette
senza rischiare il danneggiamento di cuffie, manicotti, ecc.



A Max
mm
14 1473T L
mm
220 1 014730582

1474/C4

kit 4 utensili estrazione bobine candele
Volkswagen



1474/C4 1 014740100

290x190x50 mm - 1 kg

1474E/VW

estrattore ad espansione per bobine
accensione gruppo Volkswagen



1474E/VW 1 014740120

1474E/VW2

estrattore bobine accensione
gruppo VAG
utilizzabile su motori 1.0 - 1.2 - 1.4 - 2.0



1474E/VW2 1 014740150

1474L

pinza per cappucci candele d'accensione a becchi lunghi piegati 15°

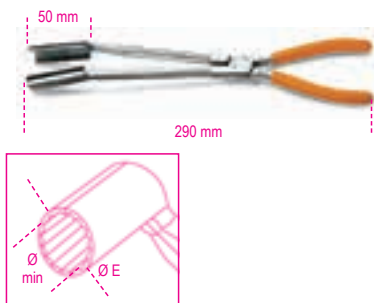

Ø min mm 14 Ø E mm 20 2 014740010

1474DL

pinza per cappucci candele d'accensione a becchi lunghi manici ricoperti con 2 strati in PVC



1474DL 1 014740015

1474G

pinza a becchi lunghi piegati per cappucci candelette di preriscaldamento



1474G 1 014740200

1475U

pinza universale cromata lucida con impugnatura a "pistola" manici ricoperti con 2 strati in PVC

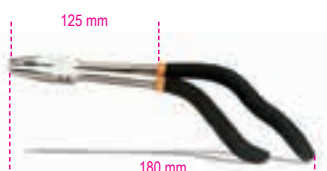

1475U 1 014750010

1476

pinza regolabile autobloccante per taglio tubi di scarico



Ø min mm 19 Ø max mm 75 L mm 225 1 014760002

1476/RC

catena di ricambio per 1476



1476/RC 1 014760012

1476A

pinza per taglio tubi di scarico



Ø min mm 30 Ø max mm 95 1 014760005

1476A/RC

catena di ricambio per 1476A



1476A/RC 1 014760015

1476C/1

attrezzi espansori per tubi di scarico



1476C/1 1 014760101
Ø 30÷42 mm
L = 131 mm
L1 = 51 mm

1476GT

pinza per rimozione supporti in gomma per tubi di scarico



L mm 280 A Max mm 58 3 mm 3 1 014760050

1476PSA

pinza per fascette di scarico con perno, gruppo PSA la forma dei becchi e il blocco automatico della cremagliera permettono di operare senza sfilare il perno



L mm 309 A Max mm 60 S mm 12,2 1 014760060

1476T

chiave per smontaggio/montaggio turbine su motori diesel, gruppo Volkswagen Audi



mm 12 1 014760200

1477/C10

chiave curva con 9 inserti per dadi tendicinghia

1 chiave curva con attacco per inserti
4 inserti poligonali doppi: 12x14 - 13x15 - 16x17 - 18x19 mm
5 inserti per viti con profilo Torx: E10 - E12 - E14 - E16 - E18



1477/C10 1 014770310
530x110x55 mm

1477D

chiavi poligonali
per dadi tendicinghia



mm	
13	1 014770113
15	1 014770115
16	1 014770116
17	1 014770117
19	1 014770119

1477D/S5

serie di 5 chiavi poligonali
per dadi tendicinghia



1477D/S5	1 014770200
13-15-16-17-19 mm	
600x200x70 mm - 2,2 kg	

1477K/7

kit chiave curva a cricchetto reversibile
con inserti



- 2 Inserti Torx® T40-T45
- 1 Inserto XZN® 10
- 1 Inserto esagonale 8 mm
- 3 Inserti poligonali 10-12-13 mm

L	
250	1 014770051

1478

pinza per estrazione pioli



1478	1 014780001
------	-------------

1478N55

pinza per pioli in plastica
con 3 punti di sblocco



L	
180	1 014780163

1478T

pinza con testa orientabile per pioli
in plastica con clips a pressione

testa orientabile a 90°

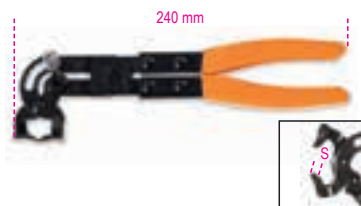

S	
4,5	1 014780101

1478/3P

pinza per pioli in plastica
con 3 punti di sblocco



1478/3P	1 014780151
---------	-------------

1478/K3

kit pinze per pioli con assortimento clips in
plastica

il kit include:

- 1 pinza con becchi dritti
- 1 pinza con becchi a 90°
- 625 clips in plastica in 16 differenti misure
- clips contenute in 3 contenitori in PPL sovrapponibili

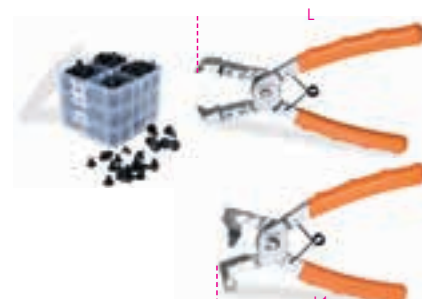

L	L1	
180	170	1 014780160

1479

estrattore per pioli

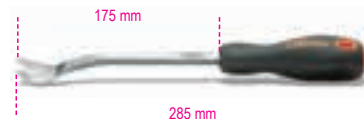

1479	2 014790001
------	-------------

1479/B27

kit di 27 attrezzi in nylon per pioli
e interventi su plastiche e guarnizioni
in busta appendibile



1479/B27	1 014790407
----------	-------------

1479LB/C5

kit di 5 levapioli in metallo



1479LB/C5	1 014790150
-----------	-------------

215x165x50 mm

1479L/S2

coppia di leverini multifunzione
in Teflon®



1479L/S2	1 014790510
----------	-------------



1479LV/S3

kit di 3 leverini multifunzione
in metallo

misure:

1479LV/1: 10x12 mm
1479LV/2: 4,8x9,6 mm
1479LV/3: 2,8x6 mm





1479LV/S3   1 014790100

1479L/K4

4 leverini per interventi
su cruscotti e parti delicate





1479L/K4   1 014790604

1479ML/B17

kit di 17 leverini multifunzione
in materiale plastico

particolarmente adatti per lavori di precisione





1479ML/B17   1 014790700

1479ML/S3

kit di 3 leverini multifunzione
in materiale plastico

Particolarmente adatti per lavori di precisione





1479ML/S3   1 014790603

1479N/S5

kit di 5 levapioli in nylon





1479N/S5   1 014790251

1479RB/1

raschietto a battere tipo diritto





1479RB/1   1 014790315

1479RB/2

raschietto a battere tipo piegato





1479RB/2   1 014790320

1479RB/3

raschietto a battere tipo piatto





1479RB/3   1 014790310

1479U/13

levapioli lama inox





1479U/13   2 014790010

1479U/32

levapioli lama inox



1479U/32   2 014790015

1480



kit riempimento filtri gasolio
per auto senza pompa elettrica

• Utilizzabile anche con pistola gonfiagomme

Il kit include:

- attacchi rapidi GM
- attacchi rapidi Renault, GM, Fiat Ø interno 6 mm
- attacchi rapidi Renault, GM, Fiat Ø interno 7 mm
- attacchi rapidi Ford
- attacchi rapidi PSA Ø interno 6mm
- attacchi rapidi PSA Ø interno 7 mm
- attacchi rapidi Ford
- 2 adattatori conici per vetture senza attacchi rapidi



1480   1 014800010



410x320x70 mm

1481/C12

kit 6 coppie pinze per
occlusione tubazioni

- 2 coppie differenti pinze misura 1/4"
- 2 coppie differenti pinze misura 3/8"
- 2 coppie differenti pinze misura 5/16"
- 3 coppie tappi in gomma



1481/C12   1 014810312

370x270x59 mm

1481K/S4

kit di 4 morsetti autoserranti per occlusione linee

misure: 5/16" - 3/8" - 1/2" e passante



1481K/S4 1 014810400

1481PL/A

pinza in plastica per occlusione tubi e manicotti

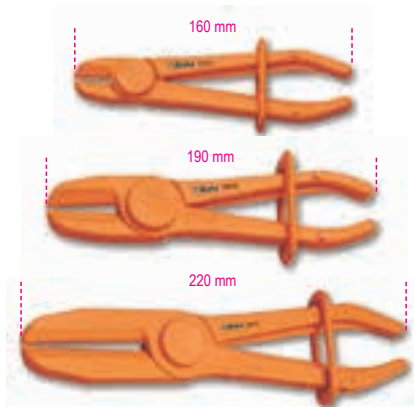

	Ø mm		
1481PL/A	8÷15	3	014810110
1481PL/B	15÷25	3	014810120
1481PL/C	25÷45	3	014810130

1481PL/S3

serie di 3 pinze in plastica per occlusione tubi e manicotti



1481PL/S3		1	014810200
1481PL-A	Ø 8÷15 mm		
1481PL-B	Ø 15÷25 mm		
1481PL-C	Ø 25÷45 mm		

1481T/C12

kit tappi di chiusura linee carburante

3 coppie di tappi con attacco rapido maschio/femmina per chiudere le linee carburante



1481T/C12 1 014810212
275x220x45 mm - 540 g

1482

chiave regolabile autoserrante per ghiera galleggianti serbatoio



Ø mm			
89÷170	1	014820001	
89÷200	1	014820002	

1482A/1

chiave a 3 zampe per ghiera galleggianti serbatoio con ghiera in alluminio

per agire sulla ghiera in alluminio montata dal 2011 su vetture dei gruppi Fiat, Volkswagen, Opel, Chevrolet, Mercedes e BMW



1482A/1 1 014820005

1482A/3

chiave per ghiera galleggianti serbatoio gruppo PSA

il disegno permette di operare sull'asse decentrato rimuovendo la ghiera, senza danneggiare il delicato pescante



1482A/3 1 014820007

1482A/5

chiave per ghiera galleggianti serbatoio a 22 settori

per agire sulla ghiera in plastica montata sulle vetture del gruppo VAG



1482A/5 1 014820015

1482/8 - 1482/10

pinze per raccordi rapidi tubi carburante

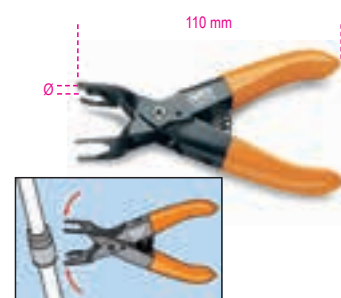

	Ø mm		
1482/8	8	2	014820008
1482/10	10	2	014820010

1482B

pinza per raccordi rapidi tubi carburante



1482B 1 014820021

1482SN

pinza snodata per raccordi rapidi tubi carburante



1482SN 1 014820110



1482C

2 coppie di cunei per sgancio raccordi filtri gasolio gruppo Fiat, Volkswagen, Jeep, Chrysler e Volvo

rapida sostituzione del filtro senza danneggiare irrimediabilmente i raccordi



1482C

1 014820022

1482D

pinza con prolunga flessibile per raccordi rapidi tubi carburante



1482D

1 014820026

1483K/12

kit per smontaggio valvole impianto aria condizionata con serie di inserti pentalobati

Il kit include:

- 2 bussole femmina ottagonali Ø 12 e 15 mm per valvole alta pressione
- 2 bussole maschio a forchetta sezione 2,2 e 3,2 mm per valvole a farfalla
- 1 serie di inserti pentalobati misura: PT10, PT15, PT20, PT25, PT27, PT30, PT40



1483K/12

1 014830012

120x80x35 mm

1483KV-PT/S7

serie di inserti pentalobati

misure incluse:

PT10 - PT15 - PT20 - PT25 - PT27 - PT30 - PT40



1483KV PT/S7

1 014830117

1483K/22

kit per la separazione di raccordi su impianti di condizionamento, alimentazione e lubrificazione



1483K/22

1 014830022

300x230x55 mm - 1 kg

1484

set di 2 utensili per la rimozione e il montaggio delle cinghie elastiche

Permette una rapida rimozione e un corretto montaggio della cinghia elastica senza rischio di danneggiamento



1484

1 014840010

1484PSA

attrezzo per il montaggio della cinghia elastica della pompa dell'acqua senza tendicinghia

utilizzabile per gruppo PSA e Opel motori 1.0 - 1.2



1484PSA

1 014840012

1485BP

attrezzo a mezzaluna per bloccare pulegge dentate

regolabile tramite manico girevole, stringe e blocca la puleggia dall'esterno, evitando danni ai sensori circostanti



A Max mm

130

1 014850000

1485BPM

attrezzo a mezzaluna con ganasce in alluminio per bloccare pulegge multigola

regolabile tramite manico girevole, stringe e blocca la puleggia dall'esterno, evitando danni ai sensori circostanti



A Max mm

180

1 014850002

1485FCA/K2

coppia di attrezzi per precaricare cuscinetti cinghia di distribuzione gruppo FCA

indicati per motori 1.2, 1.4 8/16 V e 1.4 Multiair

- 1 attrezzo lungo 175 mm con puntali da 13,5 mm
- 1 attrezzo lungo 305 mm snodato con puntali da 13,5 mm



1485FCA/K2

1 014850220

1485FCA/T

attrezzo snodato per precaricare cuscinetti cinghia di distribuzione del gruppo FCA



L mm

175

P mm

13,3

1 014850210

1485FCA/TS

attrezzo per precaricare cuscinetti cinghia di distribuzione del gruppo FCA



L mm

305

P mm

13,5

1 014850215

1485FRD/T

leva per il tensionamento delle cinghie dei servizi, montate su motori Ford

utilizzabile per la rimozione delle pulegge degli alternatori



L mm

450

Q mm

12,80

1 014850310

1485MRC/T

leva per il tensionamento delle cinghie dei servizi, montate su motori Mercedes utilizzabile per motori M133 - M270

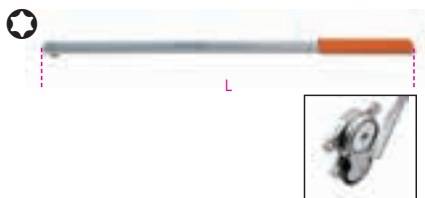

L mm 510
T55
1 014850315

1485VLV/T

leva per il tensionamento delle cinghie dei servizi, montate su motori Volvo



L mm 420
T50-T60
15 mm
1 014850320

1485TC

leva per il tensionamento delle cinghie dei servizi, montate su motori Ford, PSA, FCA



L mm 475
1 014850330

1485/KIT

kit attrezzi per controllo tensione cinghia distribuzione



1485/KIT
230x140x75 mm - 580 g
1 014850100

1485MJ

attrezzo bloccaggio albero a camme motori 1.3 16V Multijet

2 teste con 3 profili per operare su tutti i motori 1.3 16V Multijet montati da gruppo FCA, Opel, Ford e Suzuki



L mm 500
1 014850150

1485PMTJ

leva sbloccaggio pulegge albero motore Multijet

geometria appositamente studiata per bloccare l'albero motore durante le operazioni di rimozione della puleggia



L mm 450
1 014850190

1485R

attrezzo per rotazione pulegge distribuzione in acciaio forgiato con 2 coppie di puntali



Ø mm 30-120
Ø1 mm 10 - 17
L mm 500
1 014850025

1485R/P10

coppie di puntali



1485R/P10
1 014850035

1485R/P17

coppie di puntali

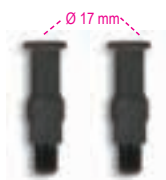

1485R/P17
1 014850038

1485VAG/K2

coppia di attrezzi per precaricare i cuscinetti cinghia di distribuzione

- testa orientabile in 3 posizioni
- 1 attrezzo con testa profonda 12,5 mm
- 1 attrezzo con testa profonda 21,5 mm



1485VAG/K2
1 014850080

1485VAG

attrezzi per precaricare cuscinetti cinghia di distribuzione

- testa orientabile in 3 posizioni



L mm 190
P mm 12,5
1 014850062
L mm 195
P mm 21,5
1 014850071

1486/10

chiave per valvole bombole metano

- gruppo VW dal 2008
- Panda dal 2004 al 2012
- Grande Punto dal 2005 al 2012
- Ducato dal 2010
- nuovi Doblò e Combo
- Cubo e Fiorino



36 mm

1486/10
1 014860110

 **Beta**

1486/20

chiave per valvole bombole metano

- Multipla
- Ducato 1ª e 2ª serie fino al 2010
- Berlingo e Ranch
- C3 con bombole in ferro
- Punto dal 1999 al 2010
- Doblò 1ª serie
- Daily e gruppo Iveco
- Dr5



∅ 36 mm

1486/20 1 014860120

1486/30

chiave per valvole bombole metano

- Zafira 2ª serie
- Combo 1ª serie



∅ 36 mm

1486/30 1 014860130

1486/40

chiave per valvole bombole metano

- Touran 1ª serie

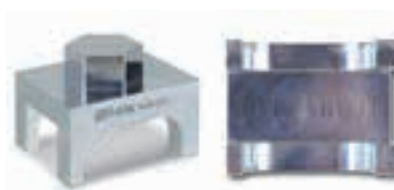

∅ 36 mm

1486/40 1 014860140

1486/50

chiave per valvole bombole metano

- Panda dal 2012
- Nuova Ypsilon

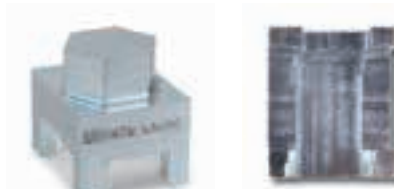

∅ 36 mm

1486/50 1 014860150

1486/60

chiave per valvole bombole metano

- C4 Picasso
- impianti BRC



∅ 36 mm

1486/60 1 014860160

1486/70

coppia di chiavi per valvole bombole metano

- C3 con bombole in composito



∅ 36 mm

1486/70 1 014860170

1486/80

chiave per valvole bombole metano

- Classe B
- Zafira 3ª serie

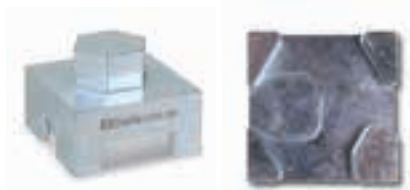

∅ 36 mm

1486/80 1 014860180

1486/90

chiave per valvole bombole metano

- Zafira 1ª serie
- Kangoo 1ª serie
- Sprinter

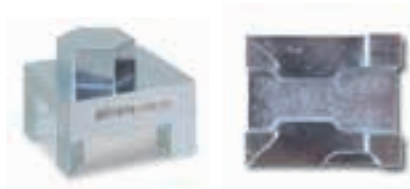

∅ 36 mm

1486/90 1 014860190

1487/K2

2 chiavi per tappi scarico radiatori



17 mm

1487/K2 1 014870100

1488 - 1488L

chiave snodata a catena doppia per filtri olio

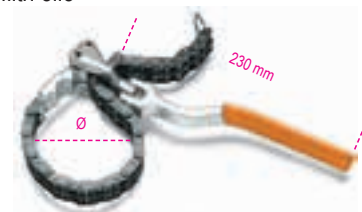

	∅ mm	
1488	60÷110	1 014880001
1488L	60÷160	1 014880050

1488/1

chiave a catena doppia sottile per filtri olio



	∅ mm	
1488/1	60÷110	1 014880010

1488R...

catena di ricambio



	1488	350	
1488RC	1488	350	1 014880101
1488R/L	1488/L	520	1 014880150
1488RC/1	1488/1		1 014880110

1489/31T

chiave per ruota libera puleggia alternatore



	15	31	
1489/31T	15	31	1 014890016

1489/33

chiave per ruota libera puleggia alternatore Bosch





	33	
1489/33	33	1 014890010

1489/33P

chiave per ruota libera puleggia nuovo alternatore Bosch FIAT Grande Punto



12"  
M 10 mm 31 1 014890015

1489/E

chiave per ruota libera puleggia alternatore





mm 10 mm 15  
1 014890025

1489R

chiave per ruota libera puleggia alternatore Renault





1489/R  
1 014890020

1489/Y

chiave per ruota libera puleggia alternatori Nippondenso



















mm 32  
1 014890040

1489/C14

assortimento di 14 utensili per le pulegge libere degli alternatori



1489/C14  
1 014890100



-  867PE 8 mm
-  867PE/L 8 mm
-  867XZN/L M10
-  867TX/L T50
-  867/2 □1/2"
-  920B 10 mm
-  1489/33
-  12" 1489/33P M10
-  1489R
-  1489/Y
-  1489/31T T50
-  1489/E 10 mm
-  188 10 mm
-  188 15 mm

420x250x45 mm - 1,9 kg

1490

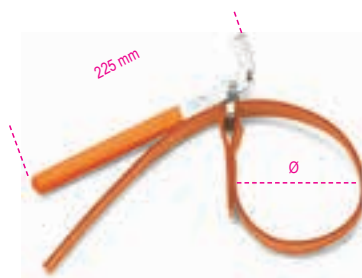
chiavi a nastro per filtri olio







mm max 160 1490/1  
240 1490/2  
1 014900001
1 014900002

1490/R1 - 1490/R2

nastri in tessuto di ricambio per 1490



mm 160 1490R/1  
240 1490R/2  
1 014900101
1 014900102

1490F

chiavi a fascia per filtri





38" 12"  
mm 200 1 014900201

1491

chiave a nastro metallico regolabile per filtri olio





mm 65÷110  
2 014910001

1491R

nastro metallico di ricambio per 1491





1491R  
10 014910010

1491A

pinza regolabile per filtri olio

Regolazione di precisione mediante cremagliera



L mm 345  
mm 55 ÷ 140 1 014910040

1491T

pinza regolabile per filtri olio truck

Regolazione di precisione mediante cremagliera
Utilizzabile per filtri essiccatori



L mm 500  
mm 70÷200 1 014910050



1492/1 - 1492/2

chiavi regolabili per filtri olio

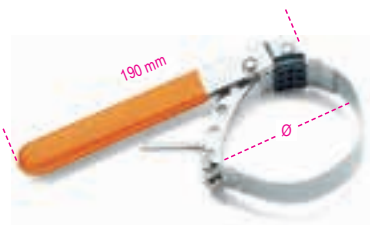

	Ø mm		
1492/1	60÷80	1	014920001
1492/2	80÷110	1	014920002

1492T

chiavi per filtri essiccatori



	Ø mm	H mm	
1492T 40	125÷145	40	1 014920540
1492T 75	120÷140	75	1 014920575

1493B

chiavi poligonali per cartucce filtri olio di difficile accesso



mm	± mm	
24	8	1 014930524
27	8	1 014930527
32	8	1 014930532
36	8	1 014930536
38	8	1 014930538

1493B/S5

serie di 5 chiavi poligonali per cartucce filtri olio di difficile accesso

misure:
24-27-32-36-38 mm



1493B/S5	1	014930599
----------	---	-----------

1493

chiave a bussola per filtri olio

N=numero lati

12"



Ø mm	N	
65	14	1 014930200
68	14	1 014930206
73	14	1 014930208
74	14	1 014930209
74	15	1 014930210
75-77	15	1 014930212
76	8	1 014930214
76	14	1 014930218
76-74	15	1 014930220
78	15	1 014930224
80	15	1 014930226
82-80	15	1 014930228
86	16	1 014930230
90	15	1 014930234
92	10	1 014930236
93	15	1 014930238
95	15	1 014930244
100	15	1 014930248
106	15	1 014930250
108	15	1 014930252
135	18	1 014930256

1493/PF

chiavi a bussola per filtri olio Purflux

N=numero lati

12"



Ø mm	N	
66	6	1 014930202
76	12	1 014930216
76	30	1 014930222
86	18	1 014930232
93	36	1 014930240
93	45	1 014930242
96	18	1 014930246
108	18	1 014930254

1493/C30

serie di 28 chiavi a bussola per filtri olio

12"



Misure incluse nel kit (Ø mm / n° lati)
1493:

65/14 - 67/14 - 68/14 - 73/14 - 74/15
76/15 - 75.77/15 - 76/14 - 76/8 - 78/15 - 80/15
82/15 - 86/16 - 90/15 - 92/10 - 93/15 - 95/15
100/15 - 106/15 - 108/15

1493PF (Purflux)

66/6 - 76/12 - 76/30 - 86/18

93/36 - 93/45 - 96/18 - 108/18

- inclusa 1 chiave regolabile universale
Ø 65÷120 mm

1493/C30

530x400x110 mm - 4 kg

1493AL

chiavi a bussola per filtri olio

N= numero lati

38"

12"



Ø mm	N	●	□	
64	14	27	1/2"	1 014930310
66,5	14	27	1/2"	1 014930315
74	14	27	1/2"	1 014930320
79	15	27	3/8"	1 014930325
84	14	27	3/8"	1 014930330
87	16	27	1/2"	1 014930335
92	15	27	3/8"	1 014930340
94,5	15	27	3/8"	1 014930345
100,5	15	27	3/8"	1 014930350

1493AL 4S

chiavi a bussola per filtri olio per auto asiatiche
profilo a 4 settori

38"

12"



Ø1 mm	Ø2 mm	
70	64,5	27 1 014930304
80	64,5	27 1 014930305

1493AL CF

chiavi a bussola esagonale per cartucce filtri olio

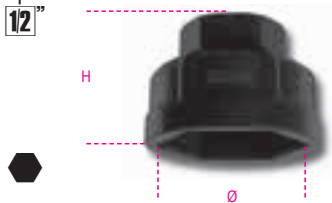

Ø mm	H mm	●	1	014930424
24	34	27	1	014930424
27	34	27	1	014930427
30	34	27	1	014930430
32,5	34	27	1	014930432
36	34	27	1	014930436
38	34	27	1	014930438

1493/C19

serie di 18 chiavi a bussola per filtri olio. particolarmente indicate per auto asiatiche

Misure incluse nella serie:

Ø mm	N lati
63-64	14
66,5	14
74	14
79	15
84	14
87	16
92	15
94,5	15
100,5	15

70 14 a settori per Toyota

80 14 a settori per Lexus

N° 6 bussole esagonali misura 24-27-30-32,5-36-38 mm per cartucce filtro

Il kit include 1 chiave regolabile universale Ø 58+93 mm



1493/C19 1 014930019

490x450x60 mm - 4 kg

1493DSG

chiave per smontaggio/montaggio filtro olio cambio DSG



1493DSG 1 014930800

1493FF

chiave per smontaggio/montaggio della sede in plastica di filtri olio Ford Peugeot Citroën motori: TDCi-HDi

permette di serrare correttamente la sede in plastica con chiave dinamometrica a 25 Nm.



1493FF 1 014930127

1493FT

chiave per filtri gasolio Ford Transit

Utilizzabile su tutte le versioni Transit, Transit Custom e Tourneo Custom dal 2012



1493FT 1 014930085

1493J

chiave per filtri gasolio Multijet

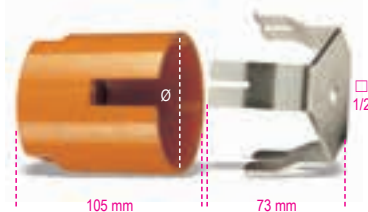

1493J 1 014930080

1493VV

chiave per filtri gasolio gruppo VAG e Volvo



1493VV 1 014930086

1493HK

chiave 15 lati per filtri gasolio Hyundai Kia



1493HK 1 014930087

1493/C7

chiave autoregolabile a tre bracci per filtri olio destrorsa-sinistrorsa, con bracci intercambiabili

finitura diamantata anticivolo

2 serie di bracci:

- 1 serie con lunghezza utile 20 mm
- 1 serie con lunghezza utile 38 mm



1493/C7 1 014930079

210x150x50 mm

1493H

chiave autoregolabile a tre bracci per filtri olio destrorsa-sinistrorsa

Griffe godronate

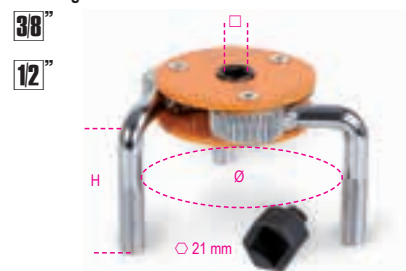

1493H 1 014930077



1493/S-U

chiave autoregolabile a tre bracci per filtri olio destrorsa-sinistrorsa

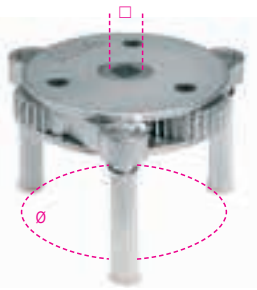

	□	∅	mm		
1493/S	3/8-1/2	80-115		1	014930074
1493/U	1/2	105-165		1	014930076

1493X

chiavi autoserranti per filtri olio sinistrorse



	∅	±	mm		
1493X/1	60÷80	2,9		1	014930105
1493X/2	80÷98	2,9		1	014930110

1493Y

chiavi autoserranti per filtri olio destrorse-sinistrorse versione pesante

l'articolo 1493Y/2 è utilizzabile anche per i filtri essiccatori



	∅	±	mm		
1493Y/1	80÷110	7,3		1	014930120
1493Y/2	104÷145	7,3		1	014930122

1493C/ADB

chiave per apertura tappo AdBlue® gruppo PSA



1493C/ADB				1	014930900
-----------	--	--	--	---	-----------

1493U/ADB

chiave apertura tappo di scarico AdBlue®



1493U/ADB				1	014930910
-----------	--	--	--	---	-----------

1494T/C5

kit chiavi speciali per tappi olio in plastica incluse nel kit:

- 1 chiave per tappi olio gruppo VAG
- 1 chiave per tappi olio BMW
- 1 chiave per tappi olio gruppo PSA e Ford
- 1 chiave per tappi olio Mercedes
- 1 chiave di manovra a "T"



1494T/C5				1	014940350
----------	--	--	--	---	-----------

173x125x50 mm - 360 g

1494BMW

chiave speciale per tappi olio in plastica motori BMW



1494BMW				1	014940315
---------	--	--	--	---	-----------

1494FPC

chiave speciale per tappi olio in plastica motori Ford, Peugeot, Citroën



1494FPC				1	014940320
---------	--	--	--	---	-----------

1494VW

chiave speciale per tappi olio in plastica motori gruppo Volkswagen

permette di rimuovere e installare il tappo in plastica dalla coppa dell'olio. Specifico per vetture del gruppo Volkswagen con motori TFSI e TDI



1494VW				1	014940305
--------	--	--	--	---	-----------

1494MRC

chiave speciale per tappi olio in plastica motori Mercedes



1494MRC				1	014940325
---------	--	--	--	---	-----------

1494MAN

chiave speciale per tappi olio in plastica motori DAF e MAN



1494MAN				1	014940330
---------	--	--	--	---	-----------

1494

chiave a bussola quadrata per tappi olio motore



mm		
10	1	014940280

1494E

chiavi a bussola maschio esagonale per tappi olio motore



mm		
8	1	014940208
9	1	014940209
10	1	014940210
11	1	014940211
12	1	014940212
14	1	014940214
17	1	014940217

1494Q

chiavi a bussola maschio quadrato per tappi olio motore

12"



mm	
8	1 014940258
9,5	1 014940259
12	1 014940262
13	1 014940263

1494T

chiave a bussola maschio triangolare per tappi olio motore

12"



mm	
9,5	1 014940289

1494XZN

chiave a bussola maschio con profilo XZN® per tappi olio motore

12"



M	
16	1 014940296

1494VW/K

kit per sostituzione olio motore gruppo VAG



Contenuto del kit:
• 1 chiave speciale per tappi in plastica
• 6 tappi in plastica per coppa

1494VW/K	
	1 014940310

1494VW/KT

kit 6 tappi in plastica per 1494VW/K



1494VW/KT	
	1 014940311

1494/C14A

assortimento di 14 utensili per cambio olio

12"



1494/C14A	
	1 014940150

- 1494E 8-9-10-11-12-14-17
- 1494Q 8-9,5(3/8")-12-13
- 1494 10
- △ 1494T 9,5(3/8")
- 1494XZN M16

380x305x40 mm - 1,7 kg

1494M

attrezzo per tappi olio esagonali magnetico e flessibile

permette di svitare il tappo senza rischi di scottature e senza sporcarsi



L	F	Ø	
mm	kg	mm	
293	2,5	19	1 014940401

1495/C6

assortimento di utensili per la riparazione dei filetti della coppa olio



• Il filetto danneggiato viene rimosso con il maschio filettato e allargato di una misura
• Consente la riparazione ed evita la sostituzione della coppa olio

Composto da:

- 1 maschio M13x1.25 + 6 viti + 12 rondelle
- 1 maschio M13x1.5 + 6 viti + 12 rondelle
- 1 maschio M15x1.5 + 6 viti + 12 rondelle
- 1 maschio M17x1.5 + 6 viti + 12 rondelle
- 1 maschio M20x1.5 + 6 viti + 12 rondelle
- 1 maschio M22x1.5 + 6 viti + 12 rondelle

1495/C6	
	1 014950500

420x185x60 mm - 2,1 kg

1495M

maschio per filetti tappi olio



M	
13x1,25	1 014950553
13x1,50	1 014950563
15x1,50	1 014950565
17x1,50	1 014950567
20x1,50	1 014950570
22x1,50	1 014950572

1495T

kit di 6 tappi olio e rondelle



M	
13x1,25	1 014950503
13x1,50	1 014950513
15x1,50	1 014950515
17x1,50	1 014950517
20x1,50	1 014950520
22x1,50	1 014950522

1496/C

chiavi per tappi olio motore



8 x 10 mm	
	3 014960010

1497D

pinza con becchi diritti per estrazione relé



A	
min+Max	
mm	
1497D 15÷50	1 014970150

1497BS

pinza con becchi dritti e sottili per estrazione relé e fusibili
i becchi lunghi e molto fini permettono la rimozione del relé e del fusibile in spazi ristretti

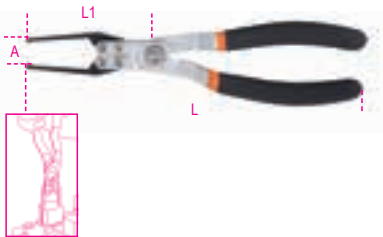

L mm	L1 mm	A mm	
230	45	14	1 014970190

1497P

pinza con becchi piegati a 60° per estrazione relé



L mm	A mm	
1497P	15÷50	1 014970160

1497SS

pinza autobloccante per saldatura fili a stagno
le clips superiori permettono di bloccare ed avvicinare i fili da saldare.
la cremagliera integrata permette di collocare i fili in sei posizioni differenti



L mm	A mm	
245	14÷70	1 014970195

1497TE

pinza per scollegamento connettori elettrici

i becchi molto fini permettono lo sblocco delle clip senza danneggiare i connettori



L mm	A mm	Ø mm	
1497TE	215	63	4
			1 014970180

1497/C23

assortimento di 23 utensili per sblocco connettori elettrici



1497/C23	1 014970200
----------	-------------

440x250x70 mm - 1,7 kg

1497/C94

assortimento di 94 connettori per test su autovetture
utilizzabili con i principali strumenti di diagnosi

- 2 rubacorrente
- 2 potenziometri
- 2 spie di segnalazione
- 2 connettori SRS
- 2 coccodrilli
- 2 sonde ad ago
- 2 puntali
- 2 connettori a banana doppi
- 4 connettori a banana singoli
- 24 terminali maschio piatti 0.6÷6 mm
- 12 terminali maschio tondi 1.6÷3.9 mm
- 24 terminali femmina piatti 0.6÷6 mm
- 12 terminali femmina tondi 1.6÷3.9 mm



1497/C94	1 014970300
----------	-------------

430x390x100 mm - 3 kg

1497RC

coppia di rubacorrente

- sezione cavi: 1,5÷3,5 mm
- voltaggio: 0÷330V
- corrente massima 5A



1497RC	1 014970351
--------	-------------

1497KB/S3

kit di 3 utensili per rimozione connettori elettrici Knorr e Bremse

- 1 utensile per connettori a baionetta
- 1 utensile con impronta per connettori a 2 poli
- 1 utensile con doppia impronta per connettori a 4 o 6 poli e 12 poli



1497KB/S3	1 014970050
-----------	-------------

1497/S3

serie di 3 cavetti per rilevazioni segnali elettrici

- 1 pz dritto
- 1 pz 45°
- 1 pz 90°



1497/S3	1 014970400
---------	-------------

1498

provatensione

CE

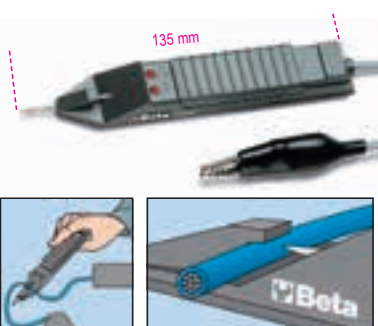

3÷48V	2 014980100
-------	-------------

AUTORIPARAZIONE

I nostri utensili per autoriparazione, usati dai professionisti più esigenti, sono sviluppati e prodotti per soddisfare gli standard più elevati al mondo e testati continuamente nelle condizioni di utilizzo più stressanti.

Da oltre 50 anni, siamo orgogliosamente a fianco dei più grandi campioni, che ci aiutano a migliorare costantemente i nostri prodotti e ne confermano il livello di qualità più assoluta.

Gli utensili dedicati all'autoriparazione si trovano in queste sezioni:

Diagnostica	da 1438 a 1499 da 1758VT a 1760TMC
Motore	da 955 a 989A da 1438 a 1499
Olio e filtri	da 1438 a 1499 da 1877 a 1885
Impianto elettrico	da 1438 a 1499
Avviatori	da 1498BC/12 a 1498/40A
Trasmissione	da 1438 a 1499
Sospensioni	da 1549 a 1569CP
Freni	da 1438 a 1499
Ruote	da 955 a 989A
Carrozzeria	da 1302 a 1369 da 1763 a 1767A
Altre attrezzature	da 1878 a 3067
Sollevatori	da 3029/2T a 3067/70-13T



1498BC/12

avviatore portatile multifunzione 12V

Dati tecnici:

- Corrente di avviamento: 600A
- Corrente di spunto: 1500A
- Tipo di batteria: 4 celle LifePo4
- Capacità batteria: 25000mAh
- Dispositivo di protezione contro inversione di polarità, corto circuito, sovracorrente, carica eccessiva e sovratensione termica



CE



Dotazione:

- Custodia protettiva
- Cavo con pinze di avviamento
- Uscite USB per caricare dispositivi elettronici
- Indicatore led di carica della batteria
- Cavo USB e USB-C
- Alimentatore da rete
- Torcia LED multifunzione

L P H
mm mm mm

1498BC/12 225 100 40 1 014980040

1498MN/12-C

cavo di avviamento con pinze per 1498BC/12



1498MN/12-C 1 014980005

1498MN/12-R

alimentatori di rete mini avviatore 1498BC/12



1498MN/12-R 1 014980003

1498MN/12-P

alimentatore presa auto mini avviatori 1498BC/12



1498MN/12-P 1 014980004

1498MN/12-U

cavi USB con adattatori universali per 1498BC/12



1498MN/12-U 1 014980009

1498LT/12

avviatore portatile ultraleggero ad alte prestazioni



CE



Dati tecnici:

- Tensione di utilizzo: 12 V
- Amperaggio continuo: 800 A
- Amperaggio massimo di avviamento: 2000 A
- Amperaggio di picco: 4000 A
- Lunghezza cavi: 500 mm
- Tipo batteria: 4 celle LifePo4
- Funzione Salva memoria: SI
- Dimensioni: 260 x 135 x 72 mm
- Peso netto: 2,5 kg
- Dotato di alimentatore di ricarica 12 V 1,3A

1498LT/12 1 014980012

1498LT/12-SF

staffa di fissaggio a parete per avviatore 1498LT/12



1498LT/12-SF 1 014980013

1498LT/12-R7

alimentatore di rete per avviatore 1498LT/12



1498LT/12-R7 1 014980057

1498LT/12-24

avviatore portatile ultraleggero ad alte prestazioni 12-24 V

indicato per utilizzo su auto, veicoli commerciali e truck



Il microprocessore permette la totale protezione contro:

- Inversione di polarità
- Corto circuito
- Voltaggio errato
- Sovraccarico
- Sottoscarica
- Sovraccarica
- Sovratemperatura

Dati tecnici:

- Tensione di utilizzo 12/24V
- Amperaggio continuo 2000/1000 A
- Amperaggio massimo di avviamento 5000/2500 A
- Amperaggio di picco 10000/5000 A
- Amperaggio pinze 1000 A
- Lunghezza cavi 160 cm
- Sezione cavi 25mm²
- Alimentatore automatico 4 Amp
- Funzione salvamemorie
- Dimensioni 350x240x140 mm
- Peso 5 kg

1498LT/12-24 1 014980014

1498/12

avviatore per auto 12V portatile



DATI TECNICI:

- Corrente di spunto 2200A
- Tracolla per trasporto inclusa
- Batteria ermetica al piombo electrolyte solido (AGM)

1498/12 1 014980480

13 kg

1498/24

avviatore per auto e veicoli commerciali 12-24V portatile



Dati tecnici:

- Corrente di spunto 4200A (12V) - 2100A (24V)
- Tracolla per trasporto inclusa
- Batteria ermetica al piombo electrolyte solido (AGM)
- Peso 17 Kg

1498/24 1 014980490

1498B12/R02

batteria di ricambio 12V per avviatori 12-24V



1498B12-R02 1 014980502

1498/12-24 R20

alimentatore di rete per avviatore 1498/12 e 1498/24



1498/12-24 R20 1 014980520

1498/2A

caricabatterie elettronico 12V per motocicli

permette la carica di tutti i tipi di batterie al Pb Wet, Agm, Gel, Mf, Vrla e delle batterie al Litio LiFePo4



Caratteristiche:

- Due specifici tipi di carica per batterie al Litio e al Piombo
- Ciclo di ricarica multifase automatico
- Protezione contro inversione di polarità e corto circuito
- Grado di protezione IP65
- Include cavo con pinze e cavo con occhielli
- Tensione di alimentazione: 220-240V

Dati tecnici:

- Corrente di ricarica: 1A
- Capacità di ricarica: 2Ah-40Ah
- Frequenza: 50-60 Hz
- Tensione della batteria: 12V
- Dimensioni: 180x80x40 mm
- Peso: 0,5 Kg

1498/2A 1 014980102

1498/4A

caricabatterie elettronico 6-12V auto-moto



Dati tecnici:

- Tensione di alimentazione: 220V-240V
- Frequenza: 50-60 Hz
- Corrente nominale (min-max): 1-4 Amp
- Tensione della batteria: 6V/12V
- Capacità batteria: 4Ah-80Ah
- Tempo di ricarica: 12 ore
- Grado di protezione: IP65

1498/4A 1 014980104

1498SA/2A-4A

cavo con presa accendisigari per 1498/2A e 1498/4A



1498SA/2A-4A 1 014980120

1498/8A

caricabatterie elettronico 12V auto-veicoli commerciali



Caratteristiche:

- Carica lenta e veloce (2A-8A)
- Funzione recupero batterie scariche
- Funzione alimentatore 13,8V-5A
- Protezione di inversione polarità e corto circuito
- Selezione manuale tipo batteria
- Display digitale retroilluminato
- Gancio di fissaggio reclinabile

Dati tecnici:

- Tensione di alimentazione: 220V - 240V
- Frequenza: 50-60 Hz
- Corrente nominale (min-max): 2-8 Amp
- Tensione della batteria: 12V
- Capacità batteria: 5Ah-160Ah
- Funzione Memory Saver: 13,8V - 5A
- Grado di protezione: IP65

1498/8A



1498/4A-8A CO

cavo ad occhielli per 1498/2A - /4A



1498/4A-8A-CO



1498/4A-8A CP

cavo con pinze per 1498/2A - /4A - /8A



1498/4A-8A-CP



1498/2A-8A-PR

prolunga per 1498/2A/4A/8A



1498/2A-8A-PR



1498/16A

caricabatterie elettronico 12-24V multifunzione



Caratteristiche:

- Display grafico retroilluminato
- Corrente massima di carica 16A continui
- Carica e mantenimento
- Protezione contro inversione polarità, corto circuito
- 9 fasi di ricarica
- Floating system
- Funzione SHOW ROOM (13,8V - 12A)
- Funzione SUPPLY (14V - 12A)
- Funzione memory saver (13,8V - 12A)
- Funzione recupero batterie
- Porta pinze
- Gancio di fissaggio reclinabile
- Inclusi accessori: cavo con pinza, cavo con occhielli

Dati tecnici:

- Alimentazione: 220-240V
- Potenza: 240W
- Corrente di carica: 4-16A
- Tipo batterie: Agm - Wet - Lithium (LiFePo4)
- Capacità di carica: 5-360Ah
- Capacità di mantenimento: 5-550Ah
- Tensione in uscita: 12-24V
- Tensione minima batteria: 0,8V
- Grado di protezione: IP20

1498/16A



1498/25A

caricabatterie elettronico 12-24V multifunzione



Caratteristiche:

- Display grafico retroilluminato
- Corrente massima di carica 25A continui
- Carica e mantenimento
- Protezione contro inversione polarità, corto circuito
- 9 fasi di ricarica
- Floating system
- Funzione SHOW ROOM (13,8V - 21A)
- Funzione SUPPLY (14V - 21A)
- Funzione memory saver (13,8V - 21A)
- Funzione recupero batterie
- Porta pinze
- Gancio di fissaggio reclinabile
- Inclusi accessori: cavo con pinza

Dati tecnici:

- Alimentazione: 220-240V
- Potenza: 390W
- Corrente di carica: 5-25A
- Tipo batterie: Agm - Wet - Lithium (LiFePo4)
- Capacità di carica: 5-550Ah
- Capacità di mantenimento: 5-800Ah
- Tensione in uscita: 12-24V
- Tensione minima batteria: 0,8V
- Grado di protezione: IP20

1498/25A

L mm H mm P mm
260 130 75



1498/120A

caricabatterie elettronico
12V multifunzione

Permette la carica delle batterie
e l'alimentazione dei veicoli durante
tutte le fasi di riprogrammazione e autodiagnosi



- corrente massima di carica 120A continui
- carica e mantenimento con microprocessore CPU
- funzione recupero batterie
- riprogrammazione e alimentazione ECU
- protezione contro inversione polarità, corto circuito, voltaggio errato e sovraccarico

DATI TECNICI

Alimentazione: 90-260V
Potenza: 1500W
Corrente di carica: 10-120A
Tipo batterie: Agm - Wet - Lithium (LifePo4)
Capacità di carica: 10-1200Ah
Capacità di mantenimento: 5-3600Ah
Tensione in uscita: 12V
Lunghezza cavi con pinze: 2700 mm
Dimensioni: 310 x 150 x 350 mm
Peso: 8,5 Kg

1498/120A 1 014980142

1498/40A

caricabatterie avviatore multifunzione 12-24V
carrellato

non avendo una batteria interna, la funzione di avviamento
(max 350A) non sostituisce quella di un avviatore specifico tipo
1498LT/12 (2000A)



- 3 cicli di carica programmati e 1 ciclo manuale
- potenziometro di regolazione elettronica
- processi specifici di carica WET-SPIRAL/GEL-AGM
- sistema di controllo e protezione elettronico
- processo di carica a 10 fasi
- funzione desolfatazione e recupero batteria
- funzione supply
- doppia tensione 12-24V
- idoneo anche per batterie Start&Stop
- pinze professionali in ottone isolate in gomma

DATI TECNICI

Alimentazione: 230V
Tensione in uscita: 12-24V
Corrente di carica: 1-40A
Corrente di avviamento: 350A max cc
Capacità di ricarica: 4-450Ah

1498/40A 1 014980140
330x250x792

1498SM

salva memorie 12 V

evita la perdita dei dati memorizzati dal computer di bordo delle
autovetture durante le operazioni di manutenzione o sostituzione
della batteria.



DATI TECNICI:

- autoalimentato
- batteria interna Pb 5 Ah
- 12 Volt
- connessione professionale con presa OBD

1498SM 1 014980020

1498SM-C

cavi memorie auto OBD II 12V per 1498SM/C



1498SM-C 1 014980021

1498SM-CP

cavi memorie auto pinza 12V 1498SM/CP



1498SM-CP 1 014980022

1498SM-A

alimentatori salva memorie 1498SM/A



1498SM-A 1 014980023

1498TB/6-12

tester analogico per batteria 6 - 12V

permette l'analisi delle batterie da 6V e 12V fino a 1000CCA



TABELLA LETTURA RISULTATI TEST

OK (VERDE):

La capacità della batteria è ok, la batteria potrebbe essere carica o non completamente carica. Ricaricare completamente la batteria.

WEAK o BAD, ma l'ago rimane fisso (GIALLO o ROSSO):

La capacità della batteria non è soddisfacente. La batteria può essere difettosa o non completamente carica. Se la ricarica non avviene al 100%, la batteria deve essere sostituita.

WEAK o BAD, ma l'ago non rimane in posizione (GIALLO o ROSSO):

La batteria potrebbe essere difettosa o completamente esaurita. Sostituire la batteria.

1498TB/6-12 290 170 75 1 014980420



1498TB/12-24

tester digitale per batteria 12V
e analizzatore sistema di avviamento e ricarica
12-24V

- permette di effettuare i seguenti test: batteria, alternatore (intelligente e normale) e avviamento, ripple di diodo e prova di messa a terra
- dotato di software per stampare il test eseguito da PC
- display retroilluminato
- struttura compatta e antiurto
- software in 10 lingue
- dotato di un apposito ingresso per il collegamento di una mini stampante estraibile (accessorio opzionale Beta 1498ST/TB)



CE

Dati tecnici:

- Applicazioni: Test batterie 12V - Test alternatore 12-24V carica - Test sistemi avviamento
- Intervallo di funzionamento: 100-2000 CCA
- Normative di riferimento: CCA, SAE, DIN, EN, IEC, JIS
- Batterie supportate: PB, WET, GEL, AGM, AGM FLAT, EFB
- Voltmetro: 9V-36V
- Lunghezza cavi: 1600 mm
- Lingue: Italiano, Inglese, Francese, Tedesco, Spagnolo, Polacco, Rumeno, Olandese, Svedese e Finlandese
- Accessori inclusi: Cavo USB e Software

1498TB/12-24

1 014980401

1498ST/TB

mini stampante termica
per Tester 1498TB/12 e 1498TB/12-24

- possibilità di collegare la mini stampante direttamente sul tester
- permette di stampare i risultati del test effettuato



CE

1498ST/TB

1 014980410

1498ST/TB ROT

ricambio carta
per stampante 1498ST/TB



1498ST/TB ROT

2 014980411

1498PC

stabilizzatore di tensione 12-24 V

Indispensabile per proteggere le centraline
in fase di saldatura ed avviamenti con avviatori



1498PC

1 014980801

1498TC

tester digitale per candele di
preriscaldamento

- Permette un rapido e preciso test delle candele di preriscaldamento
- adatto a tutti i tipi di candele 4,4-5-7-8,5-10-11 Volt
 - display digitale retroilluminato
 - adatto alle candele in acciaio e in ceramica
 - protetto contro il cortocircuito e inversione di polarità
 - spegnimento automatico quando inutilizzato

- dotato di segnalatore acustico
- dotato di torcia a led SMD
- struttura compatta ed antiurto



CE

DATI TECNICI:

- range di misura: 0.00÷25.0Ω
- tolleranza: ± 2%
- risoluzione: 0.01
- led Display: 1.8"
- temperatura di esercizio: 0°C+50°C
- alimentazione: 1 batteria 9V (non inclusa)

1498TC

1 014980450

1499

stetoscopio



1499

1 014990001

1500/...

estrattori universali
a due griffe

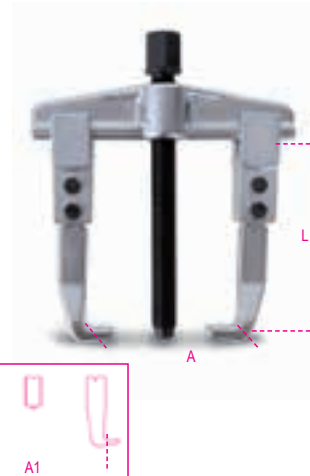

	L mm	
1500/1	100	1 015000301
1500/2	100	1 015000302
1500/3	150	1 015000303
1500/4	150	1 015000304
1500/5	205	1 015000305
1500/6	205	1 015000306
1500/7	205	1 015000307
1500/8	230	1 015000308

	A min+Max mm	A1 min+Max mm
1500/1	25÷80	70÷130
1500/2	25÷130	80÷180
1500/3	50÷160	105÷220
1500/4	60÷200	120÷270
1500/5	80÷250	160÷330
1500/6	80÷350	160÷420
1500/7	110÷520	195÷600
1500/8	170÷640	260÷715



1500/SP5

1500/1-1500/2-1500/3
1500/4-1500/5

1500/SPV

1 015000325

1 015000001

1500G/...

coppia di griffe tipo normale
per 1500 e 1580/8I



	mm	1500	
1500G/1	35	/1-2	1 015000311
1500G/3	35	/3-4	1 015000313
1500G/5	35	/5-6-7	1 015000315
1500G/8	50	/8	1 015000317

1580/8I

1500N/...

estrattori universali
a 2 griffe scorrevoli

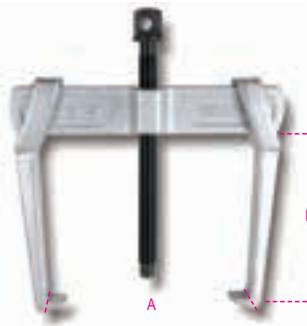

A	L		
min+Max	mm	mm	
18÷65	70	1	015000600
23÷70	100	1	015000601
23÷100	100	1	015000602
35÷140	150	1	015000603
35÷190	150	1	015000604
43÷250	205	1	015000605
43÷320	205	1	015000606



1500N/SP6	1	015000626
1500N/0-1500N/1-1500N/2-1500N/3		
1500N/4-1500N/5		
1500N/SPV	1	015000006

1500N/G...

griffe per estrattori 1500N



	1500N		
mm	mm		
10	/0	2	015000650
12	/1-2	2	015000651
17	/3-4	2	015000653
23	/5-6	2	015000655

1501/1-2-3

estrattori a griffe sottili

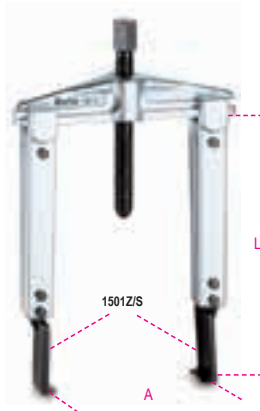

L			
mm			
100	1	015010101	
200	1	015010102	
250	1	015010103	

A	
min+Max	mm
25÷130	1501/1
25÷130	1501/2
25÷130	1501/3

1501G/1-2-3

coppie di griffe per 1501

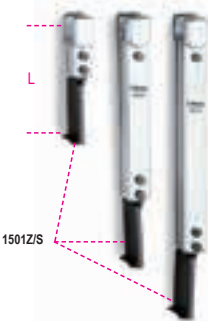

L			
mm			
100	1	015010111	
200	1	015010112	
250	1	015010113	

1501Z/S-P-R

terminali per griffe 1501G



	D		
mm	mm		
2,0	27	2	015010211
3,6	27	2	015010212
3,6	14	2	015010213

1502/...

estrattori universali
a due griffe
con regolazione e chiusura rapida delle griffe

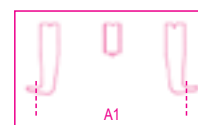

L	L1		
mm	mm		
100	166	1	015020000
100	166	1	015020001
150	247	1	015020002
150	247	1	015020003
200	321	1	015020004

A	A1
min+Max	min+Max
mm	mm
40÷90	80÷130
50÷130	90÷170
65÷150	115÷210
65÷190	125÷260
70÷235	170÷335

1505V

estrattore per bracci tergilicristalli
e tergilunotti

puntale in ottone forato removibile
per estrazione bracci con ugello lavavetro integrato



A Max	L		
mm	mm		
43	37	1	015050001

1505/C5

kit per estrazione tergicristalli

1 estrattore a 2 griffe Ø 25÷40 mm
4 mezzalune Ø 25 mm, Ø 30 mm, Ø 35 mm, Ø 41 mm



mm	1	015050300
12		
320x150x60 mm - 1,2 kg		

1506

estrattore autoserrante
a due griffe

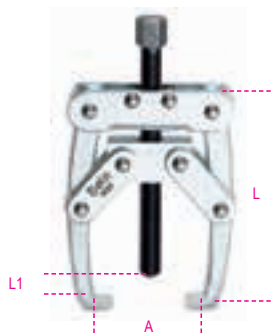

A	L	L1	1	015060001
min+Max	mm	mm		
10÷50	80	40		

1508/1 - 1508/2

estrattori a due griffe
tipo leggero



L	1	015080001
mm		
105		
1508/2	1	015080002
130		

A	L1
min+Max	mm
mm	
6÷100	85
1508/2	10÷140
	120



1511/1 - 2 - 3

estrattori a due griffe reversibili
per esterni

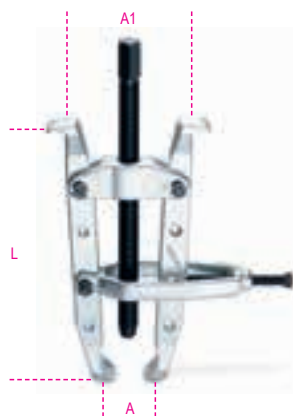

L	1	015110001
mm		
235		
1511/2	1	015110002
330		
1511/3	1	015110003
405		

A	A1
min+Max	min+Max
mm	mm
20÷100	65÷95
1511/2	40÷150
	103÷190
1511/3	40÷150
	103÷175

1515/1 - 2 - 3

estrattori a due griffe
oscillanti

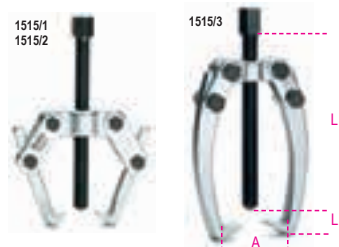

L	1	015150101
mm		
85		
1515/2	1	015150102
85		
1515/3	1	015150103
105		

A	L1
Max	mm
mm	
60	105
1515/2	70
	105
1515/3	90
	105

1516/1 - 2 - 3

estrattori a tre griffe
oscillanti



L	1	015160001
mm		
85		
1516/2	1	015160002
85		
1516/3	1	015160003
105		

A	L1
Max	mm
mm	
60	85
1516/2	70
	85
1516/3	90
	105

1517

estrattori 3 griffe autoserranti

- per elevati carichi d'estrazione.
- effetto autoserrante.



L	L1	Ø	1	015170000
mm	mm	mm		
182	60	22		
1517/150	242	115	1	015170010
1517/200	307	150	1	015170020
1517/260	395	180	1	015170030

●	A	kg	N
mm	mm		
19	18÷90	6000	59000
1517/150	19	25÷150	6000
1517/200	19	40÷200	6000
1517/260	27	50÷260	8000
			78500



1517C/... ESTRATTORI AUTOSERRANTI PER ESTERNI A 2 O 3 GRIFFE

L'estrattore Beta 1517C opera con il serraggio automatico delle griffe grazie alla molla presente sulla traversa. Questa caratteristica facilita il posizionamento ed il bloccaggio dell'estrattore sul particolare da estrarre. Una volta posizionato, le griffe si possono bloccare tramite la ghiera.

La particolare traversa presente sull'1517C ha 4 sedi che permettono all'estrattore di poter essere utilizzato sia con 2 griffe, per un lavoro più facile e veloce, oppure con 3 griffe per una maggiore stabilità di lavoro.

La spina di sicurezza posizionata in testa alla vite si rompe al superamento della coppia massima consentita, salvaguardando così l'estrattore da sovraccarichi.

1517C/... estrattori combinati a due o tre griffe autoserranti

- per un utilizzo a 2 oppure a 3 griffe.
- effetto autoserrante.



	L mm	L1 mm		
1517C0	145	250	1	015170500
1517C1	200	300	1	015170501
1517C2	270	300	1	015170502

	A mm	● mm
1517C0	12÷140	18
1517C1	20÷180	18
1517C2	30÷280	18

1518/... estrattori a tre griffe



	L mm		
1518/1	105	1	015180001
1518/2	135	1	015180002
1518/3	235	1	015180003
1518/4	270	1	015180004
1518/5	270	1	015180005
1518/6	270	1	015180006

	A min+Max mm	L1 mm
1518/1	24÷100	105
1518/2	32÷160	150
1518/3	40÷220	220
1518/4	80÷250	240
1518/5	80÷300	350
1518/6	80÷350	400

1518U/... estrattori universali a tre griffe

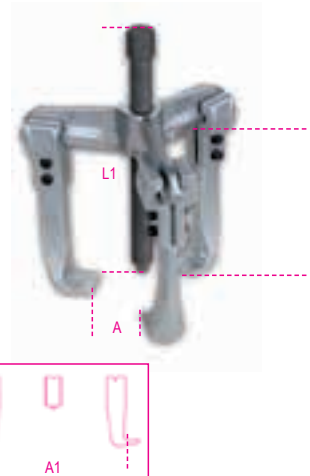

	L mm	L1 mm		
1518U/0	100	166	1	015180500
1518U/1	100	166	1	015180501
1518U/2	150	247	1	015180502
1518U/3	150	247	1	015180503
1518U/4	200	321	1	015180504

	A min+Max mm	A1 min+Max mm	● mm
1518U/0	40÷90	80÷130	17
1518U/1	50÷130	90÷170	17
1518U/2	65÷150	115÷210	22
1518U/3	65÷190	125÷260	22
1518U/4	70÷235	170÷335	27

1519/... estrattori universali a tre griffe con regolazione e chiusura rapida delle griffe

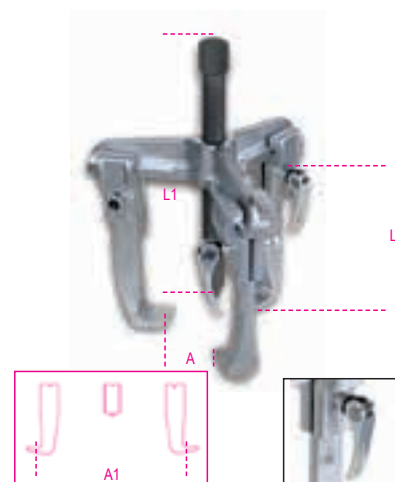

	L mm	L1 mm		
1519/0	100	166	1	015190000
1519/1	100	166	1	015190001
1519/2	150	247	1	015190002
1519/3	150	247	1	015190003

	A min+Max mm	A1 min+Max mm	● mm
1519/0	40÷90	80÷130	17
1519/1	50÷130	90÷170	17
1519/2	65÷150	115÷210	22
1519/3	65÷190	125÷260	22



1520/1 - 1520/2

estrattori a due griffe reversibili

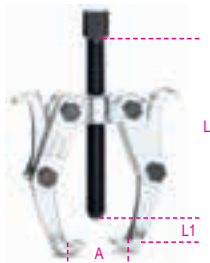

	L mm		
1520/1	135	1	015200101
1520/2	235	1	015200102

	A Max mm	L1 mm
1520/1	110	85
1520/2	160	140

1521/1 - 1521/2

estrattori a tre griffe reversibili

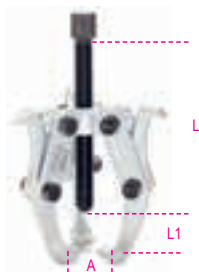

	L mm		
1521/1	135	1	015210101
1521/2	235	1	015210102

	A Max mm	L1 mm
1521/1	110	90
1521/2	160	140

1528

estrattore autoserrante per dischi freno



⊙ 19 mm

A min+Max mm		
170÷380	1	015280000

⊞ 480x240x60 mm - ⚖ 4,8 kg

1529

estrattore per pulegge multigola



A min+Max mm	L min+Max mm	L1 min+Max mm	
24÷240	60÷95	90÷135	1 015290000

⊞ 260x210x60 mm - ⚖ 2,6 kg

1529/C7

estrattore per pulegge

Incluse nel kit:

- 2 griffe con doppio piede spesso 4,7 mm
- 2 griffe a singolo piede spesso 4,3 mm
- 1 griffa con doppio piede spesso 2,3 mm
- 1 griffa a singolo piede spesso 2,3 mm

La coppia di griffe è componibile in base all'esigenza operativa



	L mm	L1 mm	A min+Max mm	
1529/C7	50	72,5	53÷114	1 015290100

⊞ 285x155x50 mm - ⚖ 2 kg

1529PI

estrattore universale per puleggia pompa iniezione

- permette un rapido e preciso smontaggio della puleggia pompa iniezione carburante.
- particolarmente indicato per Fiat, Ford, Volkswagen, Citroen e Peugeot

Incluse 3 coppie di viti per serrare l'estrattore alla puleggia:

- M6 x 1.0 x 49 mm
- M7 x 1.0 x 75 mm
- M8 x 1.25 x 76 mm



1529PI	1	015290051
--------	---	-----------

1529/PG

estrattore per pompa alta pressione gasolio vetture gruppo VAG

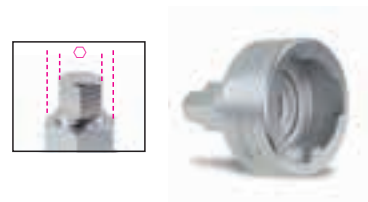

⊙ mm		
15-24	1	015290010

1530/C5

kit per estrazione mozzi e cuscinetti ruote a 3, 4, 5 fori

Il kit comprende:

- 1 flangia universale 96÷138 mm
- 1 vite idraulica da 12 tonnellate
- 1 massa battente da 2,8 kg indispensabile per mozzetti senza bullone di fissaggio centrale



1530/C5	1	015300300
---------	---	-----------

⊞ 760x320x120 mm - ⚖ 11,5 kg

1530/C16

kit a massa battente con colonnette distanziatrici, per estrazione mozzi e cuscinetti ruote a 3, 4, 5 fori

Ideale per mozzi con anello di centraggio sporgente

il kit comprende:

- 1 flangia universale 90÷130 mm
- 1 massa battente da 5 kg
- 4 colonnette attacco M12
- 4 colonnette attacco M14



1530/C16	1	015300316
----------	---	-----------

⊞ 760x310x100 mm - ⚖ 13,5 kg

1531/C7

kit estrazione anello interno
cuscinetto ruota dal mozzo

misure include:

- 1 pinza Ø 40+45 mm
- 1 pinza Ø 45+51 mm
- 1 pinza Ø 50+55 mm
- 1 pinza Ø 55+61 mm



1531/C7

1 015310107

390x315x96 mm - 4,3 kg

1532

utensile per rimozione guarnizioni
e paraoli



1532

2 015320001

1533/...

tiranti per separatori 1534



L	mm	
1533/2	150	1 015330002
1533/3	210	1 015330003
1533/4	315	1 015330004
1533/5A	305	1 015330006

A	min=Max	L1
mm	mm	mm
1533/2	45÷140	110
1533/3	55÷205	175
1533/4	90÷260	175
1533/5A	100÷360	235

1533PR/1 - 2 - 3

prolunghe per tiranti 1533



1533PR/1	1 015330011
1533/2	
1533PR/2	1 015330012
1533/3	
1533PR/3	1 015330013
1533/4-5	
1533PR/5A	1 015330016
1533/5A	

1534/...

separatori

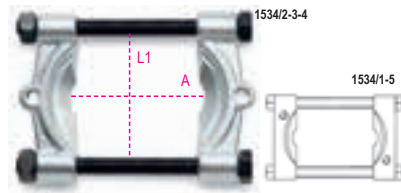

1534/1	1533/2	1 015340001
1534/2	1533/2	1 015340002
1534/3	1533/3	1 015340003
1534/4	1533/4	1 015340004
1534/5A	1533/5A	1 015340006

	A	L1
	min=Max	mm
	mm	mm
1534/1	5÷60	63
1534/2	12÷75	75
1534/3	22÷115	118
1534/4	25÷155	154
1534/5A	30÷220	180

1535/C...

estrattori combinati



1535/C1 1 015350001

1533/2	
1533PR/1	
1534/1	
260x180x40 mm - 2,5 kg	

1535/C2 1 015350002

1533/2	
1533PR/1	
1534/2	
260x180x40 mm - 2,8 kg	

1535/C3 1 015350003

1533/3	
1533PR/2	
1534/3	
380x280x55 mm - 8,0 kg	

1535/C4 1 015350004

1533/4	
1533PR/3	
1534/4	
420x380x65 mm - 14,8 kg	

1535/C5A 1 015350006

1533/5	
1533PR/3	
1534/5	
530x510x85 mm - 27,2 kg	

1539

tiralamiere a percussione



1539 1 015390001

1540

estrattore a percussione

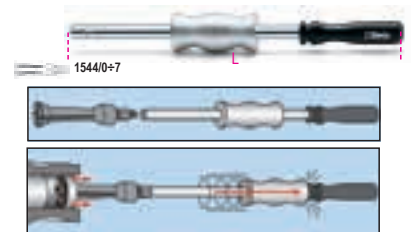

1540 390 M10 0±7 1 015400001





1542/1 - 1542/2

estrattori per griffe ed espansori



	A	1544		
	min+Max			
	mm			
1542/1	35÷75	0÷7	1	015420001
1542/2	60÷130	9C-10C	1	015420002

	L	L1
	mm	mm
1542/1	140	140
1542/2	175	160

1544/...

espansori a settori per interni

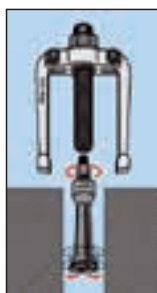

	C	M		
	mm			
1544/0	0,25	M10	1	015440100
A= 5÷7				
1544/A	0,80	M10	1	015440105
A= 7÷9				
1544/1	0,80	M10	1	015440110
A= 9÷12				
1544/2	1,15	M10	1	015440120
A= 13÷17				
1544/2B	1,00	M10	1	015440121
A= 14÷19				
1544/3	1,70	M10	1	015440130
A= 16÷21				
1544/4	1,65	M10	1	015440140
A= 20÷25				
1544/5	2,00	M10	1	015440150
A= 25÷30				
1544/6	3,00	M10	1	015440160
A= 30÷37				
1544/7	3,80	M10	1	015440170
A= 38÷45				
1544/9C	2,60	G 3/8"	1	015440189
A= 40÷75				
1544/10C	7,30	G 3/8"	1	015440199
A= 70÷115				

1545/C5M

estrattore 1542/1 con 5 espansori 1544



1545/C5M 1 015450011

1542/1	● 24 mm
1544/1	9÷12 mm
1544/2	13÷17 mm
1544/3	16÷21 mm
1544/4	20÷25 mm
1544/5	25÷30 mm

265x180x45 mm - 2,4 kg

1547/C6

estrattori per cuscinetti con false sfere

Cuscinetti:

1547/1
6011-6014, 6206-6211, 6303-6308, 6403-6405
1547/2
6004-6010, 6200-6205, 6300-6304

• utilizzabile solo dopo aver "sgabbiato" le sfere.



1547/C6 1 015470006

420x185x60 mm - 3 kg

1547KP

set di 3 coppie di terminali a falsa sfera



	Ø			
	mm			
1547KP/1	9-11-12,5	1	015470106	
1547KP/2	5-6-8	1	015470206	

1547P

prolunghe esagonali



	L			
	mm			
1547P/1	205	1547/1	1	015470101
1547P/2	102	1547/2	1	015470201

1547PG/2

prolunghe tonde corte



	L			
	mm			
1547PG/2	42	1547/2	1	015470202

1547PL/2

prolunghe tonde lunghe



	L			
	mm			
1547PL/2	106	1547/2	1	015470203

1549

kit per smontaggio e montaggio ammortizzatori a doppio effetto con rientro a gas

permette di mantenere lo stelo in estensione durante il montaggio delle molle



1549 1 015490001

310x270x110 mm - 3 kg



1550U

smonta ammortizzatori pneumatico
per autoveicoli, SUV e veicoli commerciali

CE

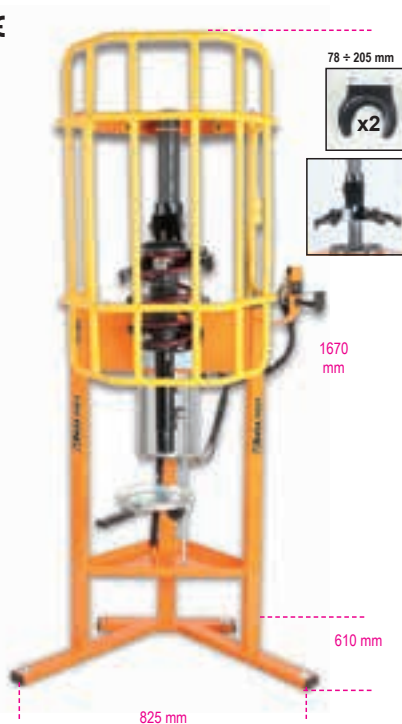

Caratteristiche:

- Potenza di spinta pari a 2 ton (10 bar), 1,6 ton (8 bar), 1,2 ton (6 bar)
- Corsa di compressione molla 335 mm
- Sistema universale di presa superiore che consente di comprimere tutti i diametri di molla, sia destrorse sia sinistrorse, con un'unica piastra adattabile superiore
- Sistema di sicurezza attivo sulla molla che, attraverso il gancio di sicurezza e le 3 valvole di blocco, garantisce il suo corretto funzionamento, mantenendo tale posizione per tutta la durata dell'operazione di compressione (il sistema ferma la macchina nel caso di posizionamento errato della molla)
- Griglia di protezione "Full Body" per garantire la massima sicurezza e copertura della zona di lavoro
- Azionamento con leva di comando per una maggiore precisione e sensibilità durante la fase di compressione
- Altezza di lavoro sulla staffa posteriore alzata fino a 875 mm
- Fornita di 2 staffe inferiori per diametri 78-205 mm

1550U

1 015500010

1550U/CGS-R

coppia ganasce superiori ribassate per 1550U



1550U CGS-R

1 015500035

1550U/MRC-ABE

staffe speciali per 1550U
specifiche per Mercedes Classe A-B-E



1550U/MRC-ABE

1 015500031

1550U/MRC-C

staffe speciali per 1550U
specifiche per Mercedes Classe C



1550U/MRC-C

1 015500032

1550U/S...

staffa inferiore per 1550U



	Ø mm		
1550U/S 130	78÷130 mm	1	015500014
1550U/S 182	105÷182 mm	1	015500015
1550U/S 205	125÷205 mm	1	015500016

1550U/SS187

staffa sinistrorsa per 1550U

particolarmente indicata per molle con profilo sinistro
tipo Nissan Qashqai e Renault Koleos



1550U/SS 187

1 015500018

1550U/M

morsa per smonta ammortizzatori 1550U

permette il bloccaggio dello stelo dell'ammortizzatore



1550U/M

1 015500021

1551/C20

kit per smontaggio teste ammortizzatori

inclusi nel kit:

- 7 bussole esagonali misure: 16 - 17 - 18 - 19 - 21 - 22 - 24
- 1 prolunga porta bussola lunga 120 mm
- 3 inserti femmina con cava misure: 8x5 - 8x6 - 11x8
- 1 inserto femmina esagonale misura: 10 mm
- 1 inserto maschio XZN® misura: M10
- 1 inserto maschio Torx® misura: T50
- 4 inserti maschio esagonali misure: 5 - 6 - 7 - 8
- 1 prolunga porta inserti lunga 95 mm
- 1 prolunga porta inserti lunga 190 mm



1551/C20

1 015510020

320x245x71 mm - 2,6 kg

1552/C9

kit per divaricare i giunti
di ammortizzatori, bracci oscillanti e sterzo

è possibile lavorare con testa a singolo o doppio divaricatore,
in modo da poter operare anche sui giunti doppi tipo gruppo
VAG



1552/C9

1 015520020

195x140x40 mm - 1,0 kg



1555/Q

pressore per molle ammortizzatori MacPherson ed equivalenti

spinta massima 1800 Kg

CE 

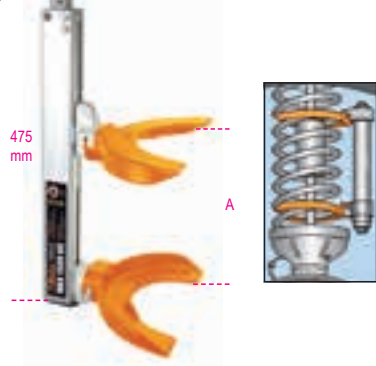

A	∅		
min+Max	min+Max		
mm	mm		
65÷354	80÷195	1	015550006

1555/QS

pressore per molle ammortizzatori Mac Pherson ed equivalenti
Dotato di protezioni in plastica per l'utilizzo in morsa

CE 



A	∅		
min+Max	min+Max		
mm	mm		
70÷300	80÷200	1	015550005

1555S/BMW-RNT

staffa per ammortizzatori BMW E39, E46 e Renault Megane II per 1555Q e 1555/QS



1555S/BMW-RNT	1	015550303
---------------	---	-----------

1555C

pressore telescopico per molle ammortizzatori con 4 staffe e barra di torsione





A	∅	N	t		
min+Max	min+Max				
mm	mm				
80÷225	90÷160	25000	8,5	1	015550202

1556/1A

coppia di pressori per molle ammortizzatori

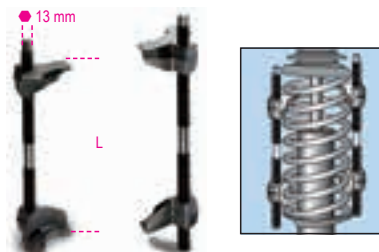

min L	Max		
mm	mm		
65÷320		1	015560101

1556/2A

coppia di pressori per molle ammortizzatori

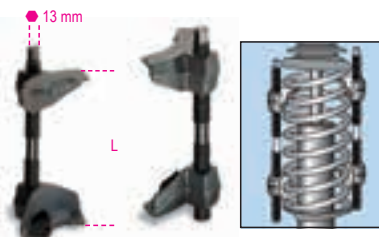

min L	Max		
mm	mm		
65÷200		1	015560102

1557

chiavi a bussola Macchina per perni balestre Truck





L	L1		
mm	mm		
37	28	1	015570137
46	34	1	015570146
56	34	1	015570156

1557V

chiave a bussola Macchina per perni balestre Truck Volvo



∅			
mm			
27		1	015570299

1557/S3

serie di 3 chiavi per ghiera ammortizzatori

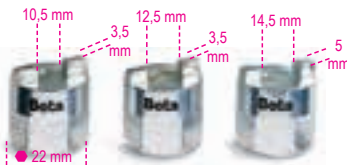

1557/S3	1	015570010
---------	---	-----------

1558/C4

attrezzo per anelli seeger interni ed esterni con azionamento a vite

grazie all'attacco quadro si applica una forza elevata in entrambe le condizioni d'utilizzo
Puntali in dotazione:
∅ 2,5-3-3,5 mm



∅ mm	∅ mm		
5,5 ÷ 77	5,5 ÷ 77		
1558/C4		1	015580100
330x220x50 mm			900 g

1558P

coppia puntali anelli seeger per 1558



∅			
mm			
2,5		1	015580125
3,0		1	015580130
3,5		1	015580135

1558/C13

attrezzo per anelli seeger interni ed esterni con azionamento a vite

grazie all'attacco quadro si applica una forza elevata in entrambe le condizioni d'utilizzo

Puntali in dotazione:
• diritti: ∅ 2,5 - 3 - 3,5 - 3,8 mm
• 45°: ∅ 2,5 - 3 - 3,5 - 3,8 mm
• 90°: ∅ 2,5 - 3 - 3,5 - 3,8 mm



∅ mm	∅ mm		
5,5÷77	5,5÷77		
1558/C13		1	015580200
330x220x45 mm			1,6 kg

1559

estrattori per snodi sferici

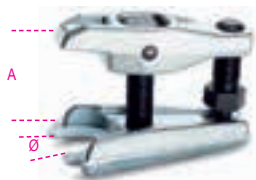

	A Max mm	Ø mm		
1559/22	50	18÷22	1	015590001
1559/36	90	36	1	015590036
1559/45	115	45	1	015590045

1559V/8T

vite idraulica per estrattore snodi sferici
1559/36 e 1559/45

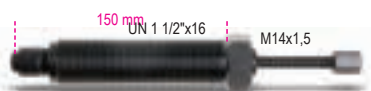

Nm	t		
80000	8	1	015590145

1560/2

estrattori per snodi sferici
modello professionale



	A min÷Max mm	Ø mm		
1560/2	60÷85	20	1	015600002

1560A

estrattore per snodi sferici



1560A	1	015600601
-------	---	-----------

1561/...

estrattori per snodi sferici



	L mm	A mm	Ø mm		
1561/1	39	36,6	18	1	015610001
1561/2	47	45,7	25	1	015610002
1561/3	63	62	30	1	015610003
1561/4	75	63	40	1	015610004

1562D

estrattore per snodi sferici

Fornito con 2 viti per l'estrazione di giunti sospensione e sterzo



A max mm	Ø mm	● mm	L mm		
50	39	26	155	1	015620239

1563/C4

kit 4 bussole per estrazione
snodi sferici

utilizzare con scalpello
includo nel kit:

- 1 bussola M12x1,25 mm
- 1 bussola M12x1,5 mm
- 1 bussola M14x1,5 mm
- 1 bussola M16x1,5 mm



22/24 mm

1563/C4	1	015630010
---------	---	-----------

1565/1-2-3

estrattori a percussione
per snodi sferici



	Ø mm	L1 mm		
1565/1	18	65	1	015650001
1565/2	23	65	1	015650002
1565/3	30	88	1	015650003

1566N

attrezzo per smontaggio/montaggio
braccetti sterzo



Ø x L mm	○ mm	□ mm		
28÷35 x 400	27	12"	1	015660005
35÷45 x 190	27	-	1	015660008
35÷45 x 400	27	12"	1	015660010

1566R

attrezzo regolabile per smontaggio/montaggio
braccetti sterzo

12"



Ø mm		
27÷43	1	015660015

1566/G01

estrattore per giunti omocinetici



L mm	A mm	Ø1 mm	Ø2 mm		
250	115	29	36	1	015660052

1566P

pinza per anelli elastici
millerighe semiassi

la pinza comprime l'anello elastico semplificando
l'inserimento del semiassi nel giunto omocinetico



L mm	A Max mm		
280	36	1	015660091

1567

leva per estrazione testine braccio oscillante
e ammortizzatori dal montante

Utilizzabile da un solo operatore



A mm	B min÷Max mm		
1060	100÷300	1	015670001

1568

attrezzo pneumatico per installazione
cuffie semiassi in silicone
8 griffe con apertura massima di 145 mm

CE



L	L1		
mm	mm		
420	195	1	015680001

1569/F

assortimento di utensili per l'estrazione e
l'introduzione
dei silent block di Fiat Panda, Panda 4x4,
Panda Metano e Cross, Fiat 500, Ford Ka e
Opel Adam



1569/F	1	015690021
--------	---	-----------

1569/SB

assortimento di utensili per l'estrazione e
l'introduzione di: silent block ponte posteriore,
paraoli albero motore e cuscinetti ruota
• le boccole possono essere utilizzate sia direttamente sul
veicolo che alla pressa idraulica



1569/SB	1	015690016
---------	---	-----------

425x365x100 mm - 13 kg

1569CP

insertori a percussione
per cuscinetti conici e paraoli

regolazione rapida



	Ø	L		
	min=Max	mm	mm	
1569CP/50	9,5÷50	130	1	015690750
1569CP/90	18÷90	145	1	015690790

1570/3

martinetto idraulico per estrattori



t	L	L1	●		
mm	mm	mm	mm		
30	243	36	19	1	015700003

1580/8I

estrattore universale
idraulico a due griffe

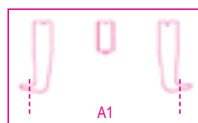
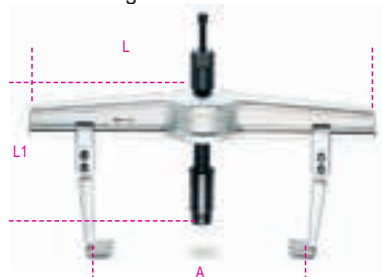

1580/8I	1	015800008
---------	---	-----------

	A	L	L1	A1	N
	min=Max	mm	mm	min=Max	Max
1580/8I	170÷640	715	280	260÷715	180000

1580GL

griffe tipo lungo per estrattori 1580/8I - 1500/8



	L		
	mm		
1580GL/8A	300	1	015800227
1580GL/8B	400	1	015800228
1580GL/8C	500	1	015800229

1585/5I - 6I - 7I

estrattori a tre griffe
per azionamento idraulico

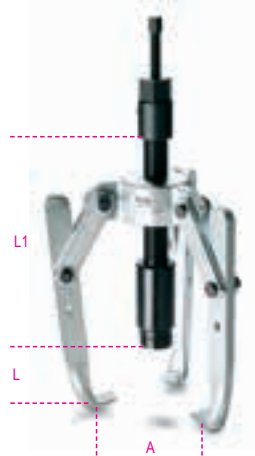

1585/5I	1	015850005
1585/6I	1	015850006
1585/7I	1	015850007

	A	L1	L	N
	min=Max	mm	mm	Max
1585/5I	50÷350	135	280	150000
1585/6I	50÷350	235	280	150000
1585/7I	50÷350	335	280	150000

1585GI/5 - 6 - 7

griffe per estrattori idraulici
1585/5I - 1585/6I - 1585/7I

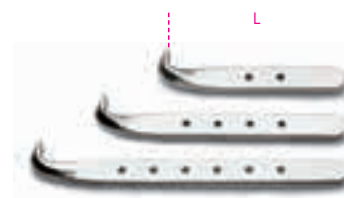

	L		
	mm		
1585GI/5	135	1	015850205
1585GI/6	235	1	015850206
1585GI/7	335	1	015850207

1589VI

vite idraulica per estrattori 1580/8I
e 1585/5I - 1585/6I - 1585/7I

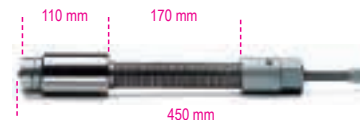

1589VI	1	015890001
--------	---	-----------

1589PI/50 - 100 - 150

prolunghe per vite idraulica



	L	L1		
	mm	mm		
1589PI/50	50	70	1	015890005
1589PI/100	100	120	1	015890010
1589PI/150	150	170	1	015890015

1590

morsetti standard

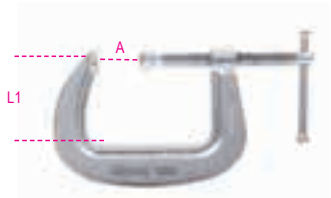

A max mm	L1 mm		
60	55	2	015900305
100	65	2	015900310
150	95	2	015900315

1591

stretti a vite



A ~	A max mm	L1 mm		
200	200	80	2	015910020
300	310	85	2	015910030
400	410	85	2	015910040
500	500	95	2	015910050
600	600	95	2	015910060
800	800	95	2	015910080
1000	1000	110	2	015910100

1593

serragianti a vite

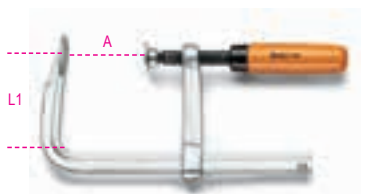

A ~	A max mm	L1 mm		
160	170	80	2	015930016
200	240	100	2	015930020
300	320	145	2	015930030

1594

serragianti a leva

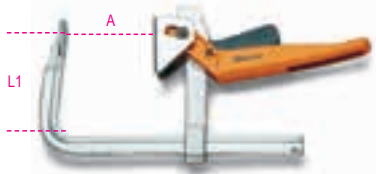

A ~	A max mm	L1 mm		
200	240	145	1	015940020
250	290	145	1	015940025
300	340	145	1	015940030
400	430	150	1	015940040
500	530	150	1	015940050
600	630	150	1	015940060

1595

serragianti a vite

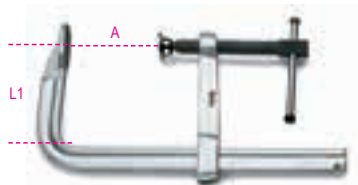

A ~	A max mm	L1 mm		
200	230	100	2	015950020
250	270	120	2	015950025
300	330	120	2	015950030
400	420	120	2	015950040
500	520	125	2	015950050
600	620	125	2	015950060
800	820	125	1	015950080
1000	1030	125	1	015950100

1599F

Morse parallele da banco forgiate

Interamente in fusione di acciaio. Ganasce fresate e temprate in superficie.
Apertura anteriore. Elevata profondità di serraggio.



L1 mm	BxH mm	Ø mm	A MAX mm		
100	92x46	11	125	1	015990100
125	108x54	13	150	1	015990125
150	125x62	13	200	1	015990150
175	140x70	15	220	1	015990175

1599GI

morse parallele da banco con ganasce intercambiabili

- con guida quadra per lavori impegnativi
- ganasce intercambiabili con superficie temprata

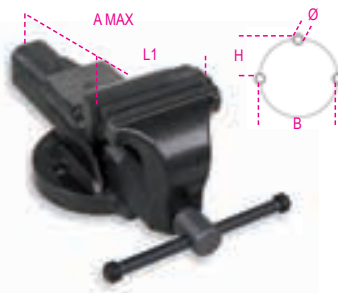

L1 mm	BxH mm	Ø mm	A MAX mm		
100	92x46	11	125	1	015990200
125	108x54	13	150	1	015990225
150	125x62	13	200	1	015990250
175	140x70	15	220	1	015990275

1599GR

coppie di ganasce e viti di ricambio per morse 1599GI



	A mm		
1599GR 100	100	1	015990920
1599GR 125	125	1	015990925
1599GR 150	150	1	015990950
1599GR 175	175	1	015990975

1599P

Morse parallele da banco

Ganasce temperate.
Incudine con ampia superficie verniciata.
Base quadrata in acciaio.

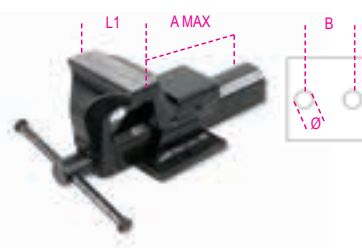

L1 mm	B mm	Ø mm	A MAX mm		
100	92	11	111	1	015990000
125	108	13	130	1	015990025
150	130	15	170	1	015990050

1599B

basi girevoli rotonde per morse 1599P



	1599P		
1599B 100	100	1	015990810
1599B 125	125	1	015990812
1599B 150	150	1	015990815

1599T

morse parallele per trapano

Morse in ghisa speciale, con ganasce temprate e rettificata.
Applicabili sui piccoli e medi trapani a colonna

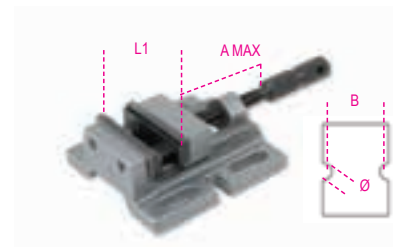

L1 mm	B mm	Ø mm	A MAX mm		
80	111	11	65	1	015990480
100	120	13	87	1	015990500

1599G

copie di copri-ganasce in alluminio

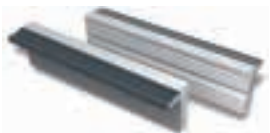

A mm		
100	1	015990910
125	1	015990912
150	1	015990915
180	1	015990917

1600Q 8

chiave a croce per quadristi

quadro da 5 / 6 / 7-8 mm
 triangolo da 7 / 9 mm
 alette 3-5 mm
 esagono 1/4"
 inserto doppio con intaglio 1,0x7 mm e impronta a croce PH2



L mm		
76	1	016000008

1600Q 10

chiave snodabile a doppia croce per quadristi

quadro da 5 / 6-7 / 8-9 mm
 triangolo da 5-6-7 / 8-9 / 10 mm
 alette 3-5 mm
 esagono 1/4"
 quadro maschio 1/4"



L mm		
125	1	016000010

SERVIZIO DI CERTIFICAZIONE STRUMENTI DI MISURA

La certificazione degli strumenti di misura è indispensabile in quei settori o ambiti di applicazione in cui è necessario conoscere e controllare l'esattezza della misura in modo inequivocabile e riconoscibile. La certificazione prevede il rilascio di un certificato Accredia:

Beta Utensili S.p.A. fornisce su richiesta il servizio di certificazione di Calibri corsoio e digitali, Comparatori, Micrometri e Tastatori. Per usufruire di questo servizio rivolgeti al tuo rivenditore di fiducia.



1650

calibro a corsoio
 lettura ventesimale

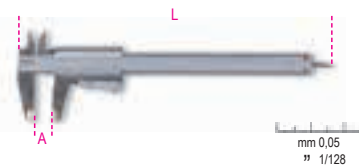

UNI EN ISO 13385-1DIN 862

A max mm	L mm		
150	235	1	016500001
200	290	1	016500002

1650FD

calibro a corsoio per dischi freni
 lettura decimale

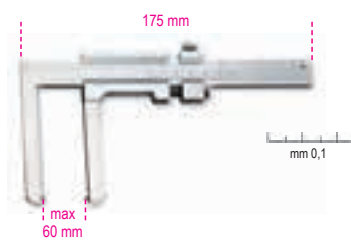

1650FD	1	016500050
--------	---	-----------

1650FT

calibro a corsoio per tamburi freni
 lettura ventesimale



	A max mm	L mm		
1650FT/1	350	438	1	016500060
1650FT/2	500	550	1	016500070

1651DGTB

calibro digitale a corsoio
 lettura centesimale

- Caratteristiche:
- Lettura centesimale
 - Bloccaggio a vite del corsoio
 - Conversione mm/pollici
 - Azzeramento in ogni posizione
 - Asta di profondità quadra fino a 300mm
 - In astuccio rigido di materiale plastico

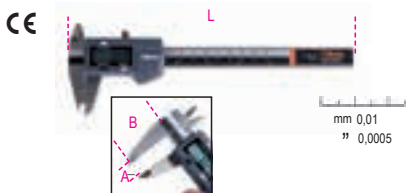

UNI EN ISO 13385-1DIN 862CE

A Max mm	L mm	B mm		
150	235	40	1	016510211
200	285	50	1	016510212
300	400	60	1	016510213



1651DGTB/IP

calibro digitale a corsoio
lettura centesimale grado di protezione IP67

- Lettura centesimale
- Bloccaggio a vite del corsoio
- Conversione mm/pollici
- Accensione automatica con il movimento del corsoio
- Azzeramento in ogni posizione
- Funzione HOLD
- Opzione di scelta tra misura assoluta e incrementale

Il grado di protezione IP67 garantisce una totale protezione dalle polveri e dai liquidi, preservando le caratteristiche funzionali del calibro anche in caso di totale immersione

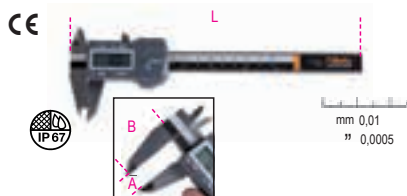

UNI EN ISO 13385-1 DIN 862CE

A Max mm	L mm	B mm	
150	235	40	1 016510711

270x115x35 mm - 450 g

1652

calibro a corsoio con comparatore
lettura cinquantesimale



UNI EN ISO 13385-1DIN 862

1652	1 016520016
------	-------------

1654

calibri a corsoio
lettura cinquantesimale



UNI EN ISO 13385-1DIN 862

A max mm	L mm	
200	330	1 016540020
300	410	1 016540030



1654DGT

calibro digitale a corsoio
lettura centesimale

- Lettura centesimale
- Bloccaggio a vite del corsoio
- Conversione mm/pollici

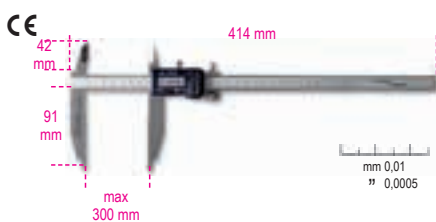

UNI EN ISO 13385-1DIN 862CE

1654DGT	1 016540111
---------	-------------

1656

calibri a corsoio di profondità
lettura cinquantesimale



UNI EN ISO 13385-2DIN 862

A max mm	L mm	
200	260	1 016560020
300	360	1 016560030

1657DGT/2

calibro a corsoio di profondità digitale
lettura centesimale

- Lettura centesimale
- Bloccaggio a vite del corsoio
- Conversione mm/pollici

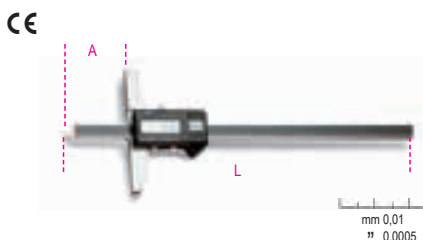

UNI EN ISO 13385-2DIN 862CE

A max mm	L mm	
1657DGT/2	200 270	1 016570002

1658/...

micrometri per esterni
lettura centesimale



DIN 863/II

	A mm	
1658/25	0÷25	1 016580025
1658/50	25÷50	1 016580050
1658/75	50÷75	1 016580075
1658/100	75÷100	1 016580100

1658/C4

assortimento di 4 micrometri 1658



DIN 863

1658/C4	1 016580001
---------	-------------

1658/25	0÷25 mm
1658/50	25÷50 mm
1658/75	50÷75 mm
1658/100	75÷100 mm

365x245x35 mm - 2,5 kg

1658DGTB

micrometri digitali per esterni IP65
lettura millesimale

- Lettura millesimale
- Contatti in metallo duro
- Bloccaggio corsoio tramite leva
- Conversione mm/pollici
- Azzeramento in ogni posizione
- Opzione di scelta tra misura assoluta e incrementale
- Chiave di regolazione nella confezione

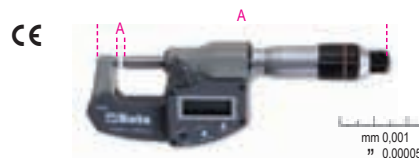

DIN 863CE

1658DGTB 25	1 016580525
1658DGTB 50	1 016580550



1658SP/1

supporto per micrometro

- Morsetto con inserti in gomma
- Rotazione a 90°



1658SP/1 1 016580910

1659

misuratore di spessore
con comparatore
lettura centesimale

C = Campo di comparazione



1659 C mm 0÷10 1 016590001

1662/1 - 1662/2

comparatori
lettura centesimale

C = Campo di comparazione



DIN 878
1662/1 C mm 0÷5 1 016620001
1662/2 C mm 0÷10 1 016620010

1662DGT/A

comparatore digitale
lettura centesimale

C = Campo di comparazione

CE



1662DGT/A C mm 0-12,5 1 016620311

1662AN

comparatore a tastatore orientabile
lettura centesimale

C = Campo di comparazione



DIN 2270
1662AN C mm 0÷0,8 1 016620200

1662SP0

supporto a base magnetica



1662SP0 1 016620800

1662SP2

supporto a base magnetica
snodato



1662SP2 1 016620910

1666

squadre semplici
in acciaio inossidabile
rettificate e lappate



DIN 875/0
L mm L1 mm 1 016660210
150 70 1 016660215
200 100 1 016660220
250 130 1 016660225
300 165 1 016660230

1666A

squadre a cappello
in acciaio inossidabile
rettificate e lappate



DIN 875/0
L mm L1 mm 1 016660110
150 70 1 016660115
200 100 1 016660120
250 130 1 016660125
300 170 1 016660130

1668

squadre semplici
in acciaio normalizzato
rettificate



DIN 875/2
L mm L1 mm 2 016680210
150 70 2 016680215
200 100 2 016680220
250 130 1 016680225
300 174 1 016680230



1668A

squadre a cappello
in acciaio normalizzato
rettificate



DIN 875/2

L mm	L1 mm		
100	70	2	016680110
150	100	2	016680115
200	130	2	016680120
250	165	1	016680125
300	176	1	016680130

1670

squadre semplici
in acciaio non normale



L mm	L1 mm		
100	70	3	016700010
150	100	3	016700015
200	130	3	016700020
250	160	3	016700025
300	175	3	016700030
400	230	2	016700040
500	280	2	016700050
600	330	2	016700060
800	420	1	016700080
1000	500	1	016700099

1670A

squadre a cappello
in acciaio non normale



L mm	L1 mm		
100	70	3	016700110
150	100	3	016700115
200	130	3	016700120
250	165	3	016700125
300	175	3	016700130
400	230	2	016700140
500	280	2	016700150
600	330	2	016700160
800	420	1	016700180
1000	500	1	016700199

1672

squadra falsa
a lama orientabile e scorrevole
lama e base in acciaio

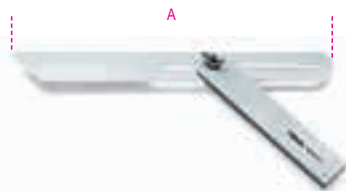

A mm		
300	2	016720030

1672A

squadre false
a lama orientabile e scorrevole
lama in acciaio cromata
base in alluminio

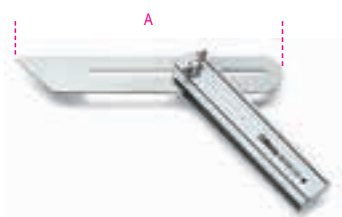

A mm		
200	3	016720120
300	3	016720130

1674A

squadre per falegnami
lama in acciaio, base in alluminio
doppia scala millimetrata



L mm	L1 mm		
300	169	2	016740130
400	214	2	016740140

1676

goniometri semplici
in acciaio

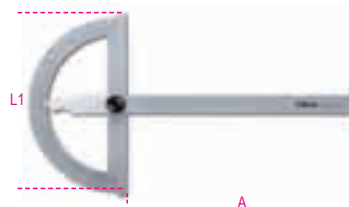

A ~	A mm	L1 mm	G mm		
120	120	80	1°	2	016760012
150	165	120	1°	2	016760015
200	210	150	1°	2	016760020
300	310	200	1°	1	016760030

1678/C3

rapportatore d'angoli
in acciaio inossidabile

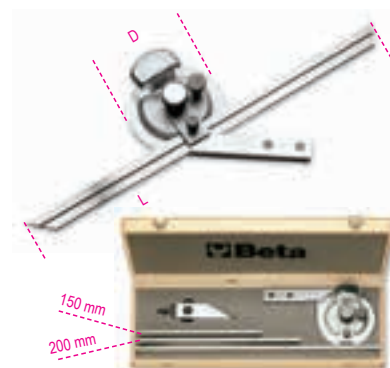

	L Max mm	D mm		
1678/C3	300	70	1	016780030

1679

calibro a tracciare con rotella
in acciaio inossidabile
lettura decimale

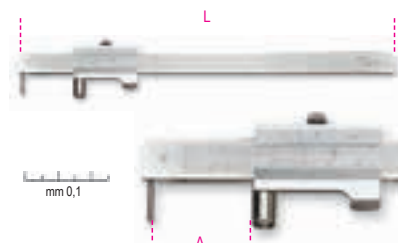

L mm	A Max mm		
235	200	1	016790020

1679/PR

punta di ricambio per calibro 1679



1679/PR	1	016790021

1680

compasso a verga
corpo e punte di tracciatura
in acciaio temprato
• Regolazione fine cinquantessimale

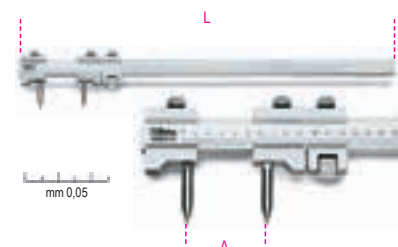

L mm	A Max mm		
660	500	1	016800050

1680A

compassi di precisione per interni



L mm	A Max mm		
150	144	2	016800115
200	200	2	016800120
250	245	1	016800125
300	300	1	016800130

1680B

compassi di precisione per esterni



L mm	A Max mm		
150	155	2	016800215
200	190	2	016800220
250	235	1	016800225
300	280	1	016800230

1680C

compassi di precisione per tracciatori
punte diritte in acciaio temprato



L mm	A Max mm		
150	138	2	016800315
200	190	2	016800320
250	235	1	016800325
300	280	1	016800330

1682

righe flessibili graduate
in acciaio inossidabile

- doppia scala millimetrata
- antiriflesso



L mm	H mm	\pm mm		
150	13	0,5	5	016820015
200	13	0,5	5	016820020
250	13	0,5	5	016820025
300	13	0,5	5	016820030
500	13	0,5	2	016820050
1000	13	0,5	2	016820100

1683

righe semirigide graduate
in acciaio inossidabile

- doppia scala millimetrata
- antiriflesso

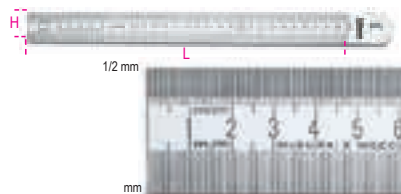

L mm	H mm	\pm mm		
300	30	1	5	016830030
500	30	1	2	016830050
1000	30	1	2	016830100
1500	30	1	1	016830150

1685/C7

assortimento di 7 strumenti
per misurare e tracciare



1685/C7 1 016850110

	1650	160 mm
	1658/25	0+25 mm
	1670	100 mm
	1680C	150 mm
	1682	150 mm
	1688BC	165 mm
	1688BC/R	

320x210x37 mm - 1,2 kg

1687A

punta di precisione piegata a 90°
con impugnatura

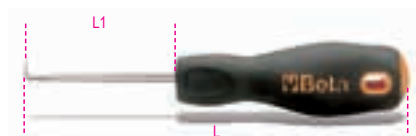

	L mm	L1 mm		
1687A	153	80	1	016870120

1687AC

punta di precisione piegata corta
con impugnatura



	L mm	L1 mm		
1687AC	153	80	1	016870125

1687D

punta di precisione diritta
con impugnatura

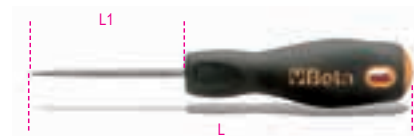

	L mm	L1 mm		
1687D	153	80	1	016870110

1687U

punta di precisione ad uncino
con impugnatura

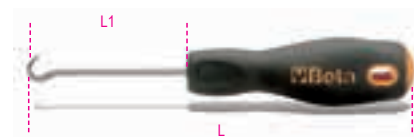

	L mm	L1 mm		
1687U	153	80	1	016870115

1687/S4

serie di 4 punte di precisione
con impugnatura



1687/S4			1	016870150
1687A-1687AC				
1687D-1687U				

1688

punta per tracciare
in acciaio temprato



	L mm	Ø mm		
1688	250	2	5	016880020

1688A

punta per tracciare in acciaio temprato
con punte in carburo di tungsteno



	L mm	Ø mm		
1688A	200	4	5	016880120

1688PC

punta per tracciare a penna
in acciaio temprato cromato



1688PC	L mm	Ø mm	1	016880300
	150	1		

1688PC/R

punta di ricambio per 1688PC



1688PC/R	1	016880310

1688M

matita per falegnami



1688M	L mm	50	016880880
	180		

1690F

metro pieghevole in fibra di vetro
classe di precisione III

CE



1690F/2	L m	S mm	5	016900220
	2	17		

1690L

metro pieghevole in legno di betulla
classe di precisione III

CE



1690L/2	L m	S mm	5	016900200
	2	17		



1691BM

flessometri
cassa bimateriale in ABS antiurto
nastro in acciaio
classe di precisione II

CE



1691BM/5	L m	S mm	1	016910205
1691BM/8	8	32	1	016910208
1691BM/10	10	32	1	016910210

1691MG

flessometri con magnete fisso
cassa bimateriale in ABS antiurto
nastro in acciaio
classe di precisione II

CE



1691MG/5	L m	S mm	1	016910405
1691MG/8	8	25	1	016910408
1691MG/10	10	25	1	016910410

1692

flessometri
cassa bimateriale in ABS antiurto
nastro in acciaio
classe di precisione II

CE



1692/2	L m	S mm	5	016920052
1692/3	3	16	5	016920053
1692/5	5	19	5	016920055
1692/8	8	25	5	016920058

1693

misuratore di distanza laser
20 metri

MISURAZIONI:

- misura di distanza singola
- misura continua o misurazione minima

Auto spegnimento

Durata batteria: fino a 4.000 misurazioni
Custodia morbida in tela (inclusa)

CE
IP54



Dati tecnici:

- Campo di misurazione: da 0,05 a 20m (da 0.2ft a 66ft)
- Selezione scala: m, in, ft
- Precisione: ±1,5 mm (± 0.06 in)
- Classe Laser: 2
- Batterie: AAA 2 x 1.5V

1693 20	H mm	L mm	S mm	1	016930020
	100	36	23		

1693M

misuratore di distanza laser, multifunzione
80 metri

MISURAZIONI:

- misura di distanza singola
- misura continua o misurazione minima

FUNZIONI:

- Addizione/sottrazione
- misura dell'area
- misura del volume
- misurazione indiretta variabile (misurazione pitagorica)
- Misurazione inclinazione

Auto spegnimento

Durata batteria: fino a 4.000 misurazioni
Custodia morbida in tela (inclusa)

CE
IP54



Dati tecnici:

- Campo di misurazione: da 0,05 a 80m (da 0.2in a 229ft)
- Selezione scala: m, in, ft
- Precisione: ±1,5 mm (± 0.06 in)
- Classe Laser: 2
- Memorizzazione misure: 99
- Batterie: AAA 2 x 1.5V

1693M 80	H mm	L mm	S mm	1	016930080
	115	48	29		



1694/L

rotelle metriche
cassa in ABS antiurto
nastro in fibra di vetro ricoperto in PVC
classe di precisione II



	L m	S mm		
1694L10	10	13	1	016940110
1694L20	20	13	1	016940120

1694A/L

rotelle metriche con impugnatura
cassa in ABS antiurto
nastro in fibra di vetro ricoperto in PVC
classe di precisione II



	L m	S mm		
1694A/L30	30	13	1	016940230
1694A/L50	50	13	1	016940250

1694B/L

rotella metrica con impugnatura
cassa in alluminio
nastro in acciaio smaltato
classe di precisione II



	L m	S mm		
1694B/L50	50	12,5	1	016940350

1695XS

livella tascabile con base a "V"
magnetica in alluminio profilato
2 file infrangibili
precisione 1mm/m

- ideale per tubi e sezioni tonde in genere
- fornita con clip



L mm	H mm	S mm		
70	48,5	20	5	016950250

1696

livelle in alluminio profilato anodizzato
con file infrangibili
precisione 1 mm/m



L mm	H mm	S mm		
200	50	19	2	016960002
400	50	19	2	016960004
500	50	19	2	016960005
600	50	19	2	016960006
800	50	19	2	016960008
1000	50	19	2	016960010

1696A

livelle in alluminio pressofuso
con 1 base rettificata a 2 file infrangibili
precisione 1 mm/m



L mm	H mm	S mm		
300	43	23	2	016960103
400	43	23	2	016960104
500	43	23	2	016960105
600	43	23	2	016960106
800	43	23	1	016960108
1000	43	23	1	016960110

1696B

livelle con base magnetica
in alluminio profilato
anodizzato a 2 file infrangibili
precisione 1 mm/m



L mm	H mm	S mm		
200	49	22	2	016960202
300	49	22	2	016960203
400	49	22	2	016960204
500	49	22	2	016960205
600	49	22	2	016960206

1696D

livelle in alluminio pressofuso con
impugnature, (tranne la versione da 300 mm)
4 basi rettificare 3 file infrangibili
precisione 1 mm/m



L mm	H mm	S mm		
300	47	25	2	016960353
400	47	25	2	016960354
500	47	25	2	016960355
600	47	25	2	016960356

1696S

stadio in alluminio con impugnatura
a due file infrangibili
precisione 1 mm/m



L mm	H mm	S mm		
1500	90	25	1	016960415
2000	90	25	1	016960420
2500	90	25	1	016960425
3000	90	25	1	016960430

1697

livella laser a croce
30 metri, raggio verde
con supporto magnetico e morsetto da parete
in valigetta

CARATTERISTICHE TECNICHE:

- croce autolivellante
- possibilità di esclusione della funzione di autolivello
- diodo laser 515 Nm, classe 2
- portata: 30 mt
- precisione: ± 1 mm a 5 metri
- campo di autolivellamento: $3^\circ \pm 0.5^\circ$

- corpo in ABS e gomma antiscivolamento
- attacco femmina da 1/4"
- pile 2xAAA
- autonomia: 4 ore

SUPPORTO:

- 1 supporto magnetico da usare singolarmente e in combinazione, con attacco maschio da 1/4"
- 1 supporto con morsetto con serraggio regolabile per vari profili in legno e metallo (da utilizzare in combinazione al supporto magnetico)
- possibilità di allineamento rapido orizzontale e verticale con un angolo di 90°

CE

IP55



H mm	L mm	S mm	
82	57	89,5	1 016970030

320x230x90 mm

1699L

livella lineare di precisione
in ghisa con base prismatica rettificata
a 2 file infrangibili
precisione 0,05 mm/m



DIN 877

L mm	A mm	
1699L 200	49	1 016990002

1699L/1

livella lineare di precisione
in ghisa con base prismatica rettificata
a 2 file infrangibili
precisione 0,02 mm/m



DIN 877

L mm	A mm	
1699L/1 200	49	1 016990005

1699Q

livelle quadre di precisione
in ghisa con 2 basi prismatiche
e 2 basi piane rettificata
a 2 file infrangibili
precisione 0,05 mm/m



DIN 877

L mm	A mm	
150	40	1 016990015
200	48	1 016990020

1700N

punte per edilizia



L mm	S mm	
250	16	5 017000005
300	16	5 017000006

1700N/PM

punte per edilizia
con paramano



L mm	S mm	
250	16	2 017000105
300	16	2 017000106

1701N

scalpelli per edilizia



L mm	A mm	S mm	
250	23	16	5 017010001
300	23	16	5 017010003

1701N/PM

scalpelli per edilizia
con paramano



L mm	A mm	S mm	
250	23	16	2 017010101
300	23	16	2 017010103

1701PMR

paramano per 1700N e 1701N



D mm	L mm	
16	115	1 017010206

1701NE/...

scalpelli per elettricisti



	SxL mm	
1701NE3	10x200	5 017010406
1701NE4	10x250	5 017010409

1702N

scalpelli a tagliente extrapiatto



A mm	SxH mm	
50	13x23	2 017020005
70	13x23	2 017020007

1702N/PM

scalpelli a tagliente extrapiatto
con paramano



A mm	SxH mm	
50	13x23	2 017020105
70	13x23	2 017020107



Si raccomanda di raffreddare
frequentemente l'utensile durante
la riaffilatura.

1702PMR

paramano per 1702N



L mm	
115	1 017020200

1704

leve piegate per carpentieri

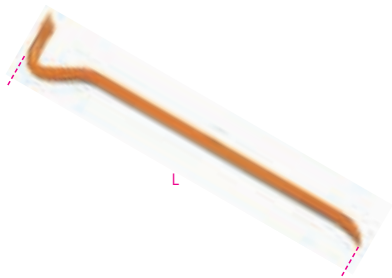

L mm	6 mm	8 mm	10 mm		
500	16	35	28	2	017040050
600	16	34	26	2	017040060
800	18	38	29	2	017040080

1704A

leve con estremità a punta e a scalpello



L mm	6 mm	8 mm		
1500	25	45	1	017040110
2000	28	55	1	017040120

1704C

leve con estremità a punta e penna chiusa



L mm	8 mm-MAX	10 mm		
1200	21-31	39	1	017040210
1400	31-37	42	1	017040212
1600	25-37	42	1	017040215

1705

traccialinea in alluminio



L m				
1705	30		4	017050001

1705PT

polvere traccialinea



g			
250		5	017050025

1706DGT

calibro digitale di profondità per battistrada pneumatici



1706DGT	1	017060011
---------	---	-----------

1707

contafiletto

Per filetti metrici ISO a 60° e Whitworth a 55°



P (ISO)	W		
0,25÷6	62÷4x1"	5	017070001

1707A/1-2-3

raggimetri

lame concave e convesse, in acciaio

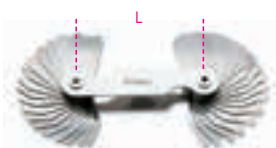

	R	L		
	mm	mm	n	
1707A/1	1,0÷7,0	70	34	2 017070007
1707A/2	7,5÷15	85	32	2 017070015
1707A/3	15,5÷25	85	30	2 017070025

1708/8 - 13 - 20

spessimetri



1708/8	S = 0,05±0,50 mm	5	017080008
1708/13	S = 0,05±1,00 mm	5	017080013
1708/20	S = 0,05±1,00 mm	5	017080020

1709/10 - 1709/18

spaccadadi



	L mm	A max mm		
1709/10	90	17 (M10)	1	017090010
1709/18	108	25 (M16)	1	017090018

1710

spaccadadi idraulico



C min mm	C max mm		
7(M4)	22(M14)	1	017100001

1712E/1-2-3

flessibili magnetici

F = forza magnetica



	L mm	D mm	F kg	
1712E/1	420	7,5	0,5	2 017120011
1712E/2	530	15	1,8	2 017120012
1712E/3	532	19	3,0	2 017120013

1712TF

magnete telescopico con testa flessibile

• Con pulitore per ugelli lavavetri
F= forza magnetica



L mm	D mm	F kg	
150÷590	11	1	1 017120600

1713M

artigli prensili flessibili

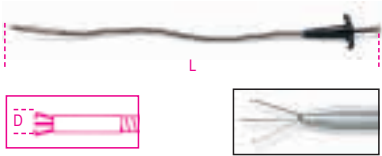

L mm	D mm		
500	7	2	017130011
1000	7	1	017130015

1714

specchietto rigido
in materiale plastico



L mm	D mm		
1714	155	25	5 017140001

1715

specchietto telescopico articolato
corpo in metallo cromato



L mm	D mm		
1715	180+540	30	1 017150001

1715FL/A

specchietto flessibile rettangolare



L mm	A mm	B mm		
1715FL/A	600	53	90	1 017150110

1715R/FL

kit di 2 specchietti di ricambio per 1715FL/A e 1715FL/B

1715R/FL	1 017150151
----------	-------------

1715FL/B

specchietto flessibile rettangolare
con illuminazione
pile: 2X AAA

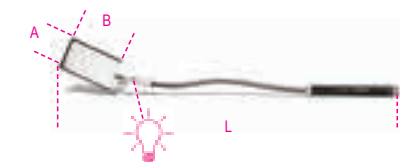

L mm	A mm	B mm		
1715FL/B	553	53	90	1 017150115

1715B/R5L

kit di 5 lampadine di ricambio per 1715FL/B

1715B/R5L	1 017150152
-----------	-------------

1716A

punta angolata per usi generici



L mm	L1 mm	■ mm		
1716A	240	125	6	3 017160040

1716P

raschietto per guarnizioni



L mm	L1 mm	● mm		
1716P	250	125	6	3 017160020

1716Q

punteruolo a punta quadra

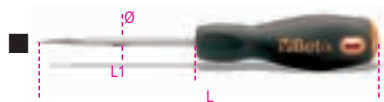

L mm	L1 mm	Ø mm		
1716Q	215	100	6	5 017160010

1716R

punteruolo a punta tonda



L mm	L1 mm	Ø mm		
1716R	215	100	6	5 017160001

1716U

punta ad uncino per usi generici



L mm	L1 mm	Ø mm		
1716U	195	80	6	3 017160025

1717A

raschietti a due taglienti



L mm	L1 mm	L2 mm		
1717A	70	260	2	017170015
200	75	310	2	017170020
250	100	360	2	017170025

1717B

raschietti a tre taglienti



L mm	L1 mm	L2 mm		
150	75	260	2	017170115
200	85	310	2	017170120
250	100	360	2	017170125

1717C

raschietti piatti



L mm	S mm	L1 mm		
150	18	270	2	017170215
200	20	320	2	017170220
250	25	370	2	017170225

1717D

raschietto piatto a tagliente frontale



L mm	S mm	L1 mm		
1717D	150	150	23 240	2 017170320

1717T

raschietti con lama triangolare
completa di 2 lame



L mm			
1717T	310	1	017170610

1717T RT

lame triangolari di ricambio



L mm			
1717T RT	65	1	017170660

1717T RS

lame sagomate di ricambio



1717T RS	1 017170661
----------	-------------

1717V

raschietti per vernici
con lama utilizzabile su più lati



	L mm	A mm		
1717V 38	200	38	1	017170703
1717V 65	285	65	1	017170706

1717V R

lame di ricambio per 1717V



	L mm			
1717V R38	38		1	017170753
1717V R65	65		1	017170756

I TAGLI DELLE LIME PER MECCANICA

Grossolano

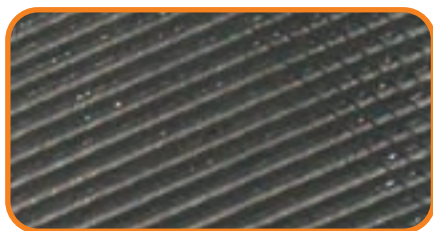

Mezzodolce

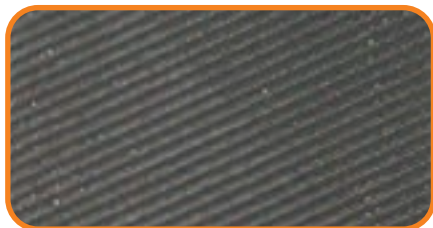

Dolce



1718D...Q

lime quadre a taglio **grossolano**, senza
impugnatura



	L mm	L "		
1718D6/Q	150	6	5	017180121
1718D8/Q	200	8	5	017180131
1718D10/Q	250	10	5	017180141

1718A...Q

lime quadre a taglio **mezzodolce**, senza
impugnatura



	L mm	L "		
1718A6/Q	150	6	5	017180021
1718A8/Q	200	8	5	017180031
1718A10/Q	250	10	5	017180041

1718D...T

lime triangolari a taglio **grossolano**, senza
impugnatura

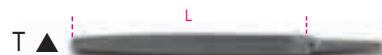

	L mm	L "		
1718D6/T	150	6	5	017180123
1718D8/T	200	8	5	017180133
1718D10/T	250	10	5	017180143

1718A...T

lime triangolari a taglio **mezzodolce**, senza
impugnatura

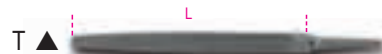

	L mm	L "		
1718A6/T	150	6	5	017180023
1718A8/T	200	8	5	017180033
1718A10/T	250	10	5	017180043

1718D...P

lime piatte a taglio **grossolano**, senza
impugnatura



	L mm	L "		
1718D6/P	150	6	5	017180125
1718D8/P	200	8	5	017180135
1718D10/P	250	10	5	017180145

1718A...P

lime piatte a taglio **mezzodolce**, senza
impugnatura

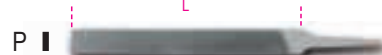

	L mm	L "		
1718A6/P	150	6	5	017180025
1718A8/P	200	8	5	017180035
1718A10/P	250	10	5	017180045

1718D...M

lime mezzotonde a taglio **grossolano**, senza
impugnatura



	L mm	L "		
1718D6/M	150	6	5	017180127
1718D8/M	200	8	5	017180137
1718D10/M	250	10	5	017180147

1718A...M

lime mezzotonde a taglio **mezzodolce**, senza
impugnatura



	L mm	L "		
1718A6/M	150	6	5	017180027
1718A8/M	200	8	5	017180037
1718A10/M	250	10	5	017180047

1718D...R

lime tonde a taglio **grossolano**, senza
impugnatura



	L mm	L "		
1718D6/R	150	6	5	017180129
1718D8/R	200	8	5	017180139
1718D10/R	250	10	5	017180149

1718A...R

lime tonde a taglio **mezzodolce**, senza
impugnatura



	L mm	L "		
1718A6/R	150	6	5	017180029
1718A8/R	200	8	5	017180039
1718A10/R	250	10	5	017180049

1718D...S5

serie di 5 lime a taglio **grossolano**, senza
impugnatura



	L mm	L "		
1718D6/S5	150	6	1	017180130
1718D8/S5	200	8	1	017180140
1718D10/S5	250	10	1	017180150

1718A...S5

serie di 5 lime a taglio **mezzodolce**, senza impugnatura

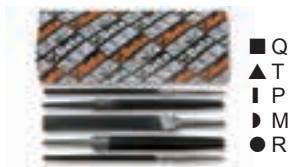

	L mm	L "		
1718A6/S5	150	6	1	017180030
1718A8/S5	200	8	1	017180040
1718A10/S5	250	10	1	017180050

1719BMD...Q

lime quadre a taglio **grossolano**, con impugnatura



	L mm	L "		
1719BMD6/Q	150	6	5	017190191
1719BMD8/Q	200	8	5	017190221
1719BMD10/Q	250	10	5	017190241
1719BMD12/Q	300	12	3	017190325

1719BMA...Q

lime quadre a taglio **mezzodolce**, con impugnatura



	L mm	L "		
1719BMA6/Q	150	6	5	017190021
1719BMA8/Q	200	8	5	017190052
1719BMA10/Q	250	10	5	017190071
1719BMA12/Q	300	12	3	017190311

1719BMX...Q

lime quadre a taglio **dolce**, con impugnatura



	L mm	L "		
1719BMX6/Q	150	6	5	017190022
1719BMX8/Q	200	8	5	017190053
1719BMX10/Q	250	10	5	017190072

1719BMD...T

lime triangolari a taglio **grossolano**, con impugnatura



	L mm	L "		
1719BMD6/T	150	6	5	017190193
1719BMD8/T	200	8	5	017190223
1719BMD10/T	250	10	5	017190243
1719BMD12/T	300	12	3	017190326

1719BMA...T

lime triangolari a taglio **mezzodolce**, con impugnatura



	L mm	L "		
1719BMA6/T	150	6	5	017190023
1719BMA8/T	200	8	5	017190054
1719BMA10/T	250	10	5	017190073
1719BMA12/T	300	12	3	017190313

1719BMX...T

lime triangolari a taglio **dolce**, con impugnatura



	L mm	L "		
1719BMX6/T	150	6	5	017190024
1719BMX8/T	200	8	5	017190055
1719BMX10/T	250	10	5	017190074

1719BMD...P

lime piatte a taglio **grossolano**, con impugnatura



	L mm	L "		
1719BMD6/P	150	6	5	017190195
1719BMD8/P	200	8	5	017190225
1719BMD10/P	250	10	5	017190245
1719BMD12/P	300	12	3	017190327

1719BMA...P

lime piatte a taglio **mezzodolce**, con impugnatura



	L mm	L "		
1719BMA6/P	150	6	5	017190025
1719BMA8/P	200	8	5	017190056
1719BMA10/P	250	10	5	017190075
1719BMA12/P	300	12	3	017190315

1719BMX...P

lime piatte a taglio **dolce**, con impugnatura



	L mm	L "		
1719BMX6/P	150	6	5	017190026
1719BMX8/P	200	8	5	017190057
1719BMX10/P	250	10	5	017190076

1719BMD...M

lime mezzotonde a taglio **grossolano**, con impugnatura

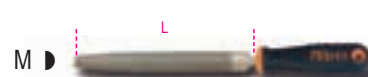

	L mm	L "		
1719BMD6/M	150	6	5	017190197
1719BMD8/M	200	8	5	017190227
1719BMD10/M	250	10	5	017190247
1719BMD12/M	300	12	3	017190328

1719BMA...M

lime mezzotonde a taglio **mezzodolce**, con impugnatura



	L mm	L "		
1719BMA6/M	150	6	5	017190027
1719BMA8/M	200	8	5	017190058
1719BMA10/M	250	10	5	017190077
1719BMA12/M	300	12	3	017190317

1719BMX...M

lime mezzotonde a taglio **dolce**, con impugnatura

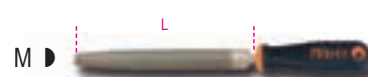

	L mm	L "		
1719BMX6/M	150	6	5	017190028
1719BMX8/M	200	8	5	017190059
1719BMX10/M	250	10	5	017190078

1719BMD...R

lime tonde a taglio **grossolano**, con impugnatura



	L mm	L "		
1719BMD6/R	150	6	5	017190199
1719BMD8/R	200	8	5	017190229
1719BMD10/R	250	10	5	017190249
1719BMD12/R	300	12	3	017190329

1719BMA...R

lime tonde a taglio **mezzodolce**, con impugnatura



	L mm	L "		
1719BMA6/R	150	6	5	017190029
1719BMA8/R	200	8	5	017190060
1719BMA10/R	250	10	5	017190079
1719BMA12/R	300	12	3	017190319

1719BMX...R

lime tonde a taglio **dolce**, con impugnatura



	L mm	L "		
1719BMX6/R	150	6	5	017190031
1719BMX8/R	200	8	5	017190061
1719BMX10/R	250	10	5	017190081

1719BMA...B5

serie di 5 lime a taglio **mezzodolce**, con impugnatura in busta appendibile



	L mm	L "		
1719BMA8/B5	200	8	1	017190297
1719BMA10/B5	250	10	1	017190298

1719BMD...B5

serie di 5 lime a taglio **grossolano**, con impugnatura in busta appendibile



	L mm	L "		
1719BMD8/B5	200	8	1	017190303
1719BMD10/B5	250	10	1	017190305

1719BMD...S5

serie di 5 lime a taglio **grossolano**, con impugnatura

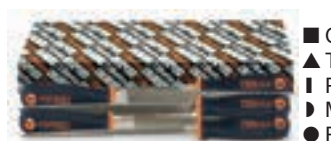

	L mm	L "		
1719BMD6/S5	150	6	1	017190200
1719BMD8/S5	200	8	1	017190230
1719BMD10/S5	250	10	1	017190250
1719BMD12/S5	300	12	1	017190363

1719BMA...S5

serie di 5 lime a taglio **mezzodolce**, con impugnatura

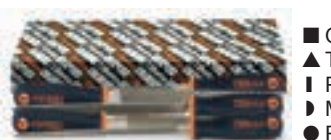

	L mm	L "		
1719BMA6/S5	150	6	1	017190030
1719BMA8/S5	200	8	1	017190070
1719BMA10/S5	250	10	1	017190080
1719BMA12/S5	300	12	1	017190361

1719BMX...S5

serie di 5 lime a taglio **dolce**, con impugnatura

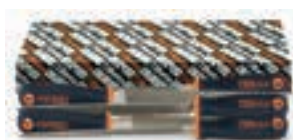

	L mm	L "		
1719BMX6/S5	150	6	1	017190032
1719BMX8/S5	200	8	1	017190069
1719BMX10/S5	250	10	1	017190082

1719BMB/P

lime piatte a taglio universale
impugnatura in materiale plastico

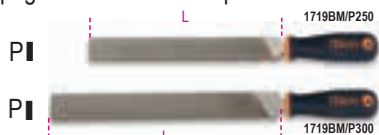

	L mm	L "		
250	10	5	017190152	
300	12	5	017190153	

1719BMC

lime mezzotonde e piatte a mazzo
impugnatura in materiale plastico



UNI 5569 - UNI 5568

	L mm	L "		
1719BMC/M 250	250	10	6	017190252
1719BMC/M 300	300	12	4	017190253
1719BMC/P 250	250	10	6	017190262
1719BMC/P 300	300	12	4	017190263

1719BM/RR

raspa tonda
impugnatura in materiale plastico



	L mm	L "		
1719BM/RR	200	8	5	017190351

1719BM/RL

raspa piatta
impugnatura in materiale plastico



	L mm	L "		
1719BM/RL	200	8	5	017190360

1719BMR

impugnature per lime



	L mm	A mm		
1719BMR/0	95	25	10	017190950
1719BMR/0B	110	29	10	017190955
1719BMR/1	110	29	10	017190951
1719BMR/1B	110	29	10	017190953
1719BMR/2	123	31	10	017190952
1719BMR/2B	123	31	10	017190954

	mm	"		
1719BMR/0	100/150	4/6	▲▲	●●
1719BMR/0B	100/150	4/6	■●	●●
1719BMR/1	150/200	6/8	▲▲	●●
1719BMR/1B	150/200	6/8	■●	●●
1719BMR/2	250/300	10/12	▲▲	●●
1719BMR/2B	250/300	10/12	■●	●●

1720/...

lime ad ago
taglio **mezzodolce**
gambo Ø 3 mm

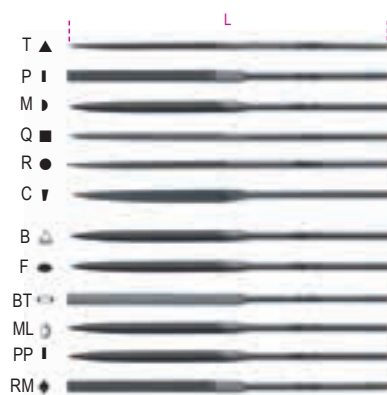

UNI 5569 UNI 5670

	L mm		
1720T	160	5	017200004
1720P	160	5	017200006
1720M	160	5	017200008
1720Q	160	5	017200009
1720R	160	5	017200010
1720C	160	5	017200012
1720B	160	5	017200005
1720ML	160	5	017200007
1720BT	160	5	017200011
1720F	160	5	017200013
1720PP	160	5	017200014
1720RM	160	5	017200015



1720/S3	1	017200000
---------	---	-----------

1720/B



1720/B6	1	017200002
1720/B12	1	017200003

1720D/...

lime ad ago diamantate
grana D126



	L mm		
1720D/T	160	2	017200104
1720D/P	160	2	017200106
1720D/M	160	2	017200108
1720D/Q	160	2	017200109
1720D/R	160	2	017200110
1720D/C	160	2	017200112



1720D/B6	1	017200120
----------	---	-----------

1721/B6

serie di 6 lime per contatti
in busta di plastica



1721/B6	1	017210010
---------	---	-----------

1723

tenditore per molle



	L mm		
1723	210	5	017230001

1725

seghetto



	L mm	L1 mm		
1725	420	300	4	017250001

1725CR

miniseghetto

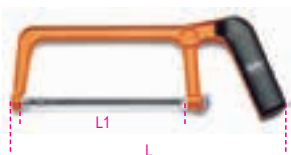

	L mm	L1 mm		
1725CR	250	150	5	017250010

1726

seghetto
con sistema di tensionamento della lama
incorporato nell'impugnatura

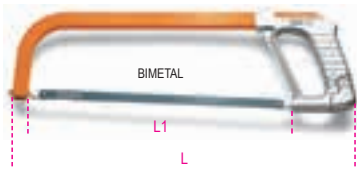

	L mm	L1 mm		
1726	440	300	4	017260001

1726BM

seghetto con sistema di tensionamento
della lama a sgancio rapido

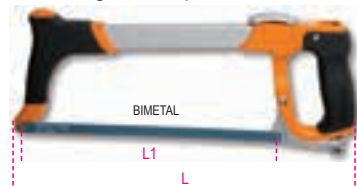

	L mm	L1 mm		
1726BM	400	300	1	017260050

1727

seghetto tipo pesante



	L mm	L1 mm		
1727	515	300	4	017270001

1727BM

seghetto
portalama



	L mm	L1 mm		
1727BM	315	300	5	017270020

1728...

lame per seghetti

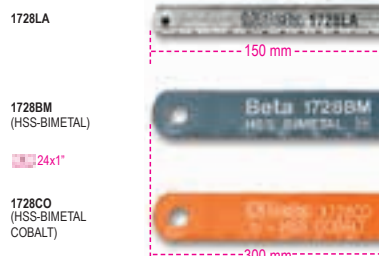

1728LA	100	017280001
1725CR		
1725MQ		
1728BM	100	017280010
1725-1726		
1727-1727M		
1728CO	50	017280030
1725-1726		
1727-1727M		

1729CG

seghetto per cartongesso



	L mm	L1 mm		
1729CG	310	160	2	017290200

1729DM 450

segaccio per legno

dentatura media, 12 denti per pollice



	L mm	L1 mm		
1729DM 450	450	400	4	017290450

1730

spatole universali con lama INOX e
impugnatura



S mm	L mm	L1 mm		
38	210	85	2	017300038
63	220	95	2	017300063
75	220	95	2	017300075
100	220	95	2	017300100

1730M

spatole per miscelatori
con lama INOX e impugnatura

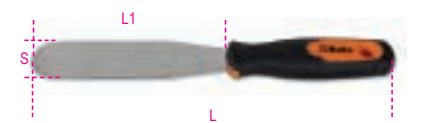

L1 mm	L mm	S mm		
150	245	27	2	017300215
200	330	28	2	017300220
250	365	36	2	017300225

1730V 38

spatola per vetrai
lama a coltello in INOX



S mm	L mm	L1 mm		
38	225	100	2	017300338

1736A

spazzola per lime
filo in acciaio INOX
Ø filo 0,5 mm



1736A L mm 240 10 017360010

1737

spazzolino con fili di ottone ondulato
Ø filo 0,2 mm



1737 L mm 145 10 017370001

1737NX

spazzola curva a fili di acciaio ottonato
Ø filo 0,3 mm



1737NX L mm 270 5 017370010

1737AC

spazzola a fili di acciaio
a 5 ranghi
Ø filo 0,3 mm



1737AC L mm 275 5 017370020

1737B

coppie di spazzole
per pulizia morsetti e
poli batteria veicoli
filo in acciaio
Ø filo 0,3 mm



1737B 1 017370050

1738

pennello



1738 L mm 210 H mm 30 10 017380001

1739B

rivettatrice estensibile
fornita con 5 testine intercambiabili



max 830 mm
Ø mm 3,2 4 4,8 5 6 6,4
Alluminio • • • • •
Inox • • • •

1739B 1 017390151

1740A

rivettatrice di potenza
fornita con 5 testine intercambiabili



525 mm
Ø mm 3,2 4 4,8 5 6 6,4
Alluminio • • • • •
Inox • • • •

1740A 1 017400101

1740B

rivettatrice di potenza compatta
con serbatoio porta-steli
fornita con 5 testine intercambiabili



Ø mm 2,4 3 3,2 4 4,8
Alluminio • • • • •
Acciaio • • • • •
Inox • • • • •

1740B 280 L mm 280 1 017400280

Ø mm 2,4 3,2 4,0 4,8 6,4
Alluminio • • • • •
Acciaio • • • • •
Inox • • • • •

1740B 330 L mm 330 1 017400330

1741B

rivettatrice
fornita con 4 testine intercambiabili



250 mm
Ø mm 2,4 3,2 4 4,8 5
Alluminio • • • • •
Acciaio • • • • •
Inox • • •

1741B 1 017410000



1741B/C5

rivettatrice 1741B con assortimento di 700 rivetti in alluminio



1741B/C5 1 017410025

	Ø mm	L mm	n.
1741RV2,9K	3,0	6	200
1741RV3,2K	3,2	8	200
1741RV3,8K	4,0	10	100
1741RV4K	4,0	12	100
1741RV4,8K	4,8	12	100

415x155x60 mm - 3,1 Kg

1741BP

rivettatrice fornita con 4 testine intercambiabili



Ø mm	2,4	3,2	4	4,8	5
Alluminio	•	•	•	•	•
Acciaio	•	•	•	•	•
Inox	•	•	•	•	•

1741BP 1 017410350

1741U

rivettatrice ultra compatta con regolazione dello sforzo fornita con 4 testine intercambiabili



Ø mm	2,4	3	3,2	4	4,8
Alluminio	•	•	•	•	•
Acciaio	•	•	•	•	•
Inox	•	•	•	•	•

1741U 1 017410450

1741RV...K

rivetti in alluminio

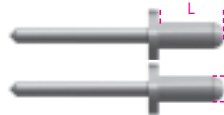

1741RV 2,9K ØxL = 3x6 mm	1 017410191
1741RV 3,2K ØxL = 3,2x8 mm	1 017410192
1741RV 3,8K ØxL = 4x10 mm	1 017410193
1741RV 4K ØxL = 4x12 mm	1 017410194
1741RV 4,8K ØxL = 4,8x12 mm	1 017410195

I prezzi indicati sono relativi a 500 pezzi

1742

rivettatrice per inserti filettati fornita con 4 testine intercambiabili e 4 perni (1x M3;M4;M5;M6)



1742 1 017420001

M	Ø mm	L mm
3	5	11
4	6	11
5	7	13
6	9	17

1742KR

kit di 4 perni di ricambio per 1742



M3	1 017420043
M4	1 017420044
M5	1 017420045
M6	1 017420046

1742R-AL/M...

rivetti in alluminio filettati per 1742-1742A-1946KF



1742R-AL M3 ØxL = 5x10 mm M = 3	1 017420023
1742R-AL M4 ØxL = 6x12 mm M = 4	1 017420024
1742R-AL M5 ØxL = 7x13 mm M = 5	1 017420025
1742R-AL M6 ØxL = 9x15 mm M = 6	1 017420026

I prezzi indicati sono relativi a 20 pezzi

1742R-A/M...

rivetti in acciaio filettati per 1742-1742A-1946KF



1742R-A M3 ØxL = 5x11 mm M = 3	1 017420013
1742R-A M4 ØxL = 6x11 mm M = 4	1 017420014
1742R-A M5 ØxL = 7x13 mm M = 5	1 017420015
1742R-A M6 ØxL = 9x17 mm M = 6	1 017420016
• 1742R-A M8 ØxL = 11x17 mm M = 8	1 017420018
• 1742R-A M10 ØxL = 13x24 mm M = 10	1 017420020

I prezzi indicati sono relativi a 20 pezzi
• I prezzi indicati sono relativi a 10 pezzi

1742/C4

rivettatrice 1742 con assortimento di 400 inserti filettati in acciaio



1742/C4 1 017420005

	M	Ø mm	n.
1742R-A/M3	3	5	100
1742R-A/M4	4	6	100
1742R-A/M5	5	7	100
1742R-A/M6	6	9	100

415x155x60 mm - 2,9 kg

1742A

rivettatrice di potenza per inserti filettati fornita con 4 testine intercambiabili



1742A 1 017420100

M	Ø mm	L mm
5	7	13
6	9	17
8	11	17
10	13	24

1742A/KR

kit di 4 perni di ricambio per 1742A



1742A/KR M5	M5	1	017420143
1742A/KR M6	M6	1	017420144
1742A/KR M8	M8	1	017420145
1742A/KR M10	M10	1	017420146

1742A/C

rivettatrice 1742A con assortimento di 60 inserti filettati in acciaio



1742A/C	1	017420105
---------	---	-----------

	M	Ø mm	n.
1742R-A/M5	5	7	20
1742R-A/M6	6	9	20
1742R-A/M8	8	11	10
1742R-A/M10	10	13	10

536x310x80 mm - 2,1 kg

1749

pistola per sigillante



L min mm	1749	340	2	017490001
-------------	------	-----	---	-----------

1749A

pistola per sigillante
modello professionale
tubo in alluminio.

Capacità cartucce 310ml
Capacità sacchetti 310ml

Non idonea per utilizzo con sigillante sfuso.



L min mm	1749A	360	1	017490010
-------------	-------	-----	---	-----------

1749A/RB

beccucci di ricambio per 1749A

1749A/RB	1	017490051
----------	---	-----------

1749A/RT

tappi frontali avvitabili per 1749A

1749A/RT	1	017490052
----------	---	-----------

1749AC

pistola ad alta spinta per ancoranti chimici e cartucce standard



L min mm	1749AC	360	1	017490005
-------------	--------	-----	---	-----------

1750

compressori a leva per grasso

utilizzabile con cartucce 1750CG oppure con grasso sfuso



1 g, 550 bar Max

1750CG cc	L mm	1750	1	017500500
400	500	380	1	017500500
600	750	450	1	017500750

1750R/1 - 1750R/2

tubi flessibili di ricambio
in Nylon



L mm	1750R/1	310	2	017500030
L mm	1750R/2	410	2	017500040

1750RC

tubo rigido piegato



L mm	M mm	1750RC	150	10x1	2	017500050
---------	---------	--------	-----	------	---	-----------

1750RT

testina a 4 griffe
tipo "Hydraulic"



M mm	1750RT	10x1	5	017500110
---------	--------	------	---	-----------

1750RP/1 - 1750RP/2

testine per raccordi piatti

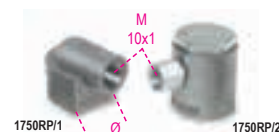

Ø mm	M mm	1750RP/1	16	10x1	2	017500115
Ø mm	M mm	1750RP/2	22	10x1	2	017500120

1750CG

cartucce di grasso universale per 1750

• Temperatura di impiego da -20°C a +130°C



cc	1750CG	400	18	017500140
cc	1750CG	600	18	017500160

1750KG10

ingrassatore a leva da 10 kg,
con tubo ad alta pressione da 2 m

dotato di raccordo girevole per non strozzare il tubo.
corpo pompante in alluminio pressofuso con valvola di sfiato

3 differenti livelli di pressione impostabili:

- 4 gr a 275 bar
- 7 gr a 206 bar
- 9 gr a 137 bar



1750KG10 1 017500100

1750TA

testina per ingrassaggio autobloccante a 6
spilli

- una volta posizionata rimane in asse e collegata al nipplo
- agevole disconnessione anche con testina in pressione.
- filetto M10x1: adatto a tutti i tipi di ingrassatore: elettrico, pneumatico, manuale, ecc.
- nessuna deformazione fino a 550 bar



1750TA 1 017500111

1750TLA

testina per ingrassaggio autobloccante a 6
spilli, versione lunga

- una volta posizionata rimane in asse e collegata al nipplo
- agevole disconnessione anche con testina in pressione.
- filetto M10x1: adatto a tutti i tipi di ingrassatore: elettrico, pneumatico, manuale, ecc.
- nessuna deformazione fino a 550 bar



1750TLA 1 017500112

1750M

mini ingrassatore

- Con microugello
- Particolarmente indicato per utensili pneumatici



	cc	D mm	L mm		
1750M	100	43	145	1	017500025

1750M3

mini ingrassatore a 3 ugelli

- Dotato di tre ugelli intercambiabili: 0.7 - 1.0 - 1.4 mm
- Particolarmente indicato per la lubrificazione di utensili pneumatici
- Utilizzabile con grasso sfuso
- Adatta per l'utilizzo di grasso di grado fino a NLGI 2



	cc	Ø mm	L mm		
1750M3	85	42	160	1	017500003

1751N

oliatori metallici a pressione
cannuccia flessibile



cc	D mm	L mm		
200	62	140	4	017510020
300	75	140	4	017510030
500	85	140	4	017510050
750	100	140	2	017510075
1000	100	140	2	017510100

1751NR

cannuccia di ricambio
per 1751N



200÷1000 5 017510110

1752

oliatori in plastica a pressione
cannuccia rigida



cc	D mm	L mm		
200	67	140	4	017520002
300	77	140	4	017520003
500	95	140	4	017520005
700	95	140	2	017520007

1752R

cannuccia di ricambio
per 1752



200÷700 5 017520020

1753

oliatori in plastica a pressione
cannuccia flessibile



cc	D mm	L mm		
200	65	190	4	017530002
300	80	190	4	017530003
500	95	190	4	017530005
700	95	190	2	017530007

1753R

cannuccia di ricambio
per 1753



200÷700 5 017530020

1754

oliatori in plastica a pressione
cannuccia flessibile



cc	D mm	L mm		
150	60	130	5	017540015
250	65	130	5	017540025

1755

oliatori in plastica
cannuccia rientrante



cc	L mm	A mm		
30	160	30	5	017550003
80	170	47	5	017550008
150	230	58	5	017550015

1756

oliatore a stilo

ideale per l'utilizzo con oli minerali



cc	L mm		
5	140	2	017560001

1756B

siringa per olio

- con zigrinatura antiscivolo
- Temperatura di funzionamento: -10°C - +60°C
- Densità minima olio SAE 10



cc	L mm		
500	280	2	017560220

1756C

siringa per olio da 200 ml
in polipropilene

- Adatta anche al liquido impianto freni
- Doppia guarnizione in EPDM
- Temperatura di funzionamento: +0 - +50°C
- Non adatta per carburanti e oli minerali
- Densità minima utilizzabile di olio è ISO 150, SAE 90 (olio cambio), SAE 40 (olio motore)



1756C	1	017560502
-------	---	-----------

1756D

siringa per olio da 1500 ml
in polipropilene

- Doppia guarnizione in NBR
- Temperatura di funzionamento: +0 - +50°C
- Non adatta per carburanti

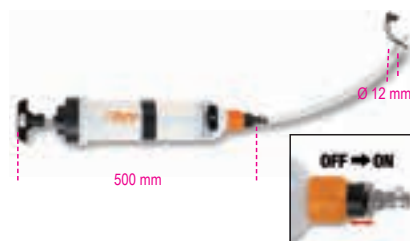

1756D	1	017560515
-------	---	-----------

1756G

siringa per gasolio
capacità 1,5 l

- Utilizzabile per:
- riempimento filtri gasolio
 - riempimento serbatoio cerina



Compresi nel kit:

- 2 tubi con attacchi rapidi femmina per collegamento tubi gasolio
- 2 attacchi rapidi maschio in metallo
- 1 adattatore conico per tubi gomma

1756G	1	017560615
-------	---	-----------

1756C-2OR

coppia di O-ring per siringhe 1756C

1756C-2OR	1	017560503
-----------	---	-----------

1756D-2OR

coppia di O-ring per siringhe 1756D

1756D-2OR	1	017560516
-----------	---	-----------

1757

rabbocicatori per liquidi batterie



cc	D mm		
250	60	4	017570002
500	75	4	017570004
1000	90	2	017570006

1757A

colmatore per liquidi batterie



1757A	1	017570020
-------	---	-----------

1758

imbuto autoadattante

particolarmente utile per auto
prive di profondità all'interno
del tappo di carico



1758	1	017580020
------	---	-----------

1758ADB-D

imbuto antiriflusso per AdBlue®
con attacco dritto



1758 ADB-D	1	017580050
------------	---	-----------

1758ADB-45°

imbuto antiriflusso per AdBlue®
con attacco a 45°



1758 ADB-45°
Max 1
1 017580060

1758A

imbuto antiriflusso
con attacco rapido Ø 38 mm
Particolarmente indicato per vetture
del gruppo Volkswagen



1758A
1 017580010

1758B

imbuto antiriflusso
con attacchi rapidi
Particolarmente indicato
per vetture gruppo VAG



1758B
1 017580030

1758B-1,6

imbuto antiriflusso da 1600 ml
con attacchi rapidi
attacchi rapidi
per vetture gruppo VAG



H1 H2 Ø
mm mm mm
1758B-1,6 125 100 155
1 017580033

1758B-RNT

attacco rapido antiriflusso
per imbuto 1758B e 1758B-1,6

per motore Renault 1.5 dCi



1758B-RNT
1 017580035

1758B/K5

kit di adattatori rapidi antiriflusso
per imbuto 1758B e 1758B-1,6

Inclusi nel kit:
• 1 adattatore per motore 1.5 dCi Renault, Dacia, Nissan
• 1 adattatore per motori 1.5/1.6 dCi Renault, Dacia, Nissan
• 1 adattatore per motore 3.0 BMW diesel
• 1 adattatore per motori 1.5/2.0 benzina gruppo VAG
• 1 adattatore di collegamento con l'imbuto con rubinetto



1758B/K5
1 017580040

1758LG

lamina modellabile in alluminio rivestita in
gomma, per la canalizzazione dei liquidi



L H
mm mm
365 168
1 017580006

1758M

imbuto



L
mm
1758M 350
1 017580000

1758R

recipienti per liquidi

pratico beccuccio flessibile removibile



litri
1758R 1 1 1 017580201
1758R 2 2 1 017580202
1758R 3 3 1 017580203
1758R 5 5 1 017580205

1758VT

kit per la verifica delle testate

segnala rapidamente se nella vaschetta d'espansione è
presente anidride carbonica.



1758VT
1 017580100

290x190x50 mm - 1kg

1758VT/L

liquido di contrasto per verifica testate



1758VT/L

1 017580101

1759

analizzatore ottico per liquidi di raffreddamento, batteria, lavavetri e AdBlue® in astuccio rigido

Compensazione automatica della temperatura

Acido batteria: intervallo di misura

da 1,1 a 1,3 kg/l

Liquido di raffreddamento propilene:

da -25°C a -50°C

Liquido di raffreddamento etilene: da -25°C a -50°C

Liquido lavavetri: da -10°C a -40°C

AdBlue(R): Misurazione percentuale di urea da 30% a 35%



1759

1 017590251

1759A

densimetro per liquido anticongelante



1759A

L
mm
340

1 017590001

1759B

densimetro per liquidi batteria



1759B

L
mm
280

1 017590005

1759HD/3

strumenti per controllo tenuta impianto di raffreddamento e riempimento circuito

Permette di verificare sotto pressione le perdite del circuito (tubi, giunti, pompe, radiatori) e riempire velocemente il circuito evitando la formazione di bolle d'aria



1759HD/3

1 017590063

600x500x140 mm - 6,5 kg

1759HD/RR

strumento per riempimento impianto di raffreddamento



1759HD/RR

1 017590064

450x310x110 mm - 2,2 kg

1759LR

attrezzo per lavaggio impianti di raffreddamento

grazie all'aria compressa, l'elevata pressione dell'acqua permette un lavaggio efficace dell'impianto di raffreddamento

- inclusi 6 adattatori per connessione con impianto
- leva di azionamento con blocco della posizione per un utilizzo continuo
- attacco rapido acqua incluso



1759LR

L
mm
402

1 017590070

390x330x100

1759HD/TRUCK

strumento per controllo e tenuta impianto di raffreddamento Truck



1759HD/TRUCK

1 017590065

440x330x100 mm - 3 kg

1759TT

kit 4 coppie tappi verifica circuito turbo utilizzabile con pistole gonfiagomme



1759TT

1 017590300

400x160x100 mm - 1,8 kg

SERVIZIO DI CERTIFICAZIONE STRUMENTI ELETTRONICI

La certificazione di strumenti elettronici di misura quali Multimetri, Pinze Amperometriche, **Tachimetri e Termometri** è indispensabile in quei settori o ambiti di applicazione in cui è necessario conoscere e controllare l'esattezza della misura in modo inequivocabile e riconoscibile.

Per i termometri infrarossi viene rilasciato un rapporto di taratura su 4 punti (minimo, massimo e due punti intermedi) con riferibilità ENAC.

Beta Utensili S.p.A. fornisce su richiesta il servizio di certificazione. Per usufruire di questo servizio rivolgeti al tuo rivenditore di fiducia.

1760DGT

multimetro digitale automotive



Dati Tecnici:

- RPM (tachimetro):
Per motori a 2 e 4 cilindri
RPM4 600 - 4000 RPM
RPM4 600 - 12000 RPM (x10 RPM)
RPM2/DIS 300 - 4000 RPM
RPM2/DIS 300 - 6000 RPM (x10 RPM)
- Angolo Dwell: 4-8 CYL
- Tensione DC: 400mV-4/40/400/1000V
- Tensione AC: 4/40/400/700V
- Corrente DC: 40/400mA-4/20A
- Corrente AC: 40/400mA-4/20A
- Resistenza: 400Ω-4/40/400Ω-4/40MΩ
- Capacità: 40/400nF-4/40/100μF
- Frequenza: 5/50/500Hz-50/500-10MHz
- Duty Cycle: 0.1 - 99,9%
- Ampiezza pulsazioni: 1 - 10ms
- Prova diodi: Corrente test 0,3mA
- Continuità: <150Ω - Corrente test <0,3mA
- Display: LCD ad alto contrasto 4 digit retro-illuminato
- Sovratensione: Categoria II 1000V
- Autospegnimento: 30 minuti
- Alimentazione: 1 batteria 9V (inclusa)
- Pinza induttiva (inclusa)
- 2 Puntali (inclusi)
- Custodia morbida in tela (inclusa)
- Manuale d'uso

1760DGT

1 017600005

1760DGT/2

multimetro digitale automotive portatile con oscilloscopio a 2 canali e generatore d'onda



Il kit include:

- Puntali multimetro
- 2 connettori coassiale BNC per oscilloscopio
- Sonda a puntale per oscilloscopio (1X e 10X)
- Caricabatteria
- Custodia in nylon

Dati tecnici:

- Display: TFT a colori da 2,8"
- Risoluzione: 320 x 240 pixels
- Alimentazione: 100V-240V AC, 50Hz-60Hz; DC INPUT 5V DC-2A
- Batteria: 2 x 2600 mAh
- Peso: 624 g
- Dimensioni: 199 x 98 x 40 mm

Specifiche multimetro:

- Test: Tensione, Corrente, Resistenza, Capacità, Diodi e On-Off
- Tensione Max: 600V AC-DC
- Corrente Max: 10A AC-DC
- Resistenza Max: 40MOHM
- Capacità Max: 100μF

Specifiche oscilloscopio:

Orizzontale

- Larghezza banda: 40MHz
- Intervallo di frequenza campionamento: 250MSa/s (singolo canale) - 125MSa/s (doppio canale)
- Gamma SEC/DIV: 5ns/div ÷ 500s/div 1,2,5 sequence

Verticale

- Gamma VOLTS/DIV: 10mV/div÷10V/divat ingresso BNC
- Analogico selezionabile limite larghezza di banda, tipico: 20MHz
- Risposta a bassa frequenza (-3db): ≤10Hz a BNC
- DC Gain Accuracy: ± 3% per la modalità di acquisizione Normale o Media, da 10V/div a 10 mV/div

Trigger

- Type: Edge
- Mode: Auto, Normal, Single
- Slope: Rising, Falling, Rising, & Falling
- Source: CH1, CH2

Ingresso

- Accoppiamento: DC, AC o GND
- Fattori di attenuazione della sonda supportati: 1X, 10X, 100X, 1000X

Generatore di forma d'onda arbitrarie

- Frequenza forma d'onda: Sine (1Hz÷25MHz), Square (1Hz÷10MHz), Ramp (1Hz÷1MHz), EXP (1Hz÷5MHz)
- Ampiezza: 2.5Vpp (50Ω) - 5Vpp (alta impedenza)
- Impedenza di uscita: 50Ω

1760DGT/2

1 017600008



1760B

multimetro digitale



CE



Parametri rilevabili:

Tensione DC: 200 mV-2/20/200/1000V
 Tensione AC: 2-20/200/700V
 Corrente DC: 2/20/200 mA-20 A
 Corrente AC: 2/200 mA-20 A
 Resistenza: 200Ω - 2/20/200 kΩ - 2/20 MΩ
 Capacità: 2/20/200 nF - 2/200 μF
 Temperatura: -20° + 1000°C/ -4 °F ~ +2000°F
 Frequenza: 20kHz
 Alimentazione: 1 batteria da 9V (inclusa)

1760B

1 017600012

1760/OHM

multimetro/megaohmetro per test isolamento ad alta tensione.

con lettura a valore efficace TRUE RMS



CE

CAT. IV
 600V
 CAT. III
 1000V

	Campo di misura	Precisione base
Tensione AC/DC:	50mV - 1000V	±0.06% - ±0.1% rdg
Corrente AC/DC:	0.01μA - 10A	±0.5% - ±1% rdg
Resistenza :	0.01Ω - 50MΩ	±0.2% - ±2% rdg
Meg OHM:	0.01 - 5000MΩ	±4% rdg. max current 1mA
Capacità:	5nF - 10mF	±1.5% - ±3% rdg
Frequenza:	50Hz - 100 MHz	±0.02% - ±0.1% rdg
Temperatura:	-50°C - +1350°C	±0.5% rdg
Test diodi:	3V dc	
Test continuità:	<30 Ω	

1760/OHM

1 017600025

1760/RMS

multimetro industriale IP67

con lettura a valore efficace TRUE RMS

EN61010-1
EN61326-1



CE

Dettagli tecnici:

Campo di misura Precisione base
 Tensione AC/DC 110mV - 600V ±0.8% - ±2% rdg
 Corrente AC/DC 110μA - 10A ±1.5% - ±2% rdg
 Resistenza 110Ω - 40MΩ ±1.2% - ±2.5% rdg
 Capacità 11nF - 40mF ±5% - ±10% rdg (fino a 11mF)
 Frequenza 1100Hz - 110 MHz ±1.2% - ±1.5% rdg
 Temperatura -32°C - +1000°C ±3% - ±5% rdg
 Test diodi 3V dc ±10% rdg
 Test continuità <30 Ω

1760/RMS

1 017600020

1760S

multimetro digitale compatto

con lettura a valore efficace TRUE RMS



CE

Parametri rilevabili:

Tensione DC: 200 mV-2/20/200/600V
 Tensione AC: 100/600V
 Corrente DC: 200 mA-10 A
 Corrente AC: 0,01-10 A
 Resistenza: 200Ω - 2/20/200 kΩ - 2 MΩ
 Test diodi: da 0.4 a 0.7 V dc
 Alimentazione: 2 batterie 1,5V tipo AAA

1760S

1 017600022

153x75x42 mm

1760PA/80

pinza amperometrica AC/DC 80A

per misurazione di bassi valori di dispersione della corrente o assorbimenti sui veicoli



CE

Caratteristiche:

- Range: 1mA-80A AC/DC
- Funzione torcia con LED bianco
- Display LCD retroilluminato
- Funzione azzeramento
- Funzione Hold
- Autospegnimento
- Alimentazione: 2 batterie 1,5V tipo AAA

1760PA/80

1 017600002

1760PA/AC

pinza amperometrica e multimetro digitale

A: AC
V: AC/DC

CE



Parametri rilevabili:

Tensione DC: 400 mV - 4/40/400/600 V
 Tensione AC: 400 mV - 4/40/400/600 V
 Corrente AC: 40/400/1000 A
 Resistenza: 400Ω - 4/40/400 kΩ - 4/40 MΩ
 Frequenza: 5/50/500 Hz - 5/50/500 kHz - 5/10 MHz
 Capacità: 40/400 nF - 4/40/100 μF
 Temperatura: -20°C + 1000°C / -4 °F + 1832 °F
 Alimentazione: 1 batteria da 9V (inclusa)

1760PA/AC

L
mm
190

1 017600050

1760PA/AC-DC

pinza amperometrica e multimetro digitale

A: AC/DC
V: AC/DC



CE



Parametri rilevabili:

- Tensione DC: 0.1mV ÷ 600V
- Tensione AC: 0.1mV ÷ 600V
- Corrente AC: 0.01A ÷ 1000A
- Corrente DC: 0.01A ÷ 1000A
- Resistenza: 0.1Ω ÷ 40MΩ
- Capacità: 0.001nF ÷ 40 μF
- Frequenza: 0.001kHz ÷ 4kHz
- Temperatura: -40°C ÷ 1000 °C -40°F ÷ 1832°F
- Alimentazione: 1 batteria da 9V (inclusa)

1760PA/AC-DC

1 017600000

1760PA/AC-DC2000

pinza amperometrica con multimetro digitale e connessione dati

funzione TRUE RMS nelle misure in AC

A: AC/DC
V: AC/DC



CE



Parametri rilevabili:

- Tensione DC: 0.1mV ÷ 1000V
- Tensione AC: 0.1mV ÷ 1000V
- Corrente AC: 0.01A ÷ 2000A
- Corrente DC: 0.01A ÷ 2000A
- Resistenza: 0.1Ω ÷ 60MΩ
- Capacità: 1nF ÷ 6000 μF
- Frequenza: 10kHz ÷ 20kHz
- Temperatura: -20°C ÷ 1000 °C -4°F ÷ 1832°F
- Alimentazione: 3 batterie da 1,5V tipo AA (incluse)
- Connessione tramite app per scaricare i dati

H mm 300
L mm 110
P mm 43

1 017600003

380x280x100 mm - 1,78 kg

1760DGT-R3

puntali di ricambio per multimetri digitali e pinze amperometriche



1760DGT-R3

1 017600603

1760/RSE

rilevatore di segnale

Permette di testare l'alimentazione di componenti come: elettroiniettori Common Rail, elettroiniettori benzina/GPL, iniettori piezoelettrici, elettrovalvole regolatrici flusso/elettrovalvole EGR, bobine e altri



CE

Per effettuare la diagnosi dei singoli componenti dell'impianto elettrico è sufficiente avvicinare la sonda al componente in esame.

In impianti con componenti elettromeccanici/elettronici comandati da una centralina, lo strumento permette di verificare se:

- La centralina di gestione è alimentata e assolve il suo compito di comando
- Il cablaggio della centralina al componente è efficiente
- Il componente in esame non è interrotto
- Il componente non è in cortocircuito
- Il componente è elettronicamente funzionante

1760/RSE

1 017600170



Beta

1760/TC2

tachimetro digitale a distanza e a contatto



CE

Dati tecnici:

- Per misurazione di:
 - Rotazione a distanza (g/min - rpm)
 - Rotazione (g/min - rpm) e velocità lineare (m/min o ft/min) a contatto
- Display LCD a 5 cifre
- Scala:
 - A distanza 2,5÷99.999 g/min
 - A contatto 0,5÷19.999 g/min
 - Velocità lineare 0,05÷1.999,9 m/min.
- Frequenza: 0,8 sec
- Alimentazione: 4 batterie 1,5V (AA) (incluse) o alimentatore 6V (non incluso)
- Fornito con:
 - Adattatore per misurazioni a contatto
 - 2 puntali maschio in gomma
 - 1 puntale femmina in gomma
 - 1 rotella per rilevazioni lineari
 - Etichette riflettenti
 - Manuale di istruzioni
 - Custodia in plastica

L mm 230
H mm 74

1760/TC2

1 017600161

1760R/TC2

etichette riflettenti per 1760/TC2



1760R/TC2

1 017600561

1760K

rilevatore di tensione AC senza contatto con mini torcia LED

campo: 200-1000Vac 50/60Hz
CAT III-1000V
funzionamento con 2 pile AAA (incluse)



CE
CAT III-1000V

1760K

1 017600140

1760PT

tester combinato di tensione e continuità
12-690V AC/DC

funzioni:

- continuità
- rotazione fasi
- cercafase
- torcia LED

CE



IP64
CATIV
- 600V ;
CATIII -
1000V

L=1 m

12÷690V AC/DC

1760PT

1 017600150

1760/IR500

termometro digitale ad infrarossi con doppio
puntamento laser

non idoneo alla misurazione della temperatura corporea

CE



Dati tecnici:

- Range temperatura: -50 ÷ 500 °C (-22 a 932 °F)
- Risoluzione display: 0,1 °C (0,1 °F)
- Emissività: regolabile 0,1 ÷ 1
- Precisione: -50 a 20°C (+/- 3°C); 20 ÷ 500°C (+/-2% o 2°C)
- Risoluzione ottica (D:S): 12:1
- Auto Spegnimento: circa 10 secondi
- Temperatura di funzionamento: 0 ÷ 50°C
- Temperatura di stoccaggio: -20 ÷ 60°C
- Alimentazione: 1 batteria 9 V

1760/IR500

1 017600350

1760/IR1000

termometro digitale ad infrarossi con doppio
puntamento laser

non idoneo alla misurazione della temperatura corporea

CE



DATI TECNICI

Range temperatura: -50 ÷ 1000 °C (-58 ÷ 1832 °F)
 Risoluzione display: 0,1°C (0,1°F)
 Emissività: regolabile 0,1 ÷ 1
 Precisione: -50 ÷ 20°C (+/- 3,5°C); 20 ÷ 300°C (+/-1% o 1°C);
 300 ÷ 1000°C (+/-1,5%)
 Risoluzione ottica (D:S): 20:1
 Temperatura di funzionamento: 0 ÷ 50°C
 Temperatura di stoccaggio: -10 ÷ 60°C
 Alimentazione: 2 batterie 1,5 V (tipo AAA)

1760/IR1000

1 017600400

1760/IR1600

termometro digitale ad infrarossi
con doppio puntamento laser

non idoneo alla misurazione della temperatura corporea

CE



DATI TECNICI

Gamma: da -50°C a 1600°C / da -58°F a 2912°F
 Selezione scala: °C/°F
 Precisione: ±1,5% o ±2°C a 20°C
 Potenza Laser: <1mW
 Risposta: 150ms
 Emissività: 0,10-1,0 regolabile
 Rapporto distanza: (D:S) 50:1
 Temperatura operativa: 0°C ÷ 50°C / 32°F ÷ 122°F
 Umidità operativa: da 0% a 100% RH
 Display LCD retro-illuminato
 Funzione di mantenimento dei dati
 Auto spegnimento
 Presa tipo K
 Presa mini USB

Cavo USB per scarico dei dati
 CD per installazione software datalogger
 Alimentazione: 1 batteria 9V (inclusa)

Custodia rigida e treppiede in alluminio
 Manuale d'uso

1760/IR1600 200 mm 115 mm

1 017600461

1760LX

luxmetro digitale portatile

EN61010-1
EN61326-1

CE



Dettagli tecnici:

Campo di misura Precisione base
 Luminosità Lux 0-200000 ±3%
 Luminosità FC 0-20000 ±3%
 Alimentazione: 1 x 9V

1760LX 165 mm

1 017600820

1760TMC

termocamera ad infrarossi

Termocamera compatta per la misurazione
 della temperatura senza contatto, adatta
 per applicazioni nei settori edile, meccanica,
 impianti elettrici e di riscaldamento

- Temperatura da -20 ÷ +600°C.
- Display LCD TFT da 2 pollici 240x320.
- Sensore da 32x32 pixel.
- Frequenza di acquisizione 7Hz.
- Termosensibilità <254mK.
- Acquisizione automatica dei punti caldi e freddi.
- Fotocamera di acquisizione immagini in formato BMP (massimo 100 immagini).
- Emissività regolabile.
- Alimentazione 3 batterie alcaline AAA.
- Interfaccia USB.
- IP54
- Banda infrarossi 6.5÷14µm.
- Distanza di fusione visibile/infrarosso 0.5; 1; 2 m.
- Funzione allarme, selezionando la temperatura massima e minima accettabili.

CE



1760TMC 600

1 017600710

Beta

1760WM

anemometro digitale con sensore a ventola

EN61010-1
EN61326-1



Dettagli tecnici:

Campo di misura Precisione base
Velocità m/s 0,4-30 ±2%
Velocità k/n 1,4-108 ±2%
Velocità ft/m 80-5900 ±2%
Velocità mil/h 0,8-58 ±2%
Flusso CFM 0-99990 ±0-9,999 ft2
Flusso CMM 0-99990 ±0-9,999 m2
Flusso CMS 0-99990 ±0-9,999 m2

L
mm
170
1 017600800

1761

pinza torcifilo
a ritorno automatico



L
mm
255
1 017610101

1761RS/1

pinza torcifilo reversibile
a ritorno automatico



L
mm
220
1 017610130

1762

pinza fustellatrice



Ø
mm
2,2-5-3
3,5-4-4,5
L
mm
210
2 017620001

1763

pinza per graffette tappezzerie auto



1763
1 017630001

1763G/S500

500 graffette per tappezzerie auto



1763G/S500
1 017630105

1764/K5

rivettatrice manuale per rivetti in plastica

fornita con 4 misure di rivetti

inclusi nel kit:

- 10 rivetti Ø 5x17,2 mm
- 10 rivetti Ø 5x15,8 mm
- 10 rivetti Ø 6,3x25,2 mm
- 10 rivetti Ø 6,6x17,2 mm



1764/K5
1 017640001

1765/C24

cassetta di 24 attrezzi
per estrazione autoradio



1765/C24
1 017650001

1766

ventosa doppia

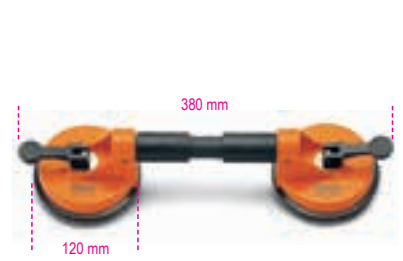

max
kg
50
2 017660001

1766A

ventosa singola



max
kg
30
2 017660005

1766/8

assortimento di 8 utensili
per cristalli auto



1766/8
1 017660100

1766ER

estrattore per raschiavetri con impugnatura

permette di rimuovere agevolmente i raschiavetri senza rischi di danneggiamenti



1766ER

1 017660501

1766ER/VW

estrattore a basso profilo per raschiavetri particolarmente indicato per raschiavetri gruppo VAG con limitato spazio di presa



L mm
215

H mm
4

1 017660510

1766L

leva per cristalli



1766L

1 017660015

1766LI

leva per inserimento cavo tagliacristalli

bordi affilati per taglio sigillante



1766LI

1 017660016

1766I

impugnatura per cavo d'acciaio 1766G e V

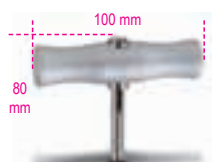

1766I

2 017660020

1766G

cavo d'acciaio per cristalli

sezione quadrata



0,7 mm

50 m

1 017660025

1766T

cavo d'acciaio per cristalli

sezione triangolare



0.7 mm

50 m

1 017660026

1767A

asta telescopica

- ideata per sostenere cofani e portelloni con pistoni scarichi
- utilizzabile per mantenere i pedali bloccati



L mm
640 ÷ 1090

1 017670000

1767B

kit blocca pedali e volante

grazie alla regolazione a pistola è possibile effettuare delle precise impostazioni quando si tiene il veicolo accelerato



1767B

1 017670100

490x285x95 mm - 2,4 kg

1767PMC

portaminuterie magnetico tondo



1767PMC

1 017670020

1767PMR

portaminuterie magnetico rettangolare



1767PMR

1 017670010

1768

pedana in alluminio

superficie rivestita in materiale antiscivolo portata massima 200 kg



L mm
960

L1 mm
300

H mm
475

1 017680010

1770

cutter extra piatto fornito con 2 lame



1770

L mm
140

A mm
9

10 017700001

1770A

cutter 9mm con blocco automatico della lama,
fornito con 3 lame

- cursore di sicurezza antiritorno



1770A	L mm	A mm	10	017700025
	135	9		

1770RL

10 lame a settori 9 mm
per cutter 1770, 1770A e 1770BM



1770RL	5	017700010
--------	---	-----------

1770BM

cutter 9 mm,
fornito con 6 lame

caricamento automatico della lama



1770BM	L mm	A mm	10	017700050
	140	9		

1771

cutter 18 mm
fornito con 3 lame



1771	10	017710000
------	----	-----------

1771BM

cutter 18 mm
fornito con 6 lame

caricamento automatico della lama



1771BM	L mm	A mm	10	017710050
	170	18		

1771HD

cutter 18 mm
fornito con 6 lame

- caricamento automatico della lama
- sistema bloccalama a vite



1771HD	L mm	A mm	5	017710100
	190	18		

1771RL

10 lame a settori 18 mm
per cutter 1771, 1771BM e 1771HD



1771RL	5	017710010
--------	---	-----------

1772M

cutter a lama retrattile di sicurezza
fornito con 4 lame

- lama con rientro automatico a molla
- corpo in lega pressofusa
- levapunti integrato nel manico



1772M	L mm	A mm	5	017720040
	170	18		

1772R

cutter a lama trapezoidale retrattile,
fornito con 5 lame
caricamento automatico della lama



1772R	L mm	A mm	5	017720006
	125	18		

1772H

cutter a lama retrattile di sicurezza,
fornito con 2 lame



1772H	L mm	A mm	5	017720029
	170	18		

1772RL/2

10 lame trapezoidali lunghe, in astuccio,
per cutter 1772H, 1772M, 1772R,
1774, 1777BMT, 1777T



1772RL/2	5	017720017
----------	---	-----------

1773A

cutter 25 mm

- sistema bloccalama a ghiera
- lama da 25 mm



1773A	L mm	A mm	10	017730000
	180	25		

1773RL

10 lame a settori 25 mm
per cutter 1773A



1773RL	5	017730015
--------	---	-----------

1774

raschietto multiuso
con salvalama di protezione



1774	L mm	L1 mm	5	017740001
	155	60		

1774A

raschietto multiuso
con impugnatura bimatereale



1774A	L mm	A mm	1	017740011
	300	40		

1774A/RL

10 lame per raschietto 1774A e 1774S

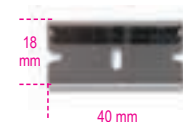

1774A/RL	1	017740511
----------	---	-----------

1774S

raschietti per rimozione adesivi



1774S	A mm	L mm	2	017740021
	40	100		

1777BM

coltello a serramanico con gola spellafili
lama in acciaio inossidabile



	L	L1	A		
	mm	mm	mm		
1777BM	190	80	16	5	017770100

1777T

cutter a serramanico con lama trapezoidale
impugnatura in alluminio, fornito con 5 lame



	L	A	L1		
	mm	mm	mm		
1777T	160	19	65	5	017770030

1777BMT

cutter a serramanico con lama trapezoidale
4 profondità regolabili della lama
4; 9.5; 15.5; 21.5 mm
fornito con 3 lame



	L	L1	A		
	mm	mm	mm		
1777BMT	170	80	19	5	017770050

1778AN

coltello a serramanico
lama in acciaio inossidabile
impugnatura leggera in alluminio anodizzato
• in astuccio



	L	A	L1		
	mm	mm	mm		
1778AN	204	26	84	5	017780065

1778AX

coltello a serramanico
lama in acciaio inossidabile seghettata,
impugnatura in alluminio,
con dentello apertura agevolata,
• in astuccio



	L	A	L1		
	mm	mm	mm		
1778AX	189	26	80	5	017780026

1778CM

coltello a serramanico mimetico
lama in acciaio temprato
• in astuccio



	L	A	L1		
	mm	mm	mm		
1778CM	195	24	80	5	017780099

1778M7

coltello a serramanico mini
lama in acciaio inossidabile
impugnatura con inserti in fibra di vetro
• in astuccio



	L	A	L1		
	mm	mm	mm		
1778M7	163	24	68	5	017780015

1778P

coltello a serramanico
lama ed impugnatura in acciaio inossidabile e
alluminio,
con apertura a pulsante
• in astuccio



	L	A	L1		
	mm	mm	mm		
1778P	193	29	72	5	017780088

1778SCL

coltello a serramanico con finitura soft carbon
look
lama in acciaio temprato
• in astuccio



	L	A	L1		
	mm	mm	mm		
1778SCL	180	22	78	5	017780089

1778SOS

coltello soccorso auto
con funzione martello frangicristallo
e tagliacinture di sicurezza
• in astuccio



	L	A	L1		
	mm	mm	mm		
1778SOS	205	25	85	5	017780080

1778V18

coltello a serramanico
impugnatura in alluminio
• in astuccio



	L	A	L1		
	mm	mm	mm		
1778V18	195	25	85	5	017780018

1778X

coltelli per nautica in acciaio inossidabile
impugnatura in alluminio



	L	L1	A		
	mm	mm	mm		
1778X	185	85	25	2	017780050

MULTITOOL - 1778MT

L'utensile multifunzione BETA si distingue dagli articoli simili presenti in commercio per caratteristiche che denotano la sua origine BETA: pinza di qualità incomparabile, utilizzo di materiali ricercati ed elevato contenuto tecnologico. La presenza di **11 inserti**, aventi le geometrie più presenti sul mercato, rende questo articolo ideale per ogni ambiente e condizione di lavoro, dal campeggio alla nautica, dalla caccia al fai da te.



22 FUNZIONI

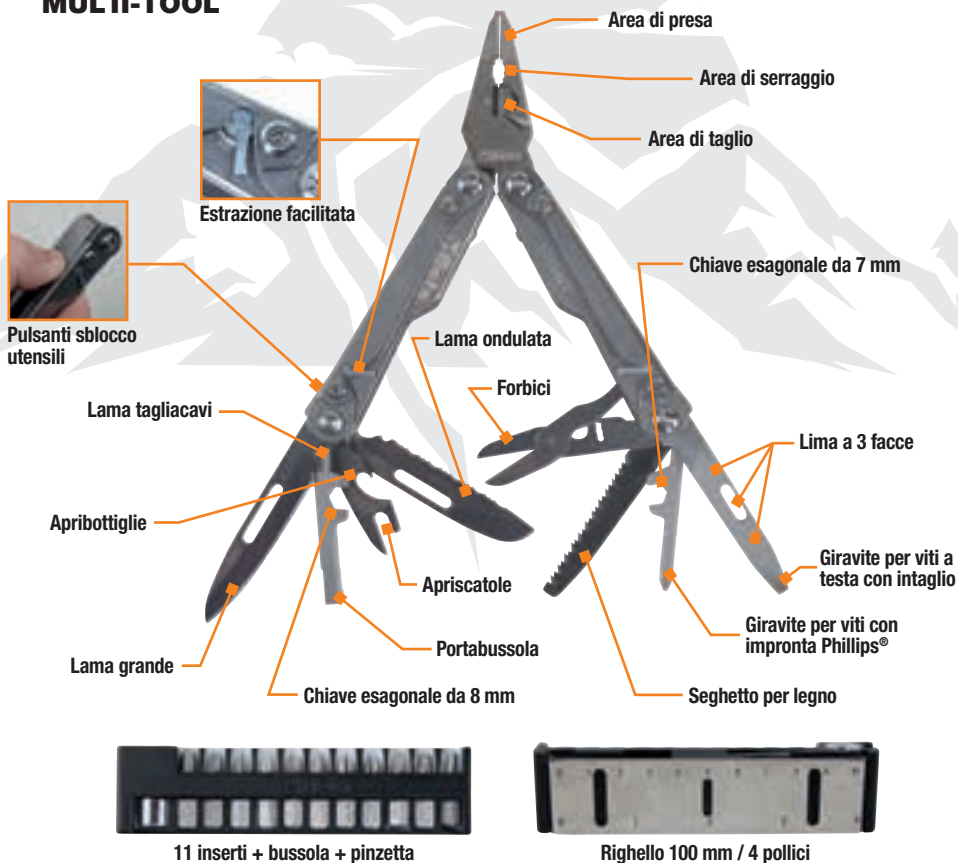

11 inserti + bussola + pinzetta



Righello 100 mm / 4 pollici

1778MT

utensili multifunzione
completi di inserti e fodero
9 utensili
22 funzioni



L mm	L1 mm	
180	115	1 017780055

1781

forbici a lame lunghe sottili



1781	L mm	
	132	2 017810001

1783

forbici modello leggero



L mm		
215	5	017830021
240	5	017830024

1784

forbici modello pesante



L mm		
175	2	017840017
200	2	017840020
250	2	017840025
300	2	017840030

1800/100

cuscini sollevatori (max 135 kg)

- sollevare-livellare
- bloccare porte ed ante



A mm	B mm	S mm	
160	150	2=55	3 018000000



Beta

ILLUMINAZIONE

La famiglia Illuminazione comprende una vasta gamma di prodotti studiati per soddisfare le esigenze di tutti gli utilizzatori, a partire dalla ispezione di piccoli condotti fino all'illuminazione di ampie aree di lavoro.

TORCE

Il nuovo design accattivante, i miglioramenti tecnici e l'ampia offerta di misure, consentono di scegliere la torcia più adatta in base alla luminosità, alla autonomia e alle prestazioni.

LAMPADE E FARI

Grazie al miglioramento della tecnologia LED, all'aumentata durata delle batterie, alla riduzione dei tempi di ricarica, alla particolare attenzione ai materiali e alla costante ricerca di soluzioni innovative, le lampade da lavoro Beta rappresentano un ottimo connubio di design, praticità e prestazioni. Una gamma completa per consentire al professionista di svolgere al meglio il proprio lavoro, in qualsiasi settore e in qualsiasi condizione.

WIRELESS



Wireless charging

La nuova tecnologia wireless consente la carica dei più recenti fari e lampade attraverso un'unica base di ricarica 1839BRW.

Attraverso la nuova base è possibile caricare contemporaneamente i più recenti fari

e lampade senza dover necessariamente ricorrere ai cavi. Inoltre, grazie al supporto estraibile, è possibile ricaricare anche il telefono cellulare.



CRI - Color Rendering Index

CCT - Correlated Color Temperature

FARI

ITEM	LUMEN	BATTERIA	TEMPO RICARICA	DURATA	IP/IK	CCT	CRI
1837C/2100	500 - 1000 - 2100	Li-Ion 11.1V; 4400 mAh	4.0h	9 - 2.5h	IP65 - IK07	6500K	80+
1837C/4300	1100 - 2100 - 4300	Li-Ion 11.1V; 5200 mAh	4.0h	6 - 1.5h	IP65 - IK07	6500K	80+
1837M	500 - 1000 - 2000	Li-Ion 11.1 V, 5200 mAh	3.5h	2 - 8h	IP65 - IK07	2700-3500-4500-5500-6500K	96+
1838FLASH	360 - 720	Li-Ion 7.4V; 4000 mAh	4.0h	4 - 8h	IP65	6300K	-
1838POCKET	160 - 400 - 800	Li-Ion 3.7V; 2600 mAh	4.0h	3 - 9h	IP65	6500K	80+

LAMPADE

ITEM	LUMEN	BATTERIA	TEMPO RICARICA	DURATA	IP/IK	CCT	CRI
1838/11LED	320	Li-Ion 3.7V; 4200 mAh	4.0h	4h	IP65	6500K	
1838AM	60 - 700 120 (spot)	Li-Ion 3.7V; 2600 mAh	4.0h - USB-C	2.5 - 16h 10h (spot)	IP54 - IK07	6500K	80+ 70+
1838COB	100 - 200 75 (spot)	Li-Ion 3.7V; 1600 mAh	3.0h	3-6h 4h (spot)	IP65	6000K	80+
1838P	80 - 50	Li-Ion 3.7V; 700 mAh	2.5h	4h	IP20	6000K	80+
1838SLIM	100 - 200 180 (back) 80 (spot)	Li-Ion 3.7V; 700 mAh	2.5h - USB-C	2 - 4h 2h (back) 3h (spot)	IP54 - IK07	6500K	80
1838UV	75 - 150	Li-Ion 3.7V; 1600 mAh	3.0h	3h	IP20	6000K	80
1838SW	250 - 500 - 1000	Li-Ion 3.6V; 3350 mAh	4.5 - 6.5h	3 - 7h	IP65 - IK07	6500K	80+
1838E	500 - 1000 - 2000	Li-Ion 3.6V; 3350 mAh	4.5 - 6.5h	3 - 9h	IP20 - IK07	5500K	80+

LAMPADE DA TESTA

ITEM	LUMEN	BATTERIA	TEMPO RICARICA	DURATA	IP/IK	CCT	CRI
1836B	125 - 250	Li-Ion 3.8V; 1600 mAh	3.0h	5h	IP65 - IK07	6000K	80+
1836AW	30 - 200 - 400	Li-Ion 3.7V; 1500 mAh	2.5h	4-18h	IP65 - IK07	6500K	80+

TORCE

ITEM	LUMEN	BATTERIA	TEMPO RICARICA	DURATA	IP/IK	PORTATA
1833XS/1	100	1 x AAA	-	5h	IP66	85m
1833XS/2	200	2 x AAA	-	10h	IP66	112m
1833S	500	2 x AA	-	10h	IP66	140m
1833M	700	3 x AAA	-	7.5h	IP66	170m
1833L	1100	3 x AA	-	8.5h	IP66	330m
1833L/USB	1200	Li-Ion 3.7V; 2600 mAh	3.0h - USB-C	3.0h	IP66	230m
1833XL	1500	3xD	-	22h	IP66	290m
1834RR	130	Li-Ion 3.7V; 550 mAh	2.0h	1h	IP30	-
1837F	500	3 x AA	-	14.5h	IP66	125m
1837F/USB	600	Li-Ion 3.7V; 2900 mAh	4.0h - USB-C	10h	IP66	280m

1833L/USB

torcia LED ricaricabile ad alta luminosità in robusto alluminio anodizzato, fino a 1200 Lumen

- cono luminoso regolabile
- 3 intensità luminose
- durata 3.0h
- IP66
- portata: 230 m
- indicazione di batteria scarica sotto il 15%
- ricarica con attacco USB-C
- caricatore non incluso



L
mm
240

1 018330054

1833RB-L/USB

batteria di ricambio per 1833L/USB

1833RB-L/USB

1 018330975

1833KS/1

torcia LED per ispezioni, in robusto alluminio anodizzato

- 100 lumen
- cono luminoso regolabile
- pila 1xAAA (non inclusa)
- IP66
- durata 5.0h
- portata: 85 m



L
mm
92

3 018330000

1833KS/2

torcia LED per ispezioni, in robusto alluminio anodizzato

- 200 lumen
- cono luminoso regolabile
- pile 2xAAA (non incluse)
- IP66
- durata 10.0h
- portata: 112 m



L
mm
133

3 018330001

1833S

torcia LED ad alta luminosità
in robusto alluminio anodizzato,
fino a **500 Lumen**

- cono luminoso regolabile
- 2 intensità luminose
- pile 2xAA (non incluse)
- durata 10.0h
- IP66
- portata: 140 m



L
mm
150

1 018330002

1833M

torcia LED ad alta luminosità
in robusto alluminio anodizzato,
fino a **700 Lumen**

- cono luminoso regolabile
- 2 intensità luminose
- pile 3xAAA (non incluse)
- indicatore di batteria scarica <15%
- durata 7.5h
- IP66
- portata: 170 m



L
mm
162

1 018330003

1833L

torcia LED ad alta luminosità
in robusto alluminio anodizzato,
fino a **1100 Lumen**

- cono luminoso regolabile
- 2 intensità luminose
- pile 3xAA (non incluse)
- indicatore di batteria scarica <15%
- durata: 8.5h
- IP66
- portata: 330m



L
mm
196

1 018330004

1833XL

torcia LED ad alta luminosità
in robusto alluminio anodizzato,
fino a **1500 Lumen**

- cono luminoso regolabile
- 2 intensità luminose
- pile 3xD (non incluse)
- indicatore di batteria scarica <15%
- durata 22.0h
- IP66
- portata: 290 m



L
mm
300

1 018330005

1834RR

torcia LED ricaricabile
con presa accendisigari

cono luminoso regolabile
Ricarica con presa accendisigari 10-28V DC
IP30
130 Lumen



1834RR

1 018340520

1836AW

lampada da testa a LED con ricarica wireless,
con doppia emissione luminosa

- 2 emissioni luminose:
principale: 3 intensità luminose LED COB 30 - 200 - 400 lumen
spot: LED COB, 400 lumen
- batteria ricaricabile: Li-Ion 3.7 V, 1500 mAh, 5.55 Wh
- 2 modalità di ricarica:
base wireless 1839BRW
alimentatore con attacco USB-C
- cavo USB-C incluso
- tempo di ricarica: 2.5h
- autonomia:
principale: 4-18h
spot: 4h
- IP 65
- IK 07



1836AW

1 018360051

1836B

lampada da testa ricaricabile a LED,
con doppia luminosità e sensore ON/OFF

- Sensore ON/OFF contactless
- 250 Lumen
- Autonomia : 3-6 h
- IP65



1836B

1 018360200

1837F

lampada magnetica snodata con LED ad alta
luminosità,
in robusto alluminio anodizzato,
fino a **500 Lumen**

- cono luminoso regolabile
- 2 intensità luminose
- pile 3xAA (non incluse)
- durata 14.5h
- indicatore di carica
- IP66



L
mm
460

1 018370050

1837F/USB

lampada ricaricabile magnetica snodata con
LED ad alta luminosità,
in robusto alluminio anodizzato,
fino a **600 Lumen**

- cono luminoso regolabile
- 2 intensità luminose
- durata 10.0h
- indicatore di batteria scarica <15%
- ricarica con attacco USB-C
- IP66



L
mm
460

1 018370060

1837RB-F/USB

batteria di ricambio per 1837F/USB

1837RB-F/USB



1 018370960

1838POCKET

faretto tascabile snodato, a LED, orientabile, con doppio fascio luminoso, ricaricabile con ricarica wireless

- doppia emissione luminosa:
- luce principale: LED COB, 3 intensità luminose: 160 - 400 - 800 Lumen
- luce spot: LED SMD, 250 lumen
- angolo illuminante: luce principale: 160°
luce spot: 18°
- batteria ricaricabile 3.7V 2600mAh Li-ion
- 2 modalità di ricarica: base wireless 1839BRW alimentatore con attacco USB-C
- tempo di ricarica: 4.5 h con base ricarica wireless
4 h con alimentatore
- autonomia: luce principale: 3-9h
luce spot: 4.5 h
- Indicatore livello di batteria a 3 led
- orientabile a 210°
- corpo in gomma antiscivolo
- base magnetica
- 1 magnete sulla base
- IP65
- IK07
- cavo USB-C incluso

CE

IP65
IK07



L	I	S
mm	mm	mm
98	82	39



1 018380080

1837C

faretti ricaricabili a LED da cantiere

- 3 intensità luminose
- carica batterie:
- input: 100-240V AC - 50/60Hz;
- output: 15V 1.5A
- tempo di ricarica: 4 ore
- indicatore di carica a 3 LED
- orientabile a 180°
- IP65
- IK07

CE

IP65
IK07



LxHxI	Lm	h
mm		
220x225x70	2100	2.5
	1000	5.0
	500	9.0
266x236.6x59	4300	1.5
	2100	3.0
	1100	6.0



1 018370210

1 018370430

1837C/RA2100-4300

Alimentatore faretti LED 1837C/2100-4300

100V-240V AC/DC 15V 1.5A



1837C/RA2100-4300



1 018370970

1837M

faretto ricaricabile a LED COLOUR MATCH, per controllo colore, elevato indice di resa cromatica (CRI 96+), fino a 2.000 Lumen

- 3 intensità luminose: 500/1.000/2.000Lumen
- CRI (indice di resa cromatica): 96+
- CCT (temperatura colore):2700K/ 3500K/ 4500K/ 5500K/ 6500K
- carica batterie: input: 100-240V AC - 50/60Hz; output: 15V 1.5A
- connettore di ricarica a sgancio rapido
- tempo di ricarica: 3.5 ore
- durata: 8/4/2 h
- indicatore di carica
- pulsante e led indicatore di temperatura colore
- pulsante e led indicatore di intensità luminosa
- orientabile a 180°
- IP65
- IK07

CE

IP65
IK07



LxHxI	Lm	h
mm		
220x225x70	500	8.0
	1000	4.0
	2000	2.0



1 018370450

1837M/RA

Alimentatore faretti COLOUR MATCH 1837M

110V-240V AC/DC 15V 1.5A

Lunghezza cavo 5m

Con caricatore a sgancio rapido



1837M/RA



1 018370975

1837S

treppiede telescopico per supporto faro da cantiere

- in metallo
- altezza variabile 70÷170 cm
- compatibile con 1837C, 1838FLASH e 1837M



h
cm
70÷170



1 018370500

1838FLASH

faretto ricaricabile ultracompatto, studiato per offrire la migliore soluzione possibile in ogni utilizzo.

ILLUMINAZIONE ABBONDANTE E SEMPRE PRONTA: con una capacità illuminante massima di 720 lumen e la possibilità di lavorare a batteria o a cavo è sempre pronto all'uso

POSIZIONABILE OVUNQUE:
-su piani: grazie ai piedini di gomma e all'attacco da 1/4" per cavalletto (attacco standard tipo macchina fotografica)
-su strutture metalliche: grazie al magnete svitabile e al gancio orientabile a 360°

COMPATTO: con soli 85x100x155 mm di ingombro può essere comodamente alloggiato nella borsa degli attrezzi ed utilizzato anche in spazi ristretti.

ROBUSTO: studiato per resistere alle sollecitazioni meccaniche più severe.

- 720 Lumen

CE

IP65



1838FLASH



1 018380300

1838RB/FLASH

batteria di ricambio per 1838FLASH

1838RB/FLASH



1 018380930

1838/11LED

lampada ricaricabile con LED ad altissima luminosità

batteria ai polimeri di litio

- corpo compatto in gomma antiscivolo
- vetrino frontale facilmente sostituibile
- gancio orientabile
- con stazione di ricarica 110-230Vac
- 320 Lumen
- con led in testa per illuminazione multidirezionale
- tempo di ricarica: 6h
- autonomia: 4h 40min



1838/11LED 1 018380111

1838RA/10-11LED

alimentatori di ricambio per 1838/10LED e 1838/11LED

CE

1838RA/10-11LED 1 018380903

1838RB/10LED

batteria di ricambio per 1838/10LED e 1838/11LED

1838RB/10LED 1 018380902

1838RR/11LED

basi di ricarica per 1838/11LED

1838RR/11LED 1 018380914

1838RV/11LED

vetrino paragraffi di ricambio per lampada 1838/11LED



1838RV/11LED 2 018380905

1838AM

lampada da ispezione ricaricabile a LED, con doppia emissione luminosa, snodata e orientabile a 180°, con base magnetica e gancio orientabili

- 2 emissioni luminose:
 - frontale: LED COB, 60-700 lumen, regolabile con potenziometro
 - spot (testa): LED SMD, 120 lumen, interruttore ON-OFF
- batteria ricaricabile 3.6V 2600mAh Li-ion
- con attacco USB-C
- fornita con caricatore 100-240V / 50-60Hz
- tempo di ricarica: 4h
- autonomia:
 - frontale: 2.5-16h
 - spot (testa): 10h
- indicatore livello di batteria a 3 led

- snodata e orientabile a 180° ($\pm 90^\circ$ rispetto all'asse)
- base magnetica (con magneti al neodimio) orientabile a 90°
- gancio orientabile alla base

- IP54
- IK07



L I S L1
mm mm mm mm
1838AM 405 40 45 175 1 018380400

1838COB

lampada a LED portatile ricaricabile

- appendibile, con corpo in gomma antiscivolo e antiurto
- batteria ai polimeri di Litio
- Gancio orientabile
- Base magnetica orientabile a 180 gradi
- Con caricatore 100-240Vac / 50-60Hz
- 100/200 lumen; SPOT 75 lumen
- Autonomia: 6h / 3h; SPOT 4h
- tempo di ricarica: 3 ore
- IP65



1838COB 1 018380010

1838P

lampada ricaricabile a penna, con doppia emissione luminosa: a lampada o a torcia

- Corpo compatto in gomma antiscivolo
- 75/150 Lumen
- Gancio da taschino
- Base magnetica orientabile a 180 gradi
- Fornita con cavo di ricarica USB/jack 3.5mm
- Autonomia: 2-4 ore
- IP65



1838P 1 018380005

1838SLIM

lampada sottile a 3 LED snodata ricaricabile

- 3 emissioni luminose
- frontale: 100/200 lumen/ posteriore: 180 lumen/ spot (testa): 80 lumen
- base magnetica
- tempo di ricarica: 2.5h
- autonomia: 2-4h/ spot 3h

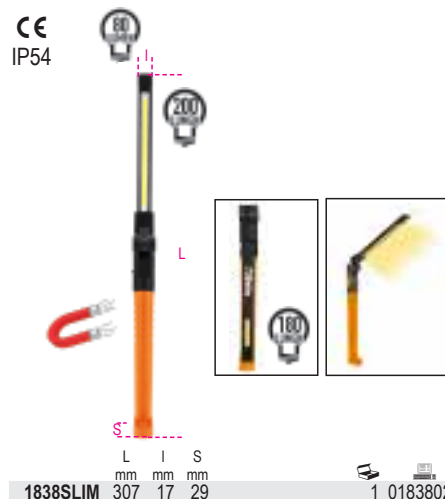

1838SLIM 1 018380221

 Beta

 Beta

1838SW

lampada snodata a LED,
ricaricabile **con ricarica wireless**

- doppia emissione luminosa:
frontale: LED COB, 3 intensità luminose: 250 - 500 - 1000 Lumen
- spot (testa): LED SMD, 200 lumen
- batteria ricaricabile 3.6V 3.350mAh Li-ion
- 2 modalità di ricarica:
base wireless 1839BRW
alimentatore con attacco USB-C
- tempo di ricarica:
6.5h con base ricarica wireless
4.5h con alimentatore
- autonomia:
frontale: 3-5h
spot (testa): 7h
- Indicatore livello di batteria a 3 led
- base orientabile a 180°
- corpo in gomma antiscivolo
- doppio gancio orientabile
- 3 magneti sul retro
- 1 magnete sulla base
- IP65
- IK07
- cavo USB-C incluso



1838SW	L mm	I mm	S mm	1	018380142
	260	53	40		

1838UV

lampada ricaricabile UV + luce bianca
ideale per la ricerca di perdite

- Corpo compatto in gomma antiscivolo
- Con caricatore 100-240Vac / 50-60Hz
- 150 lumen / UV



1838UV	1	018380150
--------	---	-----------

1838E

lampada sottocofano ricaricabile a LED

- 3 intensità luminose: 500/1000/2000 lumen
- orientabile a 360°
- lunghezza variabile: 116 ÷ 188 cm
- corpo in alluminio
- ganci in gomma antiscivolo
- ricarica con attacco USB-C
- 2 modalità di ricarica:
ricarica tramite presa USB della lampada
ricarica tramite presa USB della batteria interna
- fornita con caricatori
- input: 100-240V ~ 50/60Hz
output: DC 5V - 2000 mA
- autonomia: 3-9 h
- batteria inclusa
- IP20
- IK07

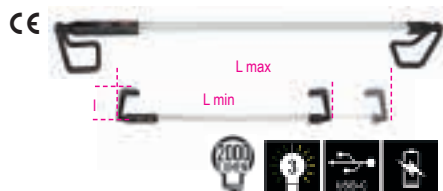

IP20
IK07

L min mm	L max mm	I mm	1	018380270
1170	1880	150		

1838E-BT

batteria ricaricabile con attacco USB-C per
lampada sottocofano 1838E

- Li-Ion 3,6V
- DC 5V - 2000 mA

CE

1838E-BT	1	018380271
----------	---	-----------

1839BRW

base di ricarica wireless,
**compatibile con lampade 1838POCKET,
1838SW, 1836AW**

- due posizioni di ricarica con attacco magnetico utilizzabili contemporaneamente
- con supporto estraibile per ricarica wireless telefono cellulare
- led per indicare lo stato di ricarica
- max input 10W x2
- input: AC 100-240V 50/60Hz
- output:
DC 12V 1.5A
DC 9V 2A
DC 5V 3A
- cavo QC3.0 USB-C (Fast charger)
- caricatore QC3.0 USB-C (Fast charger)
- appendibile a parete tramite: 3 forti magneti sul retro
2 fori per viti

- IP20
- IK07



1839BRW	L mm	I mm	S mm	1	018390002
	101	190	28		

1839/R5

cavo USB-C QC 3.0, ricambio per
1838POCKET, 1839BRW, 1836AW

1839/R5	1	018390505
---------	---	-----------

1839/R6

trasformatore quick charge USB Q C3.0,
ricambio per 1838POCKET, 1839BRW,
1836AW

1839/R6	1	018390506
---------	---	-----------

1839/R1

trasformatore con uscita USB, ricambio per
1833L/USB, 1836B, 1837F/USB, 1838COB,
1838P, 1838S, 1838SLIM, 1838UV, 1838AM,
1838E

IN: 100-240Vac / 50-60Hz
USB OUT: 5Vdc / 1A

CE

1839/R1	1	018390501
---------	---	-----------

1839/R2

cavo USB/jack 3.5mm, ricambio per 1836B,
1838P, 1838COB, 1838UV

1839/R2	1	018390502
---------	---	-----------

1839/R4

cavo USB/USB-C, ricambio per 1833L/USB,
1837F/USB, 1838SLIM, 1838S, 1838AM,
1838E

1839/R4	1	018390504
---------	---	-----------



1840BM

portalampana portatile
per lampada con attacco E27
alimentazione 230V
• Lampada esclusa



IP20

1840BM V 230 W 60 L mm 420 1 018400101

1842LED/BM

lampada con LED ad altissima luminosità,
100- 240 Vac

- cavo da 10 m
- corpo compatto in gomma anticivolo
- vetrino frontale facilmente sostituibile
- gancio orientabile
- 340 Lumen
- con LED in testa per illuminazione multidirezionale



IP65

1842LED/BM L mm 230 1 018420301

1842LED/ABM

lampada con LED ad altissima luminosità,
12-24 V AC/DC

- cavo da 10 m
- corpo compatto in gomma anticivolo
- vetrino frontale facilmente sostituibile
- gancio orientabile
- 340 Lumen
- con LED in testa per illuminazione multidirezionale



IP65

1842LED/ABM L mm 230 1 018420311

AVVOLGITORI



La nuova gamma di arrotolatori, progettata e sviluppata da Beta, offre un programma ampio e completo, atto a soddisfare le esigenze di tutti i professionisti.

- la gamma avvolgicavi comprende un'ampia proposta di metrature e tipologie di cavo, versioni con lampada LED e con presa e spina SCHUKO.
- la gamma avvolgitubo comprende tubi da 8 e 10 mm di diametro.

La molla ad alta resistenza assicura una estrema durata nel tempo e la massima fluidità di utilizzo.

Scocche realizzate in polipropilene ad alto spessore per una elevata resistenza agli urti. Il dispositivo a cremagliera permette di bloccare il riavvolgimento automatico del cavo ed è facilmente disinseribile per permettere di lavorare in trazione continua.

Tutti gli arrotolatori sono forniti di una staffa orientabile di 180° per il fissaggio a muro e di una seconda staffa per l'aggancio/sgancio rapido al supporto a parete.

AVVOLGICAVI

Ampia proposta di ben 18 versioni per soddisfare qualunque necessità lavorativa anche dell'utente più esigente. Lunghezze disponibili da 10 a 30 metri con sezioni da 2x1,0 mm² a 5Gx1,5mm² e con tipologie di cavo H05VV-F e H07RN-F. Tutti gli avvolgicavi, fino ad una sezione del cavo di 3Gx2,5mm², sono forniti di protezione termica che entra in funzione in caso di sovraccarico del circuito elettrico.



AVVOLGITUBI



pag. 337

Una gamma selezionata, con lunghezze disponibili da 10 a 15 metri con diametro da 8 e da 10 mm, per utilizzo con utensili pneumatici.

I nostri prodotti, grazie ad una tenuta senza perdite, possono essere utilizzati anche con acqua.

Art.		Conduttori	Sezione	Tipo cavo	Lungh.	Protez. termica	Accessorio
1842 15-H05/LED	018420821	2x	1,0 mm ²	H05VV-F	15+1 m	SI	Lampada LED
1843 15-H05	018430215	2x	1,5 mm ²	H05VV-F	15+1 m	SI	
1844 10-H05	018440310	3G	1,5 mm ²	H05VV-F	10+1 m	SI	-
1844 15-H05	018440315			H05VV-F	15+1 m	SI	-
1844 15-H07	018440317			H07RN-F	14+1 m	SI	-
1844 30-H05	018440330			H05VV-F	30+2 m	SI	-
1844 15-H05/SCK	018440316	3G	1,5 mm ²	H05VV-F	15+1 m	SI	SCHUKO
1844 15-H07/SCK	018440318			H07RN-F	14+1 m	SI	SCHUKO
1845 12-H05	018450365	3G	2,5 mm ²	H05VV-F	12+1 m	SI	
1845 15-H07	018450367			H07RN-F	15+1 m	SI	
1845 25-H07	018450377			H07RN-F	25+1,5 m	SI	
1846 10-H05	018460405	4G	1,5 mm ²	H05VV-F	10+1 m	NO	
1846 10-H07	018460407			H07RN-F	10+1 m	NO	
1846 15-H05	018460415			H05VV-F	15+1 m	NO	
1847 10-H05	018470420	4G	2,5 mm ²	H05VV-F	10+1 m	NO	
1847 15-H07	018470427			H07RN-F	15+1 m	NO	
1848 10-H05	018480510	5G	1,5 mm ²	H05VV-F	10+1 m	NO	
1848 15-H07	018480517			H07RN-F	15+1 m	NO	

1842

avvolgitore automatico completo di lampada a LED, 100-240Vac

- con trasformatore di sicurezza 230/12V
- cavo H05VV-F 2x1,0 mm²
- 15 m di cavo arrotolato
- cavo in entrata da 1,5 m con spina SCHUKO
- lunghezza cavo fuori scocca 1 m
- cremagliera disinseribile per cavo sempre in trazione
- fornito con staffa orientabile di 180° e seconda staffa ad incastro rapido

CE

IP42
IP65



1842 15-H05/LED	H05VV-F	L m	15+1	1	018420821
-----------------	---------	--------	------	---	-----------

1846R-LED/BM

lampade di ricambio a LED

12-24V - AC-DC



1846LED/BM R				1	018460331
--------------	--	--	--	---	-----------

1843

avvolgitore automatico con cavo 2x1,5 mm²

- cavo H05VV-F 2x1,5 mm²
- con protettore termico
- 15 m di cavo arrotolato
- lunghezza cavo fuori scocca 1 m
- fornito senza cavo in entrata
- cremagliera disinseribile per cavo sempre in trazione
- potenza max. arrotolata 1300W (230V-20°C)
- potenza max. srotolata 2300W (230V-20°C)
- fornito con staffa orientabile di 180° e seconda staffa ad incastro rapido

CE

IP42



1843 15-H05	H05VV-F	L m	15+1	1	018430215
-------------	---------	--------	------	---	-----------

1844

avvolgitore automatico con cavo 3Gx1,5 mm²

- cavo 3Gx1,5 mm²
- con protettore termico
- lunghezza cavo fuori scocca 1 m (tranne 1844 30-H05 con 2 m)
- fornito senza cavo in entrata
- cremagliera disinseribile per cavo sempre in trazione
- potenza max. arrotolata 1500W (230V-20°C)
- potenza max. srotolata 2500W (230V-20°C)
- fornito con staffa orientabile di 180° e seconda staffa ad incastro rapido

CE

IP42



1844 10-H05	H05VV-F	L m	10+1	1	018440310
1844 15-H05	H05VV-F	L m	15+1	1	018440315
1844 15-H07	H07RN-F	L m	14+1	1	018440317
1844 30-H05	H05VV-F	L m	30+2	1	018440330

1844SCK

avvolgitore automatico con cavo 3Gx1,5 mm² con presa SCHUKO

- cavo 3Gx1,5 mm²
- con protettore termico
- lunghezza cavo fuori scocca 1 m
- fornito con cavo in entrata da 1,5 m e spina SCHUKO
- cremagliera disinseribile per cavo sempre in trazione
- potenza max. arrotolata 1500W (230V-20°C)
- potenza max. srotolata 2500W (230V-20°C)
- fornito con staffa orientabile di 180° e seconda staffa ad incastro rapido

CE

IP42



1844 15-H05/SCK	H05VV-F	L m	15+1	1	018440316
1844 15-H07/SCK	H07RN-F	L m	14+1	1	018440318

1845

avvolgitore automatico con cavo 3Gx2,5 mm²

- cavo 3Gx2,5 mm²
- con protettore termico
- lunghezza cavo fuori scocca 1 m (tranne 1845 25-H07RN-F con 1,5 m)
- fornito senza cavo in entrata
- cremagliera disinseribile per cavo sempre in trazione
- potenza max. arrotolata 2000W (230V-20°C)
- potenza max. srotolata 3000W (230V-20°C)
- fornito con staffa orientabile di 180° e seconda staffa ad incastro rapido

CE

IP42



1845 12-H05	H05VV-F	L m	12+1	1	018450365
1845 15-H07	H07RN-F	L m	15+1	1	018450367
1845 25-H07	H07RN-F	L m	25+1,5	1	018450377

1846

avvolgitore automatico con cavo 4Gx1,5 mm²

- cavo 4Gx1,5 mm²
- senza protettore termico
- lunghezza cavo fuori scocca 1 m
- fornito senza cavo in entrata
- cremagliera disinseribile per cavo sempre in trazione
- potenza max. arrotolata 1400W (400V-20°C)
- potenza max. srotolata 1900W (400V-20°C)
- fornito con staffa orientabile di 180° e seconda staffa ad incastro rapido

CE

IP42



1846 10-H05	H05VV-F	L m	10+1	1	018460405
1846 10-H07	H07RN-F	L m	10+1	1	018460407
1846 15-H05	H05VV-F	L m	15+1	1	018460415

1847

avvolgitore automatico con cavo 4Gx2,5 mm²

- cavo 4Gx2,5 mm²
- senza protettore termico
- lunghezza cavo fuori scocca 1 m
- fornito senza cavo in entrata
- cremagliera disinseribile per cavo sempre in trazione
- potenza max. arrotolata 2000W (400V-20°C)
- potenza max. srotolata 2700W (400V-20°C)
- fornito con staffa orientabile di 180° e seconda staffa ad incastro rapido

CE



IP42

1847 10-H05	H05VV-F	10+1	1	018470420
1847 15-H07	H07RN-F	15+1	1	018470427

1848

avvolgitore automatico con cavo 5Gx1,5 mm²

- cavo 5Gx1,5 mm²
- senza protettore termico
- lunghezza cavo fuori scocca 1 m
- fornito senza cavo in entrata
- cremagliera disinseribile per cavo sempre in trazione
- potenza max. arrotolata 1400W (400V-20°C)
- potenza max. srotolata 1900W (400V-20°C)
- fornito con staffa orientabile di 180° e seconda staffa ad incastro rapido

CE



IP42

1848 10-H05	H05VV-F	10+1	1	018480510
1848 15-H07	H07RN-F	15+1	1	018480517

1850D

pistola termica 3 velocità

- Pos. I 250 l/min 50°C
- Pos. II 250 l/min 400°C
- Pos. III 500 l/min 550°C
- 4 ugelli inclusi

CE



1850D	L mm	H mm	1	018500018
	255	210		

1850E

pistola termica con regolazione elettronica

- Pos. I 250-500 l/min 50°C
- Pos. II 250-500 l/min 50-650°C

- Display digitale.
- Pulsanti regolazione temperatura e portata del flusso.
- 4 programmi memorizzati in origine e possibilità di personalizzazioni

- Prog 1 150°C ca. 400 l/min
- Prog 2 200°C ca. 400 l/min
- Prog 3 300°C ca. 450 l/min
- Prog 4 400°C ca. 500 l/min

CE



1850E	L mm	H mm	1	018500020
	255	210		

1851VK

pistola per colla a caldo con 12 stick di colla termofusibile in valigetta

- potenza 80 watt
- per colla in stick ø 11 e 12 mm

CE



1851VK	1	018510058
--------	---	-----------

320x250x50 mm

1851VK-12C

12 stick di colla termofusibile

ø 11 mm



1851VK-12C	1	018510062
------------	---	-----------

1851VK-12V

12 stick di colla termofusibile per superfici verniciate

ø 11 mm



1851VK-12V	1	018510072
------------	---	-----------

1852R1750

riscaldatore ad induzione portatile



Riscalda e sblocca bulloni, dadi, mozzi e cuscinetti particolarmente bloccati senza l'utilizzo di fiamme. Permette di scaldare qualsiasi tipo di metallo ferromagnetico.

Vantaggi:

- Risparmio di tempo: riscaldamento veloce e con grande precisione
- Sicurezza anti incendio: non genera fiamme, massima sicurezza per l'operatore
- Praticità: utilizzabile con una sola mano e serpentine facilmente intercambiabili

Dotazione:

- Due serpentine frontali con diametro 19 e 26 mm per sblocco dadi
- Una serpentina piatta per scaldare le superfici
- Una serpentina flessibile lunga 800 mm
- Fornito in valigetta di plastica

Dati tecnici:

- Tensione di ingresso: 230V AC, 50/60 Hz
- Corrente di ingresso: max. 7,5A
- Potenza: max. 1.75 kW

Campi di applicazione:

- Automotive
- Manutenzione industriale
- Industria aeronautica
- Industria navale
- Industria petrolchimica

1852R1750	1	018520175
-----------	---	-----------

480x370x130 mm - 4,5 kg

1852S-CNT

serpentina a contatto



1852S-CNT	1	018520520
-----------	---	-----------

1852S-CC

serpentina a cucchiaio



1852S-CC	1	018520521
----------	---	-----------

1852S-KR/CNT

kit ricambi per serpentina a contatto



1852S-KR/CNT

1 018520522

1852S-L

serpentine laterali



	Ø mm	M	L mm		
1852S-L 19	19	M6	220	1	018520501
1852S-L 20	20	M8	220	1	018520502
1852S-L 23	23	M10	220	1	018520503
1852S-L 26	26	M12	220	1	018520504
1852S-L 32	32	M16	220	1	018520505
1852S-L 38	38	M20	220	1	018520506
1852S-L 45	45	M22	220	1	018520507

1852S-F

serpentina frontale



	Ø mm	M	L mm		
1852S-F 19	19	M6	220	1	018520508
1852S-F 20	20	M8	220	1	018520509
1852S-F 23	23	M10	220	1	018520510
1852S-F 26	26	M12	220	1	018520511
1852S-F 32	32	M16	220	1	018520512
1852S-F 38	38	M20	220	1	018520513
1852S-F 45	45	M22	220	1	018520514

1852S-FLESS

serpentina flessibile



1852S-FL 750	1	018520519
1852S-FL 800	1	018520515
1852S-FL1000	1	018520517
1852S-FL1500	1	018520518

1852 S-PIATTE

serpentina piatta



1852S-PIATTE

1 018520516

Beta

Beta
Quality Tools



SALDATURA



SALDATRICI AD INVERTER

Saldatrici ad inverter facili da utilizzare, ottime caratteristiche di saldatura con tutti i tipi di elettrodi. Dotati di controllo di sovratensione, sovratemperatura e antincollaggio dell'elettrodo. Sono compatti e leggeri, ideali per lavori di manutenzione domestica, carpenteria leggera e lavori di manutenzione.



MASCHERE PER SALDARE

Beta offre varie maschere LCD ad oscuramento automatico adatte a differenti tipi di saldatura: ad elettrodo, MIG/MAG, TIG e plasma. Protezione e comfort vengono garantite dalla piena conformità a tutte le normative di sicurezza vigenti.



ACCESSORI PER LA SALDATURA

Ampia gamma di accessori per supportare le operazioni legate ai lavori di saldatura.



SALDATRICI PER STAGNO E A GAS

Saldatrici e accessori studiati per le piccole manutenzioni e lavorazioni nell'ambito della microelettronica. Oltre alle saldatrici alimentate via cavo, Beta offre varie soluzioni a gas butano che consentono anche lavorazioni in ambiente outdoor e in assenza di elettricità.

1808

saldatore a doppia potenza
con punta acciata 1824 R08



W	V	
20/130	230	1 018080001

1812 150

saldatore istantaneo



W	V	
150	230	1 018120015

1814M

saldatori a stilo
con punta acciata



W	V	
25	230	1 018140225
30	230	1 018140230
40	230	1 018140240

1820

saldatori a stilo



1820 30	30W	L = 210mm	1 018200003
1820 60	60W	L = 220mm	1 018200006
1820 80	80W	L = 260mm	1 018200008

1822

saldatori a martello



1822 120	120W	LxA = 250x125 mm	1 018220012
1822 180	180W	LxA = 250x125mm	1 018220018
1822 320	320W	LxA = 250x140mm	1 018220032

1823 60

stazione di saldatura
a controllo digitale
fornita con saldatore

- Regolazione continua della temperatura da 160°C a 480°C con precisione ±1%.
- Funzione di memoria per salvataggio temperatura selezionata al momento dello spegnimento.
- 3 tasti di selezione rapida (200-300-400°C).



W		
60		1 018230060

1823R/60

saldatore di ricambio per 1823 60



1823R 60		1 018230066
----------	--	-------------



1824R

punte di ricambio
per saldatore

1824R 08	1808	1 018240100
1824R 12	1812/150	1 018240301
1824R 14-M25	1814M/25	1 018240152
1824R 14-M30	1814M/30	1 018240153
1824R 14-M40	1814M/40	1 018240154
1824R 20	1820/30	1 018240302
1824R 60	1820/60	1 018240303
1824R 80	1820/80	1 018240304
1824R 120-180	1822/120 -/180	1 018240305
1824R 320	1822/320	1 018240307
1824R ST-60	1823-60	1 018240308

1825B

filo per saldatura a stagno con antiossidante

- filo da 1mm²; 250g
- Sn 99.3%; Cu 0.7%



1825B		1 018250251
-------	--	-------------

1827

saldatore a gas regolabile



1827		1 018270001
------	--	-------------

1827PC

punte di ricambio coniche per 1827

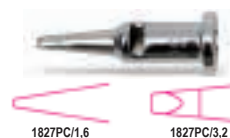

1827PC 1,6		1 018270501
1827PC 3,2		1 018270502

1827PCL

punta di ricambio a coltello per 1827



1827PCL 2,4		1 018270503
-------------	--	-------------

1827PFL

punte di ricambio a fiamma libera per 1827



1827PFL 1 018270504

1827/K

saldatore a gas con 7 accessori in valigetta con base morbida di polietilene espanso



Caratteristiche:

- Potenza: da 30 Watt a 125 Watt
- Temperatura della punta regolabile da 250°C a 500°C
- Regolatore del flusso di gas
- Tempo di riscaldamento 15 secondi dopo l'accensione
- Il serbatoio contiene gas per 120 minuti di utilizzo continuato
- Serbatoio trasparente per monitorare il livello di gas
- Ricaricabile con gas butano

1827/K 1 018270100

1827F

saldatore a gas butano ricaricabile

maxiserbatoio da 35g

- tre ugelli intercambiabili da 550°C; 1000°C e 1300°C
- fornito con cavalletto in valigetta rigida



1827F 1 018270200

1830T

pompette per dissaldare con ugello antistatico in materiale plastico (PTFE)



L
mm
190 5 018300021



1860BH/120A

saldatrice ad inverter con uscita corrente continua (DC) per saldature MMA con elettrodi rutili, basici e inox.
compatta e facile da trasportare

funzioni arcforce, hotstart, anti-sticking, protezione termostatica
corrente di regolazione: 10+120A
alimentazione: 1x230V

fattore di utilizzo (40°C) :
25% - 120 A
50% - 80 A
100% - 60 A
protezione: IP22S
elettrodi utilizzabili: Ø 1.6 - 3.2mm rutilici, basici, inox, ecc.

CE



1860BH/120A 1 018600121

1860BH/160A

saldatrice ad inverter con uscita corrente continua (DC) per saldature MMA con elettrodi rutili, basici e inox.
compatta e facile da trasportare

funzioni arcforce, hotstart, anti-sticking, protezione termostatica
corrente di regolazione: 10+160A
alimentazione: 1x230V

fattore di utilizzo (40°C) :
25% - 160 A
60% - 100 A
100% - 80 A
protezione: IP22S
elettrodi utilizzabili: Ø 1.6 - 4mm rutilici, basici, inox, ecc.

CE



1860BH/160A 1 018600161

1860BH/200A

saldatrice ad inverter con uscita corrente continua (DC) per saldature MMA con elettrodi rutili, basici e inox.
compatta e facile da trasportare

funzioni arcforce, hotstart, anti-sticking, protezione termostatica
corrente di regolazione: 10+200A
alimentazione: 1x230V

fattore di utilizzo (40°C) :
25% - 200 A
60% - 130 A
100% - 100 A
protezione: IP22S
elettrodi utilizzabili: Ø 1.6 - 4mm rutilici, basici, inox, ecc.

CE



1860BH/200A 1 018600201

1860BH R/CM

cavi massa di ricambio per saldatrici ad inverter 1860BH-120/160/200A



1860BH R/CM 1 018600612

1860BH R/CS

cavi pinza portaelettrodo di ricambio per saldatrici ad inverter 1860BH-120/160/200A



1860BH R/CS 1 018600613



1860BHT/160A

saldatrice ad inverter con uscita corrente continua (DC) per saldature ad elettrodo MMA e TIG su acciaio.
compatta e facile da trasportare

funzioni arcforce, STICK/TIG (lift arc), hotstart, anti-sticking, protezione termostatica
corrente di regolazione: 10÷160A
alimentazione: 1x230V

fattore di utilizzo (40°C) :

60% - 160 A

100% - 130 A

protezione: IP23S

elettrodi utilizzabili: Ø 1,6 - 4mm rutilici, basici, inox.

fornito con cavi da 25mm²

CE



1860BHT/160A

1 018600179

1860BHT R/CM

cavi massa di ricambio
per saldatrici TIG 1860BHT



1860BHT R/CM

1 018600616

1860BHT R/CS

cavi pinza saldatura di ricambio
per saldatrici TIG 1860BHT



1860BHT R/CS

1 018600617

1860M

morse angolari magnetiche
per saldatura
con regolazione rapida
con ganascia oscillante
ideale per bloccare particolari di differenti dimensioni

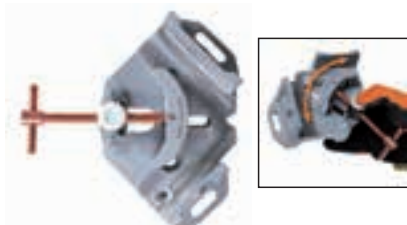

1860M

L max
mm

30

1 018600301

1860DM

dischi magnetici sollevalamiere

ideale per movimentare e fissare lamiere
forza magnetica costante su tutta la superficie del disco
manici dotati di foro per facilitare le lavorazioni in verticale



	kg max		
1860DM 16	16	1	018600310
1860DM 40	40	1	018600311

1860PMIG

pinze multuso per saldatura MIG



L mm	L1 mm		
215	44	2	018600350

1860EI

squadra magnetica 90°,
per angoli interni ed esterni.

ideale per bloccare particolari tubolari o piatti
18Kg di forza magnetica
con smussi per angoli da 30 e 60°
con foro esagonale per facilitare il distacco del magnete dal metallo



L mm	L1 mm	S mm		
165	110	35	1	018600290

1860RG

squadra magnetica regolabile 30°÷270°

ideale per bloccare particolari tubolari o piatti
15Kg di forza magnetica
chiave esagonale in dotazione per bloccaggio regolazione
angolo
perno in dotazione per bloccaggio regolazione a 30°-45°-
90°/270°-180°
con foro esagonale per facilitare il distacco del magnete dal metallo



L mm	S mm		
155	35	1	018600255

1860SQ

squadra magnetica 45°/90°

ideale per bloccare particolari tubolari o piatti
25Kg di forza magnetica
non necessita batteria, effetto ON/OFF ottenuto
con l'inclinazione dei magneti interni
pulizia da trucioli agevolata coi magneti in posizione OFF



1860SQ

1 018600210

7041LCD/4S

maschera LCD ad oscuramento automatico,
per saldatura ad elettrodo; MIG/MAG; TIG e
plasma.

4 sensori

con filtro TRUE COLOR

alimentazione a celle solari e batterie al litio
per una durata eccezionale del filtro LCD

- area di visuale 98x80 mm
- classe ottica: 1/1/1/2
- tonalità di oscuramento variabile 5÷8,5/ 9-13 con regolazione interna
- protezione UV/IR: DIN16
- tempo d'oscuramento 1/25000 s
- tempo di rischiaramento 0.1-2.0s
- sensibilità e ritardo dell'oscuramento regolabili
- accensione e spegnimento automatici
- funzione di smerigliatura
- indicatore livello basso batteria
- design ergonomico, leggera e ben bilanciata
- con ghiera regolabile



CE

7041LCD/4S

1 070410001

7041LCD/4S-VE

vetrino paragraffi esterno per 7041LCD/4S

7041LCD/4S-VE

2 070410101

7041LCD/4S-VI

vetrino interno per 7041LCD/4S

7041LCD/4S-VI

2 070410102

Beta
QUALITY TOOLS

7042LCD

maschera LCD ad oscuramento automatico, per saldatura ad elettrodo; MIG/MAG; TIG e plasma.

alimentazione a celle solari e batterie al litio per una durata eccezionale del filtro LCD

- area di visuale 98x43 mm
- tonalità di oscuramento DIN 9-13 con regolazione esterna
- protezione UV/IR
- tempo d'oscuramento 1/25000 s
- tempo di rischiaramento 0.25-1s
- sensibilità e ritardo dell'oscuramento regolabili
- accensione e spegnimento automatici
- funzione di smerigliatura
- forma ottimizzata per agevolare la respirazione a schermo abbassato



CE

7042LCD 1 070420001

7042LCD/RV

vetrino paragraffi esterno per 7042LCD, 7043

7042LCD/RV 2 070420101

7042LCD/RV-INT

vetrino interno per 7042LCD, 7043

7042LCD/RV-INT 2 070420102

7043

maschera LCD ad oscuramento automatico, per saldatura ad elettrodo, MIG/MAG, TIG e plasma.

alimentazione a celle solari.

- area di visuale 92x43 mm
- tonalità di oscuramento DIN 9-13 con regolazione esterna
- protezione UV/IR
- tempo d'oscuramento 1/1000 s
- tempo di rischiaramento 0.1-1.0 s
- ritardo dell'oscuramento regolabile
- accensione e spegnimento automatici
- funzione di smerigliatura
- forma ottimizzata per agevolare la respirazione a schermo abbassato



CE

7043 1 070430001

1870

aspiratore 20 litri per solidi e liquidi

- motore by-pass monostadio
- tensione 220/240 V
- frequenza 50/60 Hz
- potenza Max 1200 W
- portata d'aria l/sec. 58
- depressione Max 190 mbar
- capienza Max bidone 20 l in PP antistatico
- emissioni acustiche <70 dB(A)
- lunghezza cavo 5 m
- carrello porta accessori

ACCESSORI IN DOTAZIONE Ø 36 mm

- 1 tubo corrugato completo di impugnatura ergonomica
- 2 tubi rigidi di prolunga
- 1 spazzola multiuso per pavimenti e liquidi
- 1 bocchetta a lancia

SISTEMI FILTRANTI

- 1 cartuccia filtro aria superficiale 1900 cm² - 12 micron nom.
- 1 filtro anti-schiuma PPI 45/PPI 30

CE



IPX4

1870 1 018700020

1870I

aspiratore 20 litri per solidi e liquidi, bidone in acciaio INOX

- motore by-pass monostadio
- tensione 220/240 V
- frequenza 50/60 Hz
- potenza Max 1200 W
- portata d'aria l/sec. 58
- depressione Max 190 mbar
- capienza Max bidone 20 l in acciaio INOX
- emissioni acustiche <70 dB(A)
- lunghezza cavo 5 m

ACCESSORI IN DOTAZIONE Ø 36 mm

- 1 tubo corrugato completo di impugnatura ergonomica con sfiato
- 2 tubi rigidi di prolunga
- 1 spazzola multiuso per pavimenti e liquidi
- 1 bocchetta a lancia
- 1 sacco in carta

SISTEMI FILTRANTI

- 1 cartuccia filtro aria superficiale 1900 cm² - 12 micron nom.
- 1 filtro anti-schiuma PPI 45/PPI 30

CE



IPX4

1870I 1 018700220

1872L

aspiratore 35 litri per solidi e liquidi classe certificata "L"

- motore by-pass bistadio
- tensione 220/240 V
- frequenza 50/60 Hz
- potenza Max 1100 W
- portata d'aria l/sec. 55
- depressione Max 220 mbar
- capienza Max bidone 35 l in PE-HD antistatico
- emissioni acustiche <70 dB(A)
- lunghezza cavo 6 m

ACCESSORI IN DOTAZIONE Ø 36 mm

- 1 tubo corrugato completo di impugnatura ergonomica
- 2 tubi di prolunga in plastica
- 1 telaio spazzola combinata
- 1 inserto con gomme raccogli liquidi
- 1 bocchetta a lancia

SISTEMI FILTRANTI

- 1 sacco in tessuto non tessuto classe di filtraggio "L"
- 1 cartuccia filtro classificata IFA classe "L"
- 1 filtro anti-schiuma PPI 45/PPI 30
- 2 post-filtri in PET accoppiato a PP

CE



IPX4

1872L 1 018720135

1873

aspiratore 30 litri per solidi e liquidi, bidone in acciaio INOX

- motore by-pass bistadio
- tensione 220/240 V
- frequenza 50/60 Hz
- potenza Max 1100 W
- portata d'aria l/sec. 55
- depressione Max 220 mbar
- capienza Max bidone 30 l in acciaio INOX
- emissioni acustiche <61 dB(A)
- lunghezza cavo 6 m
- carrello porta accessori

ACCESSORI IN DOTAZIONE Ø 45mm

- 1 tubo corrugato completo di impugnatura ergonomica
- 2 tubi di prolunga in acciaio inox
- 1 telaio spazzola industriale
- 1 inserto industriale moquette
- 1 inserto industriale con gomme raccogli liquidi
- 1 bocchetta a lancia

SISTEMI FILTRANTI

- 1 sacco in carta filtro
- 1 cartuccia filtro superficiale 1900 cm² 12 micron nom.
- 1 filtro anti-schiuma PPI 45/PPI 30

CE



1873 30 1 018730030

1874

aspiratore 50 litri per solidi e liquidi,
bidone in acciaio INOX

- motore by-pass bistadio • tensione 220/240 V
- frequenza 50/60 Hz • potenza Max 1350 W
- portata d'aria l/sec. 55 • depressione Max 240 mbar
- capienza Max bidone 50 l in acciaio Inox
- emissioni acustiche <63 dB(A)
- lunghezza cavo 6 m
- carrello porta accessori

ACCESSORI IN DOTAZIONE Ø 45mm

- 1 tubo corrugato completo di impugnatura ergonomica
- 2 tubi di prolunga in acciaio inox
- 1 telaio spazzola industriale
- 1 inserto industriale moquette
- 1 inserto industriale con gomme raccogli liquidi
- 1 bocchetta a lancia

SISTEMI FILTRANTI

- 1 sacco in carta filtro
- 1 cartuccia filtro superficiale 5200 cm² 12 micron nom.
- 1 filtro anti-schiuma PPI 45/PPI 30

CE



1874 50

1 018740050

1875LT

lavamoquette e lavatappezzeria ad iniezione
ed estrazione

ideale per lavare in profondità superfici in tessuto.
Eroga detergente nebulizzato a pressione
e lo aspira, unitamente allo sporco,
lasciando le superfici pressochè asciutte

Accessori in dotazione:

- 1 tubo flessibile completo di impugnatura ergonomica
- 1 gruppo erogatore
- 2 prolunghe rigide
- 1 bocchetta spruzzaspira piccola
- 1 bocchetta spruzzaspira grande
- 6 ghiera blocca cavo alimentazione elettrica

CE



1875LT

1 018750000

1875SP/K3

kit spazzole
per la pulizia dei tessuti

- 1 spazzola piana Ø 48 mm
- 1 spazzola piana Ø 100 mm
- 1 spazzola semisferica Ø 90 mm
- attacco per avvitatore da 1/4"

1/4



ISO 1173 E 6,3

1875SP/K3

1 018750010

1870-20/5S

5 sacchi orizzontali in carta per
1870-1870I-1875LT



1870 20/5S

1 018700021

1870-72 /FC

filtro a cartuccia 1900 cm² 12 micron nominali
per 1870 - 1870I - 1873 - 1875LT



1870-72 /FC

1 018700026

1870-72/FL

filtro per aspirazione liquidi
per 1870 - 1870I - 1872L - 1873 - 1874 -
1875LT



1870 72/FL

1 018700027

1872L 35/FC

filtro a cartuccia classe "L"
per 1872L



1872L 35/FC

1 018720144

1872L 35/5S

5 sacchi in tessuto non tessuto classe "L"
per 1872L



1872L 35/5S

1 018720136

1873-30/5S

5 sacchi in carta verticali per 1873



1873 30/5S

1 018730031

1874-50/5S

5 sacchi verticale per 1874



1874 50/5S

1 018740051

1874-50/FC

filtro a cartuccia 5200 cm² 12 micron nominali
per 1874



1874 50/FC

1 018740056

1877

recuperatore olio esausto carrellato
con serbatoio da 90 l

- indicatore di livello
- coppa di grande diametro con griglia scolafiltro capacità 12 l
- svuotamento pneumatico del serbatoio con tubo da 1,8 m
- vaschetta portautensili

CE



1877

1 018770008



1877A

recuperatore/aspiratore olio esausto, carrellato con serbatoio da 90 l e precamera

- indicatore di livello
- coppa di grande diametro con griglia scolafiltro capacità 12 l
- precamera trasparente capacità 9,5 l
- tubo aspirazione da 1,8 m
- svuotamento pneumatico del serbatoio con tubo da 1,8 m
- vaschetta portautensili

In dotazione:

- 1 sonda rigida Ø 5x700 mm
- 1 sonda flessibile Ø 5x700 mm
- 1 sonda rigida Ø 6x600 mm
- 1 sonda flessibile Ø 6x700 mm
- 1 sonda flessibile Ø 7x700 mm
- 1 sonda flessibile Ø 8x700 mm
- adattatori per VW, BMW, CITROËN

CE



1877A

1 018770080

1877F

recuperatore olio esausto per flaconi da 1 Litro

- può accogliere fino a 4 flaconi contemporaneamente
- 2 taniche da 2 l incluse



H mm 405 L mm 270 P mm 240

1 018770100

AUTORIPARAZIONE

I nostri utensili per autoriparazione, usati dai professionisti più esigenti, sono sviluppati e prodotti per soddisfare gli standard più elevati al mondo e testati continuamente nelle condizioni di utilizzo più stressanti.

Da oltre 50 anni, siamo orgogliosamente a fianco dei più grandi campioni, che ci aiutano a migliorare costantemente i nostri prodotti e ne confermano il livello di qualità più assoluta.

Gli utensili dedicati all'autoriparazione si trovano in queste sezioni:

Diagnostica	da 1438 a 1499 da 1758VT a 1760TMC
Motore	da 955 a 989A da 1438 a 1499
Olio e filtri	da 1438 a 1499 da 1877 a 1885
Impianto elettrico	da 1438 a 1499
Avviatori	da 1498BC/12 a 1498/40A
Trasmissione	da 1438 a 1499
Sospensioni	da 1549 a 1569CP
Freni	da 1438 a 1499
Ruote	da 955 a 989A
Carrozzeria	da 1302 a 1369 da 1763 a 1767A
Altre attrezzature	da 1878 a 3067
Sollevatori	da 3029/2T a 3067/70-13T



1878 2

vaschetta per recupero liquidi

- capacità massima 2 l
- particolarmente indicata per la sostituzione olio sugli scooter



1878 2 1 2 H mm 85 1 018780002

1878 3

vaschetta per recupero olio mozzi truck scarico dell'olio con salvagoccia



1878 3 1 3 1 018780003

1878 4

vaschetta per recupero liquidi trasportabile

- indicata per moto
- capacità massima 4 l
- limita gli schizzi



1878 4 1 4 H mm 100 1 018780004

1878 8

vaschetta per recupero liquidi

- altezza idonea per moto
- capacità massima 8 l



1878 8 1 8 H mm 110 1 018780008

1878 11

vaschetta per recupero liquidi

- capacità Massima 11 l
- tappo scarico liquidi
- paratia interna per evitare la fuoriuscita dei liquidi durante il trasporto



1878 11 11 1 018780011

1878 30

vasca per recupero liquidi

- capacità Massima 30 l
- griglia anti schizzi
- dotata di 4 ruote pivotanti

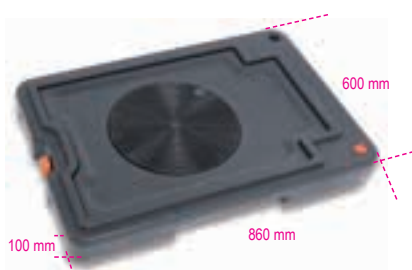

1878 30 30 1 018780030

1879

aspiratore liquidi manuale e pneumatico da 9,5 Litri



1879 1 018790001

1879 6

aspiratore liquidi manuale da 6 litri



1879 6 1 018790000

1879R/K4

kit di 4 tubi di ricambio per aspiratore liquidi 1879



1879R/K4 1 018790504

1879/FUEL

aspiratore liquidi manuale da 6 litri utilizzabile per idrocarburi



1879/FUEL 6 1 018790010

1880

pompa manuale per fusti olio

- per olio
- non usare con liquidi a base acquosa, solventi acidi, gasolio, benzina e simili
- completa di attacco fusto, tubo telescopico e beccuccio di mandata
- utilizzabile con fusti da 60, 100 e 200 Litri



1880 gr 240 1 018800001

1880ADB

pompa rotativa per AdBlue®

- 5 litri erogati ogni venti rotazioni
- prolunghe per fusti fino a 1,20 m
- 1 attacco per fusti passo fine
- 1 attacco per fusti passo grosso



1880ADB 1 018800101

1881

pompa pneumatica per fusti olio rapporto 3:1

- pressione di lavoro da 6 a 8 bar
- consumo aria 230 l/min
- per olio
- non usare con liquidi a base acquosa, solventi acidi, gasolio, benzina e simili
- completa di attacco fusto e tubo telescopico

CE



1881 l/min 18 1 018810001

1882

pistola olio con estremità flessibile e salvagocia automatico

- attacco 1/2"
- portata massima 35 l/min
- pressione massima di esercizio 100 bar
- possibilità di bloccare la leva di erogazione



1882 1 018820010

1883

contaltri digitale per olio

- attacco 1/2"
- rivestimento in gomma anti urto
- pila 1 CR2 (inclusa)
- portata Max: 0+35 l/min (0+9 gal/min)
- pressione Max: 50 bar (750 psi)
- viscosità: 8+5000 mPas
- tolleranza: ±0,5%

CE



1883 1 018830035

1883NC

niple maschio-maschio 1/2 per unire art. 1882 e 1883



1883NC 1 018830135

1884

attrezzo per l'inserimento di olio nei cambi manuali, automatici e nei differenziali

con 12 adattatori per la connessione diretta



1884

1 018840010

AT-101	FORD
AT-102	UNIVERSAL (Bmw, Honda, Nissan...)
AT-103	VW-AUDI
AT-104	VW-AUDI-PORSCHE
AT-105	VW-AUDI-MINI COOPER
AT-106	MERCEDES
AT-107	DSG
AT-108	VW-AUDI CVT
AT-109	VOLVO
AT-110	TOYOTA-LEXUS
AT-111	SKODA
AT-112	VW Passat/Tiguan <2007

1884/C12

cassetta di 12 adattatori per 1884

• inclusa nel 1884



1884/C12

1 018840100

1884N/C8

kit 8 adattatori per 1884

inclusi nel kit:

- 1 adattatore per Infiniti 7 marce M8x1.0
- 1 adattatore per Honda, Hyundai, Kia 5x8x200 mm
- 1 adattatore per Skoda M18x1.5
- 1 adattatore per Mini M14x1.5
- 1 adattatore per Nissan M10x1.5
- 1 adattatore per Nissan Juke M12x1.25
- 1 adattatore per GM M12x1.75
- 1 adattatore per gruppo VAG 7 marce



1884N/C8

1 018840200

200x145x40 mm - 400 g

1889

base in acciaio per movimentazione e stoccaggio di 2 fusti da 200 l

- verniciata completamente a caldo a polvere epossidica
- facilmente trasportabile con carrello elevatore a forche o transpallet
- supporto non sovrapponibile



1889

1 018890200

1889CF

chiave universale per apertura fusti

- 1 esagono femmina Ø 38 mm
- 1 profilo a 4 settori Ø 42 mm
- 1 lama 17x7 mm



L
mm
270

1 018890010

1885

stazione per la manutenzione del cambio automatico

Permette di effettuare in totale sicurezza, con una procedura semplice e guidata, l'intero ciclo di lavaggio e sostituzione olio in tutte le trasmissioni automatiche.

Previene il danneggiamento derivante dall'usura dell'olio contenuto nel cambio automatico, prevenendo in modo pratico e veloce malfunzionamenti caratteristici come: rumorosità eccessiva del cambio, marce bloccate, bruschi innesti delle marce, allungamento dei tempi di cambiata



CE



Caratteristiche funzionali:

- Funzionamento automatico
- Procedura guidata passo dopo passo con banca dati integrata
- Compensazione della quantità dell'olio immesso garantendo la presenza costante della corretta quantità
- Stampa di ogni operazione effettuata
- Cassetto con adattatori per i cambi più diffusi in modulo morbido

Caratteristiche automatiche:

- Immissione solvente (facoltativo)
- Lavaggio impianto cambio
- Svuotamento olio coppa
- Svuotamento olio convertitore
- Immissione olio convertitore

Caratteristiche tecniche:

- Alimentazione 220 V 50 Hz
- Visori olio retroilluminati con 2 LED luce bianca
- 2 bilance elettroniche
- Bilance elettroniche risoluzione +/- 10g
- Scheda elettronica con display grafico retroilluminato

1885

1 018850010

 **Beta**

 **Beta**

1885/C1

kit raccordi cambio automatico per 1885
(non inclusi in 1885)

il kit include:

- 1885/C1-R1 raccordi cambio Land Rover Freelander
- 1885/C1-R2 raccordo cambio DP0
- 1885/C1-R3 raccordo cambio ZF 9HP
- 1885/C1-R4 asta di livello cambio ZF 9HP
- 1885/C1-R5 asta di livello cambio Mercedes
- 1885/C1-R6 raccordi cambio AISIN TG82
- 1885/C1-R7 raccordi cambio AISIN TG81
- 1885/C1-R8 raccordi cambio Renault-Nissan



1885/C1

1 018850110

1885/C1-R1

raccordi cambio Land Rover Freelander per
1885

Ic01430



1885/C1-R1

1 018850111

1885/C1-R2

raccordo cambio DP0 per 1885

Ic0990



1885/C1-R2

1 018850112

1885/C1-R3

raccordi cambio ZF 9HP per 1885

Ic0992



1885/C1-R3

1 018850113

1885/C1-R4

asta di livello cambio ZF 9HP per 1885

Ic0192



1885/C1-R4

1 018850114

1885/C1-R5

asta di livello cambio Mercedes per 1885

K-A-M



1885/C1-R5

1 018850115

1885/C1-R6

raccordi cambio AISIN TG82 per 1885

Ic01820



1885/C1-R6

1 018850116

1885/C1-R7

raccordi cambio AISIN TG81 per 1885

Ic0150



1885/C1-R7

1 018850117

1885/C1-R8

raccordi cambio Renault-Nissan per 1885

Ic02150



1885/C1-R8

1 018850118

1885/C2

kit raccordi cambio automatico per 1885
(non inclusi in 1885)

il kit include:

- 1885/C2-R1 raccordi cambio Audi 8HP
- 1885/C2-R2 raccordi cambio ZF 9HP senza scambiatore
- 1885/C2-R3 raccordo cambio Audi 0KC
- 1885/C2-R4 raccordi cambio AG4-ZF 4HP
- 1885/C2-R5 raccordi cambio FIAT
- 1885/C2-R6 raccordi cambio Audi Q5-Q7
- 1885/C2-R7 raccordo Audi cambio 0B5



1885/C2

1 018850120

1885/C2-R1

raccordi cambio Audi 8HP per 1885

Ic0993



1885/C2-R1

1 018850121

1885/C2-R2

raccordi cambio ZF 9HP
senza scambiatore per 1885

Ic0990



1885/C2-R2

1 018850122

1885/C2-R3

raccordo cambio Audi 0KC per 1885

Ic02020



1885/C2-R3

1 018850123

1885/C2-R4

raccordi cambio AG4-ZF 4HP per 1885

Ic0750



1885/C2-R4

1 018850124

1885/C2-R5

raccordi cambio FIAT per 1885

Ic0061



1885/C2-R5

1 018850125

1885/C2-R6

raccordi cambio Audi Q5-Q7 per 1885

Ic0680



1885/C2-R6

1 018850126

1885/C2-R7

raccordo cambio Audi 0B5 per 1885

Ic01720



1885/C2-R7

1 018850127

1885/C3

kit raccordi cambio automatico per 1885 (non inclusi in 1885)

il kit include:

- 1885/C3-R1 raccordo cambio DSG Mercedes
- 1885/C3-R2 raccordo cambio POWERSHIFT
- 1885/C3-R3 raccordi cambio Toyota IQ
- 1885/C3-R4 raccordi cambio Mazda
- 1885/C3-R5 raccordi cambio Renault Laguna-Esp
- 1885/C3-R6 raccordi cambio Nissan Juke
- 1885/C3-R7 raccordi cambio AISIN TF71 FV
- 1885/C3-R8 raccordi cambio AISIN TF71 FP
- 1885/C3-R9 raccordi cambio AISIN TF71 FO
- 1885/C3-R10 raccordi cambio AISIN TF71 FS



1885/C3

1 018850130

1885/C3-R1

raccordo cambio DSG Mercedes per 1885

Ic0191



1885/C3-R1

1 018850131

1885/C3-R2

raccordo cambio POWERSHIFT per 1885

Ic0190



1885/C3-R2

1 018850132

1885/C3-R3

raccordi cambio Toyota IQ per 1885

Ic0991



1885/C3-R3

1 018850133

1885/C3-R4

raccordi cambio Mazda per 1885

Ic02130



1885/C3-R4

1 018850134

1885/C3-R5

raccordi cambio Renault Laguna-Esp per 1885

Ic02150



1885/C3-R5

1 018850135

1885/C3-R6

raccordi cambio Nissan Juke per 1885

Ic02140



1885/C3-R6

1 018850136

1885/C3-R7

raccordi cambio AISIN TF71 FV per 1885

Ic01420



1885/C3-R7

1 018850137

1885/C3-R8

raccordi cambio AISIN TF71 FP per 1885

Ic001420/1



1885/C3-R8

1 018850138

1885/C3-R9

raccordi cambio AISIN TF71 FO per 1885

Ic001420/2



1885/C3-R9

1 018850139

1885/C3-R10

raccordi cambio AISIN TF71 FS per 1885

Ic001420/3



1885/C3-R10

1 018850140

1885/XC60

raccordi cambio Volvo XC60 per 1885



1885/XC60

1 018850151

1893/134A

stazione automatica di ricarica climatizzatori gas R134a

Modello completamente automatico, con banca dati auto/autocarri con quantità gas, quantità e tipo olio compressore, software di autodiagnosi per operazioni di manutenzione ordinaria.

La banca dati è aggiornabile via software

La macchina può operare in modalità manuale (con presidio umano fase per fase)

oppure in modalità completamente automatica (senza presidio).



R134A (250 ml)

CARATTERISTICHE FUNZIONALI

Funzionamento automatico

Banca dati auto/autocarri con quantità gas, quantità e tipo olio compressore

Recupero automatico del gas dalla tubazione

Compensazione della ricarica della quantità di gas contenuto nelle tubazioni

Scarico automatico dei gas non condensabili

Segnalazione automatica di anomalie e manutenzione

Manometri ø 80 mm

Vacuometro digitale

CARATTERISTICHE TECNICHE

Serbatoio gas: 15 kg

Pompa vuoto: 140 l/min

Bilancia elettronica: 50kg

Scheda elettronica con display retroilluminato

Velocità di recupero: 500 g/min

Alimentazione: 220 V

1893/134A

1 018930001

1893/1234YF

stazione automatica di ricarica climatizzatori gas R1234yf

Modello completamente automatico, con banca dati auto/autocarri con quantità gas, quantità e tipo olio compressore, software di autodiagnosi per operazioni di manutenzione ordinaria. La banca dati è aggiornabile via software. La macchina può operare in modalità manuale (con presidio umano fase per fase), oppure in modalità completamente automatica (senza presidio).



1234YF (250 ml)

CARATTERISTICHE FUNZIONALI

Funzionamento automatico
Banca dati auto/autocarri con quantità gas, quantità e tipo olio compressore
Recupero automatico del gas dalla tubazione
Compensazione della ricarica della quantità di gas contenuto nelle tubazioni
Scarico automatico dei gas non condensabili
Segnalazione automatica di anomalie e manutenzione
Manometri \varnothing 80 mm
Vacuometro digitale

CARATTERISTICHE TECNICHE

Serbaio gas: 15 kg
Pompa vuoto: 140 l/min
Bilancia elettronica: 50 kg
Scheda elettronica con display retroilluminato
Velocità di recupero: 500 g/min
Alimentazione: 220 V

1893/1234YF

1 018930012

1893TR/134A

tracciante per gas R134a



1893TR/134A

ml
250

1 018930901

1893TR/1234YF

tracciante per gas R1234yf



1893TR/1234YF

ml
250

1 018930902

1893TR/CI

tracciante per compressori ibridi



1893TR/CI

ml
250

1 018930903

1895G

generatore di comando per elettroiniettori (benzina e GPL) ed elettrovalvole

Permette di testare in completa autonomia l'efficienza di componenti come:

- elettrovalvole EGR
- elettroiniettori di motori benzina e GPL
- elettrovalvole regolazione turbina a geometria variabile
- compressori per climatizzatori di nuova generazione



Caratteristiche tecniche

Comando iniettori benzina e GPL

- Numero uscite: 4
- Durata test: 1-60 s
- Tempo apertura: 5-10 ms
- Regolazione frequenza impulso: 1-10 Hz

Comando dispositivi PWM

- Numero uscite: 1
- Durata test: 1-60 min
- Automatico o manuale
- Regolazione duty cycle: 10%-85%
- Regolazione frequenza segnale: 120-250 Hz

1895G

1 018950800

1895/S

supporto regolabile per vasche ultrasuoni 1895

Permette il corretto posizionamento degli iniettori durante la fase di lavaggio all'interno della vasca ultrasuoni. Compatibile con i modelli di vasche da 6, 13, 27 litri

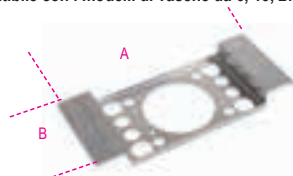

1895/S

A mm
340

B mm
140

1 018950501

1895 6

vasca di lavaggio ad ultrasuoni da 6 litri

con funzione speciale di degassificazione



Caratteristiche:

- Attraverso il riscaldamento del liquido e con l'azione degli ultrasuoni permette di pulire efficacemente parti di ricambio e pezzi metallici in genere (iniettori, carburatori, valvole, ecc...)
- Display digitale con regolazione della temperatura e del tempo di lavaggio
- Doppia funzione lavaggio: "soft" e "normal"
- Per una pulizia generale è sufficiente usare acqua ad una temperatura di 50/60°C
- Per una pulizia più accurata aggiungere soluzioni detergenti non schiumogene specifiche per vasche ad ultrasuoni
- La funzione degassificazione accelera la liberazione d'aria in tutto il volume della vasca aumentando l'efficacia degli ultrasuoni

Dati tecnici:

- Capacità vasca: 6 litri
- Rubinetto di scarico
- Potenza: 150 Watt
- Potenza di riscaldamento: 300 Watt
- Regolazione temperatura: 0+80°C
- Regolazione tempo di lavaggio: 0-99 minuti
- Frequenza: 40 kHz
- Alimentazione: 220/230V
- Dimensioni: 330x180x310 mm
- Dimensioni serbatoio: 300x155x150 mm
- Dimensioni cestello: 250x105x100 mm
- Portata massima: 5,5 kg

1895 6

Max
5,5

1 018950060

1895 13

vasca di lavaggio ad ultrasuoni da 13 litri

con funzione speciale di degassificazione



Caratteristiche:

- Attraverso il riscaldamento del liquido e con l'azione degli ultrasuoni permette di pulire efficacemente parti di ricambio e pezzi metallici in genere (iniettori, carburatori, valvole, ecc...)
- Display digitale con regolazione della temperatura e del tempo di lavaggio
- Doppia funzione lavaggio: "soft" e "normal"
- Per una pulizia generale è sufficiente usare acqua ad una temperatura di 50/60°C
- Per una pulizia più accurata aggiungere soluzioni detergenti non schiumogene specifiche per vasche ad ultrasuoni
- La funzione degassificazione accelera la liberazione d'aria in tutto il volume della vasca aumentando l'efficacia degli ultrasuoni

Dati tecnici:

- Capacità vasca: 13 litri
- Rubinetto di scarico
- Potenza: 300 Watt
- Potenza di riscaldamento: 400 Watt
- Regolazione temperatura: 0+80°C
- Regolazione tempo di lavaggio: 0-99 minuti
- Frequenza: 40 kHz
- Alimentazione: 220/230V
- Dimensioni: 350x325x320 mm
- Dimensioni serbatoio: 325x235x145 mm
- Dimensioni cestello: 257x185x100 mm
- Portata massima: 12 kg

1895 13

Max
12

1 018950130

1895 27

vasca di lavaggio ad ultrasuoni
da 27 litri

con funzione speciale di degassificazione



CE

Caratteristiche:

- Attraverso il riscaldamento del liquido e con l'azione degli ultrasuoni permette di pulire efficacemente parti di ricambio e pezzi metallici in genere (iniettori, carburatori, valvole, ecc...)
- Display digitale con regolazione della temperatura e del tempo di lavaggio
- Doppia funzione lavaggio: "soft" e "normal" - per una pulizia generale è sufficiente usare acqua ad una temperatura di 50/60°C
- Per una pulizia più accurata aggiungere soluzioni detergenti non schiumogene specifiche per vasche ad ultrasuoni
- La funzione degassificazione accelera la liberazione d'aria in tutto il volume della vasca aumentando l'efficacia degli ultrasuoni

Dati tecnici:

- Capacità vasca: 27 litri
- Rubinetto di scarico
- Potenza: 500 Watt
- Potenza di riscaldamento: 500 Watt
- Regolazione temperatura: 0÷80°C
- Regolazione tempo di lavaggio: 0-99 minuti
- Frequenza: 40 kHz
- Alimentazione: 220/230V
- Dimensioni: 530x330x380 mm
- Dimensioni serbatoio: 500x300x200 mm
- Dimensioni cestello: 450x250x150 mm
- Portata massima: 25 kg

1895 27 Max 25 1 018950270

1895/RC

cestello per vasche ad ultrasuoni 1895



	L mm	L1 mm	A mm	
1895/RC6	250	105	100	1 018950506
1895/RC13	257	185	100	1 018950513
1895/RC27	450	250	150	1 018950527

9881U



9881U 1 (1-2) 526
9881U 1 (3) 526

9882R



9882R 1 (1-2) 526
9882R 1 (3) 526

1897

sabbiatrice da banco professionale

Particolarmente indicata per operazioni di finitura superficiale di vari materiali (metallo, plastica, vetro, ceramica, legno, ecc...). La cabina è realizzata in lamiera di acciaio con opportuni rinforzi per assicurare la massima robustezza e stabilità.

La cabina è dotata di:

- porta di carico con chiusura a magneti
- piano in lamiera forata
- attacco standard per aspiratori \varnothing 36 mm
- finestra di visualizzazione in policarbonato protettivo da 6 mm
- illuminazione con lampada a LED
- circuito pneumatico (entrata aria compressa)
- pistola di sabbatura con funzionamento a grilletto



CE

DATI TECNICI

Dimensioni utili cabina: 600x520x320 mm
Dimensioni di ingombro: 660x530x500 mm
Peso: 38 kg
Piano lavoro: lamiera forata
Illuminazione: LED
Consumo aria: 340 l/min a 7 atm
Alimentazione: 220 V - 50 Hz

1897 1 018970066

1897/CRB

corindone per sabbiatrice 1897 in sacco da 25 kg



1897/CRB 1 018970101

1897/G

garnet per sabbiatrice 1897 in sacco da 25 kg



1897/G 1 018970104

1897/MV

microsfere di vetro per sabbiatrice 1897 in sacco da 25 kg



1897/MV 1 018970103

1898/K40

vasca manuale per la pulizia di pezzi meccanici a ricircolo con liquido riscaldato e batteri.

- permette l'eliminazione dei costi di smaltimento per solventi o idrocarburi
- utilizzando il detergente ecologico Beta a base di enzimi e batteri permette la rimozione e lo smaltimento dei vari residui oleosi presenti sui pezzi meccanici
- la funzione enzimatica aiuta a scindere la parte oleosa dalla parte solida di sporco mentre i batteri trasformano la stessa in anidride carbonica e acqua rigenerando costantemente il detergente



CE

Dotata di:

- Spazzola a setole lunghe e tubazione di collegamento
- Predisposizione per utilizzo destrorso e sinistrorso
- Griglia forata in acciaio inox
- Ruote con freno
- Scheda con display per visualizzazione temperatura di funzionamento e avviso livello troppo basso

Include:

- N° 2 taniche di liquido detergente ecocompatibile da 20 litri e n° 2 confezioni di batteri

Dati tecnici:

- Portata massima pompa: 10 litri/minuto
- Capacità serbatoio: 40 litri
- Temperatura di funzionamento: +5°C ÷ +40°C
- Dimensioni: 900 x 1000 x 750 mm
- Dimensioni interne vasca: 710 x 370 x 200 mm
- Peso: 50 kg a vuoto

Attenzione:

- Per garantire il ciclo di vita dei batteri la vasca deve essere costantemente sotto tensione.

1898/K40 1 018980004

ATTENZIONE:

Paesi in cui possibile distribuire il prodotto 1898/K40 sono: Austria, Belgio, Francia, Italia, Paesi Bassi, Polonia, Portogallo, Regno Unito, Spagna, Ungheria

1898/B

flacone di batteri da 400 ml per vasca lava pezzi 1898/K40



1898/B 1 018980904



ATTENZIONE:

Paesi in cui è possibile distribuire il prodotto 1898/B sono: Austria, Belgio, Francia, Italia, Paesi Bassi, Polonia, Portogallo, Regno Unito, Spagna, Ungheria

1898/D

tanica di liquido detergente ecocompatibile da 20 litri per vasca lava pezzi 1898/K40



1898/D   1 018980920

ATTENZIONE:

Paesi in cui è possibile distribuire il prodotto 1898/D sono: Austria, Belgio, Francia, Italia, Paesi Bassi, Polonia, Portogallo, Regno Unito, Spagna, Ungheria

1898/M

nebulizzatore a pressione con serbatoio da 2 Litri

- ugello regolabile per getto lineare o nebulizzato
- scala graduata da 0,5l - 1l - 1,5l - 2l
- leva con blocco per getto continuo
- non utilizzabile con idrocarburi



H mm   340 l 2 1 018980930

1898/S

pompa manuale a pressione con serbatoio da 5 Litri

- lancia in acciaio inossidabile
- leva con blocco per getto continuo
- ugello regolabile per getto lineare o nebulizzato
- comoda tracolla per il trasporto
- maniglia con aggancio per la lancia
- tubo flessibile da 1,2 m
- non utilizzabile con idrocarburi



H mm   415 l 5 1 018980932

1899A

macchina per pulizia sistemi DPF e FAP®

Mediante l'utilizzo di appositi detergenti è possibile pulire periodicamente e ripristinare sistemi DPF e FAP® compromessi da accumuli di fuliggine e cenere. I risultati sono verificabili mediante autodiagnosi, dove si possono leggere i valori di massa fuliggine e di pressione differenziale nel filtro antiparticolato prima e dopo il trattamento.





In dotazione:

- 1 tubo di mandata lungo 2 m
- 1 raccordo a innesto rapido + portagomma per tubazioni sensore differenziale
- 1 nipler M18x1,5 con portagomma per collegamento diretto con sonda Lambda
- 1 tubo prolunga
- 1 spruzzatore per DPF e FAP®
- 1 supporto magnetico per tubo
- 1 tubo per DPF e FAP® con pressacavo di regolazione più nipler M14/16/18 mm per collegamento con sonde Lambda

Caratteristiche tecniche:

- Tensione di utilizzo 12 V
- Lunghezza cavi di alimentazione 3,9 m
- Capacità serbatoio 1 l

1899A   1 018990010

1899SI

macchina 2in1 per la pulizia degli iniettori e del collettore di aspirazione

mediante l'utilizzo di appositi detergenti è possibile pulire periodicamente gli iniettori in motori diesel, benzina e GPL ed il collettore di aspirazione in motori diesel e benzina, eliminando i depositi carboniosi ed i residui della combustione



Caratteristiche tecniche:

- Tensione di utilizzo 12 V
- pressione d'esercizio programmabile
- tempi di nebulizzazione programmabili
- 2 tubi di servizio con raccordi a presa rapida per sistemi d'iniezione
- 1 attacco con raccordo a presa rapida per collettore di aspirazione
- 2 serbatoi (capacità 1 l/cad)
- kit di raccordi universali per sistemi d'iniezione in pratica valigetta

1899SI   1 018990030

2080/VG

portaminuteria in ABS con vassoi girevoli

- Dotato di un contenitore portaminuteria superiore (diametro 145 mm) e 4 vassoi girevoli:
 - 1 diametro 305 mm
 - 3 diametro 445 mm
- Fornito completo di 12 divisori applicabili all'interno dei 3 vassoi girevoli grandi per ottenere fino a 8 scompartimenti per piano





2080/VG   1 020800100

445x445x550 mm - 3,4 kg

2250-0

seggolino girevole con vassoio





2250-0   1 022500011

2252

seggolino con rotelle





2252-G   1 022520002

2252KR4

4 ruote di ricambio seggiolino 2252



2252KR4   1 022520900

2258-O

seggolino con cassettera



2258-O 1 022580011

2254A

teli copriauto da esterno,
idrorepellenti e resistenti ai raggi UV

questi teli sono ottimi per proteggere i veicoli
incidentati in attesa di riparazione

caratteristiche tecniche

- finitura esterna con trattamento di protezione raggi UV
- finitura interna morbida antigraffio
- 6 laccetti di regolazione per rendere il telo aderente alla vettura
- 2 cerniere in corrispondenza delle porte anteriori per permettere di accedere al veicolo senza dover rimuovere il telo
- sedi per gli specchietti
- catarifrangenti



Disponibile in 3 misure:

- M indicata per utilitarie
- L indicata per berline e station wagon
- XL indicata per SUV

	LxPxH mm	
/M	4400x1450 x1300	1 022540002
/L	5300x1450x1150	1 022540000
/XL	4700x1450x1580	1 022540001

2254C

protezione a ventosa per carrozzeria veicoli

In tessuto plastificato con 4 ventose sul lato superiore



2254C 1 022540200

2254F

protezione anteriore auto

Permette di proteggere la parte frontale del veicolo lasciando le aperture per i fari e il radiatore



- Lavabile
- Impermeabile e resistente ad oli e grassi
- Fissaggio tramite lacci
- Materiale: 98% poliammide/nylon, 2% poliuretano

2254F 1 022540150

2254K

protezione riutilizzabile per sedile, volante
e pomello del cambio

adatta alla maggior parte dei sedili, volanti
e pomelli dei cambi di autoveicoli



2254K 1 022540101

2254SM

tappeto sottomacchina
in EVA

doppia finitura:

- 1 lato in morbido EVA
- 1 lato in carbon look rigido per favorire lo scivolamento



2254SM 1 022540033

2254T

tappeto per protezione ginocchia

Realizzato in EVA antiscivolo



2254T 1 022540047

3000L

lettino sottomacchina

- Rivestimento in PVC con imbottitura in gomma piuma per un elevato comfort.
- Inclinazione cuscino: 30°

**REGOLAZIONE
DEL CUSCINO
TRAMITE PISTONE
A MOLLA PROGRESSIVA**

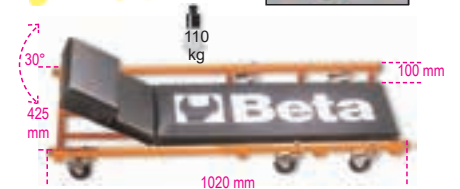

3000L 1 030000210

3000L/RLS

ruota di ricambio lettino sottomacchina



3000L/RLS 6 030000212

3002

lettino sottomacchina e seggolino

- struttura in acciaio
- rivestimento in PVC con imbottitura
- possibilità di regolare la posizione rapidamente: lettino o seggolino

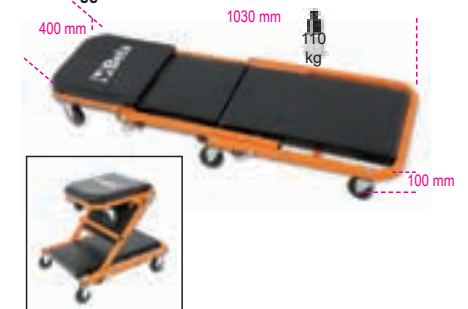

3002 1 030020001

3002/RLS

6 ruote di ricambio per lettino sottomacchina.
3002



3002/RLS 1 030020051

3003

lettino sottomacchina
in plastica antiurto

- Ø ruote: 76 mm



3003 1 030030001

3003/RLS

6 ruote di ricambio per
lettino sottomacchina 3003



3003/RLS 1 030030501

3003C

lettino sottomacchina in plastica antiurto

- Dotato di:
- cuscino per la testa e per la zona lombare con finitura in carbon look
 - piastrine superiori in metallo per il fissaggio di accessori magnetici
 - 6 ruote in gomma con diametro 79 mm
 - Portata max. 120 Kg
 - Peso 5,5 Kg



3003C 1 030030100

3003C/RLS

6 ruote di ricambio per
lettino sottomacchina 3003C



3003C/RLS 1 030030600

3003PRO

lettino sottomacchina in materiale plastico
antiurto

- Dotato di:
- cuscino poggiatesta ergonomico
 - protezione morbida per la schiena
 - 2 ruote da 178 mm con doppio cuscinetto che permettono l'utilizzo anche su superfici sconnesse e il superamento di tubi/cavi
 - 1 ruota girevole
 - doppia regolazione dell'altezza da terra: 38 o 76 mm
 - 2 lampade a led portatili da 250 lumen con magneti per fissaggio
 - capacità di carico: 200 kg
 - peso: 7,7 kg



C max	H min	H Max	H1
kg	mm	mm	mm
200	170	230	230

3003PRO 1 030030150

3003PRO/SP

supporto in plastica da parete per lettino
3003PRO

Può essere applicato su una parete, ponte, cassettera o altro permettendo il fissaggio del lettino attraverso un sistema rapido e veloce con chiusura di sicurezza.



3003PRO/SP 1 030030151

3003PRO/PM

portaminuterie magnetico tondo per lettino
3003PRO

applicandolo sul cerchio delle ruote del lettino
permette il trattamento delle minuterie durante gli interventi



3003PRO/PM 1 030030152

3003PRO/RCR

coppia ruote di ricambio posteriori per
lettino sottomacchina 3003PRO



3003PRO/RCR 1 030030650

3003PRO/RRG

ruota di ricambio girevole anteriore per
lettino sottomacchina 3003PRO



3003PRO/RRG 1 030030651

3003PRO/RT

lampada a led con magneti di ricambio
per lettino sottomacchina 3003PRO

- 250 lumen
- pile : 4xAAA non incluse



3003PRO/RT 1 030030652

3004

cuneo fermaruota

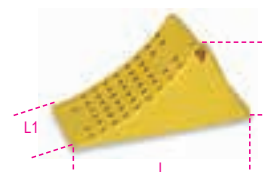

	H	L	L1
	mm	mm	mm
3004	225	475	200

3004 1 030040000



Beta

AUTORIPARAZIONE

I nostri utensili per autoriparazione, usati dai professionisti più esigenti, sono sviluppati e prodotti per soddisfare gli standard più elevati al mondo e testati continuamente nelle condizioni di utilizzo più stressanti.

Da oltre 50 anni, siamo orgogliosamente a fianco dei più grandi campioni, che ci aiutano a migliorare costantemente i nostri prodotti e ne confermano il livello di qualità più assoluta.

Gli utensili dedicati all'autoriparazione si trovano in queste sezioni:

Diagnostica	da 1438 a 1499 da 1758VT a 1760TMC
Motore	da 955 a 989A da 1438 a 1499
Olio e filtri	da 1438 a 1499 da 1877 a 1885
Impianto elettrico	da 1438 a 1499
Avviatori	da 1498BC/12 a 1498/40A
Trasmissione	da 1438 a 1499
Sospensioni	da 1549 a 1569CP
Freni	da 1438 a 1499
Ruote	da 955 a 989A
Carrozzeria	da 1302 a 1369 da 1763 a 1767A
Altre attrezzature	da 1878 a 3067
Sollevatori	da 3029/2T a 3067/70-13T



3006

sollevatore e posizionario ruote trattori ed escavatori

- portata massima 1500 kg
- diametro ruota minimo 1000 mm
- diametro ruota massimo 2200 mm
- spessore ruota massimo 800 mm

CE



3006

1 030060000

3006 R/RG

ruota girevole con freno di ricambio per sollevatore e posizionario ruote 3006



3006 R/RG

1 030060501

3006 R/RG

ruota girevole di ricambio per sollevatore e posizionario ruote 3006



3006 R/RG

1 030060502

3007

carrello sottoscocca per veicoli senza meccanica anteriore/posteriore

- per movimentare agevolmente i veicoli privi di avantreno o retrotreno durante le fasi di lavorazione
- 4 ruote pivotanti, di cui 2 con freno, adatte all'uso in forno di verniciatura
 - 2 supporti scorrevoli per adattarsi a tutti i telai
 - portata massima 800 kg

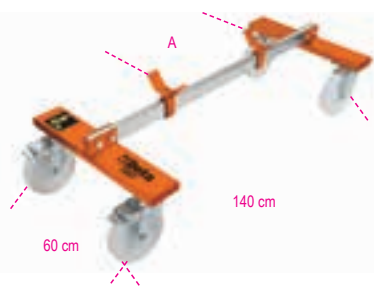

3007

A Max
mm
110

1 030070001

3007 R/RG

ruota girevole con freno di ricambio per carrello sottoscocca per veicoli 3007



3007 R/RG

1 030070501

3007 R/RG

ruota girevole di ricambio per carrello sottoscocca per veicoli 3007



3007 R/RG

1 030070502

3008

sollevatore e posizionario ruote Truck singole e gemellari

- portata massima 800 kg
- altezza minima 140 mm
- altezza massima 660 mm
- interasse rulli 470÷740 mm
- sicurezza idraulica in caso di sovraccarico
- ruote anteriori pivotanti

CE



3008

1 030080100

3009

carrello per movimentazione veicoli

- portata Max 550 kg
- 4 rulli basculanti
- larghezza rulli 200 mm
- per ruote fino a 240 mm di larghezza



A
400+850 mm

B
600 mm

1 030090001

3009R/GR4

gruppi 4 ruote carrelli 3009 R/GR4



3009R/GR4

1 030090501

3010/T...

coppia cavalletti

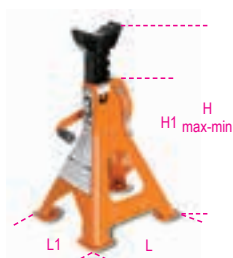

C max	H min	H Max	H1	L	L1
kg	mm	mm	mm	mm	mm
2000	280	425	245	185	165

3010T 2

1 030100002

C max	H min	H Max	H1	L	L1
kg	mm	mm	mm	mm	mm
3000	285	430	250	180	195

3010T 3

1 030100003

C max	H min	H Max	H1	L	L1
kg	mm	mm	mm	mm	mm
6000	400	580	340	245	280

3010T 6

1 030100006

C max	H min	H Max	H1	L	L1
kg	mm	mm	mm	mm	mm
10000	471	735	420	330	290

3010T 10

1 030100010

3011/T

solleventori idraulici a bottiglia

CE



C max	H min	H Max	L
kg	mm	mm	mm
3500	170	366	86

3011T 3.5

1 030110035

C max	H min	H Max	L
kg	mm	mm	mm
5000	203	467	118

3011T 5

1 030110050

C max	H min	H Max	L
kg	mm	mm	mm
10000	220	484	114

3011T 10

1 030110100

C max	H min	H Max	L
kg	mm	mm	mm
15000	230	497	113

3011T 15

1 030110150

C max	H min	H Max	L
kg	mm	mm	mm
20.000	245	521	115

3011T 20

1 030110200

3010H

cavalletti serie pesante



C Max	H min	H Max	L	L1
kg	mm	mm	mm	mm
15.000	445	631	300	300

3010H 750

1 030100150

C Max	H min	H Max	L	L1
kg	mm	mm	mm	mm
15.000	645	1077	300	300

3010H 1100

1 030100165

3010V

cavalletti serie pesante
con regolazione a vite



C Max	H min	H Max	L	L1
kg	mm	mm	mm	mm
20.000	410	600	330	330

3010V 680

1 030100200

C Max	H min	H max	L	L1
kg	mm	mm	mm	mm
20.000	665	1090	460	460

3010V 1170

1 030100220

3012

staffe sostegno motore



L	C max
mm	kg
1500	500
1800	400

3012C

staffa sostegno motore inferiore

ideale per auto e veicoli commerciali



3012C

1 030120255

3012I

staffa sostegno motore inferiore

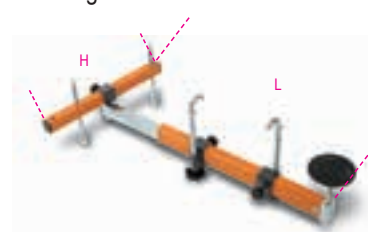

L	H
mm	mm
3012I 630÷960	190



3014

cavalletto sostegno motore



3014

1 030140010

3014R/GR5

5 ruote di ricambio per cavalletto sostegno motore 3014



3014R/GR5

1 030140501

3014 SAR

cavalletto sostegno motore richiudibile

- facilmente richiudibile con notevole riduzione degli ingombri
- permette la rotazione di 360° del motore o del cambio
- garantisce la massima sicurezza e stabilità durante gli interventi

Portata massima: 450 kg



3014SAR

1 030140360

3014SAR/RR

4 ruote di ricambio per cavalletto sostegno motore 3014SAR



3014SAR/RR

1 030140370

3014SAR/1

vasca di raccolta liquidi per 3014 SAR

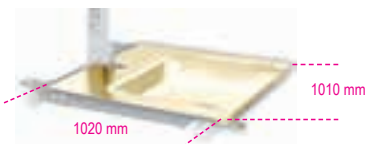

3014SAR/1

1020x1010x11 mm

1 030140361

3014SAR/2

stessa per il fissaggio della trasmissione sul cavalletto 3014 SAR

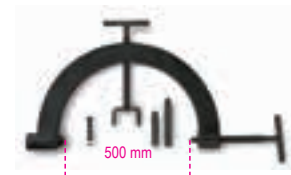

3014SAR/2

1 030140362

3023

sostegno da fossa e sottoponte con regolazione a vite

portata massima 350 kg



H	Ø
min-Max mm	mm
1350+2030	300

1 030230050

3025

gru idraulica pieghevole con pompa a doppio effetto
Portata massima 1 t



H	P	L	L1
mm	mm	mm	mm
1650	1560	1000	835

1 030250001

3025/RF

2 ruote fisse di ricambio per gru idraulica 3025



3025/RF

1 030250901

3025/RG

2 ruote girevoli di ricambio per gru idraulica 3025



3025/RG

1 030250902

3025/PF

pinza movimentazione fusti
portata massima 300 kg



A mm	B mm
550+640	70

1 030250011

3026 0,3

sollevatore idraulico da fossa e sottoponte

Portata massima: 300 kg



H min	H Max	L	L1	Ø
mm	mm	mm	mm	mm
1120	1970	450	450	25

1 030260003

3026/R0,3

4 ruote girevoli di ricambio per sollevatore idraulico 3026 0,3



3026/R 0,3

1 030260903

3026 0,5

sollevatore idraulico da fossa e sottoponte

Portata massima 500 kg

CE



H min	H Max	L	L1	Ø
mm	mm	mm	mm	mm
1140	1990	600	550	30

1 030260005

3026/R0,5

4 ruote girevoli di ricambio per sollevatore idraulico 3026 0,5



3026/R 0,5

1 030260905

3026 1,0

sollevatore idraulico da fossa e sottoponte

Portata massima 1t

CE



H min	H Max	L	L1	Ø
mm	mm	mm	mm	mm
1140	1990	650	550	35

1 030260010

3026/R 1,0

4 ruote girevoli di ricambio per sollevatore idraulico 3026 1,0



3026/R 1,0

1 030260910

3026/S

supporto orientabile per trasmissioni con boccole di riduzione per sollevatori 3026

portata massima 500 kg

CE



3026/S

1 030260501

3026/SP

supporto universale per trasmissioni

permette ad un solo operatore di smontare e rimontare le trasmissioni di autovetture, veicoli commerciali e fuoristrada con rapidità e sicurezza.

DATI TECNICI

Adatto per steli con diametro: 25-30-35-45 mm

Portata massima: 150 kg

Altezza: 250 mm

CE



3026/SP

1 030260505

3026/SA

supporto mozzo ruota per sollevatori da fossa

• utilizzabile per interventi di manutenzione inerenti ai mozzi, e durante le operazioni di sostituzione degli ammortizzatori
• adattabile ai sollevatori idraulici da fossa 3026 0,3 e 3026 0,5



3026/SA
Ø
mm
30,4

1 030260510

3026/SAM

supporto ammortizzatori per sollevatori da fossa

- utilizzabile per sostenere l'ammortizzatore quando si smonta il braccio della sospensione
- staffa per ammortizzatori con diametro Max 80 mm, più riduzione per diametri Max 60 mm
- adattabile ai sollevatori idraulici da fossa 3026 0,3 e 3026 0,5



3026/SAM

1 030260515

3027 10

pressa idraulica da banco con pistone mobile

capacità massima: 10 t

CE



3027 10

1190 kg

1 030270010

3027 20

pressa idraulica con pistone mobile

capacità massima: 20 t

CE



3027 20

1131 kg

1 030270020

3027 30

pressa idraulica con pistone mobile ed argano

capacità massima: 30 t

CE



3027 30 1 030270030

245 kg

3027 50

pressa idraulica con pistone mobile ed argano

capacità massima: 50 t

CE



3027 50 1 030270050

368 kg

3027 100

pressa elettroidraulica motorizzata con pistone mobile

caratteristiche tecniche:

- capacità massima: 100 t
- alimentazione 380 V trifase
- frequenza 50 Hz
- potenza motore elettrico 1,5 Kw
- centralina a doppia velocità
- comando con distributore a leva
- sollevamento bancale di lavoro tramite catene



3027 100 1 030270100

980 kg

3027/KP

serie di cacciaspine e piastra per pressa 3027



3027/KP10	3027 10	1 030270510
3027/KP20	3027 20	1 030270520
3027/KP30	3027 30	1 030270530
3027/KP50	3027 50	1 030270550
3027/KP100	3027 100	1 030270551

3027/KPP50

comando a pedale per pressa idraulica 3027 20-30-50



3027/KPP50 1 030270555

3027/PR

supporto pressa per estrazione/introduzione mozzi, cuscinetti e silent block

Sistema universale che, operando sotto pressa, attraverso una base di appoggio e relativi accessori, permette lo smontaggio/montaggio di mozzi, cuscinetti e silent block dalla loro sede. L'attrezzo si adatta alle conformazioni geometriche irregolari dei mozzi/perni fusi sui quali l'operatore deve intervenire.



Dati tecnici:

- Campo di lavoro: Min. 130 mm - Max. 186 mm
- Dimensioni: 300 x 300 mm
- Peso: 13 kg
- Portata massima: 20 t

3027/PR 1 030270400

3028 20

pressa idraulica con pistone mobile

capacità massima: 20 t
 piano regolabile in altezza
 pistone scorrevole

CE

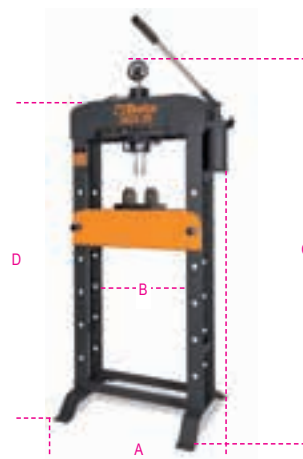

A	B	C	D	
mm	mm	mm	mm	
850	540	1830	1602	1 030280020

3028SP/20

schermo di protezione per presse 3028 20



3028SP/20 1 030280021

Beta

3028 30

pressa idraulica con pistone mobile

capacità massima: 30 t
piano regolabile in altezza
pistone scorrevole

CE

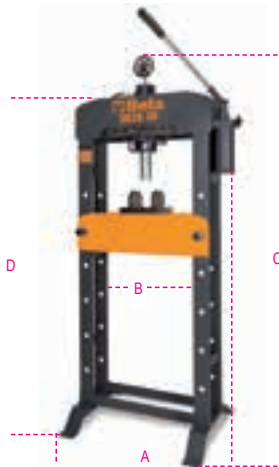

A	B	C	D
mm	mm	mm	mm
850	540	1850	1650

1 030280030

3028SP/30

schermo di protezione
per presse 3028 30



3028SP/30

1 030280031

3028 50

pressa idraulica con pistone mobile ed argano

capacità massima: 50 t
piano regolabile in altezza tramite argano
pistone scorrevole

CE

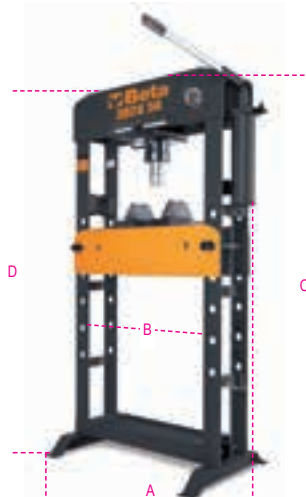

A	B	C	E
mm	mm	mm	mm
1100	750	1850	820

1 030280050

3028SP/50

schermo di protezione
per presse 3028 50



3028SP/50

1 030280051

3029/2T

sollevatore idraulico ribassato
a 4 ruote da 2 tonnellate

- Pedale di avvicinamento rapido
- Struttura in acciaio e ruote in nylon
- Altezza minima 75 mm

CE



3029/2T

1 030290020

3029L/2T

sollevatore idraulico lungo ribassato da 2 tonnellate

Permette di operare su veicoli con bassa altezza da terra e punto di sollevamento interno

- Velocità di discesa controllata
- Pedale di avvicinamento rapido
- Ruote in nylon

CE



3029L/2T

1 030290120

3029/2T-L/RP

piattello di ricambio in gomma 85 mm
per 3029/2T, 3029L/2T, 3030H/2T



3029/2T-L/RP

1 030290502

3029/2T-L/R6

ruota posteriore di ricambio
per 3029/2T, 3029L/2T, 3030H/2T, 3033E/3T



3029/2T-L/R6

1 030290506

3029/2T-L/R5

ruota anteriore di ricambio per sollevatore 3029/2T, 3029L/2T, 3030H/2T



3029/2T-L/R5

1 030290505

3030/2T

sollevatore idraulico ribassato 2 t
a 6 ruote

- doppie ruote anteriori basculanti in materiale plastico (PTFE)
- ottima manovrabilità del sollevatore su pavimentazioni sconnesse e irregolari
- portata massima: 2 tonnellate

CE



3030/2T

1 030300020

43 kg

3030/2T-R5

ruota anteriore con perno per sollevatore 3030 2T



3030 2T/R5

1 030300505

3030/2T-R6

ruota posteriore di ricambio per 3030/2T, 3033/3T



3030 2T/R6

1 030300506

3030/2TRP

piattello di ricambio in gomma 85 mm per 3030/2T, 3033/3T



3030/2TRP

5 030300501

3030H/2T

sollevatore idraulico grande alzata a 6 ruote da 2 tonnellate permette di operare su veicoli con elevata altezza da terra e con grande escursione degli ammortizzatori

- velocità di discesa controllata
- pedale di avvicinamento rapido
- ruote in nylon

CE



H	L	L1
min-Max mm	mm	mm
85+780	1010	300

1 030300220

3033/3T

sollevatore idraulico 3t versione lunga

- per utilizzo su veicoli commerciali
- portata massima: 3 tonnellate
- ruote in poliammide

CE



3033/3T

1 030330030

3033E/3T

sollevatore idraulico da 3 tonnellate

- velocità di discesa controllata
- ruote in nylon

CE



H	L	L1
min-Max mm	mm	mm
95+515	700	370

1 030330130

3033S 3T/R2

ruota anteriore di ricambio per sollevatore 3033E/3T



3033S 3T/R2

1 030330532

3035

carrello trasporta pneumatici

- per trasportare agevolmente pneumatici fino ad un massimo di 980 mm di diametro
- la solida struttura permette di movimentare i pneumatici senza doverne sopportare fisicamente il peso
- utilizzabile come piano d'appoggio, grazie al blocco della posizione in orizzontale
- 2 ruote Ø 260 mm
- 2 ruote Ø 125 mm
- altezza massima trasportabile 1,60 m
- portata massima 200 kg
- forche regolabili in 2 posizioni: prima posizione apertura massima 880 mm seconda posizione apertura massima 980 mm



3035

1 030350100

3036

base per movimentazione ruote

ruote in gomma antitraçca



3036

1 030360063

3061/2T

sollevatore pneumatico 2 t - 2 stadi

CE



Dotato di:

- membrana alta resistenza a tre strati e guida telescopica interna
- dispositivo d'arresto a fine corsa e valvola di sicurezza per carichi eccessivi
- possibilità di utilizzo anche sui ponti sollevatori

DATI TECNICI

portata: 2 t
peso: 14 kg
pressione di alimentazione: 8-10 bar
altezza: min.132 - max. 326 mm

3061/2T

1 030610020

3061/2T-P50

prolunga da 50 mm per 3061/2T



3061/2T P50

1 030610021

3061/2T-P100

prolunga da 100 mm per 3061/2T



3061/2T P100

1 030610022

3065/20-10T

sollevatore oleopneumatico 20-10T
con valigia di trasporto

Portatile e leggero, ideale per gli interventi di assistenza su strada

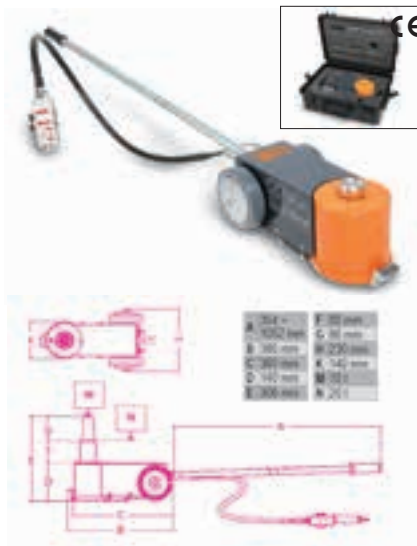

- include due prolunghe da 75 e 60 mm

DATI TECNICI

portata: 20-10 tonnellate

peso: 23 kg

pressione di alimentazione: 8-10 bar

consumo d'aria: 400 nl/min

3065/20-10T



1 030650100

3067/60-15T

sollevatore oleopneumatico 60-30-15T

Con un'altezza minima di soli 120 mm è particolarmente indicato per utilizzo su autobus, pullman e mezzi di trasporto pubblici



- rientro automatico dei pistoni
- due valvole di discesa con controllo velocità sotto carico
- include due prolunghe da 70 e 120 mm

DATI TECNICI

portata: 60-30-15 tonnellate

peso: 56 kg

pressione di alimentazione: 8-10 bar

consumo d'aria: 600 l/min

3067/60-30-15T



1 030670120

3065/40-20T

sollevatore oleopneumatico 40-20 t

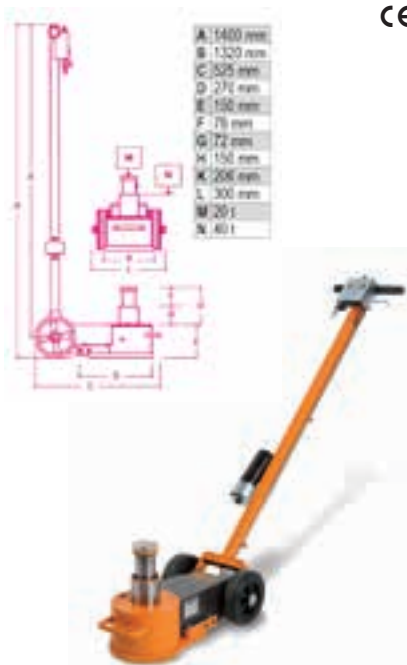

- indicato per utilizzo su mezzi pesanti
- pratico e maneggevole per trasporto anche su officine mobili
- rientro automatico dei pistoni
- due valvole di discesa con controllo velocità sotto carico
- include due prolunghe da 70 e 120 mm

DATI TECNICI

portata: 40-20 tonnellate

peso: 39 kg

pressione di alimentazione: 8-10 bar

consumo d'aria: 400 l/min

3065/40 20T



1 030650200

3067/70-13T

sollevatore oleopneumatico 70-43-23-13 t

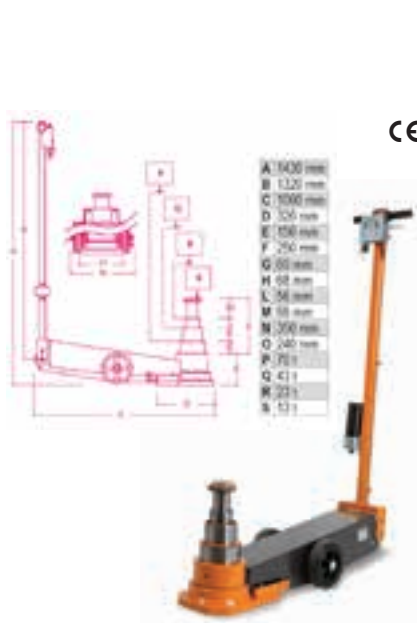

- Versione lunga, adatta all'utilizzo su autocarri, autoarticolati, autobus e macchine agricole
- rientro automatico dei pistoni
 - due valvole di discesa con controllo velocità sotto carico
 - include due prolunghe da 70 e 120 mm

DATI TECNICI

portata: 70-43-23-13 tonnellate

peso: 74 kg

pressione di alimentazione: 8-10 bar

consumo d'aria: 600 l/min

3067/70 13T



1 030670130

Beta



UTENSILI PER MOTORIPARAZIONE

La qualità e l'affidabilità dei prodotti Beta sono garantite da oltre ottant'anni di esperienza e tradizione. Prodotti continuamente aggiornati la cui qualità è altamente apprezzata dai tecnici delle migliori squadre corse nel Motomondiale, Mondiale Superbike, Mondiale Motocross ed Enduro.



3040C

cavalletto posteriore per moto regolabile

- Verniciatura nera opaca
- 4 ruote in gomma termoplastica
- Include coppia di cursori a V
- Include coppia di cursori a L



3040C 1 030400002

3040C/S1

coppia cursori a V per 3040C



3040C/S1 1 030400503

3040C/S2

coppia cursori a L in gomma per 3040C



3040C/S2 1 030400504

3041C

cavalletto anteriore per moto regolabile

- Verniciatura nera opaca
- 4 ruote in gomma termoplastica
- Include coppia di cursori a rulli
- Include coppia di cursori a cono



3041C 1 030410002

3041C/12

coppia cursori a rulli per 3041C



3041C/12 1 030410512

3041C/16

coppia cursori a cono per 3041C



3041C/16 1 030410516

3042C

cavalletto anteriore per canotto di sterzo moto

- Verniciatura nera opaca
- 4 ruote in gomma termoplastica
- Include kit di 8 perni Ø 13 - 15 - 15,5 - 17 - 19 - 20 - 21 - 27



3042C 1 030420002

3043C

cavalletto per moto con monobraccio sinistro

- Verniciatura nera opaca
- 4 ruote in gomma termoplastica
- Perno optional



3043C 1 030430002

3043C/ 41÷47

perno per 3043C



	∅ mm	
3043C/41 Ducati	21,5 ÷ 25,5	1 030430551
3043C/42 KTM - Triumph	27,5	1 030430552
3043C/43 MV	42,5	1 030430553
3043C/44 Ducati	40,5	1 030430554
3043C/45 Honda	28,5	1 030430555
3043C/47 BMW	53,5	1 030430557

3047C

cavalletto cross/enduro a pedale



3047C 1 030470002

3048C

cavalletto cross racing in acciaio



3048C 1 030480002

3050/CC

cavalletto centrale a vite sotto culla per Custom, Enduro, Cross, Scooter

Include kit di supporti regolabili

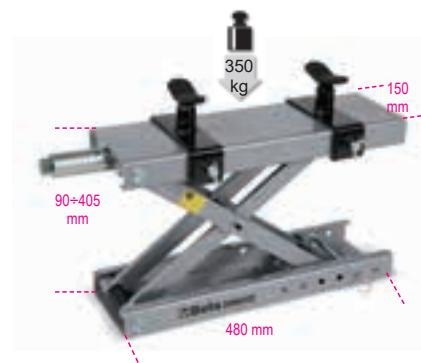

3050/CC 1 030500012



3050/600

Sollevatore moto elettroidraulico da 600 kg

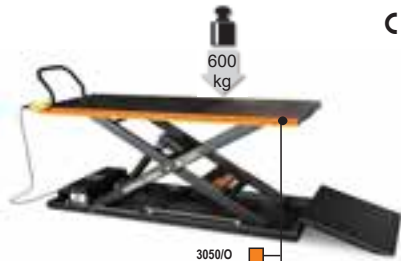

3050/O
3050/G
3050/R

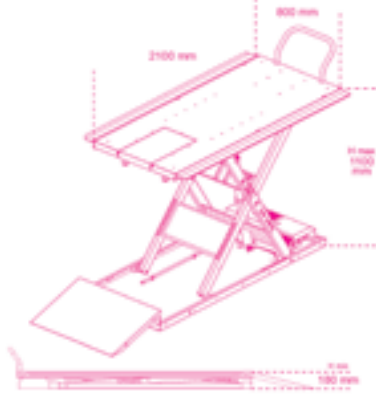

Caratteristiche tecniche:

- Sicurezze elettriche, meccaniche e idrauliche
- Portata: 600 kg
- Centralina elettroidraulica integrata: 230V - 50 Hz
- Pompa idraulica
- Velocità di discesa controllata
- Fusibili di sicurezza in caso di tranciatura del cavo
- Pulsantiera di comando
- Certificato ce omologato TÜV

	L	L	H min	H Max	
	mm	mm	mm	mm	
3050/O	975	2100	185	1110	1 030500201
3050/G	975	2100	185	1110	1 030500202
3050/R	975	2100	185	1110	1 030500203

3050/KA

kit di allargamento per sollevatore 3050/600

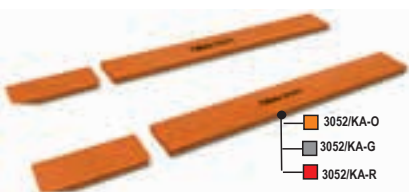

	A	B	
	mm	mm	
3050/KA-O	107,5	2100	1 030500221
3050/KA-G	107,5	2100	1 030500222
3050/KA-R	107,5	2100	1 030500223

3050/MS

morsa bloccaruota per sollevatore 3050/600

permette il bloccaggio della ruota anteriore della moto sul ponte



3050/MS 1 030500032

3050/MV

morsa bloccaruota meccanica a vite per sollevatore 3050/600



3050/MV 1 030500034

3050/LA

piano in lamiera anticivolo per sollevatore 3050/600

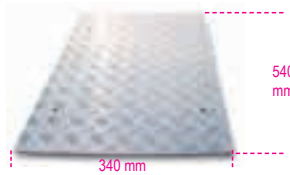

3050/LA 1 030500062

9562T1

tappeto da officina 100X80 cm

particolarmente indicato per l'utilizzo sotto smontagomme per moto BETA 3071 e 3071B

- facile da pulire, fondo gommato e anticivolo



	L	H	
	cm	cm	
9562T1	100	80	1 095620150

9562T3

tappeto da officina 300x160 cm

particolarmente indicato per l'utilizzo sotto ponti sollevatori moto

- protegge il suolo da perdite d'olio, benzina e rispetta l'ambiente
- facile da pulire, fondo gommato e anticivolo



	L	H	
	cm	cm	
9562T3	300	160	1 095620300

3054

base mobile per cavalletto centrale o per ruota posteriore moto con estensione per cavalletto laterale



3054 1 030540000

3055M

morsa automatica per furgoni

permette il fissaggio della ruota anteriore della moto



3055M 1 030550002

3057

rampa in alluminio per carico/scarico moto



3057 1 030570001

3070B

equilibratrice statica manuale

misure coni:
Øe 30 mm - Øi 10 mm
Øe 30 mm - Øi 12 mm
Øe 40 mm - Øi 14 mm



- permette l'equilibratura delle ruote in officina e sui campi gara
- dotata di cuscinetti volventi, livella di posizionamento e piedini regolabili per una massima precisione
- include coppia di coni per mozzi

3070B 1 030700100

3070B/...

asta bilanciatrice
per equilibratrice 3070B



	Ø1	Ø2	
3070B/10	30	10	1 030700101
3070B/12	30	12	1 030700102
3070B/14	40	14	1 030700103

3070BE/K

equilibratrice elettronica portatile a lancio manuale

sistema di equilibratura con microprocessore a lancio manuale (senza motore) che permette l'equilibratura di ruote in ferro o in lega di auto e moto



Caratteristiche:

- Compatta e facilmente trasportabile. Può essere utilizzata in officina, all'interno di furgoni o nei box dei circuiti
- Può essere fissata su un banco o su una parete
- Il software include tutti i programmi di correzione dello squilibrio con indicazione delle posizioni con pesi adesivi (ALUS), pesi nascosti dietro le razze (SPLIT) e ottimizzazione dello squilibrio
- Può essere utilizzata con supporto orientabile BETA 3070BE/S (optional)

Accessori inclusi:

- Righello flessibile graduato
- Ghiera di serraggio con volantino e 3 coni da Ø 45 + 110 mm

Dati tecnici:

- Alimentazione: 115-230V AC o 12-24V DC
- Potenza massima assorbita: 0.15 kW
- Velocità di equilibratura: 100 rpm
- Incertezza di misura: 1 g
- Larghezza cerchione impostabile: 1.5" ÷ 20" (40÷ 510 mm)
- Peso massimo della ruota: max 75 kg

3070BE/K 1 030700250

3070BE/S

supporto orientabile per equilibratrice portatile elettronica 3070BE

permette il fissaggio a parete o a banco dell'equilibratrice riducendo gli ingombri e gli spazi di installazione



	L	L1	
	mm	mm	
3070BE/S	514	280	1 030700201

3070BE/F

flangia universale motocicli Ø 40 mm per 3070BE

utilizzabile sulle ruote con foro centrale passante con Ø da 15 a 35 mm e sulle ruote flangiate con centratura fino a Ø 68 mm



3070BE/F 1 030700202

3070BE/B

kit di 8 bussole per il centraggio delle ruote dei motocicli per 3070BE

permette di operare sui seguenti Ø:
28 - 25 - 22 - 20 - 19,05 - 17 - 16 - 15



3070BE/B 1 030700203

3071A

smontagomme manuale per moto da cross e enduro

permette lo smontaggio dei pneumatici in modo semplice e veloce sui campi gara, grazie alla robusta ed ampia struttura realizzata in acciaio zincato garantisce stabilità durante la fase di smontaggio del pneumatico. Per una maggiore praticità di utilizzo è possibile montarlo sul rialzo BETA 3071RS

caratteristiche:

- impugnatura ergonomica in gomma che consente una presa facile e sicura della leva
- dotato di un fermo in gomma per il bloccaggio dell'asta durante il trasporto
- possibilità di montare gomme da cross ed enduro da 17" a 21".

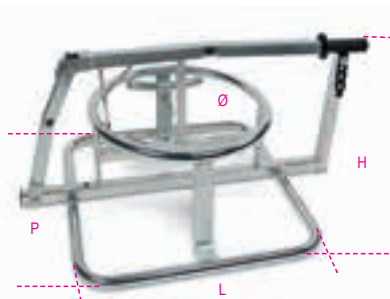

	L	H	P	Ø	
	mm	mm	mm	mm	
3071A	570	400	850	440	1 030710000

3071B

smontagomme manuale per minimoto e minicross

permette lo smontaggio dei pneumatici in modo semplice e veloce sui campi gara, grazie alla robusta ed ampia struttura realizzata in acciaio zincato garantisce stabilità durante la fase di smontaggio del pneumatico. Per una maggiore praticità di utilizzo è possibile montarlo sul rialzo BETA 3071RS

caratteristiche:

- impugnatura ergonomica in gomma che consente una presa facile e sicura della leva
- possibilità di montare la maggior parte di gomme per minimoto e minicross.



	L	H	P	Ø	
	mm	mm	mm	mm	
3071B	570	330	650	340	1 030710010

3071RS

rialzo per smontagomme BETA 3071A e 3071B

utilizzato per rialzare gli smontagomme BETA 3071A e 3071B favorendo la procedura di smontaggio, la struttura è realizzata in acciaio zincato con base quadrata per favorire la stabilità.

- dotato di 4 ganci di fissaggio

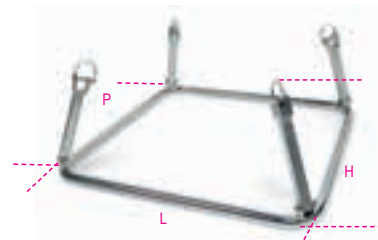

	L	H	P	
	mm	mm	mm	
3071RS	670	275	670	1 030710020

962C

coppia di levagomme per moto da cross, enduro, minimoto e minicross

da utilizzare in abbinamento agli smontagomme BETA 3071A e 3071B



	L	A	
	mm	mm	
962C	420	30	1 009620020

3072N

smonta ammortizzatori posteriori e forcelle manuale, da banco, per moto
permette lo smontaggio degli ammortizzatori posteriori moto in totale sicurezza, tramite i bracci regolabili è adatto alla maggior parte degli ammortizzatori posteriori, in alternativa è possibile utilizzare la piastra in dotazione.

caratteristiche:

- adatto all'uso per la maggior parte degli ammortizzatori posteriori moto e forcelle anteriori
- regolabile in altezza in 8 posizioni
- 3 bracci regolabili
- piastra di bloccaggio ammortizzatori
- dotato di cric a pantografo
- dotato di piedini in gomma
- dotato di spina fermo ammortizzatori
- dotato di staffa di trazione

dati tecnici

estensione cric: max 130 mm
estensione bracci: max 55 mm
estensione fermi: max 18 mm
potenza spinta: max 1 ton



	L	H	P
3072N	390 mm	785 mm	390 mm

3073

inseritore universale paraoli forcella

per diametri stelo da 35 a 45 mm



3073	1	030730001
------	---	-----------

3075A

chiave a bussola esagonale per dadi mozzo ruota



	Ø	Ø	L
3075A 28	28 mm	38 mm	30 mm
3075A 30	30 mm	40 mm	30 mm

3075B

chiave a bussola poligonale per dadi mozzo ruota DUCATI



	Ø	Ø	L
3075B 55	55 mm	70.7 mm	25 mm

3075MV

chiave a bussola poligonale per dadi mozzo ruota MV AGUSTA



	Ø	Ø	L
3075MV 56	56 mm	70.7 mm	30 mm

3075/CM

chiave esagonale maschio multipla per perni ruote



3075/CM	1	030750212
---------	---	-----------

3075/K10

set chiave universale a testina intercambiabile e 10 inserti, per serraggio raggi ruote

Misure: 5.2 - 5.4 - 5.6 - 5.8 - 6.0 - 6.2 - 6.4 - 6.6 - 6.8 - 7.0



3075/K10	1	030750410
----------	---	-----------

3079/21

oliatore per cavi

Permette una corretta lubrificazione dei cavi frizione e comando gas aumentando la scorrevolezza delle guaine e la durata dei cavi.



3079/21	1	030790021
---------	---	-----------

3080/C15

kit per smagliatura e ribaditura catene

Diametri 3-4-5 mm e kit regina



3080/C15	1	030800015
----------	---	-----------

3080R/CS3

kit di 3 cacciapinna di ricambio per smagliatene 3080/C15

diametro 3-4-5 mm



3080R/CS3	1	030800503
-----------	---	-----------

3081

smagliatene portatile

Robusto e ripiegabile per facilitarne il trasporto nella borsa da enduro.
Adatto a catene 415, 420, 428, 520, 525, 530, 532



3081	1	030810010
------	---	-----------

3085

utensile per separazione pistoncini freno

Indicato per pinze freno moto e scooter



3085	1	030850010
------	---	-----------

3091

estrattori con filetto interno per volano



	M		
3091/10	24x1,5	1	030910010
3091/20	26x1,0	1	030910020
3091/25	27x1,0	1	030910025
3091/30	28x1,0	1	030910030
3091/40	30x1,0	1	030910040
3091/45	30x1,5	1	030910045
3091/50	32x1,5	1	030910050
3091/60	33x1,5	1	030910060
3091/70	35x1,0	1	030910070
3091/75	35x1,5	1	030910075
3091/80	38x1,5	1	030910080

3092

estrattori con filetto esterno per volano



	M		
3092/10	18x1,5	1	030920010
3092/20	19x1,0	1	030920020
3092/25	27x1,0	1	030920025
3092/30	27x1,25/20x1	1	030920030
3092/35	22-26x1,5	1	030920035
3092/40	25x1,5/22x1	1	030920040
3092/50	26-28x1,0	1	030920050
3092/60	28x1,5	1	030920060

3093/E

attrezzo per bloccaggio volano, campana frizione e pulegge



3093/E	1	030930100
--------	---	-----------

3093/U

estrattore multiplo per volano



3093/U	1	030930050
M10x1.25R		
M14x1.5R		
M16x1.5R		
M18x1.5R		
M24x1.0R		
M27x1.0L		

3094PA

pannello assistenza moto OFFROAD

struttura in metallo con gambe richiudibili all'interno del telaio, indicato per la sistemazione degli utensili sui campi gara disponibile in 3 colorazioni:

- 3094PA-O Arancione
- 3094PA-G Grigio
- 3094PA-R Rosso

accessori disponibili non inclusi:

- portacarta per rotoli preforati 3200 PR
- portafiacone universale magnetico 2499PF/M

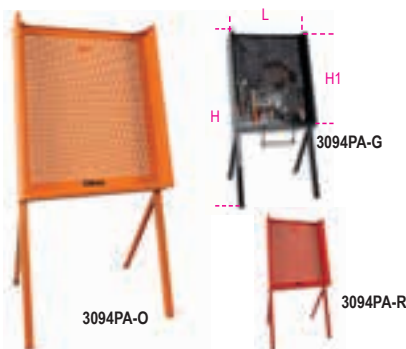

	L	H	H1		
	mm	mm	mm		
3094PA-O	750	1555	900	1	030940101
3094PA-G	750	1555	900	1	030940102
3094PA-R	750	1555	900	1	030940103

3095

supporto da banco per motori moto

grazie alle staffe regolabili, le lavorazioni a banco sui motori risultano pratiche ed agevoli



	H	P	L	L1		
	mm	mm	mm	mm		
3095	360	460	640	460	1	030950001

3099E

telo coprimoto da esterno resistente ad acqua e polvere

protegge la vernice dai graffi, dalla polvere e dai raggi solari



Misure disponibili:

Taglia "M" indicata per moto sportive, naked e scooter di medie dimensioni
Taglia "L" indicata per moto maxi enduro e crossover

3099E/M	M	1	030990102
3099E/L	L	1	030990103

3099T

telo coprimoto da interno in tessuto elasticizzato

Protegge la vernice da graffi, dalla polvere e dai raggi solari



Misure disponibili:

Taglia "M" indicata per moto sportive, naked e scooter di medie dimensioni

Taglia "L" indicata per maxi enduro e crossover

Taglia "XL" indicata per super touring

3099T/M	M	1	030990202
3099T/L	L	1	030990203
3099T/XL	XL	1	030990204



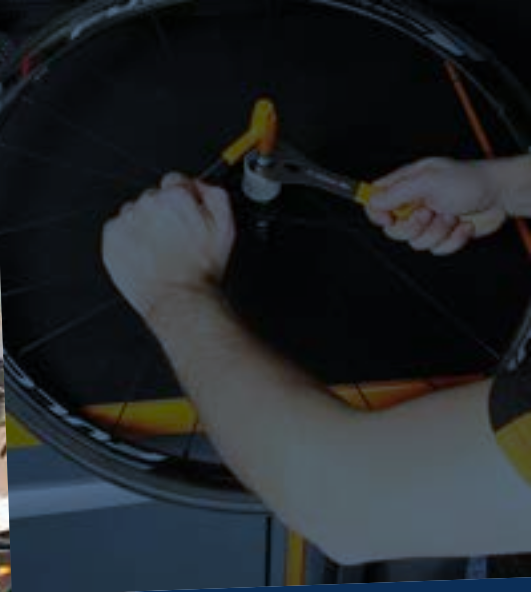

UTENSILI PER BICICLETTA

Beta è da sempre legata al ciclismo. Questo “Speciale Utensili Biciclette” è dedicato ai professionisti del settore, ed è una selezione accurata di prodotti specifici dedicati alla manutenzione delle biciclette e delle e-bike.



Vincitore Tour de France 2020 e 2021



supplier

Partnership 2022

*Collaboratore ufficiale della squadra
di ciclismo EOLO KOMETA*



Partnership 2022



3910



sollevatore per E-Bike

- Portata massima 40kg
- Altezza massima supporto movimento centrale 135cm
- Centra-ruota integrato
- Innovativo sistema di bloccaggio utilizzando il perno passante
- Include bussole adattatori per le maggiori forcelle in circolazione
- Incluso adattatore per attacco forcelle senza perno passante
- Completamente ripiegabile e trasportabile
- Peso del sollevatore 48kg

CE

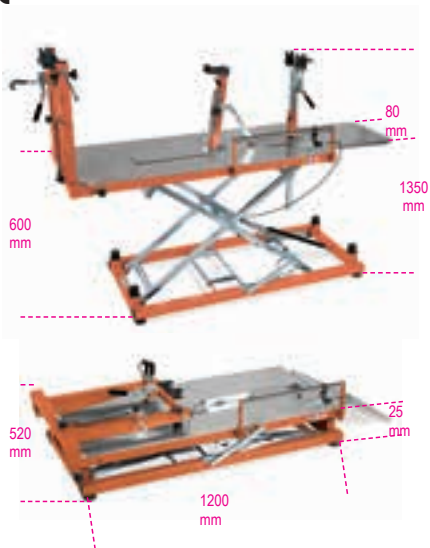

3910

1 039100010

3912TP



banco TOP da officina per manutenzione biciclette

- Dotato di supporto per movimento centrale con perno di sicurezza
- Cassetto porta attrezzi montato su guide a sfera 490x365x90 mm
- Centra-ruota integrato
- Innovativo sistema di bloccaggio utilizzando il perno passante



3912TP

1 039120050

3912PP



banco PRO da officina per manutenzione biciclette

- Dotato di supporto per movimento centrale con perno di sicurezza
- Centra-ruote integrato
- Innovativo sistema di bloccaggio utilizzando il perno passante



3912PP

1 039120150

3912TP/A



bussola adattatore per forcelle con perno passante

Per banco 3912TP, 3912PP e 3910



L mm 39

Ø mm 30

Ø1 mm 5

1 039120052

3912TP/C



bussola adattatore universale per forcelle con perno passante e serraggio con chiave esagonale

Per banco 3912TP, 3912PP e 3910



L mm 29

Ø mm 30

1 039120054

3912TP/FOX



bussola adattatore per forcelle FOX®

Per banco 3912TP, 3912PP e 3910



L mm 38

1 039120058

3912TP/QRE



perno adattatore per forcelle senza perno passante

Per banco 3912TP, 3912PP e 3910



L mm 108

1 039120064

3912TP/ROAD



bussola adattatore per forcelle da strada

Per banco 3912TP, 3912PP e 3910



L mm 33

Ø mm 35

1 039120060

3912TP/RS



bussola adattatore per forcelle con perno passante ROCKSHOX®

Per banco 3912TP, 3912PP e 3910



L mm 35

Ø mm 30

1 039120056

3912TP/ST



bussola adattatore per forcelle SUNTOUR

Per banco 3912TP, 3912PP e 3910



L mm 31

Ø mm 30

Ø1 mm 18

1 039120062



3916MMP

morsa monobraccio da officina per manutenzione biciclette

- Morsa girevole di 360° con ganasce flottanti e regolazione micrometrica
- Portata 25Kg
- Vaschetta in plastica porta-attrezzi



3916MMP

1 039160150

3918MML

morsa monobraccio di tipo leggero, richiudibile

- Morsa girevole a 360°
- Portata 15kg
- Altezza massima della morsa 150cm



3918MML

1 039180010

3921

attrezzo per l'allineamento del forcellino-cambio



L mm	A mm	A1 mm
440	115	165

1 039210010

3923

attrezzo guidalama per taglio reggisella di tipo aerodinamico fino a 80 mm e taglio canotti da 1" a 1.1/2"

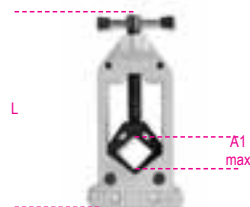

L mm	A1 max mm	Ø max mm
160	80	45

1 039230010

3927

bloccamanubrio



L mm
365

1 039270010

3932U

smagliacatena professionale compatibile con catene da 5 a 11 velocità



L mm	L1 mm
164	115

1 039320011

3935

indicatore usura catena



L mm
120

1 039350010

3937

pinza per falsamaglia



L mm
170

1 039370010

3948

estrattore per pedivelle



Ø mm	L mm	Ø mm	Ø max mm
14	79	20	15

1 039480015

3952

chiave conica semplice

- Spessore ridotto



Ø mm	L mm	Q	Q
13	205	2	039520013
14	205	2	039520014
15	205	2	039520015
16	205	2	039520016
17	205	2	039520017
18	205	2	039520018
19	205	2	039520019
20	205	1	039520020
21	205	1	039520021
22	205	1	039520022
24	205	1	039520024



3952/S7

13-14-15-16

17-18-19 mm

3952/S11

13-14-15-16

17-18-19-20-21-22-24 mm

1 039520207

1 039520211

3953

chiave per pedali



Ø mm	L mm
15	401

1 039530015

3955

chiavi a forchetta per serie sterzo universali



Ø mm	L mm
30x32	292
32x36	319

1 039550108

1 039550114

39613,2

tiraraggi nero 3,2mm



Ø mm
3,2

1 039610032

39613,3

tiraraggi verde 3,3 mm



Ø mm
3,3

1 039610033

39613,5

tiraggi rosso 3,5 mm



mm 3,5 1 039610035

3961U

tiraggi professionale 3,2 - 4,0 mm



mm 3,2 - 4,0 1 039610100

3962SH

chiave tiraggi doppia per Shimano®



L mm 132 A1 mm 4,3 A2 mm 4,4 1 039620010

3962MV

chiave tiraggi doppia per Mavic®



L mm 135 A1 mm 4,3 A2 mm 8,4 1 039620020

3963P

chiave speciale per raggi piatti



L mm 129 1 039630010

3964

chiave speciale avvità nippli



L mm 170 L1 mm 89 1 039640010

• Dotato di molla di ricambio all'interno dell'impugnatura

3965

dima per campanatura ruote da 20" a 29"



L mm 680 1 039650010

3965C

centraruote professionale



- Per diametri da 20" a 29"
- Adattatore per assi passanti tra 10 e 20mm

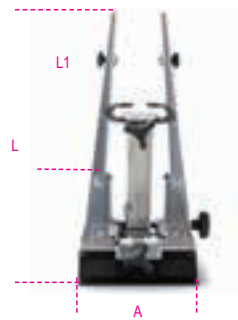

L mm 500 L1 mm 380 A mm 285 1 039650110

3967

chiave frusta smonta-pignoni



- Compatibile fino a cassette da 11 velocità
- Manico in 2PVC
- Adatta anche per ruote a scatto fisso



L mm 289 1 039670010

3969

levagomme



L mm 200 A mm 15,6 1 039690010

3969K3

kit di 3 levagomme, in plastica



L mm 113 1 039690130

3971

chiave per vite in metallo Shimano®



- Adatto per guarniture Shimano® Hollowtech II



N° 8 mm 8 1 039710010

3972

chiave estrattore per movimento centrale



- idoneo per Shimano® Hollowtech II, Campagnolo® Ultra-torque, FSA®, SRAM®



L mm 252 1 039720010

3973PF

estrattore per cuscinetti Press-Fit



- Adatto per diametri interni da 24 e 30mm



L mm 240 1 039730001

3973/1

chiave a bussola estrattore per movimento centrale a 16 tacche



- Idoneo per Shimano® XTR BB93, Dura-Ace® BB9000

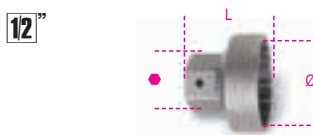

12" Ø mm 39 mm 24 L mm 34 1 039730010

3973/2

chiave a bussola estrattore per movimento centrale a 16 tacche



- Idoneo per Shimano® BBR60 (Ultegra® 11 velocità)

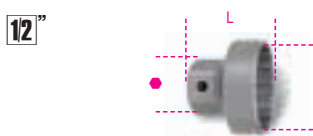

12" Ø mm 41 mm 24 L mm 35 1 039730020

3973/3

chiave a bussola estrattore per movimento centrale a 16 tacche

• idoneo per Shimano® Hollowtech II, Campagnolo® Ultra-torque, FSA®, SRAM®

12"



Ø int. mm	● mm	L mm
46	24	53,5

1 039730030

3973/4

chiave a bussola estrattore per movimento centrale a 20 tacche con perno centrale nichelata

• Idoneo per Shimano e ISIS

12"



Ø mm	L mm	● mm
31,5	55	24

1 039730040

3975

pressa montaggio serie sterzo e movimento centrale

• Adatto per il montaggio delle calotte serie sterzo da 1", 1.1/8", 1.1/4", 1.1/2" e 2"
NOTE: non utilizzabile per calotte "zero stack"



L mm	Ø mm
360	16x1

1 039750010

3984/1

chiave estrattore per ruote libere BMX a 4 innesti



Ø mm	L mm	● mm
35	25,5	24

1 039840010

3984/2

chiave estrattore per ruote libera Shimano®



Ø mm	L mm	● mm
22,8	26	24

1 039840020

3984/3

chiave estrattore per ruote libere Shimano® a cassetta con perno di guida

12"

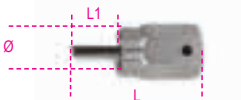

Ø mm	L mm	L1 mm
23,5	65	25

1 039840030

3984/4

chiave estrattore per ruote libere Campagnolo con perno di guida



Ø mm	L mm	L1 mm	● mm
23	51	13	24

1 039840040

3984/5

chiave estrattore per ruote libere 2 innesti

12"



Ø mm	L mm	● mm
18,5	38	21

1 039840050

3984/6

chiave estrattore per ruote libere 4 innesti

12"



Ø mm	L mm	● mm
19,5	36	21

1 039840060

3991

leva per arretrare pastiglie freni a disco



L mm	A mm	α
222	36	7°

1 039910010

3992

chiave per raddrizzare dischi freno



L mm	A1 mm
234	2,2

1 039920010

Beta

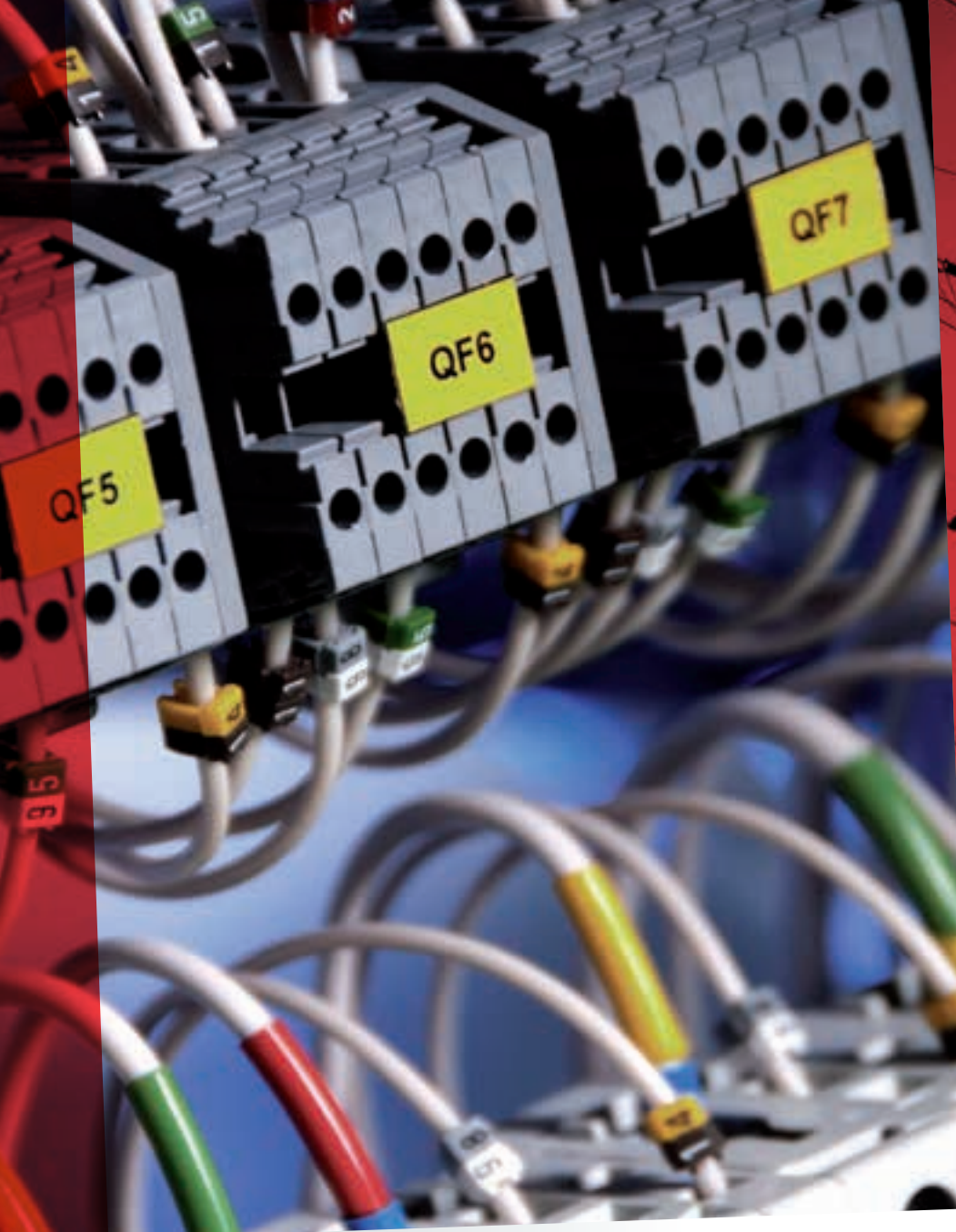

UTENSILI ISOLATI

Gli utensili isolati Beta sono prodotti studiati per garantire la sicurezza di installatori e manutentori elettrici. Tutti gli utensili isolati permettono di operare su impianti in tensione fino a 1000V in corrente alternata e 1500V in corrente continua. Per garantire il massimo livello di qualità e di prestazioni e accertare l'idoneità e la conformità alla norma EN 60900, ogni singolo utensile è sottoposto a un approfondito processo di verifica che comprende: prove di resistenza dell'impugnatura allo sfilamento e alla propagazione della fiamma e prova di tensione applicata a 10000 Volt. Per assortimenti e termoformati vedere le rispettive sezioni.



Istituto Italiano del Marchio di Qualità - I



Verband der Elektrotechnik
Elektronik Informationstechnik - D

⚡ 1000 V

TEST DI SICUREZZA: testati a 10.000 volt per lavorare su impianti a 1.000 volt

Gli utensili ad alto isolamento Beta vengono testati pezzo per pezzo a 10 kV, con l'obiettivo di offrire una qualità assoluta per strumenti di lavoro che devono garantire elevatissimi standard di sicurezza. Permettono infatti di operare su impianti in tensione fino a 1000 V in corrente alternata (1500 V in corrente continua).



NORME DI SICUREZZA:

Nonostante gli accuratissimi controlli in fase di produzione l'operatore deve sempre verificare, prima dell'uso, che non ci siano lacerazioni, modifiche o deterioramenti di qualsiasi tipo dell'impugnatura isolante.

Il mantenimento nel tempo delle caratteristiche dielettriche infatti è strettamente connesso agli stress meccanici, chimici o termici che possono venire imposti all'utensile.

Nel caso di deterioramenti dell'isolante, l'utensile non è da considerare sicuro per l'utilizzo su impianti in tensione. Usare sempre occhiali e guanti isolanti.

CONTROLLI ESEGUITI IN FASE DI PRODUZIONE



Controllo visivo al 100%:

tutti gli utensili devono avere finiture superficiali prive di difetti esteriormente visibili.



Controllo dimensionale:

tutte le quote caratteristiche degli utensili devono essere conformi alle specifiche di progetto.

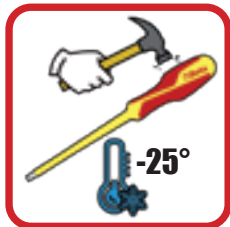

Prova d'urto:

dopo un tempo di permanenza di 2 ore a -25°C l'utensile viene colpito per tre volte, (da un peso specifico determinato dalla norma) e non deve svilupparsi alcun danneggiamento dell'impugnatura isolante.



Prova di isolamento elettrico:

dopo un'immersione in acqua per 24 ore all'utensile viene applicata una tensione di 10 kV per 3 minuti. Non si devono verificare dispersioni di corrente superiori a quelli previsti dalla norma.



Prova di penetrazione:

viene applicato per due ore un peso di 2 kg sull'impugnatura dell'attrezzo a +70°C, successivamente nella zona sottoposta a pressione meccanica viene applicata una tensione di 5 kV per tre minuti. Non si devono verificare passaggi di corrente.

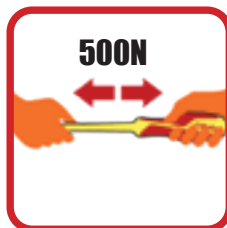

Prova di aderenza:

dopo un tempo di permanenza di 168 ore a +70°C all'utensile viene applicato un carico di 500 N per verificare che non si sfili l'impugnatura.



Prova meccanica:

gli utensili devono soddisfare tutte le prestazioni meccaniche stabilite dalle rispettive norme ISO di prodotto.



Prova di indelebilità delle marcature:

dopo il test di sfregamento con alcool isopropilico le marcature devono rimanere leggibili.



Prova di non propagazione della fiamma:

una fiamma viene indirizzata verso l'utensile per 10 secondi, nei 20 secondi successivi la fiamma non deve superare l'altezza di 120 mm.



52MQ

chiavi a forchetta semplici



1000 V

EN 60900

mm	L mm		
6	90	1	000520106
7	96	1	000520107
8	100	1	000520108
9	108	1	000520109
10	110	1	000520110
11	120	1	000520111
12	132	1	000520112
13	140	1	000520113
14	146	1	000520114
15	166	1	000520115
16	156	1	000520116
17	168	1	000520117
18	170	1	000520118
19	176	1	000520119
21	190	1	000520121
22	200	1	000520122
24	225	1	000520124
27	210	1	000520127
30	240	1	000520130
32	240	1	000520132

89MQ

chiavi poligonali semplici



1000 V

EN 60900

mm	L mm		
6	150	1	000890106
7	155	1	000890107
8	155	1	000890108
9	160	1	000890109
10	170	1	000890110
11	180	1	000890111
12	190	1	000890112
13	195	1	000890113
14	200	1	000890114
15	210	1	000890115
16	216	1	000890116
17	218	1	000890117
18	236	1	000890118
19	240	1	000890119
21	250	1	000890121
22	255	1	000890122
24	280	1	000890124
27	300	1	000890127
30	320	1	000890130
32	340	1	000890132

110MQ

chiave regolabile a rullino con scala graduata



1000 V

EN 60900

L mm	A max		
200	28	1	001100520
250	30	1	001100525
300	30	1	001100530

606MQ/50

chiave dinamometrica a scatto con cricchetto reversibile con sistema di trattenimento della bussola



1000 V

EN 60900
UNI EN 26789
ISO 6789

Nm	Kgfm	lbf.ft	L1 mm	L mm	g
5÷50	0,5÷5	4÷40	90	375	1130

606MQ/50 1 006060705

850MQ

portainseri magnetico isolato con impugnatura bimateriale

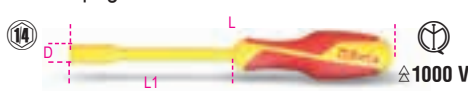

1000 V

IMQ CSV
EN 60900

L mm	L1 mm	D mm		
233	125	12,5	1	008500910

910MQ/B

chiavi a bussola poligonali



1000 V

EN 60900

mm	L mm	Ø1 mm	Ø mm		
6	45	14	24	1	009100616
7	45	15	24	1	009100617
8	45	16	24	1	009100618
9	45	17	24	1	009100619
10	45	19	24	1	009100620
11	45	20	24	1	009100621
12	45	24	24	1	009100622
13	45	24	24	1	009100623
14	45	25	24	1	009100624
15	45	27	24	1	009100625
16	45	27,5	24	1	009100626
17	45	30	24	1	009100627
18	45	31	24	1	009100628
19	45	32	24	1	009100629

910MQ/PE

chiavi a bussola maschio esagonale



1000 V

EN 60900

mm	Ø mm	L mm		
4	24	100	1	009100604
5	24,5	100	1	009100605
6	25,0	100	1	009100606
8	25,0	100	1	009100608
10	25,5	100	1	009100610

910MQ/TX

chiavi a bussola maschio per viti con impronta Torx®



1000 V

EN 60900

mm	Ø mm	L mm	L1 mm		
15	23	116	61	1	009100641
20	24,5	116	65	1	009100642
25	24,5	116	65	1	009100643
27	24,5	116	65	1	009100644
30	24,5	116	65	1	009100645
40	24,5	116	65	1	009100646

910MQ/XZN

chiavi a bussola maschio a profilo XZN®

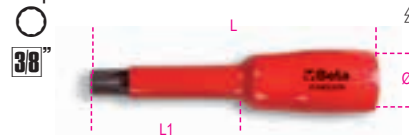

1000 V

EN 60900

mm	Ø mm	L mm	L1 mm		
M8	24	106	57	1	009100658
M10	24	106	57	1	009100660

910MQ/PT

prolunghe preparate con attacco quadro femmina 3/8"



1000 V

EN 60900

Nm	L mm	L1 mm		
12	80	35,5	1	009100801

910MQ/21

prolunga quadro maschio e femmina 3/8"



1000 V

EN 60900

L mm	Ø mm		
140	13,4	1	009100804

910MQ/22

prolunga quadro maschio e femmina 3/8"



1000 V

EN 60900

L mm	Ø mm		
265	13,4	1	009100805

910MQ/T

quadro maschio 3/8", a T

3/8"



1000 V

EN 60900

L	L1
mm	mm
200	165

910MQ/55

cricchetto reversibile con attacco quadro maschio 3/8"

3/8"



1000 V

EN 60900

L	D	A
mm	mm	mm
203	41	67

910MQ/C16

8 chiavi a bussola poligonali
4 chiavi a bussola esagonali maschio
e 4 accessori

3/8"



1000 V

EN 60900

910MQ/C16 1 009100917

	910MQ/B	8 - 10 - 11 - 12 - 13 - 14 - 17 - 19 mm
	910MQ/PE	4 - 5 - 6 - 8 mm
	910MQ/21	125 mm
	910MQ/22	250 mm
	910MQ/T	
	910MQ/55	

914MQ/A

chiavi a bussola esagonali, con attacco quadro femmina 3/8", in tecnopolimeri speciali su base poliammidica.

Specifiche per operare sulle batterie delle auto ibride ed elettriche

Utilizzare con chiave dinamometrica

3/8"



1000 V

EN 60900

Ø	Ø	L	Ø1	
mm	mm	mm	mm	
8	17,5	45	20	2 009140008
10	20,5	45	20	2 009140010
13	24	45	20	2 009140013
17	30	45	22	2 009140017

3/8"



EN 60900

914MQ-A/S4 1 009140054
8-10-13-17 mm

920MQ/A

chiavi a bussola esagonali

12"



1000 V

EN 60900

Ø	Ø	L	Ø1	
mm	mm	mm	mm	
8	21,5	57	27,5	1 009200238
9	21,5	57	27,5	1 009200239
10	21,5	57	27,5	1 009200240
11	21,5	57	27,5	1 009200241
12	23,0	57	27,5	1 009200242
13	23,0	57	27,5	1 009200243
14	23,0	57	27,5	1 009200244
16	23,0	57	27,5	1 009200246
17	30,0	57	27,5	1 009200247
18	32,0	57	27,5	1 009200248
19	32,2	57	27,5	1 009200249
20	32,0	57	27,5	1 009200250
21	34,0	57	27,5	1 009200251
22	36,0	57	27,5	1 009200252
24	39,0	57	27,5	1 009200254
27	42,0	57	27,5	1 009200257
30	44,0	57	27,5	1 009200260
32	48,0	57	27,5	1 009200262

920MQ/PE

chiavi a bussola maschio esagonale

12"



1000 V

EN 60900

Ø	L	L1	
mm	mm	mm	
★4	28,5	94,50	10,5 1 009200264
★5	28,5	94,5	10,5 1 009200265
★6	28,5	94,5	10,5 1 009200266
★8	28,5	94,5	10,5 1 009200268
10	28,5	94,5	10,5 1 009200267
12	28,5	94,5	10,5 1 009200269

920MQ/21

prolunga quadro maschio e femmina 1/2"

12"



1000 V

EN 60900

L	Ø	
mm	mm	
135	28	1 009200804

920MQ/22

prolunga quadro maschio e femmina 1/2"

12"



1000 V

EN 60900

L	Ø	
mm	mm	
264	30	1 009200805

920MQ/T

quadro maschio 1/2", a T

12"



1000 V

EN 60900

L	L1	
mm	mm	
200	163	1 009200807

920MQ/55A

cricchetto reversibile con attacco quadro maschio 1/2" con sistema di bloccaggio bussola

12"



1000 V

EN 60900

L	D	A
mm	mm	mm
240	50	89

920MQ/C16

9 chiavi a bussola esagonali
3 chiavi a bussola esagonali maschio
e 4 accessori

12"



Δ 1000 V

EN 60900

920MQ/C16

1 009200917

- 920MQ/A 8 - 10 - 12 - 13 - 14 - 17 - 19 - 22 - 24 mm
- 920MQ/PE 5 - 6 - 8 mm
- 920MQ/21 135 mm
- 920MQ/22 264 mm
- 920MQ/55A
- 920MQ/T

420x280x60 mm - 5,2 kg

943MQ

chiavi a bussola esagonale
con impugnatura



EN 60900

\varnothing mm	L mm	L1 mm	D mm	
5,5	233	125	12,2	1 009430235
6	233	125	12,5	1 009430236
7	240	125	14,3	1 009430237
8	240	125	15,3	1 009430238
10	252	125	17,3	1 009430240
13	252	125	21,3	1 009430243

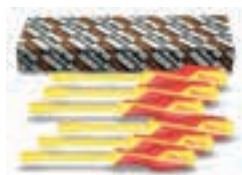

943MQ/S6

5,5-6-7-8-10-13 mm

1 009430250

951MQ

chiavi a T maschio esagonale



EN 60900

mm	L mm	L1 mm	
3	120	105	1 009510703
* 4	165	105	1 009510704
* 5	170	105	1 009510705
* 6	168	105	1 009510706
* 8	165	105	1 009510708
10	200	105	1 009510710

993MQ

pinzetta a molla a punte curve
arrotondate, zigrinate



EN 60900

L mm	
147	1 009930040

994MQ

pinzetta a molla a punte diritte
arrotondate, zigrinate



EN 60900

L mm	
145	1 009940040

1010MQ

pinze a becchi toni lunghi



EN 60900

L mm	L1 mm	
160	51,5	1 010100096

1048MQ

pinze regolabili a cerniera chiusa

• Finitura cromata

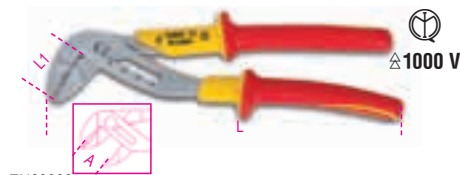

EN60900

L mm	A max mm	L1 mm	
250	48	39	1 010480315

1082MQ

tronchesi a taglienti diagonali



EN 60900

L mm	L1 mm	\varnothing mm	
140	20	1,6	1 010820094
160	22	1,6	1 010820096

1084MQ

tronchesi a grande effetto
a taglienti diagonali



EN 60900

L mm	L1 mm	\varnothing mm	
200	26	2,0	1 010840100

1088MQ

tronchesi a taglienti frontali



EN 60900

L mm	L1 mm	\varnothing mm	
160	7	1,6	1 010880096

2115P L-MQ32



2115PL-MQ32

350

1128MQ

forbici per elettricisti
lame in acciaio inossidabile
con microdentatura



IEC60900

L mm	L1 mm	
145	45	1 011280101

1132MQ

tagliacavi
per cavi flessibili in rame e alluminio



EN 60900

L mm	\varnothing mm	
230	18	1 011320193

1142MQ

pinza spallafili



EN 60900

L mm	mm ²	1	011420096
160	0,5÷6	1	011420096

1150MQ

pinze universali cromate



EN 60900

L mm	L1 mm	mm	1	011500096
160	37	1,6	1	011500096
180	39	1,8	1	011500098
200	43	2,0	1	011500100
220	46	2,0	1	011500102

1162MQ

pinze a becchi piatti
lunghe diritti



EN 60900

L mm	L1 mm	mm	1	011620096
160	56	1,6	1	011620096
200	76	1,6	1	011620100

1164MQ

pinze a becchi piatti
lunghe piegati

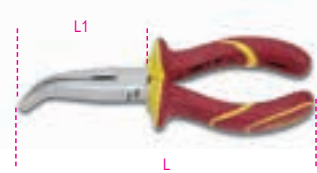

L mm	L1 mm	mm	1	011640096
160	54	1,6	1	011640096
200	76	1,6	1	011640100

1166MQ

pinze a becchi mezzotondi
lunghe diritti



EN 60900

L mm	L1 mm	mm	1	011660096
160	56	1,6	1	011660096
200	76	1,6	1	011660100

1168MQ

pinze a becchi mezzotondi
lunghe piegati

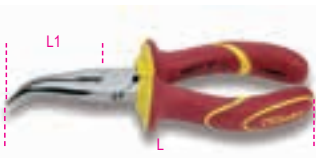

EN 60900

L mm	L1 mm	mm	1	011680096
160	50	1,6	1	011680096
200	70	1,6	1	011680100

1272MQF

giravite per viti con impronta a croce Phillips®

Slim

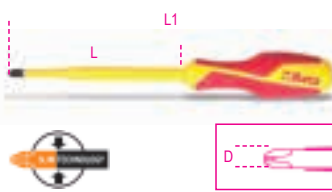

EN60900

PHxDxL mm	L1 mm	3	012720609
1x4,5x80	187	3	012720609
2x6x100	218	3	012720618

1272MQ

giravite per viti con impronta
a croce Phillips®

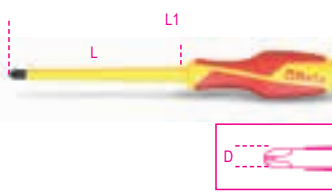

EN 60900

PHxDxL mm	L1 mm	3	012720703
0x3x60	160	3	012720703
1x4,5x80	187	3	012720709
2x6x100	218	3	012720718
3x8x150	276	2	012720724
4x10x200	326	2	012720727

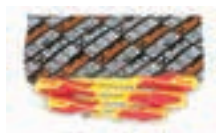

1272MQ/S5	1	012720751
PH0x3x60-PH1x4,5x80	1	012720751
PH2x6x100-PH3x8x150		
PH4x10x200 mm		

1273MQF/D...

serie di 6 giravite slim



1273MQF/D4	1	012730604
------------	---	-----------

1272MQF	1x4,5x80-2x6x100 mm	
1274MQF	0,6x3,5x100-1x5,5x125 mm	

1273MQF/D6	1	012730606
------------	---	-----------

1272MQF	1x4,5x80-2x6x100 mm	
1274MQF	0,6x3,5x100-1x4,5x100-1x5,5x125-1,2x6,5x150 mm	

1273MQ/D6

serie di 6 giravite



1273MQ/D6	1	012730851
-----------	---	-----------

1274MQ	0,5x3x100 -0,8x4x100 1,0x5,5x125 mm	
1272MQ	PH0x3x60 -PH1x4,5x80 PH2x6x100 mm	

1274MQF

giravite per viti senza testa con intaglio

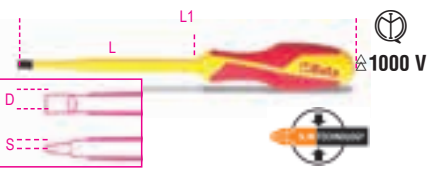

EN60900

SxDxL mm	L1 mm	3	012740603
0,6x3,5x100	200	3	012740603
1x4,5x100	205	3	012740606
1x5,5x125	232	3	012740609
1,2x6,5x150	268	3	012740612

1274MQ

giravite per viti senza testa
con intaglio

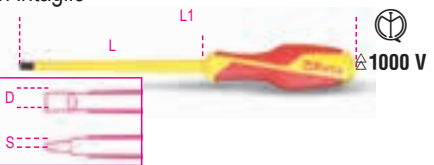

EN 60900

SxDxL mm	L1 mm	3	012740700
0,4x2,5x75	175	3	012740700
0,5x3x100	200	3	012740703
0,8x4x100	207	3	012740706
1x5,5x125	232	3	012740709
1,2x6,5x150	268	3	012740712
1,2x8x175	301	2	012740715
1,6x10x200	326	2	012740718

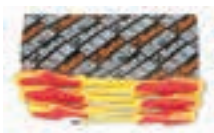

1274MQ/S6

0,5x3x100-0,8x4x100
1x5,5x125-1,2x6,5x150
1,2x8x175-1,6x10x200 mm

1 012740751

1275MQ/C

giravite per viti a croce combinata PH + intaglio

Slim

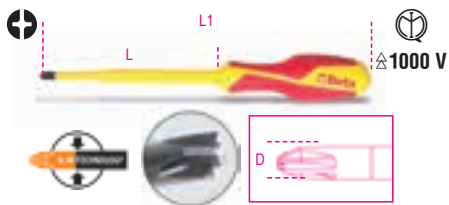

EN60900

PH1+LPP 2 012750409
PH2+LPP 2 012750418

1276MQ/C

giravite per viti a croce combinata PZ + intaglio

Slim

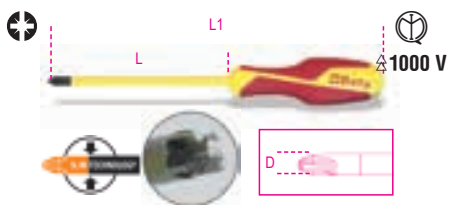

EN 60900

PZ1+LPP 2 012760409
PZ2+LPP 2 012760418

1279MQ/F

giravite per viti con impronta a croce Pozidriv®-Supadriv®

Slim

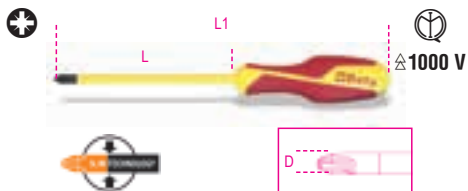

EN60900

pz	L mm	L1 mm	
1	80	187	3 012790409
2	100	218	3 012790418

1279MQ

giravite per viti con impronta a croce Pozidriv®-Supadriv®



EN 60900

PZ	L mm	L1 mm	
0	60	160	3 012790703
1	80	187	3 012790709
2	100	218	3 012790718
3	150	276	2 012790724



1279MQ/S4
PZ 0-1-2-3

1 012790751

1725MQ

miniseghetto



EN 60900

1725MQ	L mm	H mm	
	260	85	1 017250030

1777MQ/C

coltello spellacavi isolato

per cavi multipolari



EN 60900

1777MQ/C	L mm	
	190	1 017770026

1777MQ/U

coltello spellacavi isolato

per cavi unipolari



EN 60900

1777MQ/U	L mm	
	190	1 017770011

1777RL/U

4 lame di ricambio per cutter 1777MQ/U



1777RL/U		
		1 017770021

1995MQ/T

tappeto isolante

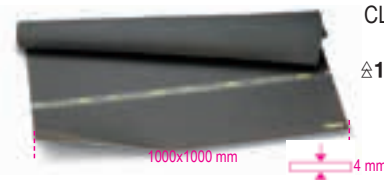

CLASS 4
1000 V

VDE 0303
EN 60243

1995MQ/T	LxSxH mm	
	1000x1000	1 019950030

1995MQ/G1 - G2

guanti isolanti, in lattice

CE 1000 V



EN 60903

1995MQ/G1	Gr.	L mm	
	9	410	1 019950010
1995MQ/G2	10	410	1 019950013

1996MQ/T

telo isolante

500x500mm

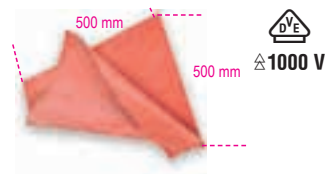

DIN EN 61112

1996MQ/T	S mm	
	1.0	1 019960005

1996MQ/GM

guanti isolanti compositi

CE 1000 V



EN 60903
EN 61482

1996MQ/GM 9	Gr.	L mm	
	9	410	1 019960109
1996MQ/GM 10	10	410	1 019960110

1996SVG

strumento per la verifica pneumatica dei guanti isolati

obbligatoria per la EN90603



1996SVG		
		1 019960133



UTENSILI ANTICADUTA

Beta H-SAFE

La gamma di utensili H-SAFE di Beta comprende più di 200 referenze, per le quali è stato progettato individualmente un sistema di trattenimento in grado di resistere alle più severe sollecitazioni meccaniche come garanzia di massima sicurezza.

Anche il confort nell'utilizzo è importante, infatti gli utensili con doppia parte attiva, come la chiave di manovra art. 42, sono allacciati con un cavo che può scorrere lungo tutto il corpo dell'utensile, mentre gli utensili manovrati con torsione, ad esempio il giravite, sono allacciati con anelli a rotazione libera per non indurre attorcigliamenti nel laccio.



Il sistema di trattenimento H-SAFE è stato ideato, testato e prodotto negli stabilimenti Beta. Col sistema di sicurezza H-SAFE di Beta gli utensili sono sempre a portata di mano in modo confortevole e sicuro.

35HS

scalpelli nervati
con sistema anticaduta H-SAFE



L mm	A mm		
200	23,0	1	000354004
250	28,5	1	000354005

42HS

chiavi combinate
con sistema anticaduta H-SAFE



DIN 3113 UN-ISO 7738

Ø mm	L mm		
6x6	95	1	000424506
7x7	105	1	000424507
8x8	116	1	000424508
9x9	127	1	000424509
10x10	137	1	000424510
11x11	148	1	000424511
12x12	158	1	000424512
13x13	169	1	000424513
14x14	180	1	000424514
15x15	190	1	000424515
16x16	201	1	000424516
17x17	212	1	000424517
18x18	222	1	000424518
19x19	233	1	000424519
20x20	243	1	000424520
21x21	254	1	000424521
22x22	264	1	000424522
23x23	275	1	000424523
24x24	285	1	000424524
25x25	296	1	000424525
26x26	307	1	000424526
27x27	317	1	000424527
28x28	328	1	000424528
29x29	338	1	000424529
30x30	349	1	000424530
32x32	370	1	000424532
34x34	391	1	000424534
36x36	412	1	000424536

42HS/AS

chiavi combinate
con sistema anticaduta H-SAFE



Ø mm	L mm		
1/4x1/4	95	1	000424106
5/16x5/16	116	1	000424108
3/8x3/8	137	1	000424110
7/16x7/16	148	1	000424111
1/2x1/2	169	1	000424113
9/16x9/16	180	1	000424114
5/8x5/8	201	1	000424116
11/16x11/16	212	1	000424117
3/4x3/4	233	1	000424119
13/16x13/16	254	1	000424121
7/8x7/8	264	1	000424122

mm	L mm		
15/16x15/16	285	1	000424124
1x1	296	1	000424125
1.1/16x1.1/16	317	1	000424127
1.1/8x1.1/8	338	1	000424129
1.1/4x1.1/4	370	1	000424132
1.5/16x1.5/16	391	1	000424133

55HS

chiavi a forchetta doppie
con sistema anticaduta H-SAFE



UNI-ISO 10102 DIN 3110

mm	L mm		
6x7	120	1	000554012
8x9	140	1	000554021
10x11	155	1	000554030
12x13	170	1	000554042
14x15	185	1	000554054
16x17	202	1	000554060
18x19	220	1	000554066
20x22	236	1	000554075
21x23	245	1	000554078
22x24	245	1	000554081
24x27	262	1	000554090
30x32	297	1	000554108
34x36	325	1	000554117

91HS-C

chiavi poligonali curve con leva di manovra
con sistema anticaduta H-SAFE



mm	Ø mm		
36	54	1	000914036
41	62	1	000914041
46	69	1	000914046

effettuare il cambio utensile (bussole, chiavi o lame)
esclusivamente a terra

91HS

chiavi poligonali curve

con sistema anticaduta H-SAFE



mm	Ø mm		
36	54	1	000914236
41	62	1	000914241
46	69	1	000914246

effettuare il cambio utensile (bussole, chiavi o lame)
esclusivamente a terra

92HS

leve di manovra per art. 91HS
con sistema di anticaduta H-SAFE



L mm	91 mm	Ø mm		
610	32+41	22	1	000924020
760	46+55	25	1	000924030

93HS

chiave per ponteggi
con sistema anticaduta H-SAFE



mm	L mm		
21x22	310	1	000934021

96TBP-HS

chiavi maschio esagonale piegate con
estremità sferica
ed impugnatura di manovra
con sistema anticaduta H-SAFE



Ø mm	L mm	L1 mm	Ø mm		
2,5	153	55	4	1	000964685
3	153	55	4	1	000964686
4	179	70	5	1	000964687
5	200	84	6	1	000964688
6	221	103	7	1	000964689
8	255	117	10	1	000964690
10	285	132	12	1	000964692

96THS

chiavi maschio esagonale piegate
con impugnatura di manovra
con sistema anticaduta H-SAFE



mm	L mm	L1 mm		
2,5	153	55	1	000964935
3	153	55	1	000964936
4	179	70	1	000964938
5	200	84	1	000964940
6	221	103	1	000964941
8	255	117	1	000964943
10	285	132	1	000964945

96THS-AS

chiavi maschio esagonale piegate
con impugnatura di manovra
con sistema anticaduta H-SAFE



mm	L mm	L1 mm	Ø mm		
5/32	200	84	6	1	000964673
3/16	200	84	6	1	000964674
7/32	221	103	7	1	000964675
1/4	236	106	8	1	000964676
5/16	255	117	10	1	000964678
3/8	285	132	12	1	000964680

97TTXHS

chiavi maschio piegate
con impugnatura
per viti con impronta Torx®

con sistema anticaduta H-SAFE



Ø	L mm	L1 mm		
T10	179	70	1	000974710
T15	179	70	1	000974715
T20	179	70	1	000974720
T25	179	70	1	000974725
T30	200	84	1	000974730
T40	221	103	1	000974740
T45	236	106	1	000974745
T50	255	117	1	000974750

111E-HS

chiavi regolabili a rullino cromate con scala
graduata

con sistema anticaduta H-SAFE

- Rotazione destrorsa del rullino
- Scala millimetrata e in pollici



DIN 3117 ISO 6787

L mm	L "	A max mm		
200	8	29	1	001114120
250	10	34	1	001114125
300	12	40	1	001114130
380	15	45	1	001114138
450	18	54	1	001114145

142HS

chiavi combinate a cricchetto reversibile

con sistema anticaduta H-SAFE



mm	L mm		
8x8	136	1	001424008
9x9	143	1	001424009
10x10	159	1	001424010
11x11	168	1	001424011
12x12	174	1	001424012
13x13	180	1	001424013
14x14	190	1	001424014
15x15	200	1	001424015
16x16	216	1	001424016
17x17	233	1	001424017
18x18	239	1	001424018
19x19	248	1	001424019
21x21	285	1	001424021
22x22	285	1	001424022
24x24	325	1	001424024
27x27	355	1	001424027
30x30	420	1	001424030
* 32x32	420	1	001424032

* modello diritto senza invertitore

360HS

giratubi modello Stillson

con sistema anticaduta H-SAFE



L mm	Ø max " mm		
250	1" gas	1	003604025
350	1 1/2" gas	1	003604035
450	2" gas	1	003604045
600	2 1/2" gas	1	003604060



LC system, sistema di trattenimento a doppia sfera. Il rilascio della bussola avviene solo col pulsante

666HS

Chiavi dinamometriche a scatto con cricchetto reversibile per serraggi destrorsi precisione di serraggio $\pm 3\%$

con sistema anticaduta H-SAFE



ISO 6789

Nm	Kgfm	lbf.ft	■	D mm	A mm	L mm	g
10÷50	1÷5	7÷37	3/8	30	33	312	660

666HS/5 1 006664005

Nm	Kgfm	lbf.ft	■	D mm	A mm	L mm	g
20÷100	2÷10	15÷75	3/8	30	33	381	730

666HS/10 1 006664010

Nm	Kgfm	lbf.ft	■	D mm	A mm	L mm	LC system *	g
40÷200	4÷20	30÷150	1/2	40	43	470	*	1010

666HS/20LC 1 006664021

Nm	Kgfm	lbf.ft	■	D mm	A mm	L mm	LC system *	g
60÷300	6÷30	50÷220	1/2	40	43	598	*	1380

666HS/30LC 1 006664031

900E-HS/55

cricchetti reversibili

con sistema anticaduta H-SAFE

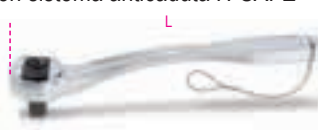

DIN 3122 - UNI-ISO 3315

L mm	Ø mm	A mm	■		
125	25	18	1/4	1	009004880

910E-HS/55

cricchetti reversibili

con sistema anticaduta H-SAFE



DIN 3122 - UNI-ISO 3315

L mm	Ø mm	A mm	■		
200	30	33	3/8	1	009104880

920E-HS/55LC

cricchetti reversibili "LC System" con sistema anticaduta H-SAFE



DIN 3122 - UNI-ISO 3315

L mm	Ø mm	A mm	■		
275	40	43	1/2	1	009204860

932HS

chiavi a pipa doppie esagonali-poligonali cromate lucide

con sistema anticaduta H-SAFE



NF E 74.303

mm	Ø mm	L mm		
6x6	11,5	110	1	009324006
7x7	12,5	116	1	009324007
8x8	13,0	120	1	009324008
9x9	14,0	125	1	009324009
10x10	16,5	133	1	009324010
11x11	17,5	143	1	009324011
12x12	19,0	148	1	009324012
13x13	19,5	154	1	009324013
14x14	21,5	167	1	009324014
15x15	22,5	182	1	009324015
16x16	24,5	193	1	009324016
17x17	26,0	198	1	009324017
18x18	26,5	215	1	009324018
19x19	29,0	220	1	009324019

1032HS

pinze a becchi diritti per anelli elastici di sicurezza, per fori manici ricoperti in PVC

con sistema anticaduta H-SAFE



UNI 7914 DIN 5256

L mm	Ø mm	Ø1 mm	A mm		
140x1,3	12÷25	1,3	20	1	010324014
180	19÷60	1,9	21	1	010324017



Beta

1034HS

pinze a becchi piegati a 90°
per anelli elastici di sicurezza, per fori
manici ricoperti in PVC

con sistema anticaduta H-SAFE



UNI 7914 DIN 5256

L	Ø	Ø1	A		
mm	mm	mm	mm		
170	19+60	1,9	21	1	010344017

1036HS

pinze a becchi dritti
per anelli elastici di sicurezza per alberi
manici ricoperti in PVC

con sistema anticaduta H-SAFE



UNI 7915 DIN 5254

L	Ø	Ø1	A		
mm	mm	mm	mm		
140x1,3	10+25	1,3	20	1	010364014
175	19+60	1,9	21	1	010364017

1038HS

pinze a becchi piegati a 90°
per anelli elastici di sicurezza per alberi
manici ricoperti in PVC

con sistema anticaduta H-SAFE



UNI 7915 DIN 5254

L	Ø	Ø1	A		
mm	mm	mm	mm		
175	19+60	-	21	1	010384017

1048BM-HS

pinza regolabile a cerniera chiusa,
impugnatura bimatériale

con sistema anticaduta H-SAFE

· modello a nove posizioni

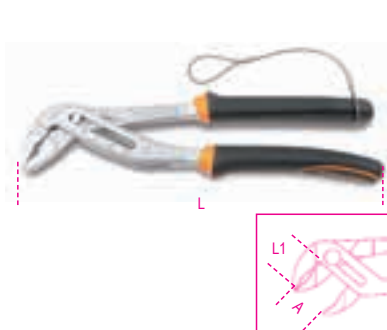

ISO 8976

L	A max	L1	g		
mm	mm	mm	g		
250	48	39	460	1	010484215

1052HS

pinze regolabili autobloccanti
ganasse concave

con sistema anticaduta H-SAFE

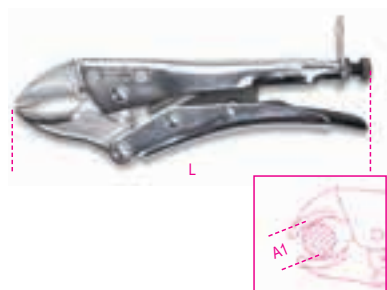

L	A	A1 max	S		
mm	mm	mm	mm		
240	72	42	10,0	1	010524024

1082BM-HS

tronchesi a taglienti diagonali
impugnatura bimatériale

con sistema anticaduta H-SAFE



UNI/ISO 5749

L	L1	mm	A		
mm	mm	mm	mm		
160	22	1,6	28,0	1	010824036

1088BM-HS

tronchesi a grande effetto
a taglienti frontali
impugnatura bimatériale

con sistema anticaduta H-SAFE

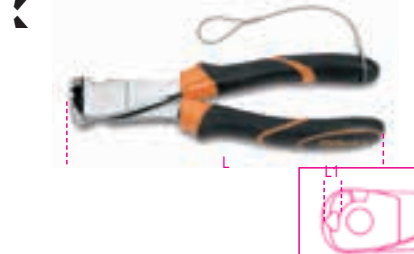

UNI/ISO 5748

L	L1	mm	A		
mm	mm	mm	mm		
160	9	1,6	28,0	1	010884036
200	11	2,0	36,0	1	010884040

1128BAX-HS

forbici per elettricisti a **doppio effetto**,
con profili a fresa in acciaio inossidabile
rivestito in DLC

con sistema anticaduta H-SAFE

taglio a doppio effetto: attraverso una speciale camma sul fulcro si ottiene uno scorrimento longitudinale delle lame che, nella fase di chiusura, ne aumenta la potenza di taglio.

profilo e fresa: studiate per allargare fori su plastica da 13 a 25 mm.

rivestimento DLC: Il DLC (diamond-like carbon) è un rivestimento innovativo a base di carbonio: l'elevata durezza ed il basso coefficiente d'attrito nascono dalla simultanea presenza di carbonio depositato sulla superficie in forma di grafite e diamante.

- alta durezza superficiale delle lame (resistenza all'abrasione e mantenimento dell'affilatura nel tempo)
- basso coefficiente di attrito (scorrevolezza e potenza di taglio)
- perno eccentrico antiallentamento
- manici ampi con gole strozzatubi



L	L1	mm²			
mm	mm	mm²			
150	50	50	1	011284088	

Beta

Beta

1132BM-HS

tagliacavi
impugnatura bimatereale
per cavi isolati in rame e alluminio

con sistema anticaduta H-SAFE



UNI 8791

L	$\frac{A}{B}$	A	B		
mm	mm	mm	mm	1	011324143
230	18	37	12,5		

1150BM-HS

pinze universali a grande effetto,
cromate,
impugnatura bimatereale

con sistema anticaduta H-SAFE

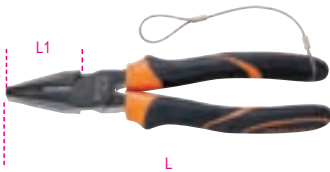

ISO 5746

L	L1	$\frac{A}{B}$	A		
mm	mm	mm	mm	1	011504146
160	42	1,6	22,0		
180	46	1,8	25,0		011504148
200	50	2,0	27,0		011504150

1166BM-HS

pinze a becchi mezzotondi lunghissimi
diritti zigrinati
impugnatura bimatereale

con sistema anticaduta H-SAFE



ISO 5745

L	L1	$\frac{A}{B}$	A		
mm	mm	mm	mm	1	011664040
200	76	1,6	22,0		

1168BM-HS

pinze a becchi mezzotondi lunghissimi
piegati zigrinati
impugnatura bimatereale

con sistema anticaduta H-SAFE



ISO 5745

L	L1	$\frac{A}{B}$	A		
mm	mm	mm	mm	1	011684040
200	70	1,6	22,0		

1290HS

giravite per viti a testa con intaglio

con sistema anticaduta H-SAFE

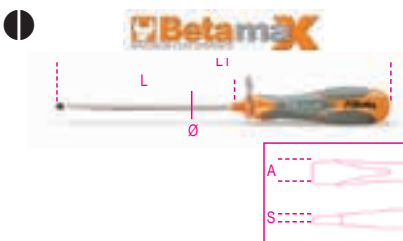

ISO 2380

SxAxL	L1	Ø		
mm	mm	mm	1	012904006
0,4x2,5x75	171	2,5		
0,5x3x100	196	3,0		012904012
0,6x3,5x100	196	3,5		012904021
0,8x4x100	196	4,0		012904030
0,8x4x150	246	4,0		012904036
1x5,5x150	259	5,0		012904042
1,2x6,5x150	270	6,0		012904051
1,2x8x150	282	7,0		012904057
1,6x10x200	332	8,0		012904066

1292HS

giravite per viti
con impronta a croce Phillips® H-SAFE

con sistema anticaduta H-SAFE



UNI/ISO 8764

PHxDxL	L1		
mm	mm	1	012924006
0x3x100	196		012924012
1x4,5x120	229		012924021
2x6x150	270		012924021
3x8x150	282		012924024

1294HS

giravite per viti senza testa
con intaglio

con sistema anticaduta H-SAFE

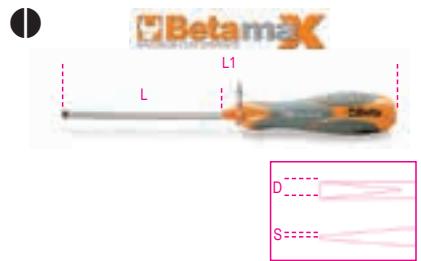

SxDxL	L1		
mm	mm	1	012944003
0,5x2,5x60	156		012944006
0,6x3x75	171		012944012
0,8x4x100	196		012944018
1x5x125	234		

1299HS

giravite per viti con impronta
a croce Pozidriv®-Supadriv®

con sistema anticaduta H-SAFE

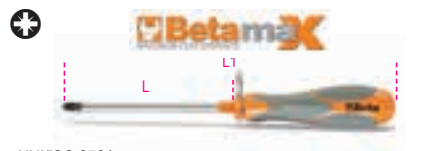

UNI/ISO 8764

PZ	L	L1		
	mm	mm	1	012994000
0	60	156		012994003
1	80	189		012994006
2	100	220		012994006
3	150	282		012994009

1370T-HS

martelli tipo tedesco
per meccanici
manico in fibra

con sistema anticaduta H-SAFE



g	A	L	L1		
	mm	mm	mm	1	013704630
300	23	300	105		013704650
500	27	320	118		013704700
1000	36	360	135		

Beta

Beta

1370FT-HS

martelli tipo francese per meccanici,
manico in fibra

con sistema anticaduta H-SAFE



A	L	L1	B		
mm	mm	mm	mm		
28	280	86	22	1	013704528
30	280	92	24	1	013704530
36	300	104	29	1	013704536

1390HS

mazzuole con battenti intercambiabili
in materiale plastico
manico in legno

con sistema anticaduta H-SAFE



UNI 7784

D	L	L1		
mm	mm	mm		
35	310	95	1	013904035
45	320	107	1	013904045

1392HS

mazzuole antirimbalo
con battenti intercambiabili
in materiale plastico
manico in acciaio

con sistema anticaduta H-SAFE



D	L	L1		
mm	mm	mm		
35	305	115	1	013924035
40	310	125	1	013924040
50	325	135	1	013924050
60	385	155	1	013924060

1602A-HS

pinza per capicorda preisolati
modello standard

con sistema anticaduta H-SAFE

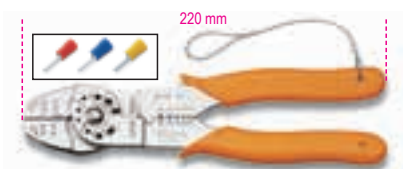

mm ²	L	A	B		
	mm	mm	mm		
0+6	220	42	4	1	016024005

1682HS

righe flessibili graduate
in acciaio inossidabile

con sistema anticaduta H-SAFE

- doppia scala millimetrata
- antiriflesso



L	H	±		
mm	mm	mm		
200	13	0,5	1	016824020
300	13	0,5	1	016824030

1692HS

flessometri
cassa bimerale in ABS antiurto
nastro in acciaio
classe di precisione II

con sistema anticaduta H-SAFE

CE



L	S		
m	mm		
3	16	1	016924053
5	19	1	016924055

1708HS/20

spessimetri

con sistema anticaduta H-SAFE



S	S	L		
mm	mm	mm		
0,05±1,0	0,002±0,040	105	1	017084020

1727HS

seghetto tipo pesante

con sistema anticaduta H-SAFE



L	L1		
mm	mm		
515	300	1	017274001

1743HS

pinza per fascette in Nylon

con sistema anticaduta H-SAFE

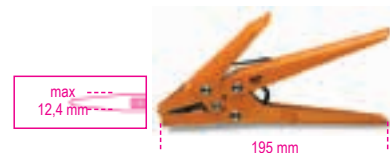

L	A	B		
mm	mm	mm		
195	85	17	1	017434001

1750HS

compressori a leva per grasso

con sistema anticaduta H-SAFE



1 g, 550 bar Max

cc	L		
mm	mm		
500	380	1	017504500

1760BHS

multimetro digitale

con sistema anticaduta H-SAFE



PARAMETRI RILEVABILI

Tensione DC: 200 mV-2/20/200/1000V

Tensione AC: 2-20/200/700V

Corrente DC: 2/20/200 mA-20 A

Corrente AC: 2/200 mA- 20 A

Resistenza: 200Ω - 2/20/200 kΩ - 2/20 MΩ

Capacità: 2/20/200 nF - 2/200 μF

Temperatura: -20° + 1000°C/ -4 °F ~ +2000°F

Frequenza: 20kHz

Alimentazione: 1 batteria da 9V (inclusa)

1760BHS	1	017604012
---------	---	-----------

1772H-HS

cutter a lama retrattile di sicurezza,
fornito con 2 lame

con sistema anticaduta H-SAFE



L mm	A mm	1	017724029
170	18		

1778SOS-HS

coltello soccorso auto
con funzione martello frangicristallo
e tagliacinture di sicurezza
• in astuccio

con sistema anticaduta H-SAFE



L mm	A mm	L1 mm	1	017784080
205	25	85		

8871

cinturone di sicurezza
con fibbia metallica a doppia chiusura,
per il collegamento degli utensili H-SAFE



L cm	1	088710070
min-max		
70-100		
100	1	088710100
100-135		

8872A

passante fisso

• Per cinturone 8871



8872A 50	1	088720050
----------	---	-----------

8872AS

passante apribile a strappo

• Per cinturone 8871



8872AS 25	D mm	1	088720525
	25		

8873

Sacca portautensili
con chiusura autoserrante e zip

• Per cinturone 8871



8873	1	088730230
------	---	-----------

8877

laccio di collegamento ammortizzato

• MAX 2.7 kg



8877 80	L cm min+max	DxL mm	1	088770080
	70-110	40x80		

8877M

laccio di collegamento ammortizzato

• Con giunto anti-attorcigliamento
• MAX 2.7 kg



8877M	L cm min+max	DxL mm	1	088770510
	20-140	30x60		

8879

polsiera a strappo

• MAX 2.7 kg



8879	D mm	1	088790025
	30		

8880

laccio di collegamento non ammortizzato

• Con giunto
anti-attorcigliamento



8880	L Cm	D mm	1	088800030
	30	10		

8883

sacca portautensili

• In nylon 840 antiabrasione
• MAX 20 kg
• Moschettone per bloccare
la zip a fine corsa
• 6 lacci trattieni-utensile
• Tasca interna



8883	DxH cm	1	088830030
	30x40		



UTENSILI INOX



L'**acciaio inossidabile** è un acciaio legato con una elevata percentuale di cromo. Il cromo crea una patina superficiale di ossido che protegge il metallo e che si riforma immediatamente in caso di danneggiamento chimico o meccanico.

Sfruttando questa straordinaria caratteristica, **Beta Utensili** ha ideato la linea **Beta Inox**, una gamma di utensili che garantiscono elevata resistenza alla corrosione e spiccate caratteristiche di **igienicità e bassa ritentività batterica**. Gli utensili realizzati in acciaio inossidabile, infatti, **si sporcano meno e si puliscono meglio** di quelli realizzati con altri materiali, e possono essere **sterilizzati in autoclave a 121°C**.

Gli utensili **Beta Inox** possono essere utilizzati in **ambienti critici**, ovvero zone e aree in cui non è ammesso il minimo livello di contaminazione.

Campi di applicazione:

- Industria alimentare
- Produzione farmaceutica CLASSE C
- Laboratori biotecnologici e biomedici
- Applicazioni nucleari

Gli utensili **Beta Inox** evitano fenomeni di contaminazione ferrosa, con conseguente presenza di **ruggine impropria**. Quando si utilizzano utensili realizzati con comuni acciai al carbonio su viti, dadi o superfici in acciaio inossidabile, dagli utensili si possono disperdere particelle di ferro che generano problemi estetici (**macchie di ruggine**) che, se trascurati, innescano processi di corrosione localizzati. L'utilizzo di



INOX + NO INOX
= RUGGINE



INOX + INOX
= NO RUGGINE

utensili in acciaio inossidabile esclude completamente la diffusione di particelle inquinanti.

Campi di applicazione:

- Cantieri navali
- Edilizia
- Applicazioni offshore
- Impianti solari
- Industria automobilistica

Caratteristiche meccaniche

Gli utensili Beta sono realizzati in **acciaio AISI 420**, magnetico e con elevate caratteristiche meccaniche che permettono di costruire utensili che raggiungono prestazioni ampiamente superiori ai valori di norma e comparabili ai normali utensili Beta. L'ergonomia e il design sono gli stessi degli utensili Beta, conosciuti e apprezzati dagli utilizzatori professionali da più di 80 anni. I contenitori sono realizzati in **acciaio AISI 304**, che ha elevate caratteristiche di formabilità a freddo e una resistenza alla corrosione ancora maggiore.

Riciclabilità

L'acciaio inossidabile è **riciclabile al 100%**. Anche questa è una caratteristica importante.



Marchio per i prodotti in acciaio inossidabile
È un marchio rilasciato dal Centro Inox –
Associazione per lo studio e lo sviluppo degli
acciai inossidabili, che caratterizza i prodotti
realizzati in acciaio inossidabile.

34INOX

scalpelli piatti,
in acciaio inossidabile

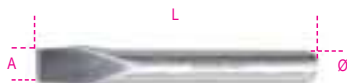

L mm	A mm	Ø mm		
160	18	18	1	000340318
200	20	20	1	000340320

39INOX

cunei,
in acciaio inossidabile



L mm	A mm	S mm		
100	50	10	1	000390310
150	50	13	1	000390315
200	40	40	1	000390320

42INOX

chiavi combinate,
in acciaio inossidabile



DIN 3113 - UNI ISO 7738

Ø mm	L mm		
6x6	95	2	000420306
7x7	105	2	000420307
8x8	116	2	000420308
9x9	127	2	000420309
10x10	137	2	000420310
11x11	148	2	000420311
12x12	158	2	000420312
13x13	169	2	000420313
14x14	180	2	000420314
15x15	190	2	000420315
16x16	201	2	000420316
17x17	212	2	000420317
18x18	222	2	000420318
19x19	233	2	000420319
21x21	254	1	000420321
22x22	264	1	000420322
24x24	285	1	000420324
27x27	290	1	000420327
30x30	320	1	000420330
32x32	340	1	000420332
36x36	360	1	000420336
38x38	430	1	000420338
41x41	430	1	000420341
46x46	480	1	000420343
50x50	520	1	000420345
55x55	560	1	000420347
60x60	595	1	000420350



42INOX/S11	1	000420391
6-8-10-11-12-13-14-15-16-17-19 mm		



42INOX/SC9	1	000420387
8-10-11-12-13-14-15-17-19 mm		
42INOX/SCV9	1	000420303

42INOX-AS

chiavi combinate,
in acciaio inossidabile



Ø	L mm		
1/4x1/4	95	1	000420356
5/16x5/16	116	1	000420358
3/8x3/8	137	1	000420360
7/16x7/16	148	1	000420361
1/2x1/2	169	1	000420363
9/16x9/16	180	1	000420364
5/8x5/8	201	1	000420366
11/16x11/16	212	1	000420367
3/4x3/4	233	1	000420369
13/16x13/16	254	1	000420371
7/8x7/8	264	1	000420372
15/16x15/16	285	1	000420373



42INOX-AS/S9	1	000420396
1/4-5/16-3/8-7/16-1/2-9/16-5/8-11/16-3/4		



96BPINOX

chiavi maschio esagonale piegate con
estremità sferica,
in acciaio inossidabile



mm	L mm	L1 mm	Ø g		
2	91	22	4	4	000961441
2,5	91	22	6	4	000961442
3	101	24	11	4	000961443
4	112	29	19	4	000961444
5	131	33	32	4	000961445
6	154	36	51	4	000961446
7	164	40	65	2	000961447
8	175	44	116	2	000961448
10	197	51	189	2	000961450

96BPINOX/B6	1	000961455
2,5-3-4-5-6-8 mm		
96BPINOX/B9	1	000961456
2-2,5-3-4-5-6-7-8-10 mm		
96BPINOX/BV	1	000961459

96BPINOX-AS

chiavi maschio esagonale piegate con
estremità sferica,
in acciaio inossidabile

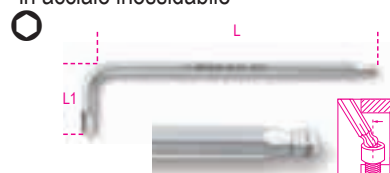

"	L mm	L1 mm	Ø g		
5/64	91	22	5,5	4	000961989
3/32	91	22	5,3	4	000961990
7/64	101	24	10,5	4	000961991
1/8	101	24	10,7	4	000961992
9/64	112	29	18,7	4	000961993
5/32	112	29	18,7	4	000961994
3/16	131	33	31,5	2	000961995
7/32	154	36	50,0	2	000961996
1/4	164	40	70,0	2	000961997
5/16	175	44	115,0	2	000961998
3/8	197	51	186,5	2	000961999

96BPINOX-AS/B8	1	000962000
5/64-3/32-1/8-5/32-3/16-7/32-1/4-5/16		
96BPINOX/BV	1	000961459

96TINOX

chiavi maschio esagonale piegate
con impugnatura di manovra,
in acciaio inossidabile



mm	L mm	L1 mm		
2,5	153	55	2	000961935
3	153	55	2	000961936
4	179	70	2	000961938
5	200	84	2	000961940
6	221	95	2	000961941
7	236	106	2	000961942
8	255	117	2	000961943
10	285	132	2	000961944



96TINOX/S5 2,5-3-4-5-6 mm	1	000961952
96TINOX/S8 2,5-3-4-5- 6-7-8-10 mm	1	000961954

96TINOX-AS

chiavi maschio esagonale piegate
con impugnatura di manovra,
in acciaio inossidabile



"	L mm	L1 mm	Ø mm		
3/32	153	55	3	2	000961861
7/64	153	55	4	2	000961862
1/8	179	70	4	2	000961863
9/64	179	70	5	2	000961864
5/32	200	84	6	2	000961865
3/16	200	84	6	2	000961866
7/32	221	103	7	2	000961867
1/4	236	106	8	2	000961868
5/16	255	117	10	2	000961869
3/8	285	132	12	2	000961870



96TINOX-AS/S7 3/32-1/8-5/32-3/16- 7/32-1/4-5/16	1	000961877
---	---	-----------

111INOX

chiavi regolabili a rullino,
in acciaio inossidabile



DIN 3117 - ISO 6787

L mm	L "	A max mm	A1 mm		
150	6	18	45	1	001110315
200	8	24	58	1	001110320
250	10	30	70	1	001110325

362INOX

giratubi modello americano,
in acciaio inossidabile



L mm	Ø max mm		
300	58	1	003620430

920INOX-A

chiavi a bussola a mano
bocca esagonale
in acciaio inossidabile

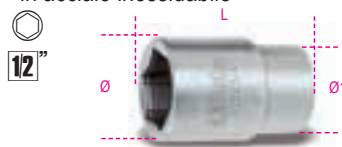

DIN 3124 - UNI ISO 2725

Ø mm	Ø mm	A mm	L mm		
8	15	10	40	2	009203008
9	16	10	40	2	009203009
10	17	10	40	2	009203010
11	18	11	40	2	009203011
12	19	11	40	2	009203012
13	20	11	40	2	009203013
14	21	11	40	2	009203014
15	23	11	40	2	009203015
16	24	11	40	2	009203016
17	25	11	40	2	009203017
18	26	13	42	2	009203018
19	28	13	42	2	009203019
20	29	13	42	1	009203020
21	30	13	43	1	009203021
22	31	15	43	1	009203022
24	34	15	43	1	009203024
27	38	18	46	1	009203027
30	42	20	46	1	009203030
32	44	20	46	1	009203032

920/55INOX

cricchetto reversibile
con attacco quadro maschio 1/2"
meccanismo a 72 denti
in acciaio inossidabile



L mm	Ø mm	A mm		
264	40	43	1	009203882

920/R55INOX

12"
72



920/R55INOX

1 009203879

1048INOX

pinza regolabile cerniera chiusa
in acciaio inossidabile

• modello a sette posizioni

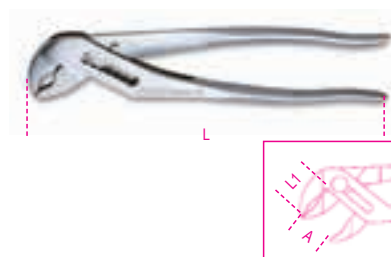

L mm	A max mm	L1 mm		
250	33	33	1	010480325

1082INOX

tronchesi a taglienti diagonali,
in acciaio inossidabile



L mm	L1 mm	mm		
150	20,0	1,6	1	010820350

1150INOX

Pinza universale a grande effetto
in acciaio inossidabile

perno decentrato
cassetta aperta



L mm	L1 mm		
180	39	1	011500518

1153INOX

pinza regolabile a due posizioni,
in acciaio inossidabile

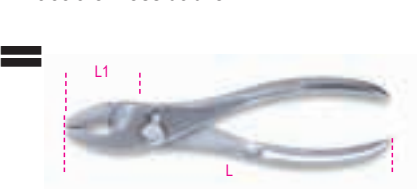

L mm	L1 mm		
150	26	1	011530315

1290INOX

giravite per viti a testa con intaglio
in acciaio inossidabile

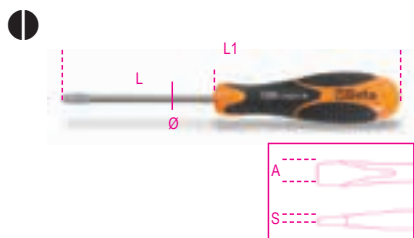

ISO 2380

SxAxL mm	L1 mm	Ø mm		
0,4x2,5x50	146	2.5	4	012900403
0,5x3x75	171	3.0	4	012900409
0,8x4x100	196	4.0	4	012900430
1,0x5,5x150	259	5.0	4	012900442
1,2x6,5x150	270	6.0	4	012900451

1292INOX

giravite per viti con impronta a croce Phillips®,
in acciaio inossidabile

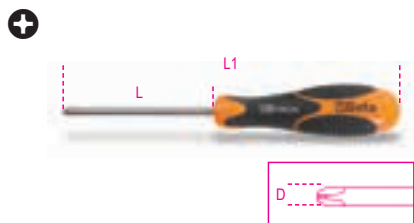

ISO 8764

PHxDxL mm	L1 mm		
0x3x60	156	4	012920403
1x4,5x80	189	4	012920409
2x6x100	220	4	012920418

1293INOX/D8

serie giravite
in acciaio inossidabile



1293INOX/D8		
1290INOX	0,4x2,5x50-0,5x3x75 0,8x4x100-1,0x5,5x150- 1,2x6,5x150 mm	1 012930408
1292INOX	PH0x60-PH1x80 PH2x100 mm	

1370INOX

martello tipo tedesco
per meccanici
in acciaio inossidabile



g	A mm	L mm	L1 mm		
500	25	240	101	1	013700375

1377INOX

martelli con testa tonda
e penna sferica
per calderai e lattonieri
in acciaio inossidabile



g	L mm	L1 mm		
230	220	82	1	013770623
340	220	90	1	013770634

1730INOX

spatola universale,
in acciaio inossidabile



A mm	L mm		
50	200	1	017300450

C20TSS

cestello estendibile a cinque scomparti
in acciaio inossidabile AISI 304



C20TSS		
	450x200x210 mm - 4kg	1 021203001



C04TSS-7

cassettiera mobile con sette cassetti
in acciaio inossidabile, con ruote antitraccia

Caratteristiche principali:

- Sette cassetti da 570 x 410 mm montati su guide telescopiche a sfera;
- 6 cassetti altezza 83 mm;
- 1 cassetto altezza 170 mm;
- Quattro ruote antitraccia con nucleo in acciaio inossidabile Ø 125mm
- 2 fisse e 2 girevoli (due con freno);
- Serratura frontale centralizzata;
- **Struttura interamente in acciaio inossidabile AISI 304**
- **Ruote, supporti, sfere, interno dei cassetti e relative guide in acciaio inossidabile**
- Maniglia cassetti in alluminio

63 kg

Beta
INOX
STAINLESS STEEL



700
kg

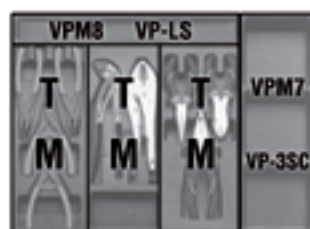

h	max
83 mm	25 kg
170 mm	30 kg

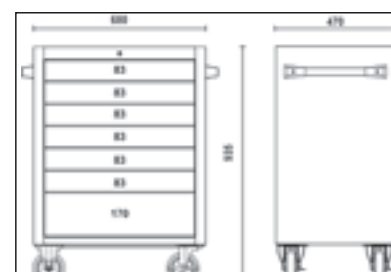
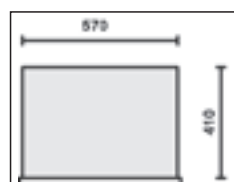



RAME-BERILLIO Cu-Be

Gli utensili Antiscintilla **Beta** sono specifici per operare in assoluta sicurezza in ambienti a potenziale rischio di esplosioni, con presenza di liquidi o gas infiammabili, o per applicazioni che richiedono l'utilizzo di utensili amagnetici e resistenti alla corrosione.

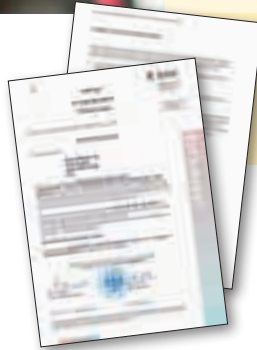

Gli utensili antiscintilla Beta sono certificati dall'Istituto per la ricerca e il collaudo BAM, secondo la Direttiva Europea 99/92/EC.



ATTENZIONE: rischio di esplosione in presenza di **ACETILENE**

Le caratteristiche meccaniche degli utensili Antiscintilla **Beta** sono diverse da quelle degli utensili normali in acciaio, devono essere usati con estrema cautela, evitando sovraccarichi.

CLASSIFICAZIONE DELLE ZONE A RISCHIO DI ESPLOSIONE

ATEX	CLASSIFICAZIONE DELLE ZONE A RISCHIO DI ESPLOSIONE	
	MEDIO BASSA	MOLTO BASSA
GAS	ZONA 1 Area in cui durante le normali attività è probabile la formazione di un'atmosfera esplosiva consistente in una miscela di aria e di sostanze infiammabili sotto forma di gas, vapore o nebbia.	ZONA 2 Area in cui durante le normali attività non è probabile la formazione di un'atmosfera esplosiva consistente in una miscela di aria e di sostanze infiammabili sotto forma di gas, vapore o nebbia e, qualora si verifici, sia unicamente di breve durata.
	ZONA 21 Area in cui occasionalmente durante le normali attività è probabile la formazione di un'atmosfera esplosiva sotto forma di nube di polvere combustibile nell'aria.	ZONA 22 Area in cui durante le normali attività non è probabile la formazione di un'atmosfera esplosiva sotto forma di nube di polvere combustibile nell'aria e, qualora si verifici, sia unicamente di breve durata.
POLVERI		

30BA

punzoni antiscintilla



Ø mm	L mm	S mm		
5	150	15	1	000300806
8	150	17	1	000300808
10	150	19	1	000300810

31BA

cacciaspina antiscintilla



Ø mm	L mm		
3	110	1	000310853
4	110	1	000310854
6	115	1	000310856
8	120	1	000310858

31BA/C

punzoni antiscintilla conici



Ø mm	Ø1 mm	L mm		
★6	12	150	1	000310876
★7	13	150	1	000310877
★12	18	175	1	000310882
★13	29	255	1	000310883

32BA

bulino antiscintilla



Ø mm	L mm		
14	150	1	000320811

34BA

scalpelli piatti antiscintilla



L mm	A mm		
200	22	1	000340801
250	24	1	000340803
300	25	1	000340802

39BA

cunei antiscintilla



L	A		
mm	mm		
150	40	1	000390801
230	40	1	000390802
250	40	1	000390803

42BA

chiavi combinate antiscintilla



mm	L		
mm	mm		
6x6	105	1	000420806
7x7	105	1	000420807
8x8	120	1	000420808
9x9	120	1	000420809
10x10	135	1	000420810
11x11	135	1	000420811
12x12	150	1	000420812
13x13	150	1	000420813
14x14	175	1	000420814
15x15	175	1	000420815
16x16	195	1	000420816
17x17	200	1	000420817
18x18	215	1	000420818
19x19	220	1	000420819
20x20	230	1	000420820
21x21	240	1	000420821
22x22	250	1	000420822
24x24	268	1	000420824
26x26	290	1	000420826
27x27	290	1	000420827
28x28	290	1	000420828
30x30	313	1	000420830
32x32	333	1	000420832
34x34	360	1	000420834
35x35	360	1	000420835
36x36	355	1	000420836
38x38	430	1	000420838
41x41	430	1	000420841
46x46	480	1	000420846
50x50	520	1	000420850
55x55	560	1	000420855
60x60	580	1	000420860
*65x65	595	1	000420865
*70x70	630	1	000420870

42BA-AS

chiavi combinate antiscintilla



mm	L		
mm	mm		
9/32x9/32	120	1	000420946
5/16x5/16	120	1	000420947
11/32x11/32	135	1	000420948
3/8x3/8	128	1	000420950
7/16x7/16	135	1	000420951
15/32x15/32	140	1	000420949
1/2x1/2	140	1	000420953
9/16x9/16	163	1	000420954

mm	L		
mm	mm		
*19/32x19/32	195	1	000420955
5/8x5/8	177	1	000420956
11/16x11/16	195	1	000420957
3/4x3/4	215	1	000420959
13/16x13/16	230	1	000420961
7/8x7/8	235	1	000420962
15/16x15/16	256	1	000420964
*31/32x31/32	265	1	000420963
1x1	266	1	000420965
1.1/16x1.1/16	283	1	000420967
1.1/8x1.1/8	297	1	000420969
1.3/16x1.3/16	308	1	000420970
1.1/4x1.1/4	324	1	000420973
*1.7/16x1.7/16	360	1	000420976

55BA

chiavi a forchetta doppie antiscintilla



mm	L		
mm	mm		
6x7	90	1	000550801
8x9	100	1	000550802
8x10	100	1	000550795
9x11	110	1	000550797
10x11	120	1	000550803
12x13	130	1	000550804
*12x14	130	1	000550846
13x14	133	1	000550799
14x15	145	1	000550805
14x17	150	1	000550806
16x17	165	1	000550807
17x19	170	1	000550847
18x19	170	1	000550809
*19x22	185	1	000550810
20x22	185	1	000550811
21x23	210	1	000550813
22x24	210	1	000550815
24x26	230	1	000550817
24x27	230	1	000550818
25x28	230	1	000550819
27x29	246	1	000550820
30x32	265	1	000550822
36x38	320	1	000550826
36x41	335	1	000550828
41x46	355	1	000550829
*46x50	370	1	000550830
*50x55	385	1	000550831
*55x60	415	1	000550832

55BA-AS

chiavi a forchetta doppie antiscintilla



mm	L		
mm	mm		
3/8x7/16	110	1	000550853
1/2x9/16	130	1	000550854
5/8x11/16	160	1	000550857
3/4x13/16	180	1	000550859
7/8x15/16	210	1	000550865
1x1.1/16	230	1	000550868
1.1/8x1.3/16	245	1	000550870
1.1/4x1.5/16	255	1	000550872

58BA

chiavi a forchetta semplici a percussione, antiscintilla



mm	L		
mm	mm		
17	125	1	000580817
19	125	1	000580819
22	135	1	000580822
24	150	1	000580824
27	165	1	000580827
30	180	1	000580830
32	190	1	000580832
*34	200	1	000580834
36	210	1	000580836
38	220	1	000580838
41	230	1	000580841
46	240	1	000580846
50	255	1	000580850
*55	305	1	000580855
*60	315	1	000580860
*65	335	1	000580865
*70	370	1	000580870
*75	375	1	000580875
*80	400	1	000580880
*85	400	1	000580885
*90	445	1	000580890
*95	445	1	000580895
*100	485	1	000580900
*110	513	1	000580901

58BA-AS

chiavi a forchetta semplici a percussione, antiscintilla



mm	L	A	S		
mm	mm	mm	mm		
*11/16	125	40,5	11,0	1	000580904
*3/4	125	40,5	11,0	1	000580905
*7/8	135	46,2	12,0	1	000580906
*15/16	150	50,3	12,0	1	000580907
*31/32	150	50,3	12,0	1	000580954
*1	175	56,9	15,0	1	000580908
*1.1/8	190	64,0	15,5	1	000580909
*1.1/4	190	64,0	15,5	1	000580910
*1.7/16	210	75,0	18,5	1	000580912
*1.1/2	220	82,0	18,5	1	000580913
*1.5/8	230	86,8	18,5	1	000580914
*1.3/4	250	98,0	20,	1	000580970

78BA

chiavi poligonali a percussione, antiscintilla



mm	L		
mm	mm		
17	145	1	000780817
19	145	1	000780819
22	165	1	000780822
24	140	1	000780824
27	155	1	000780827
30	165	1	000780830
32	180	1	000780832
34	192	1	000780834
36	208	1	000780836
38	215	1	000780838
41	225	1	000780841
46	245	1	000780846
50	250	1	000780850
55	265	1	000780855
60	275	1	000780860
65	295	1	000780865

mm	L mm		
70	310	1	000780870
75	325	1	000780875
80	340	1	000780880
*85	355	1	000780885
*90	380	1	000780890
*95	390	1	000780895
*100	410	1	000780900
*105	420	1	000780903
*110	445	1	000780901
*120	480	1	000780902

78BA-AS

chiavi poligonali a percussione, antiscintilla



mm	L mm		
11/16	145	1	000780908
3/4	145	1	000780909
7/8	155	1	000780935
15/16	165	1	000780936
*31/32	165	1	000780937
1	175	1	000780938
*1.1/16	175	1	000780939
1.1/8	180	1	000780940
1.3/16	185	1	000780941
1.1/4	177	1	000780910
*1.5/16	200	1	000780954
*1.3/8	205	1	000780911
1.7/16	208	1	000780912
*1.1/2	215	1	000780913
*1.9/16	225	1	000780947
*1.11/16	225	1	000780962
1.5/8	225	1	000780914
*1.3/4	235	1	000780963
1.13/16	243	1	000780916
1.7/8	235	1	000780915
2	254	1	000780918
2.3/16	264	1	000780920
2.3/8	275	1	000780922
*2.9/16	286	1	000780924
*2.15/16	311	1	000780926
*3.1/8	325	1	000780928
*3.1/2	355	1	000780930

89BA

chiavi poligonali semplici, antiscintilla



mm	L mm		
10	200	1	000890810
11	210	1	000890811
12	220	1	000890812
13	230	1	000890813
14	240	1	000890814
16	260	1	000890816
17	270	1	000890817
18	280	1	000890818
19	300	1	000890819
20	310	1	000890820
22	330	1	000890822
24	350	1	000890824
27	370	1	000890827
30	400	1	000890830
32	420	1	000890832

90BA

chiavi poligonali doppie antiscintilla



mm	L mm		
6x7	122	1	000900801
8x9	128	1	000900802
10x11	155	1	000900803
12x13	175	1	000900806
12x14	180	1	000900807
14x15	200	1	000900808
14x17	220	1	000900809
16x17	230	1	000900811
16x18	235	1	000900812
17x19	250	1	000900814
18x19	265	1	000900815
19x22	280	1	000900817
20x22	295	1	000900818
21x23	298	1	000900820
22x24	315	1	000900821
24x26	333	1	000900822
24x27	340	1	000900823
30x32	395	1	000900824
34x36	410	1	000900826
*36x41	450	1	000900828
*41x46	470	1	000900829
*46x50	490	1	000900830

91BA

chiavi poligonali curve antiscintilla



mm	Ø mm		
24	38	1	000910824
27	42	1	000910827
30	48	1	000910830
32	49	1	000910832
36	54	1	000910836
41	62	1	000910841
*46	69	1	000910846
*50	75	1	000910850
*55	82	1	000910855

92BA

leve di manovra per art. 91BA, antiscintilla



	L mm	91BA mm	Ø mm		
92BA/1	460	24÷30	25	1	000920810
92BA/2	610	32÷41	28	1	000920820
*92BA/3	760	46÷55	32	1	000920830

93BA

chiave a cricchetto per ponteggi antiscintilla



mm	L mm		
21x22	345	1	000930821

95BA

chiavi poligonali doppie diritte, antiscintilla



mm	L mm		
7x9	115	1	000950801
8x10	115	1	000950802
10x11	140	1	000950804
10x12	140	1	000950805
12x14	145	1	000950806
14x17	165	1	000950807
*16x18	170	1	000950809
*17x19	185	1	000950808
*18x19	185	1	000950810
*19x22	200	1	000950812
*21x23	230	1	000950815
*24x27	255	1	000950817
*30x32	295	1	000950820

96BA

chiavi maschio esagonale piegate antiscintilla



mm	L mm	L1 mm		
1,5	50	17	1	000960760
2	50	16	1	000960762
2,5	56	20	1	000960761
3	63	21	1	000960763
4	69	25	1	000960764
5	78	29	1	000960765
6	88	33	1	000960766
7	93	34	1	000960767
8	97	36	1	000960768
9	104	37	1	000960769
10	110	39	1	000960770
11	118	42	1	000960771
12	122	44	1	000960772
14	150	58	1	000960774
15	156	60	1	000960775
16	162	63	1	000960776
17	168	65	1	000960777
19	177	72	1	000960779
22	186	77	1	000960802
24	192	82	1	000960804

96BA/BP

chiavi maschio esagonale piegate con estremità sferica, antiscintilla

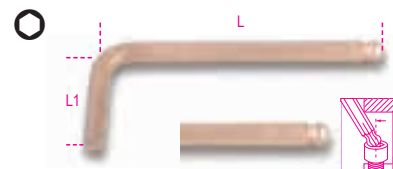

mm	L mm	L1 mm		
1,5	50	16	1	000961800
2	50	16	1	000961801
2,5	63	20	1	000961802
3	60	20	1	000961803
3,5	70	25	1	000961799
4	66	25	1	000961804
5	75	28	1	000961805
6	84	32	1	000961806
8	92	36	1	000961808
10	102	40	1	000961810
12	113	45	1	000961812

96BAF-AS

chiavi maschio esagonali piegate, antiscintilla



mm	L mm	L1 mm		
*1/16	59	25	1	000962831
*5/64	59	25	1	000962832
*3/32	59	25	1	000962833
*7/64	59	25	1	000962834
*1/8	59	25	1	000962835
*9/64	64	29	1	000962836
*5/32	65	30	1	000962837
*3/16	79	31	1	000962838
*7/32	85	37	1	000962839
*1/4	85	37	1	000962840
*5/16	92	44	1	000962842
*3/8	110	45	1	000962844
*7/16	119	48	1	000962845
*1/2	140	55	1	000962846
*9/16	150	58	1	000962847

99BA

chiavi a settore articolate con nasello quadro antiscintilla per ghiera



mm	A mm		
32-75	4,0	1	000990803
50-120	4,5	1	000990805
115-170	4,5	1	000990811

110BA

chiavi regolabili a rullino, antiscintilla



L mm	A max mm		
100	13	1	001100810
150	18	1	001100815
200	24	1	001100820
250	30	1	001100825
300	36	1	001100830
375	46	1	001100837
*450	55	1	001100845
*600	65	1	001100860

330BA

tagliatubi per tubi gas, antiscintilla



330BA/2	Ø max mm	L mm		
	50 mm	375	1	003300802

330BA/2R

coltello e spina di ricambio per 330BA per tubi gas, antiscintilla



330BA /2-R	1	003300822
------------	---	-----------

363BA

giratubi modello americano, antiscintilla



L mm	Ø max mm	Ø max mm		
150	1/2" gas	20	1	003630815
200	1" gas	30	1	003630820
250	1"1/2 gas	49	1	003630825
300	2" gas	60	1	003630830
350	2" gas	60	1	003630835
450	2"1/2 gas	76	1	003630845
600	3" gas	90	1	003630860

378BA

giratubi modello svedese, antiscintilla



L mm	Ø max "		
430	1" 1/2 gas	1	003780800
530	2" gas	1	003780801

386BA

giratubi reversibili a catena modello pesante, antiscintilla

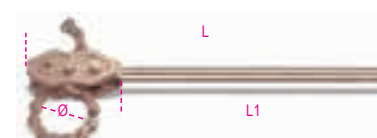

L mm	Ø max mm	L1 mm		
600	100	470	1	003860806
900	200	750	1	003860809

911BA

chiavi a bussola poligonali, antiscintilla



mm	L mm		
6	28	1	009110806
7	28	1	009110807
8	28	1	009110808
9	28	1	009110809
10	32	1	009110810
11	32	1	009110811
12	32	1	009110812
13	32	1	009110813
14	32	1	009110814
15	32	1	009110815
16	32	1	009110816
17	32	1	009110817
18	32	1	009110818
19	32	32	1 009110819

911BA/16

raccordo con attacco quadro femmina 3/8" e maschio 1/2" antiscintilla



L mm	3/8"	1/2"		
34			1	009110836

911BA/20

prolunga con attacco quadro maschio e femmina 3/8", antiscintilla



L mm			
75		1	009110840

911BA/55

cricchetto semplice con quadro scorrevole 3/8", antiscintilla



L mm	D mm	A mm		
200	45	16.5	1	009110882



921BA

chiavi a bussola poligonali,
antiscintilla

12"

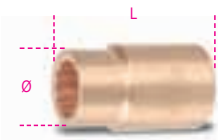

mm	Ø mm	L mm	
8	24,0	40	1 009210808
9	24,0	40	1 009210809
10	16,5	40	1 009210810
11	17,5	40	1 009210811
12	18,5	40	1 009210812
13	19,5	40	1 009210813
14	20,0	40	1 009210814
15	21,5	40	1 009210815
16	24,0	40	1 009210816
17	25,0	40	1 009210817
18	25,0	40	1 009210818
19	28,0	42	1 009210819
20	29,0	42	1 009210820
21	30,0	43	1 009210821
22	30,5	43	1 009210822
24	34,0	43	1 009210824
25	36,0	43	1 009210825
26	37,5	43	1 009210826
27	37,5	45	1 009210827
28	38,9	46	1 009210828
30	41,5	46	1 009210830
32	43,5	46	1 009210832

921BA-AS

chiavi a bussola poligonali,
antiscintilla

12"

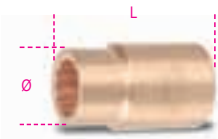

"	Ø mm	L mm	
5/16	24,0	40	1 009210958
3/8	24,0	40	1 009210960
7/16	24,0	40	1 009210961
1/2	24,0	40	1 009210963
9/16	24,0	40	1 009210964
5/8	25,0	40	1 009210966
11/16	25,5	40	1 009210967
3/4	28,0	42	1 009210969
13/16	30,0	43	1 009210971
7/8	31,5	43	1 009210972
15/16	34,0	43	1 009210974
1	36,0	43	1 009210975
1.1/16	38,0	46	1 009210977
1.1/4	42,0	46	1 009210982
1.7/16	50,5	50	1 009210986

921BA/15

raccordo con attacco quadro
femmina 1/2" e maschio 3/8"
antiscintilla

12"



L mm	□	■	
34	1/2	3/8	1 009210839

921BA/16

raccordo con attacco quadro
femmina 1/2" e maschio 3/4"
antiscintilla

12"



L mm	□	■	
34	1/2	3/4	1 009210840

921BA/21 - 921BA/22

prolunghe con attacchi quadri
maschio e femmina 1/2",
antiscintilla

12"



	L mm	Ø mm	
921BA/21	125	30	1 009210842
921BA/22	250	31	1 009210844

921BA/25

snodo con attacchi quadri
maschio e femmina 1/2",
antiscintilla

12"



L mm	Ø mm	□	■	
80	25	1/2	1/2	1 009210845

921BA/42

quadro maschio 1/2" con spina scorrevole,
antiscintilla

12"



L mm			
250			1 009210846

921BA/50

cricchetto semplice
con quadro scorrevole 1/2",
antiscintilla

12"



L mm	D mm	A mm	
250	45	16,5	1 009210850

921BA/R50

set di ricambio
antiscintilla

12"



L mm	□	■	
1/2"			1 009210851

926BA

chiavi a bussola poligonali,
antiscintilla

3/4"



mm	Ø mm	L mm	
22	40	55	1 009260822
24	40	55	1 009260824
26	40	55	1 009260826
27	40	55	1 009260827
28	41	55	1 009260828
30	43	60	1 009260830
32	45	60	1 009260832
34	48	60	1 009260834
36	50	60	1 009260836
38	53	60	1 009260838
41	57	65	1 009260841
46	63	65	1 009260846
50	68	70	1 009260850

926BA/15

raccordo con attacco quadro
femmina 3/4" e maschio 1/2"
antiscintilla

3/4"



L mm	□	■	
55	3/4	1/2	1 009260861

926BA/22

prolunghe con attacchi quadri
maschio e femmina 3/4", antiscintilla

3/4"



	L mm	Ø mm	
926BA/22	200	38	1 009260872

926BA/42

quadro maschio 3/4" con spina scorrevole,
antiscintilla

3/4"



L mm			
400			1 009260876

926BA/50

cricchetto semplice con quadro scorrevole 3/4", antiscintilla



L	D	A	
mm	mm	mm	
300	61	22	1 009260880

926BA/R50

set di ricambio antiscintilla



3/4"	1 009260881
------	-------------

937BA

chiavi a pipa esagonali, antiscintilla



Ø	L	A	
mm	mm	mm	
13	240	45	1 009370813
17	260	51	1 009370817
19	270	55	1 009370819
22	278	59	1 009370822
24	286	63	1 009370824
27	294	69	1 009370827
30	302	75	1 009370830
32	310	81	1 009370832
*36	330	85	1 009370836
*41	350	90	1 009370841

951BA

chiavi a T maschio esagonale, antiscintilla



mm	L	L1	
mm	mm	mm	
4	100	90	1 009510904
5	100	90	1 009510905
6	100	90	1 009510906

961BA

leve scrostatore, antiscintilla



L	A	
mm	mm	
250	39	1 009610802
350	55	1 009610806

963BA

leve con estremità a punta e piatta curva, antiscintilla



L	A	
mm	mm	
500	24	1 009630801
*800	24	1 009630803
*1000	30	1 009630805

964BA

aprifusti antiscintilla



L	
mm	
385	1 009640801

964BA/L

cesoia universale per fusti, antiscintilla

Per l'apertura dei fusti metallici con bordo



*964BA/L	L	
	mm	
	510	1 009640821

965BA

chiavi di manovra semplici antiscintilla, per valvole di sicurezza



A	A1	L	
mm	mm	mm	
30	44	200	1 009650830
32	50	300	1 009650832
35	47	250	1 009650835
40	50	300	1 009650840
45	58	350	1 009650845
48	62	375	1 009650848
50	67	400	1 009650850
55	73	450	1 009650855
60	79	500	1 009650860
*65	82	550	1 009650865
*70	85	600	1 009650870

966BA

chiave di manovra antiscintilla, per valvole di sicurezza

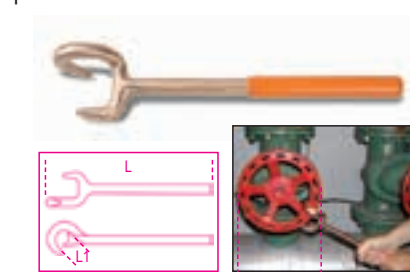

L	L1	Ø min+max	
mm	mm	mm	
350	40	50÷150	1 009660801

966BA/V

chiavi di manovra antiscintilla, per valvole di sicurezza

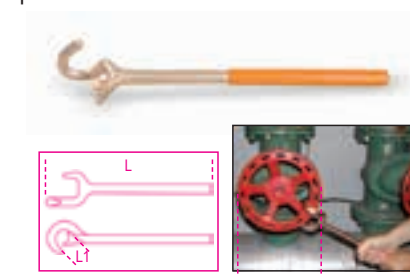

L	L1	Ø min+max	
mm	mm	mm	
370	36	125÷250	1 009660812
430	48	250÷400	1 009660814

1032BA

pinze a becchi dritti antiscintilla per anelli elastici di sicurezza, per fori manici ricoperti in PVC



L	Ø	
mm	mm	
200	40÷100	1 010320820

1036BA

pinze a becchi dritti antiscintilla per anelli elastici di sicurezza, per alberi manici ricoperti in PVC



L	Ø	
mm	mm	
200	40÷100	1 010360820

1046BA

pinze regolabili
cerniera a cremagliera,
antiscintilla

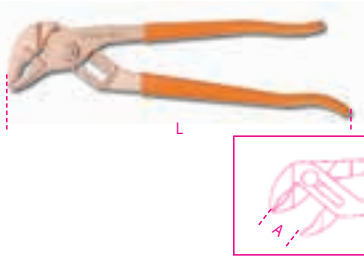

L mm	A max mm		
250	32	1	010460801
*300	52	1	010460803

1052BA

pinze regolabili autobloccanti
ganasce concave, antiscintilla



L mm	A1 max mm		
225	40,0	1	010520824

1082BA

tronchese a taglianti diagonali,
antiscintilla



L mm	L1 mm		
160	22	1	010820801

1100BA

troncabulloni,
antiscintilla



L mm			
600		1	011000860

1137BA

pinza da fochino,
antiscintilla



L mm	L1 mm		
185	30	1	011370801

1137BA/RC

lama di ricambio per 1137BA



1137BA/RC		1	011370851

1150BA

pinza universale,
antiscintilla

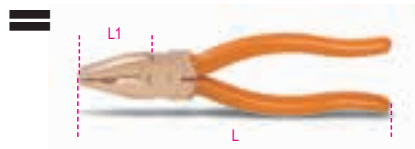

L mm	L1 mm		
200	40	1	011500820

1162BA

pinza a becchi piatti lunghissimi
diritti zigrinati,
antiscintilla

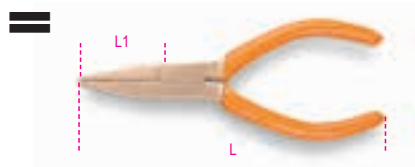

L mm	L1 mm		
150	54	1	011620815

1166BA

pinza a becchi mezzotondi
lunghissimi
diritti zigrinati,
antiscintilla



L mm	L1 mm		
150	54	1	011660815

1270BA

giravite per viti a testa con intaglio,
antiscintilla



AxL mm	L1 mm		
3x75	178	1	012700803
4x100	209	1	012700804
5x150	250	1	012700805
6x150	270	1	012700806
10x250	382	1	012700810
8x200	312	1	012700808

1272BA

giravite per viti
con impronta a croce Phillips®,
antiscintilla

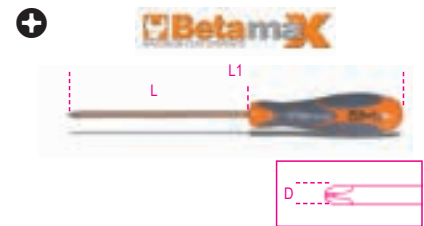

PHxDxL mm	L1 mm		
1x5x100	209	1	012720801
2x6x150	270	1	012720802
3x8x200	332	1	012720803

1277BA

giravite per viti con impronta Torx®,
antiscintilla



Ø	L mm	L1 mm	Ø mm		
T10	75	184	5	1	012770810
T15	75	184	5	1	012770815
T20	100	209	6	1	012770820
T25	125	209	6	1	012770825
T30	150	270	6	1	012770830
T40	200	332	8	1	012770840

1370BA

martelli tipo tedesco antiscintilla,
manico in legno



g	A mm	L mm	L1 mm		
500	30	310	108	1	013700805
1000	35	340	137	1	013700810

1370BA/MR

manici di ricambio per 1370BA

1370BA/MR 500	1	013700865
1370BA/500		
1370BA/MR 1000	1	013700870
1370BA/1000		

1370BA/PL

martelli tipo tedesco antiscintilla,
manico in fibra



	A	L	L1		
g	mm	mm	mm		
500	30	310	108	1	013700815
1000	35	340	137	1	013700820

1375BA/PL

martello con penna sferica
a granchio antiscintilla,
manico in fibra



	L	L1	Ø		
g	mm	mm	mm		
680	321	125	30	1	013750800

1377BA

martello con testa tonda e penna sferica
per calderai e lattonieri,
antiscintilla



	L1	L			
g	mm	mm			
340	90	280	1	013770834	

1377BA/PL

martello con testa tonda e penna sferica
per calderai e lattonieri, manico in fibra,
antiscintilla



	L1	L			
g	mm	mm			
340	90	280	1	013770884	

1379BA

martello scrostatore antiscintilla,
manico in legno



	L1	L			
g	mm	mm			
500	142	315	1	013790850	

1380BA

mazzette antiscintilla,
manico in legno



	L1	L			
g	mm	mm			
1000	100	400	1	013800810	
1500	118	400	1	013800815	
2000	126	400	1	013800820	

1380BA/MR

manici di ricambio per 1380BA

1380BA/MR 1000	1	013800860
1380BA/1000		
1380BA/MR 1500	1	013800865
1380BA/1500		
1380BA/MR 2000	1	013800870
1380BA/2000		

1380BA/PL

mazzette antiscintilla,
manico in fibra



	L1	L			
g	mm	mm			
500	80	310	1	013800955	
1000	94	350	1	013800960	
1500	115	400	1	013800965	
2000	125,5	400	1	013800970	

1381BA

mazze antiscintilla,
manico in legno



	L1	L			
g	mm	mm			
5000	179	900	1	013810850	
*8000	190	900	1	013810858	

1381BA/MR

manico di ricambio per 1381BA

1381BA/MR 5000	1	013810870
1381BA/5000		
*1381BA/MR 8000	1	013810878
1381BA/8000		

1381BA/PL

mazze antiscintilla,
manico in fibra

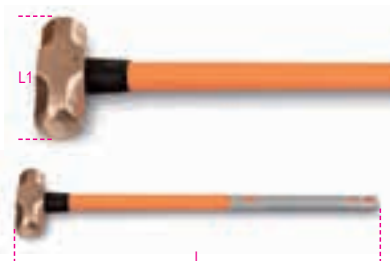

	L1	L			
g	mm	mm			
5000	172	900	1	013810885	
8000	204	900	1	013810888	

1390BA

mazuola con battenti in nylon,
antiscintilla



	L	L1			
Ø	mm	mm			
*52	370	130	1	013900805	

1390BA/R

battenti di ricambio in Nylon per 1390BA



	D				
mm					
52			4	013900885	



1602BA

pinza per capicorda preisolati
modello leggero,
antiscintilla



	L mm		
0.75+6	200	1	016020801

1701BA

scalpelli esagonale,
antiscintilla



L mm	A mm	S mm	
150	12	10	1 017010810
200	16	14	1 017010814
250	18	14	1 017010815
350	19	17	1 017010817

1703BA/A

ascia antiscintilla



L mm	L1 mm	A mm	
340	145	82	1 017030082

1703BA/P

piccone antiscintilla

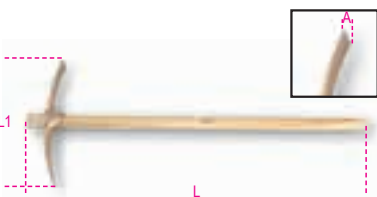

A mm	L mm	L1 mm	
56	1050	410	1 017030150

1703BA/PL

badile antiscintilla



A mm	L1 mm	L mm	
240	420	990	1 017030200

1717BA

spatole rigide,
antiscintilla



A mm			
60	1	017170801	
80	1	017170803	

1717BA/1

raschiapareti antiscintilla



A mm	L mm		
100	220	1	017170805

1719BA8

lime da 8" antiscintilla



	L mm		
1719BA8/P	200	1	017190801
1719BA8/M	200	1	017190805
1719BA8/R	200	1	017190810
1719BA8/T	200	1	017190815
1719BA8/Q	200	1	017190820

1719BA12

lima da 12" antiscintilla



	L mm		
1719BA12/P	300	1	017190831

1727BA

seghetto e lama,
antiscintilla



L mm	L1 mm		
500	300	1	017270801

1728BA

lama per seghetti,
antiscintilla



L mm			
300	1	017280801	

1737BA

spazzola con fili antiscintilla



L mm	A mm		
294	29	1	017370801

1758BA

imbuto antiscintilla



Ø mm	H mm		
160	150	1	017580815

1776BA

coltello antiscintilla



L1 mm	L mm		
145	250	1	017760801

1784BA

forbici antiscintilla



L mm			
225	1	017840822	



1972/12

trapano avvitatore ultracompatto 12V

- **ultracompatto**, solo 176 mm di lunghezza , **ultraleggero**, solo 1,1 kg con batteria e **perfettamente bilanciato**
- doppia velocità meccanica con ingranaggi in acciaio e frizione a 18 posizioni
- coppia fino a 34 Nm e 1500 giri/min (350 giri/min in 1ª marcia); fora fino ad un diametro di 10 mm nell'acciaio e 20 mm nel legno
- batterie da 2Ah e indicatore di carica sul corpo macchina
- tripla autoprotezione della batteria (termica, sovraccarico e monitoraggio dell' eventuale disparità di carica fra le celle) offre una maggiore sicurezza e garantisce prestazioni elevate nel tempo
- impugnatura ergonomica antiscivolo
- LED frontale
- mandrino autoserrante da 10 mm
- clip da cintura destra/sinistra
- selettore avvita-svita-blocco (per il trasporto)
- fornito in valigetta rigida con 2 batterie agli ioni di litio da 2 Ah e caricatore rapido (45 min)

1,1 kg



1972/12

1 019720012

1984/18QM

avvitatore reversibile ad impulsi 18V brushless

motore digitale senza spazzole brushless: offre un notevole incremento delle prestazioni fra cui: maggiore potenza, minori consumi di energia, vita utile del motore estesa, estrema compattezza, miglior dosaggio della potenza dal pulsante.

- batterie da 5Ah con indicatore di carica
- ultracompatto: solo 196 mm di lunghezza
- attacco quadro maschio da 1/2" con anello trattieni-bussola
- clip da cintura destra/sinistra
- triplo LED di illuminazione frontale
- scatola ingranaggi interamente metallica
- selettore avvita-svita-blocco (per il trasporto)
- impugnatura ergonomica antiscivolo
- tripla autoprotezione della batteria (termica, sovraccarico e monitoraggio dell'eventuale disparità di carica fra le celle) offre una maggiore sicurezza e garantisce prestazioni elevate nel tempo

4 modalità selezionabili:

1: 270Nm; 1400 RPM

2: 360Nm; 2000 RPM

3: 450Nm; 2750 RPM

A: 450Nm Autostop - finchè l'avvitatore rileva una rotazione libera applica il massimo della coppia/velocità (450Nm; 2750 RPM).

Quando il dado arriva a fine corsa e non ruota più, l'avvitatore continua ad applicare il massimo della coppia per 1 secondo poi si arresta.

- fornito in valigetta rigida con adattatore portainseri esagonale da 1/4", 2 batterie agli ioni di litio da 5 Ah e caricatore rapido (80 min)

2,3 kg



1984/18QM

1 019840018

LA GAMMA DI SMERIGLIATRICI ANGOLARI A MARCHIO BETA



La famiglia degli elettrodomestici Beta si compone di utensili a filo e a batteria. Le smerigliatrici a filo offrono differenti caratteristiche e potenze a seconda delle tipologie di impiego.

Potenza, Affidabilità e Durata nel tempo sono i 3 punti cardine su cui si basa la nuova gamma, senza tralasciare la massima sicurezza e facilità di utilizzo per il professionista.

• **Massime prestazioni:**

- Potente motore resinato resistente all'usura e di lunga durata
- Feritoie di ventilazione per un raffreddamento ottimale, protette contro l'infiltrazione della polvere

• **Massima sicurezza per l'operatore:**

- Dispositivo blocco albero per una rapida sostituzione dei dischi
- Protezione contro il riavvio accidentale
- Avviamento graduale con limitazione dello spunto alla partenza

• **Massimo comfort e maneggevolezza:**

- Impugnatura ergonomica antiscivolo per una presa più salda
- Testa ribassata per operare in spazi ristretti

Ben **4 metri di lunghezza cavo antigroviglio** per una comoda autonomia di movimento
Impugnatura supplementare posizionabile su entrambi i lati.

1956 115-750W

smerigliatrice angolare per dischi Ø 115 mm

Ideale per lavori di taglio, rettifica e sgrossatura

Potente motore da 750 W

Impugnatura ergonomica antiscivolo per maggiore comfort e sicurezza

Testa ribassata per operare in spazi ristretti

Estremamente leggera, solo 1,8kg di peso

Caratteristiche principali

- Protezione contro il riavvio accidentale
- Impugnatura supplementare, posizionabile su entrambi i lati
- Copri disco con sistema "tool-less" (sgancio rapido)
- Dispositivo blocco albero per una rapida sostituzione del disco
- Interruttore di accensione a slitta con blocco
- Feritoie di ventilazione protette contro l'infiltrazione della polvere e per un raffreddamento ottimale
- Chiave di servizio inclusa

📦 1,8 kg



1956 125-1400W

smerigliatrice angolare per dischi Ø 125mm

Ideale per lavori di taglio, rettifica e sgrossatura

L = 4 m

Potente motore da 1400 W - Velocità variabile

Impugnatura ergonomica antiscivolo per maggiore comfort e sicurezza
Testa ribassata per operare in spazi ristretti

Caratteristiche principali

- Protezione contro il riavvio accidentale
- Impugnatura supplementare **Antivibrazione**, posizionabile su entrambi i lati
- Copri disco con sistema "tool-less" (sgancio rapido)
- Dispositivo blocco albero per una rapida sostituzione del disco
- Interruttore di accensione a slitta con blocco
- Feritoie di ventilazione protette contro l'infiltrazione della polvere e per un raffreddamento ottimale
- Chiave di servizio in dotazione

📦 2,5 kg



1956 125-1400W

1 019560125

1956 230-2400W

smerigliatrice angolare per dischi Ø 230 mm

Ideale per lavori complessi di troncatura, smerigliatura e limatura

Potente motore da 2400 W

Impugnatura ergonomica antiscivolo per maggiore comfort e sicurezza

Caratteristiche principali

- Protezione contro il riavvio accidentale
- Funzione **Soft Start** per un avviamento lento e limitazione dello spunto alla partenza
- Impugnatura supplementare **Antivibrazione**, posizionabile su entrambi i lati
- Copri disco con sistema di chiusura a vite
- Dispositivo blocco albero per una rapida sostituzione del disco
- Interruttore di accensione a slitta con blocco
- Feritoie di ventilazione protette contro l'infiltrazione della polvere e per un raffreddamento ottimale
- Chiave di servizio inclusa

📦 5,8 kg

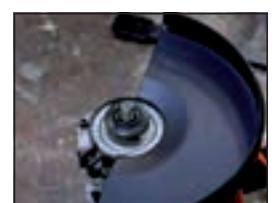

1956 230-2400W

1 019560230



UTENSILI PNEUMATICI

Da oltre 20 anni Beta Utensili ha ampliato la propria offerta con una gamma completa di utensili pneumatici e accessori destinati al mercato automotive e alla manutenzione industriale: avvitatori, cricchetti, trapani, smerigliatrici, levigatrici e molti altri articoli. Nel corso di questo periodo la stretta collaborazione con gli utilizzatori professionisti è stata fondamentale per una crescita costante. È grazie a questa crescita che oggi il mercato riconosce negli utensili pneumatici Beta un ottimo rapporto affidabilità/prestazioni.



























Beta Utensili, con l'obiettivo di soddisfare al meglio le richieste del mercato, effettua le riparazioni degli articoli pneumatici all'interno del proprio Ufficio Qualità. Questo processo ha consentito all'azienda di incrementare notevolmente il proprio know-how e di essere sempre più reattiva nei confronti della clientela.





www.beta-tools.com

GUIDA ALLA SCELTA UTENSILI PNEUMATICI













GAMMA AVVITATORI

■	ARTICOLO	CODICE	MATERIALE	 max. Nm	 db (A) LpA	 db (A) LpW	 l/min.	 kg	MECCANISMO	 m/s ²
3/8"		1924F	Alluminio	108	93.6	104.6	59	0,5	Doppio martello	6.85
3/8"		1924B	Alluminio	353	91	95	80	1,5	Pin clutch	7.9
3/8"		1924CD	Composito	410	91.7	102.7	79	1,3	Doppio martello	6.2
3/8"		1924XM	Composito	515	91.7	102.7	122	1,3	Singolo martello	6.2
1/2"		1927AN	Alluminio	244	89.4	100.4	190	2,1	Singolo martello	8.63
1/2"		1927G	Alluminio	325	92.2	103.2	113	1,2	Singolo martello	9.96
1/2"		1927B	Alluminio	705	98.0	109.0	133	2,1	Pin clutch	14.08
1/2"		1927XM	Alluminio	770	102	113	122	1,3	Singolo martello	7.5
1/2"		1927CD	Composito	1.020	95.5	106.5	130	2,3	Doppio martello	7.2
1/2"		1927P	Composito	1.750	95.1	106.1	290	2,0	Doppio martello	6.7
1/2"		1927PAL	Composito	1.750	95.1	106.1	290	2,2	Doppio martello	6.7
3/4"		1928XM	Alluminio	1.600	91.8	102.8	175	2,9	Doppio martello	12.96
3/4"		1928DA	Alluminio	1.695	96	99.5	300	4,3	Doppio martello	3.6
3/4"		1928DAL	Alluminio	1.695	96	99.5	300	4,8	Doppio martello	3.6
3/4"		1928CD	Composito	1.800	97.5	108.5	215	3,5	Doppio martello	11.4
1"		1930CD	Composito	2.445	95.6	97.1	410	7,1	Doppio martello	3,6
1"		1930PA	Alluminio	2.445	96.0	97.1	410	9,6	Doppio martello	7,2
1"		1930A	Alluminio	2.445	103.3	114.3	460	9,5	Doppio martello	67
1"		1930LH	Alluminio	2.441	97.1	108.1	282	7,1	Doppio martello	17.4
1"		1930LA	Alluminio	2.445	95.6	97.1	460	10,6	Doppio martello	3,6

GUIDA ALLA SCELTA UTENSILI PNEUMATICI

■	ARTICOLO	CODICE	MATERIALE	max. Nm	db (A) LpA	db (A) LpW	l/min.	kg	MECCANISMO	m/s ²
1"		1930HLA	Alluminio	3.661	99	101	460	16,4	Doppio martello	16,4
1 1/2"		1930ZL	Alluminio	4.068	102.4	113.4	480	15	Doppio martello	69.6

GAMMA AVVITATORI A CRICCHETTO

■	ARTICOLO	CODICE	 max. Nm	 db (A) LpA	 db (A) LpW	 l/min.	 kg	 m/s ²
1/4"		1921B1	24	96	85	90	0,4	2.6
1/4"		1921M1	27	84	88	96	0,6	1.8
1/4"		1922P1	68	90.6	101.6	88	0,6	8.61
3/8"		1921M2	27	84	88	96	0,6	1.8
3/8"		1922P2	68	90.6	101.6	88	0,6	8.61
1/2"		1921N3	68	80	87	140	1,2	2.6
1/2"		1922P3	136	94.9	105.9	113	1,5	18.28

GAMMA SMERIGLIATRICI

	ARTICOLO	CODICE	POTENZA	 db (A) LpA	 db (A) LpW	 l/min.	 kg	 m/s ²
		1933	0,20 kW	80.0	87.0	230	0,38	4.53
		1933L	0,20 kW	80.0	87.0	270	0,67	1.15
		1933AN90	0,20 kW	80.0	87.0	230	0,51	1.24
		1933I	0,38 kW	80.0	87.0	260	0,67	4.53
		1933IL	0,38 kW	79.0	97.0	113	1,4	1.6
		1933IH	0,75 kW	88.1	99.1	370	0,8	2.6
		1933ILH	0,75 kW	85.7	96.7	370	1,2	1.4
		1933AN90-H	0,75 kW	85.6	96.6	370	1,1	6.7
		1934MAV	0,04 kW	71	76	115	0,2	2.5
		1934MAV70	0,08 kW	80	87	115	0,2	4

1921B1

baby cricchetto reversibile

14"

CE



130 mm

Velocità libera	350 giri/min
Coppia massima	24 Nm
Capacità vite/dado	CI 8.8 M7●11 mm
Capacità vite/dado	CI 12.9 M6●10 mm
Attacco aria	1/4" GAS
Pressione di utilizzo	6,2 bar
Ø interno tubo aria	8 mm
Consumo aria medio	68 l/min
Peso	0,4 kg

1/4	1	019210001
-----	---	-----------

1921N3

cricchetto reversibile

12"

CE



258 mm

Velocità libera	150 giri/min
Coppia massima	68 Nm
Capacità vite/dado	CI 8.8 M10●16 mm
Capacità vite/dado	CI 12.9 M8●13 mm
Attacco aria	1/4" GAS
Pressione di utilizzo	6,2 bar
Ø interno tubo aria	10 mm
Consumo aria medio	140 l/min
Peso	1,2 kg

1/2	1,2	1	019210025
-----	-----	---	-----------

1922P3

cricchetto reversibile a massa battente

12"

CE



292 mm

Velocità libera	600 giri/min
Coppia massima	136 Nm
Capacità vite/dado	CI 8.8 M12●18 mm
Capacità vite/dado	CI 12.9 M10●16 mm
Attacco aria	1/4" GAS
Pressione di utilizzo	6,2 bar
Ø interno tubo aria	10 mm
Consumo aria medio	113 l/min
Peso	1,5 kg

1/2	1,5	1	019220013
-----	-----	---	-----------

1921M1

cricchetto compatto reversibile

14"

CE



198 mm

Velocità libera	200 giri/min
Coppia massima	27 Nm
Capacità vite/dado	CI 8.8 M7●11 mm
Capacità vite/dado	CI 12.9 M6●10 mm
Attacco aria	1/4" GAS
Pressione di utilizzo	6,2 bar
Ø interno tubo aria	8 mm
Consumo aria medio	96 l/min
Peso	0,6 kg

1/4	0,6	1	019210005
-----	-----	---	-----------

1922P1

cricchetto reversibile a massa battente

14"

CE



164 mm

Velocità libera	700 giri/min
Coppia massima	68 Nm
Capacità vite/dado	CI 8.8 M10●16 mm
Capacità vite/dado	CI 12.9 M8●13 mm
Attacco aria	1/4" GAS
Pressione di utilizzo	6,2 bar
Ø interno tubo aria	10 mm
Consumo aria medio	88 l/min
Peso	0,6 kg

1/4	0,6	1	019220006
-----	-----	---	-----------

1924F

avvitatore reversibile compatto "butterfly"

3/8"

CE



139 mm

Velocità libera	12.000 giri/min
Coppia massima	108 Nm
Capacità vite/dado	CI 8.8 M12●18 mm
Capacità vite/dado	CI 12.9 M10●16 mm
Attacco aria	1/4" GAS
Pressione di utilizzo	6,2 bar
Ø interno tubo aria	10 mm
Consumo aria medio	59 l/min
Peso	0,5 kg

3/8	0,5	1	019240025
-----	-----	---	-----------

1921M2

cricchetto compatto reversibile

3/8"

CE



198 mm

Velocità libera	200 giri/min
Coppia massima	27 Nm
Capacità vite/dado	CI 8.8 M7●11 mm
Capacità vite/dado	CI 12.9 M6●10 mm
Attacco aria	1/4" GAS
Pressione di utilizzo	6,2 bar
Ø interno tubo aria	8 mm
Consumo aria medio	96 l/min
Peso	0,6 kg

3/8	0,6	1	019210015
-----	-----	---	-----------

1922P2

cricchetto reversibile a massa battente

3/8"

CE



164 mm

Velocità libera	700 giri/min
Coppia massima	68 Nm
Capacità vite/dado	CI 8.8 M10●16 mm
Capacità vite/dado	CI 12.9 M8●13 mm
Attacco aria	1/4" GAS
Pressione di utilizzo	6,2 bar
Ø interno tubo aria	10 mm
Consumo aria medio	88 l/min
Peso	0,6 kg

3/8	0,6	1	019220010
-----	-----	---	-----------



1924B

avvitatore reversibile compatto

- Meccanismo impulsivo "Pin Clutch"



Velocità libera	10.000 giri/min
Coppia massima	353 Nm
Capacità vite/dado	Cl 8.8 M16 ● 24 mm
Capacità vite/dado	Cl 12.9 M14 ● 21 mm
Attacco aria	1/4" GAS
Pressione di utilizzo	6,2 bar
Ø interno tubo aria	8 mm
Consumo aria medio	80 l/min
Peso	1,5 kg

■	kg	🔧	📦
3/8	1,5	1	019240021

1924XM

avvitatore reversibile compatto

- Meccanismo impulsivo singolo martello



Velocità libera	9.000 giri/min
Coppia massima	515 Nm
Capacità vite/dado	Cl 8.8 M16 ● 24 mm
Capacità vite/dado	Cl 12.9 M14 ● 21 mm
Attacco aria	1/4" GAS
Pressione di utilizzo	6,2 bar
Ø interno tubo aria	10 mm
Consumo aria medio	122 l/min
Peso	1,3 kg

■	kg	🔧	📦
3/8	1,3	1	019240030

1927B/K5

avvitatore reversibile in alluminio fornito con 5 bussole macchina, in valigetta



○ 720 15-17-19-21-22 mm

Velocità libera	7.000 giri/min
Coppia massima	705 Nm
Capacità vite/dado	Cl 8.8 M22 ● 34 mm
Capacità vite/dado	Cl 12.9 M18 ● 27 mm
Attacco aria	1/4" GAS
Pressione di utilizzo	6,2 Bar
Ø interno tubo aria	10 mm
Consumo aria medio	133 l/min

■	kg	🔧	📦
1/2	3,5	1	019270122
📏 350x305x86 mm			

1924CD

avvitatore reversibile in materiale composito

- Meccanismo impulsivo doppio martello



Velocità libera	10.000 giri/min
Coppia massima	410 Nm
Capacità vite/dado	Cl 8.8 M16 ● 24 mm
Capacità vite/dado	Cl 12.9 M14 ● 21 mm
Attacco aria	1/4" GAS
Pressione di utilizzo	6,2 bar
Ø interno tubo aria	8 mm
Consumo aria medio	79 l/min
Peso	1,3 kg

■	kg	🔧	📦
3/8	1,3	1	019240007

1927B

avvitatore reversibile

- Meccanismo impulsivo "Pin Clutch"



Velocità libera	7.000 giri/min
Coppia massima	705 Nm
Capacità vite/dado	Cl 8.8 M22 ● 34 mm
Capacità vite/dado	Cl 12.9 M18 ● 27 mm
Attacco aria	1/4" GAS
Pressione di utilizzo	6,2 bar
Ø interno tubo aria	10 mm
Consumo aria medio	133 l/min
Peso	2,1 kg

■	kg	🔧	📦
1/2	2,1	1	019270022

1927CD

avvitatore reversibile in materiale composito

- Meccanismo impulsivo doppio martello



Velocità libera	7.000 giri/min
Coppia massima	1.020 Nm
Capacità vite/dado	Cl 8.8 M22 ● 34 mm
Capacità vite/dado	Cl 12.9 M18 ● 27 mm
Attacco aria	1/4" GAS
Pressione di utilizzo	6,2 bar
Ø interno tubo aria	10 mm
Consumo aria medio	130 l/min
Peso	2,3 kg

■	kg	🔧	📦
1/2	2,3	1	019270007

1927CD/K3

assortimento di un avvitatore reversibile e tre bussole Macchina

- Meccanismo impulsivo doppio martello

12"
CE



720LC17-19-21 mm

Velocità libera	7.000 giri/min
Coppia massima	1.020 Nm
Capacità vite/dado	Cl 8.8 M22●34 mm
Capacità vite/dado	Cl 12.9 M18●27 mm
Attacco aria	1/4" GAS
Pressione di utilizzo	6,2 Bar
Ø interno tubo aria	10 mm
Consumo aria medio	130 l/min

1/2	kg	4	1	019270107
350x305x86 mm				

1927P/K3

avvitatore reversibile in materiale composito
fornito con 3 bussole Macchina

12"
CE



720LC17-19-21 mm

Velocità libera	7.500 giri/min
Coppia massima	1.750 Nm
Capacità vite/dado	Cl 8.8 M24●36 mm
Capacità vite/dado	Cl 12.9 M20●30 mm
Attacco aria	1/4" GAS
Pressione di utilizzo	6,2 Bar
Ø interno tubo aria	10 mm
Consumo aria medio	290 l/min

1/2	kg	4	1	019270118
350x305x86 mm				

1927XM

avvitatore reversibile compatto

- Meccanismo impulsivo singolo martello

12"
CE



Velocità libera	10.000 giri/min
Coppia massima	770 Nm
Capacità vite/dado	Cl 8.8 M22●34 mm
Capacità vite/dado	Cl 12.9 M18●27 mm
Attacco aria	1/4" GAS
Pressione di utilizzo	6,2 bar
Ø interno tubo aria	10 mm
Consumo aria medio	122 l/min
Peso	1,3 kg

1/2	kg	1,3	1	019270030
-----	----	-----	---	-----------

1927P

avvitatore reversibile in materiale composito

- Meccanismo impulsivo doppio martello

12"
CE



Velocità libera	7.500 giri/min
Coppia massima	1.750 Nm
Capacità vite/dado	Cl 8.8 M24●36 mm
Capacità vite/dado	Cl 12.9 M20●30 mm
Attacco aria	1/4" GAS
Pressione di utilizzo	6,2 bar
Ø interno tubo aria	10 mm
Consumo aria medio	290 l/min
Peso	2 kg

1/2	kg	2,0	1	019270008
-----	----	-----	---	-----------

1927PAL

avvitatore reversibile in materiale composito

- Meccanismo impulsivo doppio martello
- Albero lungo da 2"

12"
CE



Velocità libera	7.500 giri/min
Coppia massima	1.750 Nm
Capacità vite/dado	Cl 8.8 M24●36 mm
Capacità vite/dado	Cl 12.9 M20●30 mm
Attacco aria	1/4" GAS
Pressione di utilizzo	6,2 bar
Ø interno tubo aria	10 mm
Consumo aria medio	290 l/min
Peso	2,2 kg

1/2	kg	2,2	1	019270009
-----	----	-----	---	-----------

1927XM/K5

assortimento di un avvitatore reversibile compatto e cinque bussole Macchina

- Meccanismo impulsivo singolo martello

12"
CE



720 17-19-21-22-24 mm

Velocità libera	10.000 giri/min
Coppia massima	770 Nm
Capacità vite/dado	Cl 8.8 M22●34 mm
Capacità vite/dado	Cl 12.9 M18●27 mm
Attacco aria	1/4" GAS
Pressione di utilizzo	6,2 Bar
Ø interno tubo aria	10 mm
Consumo aria medio	122 l/min

1/2	kg	2,8	1	019270129
307x206x86 mm				

1927AN

avvitatore reversibile angolare

- Meccanismo impulsivo singolo martello

1/2"

CE



Velocità libera	4.700 giri/min
Coppia massima	244 Nm
Capacità vite/dado	CI 8.8 M14 ● 21 mm
Capacità vite/dado	CI 12.9 M12 ● 19 mm
Attacco aria	1/4" GAS
Pressione di utilizzo	6,2 bar
Ø interno tubo aria	10 mm
Consumo aria medio	190 l/min
Peso	2,1 kg

1/2"	kg	1	019270012
2,1			

1927G

avvitatore reversibile compatto

- Meccanismo impulsivo singolo martello

1/2"

CE



Velocità libera	8500 giri/min
Coppia massima	325 Nm
Capacità vite/dado	CI 8.8 M16 ● 24 mm
Capacità vite/dado	CI 12.9 M14 ● 21 mm
Attacco aria	1/4" GAS
Pressione di utilizzo	6,2 bar
Ø interno tubo aria	10 mm
Consumo aria medio	113 l/min
Peso	1,2 kg

1/2"	kg	1	019270050
1,2			

1927SP-AM

supporto magnetico per avvitatore pneumatico

- Dotato di due magneti ad alta tenuta con gomma protettiva
- Permette di alloggiare 1 avvitatore da 1/2", 4 bussole e 1 chiave dinamometrica
- Portata: 10 kg



g	1	019270000
400		

1928XM

avvitatore reversibile compatto

- Meccanismo impulsivo doppio martello
- Incredibilmente compatto e potente
- Comando d'inversione a leva azionabile con una sola mano
- Tre differenti livelli di potenza in avvitamento
- Scarico dell'aria attraverso l'impugnatura

3/4"

CE



Velocità libera	4.800 giri/min
Coppia massima	1.600 Nm
Capacità vite/dado	CI 8.8 M27 ● 41 mm
Capacità vite/dado	CI 12.9 M24 ● 36 mm
Attacco aria	3/8" GAS
Pressione di utilizzo	6,2 bar
Ø interno tubo aria	10 mm
Consumo aria medio	175 l/min
Peso	2,9 kg

3/4"	kg	1	019280030
2,9			

1928CD

avvitatore reversibile in materiale composito

- Meccanismo impulsivo doppio martello

3/4"

CE



Velocità libera	4.500 giri/min
Coppia massima	1.800 Nm
Capacità vite/dado	CI 8.8 M27 ● 41 mm
Capacità vite/dado	CI 12.9 M24 ● 36 mm
Attacco aria	3/8" GAS
Pressione di utilizzo	6,2 bar
Ø interno tubo aria	10 mm
Consumo aria medio	215 l/min
Peso	3,5 kg

3/4"	kg	1	019280007
3,5			

1928DA

avvitatore reversibile

- Meccanismo impulsivo doppio martello

3/4"

CE



Velocità libera	5.000 giri/min
Coppia massima	1.695 Nm
Capacità vite/dado	CI 8.8 M30 ● 46 mm
Capacità vite/dado	CI 12.9 M27 ● 41 mm
Attacco aria	3/8" GAS
Pressione di utilizzo	6,2 bar
Ø interno tubo aria	10 mm
Consumo aria medio	240 l/min
Peso	4,3 kg

3/4"	kg	1	019280022
4,3			

1928DAL

avvitatore reversibile

- Meccanismo impulsivo doppio martello

3/4"

CE

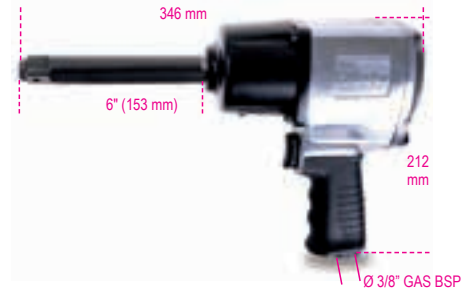

Velocità libera	5.000 giri/min
Coppia massima	1.695 Nm
Capacità vite/dado	CI 8.8 M27 ● 41 mm
Capacità vite/dado	CI 12.9 M24 ● 36 mm
Attacco aria	3/8" GAS
Pressione di utilizzo	6,2 bar
Ø interno tubo aria	10 mm
Consumo aria medio	240 l/min
Peso	4,8 kg

3/4"	kg	1	019280023
4,8			

1928K4

assortimento di un avvitatore reversibile e quattro bussole Macchina serie lunga

- Meccanismo impulsivo "Pin Clutch"

3/4"
CE



728L 27-30-32-36 mm

Velocità libera	4.000 giri/min
Coppia massima	1.493 Nm
Capacità vite/dado	CI 8.8 M27●41 mm
Capacità vite/dado	CI 12.9 M24●36 mm
Attacco aria	3/8" GAS BSP
Pressione di utilizzo	6,2 bar
Ø interno tubo aria	10 mm
Consumo aria medio	260 l/min
Peso avvitatore	5,2 kg

3/4"	9,3 kg	1	019280104
410x330x106 mm			

1930LH

avvitatore reversibile

- Meccanismo impulsivo doppio martello

1"
CE



Velocità libera	6.000 giri/min
Coppia massima	2.441 Nm
Capacità vite/dado	CI 8.8 M36●55 mm
Capacità vite/dado	CI 12.9 M30●46 mm
Attacco aria	1/2" GAS
Pressione di utilizzo	6,2 bar
Ø interno tubo aria	13 mm
Consumo aria medio	280 l/min
Peso	7,1 kg

1"	7,1 kg	1	019300030
----	--------	---	-----------

1930LA

avvitatore reversibile

- Meccanismo impulsivo doppio martello

1"
CE



Velocità libera	4.000 giri/min
Coppia massima	2.445 Nm
Capacità vite/dado	CI 8.8 M36●55 mm
Capacità vite/dado	CI 12.9 M30●46 mm
Attacco aria	1/2" GAS
Pressione di utilizzo	6,2 bar
Ø interno tubo aria	13 mm
Consumo aria medio	460 l/min
Peso	10,6 kg

1"	10,6 kg	1	019300037
----	---------	---	-----------

1930CD

avvitatore reversibile in materiale composito

- Meccanismo impulsivo doppio martello

1"
CE



Velocità libera	4.000 giri/min
Coppia massima	2.445 Nm
Capacità vite/dado	CI 8.8 M36●55 mm
Capacità vite/dado	CI 12.9 M30●46 mm
Attacco aria	1/2" GAS
Pressione di utilizzo	6,2 bar
Ø interno tubo aria	13 mm
Consumo aria medio	320 l/min
Peso	7,1 kg

1"	7,1 kg	1	019300022
----	--------	---	-----------

1930PA

avvitatore reversibile

- Meccanismo impulsivo doppio martello

1"
CE



Velocità libera	3.500 giri/min
Coppia massima	2.445 Nm
Capacità vite/dado	CI 8.8 M36●55 mm
Capacità vite/dado	CI 12.9 M30●46 mm
Attacco aria	1/2" GAS
Pressione di utilizzo	6,2 bar
Ø interno tubo aria	13 mm
Consumo aria medio	350 l/min
Peso	9,6 kg

1"	9,6 kg	1	019300032
----	--------	---	-----------

1930A

avvitatore reversibile

- Meccanismo impulsivo doppio martello

1"
CE



Velocità libera	4.000 giri/min
Coppia massima	2.445 Nm
Capacità vite/dado	CI 8.8 M36●55 mm
Capacità vite/dado	CI 12.9 M30●46 mm
Attacco aria	1/2" GAS
Pressione di utilizzo	6,2 bar
Ø interno tubo aria	13 mm
Consumo aria medio	460 l/min
Peso	9,5 kg

1"	9,5 kg	1	019300036
----	--------	---	-----------

1930HLA

avvitatore reversibile

• Meccanismo impulsivo doppio martello

1^{PP}

CE



Velocità libera	3.000 giri/min
Coppia massima	3.661 Nm
Capacità vite/dado	Cl 8.8 M42 ● 65 mm
Capacità vite/dado	Cl 12.9 M36 ● 50 mm
Attacco aria	1/2" GAS
Pressione di utilizzo	6,2 bar
Ø interno tubo aria	13 mm
Consumo aria medio	460 l/min
Peso	16,4 kg

1	kg	1	019300040
16,4			

1930ZL

avvitatore reversibile

• Meccanismo impulsivo doppio martello

1/2^{PP}

CE



Velocità libera	3.000 giri/min
Coppia massima	4.068 Nm
Capacità vite/dado	Cl 8.8 M42 ● 65 mm
Capacità vite/dado	Cl 12.9 M36 ● 55 mm
Attacco aria	1/2" GAS
Pressione di utilizzo	6,2 bar
Ø interno tubo aria	13 mm
Consumo aria medio	480 l/min
Peso	15 kg

1	kg	1	019300070
15			

1931CD6

trapano reversibile in composito

oB

CE



Velocità libera	2.600 giri/min
Capacità mandrino	1÷6 mm
Potenza	0,23 kW
Filettatura albero	3/8" - 24UNF
Attacco aria	1/4" GAS
Pressione di utilizzo	6,2 bar
Ø interno tubo aria	8 mm
Consumo aria medio	130 l/min
Peso	0,6 kg

1	kg	1	019310006
0,6			

1931CD10

trapano reversibile in composito

oB

CE



Velocità libera	1.800 giri/min
Capacità mandrino	1÷10 mm
Potenza	0,38 kW
Filettatura albero	3/8" - 24UNF
Attacco aria	1/4" GAS
Pressione di utilizzo	6,2 bar
Ø interno tubo aria	10 mm
Consumo aria medio	170 l/min
Peso	1,0 kg

1	kg	1	019310010
1,0			

1931CD13

trapano reversibile in composito

oB

CE



Velocità libera	800 giri/min
Capacità mandrino	1,0÷13 mm
Potenza	0,38 kW
Filettatura albero	1/2" - 20UNC
Attacco aria	1/4" GAS
Pressione di utilizzo	6,2 bar
Ø interno tubo aria	10 mm
Consumo aria medio	170 l/min
Peso	1,3 kg

1	kg	1	019310013
1,3			

1931AN10

trapano angolare reversibile

oB

CE



Velocità libera	1.400 giri/min
Capacità mandrino	1÷10 mm
Potenza	0,38 kW
Filettatura albero	3/8" - 24UNF
Attacco aria	1/4" GAS
Pressione di utilizzo	6,2 bar
Ø interno tubo aria	10 mm
Consumo aria medio	150 l/min
Peso	1,1 kg

1	kg	1	019310030
1,1			

1932B10

trapano reversibile



Velocità libera	1.800 giri/min
Capacità mandrino	1÷10 mm
Potenza	0,44 kW
Filettatura albero	3/8" - 24UNF
Attacco aria	1/4" GAS
Pressione di utilizzo	6,2 bar
Ø interno tubo aria	10 mm
Consumo aria medio	160 l/min
Peso	1,2 kg

kg 1,2

1 019320040

1932RS13

trapano reversibile



Velocità libera	750 giri/min
Capacità mandrino	1,5÷13 mm
Potenza	0,55 kW
Filettatura albero	3/8" - 24UNF
Attacco aria	1/4" GAS
Pressione di utilizzo	6,2 bar
Ø interno tubo aria	10 mm
Consumo aria medio	160 l/min
Peso	1,4 kg

kg 1,4

1 019320043

1932B13

trapano reversibile



Velocità libera	400 giri/min
Capacità mandrino	1,5÷13 mm
Potenza	0,34 kW
Filettatura albero	1/2" - 20UNC
Attacco aria	1/4" GAS
Pressione di utilizzo	6,2 bar
Ø interno tubo aria	10 mm
Consumo aria medio	180 l/min
Peso	1,6 kg

kg 1,6

1 019320004

1933IH

smerrigliatrice assiale alta potenza

• Fornita con pinza di Ø 3 e 6 mm



Velocità libera	20.000 giri/min
Capacità pinza	3 - 6 mm
Potenza	0,75 kW
Attacco aria	1/4" GAS
Pressione di utilizzo	6,2 bar
Ø interno tubo aria	10 mm
Consumo aria medio	370 l/min
Peso	800 g

g 800

1 019330006



1933ILH

smerrigliatrice assiale alta potenza con albero prolungato

• Fornita con pinza di Ø 3 e 6 mm

CE



Velocità libera	20.000 giri/min
Capacità pinza	3 - 6 mm
Potenza	0,75 kW
Attacco aria	1/4" GAS
Pressione di utilizzo	6,2 bar
Ø interno tubo aria	10 mm
Consumo aria medio	370 l/min
Peso	1,2 kg

kg 1,2

1 019330011

1933AN90-H

smerrigliatrice angolare alta potenza

• Fornita con pinza di Ø 3 e 6 mm

CE



Velocità libera	15.000 giri/min
Capacità pinza	3 - 6 mm
Potenza	0,75 kW
Attacco aria	1/4" GAS
Pressione di utilizzo	6,2 bar
Ø interno tubo aria	10 mm
Consumo aria medio	370 l/min
Peso	1,1 kg

kg 1,1

1 019330021

1933

smerrigliatrice assiale

• Fornita con pinza di Ø 3 e 6 mm

CE



Velocità libera	25.000 giri/min
Capacità pinza	3 - 6 mm
Potenza	0,20 kW
Attacco aria	1/4" GAS
Pressione di utilizzo	6,2 bar
Ø interno tubo aria	10 mm
Consumo aria medio	230 l/min
Peso	380 g

g 380

1 019330001

1933I

smerigliatrice assiale

• Fornita con pinza di Ø 3 e 6 mm

CE



Velocità libera	20.000 giri/min
Capacità pinza	3 - 6 mm
Potenza	0,38 kW
Attacco aria	1/4" GAS
Pressione di utilizzo	6,2 bar
Ø interno tubo aria	10 mm
Consumo aria medio	260 l/min
Peso	670 g



g

670



1 019330005

1933L

smerigliatrice assiale
con albero prolungato

• Fornita con pinza di Ø 3 e 6 mm

CE



Velocità libera	25.000 giri/min
Capacità pinza	3 - 6 mm
Potenza	0,20 kW
Attacco aria	1/4" GAS
Pressione di utilizzo	6,2 bar
Ø interno tubo aria	10 mm
Consumo aria medio	270 l/min
Peso	670 g



g

670



1 019330015

1933IL

smerigliatrice assiale con albero prolungato

• Fornita con pinza di Ø 3 e 6 mm

CE



Velocità libera	20.000 giri/min
Capacità pinza	3 - 6 mm
Potenza	0,38 kW
Attacco aria	1/4" GAS
Pressione di utilizzo	6,2 bar
Ø interno tubo aria	10 mm
Consumo aria medio	113 l/min
Peso	1,4 kg



kg

1,4



1 019330010

1933AN90

smerigliatrice angolare

• Fornita con pinza di Ø 3 e 6 mm

CE



Velocità libera	20.000 giri/min
Capacità pinza	3 - 6 mm
Potenza	0,20 kW
Attacco aria	1/4" GAS
Pressione di utilizzo	6,2 bar
Ø interno tubo aria	10 mm
Consumo aria medio	230 l/min
Peso	510 g



g

510



1 019330020

1934BV

pulitrice a basse velocità

• Fornita con pinza di Ø 3 e 6 mm

CE



Velocità libera	3.700 giri/min
Capacità pinza	3 - 6 mm
Potenza	0,37 kW
Attacco aria	1/4" GAS
Pressione di utilizzo	6,2 bar
Ø interno tubo aria	10 mm
Consumo aria medio	113 l/min
Peso	840 g



g

840



1 019340000

1934MAV

microsmerigliatrice assiale

CE



Velocità libera	56.000 giri/min
Capacità pinza	3 mm
Potenza	0,04 kW
Attacco aria	1/4" GAS BSPT
Pressione di utilizzo	6,2 bar
Ø interno tubo aria	4,5 mm
Consumo aria medio	115 l/min
Peso	205 g



g

205



1 019340010

1934MAV70

microsmerigliatrice assiale ad alta velocità

CE



Velocità libera	70.000 giri/min
Capacità pinza	3 mm
Potenza	0,08 kW
Attacco aria	1/4" GAS BSPT
Pressione di utilizzo	6,2 bar
Ø interno tubo aria	4,5 mm
Consumo aria medio	115 l/min
Peso	210 g



g

210



1 019340030



1935F

giravite reversibile



Velocità libera	800 giri/min
Campo di coppia	4-16 Nm
Capacità vite	6-9 M
Porta inserti	● 1/4"
Attacco aria	1/4" GAS
Pressione di utilizzo	6,2 bar
Ø interno tubo aria	10 mm
Consumo aria medio	150 l/min
Peso	1,3 kg

kg
1,3

1 019350045

1936/4A

smerigliatrice angolare



Velocità libera	11.000 giri/min
Dimensione mola	115 mm
Potenza	0,66 kW
Filettatura albero	M14
Attacco aria	1/4" GAS
Pressione di utilizzo	6,2 bar
Ø interno tubo aria	10 mm
Consumo aria medio	390 l/min
Peso	1,8 kg

kg
1,8

1 019360024

1936/5A

smerigliatrice angolare



Velocità libera	10.000 giri/min
Dimensione mola	125 mm
Potenza	0,66 kW
Filettatura albero	M14
Attacco aria	1/4" GAS
Pressione di utilizzo	6,2 bar
Ø interno tubo aria	10 mm
Consumo aria medio	390 l/min
Peso	1,9 kg

kg
1,9

1 019360025

1936/7A

smerigliatrice angolare



Velocità libera	7600 giri/min
Dimensione mola	180 mm
Potenza	1,3 kW
Filettatura albero	M14
Attacco aria	3/8" GAS
Pressione di utilizzo	6,2 bar
Ø interno tubo aria	13 mm
Consumo aria medio	906 l/min
Peso	2,7 kg

kg
2,7

1 019360027

1937

levigatrice rotorbitale palmare

senza lubrificazione, in composito

- Diametro orbita 5 mm
- Fornita completa di 3 adattatori per tubi: Ø25,4mm (1") Ø28,6mm (1-1/8") Ø31,8mm (1-1/4")



Velocità libera	12.000 giri/min
Potenza	0,18 kW
Dimensione platorello	150 mm
Diametro orbita	5 mm
Filettatura albero	5/16"-24
Attacco aria	1/4" GAS
Pressione di utilizzo	6,2 bar
Ø interno tubo aria	10 mm
Consumo aria medio	170 l/min
Peso	0,86 kg

kg
0,86

1 019370001

1937R/P

platorello Ø 150 mm 6 fori per 1937



1937R/P

1 019370002

1937KC

mini levigatrice rotorbitale

- Diametro orbita 4 mm
- 2 platorelli di levigatura Ø 50 mm e Ø 75 mm
- 10 dischi carta abrasiva Ø 50 mm grana 400, 600, 800
- 10 dischi carta abrasiva Ø 75 mm grana 400, 600, 800



Velocità libera	15000 giri/min
Potenza	0,25 kW
Dimensione platorello	50 - 75 mm
Filettatura albero	M6 x 1,0
Attacco aria	1/4" GAS BSPT
Pressione utilizzo	6,2 bar
Ø interno tubo aria	10 mm
Consumo aria medio	79 l/min
Peso lucidatrice	0,64 kg
Peso kit	1,4 kg

kg
1,4

1 019370171



1937C...

dischi carta abrasiva per 1937KC



Ø mm	P		
50	400	1	019370175
50	600	1	019370176
50	800	1	019370177
75	400	1	019370178
75	600	1	019370179
75	800	1	019370180

* I prezzi indicati sono relativi a 10 pezzi

1937KL

mini lucidatrice

- Platorello di levigatura Ø 75 mm
- 2 spugne di lucidatura Ø 90mm - 1937/KL-DSB, 1937/KL-DSG
- Lana d'agnello Ø 90 mm - 1937/KL-DLA

CE



Velocità libera	3.200 giri/min
Potenza	0,25 kW
Dimensione platorello	75 mm
Filettatura albero	M6
Attacco aria	1/4" GAS BSPT
Pressione di utilizzo	6,2 bar
Ø interno tubo aria	10 mm
Consumo aria medio	91 l/min
Peso lucidatrice	0,75 kg
Peso kit	1,8 kg

kg	1,8	1	019370161
----	-----	---	-----------

1937KL-D

accessori per 1937KL



Ø mm			
1937KL-DLA	90	1	019370164
1937KL-DSB	90	1	019370165
1937KL-DSG	90	1	019370166

1937K...

platorelli per 1937KC e 1937KL



Ø mm	1937KC	1937KL		
1937KC-RP	50	•	1	019370173
1937KL-RP	75	• •	1	019370163

1937M

levigatrice multifunzione
con 16 accessori

CE



Velocità libera	3.500 giri/min
Potenza	0,34 kW
Attacco aria	1/4" GAS
Pressione di utilizzo	6,2 bar
Ø interno tubo aria	10 mm
Consumo aria medio	113 l/min
Peso levigatrice	1,5 kg
Peso kit	4,5 kg

kg	4,5	1	019370011
----	-----	---	-----------

458x495x116 mm

1937M-01÷11

accessori per 1937M



L mm	1937M-		
1937M-01	30	1	019370101
1937M-02	30	1	019370102
1937M-03	11	1	019370103
1937M-04	23	1	019370104
1937M-05	11	1	019370105
1937M-06	23	1	019370106
* 1937M-07	16	1	019370107
1937M-08	13 07	1	019370108
1937M-09	26 07	1	019370109
1937M-10	11 03, 05	1	019370110
1937M-11	23 01, 02, 04, 06	1	019370111

* I prezzi indicati sono relativi a 6 pezzi

1937N10

levigatrice a nastro

CE



Velocità libera	20.000 giri/min
Potenza	0,37 kW
Dimensioni nastro	10x330 mm
Attacco aria	1/4" GAS
Pressione di utilizzo	6,2 bar
Ø interno tubo aria	10 mm
Consumo aria medio	374 l/min
Peso	0,9 kg

kg	0,9	1	019370041
----	-----	---	-----------

1937N10-GR

nastri abrasivi per 1937N10



	P		
1937N10-GR60	60	1	019370146
1937N10-GR80	80	1	019370148
1937N10-GR100	100	1	019370150
1937N10-GR120	120	1	019370152

I prezzi indicati sono relativi a 10 pezzi

1937N20

levigatrice a nastro

CE



Velocità libera	16.000 giri/min
Potenza	0,45 kW
Dimensioni nastro	20x520 mm
Attacco aria	1/4" GAS
Pressione di utilizzo	6,2 bar
Ø interno tubo aria	10 mm
Consumo aria medio	400 l/min
Peso	1,6 kg

kg	1,6	1	019370051
----	-----	---	-----------

1937N20-GR

nastri abrasivi per 1937N20



	P		
1937N20-GR60	60	1	019370156
1937N20-GR80	80	1	019370158
1937N20-GR100	100	1	019370160
1937N20-GR120	120	1	019370162

I prezzi indicati sono relativi a 10 pezzi

1938

staccavetri

• Fornito con 1 lama dritta da 57 mm

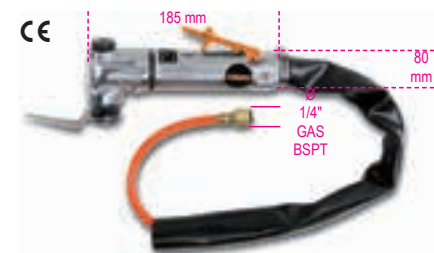

Oscillazioni al minuto	20.000
Attacco aria	1/4" GAS
Pressione di utilizzo	6,2 bar
Ø interno tubo aria	6,5 mm
Consumo aria medio	200 l/min
Peso	1,0 kg

kg	1,0	
		1 019380021

1938R/L

lame per staccavetri

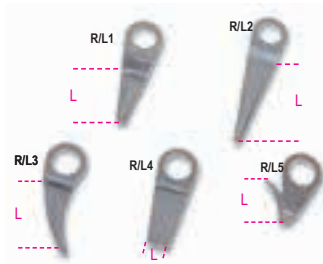

	L		
	mm		
1938R/L1	57	1	019380041
1938R/L2	90	1	019380042
1938R/L3	30	1	019380043
1938R/L4	8	1	019380044
1938R/L5	36	1	019380045

1938R/S5

serie di 5 lame per staccavetri 1938

1938R/S5		1	019380055
----------	--	---	-----------

1940

martello scalpellatore

• Fornito con molla di ritegno e trattenitore di sicurezza a baionetta per punte esagonali



Colpi al minuto	3.500
Dimensione attacco	Ø 11 mm
Dimensione pistone	19 mm
Corsa del pistone	67 mm
Attacco aria	1/4" GAS
Pressione di utilizzo	6,2 bar
Ø interno tubo aria	8 mm
Consumo aria medio	240 l/min
Peso	1,9 kg

kg	1,9	
		1 019400001

1940/C6

martello scalpellatore con 5 scalpelli e accessori

• Permette di tagliare lamiere, viti e carrozzerie, rimuovere punti di saldatura, rivetti, intonaci e piastrelle
 • Assortimento in pratica valigetta in ABS composto da:
 1 martello scalpellatore 1940
 1 scalpello piatto 1940SN
 1 scalpello per demolizione 1940ST
 1 scalpello a punta tonda 1940SD
 1 scalpello inclinato ad unghia 1940SPS
 1 scalpello taglia lamiera 1940SDT
 1 molla di tenuta 1940MT
 1 trattenitore di sicurezza a baionetta per punte esagonali



Colpi al minuto	3.500
Dimensione attacco	Ø 11 mm
Dimensione pistone	19 mm
Corsa del pistone	67 mm
Attacco aria	1/4" GAS
Pressione di utilizzo	6,2 bar
Ø interno tubo aria	8 mm
Consumo aria medio	240 l/min

kg	3,3	
		1 019400000
320x240x90 mm		

1940MT

molla di tenuta per 1940



1940MT		5	019400110
--------	--	---	-----------

1940S...

scalpelli per martelli scalpellatori 1940



1940SN		5	019400020
1940ST		5	019400021
1940SD		5	019400022
1940SPS		5	019400023
1940SDT		5	019400024

1940/S5

serie di 5 scalpelli per martelli scalpellatori 1940



1940/S5		1	019400030
---------	--	---	-----------

1940E10

martello scalpellatore

• Compatibile con scalpelli con attacco esagonale da 10 mm
 • fornito con molla di ritegno e trattenitore di sicurezza a baionetta



Colpi al minuto	2.900
Dimensione attacco	Ø 10 mm
Dimensione pistone	19 mm
Corsa del pistone	67 mm
Attacco aria	1/4" GAS
Pressione di utilizzo	6,2 bar
Ø interno tubo aria	10 mm
Consumo aria medio	76 l/min
Peso	1,7 kg

kg	1,7	
		1 019400010

1940E10/MT

molla di tenuta per 1940E10



1940E10/MT 5 019400112

1940E10/S...

scalpelli per martelli scalpellatori 1940E10



1940E10/SN	5	019400040
1940E10/ST	5	019400041
1940E10/SD	5	019400042
1940E10/SPS	5	019400043
1940E10/SDT	5	019400044

1940E10/S5

serie di 5 scalpelli per martelli scalpellatori 1940E10



1940E10/S5 1 019400050

1942A

seghetto alternativo

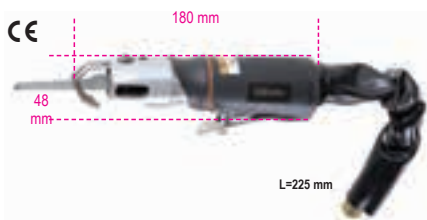

Corse al minuto	10.000
Lunghezza della corsa	10 mm
Attacco aria	1/4" GAS BSP
Pressione di utilizzo	6,2 bar
Ø interno tubo aria	8 mm
Consumo aria medio	75 l/min
Peso	550 g

550 1 019420000

1942LR

lame Bimetal per seghetto alternativo 1942A



1942LR 5 019420032

1944A

scrostatore ad aghi assiale

CE



Colpi al minuto	3.800
Corsa del pistone	33 mm
N. aghi	19
Ø aghi	3 mm
Attacco aria	1/4" GAS
Pressione di utilizzo	6,2 bar
Ø interno tubo aria	10 mm
Consumo aria medio	85 l/min
Peso	2,8 kg

2,8 kg 1 019440011

1944N

scrostatore ad aghi



Colpi al minuto	3800
Corsa del pistone	33 mm
N. aghi	19
Ø aghi	3 mm
Attacco aria	1/4" GAS
Pressione di utilizzo	6,2 bar
Ø interno tubo aria	10 mm
Consumo aria medio	85 l/min
Peso	2,7 kg

2,7 kg 1 019440002

1944AR

aghi di ricambio per scrostatore 1944N e 1944A



1944AR 2	Ø 2 mm	n. 29	1	019440015
1944AR 3	Ø 3 mm	n. 19	1	019440005

1944PA

piastre porta aghi per 1944N e 1944A



1944PA 2	Ø 2 mm	N. 29	1	019440016
1944PA 3	Ø 3 mm	N. 19	1	019440006

1945S

graffettatrice

Utilizza graffette tipo 80, sezione 0,95 x 0,65 mm (21 Gauge), lunghezza 4 - 16 mm, larghezza 12,8 mm



Capacità caricatore	157 pz.
Attacco aria	1/4" GAS
Pressione utilizzo	4,2 - 7 bar
Ø interno tubo aria	8 mm
Consumo aria (7 bar)	0,34 l/ciclo
Peso	0,87 kg

0,9 kg 1 019450000

1945S/G...

graffette tipo 80, sezione 0,95x0,65 mm (21 Gauge), larghezza 12,8 mm per 1945S



1945S/G4	L 4 mm	1	019450004
1945S/G6	L 6 mm	1	019450006
1945S/G8	L 8 mm	1	019450008
1945S/G10	L 10 mm	1	019450010
1945S/G12	L 12 mm	1	019450012
1945S/G14	L 14 mm	1	019450014
1945S/G16	L 16 mm	1	019450016

I prezzi indicati sono relativi a 5.000 pezzi
I prezzi indicati sono relativi a 10.000 pezzi



1945C

graffettatrice, groppinatrice combinata

- Utilizza graffette tipo 90, sezione 1,25 x 1,0 mm (18 Gauge), lunghezza 16 - 40 mm, larghezza 5,8 mm
- Utilizza groppini tipo B12, sezione 1,25 x 1,0 mm (18 Gauge), lunghezza 15 - 50 mm, testa da 1,9 mm



Capacità caricatore	100 pz.
Attacco aria	1/4" GAS
Pressione utilizzo	5 - 8 bar
Ø interno tubo aria	8 mm
Consumo aria (7 bar)	1,12 l/ciclo
Peso	1,16 kg

kg 1,16 1 019450200

1945C/G...

graffette tipo 90, sezione 1,25x1,0 mm (18 Gauge), larghezza 5,8 mm per 1945C



	L mm		
1945C/G16	16	1	019450216
1945C/G19	19	1	019450219
1945C/G22	22	1	019450222
1945C/G25	25	1	019450225
1945C/G28	28	1	019450228
1945C/G32	32	1	019450232
1945C/G35	35	1	019450235
1945C/G38	38	1	019450238
1945C/G40	40	1	019450240

I prezzi indicati sono relativi a 5.000 pezzi

1945C/GP...

groppini tipo B12, sezione 1,25x1,0 mm (18 Gauge), testa da 1,9 mm per 1945C



	L mm		
1945C/GP15	15	1	019450255
1945C/GP16	16	1	019450256
1945C/GP20	20	1	019450260
1945C/GP25	25	1	019450265
1945C/GP30	30	1	019450270
1945C/GP32	32	1	019450272
1945C/GP35	35	1	019450275
1945C/GP38	38	1	019450278
1945C/GP40	40	1	019450280
1945C/GP45	45	1	019450285
1945C/GP50	50	1	019450290

I prezzi indicati sono relativi a 5.000 pezzi



1945P

spillatrice

- Utilizza spilli tipo B6, Ø 0,64 mm (23 Gauge), lunghezza 12 - 35 mm



Capacità caricatore	145 pz.
Attacco aria	1/4" GAS
Pressione utilizzo	4 - 7 bar
Ø interno tubo aria	8 mm
Consumo aria (7 bar)	0,27 l/ciclo
Peso	0,87 kg

kg 0,87 1 019450100

1945P/S...

spilli tipo B6, Ø 0,64 mm (23 Gauge) per 1945P



	L mm		
1945P/S12	12	1	019450112
1945P/S15	15	1	019450115
1945P/S18	18	1	019450118
1945P/S20	20	1	019450120
1945P/S21	21	1	019450121
1945P/S22	22	1	019450122
1945P/S25	25	1	019450125
1945P/S30	30	1	019450130
1945P/S35	35	1	019450135

I prezzi indicati sono relativi a 10.000 pezzi

1946T

rivettatrice

- fornita con ugelli intercambiabili per rivetti in acciaio, acciaio inox, alluminio e rame da 2,4 - 3,2 - 4,0 - 4,8 mm



Potenza di trazione	9.000 N
Lunghezza della corsa	16 mm
Capacità massima rivetti	Ø acciaio inox 4,8 mm
Attacco aria	1/4" GAS
Pressione di utilizzo	6,2 bar
Ø interno tubo aria	8 mm
Consumo aria	2,0 l/ciclo
Peso	1,7 kg

kg 1,7 1 019460021

1946C4,8

rivettatrice

- Con aspirazione automatica
- Fornita assemblata per rivetti in acciaio, acciaio inox, alluminio e rame, da 2,4 - 3,2 - 4,0 - 4,8 mm



Potenza di trazione	8.900 N
Lunghezza della corsa	15 mm
Capacità massima rivetti	Ø acciaio inox 4,8 mm
Attacco aria	1/4" GAS
Pressione di utilizzo	6,2 bar
Ø interno tubo aria	10 mm
Consumo aria	2,6 l/ciclo
Peso	1,5 kg

kg 1,5 1 019460006



1946C7,8

rivettatrice

- Con aspirazione automatica
- Fornita assemblata per rivetti in acciaio, acciaio inox, alluminio e rame, da 4,8 - 5,6 - 6,4 - 7,8 mm

CE



Potenza di trazione	16.900 N
Lunghezza della corsa	22,5 mm
Capacità massima rivetti	Ø acciaio inox 7,8 mm
Attacco aria	1/4" GAS
Pressione di utilizzo	6,2 bar
Ø interno tubo aria	10 mm
Consumo aria	4,9 l/ciclo
Peso	1,8 kg

kg	1,8	1	019460008
----	-----	---	-----------

1946C/T...

testine per rivetti strutturali



Ø mm			
1946C/T4,8	4,8	1	019460016
1946C/T6,4	6,4	1	019460018

1946KF

rivettatrice per inserti filettati

- fornita assemblata per rivetti filettati in acciaio, acciaio inox, alluminio e rame, M4, M5, M6, M8

CE



Potenza di trazione	14.235 N
Lunghezza della corsa	7 mm
Capacità massima rivetti	Ø acciaio inox M8
Attacco aria	1/4" GAS
Pressione di utilizzo	6,2 bar
Ø interno tubo aria	10 mm
Consumo aria	2,1 l/ciclo
Peso rivettatrice	2,1 kg
Peso kit	3,4 kg

kg	3,4	1	019460012
----	-----	---	-----------

1946KF/M...

perni di ricambio per 1946KF



1946KF/M4	1	019460124
1946KF/M5	1	019460125
1946KF/M6	1	019460126
1946KF/M8	1	019460128

1947

pistola per sigillanti

- Pistola pneumatica per silicone, collanti e sigillanti di media densità
- Supporta cartucce standard (215/218 x 50/51 mm) rigide

CE



Dimensione del tubo	210x50 mm
Capacità della cartuccia	300 ml
Attacco aria	1/4" GAS
Pressione di utilizzo	4,8 bar
Ø interno tubo aria	10 mm
Consumo aria medio	120 l/min
Peso	1,1 kg

kg	1,1	1	019470001
----	-----	---	-----------

1947H

pistola per sigillanti

- pistola pneumatica per l'estrusione di siliconi e sigillanti in cartucce standard di plastica o alluminio
- supporta cartucce standard (215/218 x 50/51 mm) rigide
- riduttore di pressione integrato

CE



Dimensione del tubo	210x50 mm
Capacità della cartuccia	300/310 ml
Attacco aria	1/4" GAS
Pressione di utilizzo	4 ÷ 8 bar
Ø interno tubo aria	2,5 mm
Consumo aria medio	120 l/min
Peso	750 g

g	750	1	019470011
---	-----	---	-----------

1947G

pistola per ingrassaggio

testa pressofusa in alluminio
impugnatura ergonomica con figura a spigolo per accedere in spazi ristretti
valvola in ottone per un'elevata durata
funziona con cartucce da 400 g o grasso sfuso fino a 500 cc

CE



dimensioni del tubo: 54 (interno) x 260 mm
attacco aria: 1/4" GAS
pressione d'utilizzo: 4÷10 bar
peso: 1.9 kg

1947G	1	019470051
-------	---	-----------

1947G2

pistola per ingrassaggio 2 in 1

per erogazione graduale o continua del grasso
testa pressofusa in alluminio
impugnatura ergonomica
funziona con cartucce da 400 g o grasso sfuso fino a 500 cc
completo di:
1 canna flessibile, lunghezza 800 mm
1 testina a 4 griffe tipo "Hydraulic" M10x1

CE



Dimensione del tubo	54 (interno) x 276 mm
Attacco aria	1/4" GAS BSP
Pressione d'utilizzo	3÷10 bar
Peso	2,2 kg

1947G2	1	019470060
--------	---	-----------



1948

penna per incisioni

- consente marcature su materiali quali l'acciaio, l'acciaio inossidabile, l'alluminio, il vetro, la pietra e la ceramica

CE



Colpi al minuto	3.500 ÷ 3.800
Durezza massima	60 HRC
Attacco aria	1/4" GAS
Pressione di utilizzo	6,2 bar
Consumo aria medio	50 l/min
Peso	150 g

150 g 1 019480001

1948PR

punta in carburo di tungsteno di ricambio per 1948

- durezza massima: 60 HRC



1948PR 1 019480005

1949U5

pistola di soffiaggio progressiva con 5 ugelli

- Corpo in materiale composito ad alta resistenza, antiurto
- 3 ugelli in acciaio 100/160/320 mm con puntale di protezione in gomma antigraffio
- 1 ugello "Turbo" in nylon rinforzato con fibre di vetro con puntale di sicurezza
- 1 ugello orientabile 100 mm in nylon rinforzato con fibre di vetro
- Dotato di sistema di fissaggio rapido



Inserto ottone filettato	1/4" GAS
Pressione di utilizzo	10 bar
Pressione massima di utilizzo	15 bar
Consumo aria medio	280 l/min
Temperatura di utilizzo	-10°C ÷ 85°C
Peso	93 g

93 g 1 019490030

1949U5/A

ugello in acciaio 100 mm con puntale di protezione in gomma antigraffio per 1949U5 - 1949P



1949U5/A 1 019490131

1949U5/B

ugello in acciaio 160 mm con puntale di protezione in gomma antigraffio per 1949U5 - 1949P



1949U5/B 1 019490132

1949U5/C

ugello in acciaio 320 mm con puntale di protezione in gomma antigraffio per 1949U5 - 1949P



1949U5/C 1 019490133

1949U5/D

ugello orientabile 100 mm in nylon rinforzato con fibre di vetro per 1949U5 - 1949P



1949U5/D 1 019490134

1949U5/E

ugello "Turbo" in nylon rinforzato con fibre di vetro con puntale di sicurezza per 1949U5 - 1949P



1949U5/E 1 019490135

1949U5/F

ugello a ventaglio piatto, in nylon rinforzato con fibre di vetro, per 1949U5 e 1949P



1949U5/F 1 019490136

1949U5/G

ugello OSHA, in nylon rinforzato con fibre di vetro, per 1949U5 e 1949P



1949U5/G 1 019490137

1949BC

pistola di soffiaggio progressiva con ugello in gomma

- Corpo in materiale composito ad alta resistenza, antiurto
- Ugello in gomma antigraffio sostituibile
- Dotato di innesto



Inserto alluminio filettato	1/4" GAS
Pressione di utilizzo	6-8 bar
Pressione massima di utilizzo	15 bar
Consumo aria medio	87 l/min
Temperatura di utilizzo	-20°C ÷ 70°C
Peso	120 g

120 g 1 019490022

1949BC/RU

5 ugelli in gomma per 1949BC



1949BC/RU 1 019490122

1949P

mini pistola di soffiaggio progressiva

- Corpo in materiale composito ad alta resistenza, antiurto
- Sistema di fissaggio rapido degli ugelli
- Flusso dell'aria regolabile tramite rotazione della ghiera

Ø 1/4" GAS BSPT



Inserto ottone filettato	1/4" GAS
Pressione di utilizzo	6,2 bar
Pressione massima di utilizzo	8,3 bar
Consumo aria medio	280 l/min
Temperatura di utilizzo	-10°C ÷ 85°C
Peso	70 g

70 g 1 019490031

1949T

pistola di soffiaggio progressiva telescopica

- Corpo in materiale composito ad alta resistenza, antiurto
- Tubo telescopico in acciaio orientabile: 165 mm + 300 mm
- Dotato di innesto

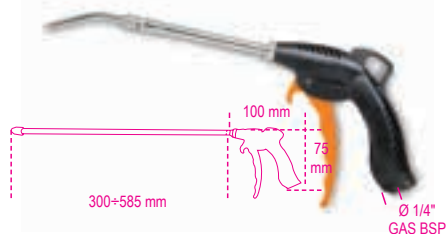

Inserto in alluminio filettato
Pressione di utilizzo
Pressione massima di utilizzo
Consumo aria medio
Temperatura di utilizzo
Peso

1/4" GAS
6÷8 bar
15 bar
144 l/min
-20°C ÷ 70°C
190 g

g 190 1 019490040

1949F2

pistola di soffiaggio progressiva

- In composito di materiale plastico ad alta resistenza, antiurto, antigraffio e termicamente isolato
- La speciale valvola e la sensibilità della leva consentono la progressiva apertura del circuito, ottimizzando il flusso dell'aria
- Puntale dotato di cono di sicurezza in plastica per una movimentazione sicura in fase di non utilizzo



Inserto ottone filettato
Pressione di utilizzo
Pressione massima di utilizzo
Temperatura di utilizzo
Peso

1/4" GAS
4-8 bar
12 bar
-20°C ÷ 70°C
125 g

g 125 1 019490028

1949GPA

pistola per gonfiaggio pneumatici

- corpo interamente rivestito in gomma antiurto
- leva d'azionamento in metallo
- pressione di esercizio 0,5÷12 bar, 7÷174 psi
- funzione di scarico della pressione
- funzione di sola misurazione della pressione
- lunghezza tubo 58 cm
- rotazione del tubo a 360°
- attacco aria 1/4



bar psi 1949GPA 0,5÷12 7÷174 1 019490018

1949DGT/2

pistola digitale per gonfiaggio pneumatici

- corpo interamente rivestito in gomma antiurto
- leva d'azionamento in metallo
- pressione di esercizio 0,5÷12 bar, 7÷174 psi
- 4 unità di misura, bar/psi/kpa/kgf
- display LCD retroilluminato
- risoluzione 0,05 bar
- spegnimento automatico dopo 1,5 minuti
- lunghezza tubo 58 cm
- rotazione del tubo a 360°
- alimentazione 2 batterie AAA
- attacco aria 1/4



bar psi 1949DGT/2 0,5÷12 7÷174 1 019490021

1949GPN

pistola per gonfiaggio pneumatici corpo in ABS

- manometro certificato CE con scala 0,7÷12 bar (ripartizione in 1/10 bar)
- 2 pulsanti servoassistiti consentono il gonfiaggio (+) e lo sgonfiaggio (-) del pneumatico con precisione e rapidità
- fornita con certificato di taratura
- fornita con guscio di protezione antiurto e occhiello per aggancio
- fornita con raccordo filettato 1/4" GAS
- attacco aria girevole per tubo in gomma Ø7 mm



bar psi 1949GPN 0,7÷12 810 1 019490011

1949M

misuratore di pressione per pneumatici



bar psi g 1949M 0÷4 5÷60 280 1 019490400

1950BZK

attrezzo tallonatore per pneumatici

- grazie alla maniglia secondaria con attivazione a pulsante permette di non staccare mai le mani dall'attrezzo durante l'utilizzo
- capacità serbatoio: 18 l
- pressione d'esercizio: 3-8 bar
- pressione massima serbatoio: 16 bar
- valvola di sicurezza per sovrappressione
- manometro con scala graduata
- bocchettone in materiale plastico per non rovinare il cerchio



1950BZK 1 019500078

1949R

pistola di soffiaggio per pulizia radiatori
i 5 fori perpendicolari allo stelo permettono la rimozione della sporcizia dai radiatori



L mm 600 6 1 019490050



1951

pistola di lavaggio

• indicata per la pulizia di tappezzeria auto, moquette, sedili e bagagliai



Capacità serbatoio	1 L
Attacco aria	1/4" GAS
Pressione di utilizzo	6,2 bar
Ø interno tubo aria	8 mm
Consumo aria medio	110 l/min
Peso	650 g

g	1	019510051

1951A

pistola di lavaggio con aspirazione

- Indicata per la pulizia di tappezzeria auto, moquette, sedili e bagagliai
- Da utilizzare con detergenti specifici
- Serbatoio da 1L
- Dotato di rubinetto per la regolazione dell'uscita del liquido contenuto nel serbatoio
- Completa di tubo corrugato da 1,8 m
- Compatibile con aspiratore codice 1873-1874



Capacità serbatoio	1 l
Attacco aria	1/4" GAS
Pressione di utilizzo	6,2 bar
Ø interno tubo aria	8 mm
Consumo aria medio	120 l/min
Peso	800 g

g	1	019510101

1952

aerografo per verniciatura professionale

- Corpo in alluminio pressofuso con trattamento protettivo in nickel chimico nero
- Tazza in nylon con dispositivo salvagoccia, filetto 3/8" BSP
- Filettatura sul corpo 1/4" BSP Gas cilindrica
- Regolatore di pressione e di portata aria
- Regolatore del getto da tondo a ventaglio
- Regolatore della quantità di vernice
- Fornito con chiave di servizio per la manutenzione

CE



	Ø mm		
1952 1,2	1,2	1	019520012
1952 1,5	1,5	1	019520015
1952 1,8	1,8	1	019520018
1952 2,0	2,0	1	019520020

1900S

avvolgitubo automatico a molla
corpo in materiale plastico antiurto
per utilizzo con aria o acqua

- pressione di utilizzo massima 15 bar
- tubo in Poliuretano retinato
- struttura in Polipropilene
- dispositivo automatico di arresto del tubo alla lunghezza desiderata
- cremagliera disinseribile per tubo sempre in trazione
- temperatura di utilizzo acqua -5°C/+50°C
- fornito con staffa orientabile di 180° e seconda staffa ad incastro rapido

CE

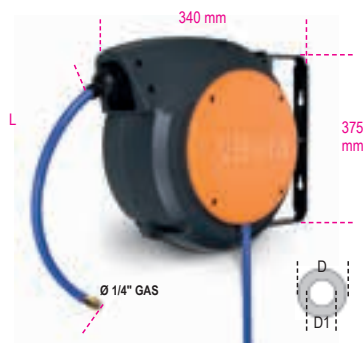

D1xD	L	Ø GAS		
mm	m	BSP		
8x12	10	1/4"	1	019000080

1900M

avvolgitubo automatico a molla
corpo in materiale plastico antiurto
per utilizzo con aria o acqua

- pressione di utilizzo massima 15 bar
- tubo in Poliuretano retinato
- struttura in Polipropilene
- dispositivo automatico di arresto del tubo alla lunghezza desiderata
- cremagliera disinseribile per tubo sempre in trazione
- temperatura di utilizzo acqua -5°C/+50°C
- fornito con staffa orientabile di 180° e seconda staffa ad incastro rapido

CE



D1xD	L	Ø GAS		
mm	m	BSP		
8x12	15	1/4"	1	019000085
10x14	15	3/8"	1	019000115

1914

spirali in poliuretano 98 Shore estensibili

- Pressione di utilizzo massima 12 bar

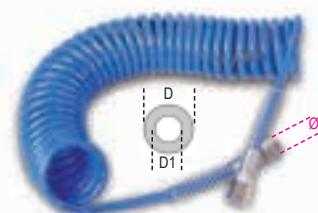

L	D1xD	Ø GAS		
m	mm	BSP		
4	5x8	1/4"	1	019140054
6	5x8	1/4"	1	019140056
10	5x8	1/4"	1	019140060

1915B

spirali in poliuretano 95 Shore
estensibili fino a 9 m

- Pressione di utilizzo massima 10 bar

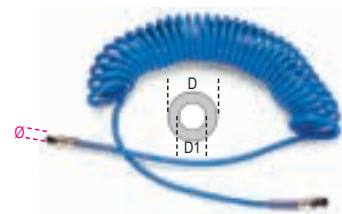

D1xD	Ø GAS		
mm	BSP		
6,5x10	1/4"	1	019150011
8x12	1/4"	1	019150012
11x16	3/8"	1	019150013

Beta

1915C

spirali in poliuretano 95 Shore
estensibili fino a 12 m

• Pressione di utilizzo massima 10 bar

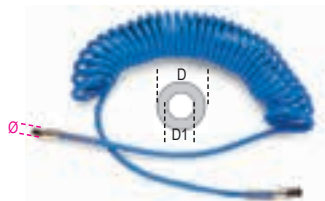

D1xD	Ø GAS		
mm	BSP		
6,5x10	1/4"	1	019150014
8x12	1/4"	1	019150015
11x16	3/8"	1	019150016

1915C/L

spirali in poliuretano 95 Shore
estensibili fino a 15 m

• Pressione di utilizzo massima 10 bar

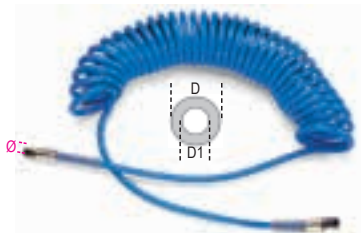

D1xD	Ø GAS		
mm	BSP		
8x12	1/4"	1	019150115
11x16	3/8"	1	019150116

1915D

tubo in poliuretano retinato 95 Shore
lunghezza 9 m

• Pressione di utilizzo massima 15 bar



D1xD	Ø GAS		
mm	BSP		
8x12	1/4"	1	019150017
11x16	3/8"	1	019150018

1915E

tubo in poliuretano retinato 95 Shore
lunghezza 12 m

• Pressione di utilizzo massima 15 bar



D1xD	Ø GAS		
mm	BSP		
8x12	1/4"	1	019150019
11x16	3/8"	1	019150020

1915E/XL

bobine in poliuretano retinato 95 Shore
lunghezza 50 m

• Pressione di utilizzo massima 15 bar



D1xD	Ø GAS		
mm	BSP		
8x12	1/4"	1	019150519
11x16	3/8"	1	019150520

1916I

innesti rapidi profilo Italia
filettati maschio, GAS cilindrici BSP



Ø GAS			
BSP			
1/4"	5	019160001	
3/8"	5	019160002	

1916G

innesti rapidi profilo Europa
filettati maschio, GAS conici BSPT



Ø GAS			
BSPT			
1/4"	5	019160005	
3/8"	5	019160010	
1/2"	5	019160012	

1916GF

innesti rapidi profilo Italia
filettati femmina, GAS cilindrici BSP



Ø GAS			
BSP			
1/4"	5	019160055	
3/8"	5	019160060	

1916GFE

innesti rapidi profilo Europa
filettati femmina, GAS conici BSPT



Ø GAS			
BSPT			
1/4"	5	019160075	
3/8"	5	019160082	
1/2"	5	019160084	

1916JM

innesti rapidi profilo asiatico
filettati maschio, GAS conici BSPT



Ø GAS			
BSPT			
1/4"	1	019160406	
3/8"	1	019160410	

1916JF

innesti rapidi profilo asiatico
filettati femmina, GAS cilindrico BSP



Ø GAS			
BSPT			
1/4"	1	019160456	
3/8"	1	019160460	

1916P

innesti rapidi profilo Italia
con mascherina portagomma



D1xD			
mm			
6x14	5	019160256	
8x17	5	019160258	
10x19	5	019160260	

Beta

1916S

innesti rapidi profilo Italia
con molla a spirale



D1xD mm			
6x8	5	019160306	
8x10	5	019160308	
10x12	5	019160310	

1917M

raccordi universali a sfera
con gomma antiurto
filettati maschio GAS cilindrici BSP

• accoppiabili agli innesti 1916I e 1916G



Ø GAS BSP			
1/4"	5	019170001	
3/8"	5	019170003	
1/2"	5	019170004	

1917F

raccordi universali a sfera
con gomma antiurto
filettati femmina GAS cilindrici BSP

• accoppiabili agli innesti 1916I e 1916G



Ø GAS BSP			
1/4"	5	019170005	
3/8"	5	019170010	
1/2"	5	019170014	

1917JM

raccordi universali a sfera
per profilo asiatico
filettati maschio GAS cilindrici BSP



Ø GAS BSP			
1/4"	1	019170406	
3/8"	1	019170410	
1/2"	1	019170412	

1917JF

raccordi a sfera per profilo asiatico
filettati femmina GAS cilindrici BSP



Ø GAS BSP			
1/4"	1	019170456	
3/8"	1	019170460	

1917RG

raccordo universale rotante

- In alluminio, filetto femmina, GAS cilindrico BSP filetto maschio, cilindrico BSP
- Accoppiabile a tutti gli innesti con profilo Italia ed Europa
- Rotazione libera anche in assenza d'aria connessa



Ø GAS BSP			
1/4"	1	019170252	

1917SP

raccordi universali a sfera
con mascherina portagomma



D1xD mm			
6x14	5	019170206	
8x17	5	019170208	
10x19	5	019170210	

1917ST

raccordi universali a sfera
con molla a spirale



D1xD mm			
6x8	5	019170306	
8x10	5	019170308	
10x12	5	019170310	

1918

attacco a resca filettato maschio



D1 mm	Ø GAS BSP		
6	1/8"	3	019180106
8	1/8"	3	019180108
6	1/4"	3	019180116
8	1/4"	3	019180118
10	1/4"	3	019180120
10	3/8"	3	019180130
12	3/8"	3	019180132
10	1/2"	3	019180140
12	1/2"	3	019180142

1918N

nippli di collegamento
con filetto conico BSPT



Ø GAS	Ø1 GAS		
1/4"	1/4"	5	019180300
3/8"	3/8"	5	019180310
1/2"	1/2"	5	019180320

1918R

nippli di riduzione
con filetto conico BSPT



Ø GAS	Ø1 GAS		
1/4"	3/8"	5	019180200
3/8"	1/2"	5	019180210

1919FE1/4

filtro regolatore lubrificatore



Attacchi aria entrata/uscita	1/4" GAS BSPT
Attacco manometro	1/8" GAS BSPT
Portata massima	750 l/min
Pressione massima	9,5 bar
Pressione di utilizzo	0,5 - 8,5 bar
Temperatura di utilizzo	5 - 60 °C
Capacità filtrante	5 micron
Capacità tazze	15 cc aria / 25 cc olio
Peso	700 g

1	019190200
---	-----------

1919RB-FE1/4

coppia bicchieri di ricambio per 1919FE1/4



1919RB-FE1/4

1 019190210

1919RF-FE1/4

ricambio elemento filtrante per 1919FE1/4



1919RF-FE1/4

1 019190230

1919RM-FE1/4

manometro di ricambio per 1919FE1/4



1919RM-FE

1 019190220

1919F1/4

filtro regolatore lubrificatore

Ø 1/4"



Attacchi aria entrata/uscita

1/4" GAS BSPT

Portata massima

1000 l/min

Pressione massima

9,5 bar

Pressione di utilizzo

0,5 - 8,5 bar

Temperatura di utilizzo

5 - 60 °C

Capacità filtrante

5 micron

Capacità tazze

60 cc aria / 90 cc olio

Peso

1,3 kg

kg
1,3

1 019190250

1919F3/8

filtro regolatore lubrificatore

Ø 3/8"



Attacchi aria entrata/uscita

3/8" GAS BSPT

Portata massima

1350 l/min

Pressione massima

9,5 bar

Pressione di utilizzo

0,5 - 8,5 bar

Temperatura di utilizzo

5 - 60 °C

Capacità filtrante

5 micron

Capacità tazze

60 cc aria / 90 cc olio

Peso

1,3 kg

kg
1,3

1 019190350

1919F1/2

filtro regolatore lubrificatore

Ø 1/2"



Attacchi aria entrata/uscita

1/2" GAS BSPT

Portata massima

2500 l/min

Pressione massima

9,5 bar

Pressione di utilizzo

0,5 - 8,5 bar

Temperatura di utilizzo

5 - 60 °C

Capacità filtrante

5 micron

Capacità tazze

60 cc aria / 90 cc olio

Peso

1,3 kg

kg
1,3

1 019190450

1919RB-F

coppia bicchieri per filtri 1919F - 1/4", 3/8" e 1/2"



1919RB-F

1 019190510

1919RF-F

ricambio elemento filtrante per filtri 1919F - 1/4", 3/8" e 1/2"



1919RF-F

1 019190530

1919RM-F

manometro di ricambio per filtri 1919F - 1/4", 3/8" e 1/2"



1919RM-F

1 019190520

1919ML

mini lubrificatori di linea



Ø

L

Ø

1/4"

63

36

1 019190030

3/8"

63

36

1 019190032

1919SC

mini separatore di condensa

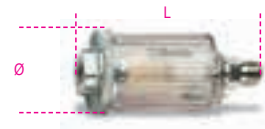

Ø

L

Ø

1/4"

80

40

1 019190035

1919L

olio lubrificatore ISO 32

Densità a 20°C

875 kg/m³

Viscosità a 40°C

32 cSt

Infiammabilità COC

210°C



cc
500

5 019190050

- **PRATICITÀ DI UTILIZZO**
- **ROBUSTEZZA**
- **DURATA NEL TEMPO**

BORSE E ZAINI IN TESSUTO TECNICO

Questi sono i tre cardini sui cui si sviluppa la gamma di Contenitori in Tessuto Beta. Le borse e gli zaini Beta sono realizzati in robusto tessuto tecnico, resistente alle abrasioni e all'usura, con fondo irrobustito e cuciture rinforzate per garantire un utilizzo affidabile nel tempo.

Ogni contenitore ha caratteristiche particolari pensate per utilizzi diversi e per l'ottimizzazione degli spazi: tasche con cerniera, impugnature a scomparsa, protezioni per le ruote, spillacci irrobustiti e buste trasparenti per documenti, sono solo alcune delle peculiarità proprie ad ogni borsa o zaino.

La costante cura dei dettagli, la varietà delle proposte e la particolare attenzione rivolta al trasporto degli utensili in totale sicurezza rendono questi prodotti i contenitori ideali in ogni condizione di lavoro.



VALIGIE IN POLIPROPILENE

Beta ti offre un'ampia gamma di valigie tecniche adatte ad ogni tipo di esigenza! Le valigie e i trolley Beta sono realizzati in robusto polipropilene ad alto spessore, resistente agli urti, alle sostanze corrosive e in grado di sopportare utilizzi gravosi anche a basse temperature.

Scegli il prodotto che più soddisfa la tua necessità lavorativa tra la classica valigia portautensili, la versione trolley con ruote per un facile trasporto, le versioni con

serrature TSA per viaggiare in totale libertà ed infine la versione in alluminio oppure a tenuta stagna impermeabile.

La maggior parte delle valigie e trolley Beta è disponibile anche in abbinamento ad assortimenti di utensili che rispondono a differenti esigenze lavorative, a seconda dei campi di applicazione: elettronica, idraulica, nautica e manutenzione.



2001/B26

busta in tessuto con assortimento di 26 utensili



2001/B26

1 020010215

55 6x7 - 8x9 - 10x11 - 12x13 - 14x15 - 16x17 mm

96N/SC9 1,5 - 2 - 2,5 - 3 - 4 - 5 - 6 - 8 - 10 mm

1044F 250 mm

1128BMX 145 mm

1150 180 mm

1201E 3x75 - 4x100 - 5,5x150 mm

1202E PH1x80 - PH2x100 mm

1370 300 g

1692 2 m

1770A 9 mm

2001/BV

1 020010051

2001/BZV

valigetta portautensili in tessuto tecnico ad alta resistenza, vuota

- Doppia maniglia superiore per una presa ottimale
- Ampia tasca frontale portadocumenti con chiusura a zip
- Fascia velcrata nella parte posteriore per fissare la valigetta alla maniglia dei trolley
- 20 pratici vani portautensili (6 tasche e 14 elastici)
- Asole porta martello
- Possibilità di applicazione della tracolla C9/RT (da ordinare a parte)



2001/BZV

1 020010151

380x290x60 mm - 675 g



2001/BZ24 MQ

valigetta pieghevole con assortimento di 24 utensili per elettricisti



2001/BZ24 MQ

1 020010154

	n.
1128BMX	1
1150MQ 180 mm	1
42 8-10-13-17-19 mm	5
1274MQ 3x100 - 4x100 - 5,5x125 mm	3
1272MQ PH0x60 - PH1x80 - PH2x100 mm	3
96BP/SC9 1,5-2-2,5-3-4-5-6-8-10 mm	9
1253	1
1082MQ 160 mm	1

2001/BZ27 VU

valigetta pieghevole con assortimento di 27 utensili per interventi universali



2001/BZ27 VU

1 020010157

	n.
1128BMX	1
1150 180 mm	1
42 7-8-10-13-17-19 mm	6
1201E 3x75 - 4x100 - 5,5x150 mm	3
1202E PH0x60 - PH1x80 - PH2x100 mm	3
96/SC9 1,5-2-2,5-3-4-5-6-8-10 mm	9
1370 300 g	1
1048N 250 mm	1
1692/5 5 m	1
1771 18 mm	1

2002/BV6

busta portautensili di tipo avvolgibile in poliestere resistente, vuota

- Con 6 pratici scomparti portautensili di diversa dimensione
- Comoda da trasportare grazie alla maniglia centrale in tessuto rinforzato
- Dotata di pateletta interna per evitare la fuoriuscita degli utensili
- Cuciture di rinforzo presenti su tutto il perimetro della busta
- Doppia chiusura con velcro
- Dimensioni aperta: mm 175 x 240



2002/BV6

1 020020000

2002/BVL6

busta portautensili di tipo avvolgibile in poliestere resistente, vuota

- Con 6 pratici scomparti portautensili di diversa dimensione
- Comoda da trasportare grazie alla maniglia centrale in tessuto rinforzato
- Dotata di pateletta interna per evitare la fuoriuscita degli utensili
- Cuciture di rinforzo presenti su tutto il perimetro della busta
- Doppia chiusura con velcro
- Dimensioni aperta: mm 220 x 290



2002/BVL6

1 020020010

2002/BV7-ZIP

busta portautensili di tipo avvolgibile in poliestere resistente, vuota

- Con 7 pratici scomparti portautensili di diversa dimensione e taschina portaminuteria con chiusura a zip
- Comoda da trasportare grazie alla maniglia centrale in tessuto rinforzato
- Dotata di pateletta interna per evitare la fuoriuscita degli utensili
- Cuciture di rinforzo presenti su tutto il perimetro della busta
- Doppia chiusura con velcro
- Dimensioni aperta: mm 355 x 220



2002/BV7-ZIP

1 020020060

2002/BV8

busta portautensili di tipo avvolgibile in poliestere resistente, vuota

- Con 8 pratici scomparti portautensili di diversa dimensione
- Comoda da trasportare grazie alla maniglia centrale in tessuto rinforzato
- Dotata di pateletta interna per evitare la fuoriuscita degli utensili
- Cuciture di rinforzo presenti su tutto il perimetro della busta
- Doppia chiusura con velcro
- Dimensioni aperta: mm 395 x 360



2002/BV8

1 020020020

2002/BV9

busta portautensili di tipo avvolgibile in poliestere resistente, vuota

- Con 9 pratici scomparti portautensili di diversa dimensione
- Comoda da trasportare grazie alla maniglia centrale in tessuto rinforzato
- Dotata di pateletta interna per evitare la fuoriuscita degli utensili
- Cuciture di rinforzo presenti su tutto il perimetro della busta
- Doppia chiusura con velcro
- Dimensioni aperta: mm 325 x 290



2002/BV9

1 020020030

2002/BV12

busta portautensili di tipo avvolgibile in poliestere resistente, vuota

- Con 12 pratici scomparti portautensili di diversa dimensione
- Comoda da trasportare grazie alla maniglia centrale in tessuto rinforzato
- Dotata di pateletta interna per evitare la fuoriuscita degli utensili
- Cuciture di rinforzo presenti su tutto il perimetro della busta
- Doppia chiusura con velcro
- Dimensioni aperta: mm 650 x 355



2002/BV12

1 020020040

2002/BV13

busta portautensili di tipo avvolgibile in poliestere resistente, vuota

- Con 13 pratici scomparti portautensili di diversa dimensione
- Comoda da trasportare grazie alla maniglia centrale in tessuto rinforzato
- Dotata di pateletta interna per evitare la fuoriuscita degli utensili
- Cuciture di rinforzo presenti su tutto il perimetro della busta
- Doppia chiusura con velcro
- Dimensioni aperta: mm 330 x 190



2002/BV13

1 020020050

2002/BV42

busta portautensili di tipo avvolgibile in poliestere resistente, vuota

- Con 42 pratici scomparti portautensili di diversa dimensione: 18 elastici e 24 tasche, di cui una dotata di pateletta di chiusura con velcro
- Comoda da trasportare grazie alla maniglia centrale in tessuto rinforzato
- Appendibile a muro per mezzo di anelli metallici
- Cuciture di rinforzo presenti su tutto il perimetro della busta
- Chiusura robusta con doppia fibbia a clip
- Dimensioni aperta: mm 595 x 540



2002/BV42

1 020020070

2005MPU

marsupio porta attrezzi vuoto in Nylon, con cintura

- Cinque ampie tasche portautensili
- Una taschina frontale porta forbice
- Fibbia con moschettone porta nastro adesivo
- Cintura regolabile da 70 a 120 cm

Dimensioni: 155x285x80 mm



2005MPU

1 020050060

2005PA/D

porta attrezzi vuoto in Nylon, con cintura



2005PA/D

1 020050000

2005PA/E

porta attrezzi vuoto in Nylon, con cintura

- Due ampie tasche con elastici portautensili
- Due taschine frontali porta forbice
- Due pratici scomparti laterali con:
 - a sinistra taschino con robusto gancio in metallo per flessometro
 - a destra doppia tasca con sacca richiudibile tramite laccio e chiusura a zip aggiuntiva
- Fibbia con moschettone porta nastro adesivo
- Cintura regolabile da 70 a 120 cm

Dimensioni: 260x250x190 mm



2005PA/E

1 020050030

2005PA/S

porta attrezzi vuoto in Nylon, con cintura



2005PA/S

1 020050020

2009N/BV

borsa per manutentori in cuoio



2009N/BV

530x220x190 mm

1 020090200

2009ID

borsa con assortimento di 35 utensili per idraulica



2009ID

(2009N/BV+5980ID)

1 020091013

2028/VV

valigia portautensili in polipropilene

- 2 pannelli portautensili
- Fondo interno con divisori removibili
- Doppia chiusura con combinazione



2028/VV

480x190x400 mm

1 020280010

2028E

valigia con assortimento di utensili per elettronica ed elettrotecnica



2028EL/A

(2028/VV+5980EL/A)

2028ET/A

(2028/VV+5980ET/A)

1 020281014

1 020281018

2029/VV

valigia portautensili in polipropilene ad alto spessore, profilata in alluminio.

2 pannelli portautensili
Fondo con divisori rimovibili e regolabili
Fornita di tracolla
2 serrature con chiave



2029/VV 1 020290000

480x227x408 mm

2029E

valigie con assortimenti di utensili per elettronica ed elettrotecnica



2029 BG MQ 1 020291257

(2029/VV+5980MQ)

2029ET/B 1 020291021

(2029/VV+5980ET/B)

2029EL/B 1 020291017

(2029/VV+5980EL/B)

2032/TV

trolley portautensili in materiale plastico

2 pannelli portautensili
Tasca portautensili interna
Fondo interno con divisori rimovibili



2032/TV 1 020320110

450x200x400 mm

2032/TE

trolley con assortimento di utensili per elettronica ed elettrotecnica



2032TET/A 1 020321328

(2032/TV+5980ET/A)

2032TEL/A 1 020321314

(2032/TV+5980EL/A)

2033L/VV

valigia portautensili in alluminio, vuota

- Estremamente resistente agli urti
- Finitura antigraffio
- Maniglia ergonomica con grip in gomma
- Doppia chiusura con combinazione

- 2 pannelli portautensili con elastici
- Fondo interno con divisori rimovibili



2033L/VV 1 020330250

470x203x373 mm

2033L

valigie in alluminio con assortimenti di utensili per elettronica ed elettrotecnica



2033LEL/A 1 020331224

(2033L/VV+5980EL/A)

2033LEL/B 1 020331225

(2033L/VV+5980EL/B)

2033LET/B 1 020331237

(2033L/VV+5980ET/B)

2036/TV

trolley portautensili in polipropilene ad alto spessore, profilato in alluminio

2 pannelli portautensili
Manico telescopico
Ruote con cuscinetti a sfera
Fondo interno con divisori rimovibili



2036/TV 1 020360000

480x267x408 mm

2036E

trolley con assortimenti di utensili per elettronica ed elettrotecnica



2036TET/B 1 020361223

(2036/TV+5980ET/B)

2036EL/B 1 020361218

(2036/TV+5980EL/B)

2037/TV

trolley portautensili in polipropilene ad alto spessore con 4 ruote pivotanti

Estremamente resistente agli urti. Indicato per il trasporto di utensili in aereo.

2 pannelli portautensili rimovibili.

Tasca portadocumenti integrata.

4 ruote pivotanti rimovibili che consentono la movimentazione orizzontale del trolley.

2 vaschette portaminuteria incluse

2 serrature omologate TSA con chiave

Maniglia ergonomica rivestita in gomma



2037/TV 1 020370000

482x295x478 mm

2038/TV

trolley portautensili in polipropilene ad alto spessore

- Estremamente resistente agli urti.
- Profilo di tenuta in alluminio
- 2 serrature omologate TSA con chiave
- 2 pannelli portautensili rimovibili.
- Maniglione telescopico e grandi ruote con cuscinetti a sfera
- 2 maniglie (1 laterale) ergonomiche rivestite in gomma
- Fondo capiente
- Tasca porta documenti
- 3 cassettini porta minuteria



2038/TV

1 020380000

430x375x525 mm

2041UC

valigia Utility Case con assortimento di 33 utensili



2041UC

1 020410215

- 55 6x7 - 8x9 - 10x11 - 12x13 - 14x15 - 16x17 mm
- 96/SC9 1,5 - 2 - 2,5 - 3 - 4 - 5 - 6 - 8 - 10 mm
- 111 200 mm
- 1048V 250 mm
- 1128BMX 145 mm
- 1150 180 mm
- 1201E 2,5x50 - 3x75 - 4x100 - 5,5x100 - 6,5x150 mm
- 1202E PH0x60 - PH1x80 - PH2x100 mm
- 1370 300 g
- 1692 3m
- 1771 170 mm
- 1833S 70 Lumen / 140 mm
- 1639NS-N 25m
- 1696 200 mm

535x282x87 mm - 4,5 Kg

2051N

valigia in polipropilene antiurto con assortimento di 55 utensili per nautica



2051N

1 020510215

- 42 7 - 8 - 10 - 12 - 13 - 14 - 17 - 19 mm
- 55AS 3/8x7/16 - 1/2x9/16 - 5/8x11/16"
- 956C □1/2 - 16 - 20,8 mm
- 1048 250 mm
- 1084BM 160 mm
- 1128BMX 145 mm
- 1150BM 180 mm
- 1166BM 160 mm
- 1201E ●3x75 - 4x100 - 5,5x150 - 6,5x150 mm
- 1202E ●PH1x80 - PH2x100 mm
- 1390 Ø 35 mm
- 1490/2 ø max 240 mm
- 96/SC9 ○1,5÷10 mm
- 1737 145 mm
- 1778X
- BMN1436 3,6 x 140 mm
- BMESB1925NE 25 m
- 111 200 mm
- 920A ○ 10 - 12 - 13 - 14 - 17 - 19 mm
- 920AS ○ 7/16 - 1/2 - 9/16 - 11/16 - 7/8"
- 920/22 255 mm - □1/2 - ■1/2
- 920/25 □1/2 - ■1/2
- 920/42 ■1/2
- 920/55 ■1/2

585x393x92 mm - 9 kg

2055HB

valigia Home Bag con assortimento di 24 utensili



2055HB

1 020550215

- 55 6x7 - 8x9 - 10x11 - 12x13 mm
- 96N/SC9 1,5 - 2 - 2,5 - 3 - 4 - 5 - 6 - 8 - 10 mm
- 1128BMX 145 mm
- 1150 180 mm
- 1048V 250 mm
- 1201E 3x75 - 4x100 - 5,5x100 mm
- 1202E PH0x60 - PH1x80 - PH2x100 mm
- 1370 300 g
- 1692 3m

373x275x70 mm - 3 Kg

2080/V6

valigia organizer con 6 vaschette asportabili e divisori regolabili



2080/V6 385x320x60 mm

1 020800060

2080/V6-U

vaschetta asportabile per valigia organizer 2080/V6



2080/V6-U

1 020800066

90x60x50 mm

 **Beta**

2080/D10

set 10 divisori regolabili per valigia organizer
2080/V6



2080/D10

1 020800070

2080/V12

valigia organizer con 12 vaschette asportabili



2080/V12 300x145x330 mm

1 020800000

2080/V12-...

vaschetta asportabile per valigia organizer
2080/V12



2080/V12-S

3 020800013

95x75x65 mm

2080/V12-M

2 020800015

145x75x65 mm

2080/V12-L

1 020800020

295x75x65 mm

C3

mini borsa portautensili in tessuto tecnico

Caratteristiche principali:

- 1 tasca esterna frontale con chiusura a zip
- 2 tasche laterali con vaschette portaminuteria incluse
- 1 pratica tasca posteriore con chiusura a velcro
- 1 pannello portautensili interno removibile, con elastici presenti su ambo i lati
- Interfaccia USB per la ricarica dei propri dispositivi mobili
- Fornita completa di tracolla



C3

1 021030000

230x110x320 mm - 890 g

C4 - 2104

secchiello portautensili in tessuto tecnico, vuoto

Pannello portautensili interno estraibile

Tasche ed elastici portautensili sia esterni che interni

Base rigida impermeabile con piedini in gomma

Fornito di tracolla



C4

1 021040000

2104VU/0

1 021041122

(C4+5915VU/0)

330x260x360 mm - 2,5 kg

C5S

zaino portautensili in poliestere resistente

- Doppia maniglia sulla sommità centrale dello zaino per una presa sicura e bilanciata
- Due ampie tasche frontali
- Due capienti tasche interne e 2 fasce aggiuntive con velcro
- Pratica busta avvolgibile interna, composta da 4 pannelli portautensili
- Spallacci imbottiti rinforzati e regolabili
- Carico massimo 15 Kg



C5S

1 021050100

310x120x390 mm - 0,9 Kg

C5 - 2105

zaino portautensili in tessuto tecnico

- Pannello portautensili interno removibile
- Sei tasche esterne
- Due capienti tasche interne
- Base in materiale plastico resistente all'acqua
- Doppio laccetto di sicurezza per fissare lo zaino sulle spalle
- Schienale ergonomico imbottito



C5

1 021050000

2105VU/0

1 021051122

(C5+5915VU/0)

400x200x500 mm - 2,5 Kg

C6T - 2106

zaino portautensili in tessuto tecnico, con ruote

- Manico telescopico di trasporto
- Ruote integrate nella struttura con copertura anti-polvere per l'impiego come zaino
- Due pannelli portautensili removibili
- Cinque tasche esterne
- Capiente tasca per pc interna
- Base in materiale resistente all'acqua



C6T 1 021060010
2106T/VU0 1 021061123
(C6T+5915VU/0)

360x200x480 mm - 4,5 kg

C7 - 2107

borsa portautensili in tessuto tecnico

- 2 pannelli interni portautensili removibili
- 2 tasche esterne frontali
- Fondo interno in materiale plastico con divisori removibili



C7 1 021070000
2107VU/2 1 021071112
(C7+5915VU/2)

2107VU/3 1 021071114
(C7+5915VU/3)

480x165x380 mm - 3,5 kg

C8 - 2108

trolley portautensili in tessuto tecnico

- Manico telescopico di trasporto
- 2 pannelli interni portautensili removibili
- Tasca porta PC interna
- 2 tasche esterne frontali
- Predisposizione per l'alloggiamento del cestello C10S



C8 1 021080000
2108VU/1 1 021081022
(C8+5915VU/1)

470x280x380 mm - 4 kg

C8B

trolley portautensili in tessuto tecnico per elettricisti

- Struttura rigida
- Manico telescopico di trasporto
- 4 ruote piroettanti
- 1 pannello interno portautensili removibile
- Tasca frontale con porta badge
- Doppio fondo con portaminuteria compreso
- 2 tasche esterne laterali
- 2 ganci porta sonda tirafili
- Manico inclinabile per facilitare l'accesso agli utensili
- Possibilità di chiusura con lucchetto (non compreso)



C8B 1 021080300

380x250x430 mm - 4,7 kg

C9 - 2109

borsa portautensili in tessuto tecnico

- Base rigida
- Tasche interne ed esterne per l'inserimento di utensili
- Tasca esterna con chiusura a zip per maggior sicurezza
- Tasca chiudibile con strappo per oggetti personali
- Doppio fondo
- Doppio laccio per livello
- Tracolla per facilitare il trasporto



C9 1 021090000
2109VU/1 1 021091022
(C9+5915VU/1)
2109VU/3 1 021091024
(C9+5915VU/3)

550x280x320 mm - 2,6 kg

C9/RT

tracolla per C4,C7,C9,C10,C10S,C11, C12 e 2001/BZV



C9/RT 1 021090900

C10 - 2110

cestello portautensili in tessuto tecnico

- Struttura rigida
- Doppio fondo. Il fondo si può rimuovere per aumentare la capienza della borsa
- Manico inclinabile per facilitare l'accesso agli utensili
- Elastici portautensili e tasche sia interne che esterne
- Fodero di copertura
- Vaschetta portaminuterie inclusa nel doppio fondo



C10 1 021100000
2110VU/1 1 021101031
(C10+5915VU/1)
2110VU/3 1 021101034
(C10+5915VU/3)
2110VU/AS 1 021101036
(C10+5915VU/AS)

520x220x250 mm - 3,3 kg

C10S - 2110S

cestello portautensili in tessuto tecnico

Struttura rigida

Manico inclinabile per facilitare l'accesso agli utensili

Elastici portautensili e tasche sia interne che esterne

Fodero di copertura

Vaschetta portaminuterie inclusa nel doppio fondo



C10S	1	021100001
2110SVU/1 (C10S+5915VU/1)	1	021101041
2110SVU/3 (C10S+5915VU/3)	1	021101044

≡ 420x220x250 mm - 📦 2,3 kg

C11 - 2111

cestello portautensili in tessuto tecnico

• Base rigida in materiale plastico resistente all'acqua

• Elastici e tasche portautensili sia interne che esterne

• Buste portadocumenti integrate nel doppiofondo del coperchio



C11	1	021110000
2111VU/1 (C11+5915VU/1)	1	021111031
2111VU/3 (C11+5915VU/3)	1	021111034

≡ 410x230x250 mm - 📦 2 kg



C12 - 2112

borsa portautensili in tessuto tecnico

Pannello interno portautensili estraibile

Elastici portautensili e capienti tasche sia interne che esterne

La borsa si apre anteriormente per facilitare l'accesso agli utensili sul luogo di lavoro

Base rigida impermeabile con piedini in gomma



C12	1	021120000
2112ET/A (C12+5980ET/A)	1	021121028
2112ET/B (C12+5980ET/B)	1	021121029
2112VU/5 (C12+5915VU/5)	1	021121056

≡ 500x270x350 mm - 📦 5 kg

C13

baule portautensili con ruote, in polipropilene ad alta resistenza

• Idoneo per uso esterno

• Resistente agli urti e agli agenti chimici

• Predisposizione per chiusura con lucchetto (non compreso)

• Dotato di due chiusure

• Due ruote che consentono la movimentazione orizzontale del baule

• Provvisto all'interno di una vaschetta porta minuteria rimovibile e bloccabile all'interno su due posizioni

• Targhetta identificativa portanome



C13	1	021130000
-----	---	-----------

≡ 806x350x467 mm - 📦 7,2 kg

C14

trolley portautensili in polipropilene con 4 cassetti

• Struttura in polipropilene a iniezione che garantisce elevata resistenza agli urti.

• La parte anteriore, protetta dal coperchio frontale, ospita 4 cassetti 470x255 mm estraibili:

1 cassetto altezza 30 mm

2 cassetti altezza 60 mm

1 cassetto altezza 90 mm

• Serratura centralizzata frontale consente di chiudere contemporaneamente i due coperchi, quello superiore e quello frontale.

• Due maniglie laterali

• 4 robuste ruote posteriori

• Vassoio superiore removibile

• Pannello portautensili integrato nel coperchio

• 3 vaschette porta minuteria incluse

• Targhetta identificativa portanome

• Predisposizione per la chiusura con lucchetto TSA



C14	1	021140000
2114VU/M (C14+5914VU/M)	1	021141011

≡ 585x390x457 mm - 📦 10 kg

CP15 - 2115

cestello in materiale plastico con contenitore e vaschette portaminuterie asportabili

• 1 vaschetta portaminuterie integrata nel coperchio

• 2 vaschette portaminuterie asportabili con divisori regolabili

• 1 contenitore interno con divisori regolabili



CP15	1	021150201
2115PVU/1 (CP15+5915VU/1)	1	021151232
2115PVU/2 (CP15+5915VU/2)	1	021151234

≡ 445x240x250 mm - 📦 2 kg



CP15L - 2115

cestello modello lungo in materiale plastico con contenitore e vaschette portaminuterie

- 3 vaschette portaminuterie integrate nel coperchio con divisori regolabili
- 1 contenitore interno con divisori regolabili



CP15L	1	021150202
2115PL-VU/1 (CP15L+5915VU/1)	1	021151242
2115PL-VU/3 (CP15L+5915VU/3)	1	021151245

558x277x270 mm - 2,5 kg

2115PI/BIKE-HOME

assortimento di 28 utensili per manutenzione biciclette e E-Bike, in cestello in materiale plastico



2115PI/BIKE-HOME	1	021150098
------------------	---	-----------

- 96BP/SC9
- 3935
- 3969K3
- 42 8-9-10-13-14 mm
- 42SLIM 15 mm
- 1082G 160 mm
- 1150G 180 mm
- 1201E 3x75 - 5,5x150 mm
- 1202E PH0x60 - PH2x100 mm
- 3991
- BMESB1925NE 25 m
- BMN1436 3,6 x 140 mm

558x277x270 mm - 4,3 kg



2115P L-MQ32

assortimento di 32 utensili isolati per auto ibride, in cestello plastico con termoformato morbido



2115PL-MQ32	1	021150332
-------------	---	-----------

- 920MQ/55A
- 89MQ 10-12 mm
- 850MQ 1/4"
- 860TX/A10 T7-T8-T9-T10-T15-T20-T25-T27-T30-T40
- 920MQ/A 8-10-12-13-14-17-19 mm
- 920MQ/21 125mm
- 920MQ/22 250mm
- 1048MQ250 250mm
- 1150MQ 180mm
- 1164MQ160 160mm
- 1272MQ 4.5X80-6X100mm
- 1274MQ 3X100-4X100-5.5X125
- 1995MQ/G2 G2
- CP15L

C16 - 2116

cestello in materiale plastico con vano portaoggetti interno



C16	1	021160000
2116VU/1 (C16+5915VU/1)	1	021161102
2116VU/3 (C16+5915VU/3)	1	021161105

500x260x260 mm - 2,5 kg

CP17 - CP17L - 2117

cestello in acciaio inox e materiale plastico con contenitore asportabile



CP17
 500x200x220 mm



CP17L
 575x245x265 mm

CP17	1	021170500
2117P-VU/1 (CP17+5915VU/1)	1	021171042
2117P-VU/3 (CP17+5915VU/3)	1	021171045
CP17L	1	021170502
2117L-VU/1 (CP17L+5915VU/1)	1	021171142
2117PL-VU/3 (CP17L+5915VU/3)	1	021171145

C18 - 2118

cestello semplice in lamiera



C18	1	021180001
2118VU/1 (C18+5915VU/1)	1	021181032

450x200x100 mm - 3 kg



C19 - 2119 - C19L - 2119L

cestello estendibile
a tre scomparti
in lamiera



C19

450x200x160 mm

C19L

550x200x160 mm

C19	1	021190001
2119VU/3 (C19+5915VU/3)	1	021191025
C19L	1	021190002
2119L-VU/3 (C19L+5915VU/3)	1	021191125

C20 - C20L - 2120

cestello estendibile
a cinque scomparti
in lamiera



C20

450x200x210 mm

C20L

550x200x210 mm

C20	1	021200001
2120VU/2 (C20+5915VU/2)	1	021201061
2120VU/3 (C20+5915VU/3)	1	021201063
2120VU/4 (C20+5915VU/4)	1	021201064
2120VU/AS (C20+5915VU/AS)	1	021201068
C20L	1	021200002
2120L-VU/2 (C20L+5915VU/2)	1	021201161
2120L-VU/3 (C20L+5915VU/3)	1	021201163
2120L-VU/4 (C20L+5915VU/4)	1	021201164
2120L-VU/AS (C20L+5915VU/AS)	1	021201168

C20TSS

cestello estendibile a cinque scomparti
in acciaio inossidabile AISI 304



C20TSS

450x200x210 mm - 4kg

1	021203001
---	-----------

C22B

baule portautensili in lamiera



C22B O

720x320x310 mm

C22BM O

850x360x350 mm

C22BL O

1010x410x400 mm

C22B-O	1	022000150
C22BM-O	1	022000160
C22BL-O	1	022000170

C22B O: 13 kg
C22BM O: 20 kg
C22BL O: 26 kg

C22W

baule portautensili in lamiera, rivestito
internamente per una maggiore protezione
degli utensili



C22W-O

690x300x360 mm

C22WL-O

990x300x360 mm

C22W-O	1	022000269
C22WL-O	1	022000299

C22W O: 15 kg
C22WL O: 28 kg

C22P

baule portautensili da cantiere, in lamiera

maniglie incassate a scomparsa
pattini rialzati per il sollevamento con muletto
doppia chiusura anti-effrazione per lucchetto (non incluso)



C22PM O

915x540x430 mm

C22PL O

1220x720x615 mm

C22PM-O	1	022000240
C22PL-O	1	022000245

C22PM O: 39 kg
C22PL O: 67 kg



C99

Combo è il sistema modulare Beta

composto da **3 diverse tipologie di robuste valigette** portautensili per riporre in maniera ordinata e in totale sicurezza la vostra attrezzatura da lavoro.

Le valigette possono essere facilmente unite tra di loro con un **semplice click**, grazie alle pratiche chiusure laterali a scatto.

Il sistema Beta Combo C99 è compatibile con lo standard L-BOXX di Sortimo®

C99

sistema modulare completo COMBO

Le valigette porta attrezzi possono essere facilmente unite tra di loro con un semplice clic, grazie alle pratiche chiusure laterali a scatto.

Composto da:

- Carrello ultracompatto richiudibile con manico telescopico **C99P** (485x520x1095 mm)
- Valigetta portautensili in ABS **C99V1** (445x358x152 mm)
- Valigetta portautensili in ABS **C99V2** (445x358x254 mm)
- Valigetta portautensili in ABS con 2 cassette portaminuteria trasportabili **C99V3/2C** (445x358x322 mm)



C99



1

099000010

C99V0

valigetta portautensili COMBO in ABS, con coperchio trasparente

Le valigette porta attrezzi possono essere facilmente unite tra di loro con un semplice clic, grazie alle pratiche chiusure laterali a scatto.

Caratteristiche principali:

- Coperchio trasparente in robusto policarbonato per una rapida individuazione del contenuto
- Dimensioni esterne 445x358x118 mm
- Capacità di carico max interna 25 Kg
- Predisposizione per la chiusura con lucchetto
- Peso 2,5 Kg

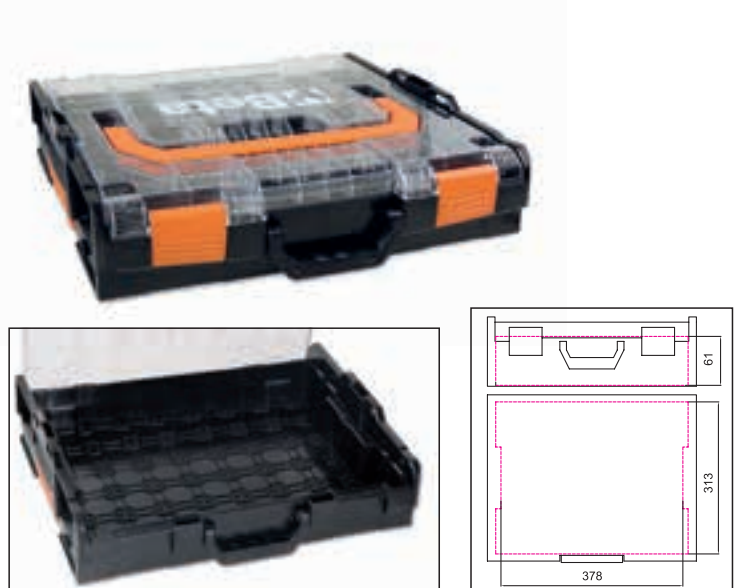

C99V0



1

099000202

C99V0-P12

valigetta portautensili COMBO in ABS, con coperchio trasparente

Le valigette porta attrezzi possono essere facilmente unite tra di loro con un semplice clic, grazie alle pratiche chiusure laterali a scatto.

Caratteristiche principali:

- Coperchio trasparente in robusto policarbonato per una rapida individuazione del contenuto
- Particolarmente indicata per il trasporto di minuteria come viti, dadi, rondelle, rivetti o tasselli
- Fornita completa di kit 18 vaschette portaminuteria:
 - 2 vaschette rosse 52x52 mm
 - 3 vaschette gialle 104x52 mm
 - 2 vaschette blu 104x104 mm
 - 1 vaschetta verde 104x156 mm
 - 2 vaschette arancioni 208x52 mm
 - 2 vaschette grigie 312x71 mm e 6 divisori regolabili
- Dimensioni esterne 445x358x118 mm
- Capacità di carico max interna 25 Kg
- Predisposizione per la chiusura con lucchetto
- Peso 3,2 Kg

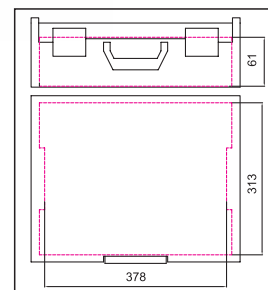

C99V0-P12



1



099000200

C99P12-V0

kit 18 vaschette portaminuteria per valigette portautensili C99V0

Composizione:

- 2 vaschette rosse 52x52 mm
- 3 vaschette gialle 104x52 mm
- 2 vaschette blu 104x104 mm
- 1 vaschetta verde 104x156 mm
- 2 vaschette arancioni 208x52 mm
- 2 vaschette grigie 312x71 mm e 6 divisori regolabili



C99P12-V0



1



099000499



C99V1

valigetta portautensili COMBO in ABS

Le valigette porta attrezzi possono essere facilmente unite tra di loro con un semplice clic, grazie alle pratiche chiusure laterali a scatto.

Caratteristiche principali:

- Dimensioni esterne 445x358x152 mm
- Capacità di carico max interna 25 Kg
- Predisposizione per la chiusura con lucchetto
- Peso 2,2 Kg

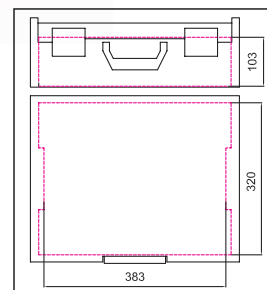

C99V1



099000250

C99V2

valigetta portautensili COMBO in ABS

Le valigette porta attrezzi possono essere facilmente unite tra di loro con un semplice clic, grazie alle pratiche chiusure laterali a scatto.

Caratteristiche principali:

- Dimensioni esterne 445x358x254 mm
- Capacità di carico max. interna 25 Kg
- Peso 2,8 Kg

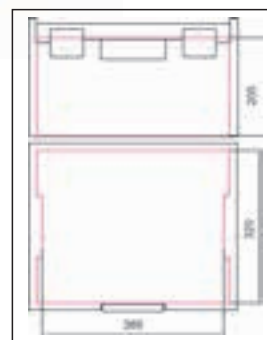

C99V2



099000350



C99V3/2C

valigetta portautensili COMBO in ABS con 2 cassette portaminuteria trasportabili

Le valigette porta attrezzi possono essere facilmente unite tra di loro con un semplice clic, grazie alle pratiche chiusure laterali a scatto.

Caratteristiche principali:

- Dimensioni esterne 445x358x322 mm
- Capacità di carico max. interna 25 Kg
- Fornita con 2 cassette portaminuteria C99C-V3 vuote
- Peso 5,6 Kg

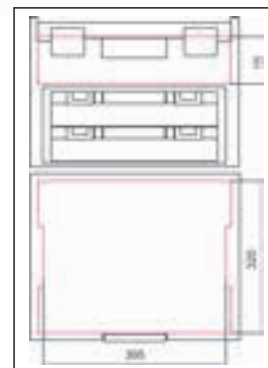

C99V3/2C



1 099000450

C99C-V3

cassetta portautensili COMBO trasportabile

Coperchio trasparente per una rapida individuazione del contenuto

Maniglia integrata

Dimensioni esterne: 367x316x72 mm

Peso 0,9 Kg

Accessoriabile con:

- termoformato portaminuteria a 7 vani C99T-V3
- kit 17 vaschette portaminuteria C99P-V3

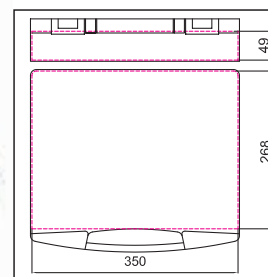

C99C-V3



1 099000496

C99P

carrello pieghevole COMBO

Caratteristiche principali:

- Carrello ultracompatto richiudibile
- Impugnatura con manico telescopico
- Dimensioni aperto: 485x520x1095 mm
- Dimensioni chiuso: 485x80x810 mm
- Dimensioni base ribaltabile 485x350 mm
- Due ruote antiforatura Ø 175 mm
- Cinghia inclusa nella confezione
- Portata massima 100 kg.
- Peso 5,8 kg



C99P



1 099000101

C99PC

rivestimento interno per coperchio valigette C99V1 e C99V3/2C

Indispensabile in abbinamento ai termoformati per evitare che il contenuto fuoriesca dai vani o si mischi durante il trasporto.



C99PC

1 099000491

C99T

termoformato portaminuteria a 4 vani per valigette C99V1 e C99V3/2C



C99T

1 099000492

C99M

inserto soft precubettato per valigette COMBO C99V1, C99V2 e C99V3/2C

Facile da sagomare per creare alloggiamenti sicuri e su misura per qualsiasi tipo di utensile da contenere

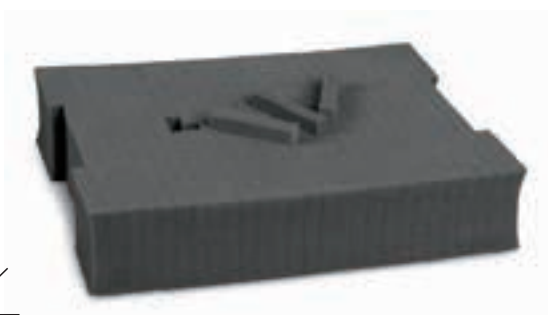

C99M

1 099000494

C99T-V3

termoformato portaminuteria a 7 vani per cassette portautensili C99C-V3



C99T-V3

1 099000497

C99P-V3

kit 17 vaschette portaminuteria per cassette portautensili C99C-V3

Composizione:

- 6 vaschette rosse 52x52 mm
- 2 vaschette gialle 104x52 mm
- 3 vaschette grigie 260x78 mm e 6 divisori regolabili



C99P-V3

1 099000498

C99PP

pannello portautensili per valigette COMBO

- dotato di 6 tasche e 11 elastici portautensili
- fornito completo di ganci per il fissaggio del pannello all'interno del coperchio della valigetta



376 mm

306 mm

C99PP

1 099000489



L'EVOLUZIONE DELLA PERFEZIONE

RSC22

cassettiera portatile
con 3 cassetti

Caratteristiche principali:

- 3 cassetti da 588x277 mm,
- montati su guide telescopiche a sfera:
- 1 cassetto altezza 50 mm
- 2 cassetti altezza 70 mm.
- Serratura centralizzata frontale.
- Maniglie laterali a scomparsa per il trasporto.

19 kg



RSC22-O



RSC22-A



RSC22-R



h	max
50 mm	25 kg
70 mm	25 kg

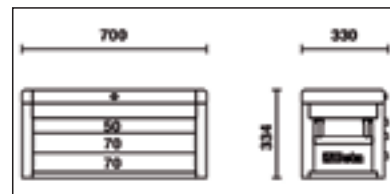
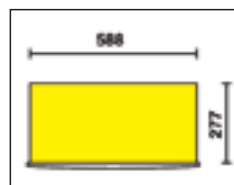

RSC22-O	RAL 2011	1	022003001
RSC22-R	RAL 3000	1	022003003
RSC22-A	RAL 7016	1	022003007

RSC23

cassettiera portatile
con 5 cassetti

Caratteristiche principali:

- 5 cassetti da 588x277 mm, montati su guide telescopiche a sfera;
- 2 cassetti altezza 50 mm
- 3 cassetti altezza 70 mm.
- Serratura centralizzata frontale.
- Maniglie laterali a scomparsa per il trasporto.

📦 26 kg



RSC23-A



RSC23-R



RSC23-O



h	max
50 mm	25 kg
70 mm	25 kg

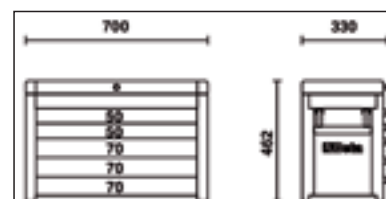
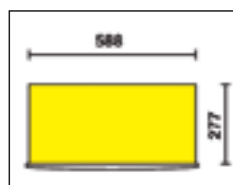

Model	RAL	Weight	Code
RSC23-O	RAL 2011	1	023003001
RSC23-R	RAL 3000	1	023003003
RSC23-A	RAL 7016	1	023003007

CD23S

carrello Caddy

Caratteristiche principali:

- Piano di lavoro ricoperto in ABS sul quale sono collocabili a misura le cassettiere RSC22, RSC23, RSC23C, RSC23T
- Timone di guida smontabile, collocabile sotto il piano.
- Quattro ruote Ø 100 mm: 2 fisse e 2 girevoli (una con freno).
- Portata massima 250 kg.

📦 14 kg



Model	Weight	Code
CD23S	1	023000610

RSC23C

cassettiera portatile
con 8 cassetti

Caratteristiche principali:

- 8 cassetti da 588x277 mm, montati su guide telescopiche a sfera:
- 4 cassetti altezza 50 mm
- 3 cassetti altezza 70 mm
- 1 cassetto altezza 100 mm.
- Serratura centralizzata frontale.
- Maniglie laterali a scomparsa per il trasporto.

📦 28 kg



RSC23C-A



RSC23C-R



RSC23C-O



h	max
50 mm	25 kg
70 mm	25 kg

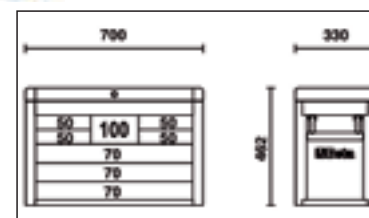
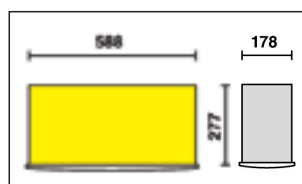

Model	RAL	Weight	Code
RSC23C-O	RAL 2011	1	023003011
RSC23C-R	RAL 3000	1	023003013
RSC23C-A	RAL 7016	1	023003017

RSC23T

cassettiera portatile
con 5 cassetti

Caratteristiche principali:

- 5 cassetti da 588x367 mm, montati su guide telescopiche a sfera:
- 5 cassetti altezza 70 mm
- Serratura centralizzata frontale.
- Possibilità di applicazione del kit 4 ruote più maniglione (2300ST/KIT)

📦 36 kg

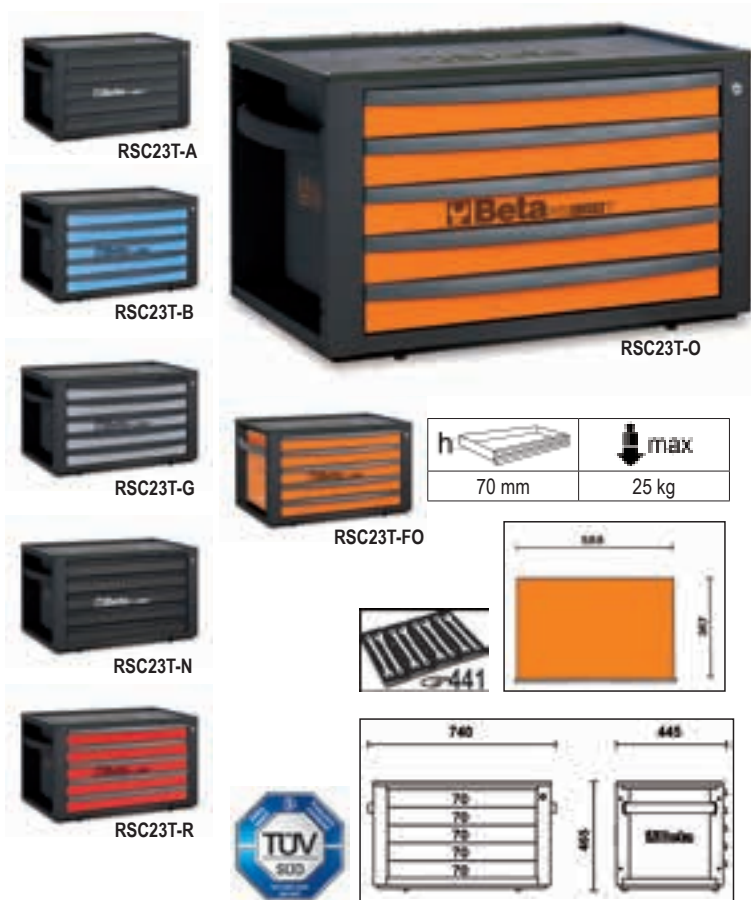

RSC23T-FO	RAL 2011	1	023003020
RSC23T-O	RAL 2011	1	023003021
RSC23T-G	RAL 9006	1	023003022
RSC23T-R	RAL 3000	1	023003023
RSC23T-B	RAL 5015	1	023003026
RSC23T-A	RAL 7016	1	023003027
RSC23T-N	RAL 9005	1	023003029

2300ST/KIT

kit con quattro ruote e maniglione per RSC23T

- Quattro ruote Ø 125 mm:
- 2 fisse e 2 girevoli (una con freno).
- Maniglione telescopico

📦 6,5 kg

2300ST/KIT	1	023000950
------------	---	-----------



Beta
RSC24

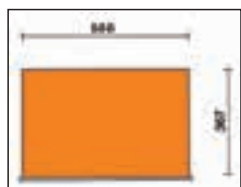

Colori disponibili:

RSC24-		
FO	RAL 2011	RAL 2011
O	RAL 7016	RAL 2011
G	RAL 7016	RAL 9006
R	RAL 7016	RAL 3000
B	RAL 7016	RAL 5015
A	RAL 7016	RAL 7016
N	RAL 9005	RAL 9005

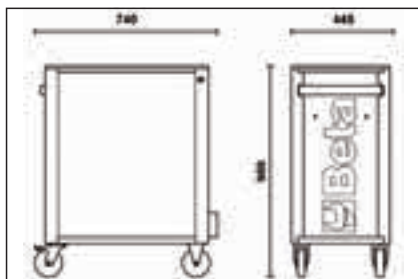

PIANO DI LAVORO

- + **SOLIDO E ROBUSTO**
- + **PRATICO E FUNZIONALE**
- + **MODERNO**



- Cassetti montati su guide telescopiche a sfera
- Piano dei cassetti protetto da tappetini di gomma espansa
- Possibilità di inserire in ogni cassetto fino a 4 vassoi morbidi in EVA o termoformati rigidi in ABS
- Nuovo piano di lavoro rinforzato in ABS, sul quale è collocabile a misura una cassetteria portatile RSC22, RSC23, RSC23C e RSC23T
- Piano di appoggio multifunzione con bordi anticaduta e otto fori per l'alloggiamento dei giravite
- Serratura di sicurezza centralizzata frontale
- Quattro ruote Ø 125 mm: 2 fisse e 2 girevoli (una con freno)
- Capacità di carico statico: 800 kg
- Porta flaconi laterale integrato, applicabile su entrambi i lati

Modelli disponibili:

- RSC24/5 (5 cassetti)
- RSC24/6 (6 cassetti)
- RSC24/7 (7 cassetti)
- RSC24/8 (8 cassetti)

Accessori disponibili:

2400 RSC24/PF

2400 RSC24/SPC

2400 RSC24/PL

2400 RSC24/PF-A
2400 RSC24/PF-N

2400 RSC24/PD-A
2400 RSC24/PD-N

2400 RSC24/MP

2400 RSC24/PC-A
2400 RSC24/PC-N

RSC24/7

cassetteria mobile con 7 cassetti

Caratteristiche principali:

- 7 cassetti da 588x367 mm ad estrazione totale, montati su guide telescopiche a sfera:
- 5 cassetti altezza 70 mm
- 1 cassetto altezza 140 mm
- 1 cassetto altezza 210 mm

63 kg

Modello	Q.tà	Articolo
RSC24/7-FO	1	024004070
RSC24/7-O	1	024004071
RSC24/7-G	1	024004072
RSC24/7-R	1	024004073
RSC24/7-B	1	024004076
RSC24/7-A	1	024004077
RSC24/7-N	1	024004079



RSC24/7-O

Beta
RSC24



h	max
70 mm	25 kg
140 mm	30 kg
210 mm	30 kg

RSC24/5

cassettiera mobile con 5 cassetti

Caratteristiche principali:

- 5 cassetti da 588x367 mm ad estrazione totale, montati su guide telescopiche a sfera:
- 2 cassetti altezza 70 mm
- 2 cassetti altezza 140 mm
- 1 cassetto altezza 280 mm

60 kg

RSC24/5-FO	1	024004050
RSC24/5-O	1	024004051
RSC24/5-G	1	024004052
RSC24/5-R	1	024004053
RSC24/5-B	1	024004056
RSC24/5-A	1	024004057
RSC24/5-N	1	024004059



RSC24/5-O

Beta RSC24



h	max
70 mm	25 kg
140 mm	30 kg
280 mm	35 kg

RSC24/6

cassettiera mobile con 6 cassetti

Caratteristiche principali:

- 6 cassetti da 588x367 mm ad estrazione totale, montati su guide telescopiche a sfera:
- 4 cassetti altezza 70 mm
- 1 cassetto altezza 140 mm
- 1 cassetto altezza 280 mm

62 kg

RSC24/6-FO	1	024004060
RSC24/6-O	1	024004061
RSC24/6-G	1	024004062
RSC24/6-R	1	024004063
RSC24/6-B	1	024004066
RSC24/6-A	1	024004067
RSC24/6-N	1	024004069



RSC24/6-O

Beta RSC24



h	max
70 mm	25 kg
140 mm	30 kg
280 mm	35 kg

RSC24/8

cassettiera mobile con 8 cassetti

Caratteristiche principali:

- 8 cassetti da 588x367 mm ad estrazione totale, montati su guide telescopiche a sfera:
- 6 cassetti altezza 70 mm
- 2 cassetti altezza 140 mm

66 kg

RSC24/8-FO	1	024004080
RSC24/8-O	1	024004081
RSC24/8-G	1	024004082
RSC24/8-R	1	024004083
RSC24/8-B	1	024004086
RSC24/8-A	1	024004087
RSC24/8-N	1	024004089



RSC24/8-O

Beta RSC24



h	max
70 mm	25 kg
140 mm	30 kg

RSC24A/6

cassettiera mobile con 6 cassetti,
con sistema antiribaltamento

Caratteristiche principali:

- 6 cassetti da 588x367 mm ad estrazione totale, montati su guide telescopiche a sfera:
- 4 cassetti altezza 70 mm
- 1 cassetto altezza 140 mm
- 1 cassetto altezza 280 mm

62 kg

RSC24A/6-O	1	024004161
RSC24A/6-R	1	024004163
RSC24A/6-A	1	024004167



Beta R5C24



RSC24A/6-A



RSC24A/6-R



h	max
70 mm	25 kg
140 mm	30 kg
280 mm	35 kg

RSC24A/7

cassettiera mobile con 7 cassetti,
con sistema antiribaltamento

Caratteristiche principali:

- 7 cassetti da 588x367 mm ad estrazione totale, montati su guide telescopiche a sfera:
- 5 cassetti altezza 70 mm
- 1 cassetto altezza 140 mm
- 1 cassetto altezza 210 mm

63 kg

RSC24A/7-O	1	024004171
RSC24A/7-R	1	024004173
RSC24A/7-A	1	024004177



Beta R5C24



RSC24A/7-A



RSC24A/7-R



h	max
70 mm	25 kg
140 mm	30 kg
210 mm	30 kg

RSC24A/8

cassettiera mobile con 8 cassetti,
con sistema antiribaltamento

Caratteristiche principali:

- 8 cassetti da 588x367 mm ad estrazione totale, montati su guide telescopiche a sfera:
- 6 cassetti altezza 70 mm
- 2 cassetti altezza 140 mm

66 kg

RSC24A/8-O	1	024004181
RSC24A/8-R	1	024004183
RSC24A/8-A	1	024004187



Beta R5C24



RSC24A/8-A



RSC24A/8-R



h	max
70 mm	25 kg
140 mm	30 kg

CASSETTIERA MOBILE RSC24AXL



VERSIONE LUNGA:
 può contenere fino a 6 vassoi morbidi in EVA
 o termoformati rigidi in ABS per cassetto

SISTEMA ANTIRIBALTAMENTO: NON CONSENTE L'APERTURA CONTEMPORANEA DI PIÙ CASSETTI



- Cassetti montati su guide telescopiche a sfera
- Nuovo piano di lavoro rinforzato in ABS con bordi anticaduta, otto fori per l'alloggiamento dei giravite e 6 vaschette portaminuterie.
- Frontalino in nylon ad alta resistenza con porta-etichette integrato
- Quattro ruote Ø 125 mm: 2 fisse e 2 girevoli (una con freno)
- Capacità di carico statico: 1.000 kg
- Piano dei cassetti protetto da tappetini di gomma espansa
- Portaflaconi laterale integrato
- Serratura di sicurezza centralizzata frontale

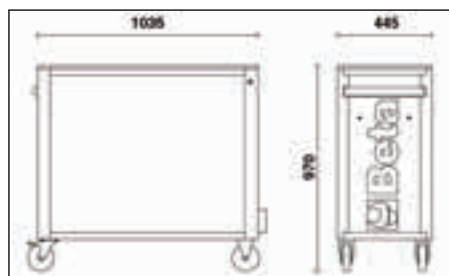

Colori disponibili:

O	RAL 7016	RAL 2011
R	RAL 7016	RAL 3000
A	RAL 7016	RAL 7016

Accessori disponibili:



RSC24AXL/7

cassettiera mobile con 7 cassetti,
 con sistema antiribaltamento,
 modello lungo

Caratteristiche principali:

- 7 cassetti da 882x367 mm ad estrazione totale, montati su guide telescopiche a sfera:
- 5 cassetti altezza 70 mm
- 1 cassetto altezza 140 mm
- 1 cassetto altezza 210 mm

84 kg



h	max
70 mm	30 kg
140 mm	35 kg
210 mm	35 kg

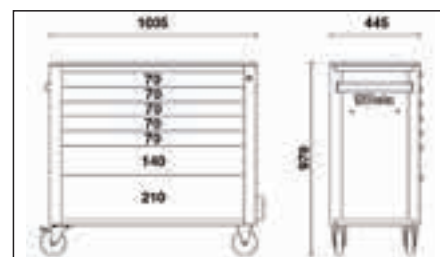
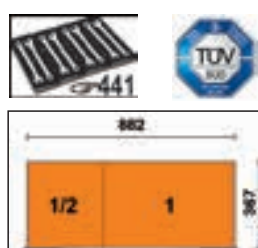

RSC24AXL/7-O	1	024004271
RSC24AXL/7-R	1	024004273
RSC24AXL/7-A	1	024004277

RSC24AXL/8

cassettiera mobile con 8 cassetti,
con sistema antiribaltamento,
modello lungo

Caratteristiche principali:

- 8 cassetti da 882x367 mm ad estrazione totale, montati su guide telescopiche a sfera:
- 6 cassetti altezza 70 mm
- 2 cassetto altezza 140 mm

88 kg

RSC24AXL/8-O	1	024004281
RSC24AXL/8-R	1	024004283
RSC24AXL/8-A	1	024004287

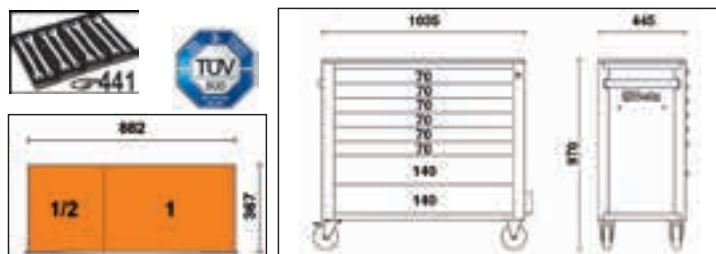

RSC24AXL/9

cassettiera mobile con 9 cassetti,
con sistema antiribaltamento,
modello lungo

Caratteristiche principali:

- 9 cassetti da 882x367 mm ad estrazione totale, montati su guide telescopiche a sfera:
- 8 cassetti altezza 70 mm
- 1 cassetto altezza 140 mm

90 kg

RSC24AXL/9-O	1	024004291
RSC24AXL/9-R	1	024004293
RSC24AXL/9-A	1	024004297

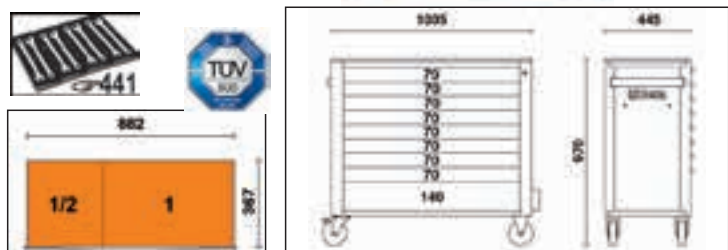

2400 RSC24/PC

portacarta per rotoli preforati per cassetteria RSC24

0,3 kg

2400 RSC24/PC-A	1	024004903
2400 RSC24/PC-N	1	024004904

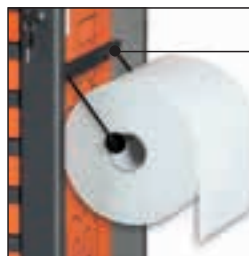

RAL7016 2400 RSC24/PC-A
RAL9005 2400 RSC24/PC-N



2400 RSC24/PD

portadocumenti per cassetteria RSC24

1,2 kg

2400 RSC24/PD-A	1	024004907
2400 RSC24/PD-N	1	024004908

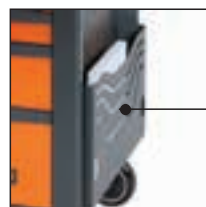

RAL7016 2400 RSC24/PD-A
RAL9005 2400 RSC24/PD-N



2400 RSC24/PF

pannello forato con supporti per cassetteria RSC24

2,3 kg

2400 RSC24/PF	1	024004902
---------------	---	-----------



2400 RSC24/PF-

portaflaconi per cassetteria RSC24

0,5 kg

2400 RSC24/PF-A	1	024004905
2400 RSC24/PF-N	1	024004906

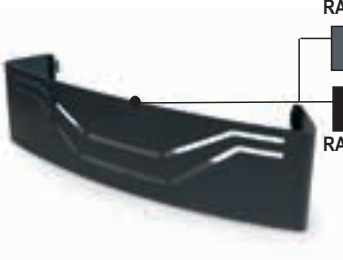

RAL7016 2400S RSC24/PF-A
RAL9005 2400S RSC24/PF-N



2400 RSC24/PL

piano di lavoro in legno per cassetteria RSC24

4,3 kg

2400 RSC24/PL	1	024004901
---------------	---	-----------



2400 RSC24/SPC

supporto porta computer per cassetteria RSC24

- Con cassetto estraibile
- Non abbinabile al modello RSC24AXL

3,1 kg

2400 RSC24/SPC	1	024004909
----------------	---	-----------



2400 RSC24/MP

mensola pieghevole per RSC24 - RSC24A - RSC51

- Utilizzabile come piano di lavoro supplementare
- Piano di lavoro mis. 390x440 mm, protetto con tappetino in gomma antiolio e antibenzina
- Capacità di carico: 20 kg

📦 3,4 kg



2400 RSC24/MP

1 024004900

2499PF

portaflaconi

- Abbinabile alle cassettiere serie C38

📦 2,5 kg

2499PF-O 1 024990210
2499PF-G 1 024990219
2499PF-R 1 024990230

2499PF O

2499PF G

2499PF R



2499PF/M

portaflaconi universale magnetico

📦 2,2 kg

2499PF/M 1 024990050



2499PC

portacarta per rotoli preforati

- Abbinabile a tutti i carrelli Tank C25 e alle cassettiere serie C38.

📦 2,2 kg

2499PC 1 024990090



RSC24L/7

cassettiera mobile
con 7 cassetti
e ripiani laterali

Caratteristiche principali:

- 7 cassetti da 588x367 mm, montati su guide telescopiche a sfera: 5 cassetti altezza 70 mm 1 cassetto altezza 140 mm 1 cassetto altezza 210 mm.
- Piano dei cassetti protetto da tappetini di gomma espansa.
- Quattro ruote Ø 125 mm: 2 fisse e 2 girevoli con freno.
- Serratura centralizzata frontale.
- Capacità di carico statico: 1.100 kg.
- Piano di lavoro in legno multistrato con fori per la collocazione di una morsa (1599F/100 da ordinare separatamente).
- Vano laterale con ripiano regolabile in altezza.
- Portacarta integrato.
- Doppio portaflaconi posteriore.
- Portaflaconi laterale integrato

80 kg

RSC24L/7-O	RAL 2011	1	024004371
RSC24L/7-R	RAL 3000	1	024004373
RSC24L/7-A	RAL 7016	1	024004377

RSC24L-CAB

cassettiera mobile
con sette cassetti
e armadietto porta-oggetti

Caratteristiche principali:

- 7 cassetti da 588x367 mm, montati su guide telescopiche a sfera: 5 cassetti altezza 70 mm 1 cassetto altezza 140 mm 1 cassetto altezza 210 mm.
- Piano dei cassetti protetto da tappetini di gomma espansa.
- Quattro ruote Ø 125 mm: 2 fisse e 2 girevoli con freno.
- Serratura centralizzata frontale.
- Armadietto laterale portaoggetti con anta richiudibile con serratura e ripiano interno regolabile in altezza.
- Capacità di carico statico: 1.100 kg.
- Piano di lavoro in legno multistrato con fori per la collocazione di una morsa (1599F/100 da ordinare separatamente).
- Portacarta integrato.
- Doppio portaflaconi posteriore.
- Portaflaconi laterale integrato

82 kg

RSC24L-CAB/O	RAL 2011	1	024004471
RSC24L-CAB/R	RAL 3000	1	024004473
RSC24L-CAB/A	RAL 7016	1	024004477



C04TSS-7

cassettiera mobile con sette cassetti
in acciaio inossidabile, con ruote antitraccia

Caratteristiche principali:

- Sette cassetti da 570 x 410 mm montati su guide telescopiche a sfera;
- 6 cassetti altezza 83 mm;
- 1 cassetto altezza 170 mm;
- Quattro ruote antitraccia con nucleo in acciaio inossidabile Ø 125mm 2 fisse e 2 girevoli (due con freno);
- Serratura frontale centralizzata;
- Struttura interamente in acciaio inossidabile AISI 304
- Ruote, supporti, sfere, interno dei cassetti e relative guide in acciaio inossidabile
- Maniglia cassetti in alluminio

63 kg



700 kg

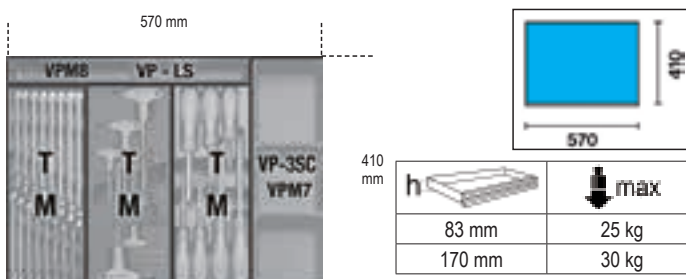

C04TSS/7

1

024003077

305

C25

carrello Tank con mensola

Caratteristiche principali:

- Coperchio di chiusura ribaltabile.
- 1 cassetto scorrevole.
- Piano di alloggiamento utensili protetto da tappetini di gomma espansa.
- Piani di servizio protetti con tappetini in gomma antiolio e antibenzina.
- Quattro ruote Ø 100 mm: 2 fisse e 2 girevoli (una con freno).
- Serratura centralizzata frontale.
- Termoformato vuoto per bussole e accessori da 1/2" (024990104)
- Possibilità di applicazione del portacarta 2499PC.

31,5 kg

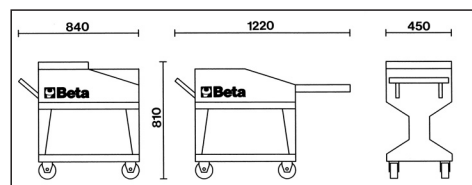

C25

1

025000001

C27S

carrello portautensili richiudibile per interventi esterni

Struttura in lamiera.

Carrello richiudibile con colonnine ribaltabili per permettere un agevole trasporto.

Modello registrato.

2 cassette 588x277 mm montati su guide telescopiche che permettono l'apertura in due sensi.

Ampio vano portaoggetti inferiore 588x277x220 mm.

2 ruote fisse Ø 160 mm e 2 ruote piroettanti con freno Ø 100 mm

Piano di lavoro termoplastico con 6 vaschette portaminuterie integrate.

Chiusura centralizzata.

Predisposizione per l'alloggiamento di separatori per cassetto e termoformati portautensili MC.

20 kg



C27S-O



C27S-G



C27S-R



h	max
70 mm	20 kg

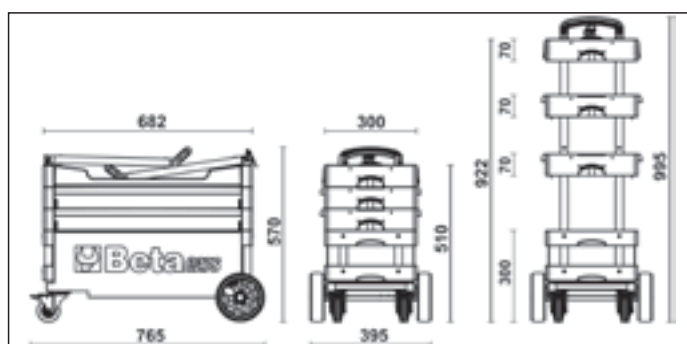
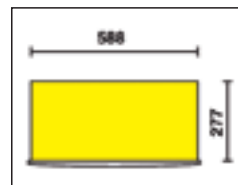

C27S-O	RAL 2011	1	027000201
C27S-G	RAL 7016	1	027000202
C27S-R	RAL 3000	1	027000203

RSC28

carrello SuperTank con piano di lavoro in legno e 10 cassetti

Caratteristiche principali:

- 10 cassetti da 588x367 mm, montati su guide telescopiche a sfera.
- Sistema rapido e sicuro per l'apertura e chiusura dei cassetti con frontalino in nylon e fibra di vetro.
- Cinque cassetti laterali di cui:
 - 4 cassetti altezza 70 mm
 - 1 cassetto altezza 210 mm.
- Cinque cassetti frontali di cui:
 - 4 cassetti altezza 70 mm
 - 1 cassetto altezza 210 mm.
- Piano dei cassetti protetto da tappetini di gomma espansa.
- Quattro ruote ad alta portata Ø 150 mm: 2 fisse e 2 girevoli con freno.
- 2 serrature di sicurezza centralizzate.
- Piano di lavoro in legno multistrato con fori per la collocazione di una morsa (1599F/150 da ordinare separatamente).
- Vano integrato portaminuterie.
- Vano laterale con antina di chiusura a scomparsa con serratura.
- Portaflaconi integrati.
- Vano passante altezza 135 mm con base ricoperta in materiale plastico.
- Capacità di carico statico: kg 1.200.

130 kg

1200 kg



RSC28-O



RSC28-A



RSC28-R



h	max
70 mm	25 kg
210 mm	30 kg

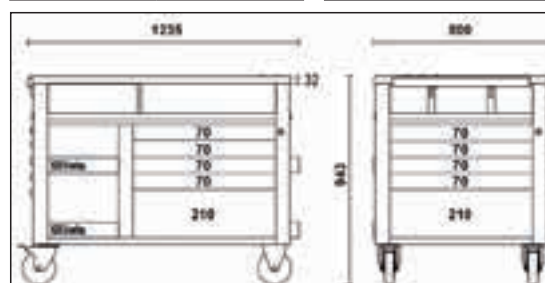

RSC28-O	1	028003001
RSC28-R	1	028003003
RSC28-A	1	028003007

C30M

postazione di lavoro mobile MaxiTank

Caratteristiche principali:

- 5 cassetti frontali montati su guide telescopiche a sfera:
 - 3 cassetti 367x610 mm, altezza 90 mm
 - 1 cassetto 588x610 mm, altezza 90 mm
 - 1 cassetto 588x610 mm, altezza 180 mm
- Sistema di apertura rapido con frontalino in alluminio.
- Piano dei cassetti protetto da tappetini di gomma espansa.
- Predisposizione per l'inserimento di termoformati.
- Un martinetto idraulico consente, senza sforzo, il sollevamento della parte anteriore e quindi un trasporto agevole.
- Quattro ruote ad alta portata:
 - 2 girevoli, anteriori, Ø 150 mm
 - 2 fisse, posteriori, Ø 170 mm.
- Piano di lavoro ricoperto in gomma antiolio 1300x800 mm con foro di scarico per la raccolta di liquidi in un piccolo serbatoio.
- Vano passante 720x250x1300 mm con piano ricoperto in PVC, chiuso frontalmente da antine a scomparsa.
- Chiusura centralizzata per cassetti e antine.
- 3 portafiacconi laterali integrati.
- Portacarta integrato
- Capacità di carico statico: kg 1.800.
- Predisposizione per la collocazione di un piano di lavoro in legno multistrato (3000M/PLM) da ordinare separatamente
- Possibilità di collocazione di una morsa 1599F/150. (da ordinare separatamente)

📦 200 kg



h	max
90 mm	30 kg
180 mm	35 kg

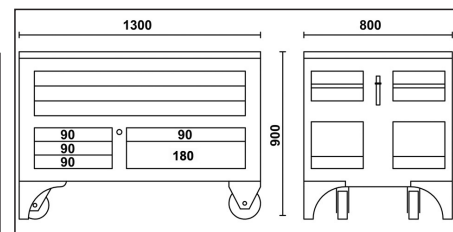
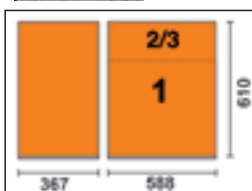

C30M

📦 1 030000300

3000M/PLM

piano di lavoro in legno per C30M, con fori per la collocazione di una morsa 1599F/150

📦 10 kg



📏 1240x740x26 mm

3000M/PLM

📦 1 030000350



PRATICA E ROBUSTA

- Cassetti ad estrazione totale
- Serratura di sicurezza centralizzata frontale
- Predisposizione per piano di lavoro e separatori per i cassetti, da ordinare separatamente
- Capacità di carico statico: 1200 kg

Modelli disponibili:

- **C35/6GM** (6 cassetti)
- **C35/7GM** (7 cassetti)
- **C35/8GM** (8 cassetti)
- **C35/9GM** (9 cassetti)

Accessori disponibili:

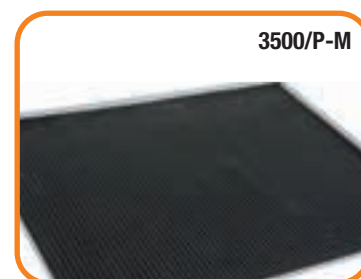

C35/6GM

cassettiera fissa industriale con 6 cassetti

Caratteristiche principali:

- 6 cassetti da 600x447 mm ad estrazione totale:

- 2 cassetti altezza 75 mm
- 1 cassetto altezza 100 mm
- 1 cassetto altezza 150 mm
- 1 cassetto altezza 200 mm
- 1 cassetto altezza 300 mm

- Serratura di sicurezza centralizzata frontale.

- Predisposizione per piano di lavoro e separatori per i cassetti, da ordinare separatamente

75 kg



h	max
75 mm	70 kg
100 mm	70 kg
150 mm	70 kg
200 mm	70 kg
300 mm	70 kg

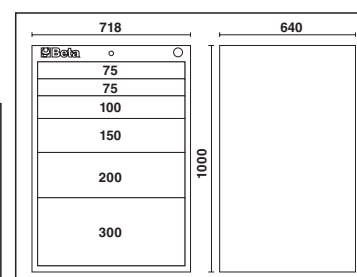

C35/6GM

1 035000162

C35/7GM

cassettiera fissa industriale con 7 cassetti

Caratteristiche principali:

- 7 cassetti da 600x447 mm ad estrazione totale:
- 2 cassetti altezza 75 mm
- 1 cassetto altezza 100 mm
- 3 cassetti altezza 150 mm
- 1 cassetto altezza 200 mm
- Serratura di sicurezza centralizzata frontale.
- Predisposizione per piano di lavoro e separatori per i cassetti, da ordinare separatamente

82 kg



h	max
75 mm	70 kg
100 mm	70 kg
150 mm	70 kg
200 mm	70 kg



718	640
75	
75	
100	
150	
150	
150	
200	

C35/7GM

1 035000172

C35/8GM

cassettiera fissa industriale con 8 cassetti

Caratteristiche principali:

- 8 cassetti da 600x447 mm ad estrazione totale:
- 4 cassetti altezza 75 mm
- 1 cassetto altezza 100 mm
- 2 cassetti altezza 150 mm
- 1 cassetto altezza 200 mm
- Serratura di sicurezza centralizzata frontale.
- Predisposizione per piano di lavoro e separatori per i cassetti, da ordinare separatamente

86 kg



h	max
75 mm	70 kg
100 mm	70 kg
150 mm	70 kg
200 mm	70 kg



718	640
75	
75	
75	
75	
100	
150	
150	
200	

C35/8GM

1 035000182

C35/9GM

cassettiera fissa industriale con 9 cassetti

Caratteristiche principali:

- 9 cassetti da 600x447 mm ad estrazione totale:
- 6 cassetti altezza 75 mm
- 3 cassetti altezza 150 mm
- Serratura di sicurezza centralizzata frontale.
- Predisposizione per piano di lavoro e separatori per i cassetti, da ordinare separatamente

91 kg



h	max
75 mm	70 kg
150 mm	70 kg



718	640
75	
75	
75	
75	
75	
75	
150	
150	
150	

C35/9GM

1 035000192

3500/P-M

piano di lavoro con bordo perimetrale per cassettiera C35

3500/P-M

700x600 mm

1 035000505



PARACOLPI MORBIDI

- Cassetti montati su guide telescopiche a sfera
- Piano di lavoro multifunzione ad alta resistenza
- Sistema di apertura a sgancio rapido in alluminio posizionato su tutta la lunghezza del cassetto
- Portaminuterie e fori per l'alloggiamento dei giravite
- Quattro ruote Ø 125 mm: 2 fisse e 2 girevoli (una con freno)
- Capacità di carico statico: 1000 kg
- Paracolpi angolari morbidi su tutta l'altezza della cassetiera per evitare, in caso di urto, il danneggiamento dei veicoli all'interno dell'officina
- Piano dei cassetti protetto da tappetini di gomma espansa
- Serratura di sicurezza centralizzata frontale
- Portaflaconi e portacarta laterali integrati regolabili in più posizioni

Modelli disponibili:

- C37/6 (6 cassetti)
- C37/7 (7 cassetti)
- C37/8 (8 cassetti)
- C37A/7 (7 cassetti con sistema antiribaltamento)



Colori disponibili:

O	RAL 2011
G	RAL 7016
R	RAL 3000

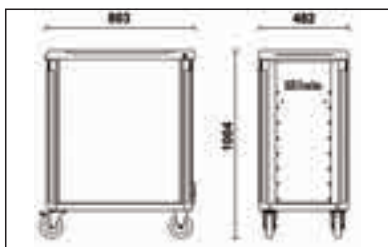

Accessori disponibili:



C37/7

cassetiera mobile con 7 cassetti

Caratteristiche principali:

- 7 cassetti da 588x367 mm, montati su guide telescopiche a sfera:
- 5 cassetti altezza 75 mm
- 1 cassetto altezza 150 mm
- 1 cassetto altezza 225 mm

71 kg

1000 kg



C37/7-O



C37/7-G



C37/7-R



C37/7-O	1	037000071
C37/7-G	1	037000072
C37/7-R	1	037000073

h	max
75 mm	30 kg
150 mm	35 kg
225 mm	35 kg

C37/6

cassettiera mobile
con 6 cassetti

Caratteristiche principali:

- 6 cassetti da 588x367 mm, montati su guide telescopiche a sfera:
- 4 cassetti altezza 75 mm
- 1 cassetto altezza 150 mm
- 1 cassetto altezza 305 mm

69 kg

C37/6-O	1	037000061
C37/6-G	1	037000062
C37/6-R	1	037000063



h	max
75 mm	30 kg
150 mm	35 kg
305 mm	40 kg



C37/8

cassettiera mobile
con 8 cassetti

Caratteristiche principali:

- 8 cassetti da 588x367 mm, montati su guide telescopiche a sfera:
- 6 cassetti altezza 75 mm
- 2 cassetti altezza 150 mm

73 kg

C37/8-O	1	037000081
C37/8-G	1	037000082
C37/8-R	1	037000083



h	max
75 mm	30 kg
150 mm	35 kg



C37A/7

cassettiera mobile
con 7 cassetti con sistema antiribaltamento

Caratteristiche principali:

- 7 cassetti da 588x367 mm, montati su guide telescopiche a sfera:
- 5 cassetti altezza 75 mm
- 1 cassetto altezza 150 mm
- 1 cassetto altezza 225 mm

71 kg

C37A/7-O	1	037000271
C37A/7-G	1	037000272
C37A/7-R	1	037000273





h	max
75 mm	30 kg
150 mm	35 kg
225 mm	35 kg



3700/PLA

piano di lavoro in acciaio inossidabile per cassettera C37

📦 2,8 kg

3700/PLA  1  037000100





3700/PLL

piano di lavoro in legno per cassettera C37

Con predisposizione per la collocazione di una morsa 1599P/100 (da ordinare separatamente)

📦 3,9 kg

3700/PLL  1  037000101





 672x396x28 mm

3700/PF

pannello forato con supporti per cassettera C37

📦 3,2 kg



3700/PF  1  037000102



3700/PFL

pannello forato laterale per cassettera C37

📦 1,9 kg

3700/PFL  1  037000104

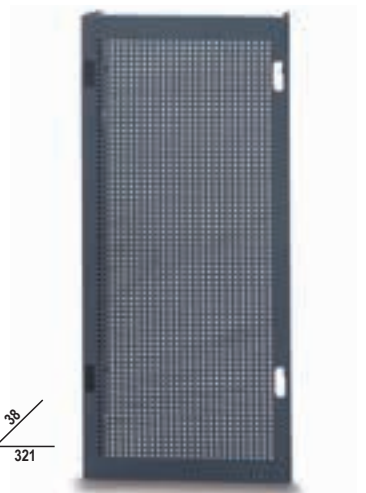

3700/PC

supporto porta computer per cassettera C37

Con cassetto estraibile

📦 3,1 kg

3700/PC  1  037000103



C38

cassettiera mobile
con 11 cassetti

Caratteristiche principali:

- 11 cassetti montati su guide telescopiche a sfera:
 - 1 cassetto 937x410x122 mm
 - 3 cassetti 570x410x74 mm
 - 2 cassetti 570x410x153 mm
 - 3 cassetti 313x410x74 mm
 - 2 cassetti 313x410x153 mm.
- Piano dei cassetti protetto da tappetini di gomma espansa.
- Capacità di carico statico: 1200 kg.
- 4 ruote ad alta portata Ø 125 mm:
 - 2 fisse e 2 girevoli (entrambe con freno a leva).
- Serratura centralizzata frontale.
- Piano di lavoro di lamiera ricoperto da tappetino in gomma.
- Possibilità di applicazione del portacarta 2499PC e del portafilaconi 2499PF.

114 kg



C38-G



C38-R



C38-O



h	max
74 mm	25 kg
153 mm	30 kg

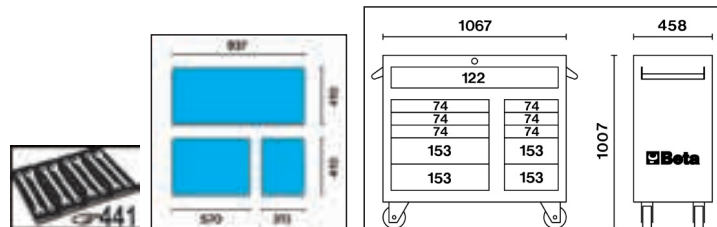

C38-O	1	038000001
C38-G	1	038000003
C38-R	1	038000002

C38L

cassettiera laterale con 7 cassetti

Caratteristiche principali:

- 7 cassetti da 410x313 mm, montati su guide telescopiche a sfera:
 - 5 cassetti altezza 74 mm
 - 2 cassetti altezza 153 mm.
- Piano dei cassetti protetto da tappetini di gomma espansa.
- Serratura di sicurezza centralizzata frontale.
- Piano di lavoro in alluminio antiscivolo.
- Agganciabile su entrambi i lati del C38.

45 kg

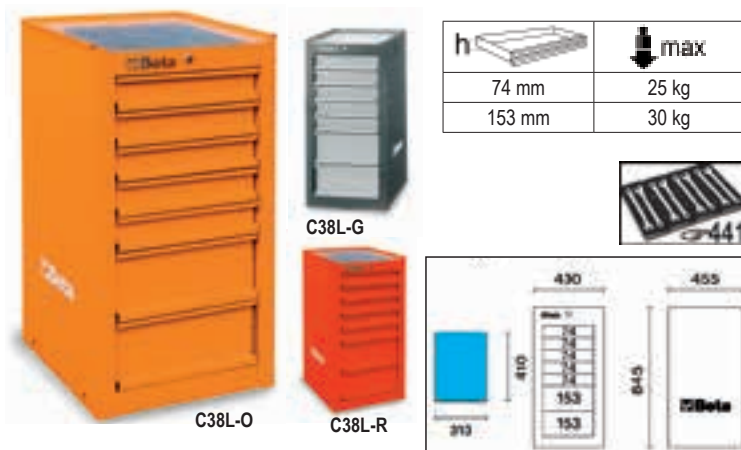

C38L-O



C38L-G

C38L-R

h	max
74 mm	25 kg
153 mm	30 kg

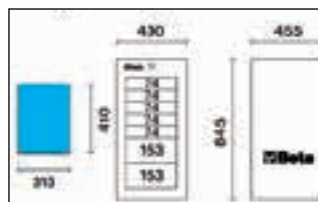

C38L-O	1	038000081
C38L-G	1	038000083
C38L-R	1	038000082

C38LA

modulo laterale con antina
e scaffale interno

Caratteristiche principali:

- Serratura frontale.
- Scaffale interno regolabile in altezza.
- Tasca portadocumenti posizionata all'interno dell'antina.
- Piano di lavoro in alluminio antiscivolo.
- Agganciabile su entrambi i lati del C38.

18 kg



C38LA-O



C38LA-G



C38LA-R

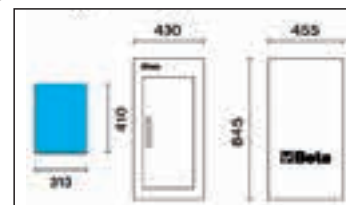

C38LA O	1	038000071
C38LA G	1	038000073
C38LA R	1	038000072

C38C

cassettiera mobile con 33 cassetti
composta da:

- 1 cassettiera mobile C38
- 2 cassette laterali C38L
- 1 cassettiera top C38T

📦 268 kg



C38C-O



C38C-G



C38C-R



h	max
74 mm	25 kg
153 mm	30 kg

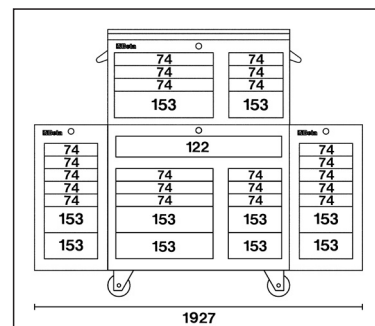
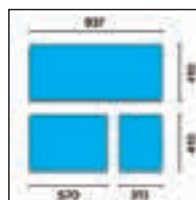

C38C-O	1	038000201
C38C-G	1	038000203
C38C-R	1	038000202

C38T

cassettiera top
con 8 cassetti e vano portautensili

Caratteristiche principali:

- 8 cassetti montati su guide telescopiche a sfera:
- 3 cassetti 570x410x74 mm
- 1 cassetto 570x410x153 mm
- 3 cassetti 313x410x74 mm
- 1 cassetto 313x410x153 mm.
- Vano portautensili.
- Piano dei cassetti protetto da tappetini di gomma espansa.
- Serratura di sicurezza centralizzata frontale.
- Collocabile sul piano di lavoro del C38.

📦 64 kg



C38T-O



C38T-G



C38T-R

h	max
74 mm	25 kg
153 mm	30 kg

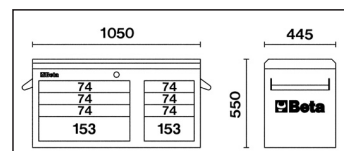
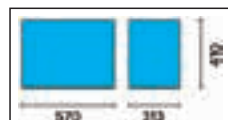

C38T-O	1	038000091
C38T-G	1	038000093
C38T-R	1	038000092

CASSETTIERA MOBILE C39

STRUTTURA PORTANTE IN LEGA DI ALLUMINIO + RESISTENZA + LEGGEREZZA

- Cassetti montati su guide telescopiche a sfera
- Piano di lavoro termoplastico sul quale è collocabile a misura una cassettera portatile C39T
- Sistema di apertura a sgancio rapido in alluminio posizionato su tutta la lunghezza del cassetto
- Quattro ruote Ø 125 mm; 2 fisse e 2 girevoli (una con freno)
- Capacità di carico statico: 1200 kg
- Piano dei cassetti protetto da tappetini di gomma espansa
- Serratura di sicurezza centralizzata frontale
- Portaminuterie e fori per l'alloggiamento dei giravite
- Portaflaconi laterali e posteriori integrati
- Portacarta integrato

Modelli disponibili:

- C39/6 (6 cassetti)
- C39/7 (7 cassetti)
- C39/8 (8 cassetti)

Colori disponibili:

O	RAL 2011
G	RAL 7016
R	RAL 3000

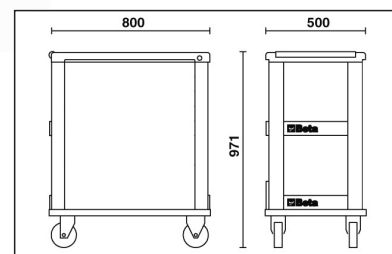

C39/7

cassettera mobile
con 7 cassetti

Caratteristiche principali:

- 7 cassetti da 588x367 mm, montati su guide telescopiche a sfera:
- 5 cassetti altezza 70 mm
- 1 cassetto altezza 140 mm.
- 1 cassetto altezza 210 mm

61 kg

1200 kg



C39-7/G



C39-7/R

C39-7/O

Modello	Quantità	Numero di serie
C39-7/O	1	039000001
C39-7/G	1	039000002
C39-7/R	1	039000003

h	max
70 mm	30 kg
140 mm	35 kg
210 mm	35 kg



C39/6

cassettiera mobile con 6 cassetti

Caratteristiche principali:

- 6 cassetti da 588x367 mm, montati su guide telescopiche a sfera:
- 4 cassetti altezza 70 mm
- 1 cassetto altezza 140 mm
- 1 cassetto altezza 280 mm

59 kg

C39-6/O	1	039000031
C39-6/G	1	039000032
C39-6/R	1	039000033



C39-6/G



C39-6/R



h	max
70 mm	30 kg
140 mm	35 kg
280 mm	40 kg



C39/8

cassettiera mobile con 8 cassetti

Caratteristiche principali:

- 8 cassetti da 588x367 mm, montati su guide telescopiche a sfera:
- 6 cassetti altezza 70 mm
- 2 cassetti altezza 140 mm

64 kg

C39-8/O	1	039000041
C39-8/G	1	039000042
C39-8/R	1	039000043



C39-8/G



C39-8/R



h	max
70 mm	30 kg
140 mm	35 kg



C39T

cassettiera portatile con 4 cassetti

Caratteristiche principali:

- 4 cassetti da 588x367 mm, montati su guide telescopiche a sfera:
- 4 cassetti altezza 70 mm
- Serratura centralizzata frontale.
- Montanti e frontalino del cassetto in alluminio.

29 kg

C39T-O	1	039000101
C39T-G	1	039000102
C39T-R	1	039000103



C39T-O



C39T-R

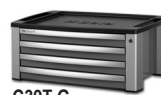

C39T-G



29 kg

h	max
70 mm	30 kg

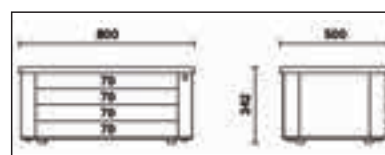

2400-COVER RSC24

Protezione in nylon per cassettera mobile RSC24/RSC24A - C39

2400-COVER RSC24

1 024000910



2400-COVER RSC24AXL

Protezione in nylon per cassettera mobile RSC24AXL, RSC24L/7, RSC24L-CAB

2400-COVER RSC24AXL

1 024000930



3700-COVER C37

Protezione in nylon per cassettera mobile C37

3700-COVER C37

1 037000930



C39SM

cassettiera speciale mobile tipo Racing SM

Caratteristiche tecniche

- Piano di lavoro in legno multistrato
- Serratura di sicurezza centralizzata frontale.
- 4 ruote Ø 125 mm
- 2 fisse e 2 girevoli (una con freno) con copertura a vista
- Capacità di carico statico: 1200 Kg

Modulo con 7 cassetti

da 588x367 mm, montati

su guide telescopiche a sfera:

6 cassetti altezza 70 mm

1 cassetto altezza 240 mm

• Piano dei cassetti protetto da tappetini di gomma espansa.

• Sistema di apertura posizionato su tutta la lunghezza del cassetto.

• Frontalino del cassetto in alluminio.

Modulo di servizio

• Cestino portarifiuti integrato

• Vano portacarta per rotoli integrato

• 1 cassetto portaoggetti 380x305x270 mm

125 kg

C39SM-O	RAL 2011	1	039390001
C39SM-G	RAL 7016	1	039390002
C39SM-R	RAL 3000	1	039390003

1200 kg



C39SM-G



C39SM-R



C39SM-O

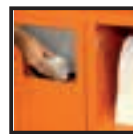

h	max
70 mm	30 kg
240 mm	40 kg

h	max
70 mm	30 kg
240 mm	40 kg



C39MD

cassettiera speciale mobile Racing MD

Caratteristiche tecniche

- Piano di lavoro in legno multistrato
- Serratura di sicurezza centralizzata frontale.
- 4 ruote Ø 125 mm
- 2 fisse e 2 girevoli (una con freno) con copertura a vista
- Capacità di carico statico: 1200 Kg

Modulo con 7 cassetti

da 588x367 mm, montati

su guide telescopiche a sfera:

6 cassetti altezza 70 mm

1 cassetto altezza 240 mm

• Piano dei cassetti protetto da tappetini di gomma espansa.

• Sistema di apertura posizionato su tutta la lunghezza del cassetto.

• Frontalino del cassetto in alluminio.

Modulo con 2 cassetti

da 588x367x270 mm e 588x367x380 mm, montati su guide telescopiche a sfera

• Piano dei cassetti protetto da tappetini di gomma espansa

• Sistema di apertura posizionato su tutta la lunghezza dei cassettoni

• Frontalino dei cassettoni in alluminio.

123 kg

C39MD-O	RAL 2011	1	039390101
C39MD-G	RAL 7016	1	039390102
C39MD-R	RAL 3000	1	039390103

1200 kg



C39MD-G



C39MD-R

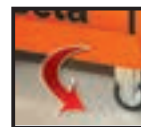

C39MD-O



h	max
70 mm	30 kg
240 mm	40 kg

h	max
70 mm	30 kg
240 mm	40 kg

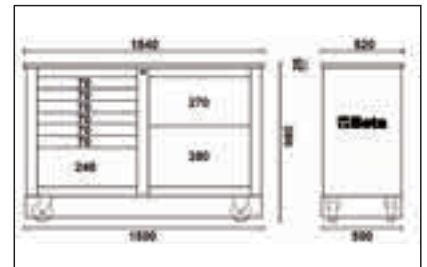

C41S

trolley portautensili
a 2 moduli sovrapponibili

Caratteristiche principali:

- Struttura in lamiera e piani in materiale plastico: grande robustezza e peso ridotto.
- 2 moduli separabili: 1 cestello superiore, 1 modulo con 1 cassetto altezza 95 mm e 1 cassetto altezza 295 mm.
- Ruote di grosso diametro (160 mm), integrate nella struttura per facilitare il trasporto anche su gradini.
- Serratura centralizzata laterale per la chiusura dei 2 cassetti del modulo inferiore.
- Cassetti montati su guide telescopiche a sfera con doppio gancio di chiusura.
- Impugnatura con manico telescopico in alluminio.
- Portaminuterie integrato nel cestello superiore.
- Cassetto inferiore con doppia guida telescopica
- Assortimenti consigliati: 5940/SBK e 5915VU/5

16 kg

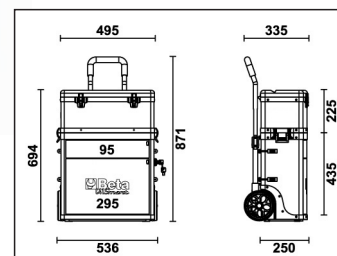

C41S



1 041000001

C41H

trolley portautensili
a 2 moduli sovrapponibili

Caratteristiche principali:

- Struttura in lamiera e piani in materiale plastico: grande robustezza e peso ridotto.
- 2 moduli separabili: 1 cestello superiore, 1 modulo con 2 cassetti altezza 95 mm, 1 cassetta estraibile in materiale plastico altezza 66 mm e 1 cassetto altezza 295 mm.
- Ruote di grosso diametro (160 mm), integrate nella struttura per facilitare il trasporto anche su gradini.
- Serratura centralizzata laterale per la chiusura dei cassetti del modulo inferiore.
- Cassetti montati su guide telescopiche a sfera con doppio gancio di chiusura.
- Impugnatura con manico telescopico in alluminio.
- Portaminuterie integrato
- Cassetto inferiore con doppia guida telescopica

• Assortimenti consigliati: 5940/SBK, 5915VU/5 e 5941VU-M

* Colorazioni disponibili su richiesta

21 kg



C41H-O



C41H-W

C41H-Y

C41H-R

C41H-V

C41H-B

C41H-G

C41H-N

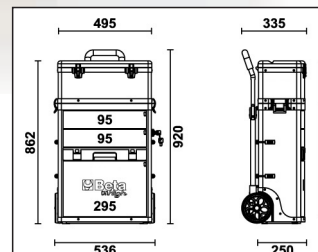

Model	Color	Weight	Part Number
C41H-O	RAL 2011	1	041000002
C41H-N	RAL 9005	1	041000005
C41H-B	RAL 5002	1	041000006
C41H-R	RAL 3000	1	041000008
C41H-G	RAL 7016	1	041000010
C41H-Y	RAL 1023	1	041000012
C41H-W	RAL 9016	1	041000021
C41H-V	RAL 6016	1	041000024

C41H/CE

cassetta portautensili con separatori estraibili per minuterie,
in materiale plastico per trolley C41H

1,3 kg



C41H/CE



1 041000916

C42H

trolley portautensili a tre moduli sovrapponibili

Caratteristiche principali:

- Struttura in lamiera e materiale plastico: grande robustezza e peso ridotto.
- 3 moduli separabili:
 - 1 cestello superiore, altezza 220 mm
 - 1 modulo portautensili centrale, altezza 180 mm
 - 1 modulo portautensili inferiore con ruote, altezza 330 mm.
- Ruote di grosso diametro (\varnothing 160 mm),
- Manico telescopico regolabile in 3 posizioni.
- Sistema di sgancio rapido dei moduli: agevole e veloce accesso a tutti i diversi scomparti portautensili.
- Cestello superiore con vano portaoggetti interno e 3 portaminuterie integrati nel coperchio
- Predisposizione per essere utilizzato solamente con 2 moduli.
- Assortimenti consigliati: 5940/SBK e 5915VU/5

14 kg

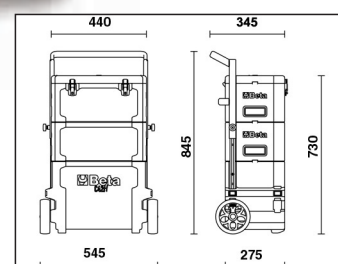

C42H



042000002

Beta

CX49-G

carrello multifunzione

utilizzabile come postazione mobile
per strumenti di diagnosi, laptop, tester e caricabatterie.

Caratteristiche:

- Struttura in lamiera verniciata: massima stabilità e solidità
- Maniglia ergonomica
- Piano di appoggio superiore su 2 livelli
- Cassetto estraibile per mini tastiera
- 2 ripiani centrali con posizione regolabile e 1 ripiano basso fisso
- 4 utili avvolgicavo laterali in plastica
- 2 pratici contenitori laterali
- 2 ruote posteriori fisse Ø 160 mm
- 2 ruote anteriori girevoli Ø 100 mm (una con freno)
- Peso: 43 kg

CX49



1 049000102



CA49-G

carrello multifunzione con antenna

utilizzabile come postazione mobile
per strumenti di diagnosi, laptop, tester e caricabatterie.

Caratteristiche:

- Struttura in lamiera verniciata: massima stabilità e solidità
- Maniglia ergonomica
- Piano di appoggio superiore su 2 livelli
- Cassetto estraibile per mini tastiera
- 1 ripiano con posizione regolabile, 1 ripiano fisso e antenna di chiusura
- 4 utili avvolgicavo laterali in plastica
- 2 pratici contenitori laterali
- 2 ruote posteriori fisse Ø 160 mm
- 2 ruote anteriori girevoli Ø 125 mm (una con freno)
- Peso: 36,5 kg

CA49 G



1 049000112



4900-COVER C49

protezione in nylon per carrello multifunzione C49

4900-COVER C49



1 049000930



C48M

carrello contenitore elettrico, con sponde

Le dimensioni ridotte e la versatilità di utilizzo rendono il carrello C48M la soluzione ideale per movimentare in modalità elettroassistita carichi pesanti (scatole, contenitori, oggetti ingombranti, parti di attrezzature) in totale sicurezza, anche in zone di difficile accesso o in ambienti di lavoro dove i tradizionali muletti non possono accedere.

Ne consegue un'importante riduzione dei rischi legati all'incolumità dell'operatore, come per esempio i disturbi muscoloscheletrici causati dalla movimentazione manuale dei carichi.

Pianale motorizzato con motore 24V - 400W con alimentazione a batteria 2x12V 33Ah e scheda di controllo Curtis.

Piano di carico realizzato in solido acciaio, ricoperto con gomma antiscivolo, con sponde tubolari di contenimento a sezione tonda per il trasporto del carico in sicurezza.

Le sponde possono anche essere sfilate, per adattarsi alle singole esigenze di trasporto.

La consolle di comando è dotata di:

- chiave di accensione
- regolazione della velocità
- farfalle laterali per il controllo della trazione
- segnale acustico intermittente che si attiva durante la retromarcia
- indicatore stato di carica della batteria
- pulsante per esclusione freno elettrico
- fungo di emergenza

Dotato di 2 ruote pneumatiche di trazione Ø260mm e 2 ruote in gomma piroettanti Ø150mm, freno elettromagnetico e differenziale.

Carica batterie esterno 220V/50Hz - V/A 24/12 in dotazione

Caratteristiche funzionali

- Capacità di carico: 400 kg
- Velocità di marcia: 4-6 km/h (regolabile)
- Autonomia: 4 ore
- Pendenza massima superabile a pieno carico: 6%
- Pendenza massima superabile con 100 kg di carico: 18%

Dispositivi di sicurezza

- Freno elettronico
- Segnalatore acustico
- Protezione antischiacciamento
- Indicatore dello stato di carica della batteria
- Scheda di controllo Curtis

Caratteristiche tecniche

- Dimensioni di ingombro: mm 1280x630x1100h
- Dimensioni utili piano di carico con sponde: mm 1180x580
- Dimensioni utili piano di carico senza sponde: mm 1260x620
- Altezza pianale di carico dal pavimento: 320 mm
- Altezza vano batteria-pavimento: 65 mm
- Peso con batterie: 140 kg

140 kg

C48M



1 048000230

Beta
BRUTUS

CE

400
kg



1100
630
1280



C48P

carrello pieghevole

Caratteristiche principali:

- Pianale di carico in polipropilene (PP) rinforzato, con rivestimento antiscivolo e inserti in TPV per la protezione degli spigoli
- Maniglia richiudibile per uno stoccaggio rapido e poco ingombrante
- Quattro ruote antitraccia Ø 125 mm: 2 fisse e 2 girevoli con freno
- Portata massima 300 kg.
- Larghezza utile pianale di carico: 705 mm
- Profondità pianale di carico: 480 mm
- Altezza pianale di carico: 200 mm



280
mm



300
kg



11 kg

C48P



1 048000030

C51

carrello

- 3 ripiani ricoperti in gomma millerighe antiscivolo
- Maniglia ergonomica
- Doppia possibilità di fissaggio del ripiano centrale
- Quattro ruote Ø 100 mm:
- 2 fisse e 2 girevoli (una con freno).
- Capacità di carico statico: 200 kg. (distribuita sui 3 ripiani)

21 kg

C51 O	RAL 2011	1	051000001
C51 G	RAL 7016	1	051000002
C51 R	RAL 3000	1	051000003

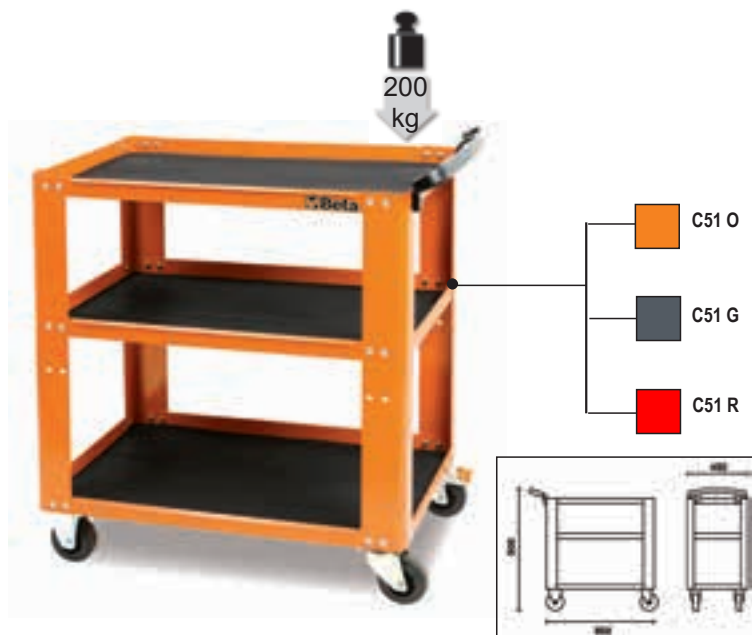

RSC51

carrello di servizio con 3 cassetti

Caratteristiche principali:

- Piano di lavoro rinforzato in ABS, solido e robusto
- Piano di appoggio multifunzione con bordi anticaduta e 8 fori per l'alloggiamento dei giravite
- 3 cassetti da 588x367 mm, montati su guide telescopiche a sfera, altezza 70 mm
- Piano dei cassetti protetto da tappetini di gomma espansa
- Possibilità di inserire in ogni cassetto fino a 4 vassoi morbidi in EVA o termoformati rigidi in ABS
- Serratura di sicurezza centralizzata frontale
- Pratico portagiravite laterale incluso
- Due portabombolette laterali integrati nella struttura
- Ampio ripiano inferiore protetto con tappetino in gomma antiolio e antibenzina
- Quattro ruote Ø 125 mm: 2 fisse e 2 girevoli (una con freno)

- Capacità di carico statico: 400 kg
- Portata singolo cassetto: 15 kg uniformemente distribuiti

Accessori integrabili:

- Piano di lavoro in legno 2400 RSC24/PL
- Pannello forato portautensili 2400 RSC24/PF
- Supporto porta computer 2400 RSC24/SPC
- Mensola pieghevole 2400 RSC24/MP
- Portacarta per rotoli preforati 2400 RSC24/PC-A

38 kg

RSC51-FO	RAL 2011	1	051000300
RSC51-R	RAL 3000	1	051000303
RSC51-A	RAL 7016	1	051000307



2400 RSC24/MP

mensola pieghevole per RSC24 - RSC24A - RSC51

- Utilizzabile come piano di lavoro supplementare
- Piano di lavoro mis. 390x440 mm, protetto con tappetino in gomma antiolio e antibenzina
- Capacità di carico: 20 kg

3,4 kg

2400 RSC24/MP		1	024004900
---------------	--	---	-----------

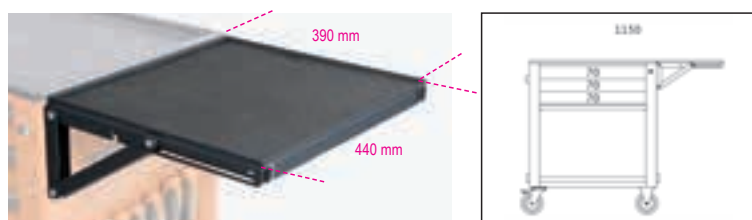

CP51

carrello ad alta resistenza

- 2 ripiani ricoperti da tappetini in gomma
- Maniglia ergonomica
- Quattro ruote Ø 125 mm ad alta resistenza: 2 fisse e 2 girevoli con freno
- Capacità di carico statico: 750 kg. (distribuita sui 2 ripiani)

📏 37 kg

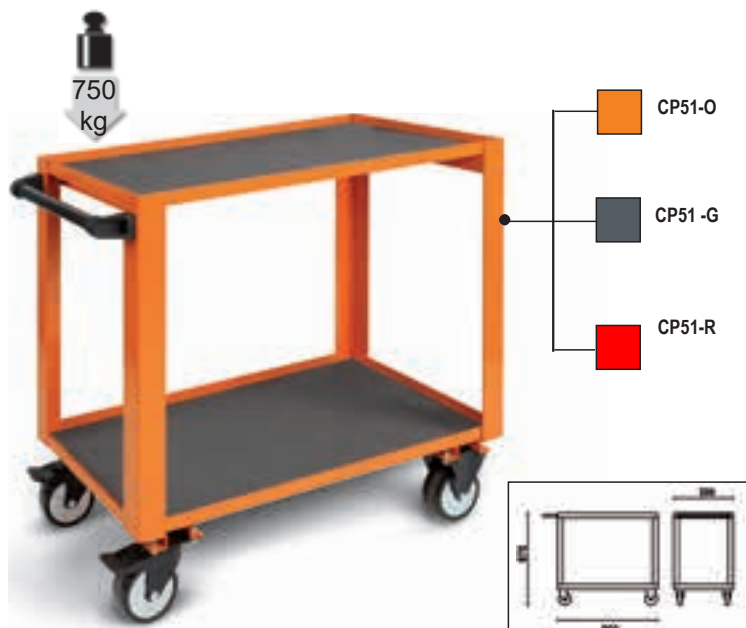

CP51 O	RAL 2011	1	051000501
CP51 G	RAL 7016	1	051000502
CP51 R	RAL 3000	1	051000503

CB52

carrello per cambi/trasmissioni
con recupero liquidi

Il piano inclinato e i fori di scolo
permettono il recupero dei liquidi
direttamente nella vaschetta di raccolta

Dotato di:

- 4 ruote girevoli di cui 2 con freno
- Cassetto per utensili
- Vaschetta di raccolta liquidi estraibile con capacità 7 litri
- 2 ripiani

📏 60 kg



CB52		1	052000201
------	--	---	-----------

Beta

C56P O

banco da lavoro pieghevole

Compatto e facilmente trasportabile.
Piano di lavoro 800x500mm (spessore 30 mm) in MDF e lamiera zincata, utilizzabile da entrambi i lati.
Maniglia con protezione in gomma per un agevole trasporto.
Piedini con copertura anti-scivolamento.
Capacità di carico statico: 250 kg

👤 25 kg



C56P O

👤 1 056000011

C56PL O

banco da lavoro pieghevole, versione Light

Leggero, compatto e facilmente trasportabile.
Piano di lavoro 800x500mm in lamiera zincata utilizzabile da un solo lato, protetto con rivestimento in gomma antiolio e antibenzina.
Maniglia con protezione in gomma per un agevole trasporto.
Piedini con copertura anti-scivolamento.
Capacità di carico statico: 200 kg

👤 18,5 kg



C56PL O

👤 1 056000021

C54S

armadietti Cargo

Sono realizzati sulla base di accurate ricerche presso qualificati utilizzatori professionali ed offrono le soluzioni ideali per operare in modo confortevole e razionale.
L'apertura dei pannelli forati delle due antine permette lo sfruttamento anche della loro superficie interna.

Caratteristiche principali:

- 1 cassetto montato su guide telescopiche.
- Possibilità di modificare facilmente la disposizione degli utensili in funzione delle proprie esigenze.
- Posizionamento a parete per mezzo di due asole situate posteriormente.
- Serratura per chiusura contemporanea di antine e cassetto.
- Termoformato vuoto per bussole e accessori da 1/2".

37 kg



C54S-G



C54S-R



C54S-O

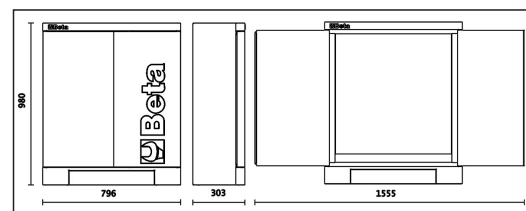

C54S-O	RAL 2011	1	054000301
C54S-G	RAL 7016	1	054000302
C54S-R	RAL 3000	1	054000303



C57SA

banco da lavoro MasterCargo

- Modello con parete portautensili (C57SP) e una cassetiera.

Cassetiera formata da cinque cassetti da 367x588 mm di cui 3 altezza 90 mm, 1 altezza 180 mm e 1 altezza 280 mm montati su guide telescopiche a sfera.

Predisposizione per l'inserimento di termoformati
Serratura centralizzata.

Parete portautensili anche appendibile mediante asole.

Tapparella in alluminio, manovrabile verticalmente, con serratura.

Tre pannelli forati amovibili per il sostegno degli utensili.

Piano di lavoro in legno multistrato, rivestito in laminato plastico con tre fori per la collocazione di una morsa 1599F/150 da ordinare separatamente.

1800 kg



C57S/A-O



C57S/A-G



C57S/A-R



h	max
90 mm	30 kg
180 mm	40 kg
280 mm	40 kg

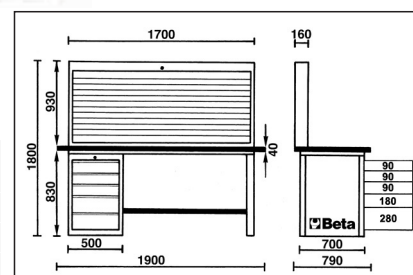

Model	RAL	Weight	Code
C57S/A-O	RAL 2011	1	057001005
C57S/A-G	RAL 7016	1	057001205
C57S/A-R	RAL 3000	1	057001405

C57SD

banco da lavoro MasterCargo

- Modello con una cassetiera

Cassetiera formata da cinque cassetti da 367x588 mm di cui 3 altezza 90 mm, 1 altezza 180 mm e 1 altezza 280 mm montati su guide telescopiche a sfera.

Predisposizione per l'inserimento di termoformati
Serratura centralizzata.

Piano di lavoro in legno multistrato, rivestito in laminato plastico con tre fori per la collocazione di una morsa 1599F/150 da ordinare separatamente.

158 kg



C57S/D-O



h	max
90 mm	30 kg
180 mm	40 kg
280 mm	40 kg



C57S/D-G



C57S/D-R

Model	RAL	Weight	Code
C57S/D-O	RAL 2011	1	057001004
C57S/D-G	RAL 7016	1	057001204
C57S/D-R	RAL 3000	1	057001404

C57SB

banco da lavoro MasterCargo

- Modello con parete portautensili (C57SP) e due cassettiere.

Cassettiera formata da cinque cassetti da 367x588 mm di cui 3 altezza 90 mm, 1 altezza 180 mm e 1 altezza 280 mm montati su guide telescopiche a sfera.

Predisposizione per l'inserimento di termoformati
Serratura centralizzata.

Parete portautensili anche appendibile mediante asole.

Tapparella in alluminio, manovrabile verticalmente, con serratura.

Tre pannelli forati amovibili per il sostegno degli utensili.

Piano di lavoro in legno multistrato, rivestito in laminato plastico con tre fori per la collocazione di una morsa 1599F/150 da ordinare separatamente.



C57S/B-O

243 kg



C57S/B-G



C57S/B-R



h	max
90 mm	30 kg
180 mm	40 kg
280 mm	40 kg

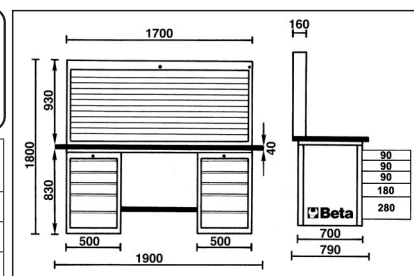

C57S/B-O	RAL 2011	1	057001006
C57S/B-G	RAL 7016	1	057001206
C57S/B-R	RAL 3000	1	057001406

C57SC

banco da lavoro MasterCargo

- Modello con due cassettiere.

Cassettiera formata da cinque cassetti da 367x588 mm di cui 3 altezza 90 mm, 1 altezza 180 mm e 1 altezza 280 mm montati su guide telescopiche a sfera.

Predisposizione per l'inserimento di termoformati
Serratura centralizzata.

Piano di lavoro in legno multistrato, rivestito in laminato plastico con tre fori per la collocazione di una morsa 1599F/150 da ordinare separatamente.

1800 kg



h	max
90 mm	30 kg
180 mm	40 kg
280 mm	40 kg



C57S/C-O



C57S/C-G



C57S/C-R

196 kg

C57S/C-O	RAL 2011	1	057001003
C57S/C-G	RAL 7016	1	057001203
C57S/C-R	RAL 3000	1	057001403

C57SP

parete portautensili MasterCargo

- Parete portautensili anche appendibile mediante asole.
- Tapparella in alluminio, manovrabile verticalmente, con serratura.
- Tre pannelli forati amovibili per il sostegno degli utensili.

📦 46 kg

C57SP-O	RAL 2011	1	057001020
C57SP-G	RAL 7016	1	057001220
C57SP-R	RAL 3000	1	057001420



C57SP O

1700 mm

930 mm



C57SP G



C57SP R

5700LAMP

lampada per banco MasterCargo

- Robusta struttura in lamiera composta da quattro elementi; completa di viti per l'assemblaggio.
- Portalampana con striscia LED da 1120 Lumen, 4000K, 14W
- Alimentazione 230V.
- Fornito senza cavo.

📦 9 kg

5700LAMP		1	057000005
----------	--	---	-----------



5700LAMP + C57S/A-O

1000 mm

1030 mm

1900 mm

C58P

parete portautensili

- Soluzione con chiusura a tapparella in alluminio verniciato e serratura di chiusura.
- Due pannelli forati amovibili per il sostegno degli utensili.

📦 46,8 kg

C58P-O	RAL 2011	1	058000221
C58P-G	RAL 7016	1	058000222
C58P-R	RAL 3000	1	058000223



C58P-G

C58P-R

C58P-O

930 mm

1360 mm



PV

pannello portautensili da parete

	LxA mm			
PV1	1000x920	10,2	1	088880010
PV1,5	1500x920	14,2	1	088880015



C56W

banco da lavoro con piano di lavoro in legno

- Piano di lavoro in legno multistrato con fori per la collocazione di una morsa 1599F/125 (da ordinare separatamente)
- Struttura in acciaio con 6 gambe di sostegno
- Capacità di carico statico: 1.200 kg
- Abbinabile alla parete C57SP (non fissabile al piano di lavoro).
- Due cassetti dotati di serratura.
- Predisposizione per il fissaggio al pavimento.

📦 86 kg



C56W-O	RAL 2011	1	056000251
C56W-G	RAL 7016	1	056000252
C56W-R	RAL 3000	1	056000253

C56B

banco da lavoro con piano in legno

Caratteristiche principali:

- Piano di lavoro in legno multistrato con fori per la collocazione di una morsa 1599F/125 (da ordinare separatamente).
- Struttura in acciaio con 4 gambe di sostegno
- Capacità di carico statico: 600 kg.
- Ripiano inferiore portaoggetti con capacità di carico 150 kg. (uniformemente distribuiti)
- Predisposizione per il fissaggio al pavimento

📦 54,5 kg

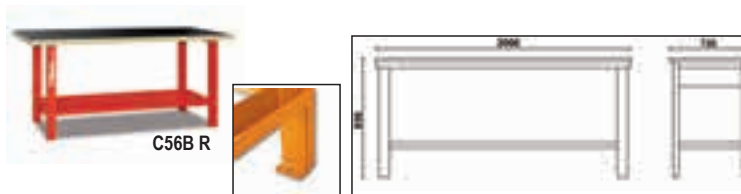

C56B-O	RAL 2011	1	056000401
C56B-G	RAL 7016	1	056000402
C56B-R	RAL 3000	1	056000403

C56

banco da lavoro

- Piano di lavoro in lamiera verniciata con bordo perimetrale
- Struttura in acciaio con 6 gambe di sostegno
- Capacità di carico statico: 1.200 kg
- Abbinabile alla parete C57SP non fissabile al piano di lavoro.
- Due cassetti dotati di serratura.
- Predisposizione per il fissaggio al pavimento.

📦 82 kg



C56-O	RAL 2011	1	056000201
C56-G	RAL 7016	1	056000202
C56-R	RAL 3000	1	056000203

C56M

banco da lavoro

- Piano di lavoro in metallo rivestito per metà da lastra in alluminio antiscivolo e per metà da tappeto in gomma asportabile.
- Sottopiano in massello di legno.
- Capacità di carico statico: 800 kg
- Abbinabile alla parete C57SP non fissabile al piano di lavoro.
- Tre cassetti dotati di serratura.
- Predisposizione per il fissaggio al pavimento.

📦 95 kg



C56M O	RAL 2011	1	056000050
C56M G	RAL 7016	1	056000053
C56M R	RAL 3000	1	056000054

C58B

banco da lavoro con piano in legno

Caratteristiche principali:

- Piano di lavoro in legno multistrato con fori per la collocazione di una morsa 1599F/125 (da ordinare separatamente).
- Struttura in acciaio con 4 gambe di sostegno
- Capacità di carico statico: 800 kg.
- Ripiano inferiore portaoggetti con capacità di carico 150 kg. (uniformemente distribuiti)
- Predisposizione per il fissaggio al pavimento

📦 44 kg



C58B-O	RAL 2011	1	058000401
C58B-G	RAL 7016	1	058000402
C58B-R	RAL 3000	1	058000403

C58M

banco da lavoro

- Piano di lavoro in metallo interamente rivestito da un tappetino in gomma antiscivolo asportabile.
- Sottopiano in massello di legno.
- Capacità di carico statico: 800 kg.
- 2 cassetti dotati di serratura.
- Predisposizione per il fissaggio al pavimento.
- Possibilità di applicazione opzionale del piano di lavoro in alluminio C58M/PA.

📦 65 kg



C58M-O	RAL 2011	1	058000300
C58M-G	RAL 7016	1	058000302
C58M-R	RAL 3000	1	058000303

C58M/PA

piano in alluminio godronato
per banco da lavoro C58M

4,5 kg

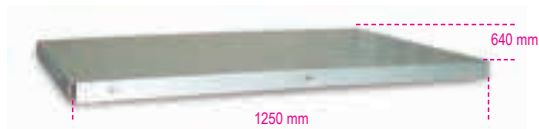

C58M/PA

1 058000350

C59A

banco da lavoro "Endurance" con 1 cassetiera da 6 cassetti

Caratteristiche principali:

- Ripiano in legno multistrato con fori per la collocazione di una morsa 1599F/125 (da ordinare separatamente).
- 6 cassetti 588x367 mm, montati su guide telescopiche a sfera:
 - 4 cassetti altezza 70 mm
 - 1 cassetto altezza 140 mm
 - 1 cassetto altezza 280 mm
- Piano dei cassetti protetto da tappetini di gomma espansa.
- Frontalino dei cassetti in Nylon ad alta resistenza.
- Cassettiere predisposte per l'inserimento di termoformati.
- Serratura di sicurezza centralizzata frontale.
- Ripiano inferiore portaoggetti.
- Predisposizione per portacarta (2400 RSC24/PC) e portafaconi (2400 RSC24/PF-) da ordinare separatamente.

115 kg

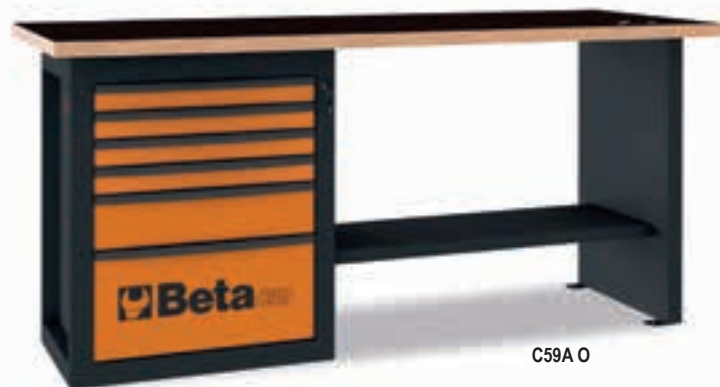

C59A O



C59A A



C59A R



1500 kg



		1	
C59A-O	RAL 2011	1	059000011
C59A-A	RAL 7016	1	059000031
C59A-R	RAL 3000	1	059000051

h	max
70 mm	25 kg
140 mm	30 kg
280 mm	35 kg



C59B

banco da lavoro "Endurance" con 2 cassetiere da 6 cassetti

Caratteristiche principali:

- Ripiano in legno multistrato con fori per la collocazione di una morsa 1599F/125 (da ordinare separatamente).
- 12 cassetti 588x367 mm, montati su guide telescopiche a sfera:
 - 8 cassetti altezza 70 mm
 - 2 cassetti altezza 140 mm
 - 2 cassetti altezza 280 mm
- Piano dei cassetti protetto da tappetini di gomma espansa.
- Possibilità di inserimento termoformati.
- Serratura di sicurezza centralizzata frontale.
- Ripiano inferiore portaoggetti.
- Predisposizione per portacarta (2400 RSC24/PC) e portaflaconi (2400 RSC24/PF-) da ordinare separatamente.

155 kg

Modello	RAL	Q	Articolo
C59B-O	RAL 2011	1	059000012
C59B-R	RAL 3000	1	059000052
C59B-A	RAL 7016	1	059000032

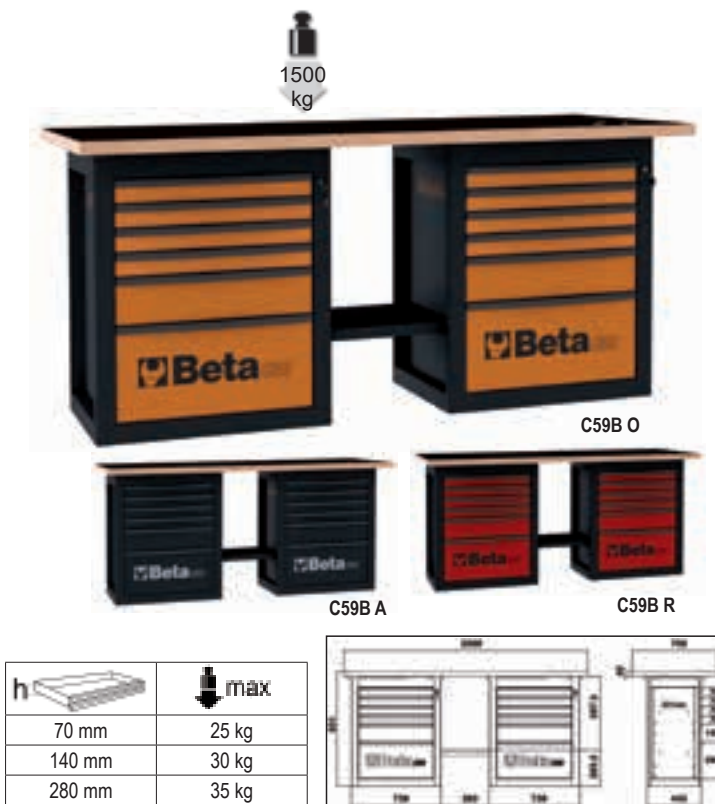

h	max
70 mm	25 kg
140 mm	30 kg
280 mm	35 kg

C59C

banco da lavoro "Endurance" con 1 cassetiera da 6 cassetti, modello corto

Caratteristiche principali:

- Ripiano in legno multistrato con fori per la collocazione di una morsa 1599F/125 (da ordinare separatamente).
- 6 cassetti 588x367 mm, montati su guide telescopiche a sfera:
 - 4 cassetti altezza 70 mm
 - 1 cassetto altezza 140 mm
 - 1 cassetto altezza 280 mm
- Piano dei cassetti protetto da tappetini di gomma espansa.
- Possibilità di inserimento termoformati.
- Serratura di sicurezza centralizzata frontale.
- Ripiano inferiore portaoggetti.
- Predisposizione per portacarta (2400 RSC24/PC) e portaflaconi (2400 RSC24/PF-) da ordinare separatamente.

105 kg

Modello	RAL	Q	Articolo
C59C-O	RAL 2011	1	059000013
C59C-R	RAL 3000	1	059000053
C59C-A	RAL 7016	1	059000033



h	max
70 mm	25 kg
140 mm	30 kg
280 mm	35 kg

9562T2

tappeto per banco da lavoro 200x160 cm

- protegge il suolo da perdite d'olio, benzina e rispetta l'ambiente
- facile da pulire, fondo gommato ed antiscivolo



Modello	L cm	Q	Articolo
9562T2	200	1	095620200



ARREDO OFFICINA



Beta Utensili, per rispondere alle esigenze di un mercato che sempre più ricerca qualità, design e personalizzazione, ha creato "Racing System C55": un arredo per officina modulare che vi offre la possibilità di creare un ambiente di lavoro moderno, modellato sulle vostre necessità.

Qualità

La migliore qualità Beta "Made in Italy" per arredare la tua officina

Organizzazione

Una postazione organizzata in maniera razionale consente di ottimizzare il lavoro



Modularità

Officina componibile in base ai vostri spazi e alle vostre esigenze

Design

Finiture ricercate ed accattivanti per rendere il posto di lavoro un ambiente ordinato e gradevole





MADE IN ITALY

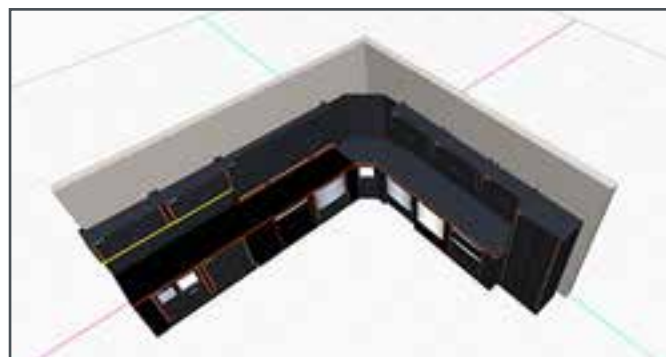

Configura on-line la tua officina
Vai su **www.rsc55.com**



L'officina con i tuoi colori!

RSC55 ti offre la possibilità di ordinare i banchi e la parete con tapparella in versione neutra (grigia) e di completare la tua personalizzazione con gli inserti colorati verticali da ordinare tra 7 differenti nastri adesivi.

**1. Ordina i tuoi moduli
con colorazione neutra**

2. Ordina l'inserto verticale

Scegli il colore secondo i tuoi gusti o in base ai colori sociali della tua azienda

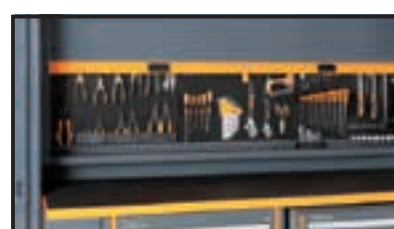

Combinazione completa composta da:

- Armadio ad 1 anta (C55A1)
- Armadio a 2 ante (C55A2)
- Banco da lavoro (C55BO/2)
- Banco da lavoro con prese (C55PRO BO/2)
- Cassettiera mobile con 7 cassetti (C55C7)
- Modulo fisso con 2 cassettoni (C55M2)
- Modulo fisso con 7 cassetti (C55M7)
- Modulo fisso di servizio (C55MS)
- Parete con pensili (C55/2PM)
- Parete portautensili con tapparella (C55PS-O)

C55AB

combinazione arredo officina

Combinazione composta da:

- Armadio a 2 ante (C55A2)
- Banco da lavoro (C55BO/2)
- Modulo fisso con 7 cassetti (C55M7)
- Modulo fisso di servizio (C55MS)
- Parete con pensili (C55/2PM)

407 kg



C55AB

1 055000020



C55PB/3

combinazione arredo officina

Combinazione composta da:

- Banco da lavoro (C55BO/2)
- Cassettiera mobile con 8 cassetti (C55C8)
- Modulo fisso con 2 cassettoni (C55M2)
- Parete portautensili con tapparella (C55PS-O)

334 kg



C55PB/3

1 055000035



C55B/2

banco da lavoro da 2 metri per arredo officina

Con piano da lavoro 2050x700 mm rivestito da uno strato di PVC antiurto e antigraffio resistente agli idrocarburi

- Fori per la collocazione di una morsa 1599F/150 (da ordinare separatamente)
- Piedini regolabili in altezza

📦 105 kg

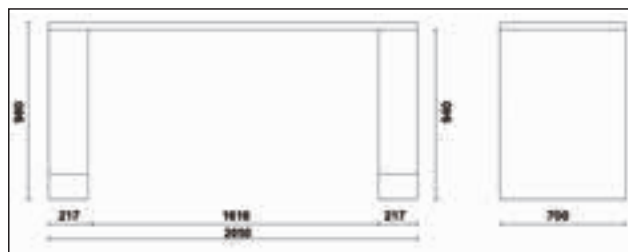
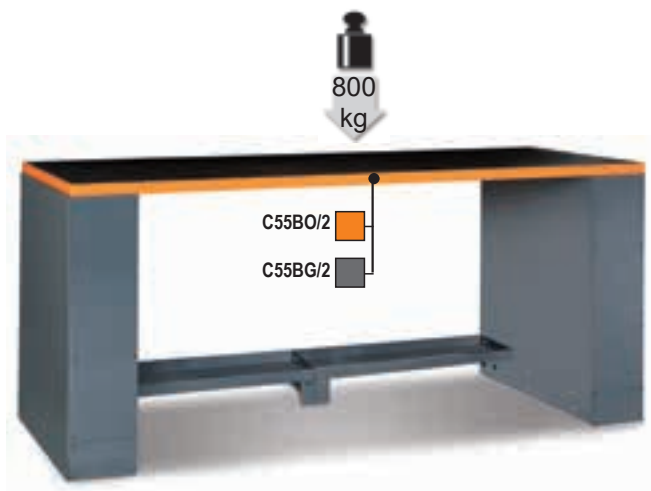

C55BO/2	1	055000101
C55BG/2	1	055000111

C55PRO B/2

banco da lavoro da 2 metri per arredo officina

Con piano da lavoro 2050x700 mm rivestito da uno strato di PVC antiurto e antigraffio resistente agli idrocarburi

Prese elettriche e arrotolatore integrati:

- Presa Schuko+16+10A
- Presa EU Plug 10A
- Presa per aria compressa con arrotolatore da Ø 8 mm, lunghezza tubo: 10 m.
- Fori per la collocazione di una morsa Art. 1599F/150 (da ordinare separatamente)
- Piedini regolabili in altezza

📦 110 kg

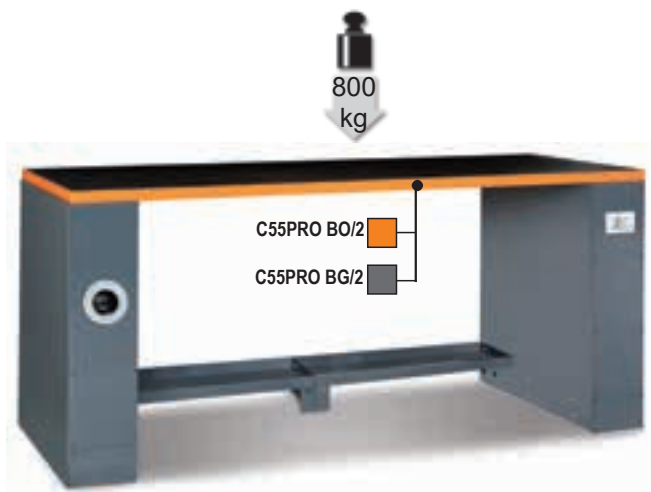

C55PRO BO/2	1	055000151
C55PRO BG/2	1	055000171

C55B/2,8

banco da lavoro da 2,8 metri per arredo officina

Con piano da lavoro 2850x700 mm rivestito da uno strato di PVC antiurto e antigraffio resistente agli idrocarburi

- Fori per la collocazione di una morsa 1599F/150 (da ordinare separatamente)
- Piedini regolabili in altezza

129 kg

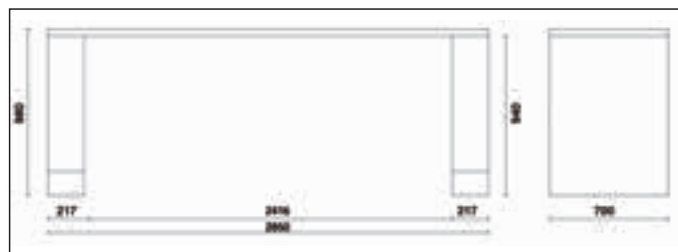
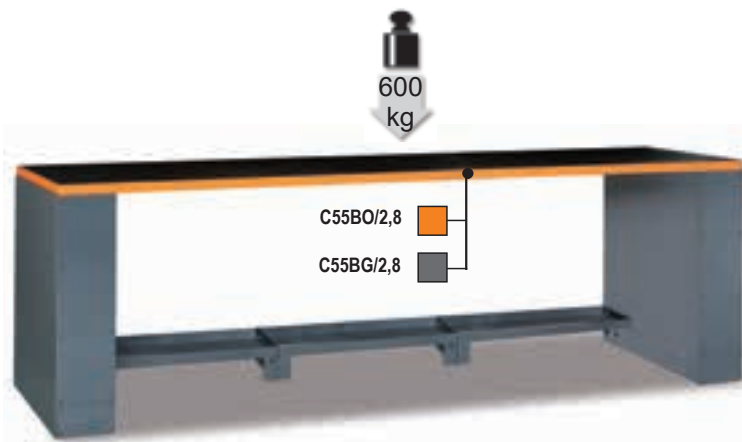

C55BO/2,8	1	055000261
C55BG/2,8	1	055000281

C55PRO B/2,8

banco da lavoro da 2,8 metri per arredo officina

Con piano da lavoro 2850x700 mm rivestito da uno strato di PVC antiurto e antigraffio resistente agli idrocarburi

Prese elettriche e arrotolatore integrati:

- Presa Schuko+16+10A
- Presa EU Plug 10A
- Presa per aria compressa con arrotolatore da Ø 8 mm, lunghezza tubo: 10 m.
- Fori per la collocazione di una morsa Art. 1599F/150 (da ordinare separatamente)
- Piedini regolabili in altezza

134 kg

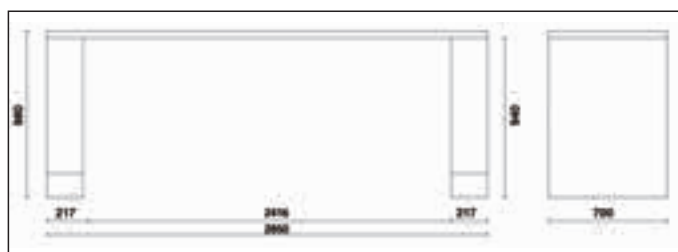
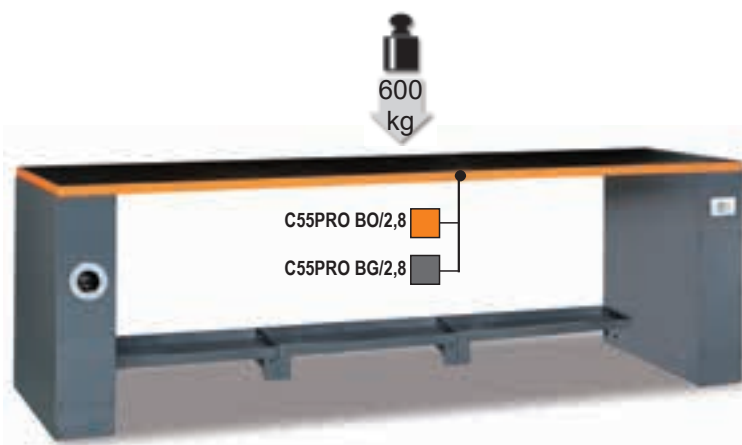

C55PRO BO/2,8	1	055000271
C55PRO BG/2,8	1	055000283

C55B-D4

banco da lavoro doppio da 4 metri con gamba centrale

Con piano da lavoro 4100x700 mm rivestito da uno strato di PVC antiurto e antigraffio resistente agli idrocarburi

- Fori per la collocazione di una morsa 1599F/150 (da ordinare separatamente)
- Piedini regolabili in altezza
- Gamba doppia centrale con vano-portaoggetti e sportello di chiusura 365x750 mm

185 kg

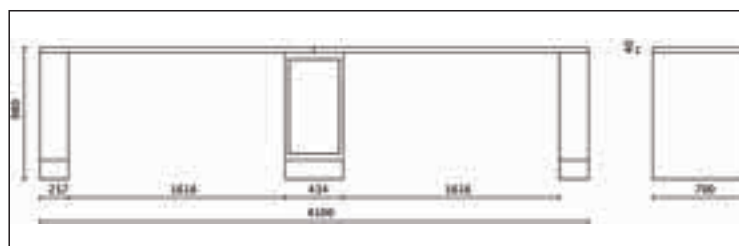
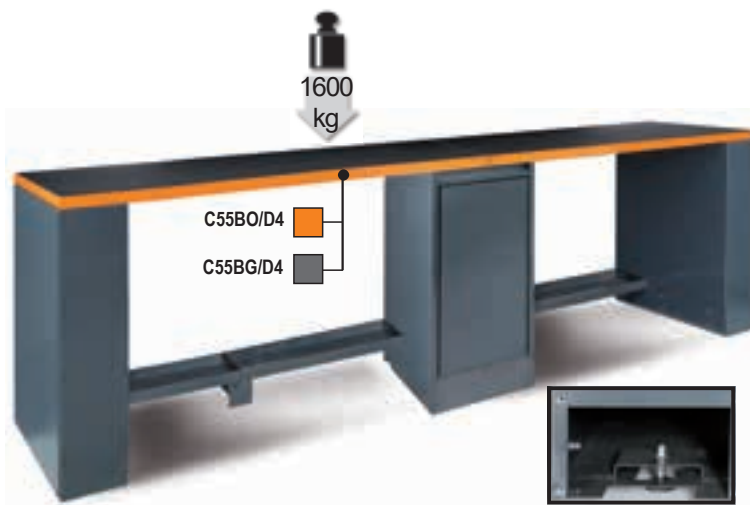

C55BO-D4	1	055000109
C55BG-D4	1	055000119

C55PRO B-D4

banco da lavoro doppio da 4 metri con gamba centrale

Con piano da lavoro 4100x700 mm rivestito da uno strato di PVC antiurto e antigraffio resistente agli idrocarburi

Prese elettriche e arrotolatore integrati:

- Presa Schuko+16+10A
- Presa EU Plug 10A
- Presa per aria compressa con arrotolatore da Ø 8 mm, lunghezza cavo: 10 m.
- Fori per la collocazione di una morsa Art. 1599F/150 (da ordinare separatamente)
- Piedini regolabili in altezza
- Gamba doppia centrale con vano-portaoggetti e sportello di chiusura 365x750 mm

190 kg

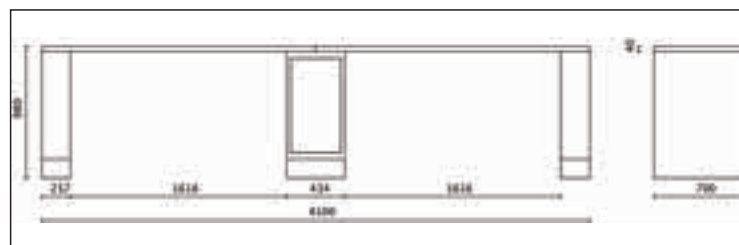
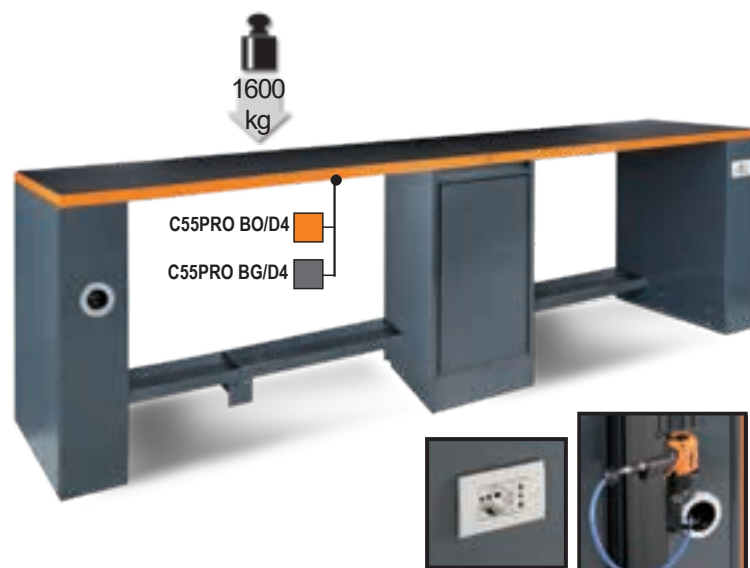

C55PRO-BO-D4	1	055000159
C55PRO-BG-D4	1	055000179

Beta

C55B/G

gamba universale per banco da lavoro arredo officina

- Dotata di piedini regolabili in altezza
- Accesso frontale e laterale
- Utilizzabile per entrambi i lati del banco di lavoro

📦 30 kg

C55B/G



1 055000096

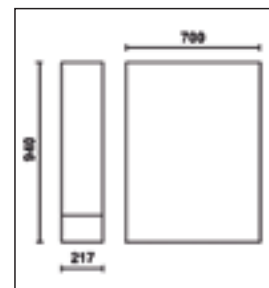

C55B/GAA

gamba universale per banco da lavoro con avvolgitubo integrato

- Avvolgitubo automatico integrato per aria compressa o acqua fredda da Ø 8 mm
- Lunghezza tubo: 10 m
- Dotata di piedini regolabili in altezza
- Accesso frontale e laterale

📦 35 kg

C55B/GAA



1 055000099

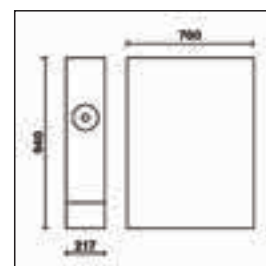

C55B/GDP

gamba doppia per banchi di lavoro adiacenti per arredo officina

- Vano portacarta per rotoli preforati
- Vano portaoggetti con antina
- Dotata di piedini regolabili in altezza

📦 45 kg

C55B/GDP



1 055000292



C55B/GDS

gamba doppia per banchi di lavoro adiacenti per arredo officina

- Vano porta-oggetti con sportello 365x750 mm
- Dotata di piedini regolabili in altezza

📦 45 kg

C55B/GDS



1 055000291

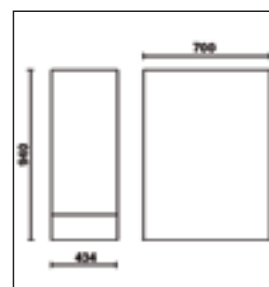

C55B/GE

gamba universale con prese elettriche per banco da lavoro arredo ufficio

- Presa Schuko+16+10A
- Presa EU Plug 10A
- Dotata di piedini regolabili in altezza
- Accesso frontale e laterale

📦 30 kg

C55B/GE

1 055000097

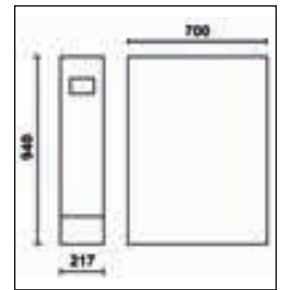

C55B/GAE

gamba universale con avvolgitore elettrico integrato per banco da lavoro arredo ufficio

- Avvolgitore automatico integrato con presa Schuko
- Lunghezza cavo: 15 m
- Con protezione termica
- Dotata di piedini regolabili in altezza
- Accesso frontale e laterale

📦 35 kg

C55B/GAE

1 055000094

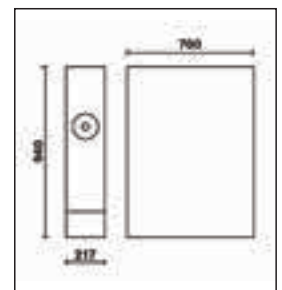
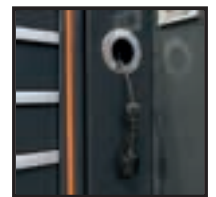

C55/PL-1,024

piano di lavoro da 1 metro per estensione banco

Piano di lavoro in lamiera verniciata 1024x700 mm rivestito da uno strato di PVC antiurto e antigraffio resistente agli idrocarburi

21 kg

C55/PLO-1,024	1	055000130
C55/PLG-1,024	1	055000131



C55B PT/2

piano di lavoro da 2 metri per banco arredo officina

Piano di lavoro in lamiera verniciata 2050x700 mm rivestito da uno strato di PVC antiurto e antigraffio resistente agli idrocarburi
Fori per la collocazione di una morsa 1599F/150 da ordinare separatamente

43 kg

C55B PT/2	1	055000106
C55BG PT/2	1	055000116

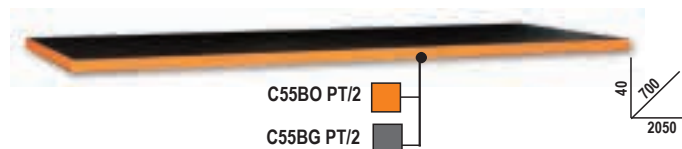

C55B PT/2,8

piano di lavoro da 2,8 metri per banco arredo officina

Piano di lavoro in lamiera verniciata 2850x700 mm rivestito da uno strato di PVC antiurto e antigraffio resistente agli idrocarburi
Fori per la collocazione di una morsa 1599F/150 da ordinare separatamente

61 kg

C55BO PT/2,8	1	055000266
C55BG PT/2,8	1	055000286



C55RB

rivestimento in PVC antiurto antigraffio resistente agli idrocarburi

per proteggere il piano di lavoro.
C55RB/2: per banco da 2 metri
C55RB/2,8: per banco da 2,8 metri
C55RB/0,7: per banco da 700x700mm
C55RB/1: per banco da 1 metro



C55RB/2	1	055000195
C55RB/2,8	1	055000196
C55RB/0,7	1	055000199
C55RB/1	1	055000198

C55B/VS

staffa inferiore sostegno banchi

Misure 800x230x60 mm

4 kg

C55B/VS	1	055000095
---------	---	-----------

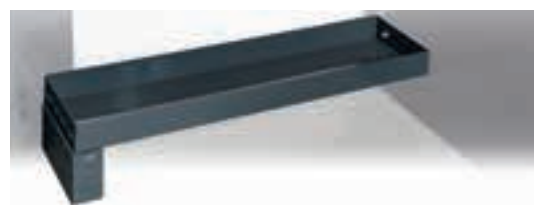

C55C7

cassettiera mobile con 7 cassetti per arredo officina

7 cassetti da 588x367 mm, montati su guide telescopiche a sfera

- 4 ruote Ø 100 mm, 2 fisse e 2 girevoli (una con freno)
- Sistema di apertura in alluminio posizionato su tutta la lunghezza del cassetto
- Piano dei cassetti protetto da tappetini di gomma espansa
- Serratura centralizzata frontale
- Predisposizione per l'inserimento dei termoformati

79 kg

1000
kg



h	max
70 mm	30 kg
245 mm	40 kg

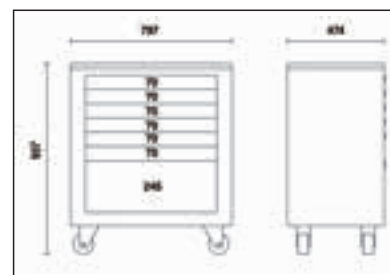

C55C7

1

055000201



C55C8

modulo cassetiera mobile con 8 cassetti per arredo officina

8 cassetti da 588x367 mm, montati su guide telescopiche a sfera

- 4 ruote Ø 100 mm, 2 fisse e 2 girevoli (una con freno)
- Sistema di apertura in alluminio posizionato su tutta la lunghezza del cassetto
- Piano dei cassetti protetto da tappetini di gomma espansa
- Serratura centralizzata frontale
- Predisposizione per l'inserimento dei termoformati

81 kg



h	max
70 mm	30 kg
175 mm	40 kg

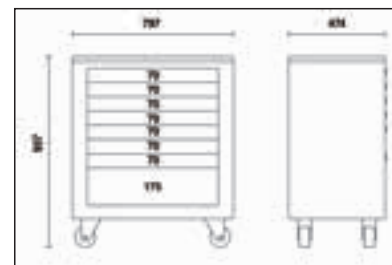

C55C8

1 055000206

C55M2

modulo fisso con 2 cassetti per arredo officina

2 cassetti da 588x367mm, montati su guide telescopiche a sfera

- Sistema di apertura in alluminio posizionato su tutta la lunghezza del cassetto
- Piano dei cassetti protetto da tappetini di gomma espansa
- Serratura centralizzata frontale

66 kg



h	max
280 mm	40 kg
385 mm	40 kg

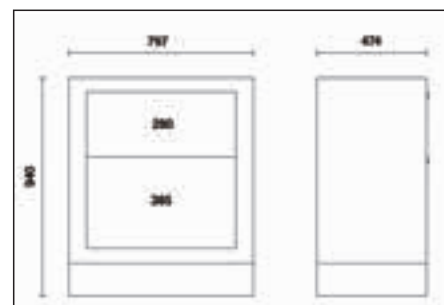

C55M2

1 055000202

C55M4

modulo fisso con 4 cassetti per arredo officina

4 cassetti da 588x367 mm, montati su guide telescopiche a sfera

- Sistema di apertura in alluminio posizionato su tutta la lunghezza del cassetto
- Piano dei cassetti protetto da tappetini di gomma espansa
- Serratura centralizzata frontale

75 kg



h	max
140 mm	30 kg
245 mm	40 kg

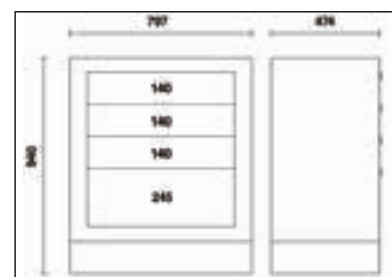

C55M4

1 055000212

C55M7

modulo fisso con 7 cassetti per arredo officina

7 cassetti da 588x367 mm, montati su guide telescopiche a sfera

- Sistema di apertura in alluminio posizionato su tutta la lunghezza del cassetto
- Piano dei cassetti protetto da tappetini digomma espansa
- Serratura centralizzata frontale
- Predisposizione per l'inserimento dei termoformati

78 kg

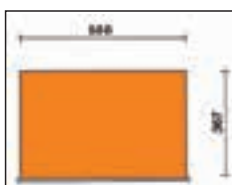

h	max
70 mm	30 kg
245 mm	40 kg

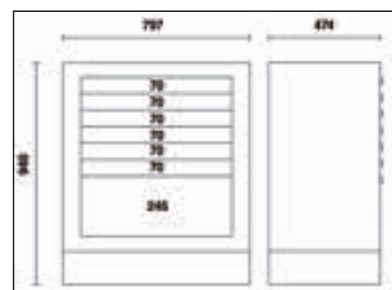

C55M7

1 055000203

C55M8

modulo fisso con 8 cassetti per arredo officina

8 cassetti da 588x367 mm, montati su guide telescopiche a sfera

- Sistema di apertura in alluminio posizionato su tutta la lunghezza del cassetto
- Piano dei cassetti protetto da tappetini digomma espansa
- Serratura centralizzata frontale
- Predisposizione per l'inserimento dei termoformati

📦 78,9 kg



h	max
70 mm	30 kg
175 mm	40 kg

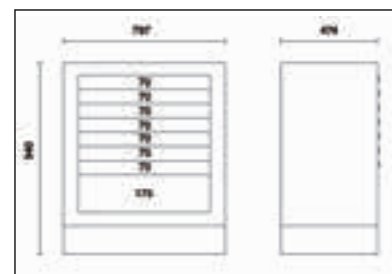

C55M8

📦 1 055000207

C55CS

modulo fisso per rifiuti differenziati per arredo officina

- Vano spazzatura estraibile 588x465 mm montato su guide telescopiche a sfera

- 2 capienti contenitori interni estraibili per differenziare i rifiuti

📦 62 kg

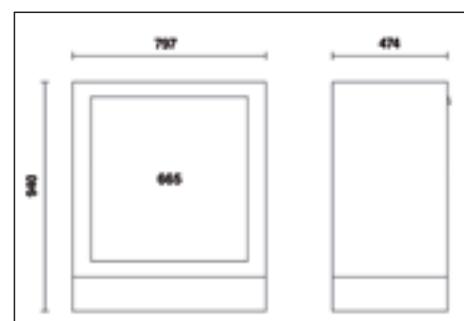

C55CS

📦 1 055000208

C55MA

modulo fisso con due antine per arredo officina

- Sistema di apertura push & pull a pressione
- Dotato di serratura
- Ripiano interno regolabile in altezza

📦 75 kg

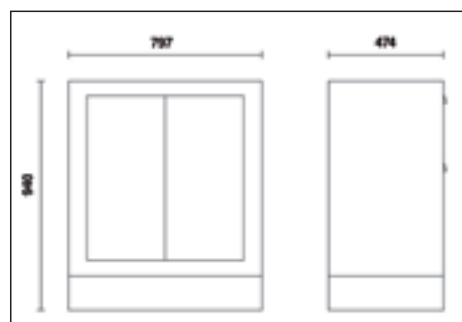

C55MA

1 055000205

C55MDO

Modulo fisso di distribuzione olio per arredo officina

- 2 arrotolatori con tubo flessibile da 7m - 1/2" inclusi
- Completo di 2 pistole con conta litri digitali dotate di salvagoccia automatico.
 - portata max: 35 l/min
 - viscosità: 8÷5000 mPas

📦 94 kg

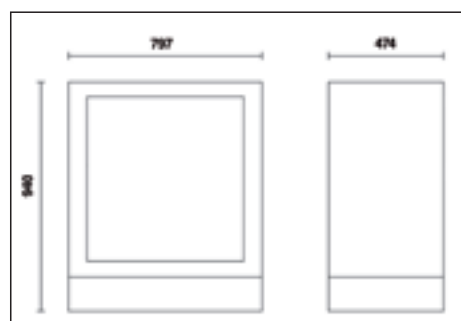

C55MDO

1 055000210

C55MS

modulo fisso di servizio per arredo officina

- Cestino portarifiuti integrato
- Vano portacarta per rotoli preforati
- Cassettone portaoggetti 305x270 mm

📦 75 kg

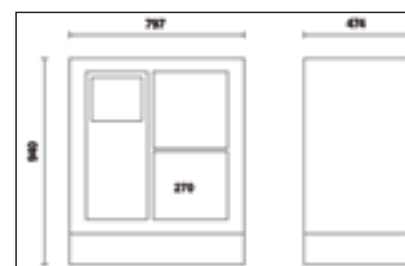

C55MS



1



055000204

C55T3

carrello

- 3 ripiani ricoperti in gomma millerighe antiscivolo
- Maniglia ergonomica
- Doppia possibilità di fissaggio del ripiano centrale
- Quattro ruote girevoli Ø 100 mm (due con freno)
- Capacità di carico statico: 200 kg. (distribuita sui 3 ripiani)

📦 21 kg

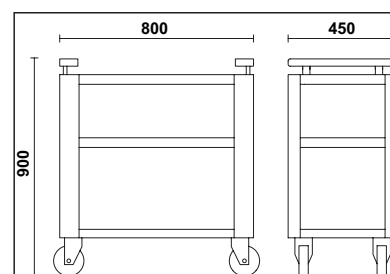

C55T3



1



055000219

C55P/MCD

montanti centrali intermedi doppi

10 kg

C55P/MCD

1 055000257



C55P/2MDX-SX

coppia di montanti DX-SX pareti

10 kg

C55P/2MDX-SX

1 055000253



C55PM

pensile per arredo officina da 1 metro

• Misure 1024x400x300 mm dotato di molle a gas per facilitare l'apertura e la chiusura dell'anta

24 kg

C55PM

1 055000302

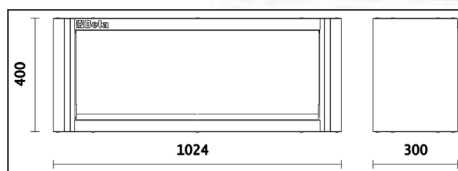

C55PFA-1,0

pannello forato autoportante da 1 metro per arredo officina

Pannello forato in acciaio 1024x1020x25 mm per il sostegno degli utensili

11 kg

C55PFA-1,0

1 055000316



C55/PF

pannello forato sotto pensile per arredo officina da 1 metro

• Pannello forato 1024x620x25 mm per il sostegno degli utensili, da sovrapporre a C55PT1,0x0,6

6 kg

C55/PF

1 055000307



C55PT1,0X0,6

pannello sotto pensile da 1 metro

Misure 1024x620x25 mm

8 kg

C55PT1,0X0,6

1 055000314



C55PTE-1,0

pannello sotto pensile da 1 metro

Misure 1024x620x25 mm

Con predisposizione per 2 prese elettriche (non incluse)

8 kg

C55PTE-1,0

1 055000319



C55/2PM

parete con 2 pensili per arredo ufficio

- 2 pensili 1024x400x300 mm dotati di molle a gas per facilitare l'apertura e la chiusura delle ante.
- 2 pannelli a muro 1024x620 mm con predisposizione per alloggiare pannelli forati portautensili C55/PF (da ordinare separatamente)
- Fornita con struttura portante
- Abbinabile al banco di lavoro da 2 metri.

80 kg

C55/2PM

1 055000301

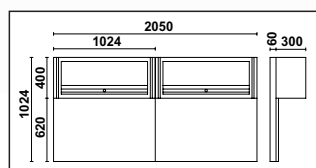

C55PFA-0,8

pannello forato autoportante da 0,8 metri per arredo officina

Pannello forato in acciaio 800x1020x25 mm per il sostegno degli utensili

10 kg

C55PFA-0,8

1

055000315



C55PM/M0,8

Pensile 0,8 metri per arredo officina

Misure 800x400x300 mm dotato di molle a gas per facilitare l'apertura e la chiusura dell'anta

19 kg

C55PM/M0,8

1

055000312

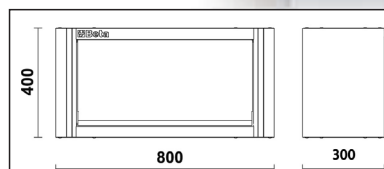

C55PTE-0,8

pannello sotto pensile da 0,8 metri

Misure 800x620x25 mm

Con predisposizione per 1 presa elettrica (non inclusa)

6 kg

C55PTE-0,8

1

055000318



C55PT0,8X0,6

pannello sotto pensile da 0,8 metri

Misure 800x620x25 mm

7,8 kg

C55PT0,8X0,6

1

055000313



C55/1PF

pannello forato portautensili per arredo officina

• Pannello forato 800x620x25 mm per il sostegno degli utensili

5 kg

C55/1PF

1

055000309



C55PS

parete portautensili con tapparella per arredo officina

- Tapparella in alluminio, manovrabile verticalmente, con serratura
- Pannello forato amovibile per il sostegno degli utensili
- Fornita con struttura portante
- Kit di 50 ganci GPS incluso
- Abbinabile al banco di lavoro da 2 metri.

88 kg

C55PS-O	1	055000250
C55PS-G	1	055000255

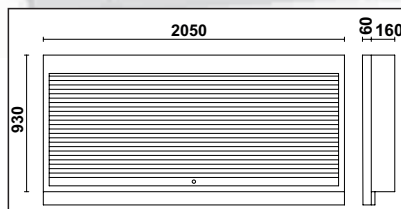

C55PSE

parete portautensili con tapparella e predisposizione per 2 prese elettriche

- Tapparella in alluminio, manovrabile verticalmente, con serratura
- Pannello forato amovibile per il sostegno degli utensili
- Fornita con struttura portante
- Kit di 50 ganci GPS incluso
- Con predisposizione per prese elettriche (non incluse)
- Abbinabile al banco di lavoro da 2 metri.

88 kg

C55PSE-O	1	055000258
C55PSE-G	1	055000260

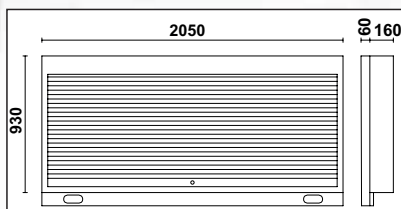
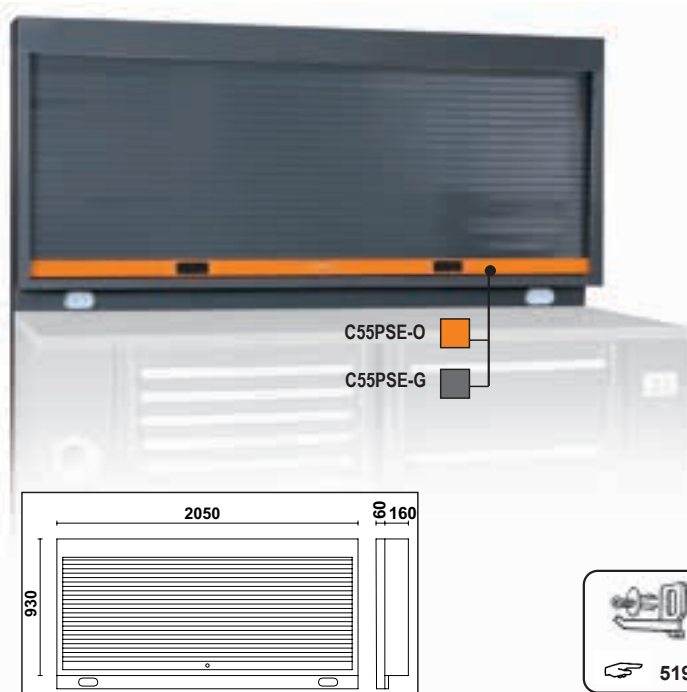

C55AE

profilo 2 metri con predisposizione elettrica

Misure 2050x25x90mm
Con predisposizione per 2 prese elettriche

1,5 kg

C55AE	1	055000325
-------	---	-----------



C55AC

angolo completo autoportante

Piano di lavoro da 700x700 mm con gambe
2 pareti superiori porta utensili complete di 2 mensole per fissaggio 670x160 mm

📦 66 kg

C55AC O	1	055000360
C55AC G	1	055000380

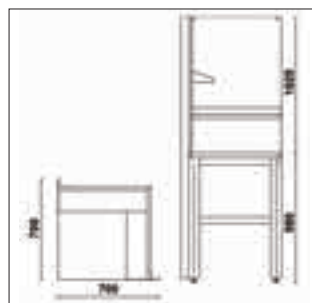

C55AC O
C55AC G

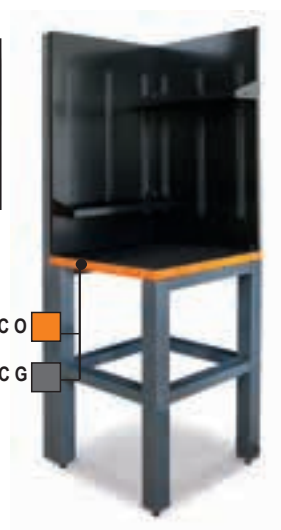

C55KAI

elemento angolare 700x700 con gambe

• Piano di lavoro in lamiera verniciata 700x700 mm rivestito da uno strato di PVC antiurto e antigraffio resistente agli idrocarburi

📦 32 kg

C55KAI O	1	055000365
C55KAI G	1	055000385

C55KAI O
C55KAI G

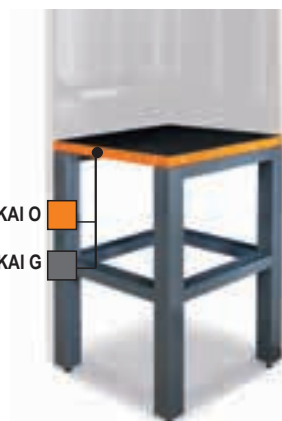

C55KAS

angolo superiore con pareti porta utensili

• 2 Pareti forate 700x1020x25 mm
• 2 Mensole per fissaggio 670x160 mm

📦 24 kg

C55KAS	1	055000370
--------	---	-----------



C55MP

Mensole in acciaio per pareti angolo

Misure 670x160x80 mm

C55MP	1	055000374
-------	---	-----------

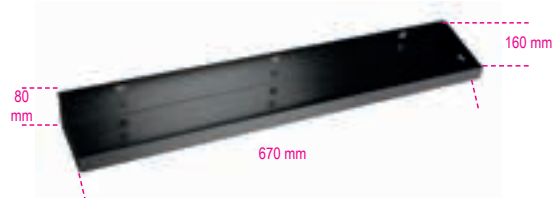

C55B/1

estensione da 1 metro per arredo officina con modulo fisso C55M7

Piano di lavoro 1024x700 mm rivestito da uno strato di PVC antiurto e antigraffio resistente agli idrocarburi

- Gamba universale dotata di piedini regolabili in altezza
- 1 modulo fisso: 7 cassetti da 588x367 mm, montati su guide telescopiche a sfera
- Sistema di apertura in alluminio posizionato su tutta la lunghezza del cassetto
- Piano dei cassetti protetto da tappetini di gomma espansa
- Serratura centralizzata frontale

127 kg



h	max
70 mm	30 kg
245 mm	40 kg

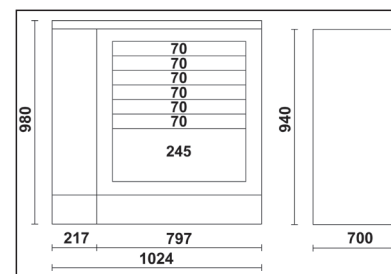

C55BO/1	1	055000090
C55BG/1	1	055000091

C55C

armadietti Cargo linea RSC55

Sono realizzati sulla base di accurate ricerche presso qualificati utilizzatori professionali ed offrono le soluzioni ideali per operare in modo confortevole e razionale.

L'apertura dei pannelli forati delle due antine permette lo sfruttamento anche della loro superficie interna.

Caratteristiche principali:

- 1 cassetto montato su guide telescopiche.
- Possibilità di modificare facilmente la disposizione degli utensili in funzione delle proprie esigenze.
- Posizionamento a parete per mezzo di due asole situate posteriormente.
- Serratura per chiusura contemporanea di antine e cassetto.
- Termoformato vuoto per bussole e accessori da 1/2".

37 kg

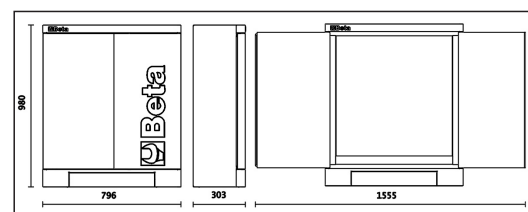

C55C	1	055000400
------	---	-----------

C55A1

armadio in lamiera a un'anta per arredo officina

- 3 ripiani amovibili regolabili in altezza
- Dotato di serratura
- Misure utili interne: 1770x420x420 mm

📦 50 kg



C55A1

1 055000411

C55A1/R42

ripiano interno per armadio C55A1/C55AT1

📦 2,4 kg



C55A1/R42

420x420 mm

1 055000461



Beta

C55A2

armadio in lamiera a due ante per arredo officina

- 3 ripiani amovibili regolabili in altezza
- Dotato di serratura
- Misure utili interne: 1770x700x420 mm

📦 72 kg



C55A2

📦 1 055000412

C55A2/R70

ripiano interno per armadio C55A2/C55AT2

📦 3,5 kg



C55A2/R70

700x420 mm

📦 1 055000462

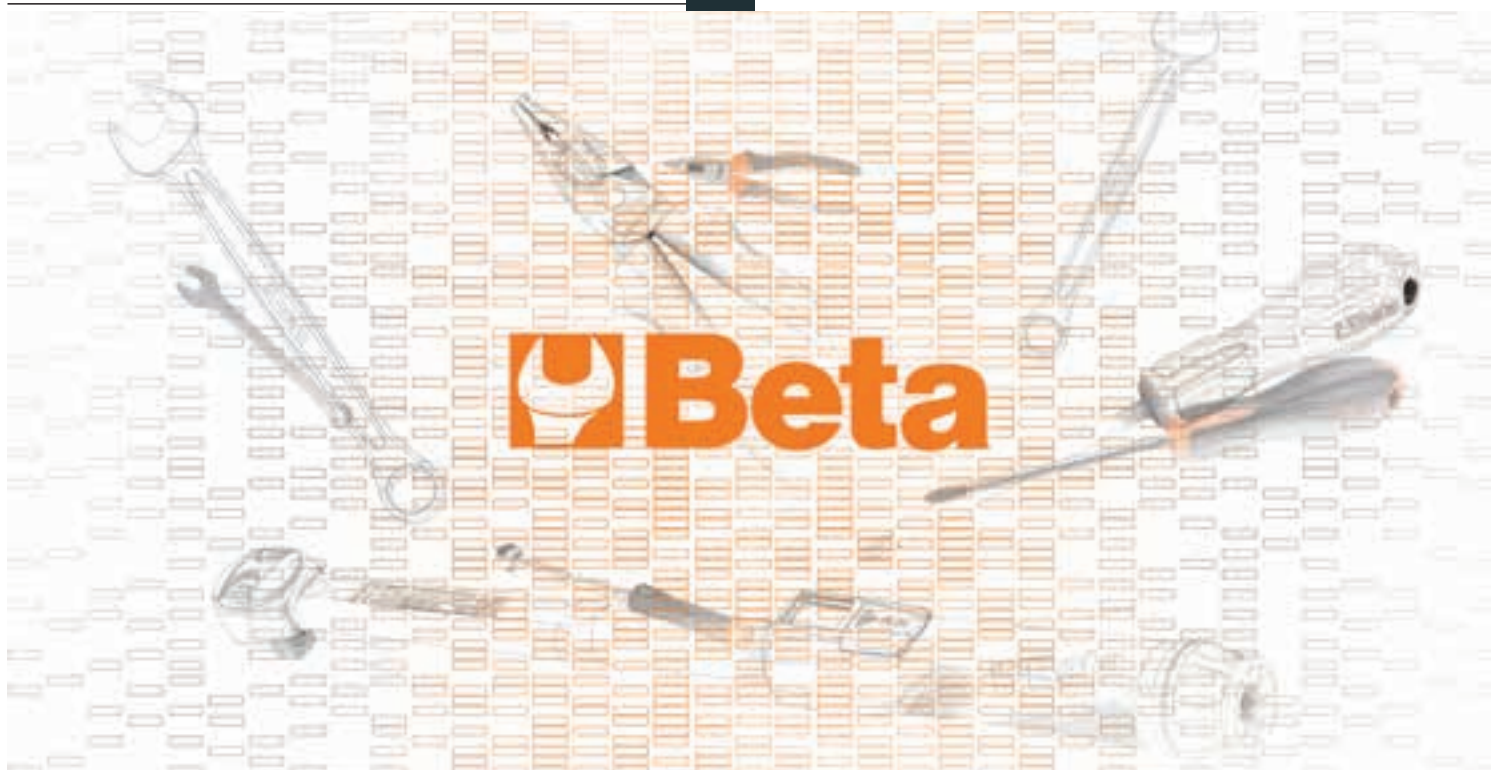

C55AT1

armadio in lamiera con anta trasparente in policarbonato per arredo officina

- 3 ripiani amovibili regolabili in altezza
- Dotato di serratura
- Misure utili interne: 1770x420x420 mm

41 kg

C55AT1

1 055000421



C55AT2

armadio in lamiera con due ante trasparenti in policarbonato per arredo officina

- 3 ripiani amovibili regolabili in altezza
- Dotato di serratura
- Misure utili interne: 1770x700x420 mm

56 kg

C55AT2

1 055000422



C55STR

nastro adesivo colorato 25 m

permette di personalizzare il colore degli inserti verticali dell'arredo officina C55

C55STR-O/2011		1	055000901
C55STR-R/3000		1	055000903
C55STR-V/6029		1	055000906
C55STR-W/9016		1	055000907
C55STR-Y/1023		1	055000905
C55STR-B/5015		1	055000904
C55STR-GO/1035		1	055000909
C55STR-S/9006		1	055000902



PROFESSIONALE ROBUSTO ORDINATO

**NUOVO
DESIGN**

C45PRO è il sistema di arredamento professionale per iniziare a organizzare al meglio il proprio spazio di lavoro.

Il nuovo design e i miglioramenti tecnici apportati alla struttura lo posizionano ad un ottimo rapporto qualità/prezzo.

L'arredo per officina modulare C45PRO permette di creare il proprio ambiente di lavoro in base agli spazi a disposizione e alle esigenze di utilizzo.

È una gamma semplice e flessibile con combinazioni predeterminate che può essere ampliata o modificata nel tempo.

In alternativa è possibile costruire interamente la postazione di lavoro personalizzata partendo dai piani di lavoro - disponibili in MDF rivestito in acciaio inox o in legno multistrato - e completandola con i numerosi componenti e accessori disponibili.

Crea il tuo ambiente di lavoro a tua misura.

Cambia faccia al tuo laboratorio o alla tua officina.

Scegli tra le soluzioni preassemblate o costruisci da zero la tua postazione.



L'ARREDO OFFICINA C45 CAMBIA ABITO E INDOSSA I COLORI BETA!

Configura on-line la tua officina in 3D

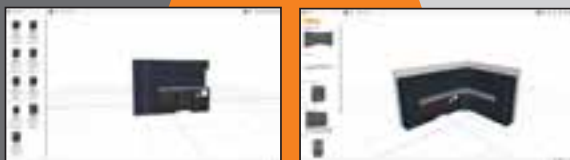

su www.beta-tools.com

C45PRO X

combinazione arredo officina C45PRO

Combinazione composta da:

- Piano di lavoro in MDF rivestito in acciaio inossidabile (C45PX/3-2,0MT)
- Modulo fisso con 7 cassetti (C45PRO M7)
- Modulo fisso di servizio (C45PRO MS)
- Cassettiera mobile con 7 cassetti (C45PRO C7)
- Armadio a 2 ante (C45PRO AS2)
- 3 pannelli forati portautensili (C45PRO PF)
- 3 pensili a muro (C45PRO PM)
- 3 staffe per parete tipo largo (C45PRO SL)
- 1 staffa per parete tipo stretto (C45PRO SS)

📦 305 kg



C45PRO W

combinazione arredo officina C45PRO

Combinazione composta da:

- Piano di lavoro in legno multistrato (C45PW/3-2,0MT)
- Modulo fisso con 7 cassetti (C45PRO M7)
- Modulo fisso di servizio (C45PRO MS)
- Cassettiera mobile con 7 cassetti (C45PRO C7)
- Armadio a 2 ante (C45PRO AS2)
- 3 pannelli forati portautensili (C45PRO PF)
- 3 pensili a muro (C45PRO PM)
- 3 staffe per parete tipo largo (C45PRO SL)
- 1 staffa per parete tipo stretto (C45PRO SS)

📦 303 kg

C45PRO W

1 045000002

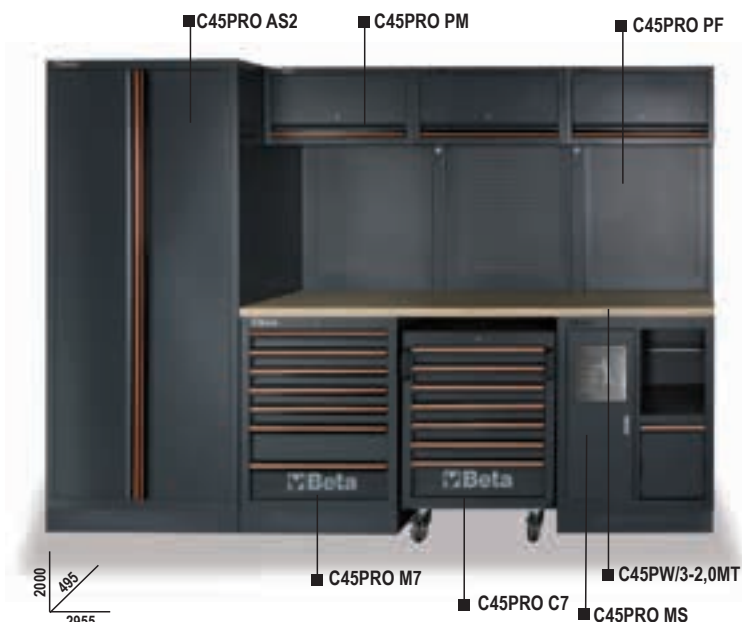

C45PRO AX

combinazione arredo officina C45PRO

Combinazione composta da:

- Piano di lavoro in MDF rivestito in acciaio inossidabile (C45PX/3-2,0MT)
- Modulo fisso con 7 cassetti (C45PRO M7)
- Modulo fisso di servizio (C45PRO MS)
- Modulo fisso con 2 antine (C45PRO MA)
- 3 pensili a muro (C45PRO PM)
- 3 pannelli forati portautensili (C45PRO PF)
- 2 staffe per parete tipo largo (C45PRO SL)
- 2 staffe per parete tipo stretto (C45PRO SS)

📦 206 kg

C45PRO AX

1 045000003



C45PRO AW

combinazione arredo officina C45PRO

Combinazione composta da:

- Piano di lavoro in legno multistrato (C45PW/3-2,0MT)
- Modulo fisso con 2 antine (C45PRO MA)
- Modulo fisso con 7 cassetti (C45PRO M7)
- Modulo fisso di servizio (C45PRO MS)
- 3 pensili a muro (C45PRO PM)
- 3 pannelli forati portautensili (C45PRO PF)
- 2 staffe per parete tipo stretto (C45PRO SS)
- 2 staffe per parete tipo largo (C45PRO SL)

📦 204 kg

C45PRO AW

1 045000004



C45PRO BX

combinazione arredo officina C45PRO

Combinazione composta da:

- Piano di lavoro in MDF rivestito in acciaio inossidabile (C45PX/2-1,3MT)
- Modulo fisso con 5 cassetti (C45PRO M5)
- Modulo fisso con 2 antine (C45PRO MA)
- Armadio a 1 anta (C45PRO AS1)
- 2 pensili a muro (C45PRO PM)
- 2 pannelli forati portautensili (C45PRO PF)
- 2 staffe per parete tipo largo (C45PRO SL)
- 1 staffa per parete tipo stretto (C45PRO SS)

191 kg

C45PRO BX

1 045000021



C45PRO BW

combinazione arredo officina C45PRO

Combinazione composta da:

- Piano di lavoro in legno multistrato (C45PW/2-1,3MT)
- Modulo fisso con 5 cassetti (C45PRO M5)
- Modulo fisso con 2 antine (C45PRO MA)
- Armadio a 1 anta (C45PRO AS1)
- 2 pensili a muro (C45PRO PM)
- 2 pannelli forati portautensili (C45PRO PF)
- 2 staffe per parete tipo largo (C45PRO SL)
- 1 staffa per parete tipo stretto (C45PRO SS)

190 kg

C45PRO BW

1 045000022



C45PRO DX

combinazione arredo officina C45PRO

Combinazione composta da:

- 1 piano di lavoro in MDF rivestito in acciaio inossidabile (C45PX/3-2,0MT)
- 1 piano di lavoro in MDF rivestito in acciaio inossidabile (C45PX/2-1,3MT)
- 1 modulo fisso con 7 cassetti (C45PRO M7)
- 1 cassettiera mobile con 7 cassetti (C45PRO C7)
- 1 modulo fisso di servizio (C45PRO MS)
- 1 modulo fisso con 5 cassetti (C45PRO M5)
- 1 modulo fisso con 2 antine (C45PRO MA)
- 1 angolo completo autoportante con piano di lavoro in MDF rivestito in acciaio inossidabile (C45PRO CORNER/X)
- 5 pannelli forati portautensili (C45PRO PF)
- 5 pensili a muro (C45PRO PM)
- 7 staffe per parete tipo largo (C45PRO SL)
- 2 staffe per parete tipo stretto (C45PRO SS)
- 2 armadi a 1 anta (C45PRO AS1)

572,3 kg

C45PRO DX

1 045000031

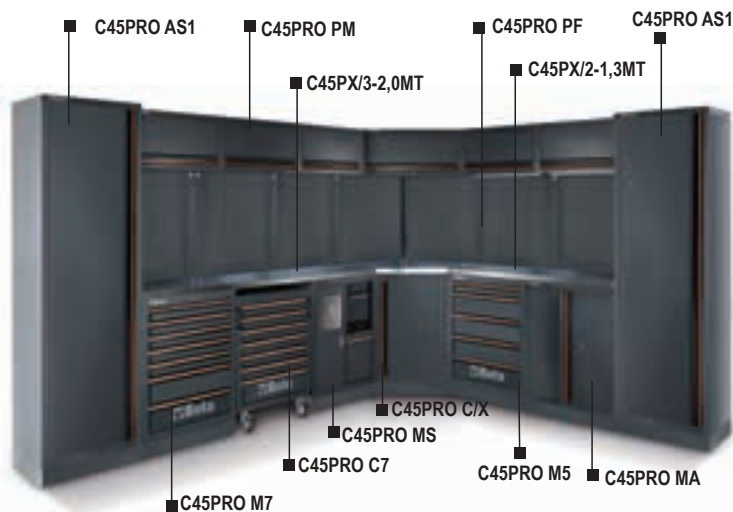

C45PRO DW

combinazione arredo officina C45PRO

Combinazione composta da:

- 1 piano di lavoro in legno multistrato (C45PW/3-2,0MT)
- 1 piano di lavoro in legno multistrato (C45PW/2-1,3MT)
- 1 modulo fisso con 7 cassetti (C45PRO M7)
- 1 cassetiera mobile con 7 cassetti (C45PRO C7)
- 1 modulo fisso di servizio (C45PRO MS)
- 1 modulo fisso con 5 cassetti (C45PRO M5)
- 1 modulo fisso con 2 antine (C45PRO MA)
- 1 angolo completo autoportante con piano di lavoro in legno (C45PRO CORNER/W)
- 5 pannelli forati portautensili (C45PRO PF)
- 5 pensili a muro (C45PRO PM)
- 7 staffe per parete tipo largo (C45PRO SL)
- 2 staffe per parete tipo stretto (C45PRO SS)
- 2 armadi a 1 anta (C45PRO AS1)

■ 568,5 kg

C45PRO DW



1

045000032

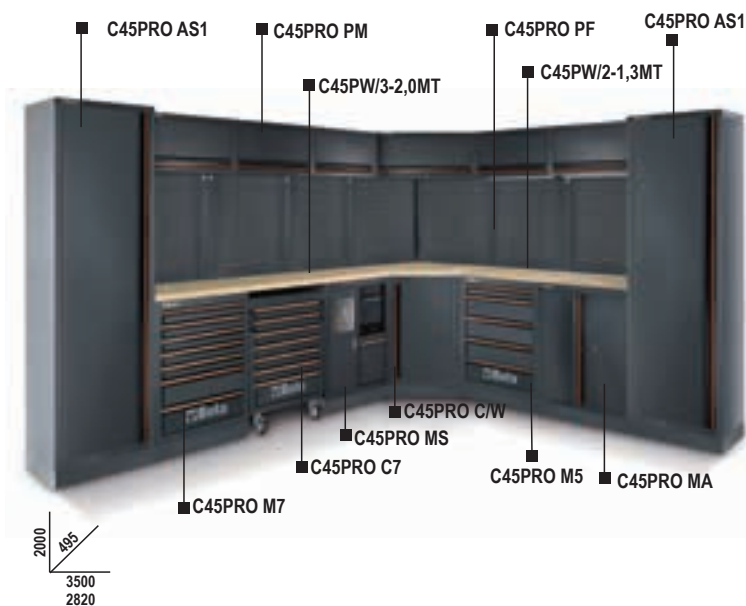

C45PRO EX

combinazione arredo officina C45PRO

Combinazione composta da:

- 2 pannelli forati portautensili (C45PRO PF)
- 2 pensili a muro (C45PRO PM)
- 2 staffe per parete tipo largo (C45PRO SL)
- 1 staffa per parete tipo stretto (C45PRO SS)
- 1 armadio a 1 anta (C45PRO AS1)
- Modulo fisso con 7 cassetti e piano di lavoro in MDF rivestito in acciaio inossidabile (C45PRO M7A/X):
 - 1 cassetto da 1248x406 mm
 - 6 cassetti da 782x406 mm
 - 5 cassetti altezza 65 mm
 - 1 cassetto altezza 145 mm
- 1 vano portaoggetti con ripiano intermedio e antina di chiusura

■ 174,6 kg

C45PRO EX



1

045000033



C45PRO EW

combinazione arredo officina C45PRO

Combinazione composta da:

- 2 pannelli forati portautensili (C45PRO PF)
- 2 pensili a muro (C45PRO PM)
- 2 staffe per parete tipo largo (C45PRO SL)
- 1 staffa per parete tipo stretto (C45PRO SS)
- 1 armadio a 1 anta (C45PRO AS1)
- Modulo fisso con 7 cassetti e piano di lavoro in legno multistrato (C45PRO M7A/W):
 - 1 cassetto da 1248x406 mm
 - 6 cassetti da 782x406 mm
 - 5 cassetti altezza 65 mm
 - 1 cassetto altezza 145 mm
- 1 vano portaoggetti con ripiano intermedio e antina di chiusura

■ 173,6 kg

C45PRO EW



1

045000034



C45PRO CX

combinazione arredo officina C45PRO

Combinazione composta da:

- Piano di lavoro in MDF rivestito in acciaio inossidabile (C45PX/2-1,3MT)
- Modulo fisso con 7 cassetti (C45PRO M7)
- Modulo fisso di servizio (C45PRO MS)
- Armadio a 1 anta (C45PRO AS1)
- 2 pensili a muro (C45PRO PM)
- 2 pannelli forati portautensili (C45PRO PF)
- 2 staffe per parete tipo largo (C45PRO SL)
- 1 staffa per parete tipo stretto (C45PRO SS)

199 kg

C45PRO CX

1 045000023



C45PRO CW

combinazione arredo officina C45PRO

Combinazione composta da:

- Piano di lavoro in legno multistrato (C45PW/2-1,3MT)
- Modulo fisso con 7 cassetti (C45PRO M7)
- Modulo fisso di servizio (C45PRO MS)
- Armadio a 1 anta (C45PRO AS1)
- 2 pensili a muro (C45PRO PM)
- 2 pannelli forati portautensili (C45PRO PF)
- 2 staffe per parete tipo largo (C45PRO SL)
- 1 staffa per parete tipo stretto (C45PRO SS)

198 kg

C45PRO CW

1 045000024



C45PRO BPX-1,3

combinazione banchi arredo officina C45PRO

Combinazione composta da

- Piano di lavoro in MDF rivestito in acciaio inossidabile (C45PX/2-1,3MT)
- Modulo fisso con 7 cassetti (C45PRO M7)
- Modulo fisso con 5 cassetti (C45PRO M5)
- 2 pannelli forati portautensili (C45PRO PF)
- 1 staffa per parete tipo largo (C45PRO SL)
- 2 staffe per parete tipo stretto (C45PRO SS)

140 kg

C45PRO BPX-1,3

1 045000041



C45PRO BPW-1,3

combinazione banchi arredo officina C45PRO

Combinazione composta da:

- Piano di lavoro in legno multistrato (C45PW/2-1,3MT)
- Modulo fisso con 7 cassetti (C45PRO M7)
- Modulo fisso con 5 cassetti (C45PRO M5)
- 2 pannelli forati portautensili (C45PRO PF)
- 1 staffa per parete tipo largo (C45PRO SL)
- 2 staffe per parete tipo stretto (C45PRO SS)

139 kg

C45PRO BPW-1,3

1 045000051



C45PRO BPX-2,0

combinazione banchi arredo officina C45PRO

Combinazione composta da:

- Piano di lavoro in MDF rivestito in acciaio inossidabile (C45PX/3-2,0MT)
- Modulo fisso con 7 cassetti (C45PRO M7)
- Modulo fisso con 5 cassetti (C45PRO M5)
- 3 pannelli forati portautensili (C45PRO PF)
- 2 staffe per parete tipo largo (C45PRO SL)
- 2 staffe per parete tipo stretto (C45PRO SS)

158 kg

C45PRO BPX-2,0

1 045000042



C45PRO BPW-2,0

combinazione banchi arredo officina C45PRO

Combinazione composta da:

- Piano di lavoro in legno multistrato (C45PW/3-2,0MT)
- Modulo fisso con 7 cassetti (C45PRO M7)
- Modulo fisso con 5 cassetti (C45PRO M5)
- 3 pannelli forati portautensili (C45PRO PF)
- 2 staffe per parete tipo largo (C45PRO SL)
- 2 staffe per parete tipo stretto (C45PRO SS)

156 kg

C45PRO BPW-2,0

1 045000052



C45PRO M7A/X

modulo fisso con 7 cassetti per arredo officina C45PRO

- Piano di lavoro da 1360 mm in MDF rivestito in acciaio inossidabile
- 1 cassetto da 1248x406 mm, montato su guide telescopiche a sfera
- 6 cassetti da 782x406 mm, montati su guide telescopiche a sfera:
 - 5 cassetti altezza 65 mm
 - 1 cassetto altezza 145 mm
- Piano dei cassetti protetto da tappetini di gomma espansa
- Serratura centralizzata frontale
- Dotato di piedini regolabili in altezza
- Predisposizione per l'inserimento dei termoformati
- 1 vano portaoggetti con ripiano intermedio e antina di chiusura, misure interne 504x424x597 mm

81 kg

C45PRO M7A/X

1 045000161



h	max
65 mm	25 kg
105 mm	40 kg
145 mm	30 kg

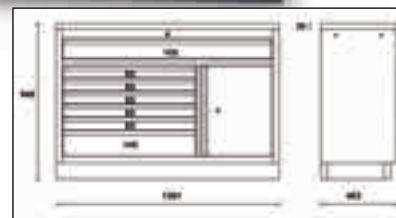

C45PRO M7A/W

modulo fisso con 7 cassetti per arredo officina C45PRO

- Piano di lavoro da 1360mm in legno multistrato
- 1 cassetto da 1248x406 mm, montato su guide telescopiche a sfera
- 6 cassetti da 782x406 mm, montati su guide telescopiche a sfera:
 - 5 cassetti altezza 65 mm
 - 1 cassetto altezza 145 mm
- Piano dei cassetti protetto da tappetini di gomma espansa
- Serratura centralizzata frontale
- Dotato di piedini regolabili in altezza
- Predisposizione per l'inserimento dei termoformati
- 1 vano portaoggetti con ripiano intermedio e antina di chiusura, misure interne 504x424x597 mm

80 kg

C45PRO M7A/W

1 045000171



h	max
65 mm	25 kg
105 mm	40 kg
145 mm	30 kg

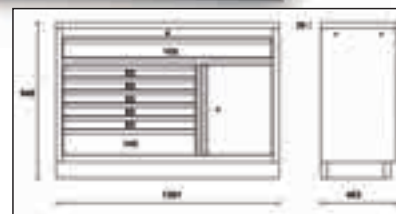

C45PRO MWS/X

cassettiera mobile Work Station con 7 cassetti e cestino portarifiuti integrato

- Piano di lavoro da 1680 mm in MDF rivestito in acciaio inossidabile
- 1 cassetto da 1248x406 mm, montato su guide telescopiche a sfera
- 6 cassetti da 782x406 mm, montati su guide telescopiche a sfera:
 - 5 cassetti altezza 65 mm
 - 1 cassetto altezza 145 mm
- Piano dei cassetti protetto da tappetini di gomma espansa
- Predisposizione per l'inserimento dei termoformati
- Vano portaoggetti con ripiano intermedio e antina di chiusura, misure interne 504x424x597mm
- Cestino portarifiuti integrato
- Supporto portacarta integrato
- 4 ruote Ø 150 mm alta portata, 2 fisse e 2 girevoli con freno
- Serratura centralizzata frontale

126 kg

C45PRO MWS/X

1 045000181



h	max
65 mm	25 kg
105 mm	40 kg
145 mm	30 kg

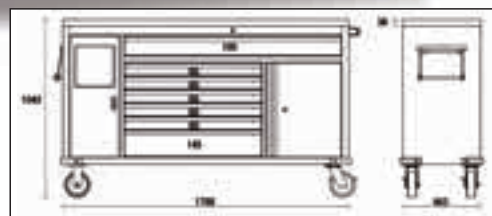

C45PRO MWS/W

cassettiera mobile Work Station con 7 cassetti e cestino portarifiuti integrato

- Piano di lavoro da 1680 mm in legno multistrato
- 1 cassetto da 1248x406 mm, montato su guide telescopiche a sfera
- 6 cassetti da 782x406 mm, montati su guide telescopiche a sfera:
- 5 cassetti altezza 65 mm
- 1 cassetto altezza 145 mm
- Piano dei cassetti protetto da tappetini di gomma espansa
- Predisposizione per l'inserimento dei termoformati
- Vano portaoggetti con ripiano intermedio e antina di chiusura, misure interne 504x424x597mm
- Cestino portarifiuti integrato
- Supporto portacarta integrato
- 4 ruote Ø 150 mm alta portata, 2 fisse e 2 girevoli con freno
- Serratura centralizzata frontale

122 kg

C45PRO MWS/W



1

045000191



h	max
65 mm	25 kg
105 mm	40 kg
145 mm	30 kg

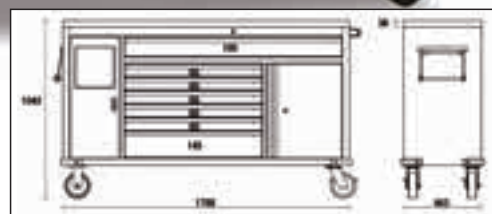

C45PX/1-0,7MT

piano di lavoro in MDF rivestito in acciaio inossidabile 680x463 mm, per banco arredo officina C45PRO

- spessore 38 mm

6 kg

C45PX/1-0,7MT



1

045000101



C45PW/1-0,7MT

piano di lavoro in legno multistrato 680x463 mm, per banco arredo officina C45PRO

- spessore 38 mm

6 kg

C45PW/1-0,7MT



1

045000111



C45PX/2-1,3MT

piano di lavoro in MDF rivestito in acciaio inossidabile 1360x463 mm, per banco arredo officina C45PRO

- spessore 38 mm

21 kg

C45PX/2-1,3MT



1

045000103



C45PW/2-1,3MT

piano di lavoro in legno multistrato 1360x463 mm, per banco arredo officina C45PRO

- spessore 38 mm

20 kg

C45PW/2-1,3MT



1

045000113



C45PX/3-2,0MT

piano di lavoro in MDF rivestito in acciaio inossidabile 2040x463 mm,
per banco arredo officina C45PRO

- spessore 38 mm

📦 31,8 kg

C45PX/3-2,0MT

📦 1 045000110



C45PW/3-2,0MT

piano di lavoro in legno multistrato 2040x463 mm,
per banco arredo officina C45PRO

- spessore 38 mm

📦 30 kg

C45PW/3-2,0MT

📦 1 045000120



C45PRO C5

cassettiera mobile con 5 cassetti per arredo officina C45PRO

- 5 cassetti da 532x406 mm, montati su guide telescopiche a sfera
- 4 ruote girevoli Ø 100 mm (2 con freno)
- Piano dei cassetti protetto da tappetini di gomma espansa
- Serratura centralizzata frontale
- Predisposizione per l'inserimento dei termoformati
- Maniglie integrate nella struttura per una facile movimentazione

📦 46 kg

C45PRO C5

📦 1 045000225

h	max
65 mm	25 kg
145 mm	30 kg

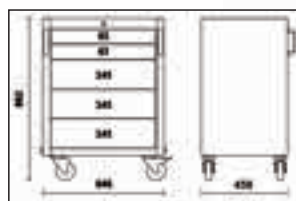
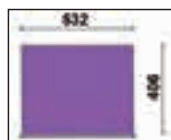

C45PRO C7

cassettiera mobile con 7 cassetti per arredo officina C45PRO

- 7 cassetti da 532x406 mm, montati su guide telescopiche a sfera
- 4 ruote girevoli Ø 100 mm (2 con freno)
- Piano dei cassetti protetto da tappetini di gomma espansa
- Serratura centralizzata frontale
- Predisposizione per l'inserimento dei termoformati
- Maniglie integrate nella struttura per una facile movimentazione

📦 50 kg

C45PRO C7

📦 1 045000227

h	max
65 mm	25 kg
145 mm	30 kg

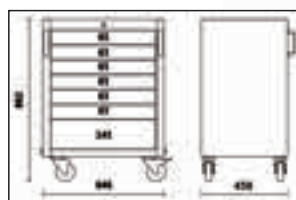
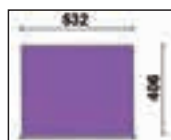

C45PRO M4

modulo fisso con 4 cassetti per arredo officina C45PRO

- 4 cassetti da 566x406 mm, montati su guide telescopiche a sfera
- Piano dei cassetti protetto da tappetini di gomma espansa
- Serratura centralizzata frontale
- Dotato di piedini regolabili in altezza
- Predisposizione per l'inserimento dei termoformati

📦 45,7 kg

h	max
65 mm	25 kg
145 mm	30 kg
225 mm	30 kg

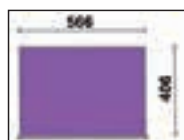

C45PRO M4



1



045000234

C45PRO M5

modulo fisso con 5 cassetti per arredo officina C45PRO

- 5 cassetti da 566x406 mm, montati su guide telescopiche a sfera
- Piano dei cassetti protetto da tappetini di gomma espansa
- Serratura centralizzata frontale
- Dotato di piedini regolabili in altezza
- Predisposizione per l'inserimento dei termoformati

📦 49,3 kg

h	max
65 mm	25 kg
145 mm	30 kg

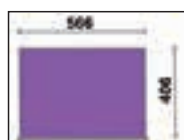

C45PRO M5



1



045000235

C45PRO M7

modulo fisso con 7 cassetti per arredo officina C45PRO

- 7 cassetti da 566x406 mm, montati su guide telescopiche a sfera
- Piano dei cassetti protetto da tappetini di gomma espansa
- Serratura centralizzata frontale
- Dotato di piedini regolabili in altezza
- Predisposizione per l'inserimento dei termoformati

📦 54,3 kg

h	max
65 mm	25 kg
145 mm	30 kg

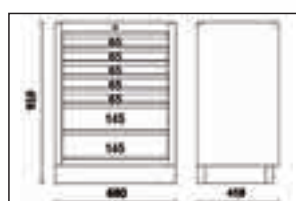
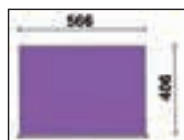

C45PRO M7



1





045000237

C45PRO M8

modulo fisso con 8 cassetti per arredo officina C45PRO

- 8 cassetti da 566x406 mm, montati su guide telescopiche a sfera
- Piano dei cassetti protetto da tappetini di gomma espansa
- Serratura centralizzata frontale
- Dotato di piedini regolabili in altezza
- Predisposizione per l'inserimento dei termoformati

📦 56,5 kg

	
65 mm	25 kg
145 mm	30 kg

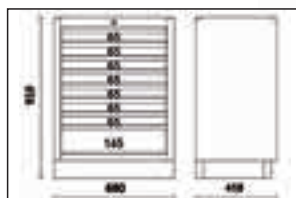
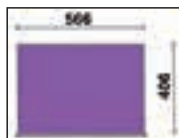

C45PRO M8

 1  045000238

C45PRO MS

modulo fisso di servizio per arredo officina C45PRO

- Cestino portarifiuti integrato
- Vano portacarta per rotoli preforati
- Dotato di piedini regolabili in altezza

📦 37 kg

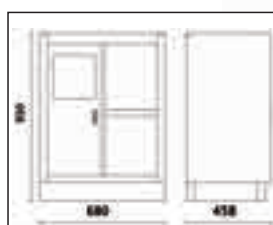

C45PRO MS

 1  045000239

C45PRO RD

modulo fisso raccolta differenziata per arredo officina C45PRO

La soluzione ideale per la raccolta differenziata dei rifiuti (vetro, carta, plastica...)

- **Piano di lavoro a scelta** tra la versione in acciaio inossidabile (X) oppure in legno multistrato (W)
- Solida struttura in lamiera completa di 4 contenitori con antina basculante per raccogliere i rifiuti separatamente
- Ogni contenitore è dotato di:
 - un cestino in plastica removibile, capacità 25 litri
 - 4 ruote girevoli Ø60 mm
- Kit 4 adesivi colorati inclusi nella confezione
- Dotato di piedini regolabili in altezza

📦 80 kg



C45PRO RD/X



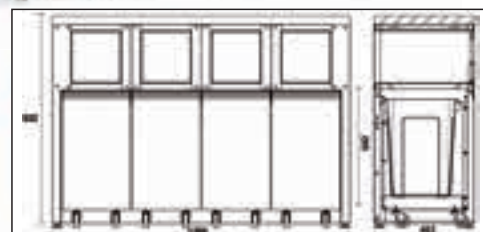

C45PRO RD/W



C45PRO RD/X

 1  045000241

C45PRO RD/W

 1  045000240

C45PRO MA

modulo fisso con 2 antine per arredo officina C45PRO

- Dotato di serratura
- Ripiano interno regolabile in altezza
- Misure interne 670x420 mm
- Dotato di piedini regolabili in altezza

📦 29,4 kg

C45PRO MA



1



045000232

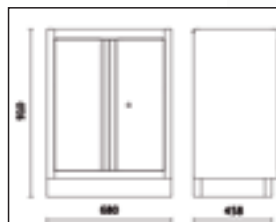

C45PRO M3A

modulo fisso con 3 cassetti e 2 antine per arredo officina C45PRO

- 3 cassetti da 566x406 mm, montati su guide telescopiche a sfera
- Piano dei cassetti protetto da tappetini di gomma espansa
- Predisposizione per l'inserimento dei termoformati
- Serratura centralizzata frontale
- Vano portaoggetti con doppia antina e serratura (misure interne 670x440 mm), completo di ripiano intermedio
- Dotato di piedini regolabili in altezza

📦 40 kg

C45PRO M3A



1



045000231

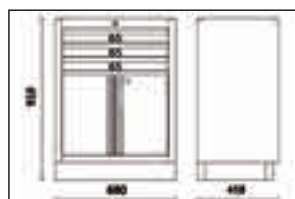

C45PRO ML

modulo fisso con lavandino integrato per arredo officina C45PRO

Caratteristiche tecniche:

- Vasca in acciaio inossidabile
- Fornito completo di:
 - 1 rubinetto miscelatore
 - 1 gruppo di scarico
 - 1 tappo di chiusura
 - 1 tappo filtro
 - 1 erogatore per sapone

Modulo fisso con due antine dotato di serratura:

- Misure utili interne 600x603x416 mm
- Dotato di piedini regolabili in altezza

📦 44 kg

C45PRO ML



1



045000233

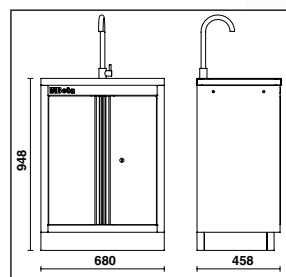

C45PRO ACT



modulo fisso con 3 cassetti e 2 arrotolatori integrati per arredo officina C45PRO

- 3 cassetti da 566x406 mm, montati su guide telescopiche a sfera
- Piano dei cassetti protetto da tappetini di gomma espansa
- Serratura centralizzata frontale
- Dotato di piedini regolabili in altezza

Fornito completo di:

- 1 avvolgitubo per aria compressa o acqua fredda integrato da 8 mm, lunghezza 10m art 1900S 8x10
- 1 avvolgitore elettrico integrato, lunghezza 15m, art 1844 15-H05

47 kg

	
65 mm	25 kg
145 mm	30 kg

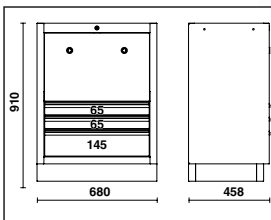
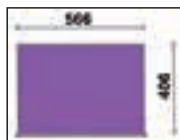

C45PRO ACT



1 045000247

C45PRO TC

modulo fisso per arrotolatori con 3 cassetti per arredo officina C45PRO, vuoto

- 3 cassetti da 566x406 mm, montati su guide telescopiche a sfera
- Piano dei cassetti protetto da tappetini di gomma espansa
- Serratura centralizzata frontale
- Dotato di piedini regolabili in altezza
- **Predisposizione per l'inserimento di 2 arrotolatori a scelta tra:**
 - 2 avvolgitubo per aria compressa o acqua fredda da 8 mm, lunghezza 10m art 1900S 8x10
 - 2 avvolgitori elettrici a scelta tra i seguenti articoli: 1843 15-H05, 1844 10-H05, 1844 15-H05, 1844 15-H07, 1845 12-H05, 1846 10-H05, 1846 10-H07 e 1846 15-H05
 - 1 avvolgitubo per aria compressa o acqua fredda da 8 mm, lunghezza 10m art 1900S 8x10 e 1 avvolgitore elettrico a scelta tra gli articoli sopra elencati

38 kg

	
65 mm	25 kg
145 mm	30 kg

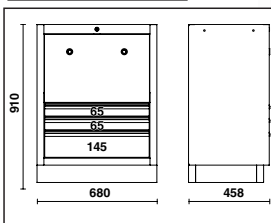
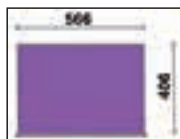

C45PRO TC

1 045000249

C45PRO T3

carrello a 3 ripiani per arredo officina C45PRO

- Quattro ruote girevoli Ø 100 mm (una con freno)
- Capacità di carico statico: 200 kg. (distribuita sui 3 ripiani)

19,2 kg

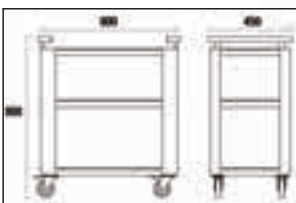

C45PRO T3

1 045000250

C45PRO SS

staffe laterali per parete tipo stretto per C45PRO

• Misure 1420x32,5x30 mm

📦 1,5 kg



C45PRO SS



1



045000333

C45PRO SL

staffe laterali per parete tipo largo per C45PRO

• Misure 1420x65x30 mm

📦 2 kg



C45PRO SL



1



045000366

C45PRO PAS

parete portautensili per arredo officina C45PRO

- Tapparella in alluminio, manovrabile verticalmente, con serratura
- Due pannelli forati amovibili per il sostegno degli utensili
- Abbinabile al banco di lavoro da 1,3 metri

📦 48,8 kg

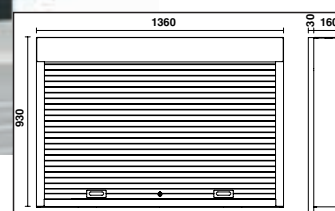

C45PRO PAS



1



045000290

C45PRO PF

pannello forato portautensili per arredo officina C45PRO

• Misure 1052x614,5x24 mm

📦 5,3 kg



C45PRO PF



1



045000313

C45PRO PFE

pannello forato portautensili per arredo officina C45PRO

- Misure 1052x614,5x24 mm
- Con predisposizione per 1 presa elettrica (non inclusa)

5,3 kg



C45PRO PFE

1 045000312

C45PRO CORNER/X

angolo completo autoportante per arredo officina C45PRO

- Pensile ad angolo con serratura dotato di molle a gas per facilitare l'apertura e la chiusura dell'anta
- 2 pannelli forati 1052x860 mm per il sostegno degli utensili
- Piano di lavoro angolare in MDF rivestito in acciaio inossidabile da 860 x 860 mm
- Modulo inferiore angolare con ampio vano porta-oggetti
- Dotato di piedini regolabili in altezza

94 kg

C45PRO CORNER/X

1 045000401

C45PRO CORNER/W

angolo completo autoportante per arredo officina C45PRO

- Pensile ad angolo con serratura dotato di molle a gas per facilitare l'apertura e la chiusura dell'anta
- 2 pannelli forati 1052x860 mm per il sostegno degli utensili
- Piano di lavoro angolare in legno multistrato da 860 x 860 mm
- Modulo inferiore angolare con ampio vano porta-oggetti
- Dotato di piedini regolabili in altezza

93 kg

C45PRO CORNER/W

1 045000411



C45PRO CAI/X

modulo inferiore angolare per arredo officina C45PRO

- Piano di lavoro angolare in MDF rivestito in acciaio inossidabile da 860x860 mm
- Modulo fisso angolare con ampio vano porta-oggetti
- Dotato di piedini regolabili in altezza

📦 62 kg

C45PRO CAI/X

1 045000412



C45PRO CAI/W

modulo inferiore angolare per arredo officina C45PRO

- Piano di lavoro angolare in legno multistrato da 860x860 mm
- Modulo fisso angolare con ampio vano porta-oggetti
- Dotato di piedini regolabili in altezza

📦 56 kg

C45PRO CAI/W

1 045000402



C45PRO PM

pensile a muro per banco arredo officina C45PRO

- Lunghezza pensile 680 mm
- Dotato di molle a gas per facilitare l'apertura e la chiusura dell'anta
- Con serratura

📦 10 kg

C45PRO PM

1 045000302



C45PRO PML

pensile a muro lungo per banco arredo officina C45PRO

- Lunghezza pensile 1360 mm
- Dotato di molle a gas per facilitare l'apertura e la chiusura dell'anta
- Con serratura

📦 18 kg

C45PRO PML

1 045000303



C45PRO AS1

armadio in lamiera a 1 anta con staffa per arredo officina C45PRO

- 4 ripiani amovibili regolabili in altezza
- Dotato di serratura
- Misure interne 590x430 mm
- Dotato di piedini regolabili in altezza

📦 57,5 kg



C45PRO AS1

📦 1 045000451

C45PRO AS2

armadio in lamiera a 2 ante con staffa per arredo officina C45PRO

- 4 ripiani amovibili regolabili in altezza
- Dotato di serratura
- Misure interne 910x430 mm
- Dotato di piedini regolabili in altezza

📦 80 kg



C45PRO AS2

📦 1 045000481

C45STR

nastro adesivo colorato per arredo officina C45PRO

- permette di personalizzare il colore degli inserti orizzontali e verticali dell'arredo officina C45PRO

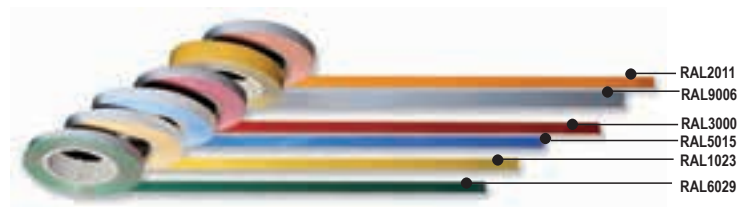

	L m	📦	📦
C45STR-O/2011	30	1	045000911
C45STR-G/9006	25	1	045000912
C45STR-R/3000	25	1	045000913
C45STR-B/5015	25	1	045000914
C45STR-Y/1023	25	1	045000915
C45STR-V/6029	25	1	045000916

ACCESSORI RSC55 - C45PRO

C45LMP

lampada LED per arredo officina C45PRO - RSC55

- Lunghezza: 630 mm
- Pratico fissaggio sotto all'armadietto pensile tramite adesivi
- Interruttore ON/OFF
- 570 lumen

Input: 100-240V 0,6A
Output: 12V 1.50A 18.0W

📦 307 g



C45LMP

1 045000320

PM/5C

portaminuterie a 5 vaschette in materiale plastico, con supporto

- Dimensione interna della vaschetta 95x120 mm
- Abbinabile alle pareti portautensili serie C45PRO e RSC55

📦 1,8 kg



165
140
600



PM/5C

1 088880450

PM/6C

portaminuterie a 6 vaschette in materiale plastico, con supporto

- Dimensione interna della vaschetta 80x60 mm
- Abbinabile alle pareti portautensili serie C45PRO e RSC55

📦 970 g



115
85
600



PM/6C

1 088880440

CP

cestino portaflaconi da parete in acciaio

- Abbinabile ai pannelli portautensili da parete

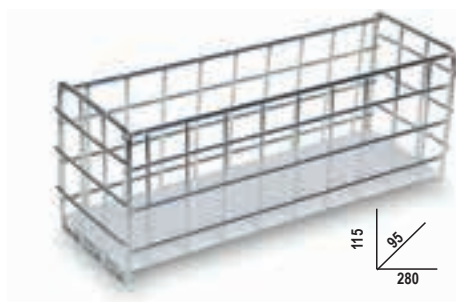

115
85
280

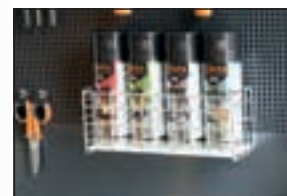

CP

1 088880470

SPC

supporto da parete porta computer

- Abbinabile alle pareti portautensili serie RSC55 e C45PRO
- Dimensioni 398x243x138 mm



SPC

1 088880480

CASSETTIERE E CONTENITORI

		Applicazione	N° pezzi	Cassettiere e Contenitori																
				RSC22	RSC23	RSC23C	RSC23T	RSC24/5	RSC24/6	RSC24/7	RSC24/8	RSC24AXL/9	C25	C27S	RSC28	C30M				
UTENSILI SCIOLTI	Senza supporti	5902MT	Movimento terra	106	☐ 477	☐ 477	☐ 477													
		5902MT/AS	Movimento terra	99	☐ 478	☐ 478	☐ 478													
		5902VI	Manutenzioni industriali	107	☐ 443	☐ 443		☐ 443							☐ 443	☐ 443				
		5904VG/3	Autoriparazione	132					☐ 481	☐ 481	☐ 481	☐ 481								
		5905VG/1	Autoriparazione	94											☐ 484					
		5905VG/2	Autoriparazione	118											☐ 485					
	5910VI/3	Manutenzioni industriali	297																☐ 447	
	Con supporti	5954VG	Autoriparazione	138																
		5954VI	Manutenzioni industriali	133																
		5957U-P	Interventi universali	133																
		5957VG	Autoriparazione	174																
		5957VI	Manutenzioni industriali	162																
		5958U	Interventi universali	85																
	UTENSILI IN MODULI	Morbidi	5904VG/2M	Autoriparazione	170				☐ 479	☐ 479	☐ 479	☐ 479	☐ 479	☐ 479					☐ 479	
5904VU/1M			Interventi universali	90				☐ 452	☐ 452	☐ 452	☐ 452	☐ 452	☐ 452					☐ 452		
5904VU/2M			Interventi universali	144				☐ 453	☐ 453	☐ 453	☐ 453	☐ 453	☐ 453					☐ 453		
5927VU/M			Interventi universali	108	☐ 463	☐ 463	☐ 463											☐ 463		
5935ET/1MB			Elettrotecnica	96																
5935VG/1MB			Autoriparazione	98																
5935VI/2MB			Manutenzioni industriali	133																
5945VUM			Interventi universali	231																
5988H/7M			Autoriparazione	333										☐ 469	☐ 469				☐ 469	
5988L/4M			Autoriparazione	273					☐ 470	☐ 470	☐ 470	☐ 470	☐ 470	☐ 470						
5988U/6M			Interventi universali	214							☐ 471	☐ 471	☐ 471	☐ 471					☐ 471	
5988U/7M			Interventi universali	215				☐ 459	☐ 459	☐ 459	☐ 459	☐ 459	☐ 459	☐ 459					☐ 459	
5988VHB-MQ			Elettrotecnica	66				☐ 475	☐ 475	☐ 475	☐ 475	☐ 475	☐ 475	☐ 475					☐ 475	
Rigidi			5904VI/1T	Manutenzioni industriali	98				☐ 443	☐ 443	☐ 443	☐ 443	☐ 443	☐ 443	☐ 443					☐ 443
		5904VI/2T	Manutenzioni industriali	153				☐ 444			☐ 444	☐ 444	☐ 444	☐ 444					☐ 444	
		5904VI/3T	Manutenzioni industriali	142								☐ 445	☐ 445	☐ 445					☐ 445	
		5904VG/2T	Autoriparazione	99				☐ 480	☐ 480	☐ 480	☐ 480	☐ 480	☐ 480	☐ 480					☐ 480	
		5904VG/3T	Autoriparazione	102				☐ 482	☐ 482	☐ 482	☐ 482	☐ 482	☐ 482	☐ 482					☐ 482	
		5904VG/5T	Autoriparazione	153				☐ 483		☐ 483	☐ 483	☐ 483	☐ 483	☐ 483					☐ 483	
		5904VU/2T	Interventi universali	104				☐ 454	☐ 454	☐ 454	☐ 454	☐ 454	☐ 454	☐ 454					☐ 454	
		5904VU/3T	Interventi universali	146				☐ 455	☐ 455	☐ 455	☐ 455	☐ 455	☐ 455	☐ 455					☐ 455	
		5904VU/4T	Interventi universali	197				☐ 456	☐ 456	☐ 456	☐ 456	☐ 456	☐ 456	☐ 456					☐ 456	
		5908VG/2T	Autoriparazione	214																☐ 486
		5908VI/2T	Manutenzioni industriali	232									☐ 446	☐ 446					☐ 446	
		5908VU/2T	Interventi universali	161				☐ 457		☐ 457	☐ 457	☐ 457	☐ 457	☐ 457					☐ 457	
5910VG/3T		Autoriparazione	202																☐ 487	
5910VI/3T	Manutenzioni industriali	261																☐ 448		
5938U/2T	Interventi universali	210																		

CASSETTIERE E CONTENITORI

		Applicazione	N° pezzi	C35	C38	C39MD C39SM	C39T	C45PRO	RSC51	C54S RSC55C	RSC55	RSC55PS RSC55PSE	C57SA C57SD	C57SB C57SP	C58P	C45PRO PAS	C59A C59C	C59B	
UTENSILI SCIOLTI	Senza supporti			5902MT	Movimento terra	106			477										
		5902MT/AS	Movimento terra	99			478												
		5902VI	Manutenzioni industriali	107															
		5904VG/3	Autoriparazione	132							482						482	482	
		5905VG/1	Autoriparazione	94															
		5905VG/2	Autoriparazione	118															
		5910VI/3	Manutenzioni industriali	297															
		5954VG	Autoriparazione	138						491									
		5954VI	Manutenzioni industriali	133						451	451								
		5957U-P	Interventi universali	133								465	465						
	5957VG	Autoriparazione	174								492	492							
	5957VI	Manutenzioni industriali	162									450							
	5958U	Interventi universali	85				466			466	466			466					
UTENSILI IN MODULI	Morbidi	5904VG/2M	Autoriparazione	170		479	479				479						479	479	
		5904VU/1M	Interventi universali	90		452	452		452		452							452	452
		5904VU/2M	Interventi universali	144		453	453				453							453	453
		5927VU/M	Interventi universali	108															
		5935ET/1MB	Elettrotecnica	96	472														
		5935VG/1MB	Autoriparazione	98	488														
		5935VI/2MB	Manutenzioni industriali	133	449														
		5945VUM	Interventi universali	231		490			490										
		5988H/7M	Autoriparazione	333								469							469
		5988L/4M	Autoriparazione	273			470	470				470						470	470
	5988U6/M	Interventi universali	214			471					471							471	
	5988U/7M	Interventi universali	215			459					459						459	459	
	5988VHB-MQ	Elettrotecnica	66			475	475		475		475						475	475	
	Rigidi	5904VI/1T	Manutenzioni industriali	98			443	443		443		443						443	443
		5904VI/2T	Manutenzioni industriali	153			444					444						444	444
		5904VI/3T	Manutenzioni industriali	142			445					445							445
		5904VG/2T	Autoriparazione	99			480	480		480		480						480	480
		5904VG/3T	Autoriparazione	102			482	482				482						482	482
		5904VG/5T	Autoriparazione	153			483					483						483	483
		5904VU/2T	Interventi universali	104			454	454				454						454	454
		5904VU/3T	Interventi universali	146			455	455				455						455	455
		5904VU/4T	Interventi universali	197			456	456				456						456	456
		5908VG/2T	Autoriparazione	214															
5908VI/2T		Manutenzioni industriali	232															446	
5908VU/2T		Interventi universali	161			457					457						457	457	
5910VG/3T		Autoriparazione	202																
5910VI/3T	Manutenzioni industriali	261																	
5938U/2T	Interventi universali	210		464															

5902VI

assortimento di 107 utensili

► Manutenzioni industriali

N. pezzi/Descrizione

- 6 cacciaspina Ø 2 - 3 - 4 - 5 - 6 - 8 mm
- 1 bulino Ø 3 mm
- 1 scalpelli piatti nervati 200 mm
- 26 serie di chiavi combinate 6+32 mm
- 12 chiavi a forchetta 6x7 - 8x9 - 10x11 - 12x13 - 14x15 - 16x17
18x19 - 20x22 - 21x23 - 24x26 - 25x28 - 30x32 mm
- 9 chiavi maschio esagonale piegate Ø 1,5 - 2 - 2,5 - 3 - 4 - 5 - 6 - 8 - 10 mm
- 1 chiave regolabile a rullino 300 mm
- 13 chiavi a bussola esagonali 1/2" con guida Ø 10+22 mm
- 1 prolunga - 1/2" 125 mm
- 1 prolunga - 1/2" 255 mm
- 1 snodo 1/2"
- 1 quadro maschio 1/2" con spina scorrevole
- 1 cricchetto reversibile 1/2" ®
- 1 pinze regolabili cerniera chiusa 250 mm
- 1 pinza autobloccante 240 mm
- 1 tronchesi a grande effetto, a taglienti diagonali, finitura industriale 160 mm
- 1 cesoia a doppia leva diritta 250 mm
- 1 forbici per elettricisti lame diritte
- 1 pinze universali a grande effetto, finitura industriale 180 mm
- 1 pinze a becchi mezzotondi lunghissimi, diritti zigrinati, impugnatura bimatereale, finitura industriale 160 mm
- 8 giravite lama piatta 2,5x50 - 3x75 - 3,5x100 - 4x125 - 5,5x125 - 6,5x150 - 8x200 - 10x200 mm
- 4 giravite per viti con impronta a croce Phillips® PH0x60 - PH1x80 - PH2x100 - PH3x150 mm
- 1 martello tipo tedesco 500 g
- 1 mazzuola antirimbalzo Ø 40 mm
- 1 punta per tracciare
- 1 flessometro 5 m
- 1 spessimetro
- 5 serie di 5 lime 200 mm
- 1 seghetto
- 1 oliatore in metallo a pressione 300 cc
- 1 cutter con lama a settori
- 1 lampada magnetica snodata con LED ad alta luminosità

Beta N.

- 31
- 32
- 35
- 42/S26
- 55/S12
- 96N/SC9
- 111E
- 920A/SB13
- 920/21
- 920/22
- 920/25
- 920/42
- 920/55
- 1048N
- 1052
- 1084GBM
- 1122
- 1128BMX
- 1150GBM
- 1166GBM
- 1260
- 1262
- 1370
- 1392
- 1688A
- 1692
- 1708/20
- 1719BMA...S5
- 1726BM
- 1751N
- 1771BM
- 1837F

5902VI

059021060

Assortimento consigliato in abbinamento con RSC22 - RSC23 - RSC23T - C25 - C27S

5904VI/1T

assortimento di 98 utensili in termoformato rigido in ABS

► Manutenzioni industriali

N. pezzi/Descrizione

- 19 chiavi a bussola esagonali 1/2" Ø 10+24 - 26 - 27 - 30 - 32 mm
- 5 chiavi a bussola maschio esagonale 1/2" Ø 5 - 6 - 8 - 10 - 12 mm
- 1 prolunga - 1/2" 125 mm
- 1 prolunga - 1/2" 255 mm
- 1 snodo 1/2"
- 1 quadro maschio 1/2" con spina scorrevole
- 1 cricchetto reversibile 1/2" ®
- 16 chiavi combinate 6+21 mm
- 5 chiavi combinate 22-24-27-30-32 mm
- 1 pinze regolabili cerniera chiusa 250 mm
- 1 pinza autobloccante 240 mm
- 1 tronchesi a grande effetto taglienti diagonali 160 mm
- 1 pinza universale 180 mm
- 1 pinza a becchi mezzotondi diritti 160 mm
- 1 pinze becchi diritti per anelli elastici, per fori Ø 180 mm
- 1 pinze becchi piegati per anelli elastici, per fori Ø 170 mm
- 1 pinze becchi diritti per anelli elastici, per alberi Ø 175 mm
- 1 pinze becchi piegati per anelli elastici, per alberi Ø 175 mm
- 2 scalpelli piatti nervati 100 - 200 mm
- 5 lime a taglio mezzodolce 200 mm
- 1 martello tipo tedesco 300 g
- 1 mazzuola con battenti in materiale plastico Ø 35 mm
- 8 chiavi a forchetta 6x7 - 8x9 - 10x11 - 12x13 - 14x15 - 16x17 - 18x19 - 20x22 mm
- 9 chiavi maschio esagonale piegate Ø 1,5 - 2 - 2,5 - 3 - 4 - 5 - 6 - 8 - 10 mm
- 4 giravite lama piatta 3x75 - 4x100 - 5,5x150 - 6,5x150 mm
- 3 giravite per viti con impronta a croce Phillips® PH0x60 - PH1x80 - PH2x100 mm
- 6 chiavi a T maschio esagonale Ø 2,5 - 3 - 4 - 5 - 6 - 8 mm

Beta N. TR

- 920A T80
- 920ME T80
- 920/21 T80
- 920/22 T80
- 920/25 T80
- 920/42 T80
- 920/55 T80
- 42 T05
- 42 T06
- 1048N T153
- 1052 T153
- 1084 T138
- 1150 T138
- 1166 T138
- 1032 T145
- 1034 T145
- 1036 T145
- 1038 T145
- 35 T234
- 1719BMA8/S5 T236
- 1370 T234
- 1390 T234
- 55 T33
- 96/SC9 T33
- 1260 T208
- 1262 T208
- 951 T68

5904VI/1T

059041161

Assortimento consigliato in abbinamento con RSC23T - RSC24 - RSC24L7 - RSC24L-CAB
RSC24A - RSC24AXL - RSC28 - C37 - C39 da 6 - 7 - 8 cassetti - C39MD - C39SM - C39T - RSC51 - RSC55 - C59

5904VI/2T

assortimento di 153 utensili in termoformato rigido in ABS

► Manutenzioni industriali

N. pezzi/Descrizione

- 16 chiavi combinate 6÷21 mm
- 5 chiavi combinate 22 - 24 - 27 - 30 - 32 mm
- 5 cacciapina Ø 2 - 3 - 4 - 5 - 6 mm
- 1 bulino Ø 4 mm
- 12 chiavi a forchetta 6x7 - 8x9 - 10x11 - 12x13 - 14x15 - 16x17
18x19 - 20x22 - 21x23 - 24x26 - 27x29 - 30x32 mm
- 9 chiavi maschio esagonale piegate \bigcirc 1,5 - 2 - 2,5 - 3 - 4 - 5 - 6 - 8 - 10 mm
- 7 chiavi poligonali curve 6÷29 mm
- 19 chiavi a bussola esagonali 1/2" \bigcirc 10÷24 - 26 - 27 - 30 - 32 mm
- 1 prolunga - 1/2" 125 mm
- 1 prolunga - 1/2" 255 mm
- 1 snodo 1/2"
- 1 quadro maschio 1/2" con spina scorrevole
- 1 cricchetto reversibile 1/2" $\text{\textcircled{R}}$
- 13 chiavi a bussola esagonali 1/4" \bigcirc 4÷14 mm
- 6 chiavi a bussola maschio esagonale 1/4" \bigcirc 2,5÷8 mm
- 1 prolunga - 1/4" 50 mm
- 1 prolunga - 1/4" 150 mm
- 1 snodo 1/4"
- 1 quadro con impugnatura 1/4"
- 1 quadro scorrevole 1/4"
- 1 cricchetto reversibile 1/4" $\text{\textcircled{R}}$
- 9 giravite lama piatta \bullet 3x75 - 3x100 - 4x100 - 4x150 - 5,5x100
5,5x150 - 6,5x150 - 8x150 - 10x200 mm
- 2 giravite nano lama piatta \bullet 4x30 - 6,5x30 mm
- 7 giravite per viti con impronta a croce Phillips® $\text{\textcircled{P}}$ PH0x60 - PH0x100 - PH1x80 - PH1x120 -
PH2x100 - PH2x150 - PH3x150 mm
- 2 giraviti nano Phillips® $\text{\textcircled{P}}$ PH1x30 - PH2x30 mm
- 1 pinze regolabili cerniera chiusa 250 mm
- 1 pinza autobloccante 240 mm
- 1 tronchesi a grande effetto taglienti diagonali ∇ 160 mm
- 1 pinza a becchi mezzotondi diritti \bullet 160 mm
- 1 pinza universale $\text{\textcircled{=}}$ 180 mm
- 1 pinze becchi dritti per anelli elastici, per fori \bigcirc 180 mm
- 1 pinze becchi piegati per anelli elastici, per fori \bigcirc 170 mm
- 1 pinze becchi dritti per anelli elastici, per alberi \bullet 175 mm
- 1 pinze becchi piegati per anelli elastici, per alberi \bullet 175 mm
- 6 chiavi a T maschio esagonale \bigcirc 2,5 - 3 - 4 - 5 - 6 - 8 mm
- 5 lime a taglio mezzodolce 200 mm
- 2 scalpelli piatti nervati 100 - 200 mm
- 1 martello tipo tedesco 300 g
- 1 mazzuola con battenti in materiale plastico Ø 35 mm
- 1 rivettatrice
- 100 rivetti 2,9x6 mm
- 100 rivetti 3,2x8 mm
- 100 rivetti 3,8x10 mm
- 100 rivetti 4x12 mm
- 100 rivetti 4,8x12 mm
- 1 flessometro
- 1 miniseghetto
- 1 oliatore in plastica
- 1 cutter con lama a settori

Beta N.	TR
42	T05
42	T06
31	T31
32	T31
55	T31
96N/SC9	T31
90	T40
920A	T83
920/21	T83
920/22	T83
920/25	T83
920/42	T83
920/55	T83
900	T91
900ME	T91
900/20	T91
900/21	T91
900/25	T91
900BG/30	T91
900/42	T91
900/55	T91
1260	T167
1260N	T167
1262	T168
1262N	T168
1048N	T153
1052	T153
1084	T138
1166	T138
1150	T138
1032	T145
1034	T145
1036	T145
1038	T145
951	T68
1719BMA8/S5	T236
35	T234
1370	T234
1390	T234
1741B	T281
1741RV...K	T281
1741RV...K	T281
1741RV...K	T281
1741RV...K	T281
1741RV...K	T281
1692	T289
1725CR	T289
1755	T289
1771	T289



T05 T06 T31



T40 T83 T91



T167 T168



T153 T138 T145 T68



T236 T234 T281 T289

5904VI/3T

assortimento di 142 utensili in termoformato rigido in ABS

► Manutenzioni industriali

N. pezzi/Descrizione

N. pezzi/Descrizione	Beta N.	TR
16 chiavi combinate 6÷21 mm	42	T05
5 chiavi combinate 22 - 24 - 27 - 30 - 32 mm	42	T06
5 cacciaspina Ø 2 - 3 - 4 - 5 - 6 mm	31	T31
1 bullino Ø 4 mm	32	T31
12 chiavi a forchetta 6x7 - 8x9 - 10x11 - 12x13 - 14x15 - 16x17 - 18x19 - 20x22 - 21x23 - 24x26 - 27x29 - 30x32 mm	55	T31
9 chiavi maschio esagonale piegate Ø 1,5 - 2 - 2,5 - 3 - 4 - 5 - 6 - 8 - 10 mm	96N/SC9	T31
9 giravite lama piatta ● 3x75 - 3,5x100 - 4x100 - 4x150 - 5,5x100 - 5,5x150 - 6,5x150 - 8x150 - 10x200 mm	1260	T167
2 giravite nano lama piatta ● 4x30 - 6,5x30 mm	1260N	T167
6 giravite per viti con impronta a croce Phillips® ● PH0x60 - PH0x100 - PH1x80 - PH1x120 - PH2x100 - PH2x150 mm	1262	T202
7 chiave maschio per viti con impronta Torx® ● T6-T7-T8-T9-T10-T15-T20	1267TX	T205
5 chiavi a bussola maschio esagonale 1/2" ○ 5 - 6 - 8 - 10 - 12 mm	920ME	T80
1 prolunga - 1/2" 125 mm	920/21	T80
1 prolunga - 1/2" 255 mm	920/22	T80
1 snodo 1/2"	920/25	T80
1 quadro maschio 1/2" con spina scorrevole	920/42	T80
1 cricchetto reversibile 1/2" ⊕	920/55	T80
19 chiavi a bussola esagonali 1/2" ○ 10÷24 - 26 - 27 - 30 - 32 mm	920A	T80
8 chiavi a tubo doppie poligonali 6x7 - 8x9 - 10x11 - 12x13 - 14x15 - 16x17 - 18x19 - 20x22 mm	930	T73
1 spine di manovra per chiavi a tubo 1 - 2	940/1	T73
1 spine di manovra per chiavi a tubo 1 - 2	940/2	T73
6 chiavi a T maschio esagonale ○ 2,5 - 3 - 4 - 5 - 6 - 8 mm	951	T68
1 pinza universale = 180 mm	1150BM	T137
1 pinza a becchi mezzotondi dritti ● 160 mm	1166BM	T137
1 tronchesi a grande effetto taglienti diagonali ⚡ 160 mm	1084BM	T137
1 pinze regolabili cerniera chiusa 250 mm	1048N	T153
1 pinza autobloccante 240 mm	1052	T153
1 pinze becchi dritti per anelli elastici, per fori ○ 180 mm	1032	T145
1 pinze becchi piegati per anelli elastici, per fori ○ 170 mm	1034	T145
1 pinze becchi dritti per anelli elastici, per alberi ● 175 mm	1036	T145
1 pinze becchi piegati per anelli elastici, per alberi ● 175 mm	1038	T145
1 pinze becchi dritti per anelli elastici, per fori ○ 140 mm	1032	T146
1 pinze becchi piegati per anelli elastici, per fori ○ 225 mm	1034	T146
1 pinze becchi dritti per anelli elastici, per alberi ● 140 mm	1036	T146
1 pinze becchi piegati per anelli elastici, per alberi ● 225 mm	1038	T146
1 martello tipo tedesco 400 g	1370	T231
1 mazzuola con battenti in materiale plastico Ø 35 mm	1390	T231
1 lime a taglio mezzodolce 200 mm	1719BMA8/T	T231
1 lime a taglio mezzodolce 200 mm	1719BMA8/P	T231
1 lime a taglio mezzodolce 200 mm	1719BMA8/M	T231
1 calibro digitale a corsoio	1651DGT	T297
1 riga flessibile graduata 300 mm	1682	T297
1 flessometro 5 m	1691BM	T297
1 rivettatrice 250 mm	1741B	T281
100 rivetti 2,9x6 mm	1741RV..K	T281
100 rivetti 3,2x8 mm	1741RV..K	T281
100 rivetti 3,8x10 mm	1741RV..K	T281
100 rivetti 4x12 mm	1741RV..K	T281
100 rivetti 4,8x12 mm	1741RV..K	T281
1 cesoia a lame larghe diritte 250 mm	1112	T285
1 forbici per elettricisti lame dritte	1128BM	T285
1 seghetto	1726	T285
(5) lame per seghetti	1728BM	T285
1 oliatore in plastica a pressione 200 cc termoformato vuoto	1753	T285
	VP6	VP6



T05 T06 T31



T167 T202 T205



T80 T73 T68



T137 T153 T145 T146



T231 T297 T281



T285 VP6

5904VI/3T

059041168

Assortimento consigliato in abbinamento con RSC24 da 8 cassetti - RSC24A da 8 cassetti - RSC24AXL da 8-9 cassetti - RSC28 - C37 da 8 cassetti - C39 da 8 cassetti - C39MD - C39SM - RSC55 - C59B

5908VI/2T

assortimento di 232 utensili in termoformato rigido in ABS

► Manutenzioni industriali

N. pezzi/Descrizione

N. pezzi/Descrizione	Beta N.	TR
5 chiavi a bussola maschio esagonale 1/2" \odot 5 - 6 - 8 - 10 - 12 mm	920ME	T80
1 prolunga - 1/2" 125 mm	920/21	T80
1 prolunga - 1/2" 255 mm	920/22	T80
1 snodo 1/2"	920/25	T80
1 quadro maschio 1/2" con spina scorrevole	920/42	T80
1 cricchetto reversibile 1/2" \otimes	920/55	T80
19 chiavi a bussola esagonali 1/2" \odot 10+24 - 26 - 27 - 30 - 32 mm	920A	T80
16 chiavi combinate 6+21 mm	42	T05
5 chiavi combinate 22 - 24 - 27 - 30 - 32 mm	42	T06
13 chiavi a bussola esagonali 1/4" \odot 4+14 mm	900	T91
6 chiavi a bussola maschio esagonale 1/4" \odot 2,5 - 3 - 4 - 5 - 6 - 8 mm	900ME	T91
1 prolunga - 1/4" 50 mm	900/20	T91
1 prolunga - 1/4" 150 mm	900/21	T91
1 quadro con impugnatura 1/4"	900BG/30	T91
1 snodo 1/4"	900/25	T91
1 quadro scorrevole 1/4"	900/42	T91
1 cricchetto reversibile 1/4" \otimes	900/55	T91
6 chiavi a T maschio esagonale \odot 2,5 - 3 - 4 - 5 - 6 - 8 mm	951	T68
7 chiavi poligonali curve 6x7-8x9-10x11-12x13-14x15-16x17-18x19 mm	90	T40
5 chiavi poligonali curve 20x22 - 21x23 - 24x26 - 25x28 - 27x29 mm	90	T41
7 giravite lama piatta \bullet 2,5x50 - 3x75 - 3,5x100 - 4x125 - 5,5x100 - 5,5x150 - 6,5x150 mm	1260	T199
6 giravite per viti con impronta a croce Phillips \oplus PH0x60 - PH0x100 - PH1x80 - PH1x120 - PH2x100 - PH2x150 mm	1262	T202
3 giravite lama piatta \bullet 8x200 - 10x150 - 10x200 mm	1260	T201
2 giravite nano lama piatta \bullet 4x30 - 6,5x30 mm	1260N	T201
2 giravite per viti con impronta a croce Phillips \oplus PH3x150 - PH4x200 mm	1262	T204
2 giraviti nano Phillips \oplus PH1x30 - PH2x30 mm	1262N	T204
2 scalpelli piatti nervati 100 - 200 mm	35	T234
1 martello tipo tedesco 300 g	1370	T234
1 mazzuola con battenti in materiale plastico \varnothing 35 mm	1390	T234
1 rivettatrice 250 mm	1741B	T281
100 rivetti 2,9x6 mm	1741RV...K	T281
100 rivetti 3,2x8 mm	1741RV...K	T281
100 rivetti 3,8x10 mm	1741RV...K	T281
100 rivetti 4x12 mm	1741RV...K	T281
100 rivetti 4,8x12 mm	1741RV...K	T281
1 pinze regolabili cerniera chiusa 250 mm	1048N	T153
1 pinza autobloccante 240 mm	1052	T153
5 serie di 5 lime 200 mm	1719BMA...S5	T236
1 pinze becchi diritti per anelli elastici, per fori \odot 180 mm	1032	T145
1 pinze becchi piegati per anelli elastici, per fori \odot 170 mm	1034	T145
1 pinze becchi diritti per anelli elastici, per alberi \bullet 175 mm	1036	T145
1 pinze becchi piegati per anelli elastici, per alberi \bullet 175 mm	1038	T145
1 pinza universale \equiv 180 mm	1150BM	T137
1 pinza a becchi mezzotondi diritti \bullet 160 mm	1166BM	T137
1 tronchese a grande effetto taglienti diagonali ∇ 160 mm	1084BM	T137
5 cacciaspina \varnothing 2 - 3 - 4 - 5 - 6 mm	31	T31
1 bulino \varnothing 4 mm	32	T31
12 chiavi a forchetta 6x7 - 8x9 - 10x11 - 12x13 - 14x15 - 16x17 - 18x19 - 20x22 - 21x23 - 24x26 - 27x29 - 30x32 mm	55	T31
9 chiavi maschio esagonale piegate \odot 1,5 - 2 - 2,5 - 3 - 4 - 5 - 6 - 8 - 10 mm	96N/SC9	T31
1 cesoia a lame larghe diritte 250 mm	1112	T285
1 forbici per elettricisti lame dritte	1128BM	T285
1 seghetto	1726	T285
5 lame per seghetti	1728BM	T285
1 oliatore in plastica a pressione 200 cc	1753	T285
1 termoformato vuoto	VP5	VP5
1 giramaschi regolabile M3+M12	435/1,5	T273
1 giramaschi regolabile M5+M21	435/3	T273
1 giramaschi a cricchetto reversibile 2,0+5,0 mm (M3+M8)	436/1	T273
1 giramaschi a cricchetto reversibile 4,6+8,0 mm (M5+M12)	436/2	T273
1 girafilire 25,4 mm	444/1	T273
1 girafilire 38,1 mm	444/2	T273
1 contafilletti 0,25+6 W 62+4x1"	1707	T273
26 maschi a mano passo grosso M3 - 4 - 5 - 6 - 7 - 8 - 9 - 10 - 12 - 14 - 16 - 18 - 20	430	T270
14 maschi a mano passo fine M6x0,75 - M8x1 - M10x1,25 - M12x1,5 - M14x1,5 - M16x1,5 - M18x1,5	433	T270
7 filiere tonde passo grosso M3 - 4 - 5 - 6 - 7 - 8 - 9	440	T270
6 filiere tonde passo grosso M10 - 12 - 14 - 16 - 18 - 20	440A	T270
2 filiere tonde passo fine M6x0,75 - M8x0,75	441	T270
5 filiere tonde passo fine M10x1,25 - M12x1,5 - M14x1,5 - M16x1,5 - M18x1,5	441A	T270



T80 T05 T06



T91 T68 T40 T41



T199 T202 T201 T204



T234 T281 T153 T236



T145 T137 T31



T285 VP5



T273 T270

5908VI/2T

059081105

Assortimento consigliato in abbinamento con RSC28 - RSC24/8 - RSC24A/8 - RSC24AXL da 8 e 9 cassetti - C37/8 - C39/8 - C59B



5910VI/3

assortimento di 297 utensili

► Manutenzioni industriali

N. pezzi/Descrizione	Beta N.
6 cacciaspina Ø 2 - 3 - 4 - 5 - 6 - 8 mm	31/B6N
1 bulino Ø 4 mm	32
2 scalpelli piatti nervati 125 - 250 mm	35
1 ugnetto nervato 200 mm	37
30 chiavi combinate 6-7-8-9-10-11-12-13-14-15-16-17-18-19-20-21-22-23-24-25-26-27-28-29-30-32-35-36-38-41 mm	42
14 chiavi a forchetta 6x7 - 8x9 - 10x11 - 12x13 - 14x15 - 16x17 - 18x19 - 20x22 - 21x23 - 24x26 - 25x28 - 27x29 - 30x32 - 36x41 mm	55
13 chiavi poligonali curve 6x7+30x32 mm	90
14 chiavi maschio esagonale piegate Ø 1,5 - 2 - 2,5 - 3 - 4 - 5 - 6 - 8 - 10 - 12 - 13 - 14 - 17 - 19 mm	96N
1 chiave regolabile a rullino 250 mm	111E
1 giratubi modello americano 300 mm	362
25 punte elicoidali cilindriche, serie corta 1=13x0,5 mm	412/SP25
37 assortimento di maschi e filere in acciaio HSS	447/C37
1 chiavi dinamometriche a scatto @ 1/2", 40+200 Nm	666N/20
1 quadro maschio a T snodato 1/2"	920/40
4 chiavi a bussola maschio esagonale 1/2" Ø 10-12-14-17 mm	920ME
25 20 chiavi a bussola e 5 accessori	920A/C20X
17 assortimento di 12 chiavi a bussola e 5 accessori 3/4"	928A/C12
12 chiavi a pipa doppie esagonali - poligonali 8 - 10 - 11 - 13 - 14 - 17 - 19 - 22 - 24 - 27 - 30 - 32 mm	932
14 chiavi a T maschio esagonale 2=14 mm	951/S14
5 chiavi a T con maschio esagonale snodato Ø 3 - 4 - 5 - 6 - 8 mm	953
3 pinze becchi dritti per anelli elastici, per fori Ø 180 - 225 - 300 mm	1032
3 pinze becchi piegati per anelli elastici, per fori Ø 170 - 210 - 290 mm	1034
3 pinze becchi dritti per anelli elastici, per alberi Ø 140x1,3 - 175 - 225 mm	1036
3 pinze becchi piegati per anelli elastici, per alberi Ø 135x1,3 - 175 - 220 mm	1038
2 pinze regolabili cerniera chiusa 250 - 300 mm	1048N
1 pinza autobloccante a doppia regolazione	1051
1 tronchese a grande effetto, a taglienti diagonali, finitura industriale 160 mm	1084GBM
1 tronchese doppia leva taglio frontale 180 mm	1092V
1 cesoia a lame larghe diritte 300 mm	1112
1 cesoia a lame strette diritte 250 mm	1114
1 forbici per elettricisti lame diritte	1128BMX
1 pinze universali a grande effetto, finitura industriale 180 mm	1150GBM
1 pinze a becchi mezzotondi lunghissimi, dritti zigrinati, impugnatura bimatereale, finitura industriale 160 mm	1166GBM
1 pinze a becchi mezzotondi lunghissimi, piegati zigrinati, impugnatura bimatereale, finitura industriale 160 mm	1168GBM
9 giravite lama piatta Ø 2,5x50 - 3x75 - 3,5x150 - 4x125 - 5,5x125 - 6,5x150 - 8x200 - 10x200 - 12x250 mm	1260
2 giravite nano lama piatta Ø 4x30 - 6,5x30 mm	1260N
5 giravite per viti con impronta a croce Phillips® PH0x100 - PH1x120 - PH2x150 - PH3x150 - PH4x200 mm	1262
2 giraviti nano Phillips® PH1x30 - PH2x30 mm	1262N
7 chiave maschio per viti con impronta Torx® T6 - T8 - T10 - T15 - T20 - T25 - T30	1267TX
2 martello tipo tedesco 300 - 600 g	1370
2 mazzuola con battenti in materiale plastico Ø 35 - 60 mm	1390
5 estrattori conici M3+M18	1430/S5
1 estrattore universale a due griffe 23+70 mm	1500N/1
1 estrattore universale a due griffe 23+100 mm	1500N/2
1 calibro a corsoio	1650
1 riga semirigida 300 mm	1683
1 punta per tracciare	1688A
1 flessometro 5 m	1692
1 spessimetro	1708/13
1 flessibile magnetico 1,8 kg	1712E/2
5 lime a taglio mezzodolce 200 mm	1719BMA8/S5
1 seghetto	1726BM
1 rivettatrice	1741B
1 oliatore in metallo a pressione 200 cc	1751N

5910VI/3T

assortimento di 261 utensili in termoformato rigido in ABS

► Manutenzioni industriali

N. pezzi/Descrizione

- 16 chiavi combinate 6÷21 mm
- 5 chiavi combinate 22 - 24 - 27 - 30 - 32 mm
- 5 cacciaspina Ø 2 - 3 - 4 - 5 - 6 mm
- 1 bulino Ø 4 mm
- 13 chiavi a forchetta 6x7 - 8x9 - 10x11 - 12x13 - 14x15 - 16x17
18x19 - 20x22 - 21x23 - 24x26 - 27x29 - 30x32 mm
- 9 chiavi maschio esagonale piegate Ø 1,5 - 2 - 2,5 - 3 - 4 - 5 - 6 - 8 - 10 mm
- 5 chiavi poligonali curve 20x22 - 21x23 - 24x26 - 25x28 - 27x29 mm
- 7 chiavi poligonali curve 6x7 - 8x9 - 10x11 - 12x13 - 14x15 - 16x17
18x19 mm
- 5 chiavi a bussola maschio esagonale 1/2" Ø 5 - 6 - 8 - 10 - 12 mm
- 1 prolunga - 1/2" 125 mm
- 1 prolunga - 1/2" 255 mm
- 1 snodo 1/2"
- 1 quadro maschio 1/2" con spina scorrevole
- 1 cricchetto reversibile 1/2" Ⓢ
- 19 chiavi a bussola esagonali 1/2" Ø 10÷24 - 26 - 27 - 30 - 32 mm
- 9 giravite lama piatta ● 3x75 - 3x100 - 4x100 - 4x150 - 5,5x100 - 5,5x150
6,5x150 - 8x150 - 10x200 mm
- 2 giravite nano lama piatta ● 4x30 - 6,5x30 mm
- 7 giravite per viti con impronta a croce Phillips® Ⓢ PH0x60 - PH0x100 - PH1x80 - PH1x120 -
PH2x100 - PH2x150 - PH3x150 mm
- 2 giraviti nano Phillips® Ⓢ PH1x30 - PH2x30 mm
- 4 chiavi maschio esagonale piegate Ø 13-14-17-19 mm
- 1 cesoia a lame larghe diritte 250 mm
- 1 forbici per elettricisti lame dritte
- 1 seghetto
- (5) lame per seghetti
- 1 oliatore in plastica a pressione 200 cc
- 1 pinza universale = 180 mm
- 1 pinza a becchi mezzotondi dritti ● 160 mm
- 1 tronchese a grande effetto taglienti diagonali ⚡ 160 mm
- 1 pinze becchi dritti per anelli elastici, per fori ○ 180 mm
- 1 pinze becchi piegati per anelli elastici, per fori ○ 170 mm
- 1 pinze becchi dritti per anelli elastici, per alberi ● 175mm
- 1 pinze becchi piegati per anelli elastici, per alberi ● 175mm
- 2 scalpelli piatti nervati 100 - 200 mm
- 1 martello tipo tedesco 300 g
- 1 mazzuola con battenti in materiale plastico Ø 35 mm
- 1 lime a taglio mezzodolce 200 mm
- 4 chiavi combinate 35-36-38-41 mm
- 1 chiavi a forchetta 36x41 mm
- 1 chiave regolabile a rullino 250 mm
- 1 giratubi modello americano 300 mm
- 25 punte elicoidali cilindriche, serie corta
- 37 assortimento di maschi e filiere in acciaio HSS
- 1 chiavi dinamometriche a scatto Ⓢ 200 Nm
- 17 assortimento di 12 chiavi a bussola e 5 accessori 3/4"
- 14 chiavi a T maschio esagonale
- 5 chiavi a T con maschio esagonale snodato ○ 3-4-5-6-8 mm
- 1 pinze becchi dritti per anelli elastici, per fori ○ 300 mm
- 1 pinze becchi piegati per anelli elastici, per fori ○ 290 mm
- 1 pinze becchi dritti per anelli elastici, per alberi ● 225 mm
- 1 pinze becchi piegati per anelli elastici, per alberi ● 220 mm
- 1 pinze regolabili cerniera chiusa 300 mm
- 1 pinza autobloccante a doppia regolazione
- 1 tronchese doppia leva taglio frontale ⚡ 180 mm
- 1 martello tipo tedesco 600 g
- 1 mazzuola con battenti in materiale plastico 60 mm
- 5 estrattori conici M3-M18
- 1 estrattore universale a due griffe
- 1 calibro a corsoio
- 1 riga semirigida
- 1 punta per tracciare
- 1 flessometro 5 m
- 1 spessimetro
- 1 flessibile magnetico

Beta N.	TR
42	T05
42	T06
31	T31
32	T31
55	T31
96N/SC9	T31
90	T41
90	T40
920ME	T80
920/21	T80
920/22	T80
920/25	T80
920/42	T80
920/55	T80
920A	T80
1260	T167
1260N	T167
1262	T168
1262N	T168
96N	T168
1112	T285
1128BM	T285
1726	T285
1728BM	T285
1753	T285
1150BM	T137
1166BM	T137
1084BM	T137
1032	T145
1034	T145
1036	T145
1038	T145
35	T234
1370	T234
1390	T234
1719BMA8/S5	T236
42	
55	
111E	
362	
412/SP25	
447/C37	
666N/20	
928A/C12	
951/S14	
953	
1032	
1034	
1036	
1038	
1048N	
1051	
1092V	
1370	
1390	
1430/S5	
1500/3	
1650	
1683	
1688	
1692	
1708/13	
1712E/2	



T05 T06 T31



T40 T41 T80



T167 T168 +96N



T137 T145 T234 T236



5935VI/2MB

assortimento di 133 utensili per cassettera C35, in vassoio morbido in EVA

► Manutenzioni industriali

N. pezzi/Descrizione

- 21 chiavi combinate 6-7-8-9-10-11-12-13-14-15-16-17-18-19-20-21-22-24-27-30-32 mm
- 8 chiavi a forchetta 6x7-8x9-10x11-12x13-14x15
16x17-18x19-20x22 mm
- 1 pinze regolabili cerniera chiusa 250 mm
- 19 chiavi a bussola esagonali 1/2" ○ 10-11-12-13-14-15-16-17-18
19-20-21-22-23-24-26-27-30-32 mm
- 1 prolunga angolare - 1/2" 125 mm
- 1 prolunga angolare - 1/2" 150 mm
- 1 snodo 1/2"
- 1 quadro maschio 1/2" con spina scorrevole
- 1 cricchetto reversibile 1/2" ⊕
- 1 chiave regolabile a rullino 250 mm
- 1 pinza autobloccante 240 mm
- 1 tronchesi a grande effetto taglienti diagonali ∇ 160 mm
- 1 pinza universale = 180 mm
- 1 pinza a becchi mezzotondi dritti ● 160 mm
- 1 pinze becchi dritti per anelli elastici, per fori ○ 180 mm
- 1 pinze becchi piegati per anelli elastici, per fori ○ 170 mm
- 1 pinze becchi dritti per anelli elastici, per alberi ● 175 mm
- 1 pinze becchi piegati per anelli elastici, per alberi ● 175 mm
- 13 chiavi a bussola esagonali 1/4" ○ 4-4,5-5-5,5-6-7-8-9-10-11-12-13-14 mm
- 1 prolunga - 1/4" 50 mm
- 1 prolunga - 1/4" 150 mm
- 1 snodo 1/4"
- 1 quadro con impugnatura 1/4"
- 1 cricchetto reversibile 1/4" ⊕
- 1 quadro scorrevole 1/4"
- 7 giravite lama piatta ● 2,5x50-3x75-3,5x100-4x100-5,5x125-6,5x150-8x200 mm
- 2 giravite nano lama piatta ● 4x30-6,5x30 mm
- 7 giravite per viti con impronta a croce Phillips® ⊕ PH0x60-PH0x100-PH1x80-PH1x120-
PH2x100-PH2x150-PH3x150 mm
- 2 giraviti nano Phillips® ⊕ PH1x30-PH2x30 mm
- 1 giravite cercafase ● 4x30-6,5x30 mm
- 9 chiavi maschio esagonale piegate con estremità sferica ○
- 6 chiavi a T maschio esagonale ○ 2,5-3-4-5-6-8 mm
- 5 cacciaspina Ø 2-3-4-5-6 mm
- 1 bulino Ø 4 mm
- 1 scalpelli piatti nervati 200 mm
- 1 cesoia a lame larghe diritte 250 mm
- 1 forbici per elettricisti lame diritte
- 1 martello tipo tedesco 500 g
- 1 mazzuola con battenti in materiale plastico Ø 45 mm
- 1 lima 200 mm
- 1 lima 200 mm
- 1 lima 200 mm
- 1 lima 200 mm
- 1 lima 200 mm
- 1 seghetto 440 mm

Beta N.	TR
42	MB12
55	MB12
1048N	MB12
920A	MB37
920AN/125	MB37
920AN/250	MB37
920/25	MB37
920/42	MB37
920/55	MB37
111E	MB37
1052	MB37
1084BM	MB37
1150BM	MB37
1166BM	MB37
1032	MB37
1034	MB37
1036	MB37
1038	MB37
900	MB37
900/20	MB37
900/21	MB37
900/25	MB37
900BG/30	MB37
900/55	MB37
900/42	MB37
1260	MB44
1260N	MB44
1262	MB44
1262N	MB44
1253	MB44
96BPC/SC9	MB44
951	MB44
31	MB55
32	MB55
35	MB55
1112	MB55
1128BMX	MB55
1370	MB55
1390	MB55
1719BMA..Q	MB55
1719BMA..T	MB55
1719BMA..P	MB55
1719BMA..M	MB55
1719BMA..R	MB55
1726	MB55



MB12



MB37



MB44



MB55



5957VI

assortimento di 162 utensili - accessori di fissaggio inclusi

► Manutenzioni industriali

N. pezzi/Descrizione	Beta N.
6 cacciaspina Ø 2 - 3 - 4 - 5 - 6 - 8 mm	31/SP6
6 punzoni, 1 bulino, 3 scalpelli con supporto	38/SP6
18 chiavi combinate 6-7-8-10-11-12-13-14-15-16-17 19-21-22-24-27-30-32 mm	42
12 chiavi a forchetta 6x7 ± 30x32 mm	55/S12X
8 chiavi maschio esagonale con impugnatura 2 - 2,5 - 3 - 4 5 - 6 - 8 - 10 mm	96T/S8
8 chiavi maschio piegate per viti con impronta Torx® Ⓢ T9 - T10 - T15 - T20 - T25 - T27 - T30 - T40	97TX/SC8
1 chiave regolabile a rullino 250 mm	111E
13 chiavi a bussola poligonali 1/2" con guida Ⓢ 10÷22 mm	920B/SB13
8 chiavi a bussola poligonali 1/2" con guida Ⓢ 23÷32 mm	920B/SB8
4 chiavi a bussola a giravite lama piatta 1/2" Ⓢ 1,2x6,5 - 1,2x8 - 1,6x8 - 2x12 mm	920LP
3 chiavi a bussola a giravite lama Phillips® 1/2" Ⓢ PH2 - 3 - 4	920PH
1 prolunga - 1/2" 125 mm	920/21
1 prolunga - 1/2" 255 mm	920/22
1 snodo 1/2"	920/25
1 quadro maschio 1/2" con spina scorrevole	920/42
1 cricchetto reversibile 1/2" Ⓢ	920/55
1 leva con estremità a punta e piatta curva	963
2 pinze becchi dritti per anelli elastici, per fori Ⓢ 140 - 180 mm	1032
2 pinze becchi piegati per anelli elastici, per fori Ⓢ 130 - 170 mm	1034
2 pinze becchi dritti per anelli elastici, per alberi Ⓢ 140 - 175 mm	1036
2 pinze becchi piegati per anelli elastici, per alberi Ⓢ 135 - 175 mm	1038
1 pinza regolabili cerniera chiusa 250 mm	1048N
1 pinza autobloccante a doppia regolazione	1051
1 tronchese a grande effetto taglienti diagonali ⚡ 160 mm	1084BM
1 tronchese doppia leva taglio frontale ⚡ 180 mm	1092V
1 cesoia a lame larghe diritte 250 mm	1112
1 cesoia a lame strette diritte 250 mm	1114
1 forbici per elettricisti lame diritte	1128BMX
1 pinza universale = 180 mm	1150BM
1 pinza a becchi mezzotondi dritti Ⓢ 160 mm	1166BM
1 pinza a becchi mezzotondi piegati Ⓢ 160 mm	1168BM
7 giravite lama piatta Ⓢ 2,5x50 - 3x75 - 4x100 5,5x125 - 6,5x150 - 8x200 - 10x200 mm	1260
4 giravite per viti con impronta a croce Phillips® Ⓢ PH0x60 - PH1x80 - PH2x100 - PH3x150 mm	1262
3 martello tipo tedesco 300 - 600 - 1000 g	1370
1 mazzuola con battenti in materiale plastico Ø 35 mm	1390
1 flessometro 5 m	1692
1 flessibile magnetico 1,8 kg	1712E/2
1 raschietto a due taglienti 200 mm	1717A
1 raschietto a tre taglienti 200 mm	1717B
5 lime a taglio mezzodolce 200 mm	1719BMA8/S5
1 seghetto	1725
1 oliatore in metallo a pressione 200 cc	1751
1 scalpelli piatti nervati 200 mm	35
1 ugnetto nervato 200 mm	37
11 chiavi a pipa doppie esagonali - poligonali 8 - 10 - 11 - 12 - 13 - 14 - 16 - 17 - 19 - 22 - 24 mm	932
1 pinza autobloccante 240 mm	1052
1 pinza autobloccante 280 mm	1060
1 pinza autobloccante 290 mm	1062
1 mazzuola antirimbalzo Ø 50 mm	1392
1 estrattore universale a due griffe 25÷130 mm	1500N/2
1 calibro a corsoio	1650
1 riga semirigida 300 mm	1683
1 punta per tracciare	1688A
1 spessimetro	1708/13
1 coltello a serramanico	1777BM
1 cutter con lama a settori 170 mm	1771BM
1 tronchese a taglienti diagonali ⚡ 160 mm	1082BM

5954VI

assortimento di 133 utensili - accessori di fissaggio inclusi

► Manutenzioni industriali

N. pezzi/Descrizione	Beta N.
5 cacciaspina Ø 2-3-4-5-6 mm	31
1 bulino Ø 4 mm	32
2 scalpelli piatti nervati 200-250 mm	35
18 chiavi combinate 6+14 - 16 - 17 - 18 - 19 - 21 - 22 - 24 - 27 - 30 mm	42
12 chiavi a forchetta 6x7 - 8x9 - 10x11 - 12x13 - 14x15 - 16x17 18x19 - 20x22 - 21x23 - 24x26 - 27x29 - 30x32 mm	55
12 chiavi maschio esagonale piegate Ø 2+10 mm	96/SC12
1 chiave regolabile a rullino 250 mm	111E
1 giratubi svedese 320 mm	374
20 chiavi a bussola esagonali 1/2" Ø 10+24 - 26 - 27 - 28 - 30 - 32 mm	920A
6 chiavi a bussola maschio esagonale 1/2" Ø 5 - 6 - 8 - 10 - 12 - 14 mm	920ME
1 prolunga - 1/2" 125 mm	920/21
1 prolunga - 1/2" 255 mm	920/22
1 snodo 1/2"	920/25
1 quadro maschio a T snodato 1/2"	920/40
1 quadro maschio 1/2" con spina scorrevole	920/42
1 cricchetto reversibile 1/2" ®	920/55
6 chiavi a T maschio esagonale Ø 2,5 - 3 - 4 - 5 - 6 - 8 mm	951
2 pinze becchi dritti per anelli elastici, per fori Ø 140 - 180 mm	1032
1 pinze becchi piegati per anelli elastici, per fori Ø 170 mm	1034
2 pinze becchi dritti per anelli elastici, per alberi Ø 140x1,3 - 175 mm	1036
1 pinze becchi piegati per anelli elastici, per alberi Ø 175 mm	1038
1 pinze regolabili cerniera chiusa 250 mm	1048N
1 pinza autobloccante 240 mm	1052
1 tronchesi a grande effetto taglianti diagonali < 160 mm	1084BM
1 tronchesi doppia leva taglio frontale < 180 mm	1092V
1 cesoia a lame larghe diritte 250 mm	1112
1 forbici per elettricisti lame diritte	1128BMX
1 pinza universale = 180 mm	1150BM
1 pinza a becchi mezzotondi dritti Ø 160 mm	1166BM
1 giravite cercafase ●	1253
2 giravite lama piatta ● 8x150 - 10x200 mm	1260
2 giravite nano lama piatta ● 4x30 - 6,5x30 mm	1260N
2 giravite per viti con impronta a croce Phillips® ● PH3x150 - PH4x200 mm	1262
2 giraviti nano Phillips® ● PH1x30 - PH2x30 mm	1262N
8 giravite	1263/D8
2 martello tipo tedesco 300 - 500 g	1370
1 mazzuola con battenti in materiale plastico Ø 45 mm	1390
1 flessometro 5 m	1692
1 flessibile magnetico 0,5 kg	1712E/1
5 lime a taglio mezzodolce 200 mm	1719BMA8/S5
1 seghetto	1726BM
1 oliatore in plastica a pressione 250 cc	1754



5954VI

059541053

Assortimento consigliato in abbinamento con C54S-C55C

5904VU/1M

assortimento di 90 utensili in vassoio morbido in EVA

► Universali

N. pezzi/Descrizione

- 16 chiavi combinate 6÷21 mm
- 8 chiavi a forchetta 6x7 - 8x9 - 10x11 - 12x13 - 14x15 - 16x17
18x19 - 20x22 mm
- 9 chiavi maschio esagonale piegate \odot 1,5 - 2 - 2,5 - 3 - 4 - 5 - 6 - 8 - 10 mm
- 6 chiave maschio per viti con impronta Torx® \odot T8-T10-T15-T20-T25-T30
- 3 giravite lama piatta \bullet 3x75-4x100-6,5x150 mm
- 3 giravite per viti con impronta a croce Phillips® \oplus PH0x60-PH1x80-PH2x100 mm
- 8 chiavi maschio esagonale con impugnatura \odot 2-2,5-3-4-5-6-7-8 mm
- 1 prolunga angolare - 1/2" 125 mm
- 1 prolunga angolare - 1/2" 250 mm
- 1 snodo 1/2"
- 1 quadro maschio 1/2" con spina scorrevole
- 1 cricchetto reversibile 1/2" \otimes
- 19 chiavi a bussola esagonali 1/2" \odot 10÷24 - 26 - 27 - 30 - 32 mm
- 1 tronchese a grande effetto taglienti diagonali ∇ 160 mm
- 1 pinza universale \equiv 180 mm
- 1 pinza a becchi mezzotondi dritti \bullet 160 mm
- 1 pinze regolabili cerniera chiusa 250 mm
- 1 pinza autobloccante 240 mm
- 2 scalpelli piatti nervati 100 - 200 mm
- 1 martello tipo tedesco 300 g
- 1 mazzuola con battenti in materiale plastico \varnothing 35 mm
- 1 pinze becchi dritti per anelli elastici, per fori \odot 180 mm
- 1 pinze becchi piegati per anelli elastici, per fori \odot 170 mm
- 1 pinze becchi dritti per anelli elastici, per alberi \bullet 175 mm
- 1 pinze becchi piegati per anelli elastici, per alberi \bullet 175 mm

Beta N.	TR
42	M05
55	M33
96/SC9	M33
1267TX	M204
1260	M201
1262	M201
96T	M50
920AN/125	M83
920AN/250	M83
920/25	M83
920/42	M83
920/55	M83
920A	M83
1084	M137
1150	M137
1166	M137
1048N	M153
1052	M153
35	M234
1370	M234
1390	M234
1032	M145
1034	M145
1036	M145
1038	M145



5904VU/1M

059041201

Assortimento consigliato in abbinamento con RSC51 - RSC23T - RSC24 - RSC24A - RSC24AXL - RSC24L/7 - RSC24L-CAB - RSC28
C37 - C39 - C39T - C39SM - C39MD - RSC55 - C59

5904VU/2M

assortimento di 144 utensili in vassoio morbido in EVA

► Universali

N. pezzi/Descrizione

- 16 chiavi combinate 6÷21 mm
- 8 chiavi a forchetta 6x7 - 8x9 - 10x11 - 12x13 - 14x15 - 16x17 - 18x19 - 20x22 mm
- 9 chiavi maschio esagonale piegate \odot 1,5 - 2 - 2,5 - 3 - 4 - 5 - 6 - 8 - 10 mm
- 3 giravite lama piatta \bullet 3x75-4x100-6,5x150 mm
- 3 giravite per viti con impronta a croce Phillips® \oplus PH0x60-PH1x80-PH2x100 mm
- 6 chiave maschio per viti con impronta Torx® \otimes T8-T10-T15-T20-T25-T30
- 8 chiavi maschio esagonale con impugnatura \odot 2-2,5-3-4-5-6-7-8 mm
- 1 prolunga angolare - 1/2" 125 mm
- 1 prolunga angolare - 1/2" 250 mm
- 1 snodo 1/2"
- 1 quadro maschio 1/2" con spina scorrevole
- 1 cricchetto reversibile 1/2" \oplus
- 19 chiavi a bussola esagonali 1/2" \odot 10÷24 - 26 - 27 - 30 - 32 mm
- 1 tronchesi a grande effetto taglienti diagonali ∇ 160 mm
- 1 pinza universale \equiv 180 mm
- 1 pinza a becchi mezzotondi dritti \bullet 160 mm
- 1 pinze regolabili cerniera chiusa 250 mm
- 1 pinza autobloccante 240 mm
- 2 scalpelli piatti nervati 100 - 200 mm
- 1 martello tipo tedesco 300 g
- 1 mazzuola \emptyset 35 mm
- 1 pinze becchi dritti per anelli elastici, per fori \odot 180 mm
- 1 pinze becchi piegati per anelli elastici, per fori \odot 170 mm
- 1 pinze becchi dritti per anelli elastici, per alberi \bullet 175 mm
- 1 pinze becchi piegati per anelli elastici, per alberi \bullet 175 mm
- 1 termoformato morbido
con 3 vaschette portaminuterie
- 1 flessometro 5 m
- 1 miniseghetto
- 1 oliatore in plastica 30 cc
- 1 cutter con lama a settori
- 5 inserti colorati per avvitatori per viti a testa con intaglio \bullet 0,5x3 - 0,6x4,5 - 0,8x5,5 - 1x5,5 - 1,2x6,5 mm
- 8 inserti colorati maschio esagonale per avvitatori \odot 2 - 2,5 - 3 - 4 - 5 - 6 - 8 - 10 mm
- 5 inserti colorati per avvitatori per viti con impronta a croce Phillips® \oplus PH0 - PH1 - PH2 - PH3 - PH4
- 4 inserti colorati per avvitatori per viti con impronta a croce Pozidriv® - Supadriv® \oplus PZ1 - PZ2 - PZ3 - PZ4
- 11 inserti colorati per avvitatori per viti con impronta Torx® \otimes T6-T7-T8-T9-T10-T15-T20-T25-T27-T30-T40
- 8 inserti colorati per avvitatori per viti con impronta Tamper Resistant Torx® \oplus T9-T10-T15-T20-T25-T27-T30-T40
- 1 portainseri a sgancio rapido con impugnatura 230 mm
- 1 cricchetto reversibile portainseri 100 mm
- 5 lime a taglio mezzodolce 200 mm
- 1 raccordi per avvitatori
- 1 prolunga portainseri magnetica

Beta N.	TR
42	M05
55	M33
96/SC9	M33
1260	M201
1262	M201
1267TX	M204
96T	M50
920AN/125	M83
920AN/250	M83
920/25	M83
920/42	M83
920/55	M83
920A	M83
1084	M137
1150	M137
1166	M137
1048N	M153
1052	M153
35	M237
1370T	M237
1390N	M237
1032	M145
1034	M145
1036	M145
1038	M145
VPM3	VPM3
1692	M289
1725CR	M289
1755	M289
1771	M289
860LP	M85
860PE	M85
860PH	M85
860PZ	M85
860TX	M85
860RTX	M85
851SR	M85
860/55	M85
1719BMA8/S5	M236
8920	M85
882P	M85



5904VU/2M

059041212

Assortimento consigliato in abbinamento con RSC23T - RSC24A - RSC24AXL - RSC24L/7 - RSC24L-CAB
RSC28 - C37 - C39 - C39SM - C39MD - C39T RSC55 - C59

5904VU/2T

assortimento di 104 utensili in termoformato rigido in ABS

► Universali

N. pezzi/Descrizione

- 7 giravite lama piatta ● 2,5x50 - 3x75 - 3,5x100 - 4x125
5,5x100 - 5,5x150 - 6,5x150 mm
- 6 giravite per viti con impronta a croce Phillips® ⊕ PH0x60 - PH0x100 - PH1x80 - PH1x120 - PH2x100 - PH2x150 mm
- 19 chiavi a bussola esagonali 1/2" ○ 10-11-12-13-14-15-16-17-18-19
20-21-22-23-24-26-27-30-32 mm
- 1 prolunga - 1/2" 125 mm
- 1 prolunga - 1/2" 255 mm
- 1 snodo 1/2"
- 1 quadro maschio 1/2" con spina scorrevole 305 mm
- 1 cricchetto reversibile 1/2" ⊗
- 1 pinze becchi dritti per anelli elastici, per fori ○ 180 mm
- 1 pinze becchi piegati per anelli elastici, per fori ○ 170 mm
- 1 pinze becchi dritti per anelli elastici, per alberi ● 175 mm
- 1 pinze becchi piegati per anelli elastici, per alberi ● 175 mm
- 1 pinze regolabili cerniera chiusa 250 mm
- 1 pinza autobloccante 240 mm
- 1 tronchesi a grande effetto taglienti diagonali ✂ 160 mm
- 1 pinza universale = 180 mm
- 1 pinza a becchi mezzotondi dritti ● 160 mm
- 2 scalpelli piatti nervati 100-200 mm
- 1 martello tipo tedesco 300 g
- 1 mazzuola con battenti in materiale plastico Ø 35 mm
- 6 chiavi a T maschio esagonale ○ 2,5-3-4-5-6-8 mm
- 8 chiavi a forchetta 6x7-8x9-10x11-12x13-14x15
16x17-18x19-20x22 mm
- 9 chiavi maschio esagonale piegate ○ 1,5+10 mm
- 16 chiavi combinate 6-7-8-9-10-11-12-13-14-15-16-17
18-19-20-21 mm
- 5 chiavi combinate 22-24-27-30-32 mm
- 1 forbici per elettricisti lame diritte
- 1 forbici multiuso
- 1 lima 200 mm
- 1 lima 200 mm
- 1 lima 200 mm
- 1 lima 200 mm
- 1 lima 200 mm
- 1 seghetto
- 1 lame per seghetti
- 1 cutter con lama a settori 170 mm
- 1 coltello a serramanico 185 mm

Beta N.	TR
1260	T199
1262	T202
920A	T83
920/21	T83
920/22	T83
920/25	T83
920/42	T83
920/55	T83
1032	T145
1034	T145
1036	T145
1038	T145
1048N	T153
1052	T153
1084	T138
1150	T138
1166	T138
1370	T234
1390	T234
951	T68
55	T33
96/SC9	T33
42	T05
42	T06
1128BMX	T284
1130BMX	T284
1719BMA...Q	T284
1719BMA...P	T284
1719BMA...T	T284
1719BMA...M	T284
1719BMA...R	T284
1726BM	T284
1728BM	T284
1771BM	T284
1778	T284



T199 T202 T83



T145 T153 T138 T234



T68 T33 T05 T06



T284

5904VU/2T

059041070

Assortimento consigliato in abbinamento con RSC23T - RSC24 - RSC24A - RSC24AXL - RSC24L/7 - RSC24L-CAB - RSC28 - C37 - C39 - C39SM - C39MD - C39T RSC55 - C59

5904VU/3T

assortimento di 146 utensili in termoformato rigido in ABS

► Universali

N. pezzi/Descrizione

- 16 chiavi combinate 6÷21 mm
- 5 chiavi combinate 22 - 24 - 27 - 30 - 32 mm
- 5 cacciaspina Ø 2 - 3 - 4 - 5 - 6 mm
- 1 bulino Ø 4 mm
- 12 chiavi a forchetta 6x7 - 8x9 - 10x11 - 12x13 - 14x15 - 16x17 - 18x19
20x22 - 21x23 - 24x26 - 27x29 - 30x32 mm
- 9 chiavi maschio esagonale piegate ○ 1,5 - 2 - 2,5 - 3 - 4 - 5 - 6 - 8 - 10 mm
- 6 chiavi maschio esagonale con impugnatura ○ 2 - 2,5 - 3 - 4 - 5 - 6 mm
- 6 chiavi maschio con impugnatura per viti con impronta Torx® ⊕ T10-T15-T20-T25-T27-T30
- 5 chiavi a bussola maschio esagonale 1/2" ○ 5 - 6 - 8 - 10 - 12 mm
- 1 prolunga - 1/2" 125 mm
- 1 prolunga - 1/2" 255 mm
- 1 snodo 1/2"
- 1 quadro maschio 1/2" con spina scorrevole
- 1 cricchetto reversibile 1/2" ⊕
- 19 chiavi a bussola esagonali 1/2" ○ 10÷24 - 26 - 27 - 30 - 32 mm
- 13 chiavi a bussola esagonali 1/4" ○ 4-4,5-5-5,5-6-7-8-9-10-11-12-13-14 mm
- 6 chiavi a bussola maschio esagonale 1/4" ○ 2,5-3-4-5-6-8 mm
- 1 prolunga - 1/4" 50 mm
- 1 prolunga - 1/4" 150 mm
- 1 snodo 1/4"
- 1 quadro con impugnatura 1/4"
- 1 quadro scorrevole 1/4" 115 mm
- 1 cricchetto reversibile 1/4" ⊕
- 1 pinze becchi dritti per anelli elastici, per fori ○ 180 mm
- 1 pinze becchi piegati per anelli elastici, per fori ○ 170 mm
- 1 pinze becchi dritti per anelli elastici, per alberi ● 175 mm
- 1 pinze becchi piegati per anelli elastici, per alberi ● 175 mm
- 1 pinza universale = 180 mm
- 1 pinza a becchi mezzotondi dritti ● 160 mm
- 1 tronchesi a grande effetto taglienti diagonali ∇ 160 mm
- 1 pinze regolabili cerniera chiusa 250 mm
- 1 pinza autobloccante 240 mm
- 4 giravite lama piatta ● 3x75 - 4x100 - 5,5x150 - 6,5x150 mm
- 3 giravite per viti con impronta a croce Pozidriv®-Supadriv® ⊕ PZ0 - PZ1 - PZ2
- 7 chiave maschio per viti con impronta Torx® ⊕ T6-T7-T8-T9-T10-T15-T20
- 2 scalpelli piatti nervati 100 - 200 mm
- 1 martello tipo tedesco 300 g
- 1 mazzuola con battenti in materiale plastico Ø 35 mm
- 5 lime a taglio mezzodolce 200 mm

Beta N.	TR
42	T05
42	T06
31	T31
32	T31
55	T31
96N/SC9	T31
96T	T52
97TTX	T55
920ME	T80
920/21	T80
920/22	T80
920/25	T80
920/42	T80
920/55	T80
920A	T80
900	T91
900ME	T91
900/20	T91
900/21	T91
900/25	T91
900BG/30	T91
900/42	T91
900/55	T91
1032	T145
1034	T145
1036	T145
1038	T145
1150	T138
1166	T138
1084	T138
1048N	T153
1052	T153
1260	T198
1269PZ	T198
1267TX	T205
35	T234
1370	T234
1390	T234
1719BMA&S5	T236



T05 T06 T31



T52 T55 T80



T91 T145 T138 T153



T198 T205 T234 T236

5904VU/3T

059041203

Assortimento consigliato in abbinamento con RSC24 - RSC24A - RSC24AXL - RSC24L7 - RSC24L-CAB - C37 - C39 - C39T - C39SM - C39MD RSC55 - C59

5904VU/4T

assortimento di 197 utensili in termoformato rigido in ABS

► Universali

N. pezzi/Descrizione

- 1 punzoni Ø 4 mm
- 1 cacciaspina Ø 4 mm
- 1 bulino Ø 4 mm
- 54 Assortimento di 52 inserti con attacco esagonale 10 mm e 2 accessori
- 17 chiavi combinate 6-7-8-10-11-12-13-14-16-17-18-19-21-22-24-27-30 mm
- 7 chiavi poligonali curve 6x7-8x9-10x11-12x13-14x15-16x17-18x19 mm
- 19 chiavi a bussola esagonali 1/2" ○ 10-11-12-13-14-15-16-17-18-19-20-21-22-23-24-26-27-30-32 mm
- 1 prolunga - 1/2" 125 mm
- 1 prolunga - 1/2" 250 mm
- 1 snodo 1/2"
- 1 quadro maschio 1/2" con spina scorrevole 305 mm
- 1 cricchetto reversibile 1/2" ⊕
- 13 chiavi a bussola esagonali 1/4" ○ 4-4,5-5-5,5-6-7-8-9-10-11-12-13-14 mm
- 6 chiavi a bussola maschio esagonale 1/4" ○ 2,5-3-4-5-6-8 mm
- 1 prolunga - 1/4" 50 mm
- 1 prolunga - 1/4" 150 mm
- 1 snodo 1/4"
- 1 quadro con impugnatura 1/4"
- 1 quadro scorrevole 1/4" 115 mm
- 1 cricchetto reversibile 1/4" ⊕
- 1 tronchesi a taglienti diagonali 160 mm
- 1 pinza universale 180 mm
- 1 pinze regolabili cerniera chiusa 250 mm
- 7 giravite lama piatta 2,5x50 - 3x75 - 3,5x100 - 4x125 - 5,5x100 - 5,5x150 - 6,5x150 mm
- 6 giravite Phillips® PH0x60 - PH1x80 - PH1x120 - PH2x100 - PH2x150 - PH3x150 mm
- 7 chiavi maschio con impugnatura per viti con impronta Torx® T6-T7-T8-T9-T10-T15-T20
- 2 scalpelli piatti nervati 100-200 mm
- 1 martello tipo tedesco 300 g
- 1 mazzuola con battenti in materiale plastico Ø 35 mm
- 1390
- 7 chiavi maschio esagonale piegate con estremità sferica ○ 2,5-3-4-5-6-8-10 mm
- 1 chiavi maschio esagonale piegate ○ 12 mm
- 31 inserti colorati con portainseriti magnetico in astuccio tascabile ⊕ ⊙ ⊕ ⊕ ⊕
- 1 bussola portainseriti

Beta N.	TR
30	
31	
32	
867/C52	
42	T01
90	T40
920A	T83
920/21	T83
920/22	T83
920/25	T83
920/42	T83
920/55	T83
900	T91
900ME	T91
900/20	T91
900/21	T91
900/25	T91
900BG/30	T91
900/42	T91
900/55	T91
1082	T156
1150	T156
1048	T156
1201E	T211
1202E	T213
1207E/TX	T216
35	T234
1370	T234
1390	T234
96BP	T259
96N	T259
860MX/A31	T259
895/1	T259



T01 T83



T91 T156 T40 T211



T213 T216 T234 T259

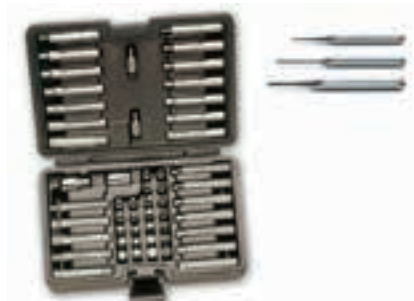

5904VU/4T

059241100

Assortimento consigliato in abbinamento con RSC23T - RSC24 - RSC24A - RSC24AXL - RSC24L/7 - RSC24L-CAB - C37 - C39 - C39T - C39SM - C39MD - RSC55 - C59

5908VU/2T

assortimento di 161 utensili in termoformato rigido in ABS

► Universali

N. pezzi/Descrizione

- 16 chiavi combinate 6+21 mm
- 5 chiavi combinate 22 - 24 - 27 - 30 - 32 mm
- 5 cacciaspina Ø 2 - 3 - 4 - 5 - 6 mm
- 1 bulino Ø 4 mm
- 12 chiavi a forchetta 6x7 - 8x9 - 10x11 - 12x13 - 14x15 - 16x17
18x19 - 20x22 - 21x23 - 24x26 - 27x29 - 30x32 mm
- 9 chiavi maschio esagonale piegate ○ 1,5 - 2 - 2,5 - 3 - 4 - 5 - 6 - 8 - 10 mm
- 7 chiavi poligonali curve 6x7-8x9-10x11-12x13-14x15-16x17-18x19 mm
- 6 chiavi maschio esagonale con impugnatura ○ 2-2,5-3-4-5-6 mm
- 6 chiavi maschio con impugnatura per viti con impronta Torx® ○ T10-T15-T20-T25-T27-T30
- 19 chiavi a bussola esagonali 1/2" ○ 10-11-12-13-14-15-16-17-18-19
20-21-22-23-24-26-27-30-32 mm
- 5 chiavi a bussola maschio esagonale 1/2" ○ 5-6-8-10-12 mm
- 1 prolunga angolare - 1/2" 125 mm
- 1 prolunga angolare - 1/2" 250 mm
- 1 snodo 1/2"
- 1 quadro maschio 1/2" con spina scorrevole 305 mm
- 1 cricchetto reversibile 1/2" Ⓞ
- 13 chiavi a bussola esagonali 1/4" ○ 4-4,5-5-5,5-6-7-8-9-10-11-12-13-14 mm
- 6 chiavi a bussola maschio esagonale 1/4" ○ 2,5-3-4-5-6-8 mm
- 1 prolunga - 1/4" 50 mm
- 1 prolunga - 1/4" 150 mm
- 1 snodo 1/4"
- 1 quadro con impugnatura 1/4"
- 1 quadro scorrevole 1/4" 115 mm
- 1 cricchetto reversibile 1/4" Ⓞ
- 1 tronchese a grande effetto taglienti diagonali † 160 mm
- 1 pinza universale = 180 mm
- 1 pinza a becchi mezzotondi dritti ● 160 mm
- 1 pinze becchi dritti per anelli elastici, per fori ○ 180 mm
- 1 pinze becchi piegati per anelli elastici, per fori ○ 170 mm
- 1 pinze becchi dritti per anelli elastici, per alberi ● 175 mm
- 1 pinze becchi piegati per anelli elastici, per alberi ● 175 mm
- 1 pinze regolabili cerniera chiusa 250 mm
- 1 pinza autobloccante 240 mm
- 7 giravite lama piatta ● 2,5x50-3x75-3,5x100-4x125-5,5x100-5,5x150-6,5x150 mm
- 3 giravite lama piatta ● 8x150-8x200-10x200 mm
- 2 giravite nano lama piatta ● 4x30-6,5x30 mm
- 6 giravite Phillips® ⚙ PH0x60-PH0x100-PH1x80-PH1x120-PH2x100-PH2x150 mm
- 2 giravite Phillips® ⚙ PH3x150-PH4x200 mm
- 2 giravite nano Phillips® ⚙ PH1x30-PH2x30 mm
- 2 scalpelli piatti nervati 100-200 mm
- 1 martello tipo tedesco 300 g
- 1 mazzuola con battenti in materiale plastico Ø 35 mm
- 1 lima 200 mm
- 1 lima 200 mm
- 1 lima 200 mm
- 1 lima 200 mm
- 1 lima 200 mm
- 1 termoformato rigido in ABS

Beta N.	TR
42	T05
42	T06
31	T31
32	T31
55	T31
96N/SC9	T31
90	T40
96T	T52
97TTX	T55
920A	T82
920ME	T82
920AN/125	T82
920AN/250	T82
920/25	T82
920/42	T82
920/55	T82
900	T91
900ME	T91
900/20	T91
900/21	T91
900/25	T91
900BG/30	T91
900/42	T91
900/55	T91
1084	T138
1150	T138
1166	T138
1032	T145
1034	T145
1036	T145
1038	T145
1048N	T153
1052	T153
1290	T170
1290	T171
1290N	T171
1292	T172
1292	T173
1292N	T173
35	T234
1370	T234
1390	T234
1719BMA...Q	T236
1719BMA...T	T236
1719BMA...P	T236
1719BMA...M	T236
1719BMA...R	T236
VP4	



T05 T06 T31



T40 T52 T55 T91



T82 T138 T153



T145 T170 T171 T172



T173 T234 T236 VP4

5914VU/M

Assortimento di 109 utensili per trolley C14, in vassoio morbido in EVA

► Universali

N. pezzi/Descrizione

- 31 inserti colorati con portainseri magnetico in astuccio tascabile ● ○ ⊕ ⊕ ⊕ ⊕
- 1 bussola portainseri
- 13 chiavi a bussola esagonali 1/4" ○ 4-4,5-5-5,5-6-7-8-9-10-11-12-13-14 mm
- 1 prolunga - 1/4" 150 mm
- 1 snodo 1/4"
- 1 quadro maschio 1/4"
- 1 quadro scorrevole 1/4"
- 1 cricchetto reversibile 1/4" ⊕
- 16 chiavi a bussola esagonali 1/2" ○ 10-11-12-13-14-15-16-17-18-19-21-22-24-27-30-32 mm
- 1 snodo 1/2"
- 1 prolunga angolare - 1/2"
- 1 quadro maschio 1/2" con spina scorrevole
- 1 cricchetto reversibile 1/2" ⊕
- 16 chiavi combinate 6-7-8-9-10-11-12-13-14-15-16-17-18-19-21-22 mm
- 9 chiavi maschio esagonale piegate ○
- 1 chiave regolabile a rullino 250 mm
- 1 forbici per elettricisti lame dritte
- 1 flessometro 5 mt
- 1 cutter con lama a settori
- 1 pinze regolabili cerniera chiusa 250 mm
- 1 tronchesi a taglienti diagonali 160 mm
- 1 pinza universale = 180 mm
- 1 pinza a becchi mezzotondi diritti ● 160 mm
- 3 giravite lama piatta ● 3,5x100-5,5x125-6,5x150 mm
- 3 giravite per viti con impronta a croce Phillips® ⊕ PH0x60-PH1x80-PH2x100 mm

Beta N.	TR
860MIX/A31	MCT1
895/1	MCT1
900	MCT1
900/...	MCT1
900/25	MCT1
900BG/30C	MCT1
900/42	MCT1
900/55	MCT1
920A	MCT1
920/25	MCT1
920AN/125	MCT1
920/42	MCT1
920/55	MCT1
42	MCT2
96/SC9	MCT2
111E	MCT2
1128BMX	MCT2
1692/5	MCT2
1771	MCT2
1048N	MCT3
1082BM	MCT3
1150BM	MCT3
1166BM	MCT3
1260	MCT3
1262	MCT3



MC T1



MC T2



MC T3

5988U/7M

assortimento di 215 utensili in vassoio morbido in EVA

► Universali

N. pezzi/Descrizione

- 22 chiavi combinate 6-7-8-9-10-11-12-13-14-15-16-17-18-19-20-21-22-24-27-30-32-36 mm
- 8 chiavi a forchetta 6x7-8x9-10x11-12x13-14x15-16x17-18x19-20x22 mm
- 9 chiavi maschio esagonale piegate \odot 1,5+10 mm
- 7 inserti maschio esagonale \odot 4-5-6-7-8-10-12 mm
- 7 inserti maschio esagonale \odot 4-5-6-7-8-10-12 mm
- 5 inserti a profilo XZN[®] \odot 5-6-8-10-12 mm
- 5 inserti a profilo XZN[®] \odot 5-6-8-10-12 mm
- 7 inserti per viti con impronta Torx[®] \odot T20-T25-T30-T40-T45-T50-T55
- 6 inserti per viti con impronta Torx[®] \odot T25-T30-T40-T45-T50-T55
- 7 inserti per viti con impronta Tamper Resistant Torx[®] \odot T20-T25-T30-T40-T45-T50-T55
- 1 bussole portainseri per 867
- 1 bussole portainseri per 867
- 1 bussola portainseri
- 1 bussola portainseri
- 1 bussola portainseri
- 13 chiavi a bussola esagonali 1/4" \odot 4-4,5-5-5,5-6-7-8-9-10-11-12-13-14 mm
- 9 chiavi a bussola a mano lunghe bocca esagonale \odot 5-6-7-8-9-10-11-12-13 mm
- 5 chiavi a bussola maschio esagonale 1/4" \odot 3-4-5-6-7 mm
- 4 chiavi a bussola a giravite per viti con intaglio \bullet 0,8x4-1x5,5-1,2x6,5-1,2x8 mm
- 4 chiavi a bussola a giravite per viti con impronta a croce Phillips[®] \oplus PH1-PH2-PH3-PH4
- 7 chiavi a bussola a giravite maschio per viti con impronta Torx[®] \odot T10-T15-T20-T25-T27-T30-T40
- 1 prolunga - 1/4" 50 mm
- 1 prolunga - 1/4" 100 mm
- 1 prolunga - 1/4" 150 mm
- 1 snodo 1/4"
- 1 quadro con impugnatura 1/4"
- 1 quadro scorrevole 1/4"
- 1 cricchetto reversibile 1/4" \oplus
- 21 chiavi a bussola esagonali 1/2" \odot 8-10-11-12-13-14-15-16-17-18-19-20-21-22-23-24-26-27-28-30-32 mm
- 1 raccordo con attacco quadro
- 1 snodo 1/2"
- 1 prolunga angolare - 1/2" 125 mm
- 1 prolunga angolare - 1/2" 250 mm
- 1 quadro maschio 1/2" con spina scorrevole
- 1 cricchetto reversibile 1/2" \oplus
- 8 chiavi a bussola 1/2" per viti con teste a profilo Torx[®] \odot 10-12-14-16-18-20-22-24 mm
- 11 chiavi a bussola a mano lunghe bocca esagonale \odot 10-12-13-14-15-16-17-18-19-21-22
- 1 tronchesi a grande effetto taglienti diagonali ∇ 160 mm
- 1 pinza universale \equiv 180 mm
- 1 pinza a becchi mezzotondi dritti \bullet 160 mm
- 6 giravite lama piatta \bullet 2,5x50-3x75-4x100-5,5x125-6,5x150-8x200 mm
- 1 giravite per viti a testa con intaglio \bullet 4x30 mm
- 4 giravite Phillips[®] \oplus PH0x60-PH1x80-PH2x100-PH3x150 mm
- 1 giravite Phillips[®] \oplus PH1X30 mm
- 12 chiavi maschio con impugnatura per viti con impronta Torx[®] \odot T6-T7-T8-T9-T10-T15-T20-T25-T27-T30-T40-T45
- 1 giravite cercafase \bullet
- 2 scalpelli piatti nervati 100-200 mm
- 1 martello tipo tedesco 300 g
- 1 mazzuola con battenti in materiale plastico \varnothing 35 mm

Beta N.	TR
42	M01
55	M33
96/SC9	M33
867PE	M86
867PE/L	M86
867XZN	M86
867XZNL	M86
867TX	M86
867TXL	M86
867RTX	M86
867/1	M86
867/2	M86
895/1	M100
895/3	M100
895/6	M100
900	M100
900L	M100
900ME	M100
900LP	M100
900PH	M100
900TX	M100
900/20	M100
900/20L	M100
900/21	M100
900/25	M100
900BG/30	M100
900/42	M100
900/55	M100
920A	M100
920/15	M100
920/25	M100
920AN/125	M100
920AN/250	M100
920/42	M100
920/55	M100
920FTX	M100
920AL	M100
1084BM	M136
1150BM	M136
1166BM	M136
1201E	M213
1201EN	M213
1202E	M213
1202EN	M213
1207E/TX	M213
1253	M213
35	M234
1370	M234
1390	M234



M01



M100



M213



M33 M86 M136 M234



5915VU/0

assortimento di 35 utensili

► Universali

N. pezzi/Descrizione

- 1 bulino 4 mm
- 1 scalpelli piatti nervati 125 mm
- 8 chiavi a forchetta 6x7-8x9-10x11-12x13-14x15-16x17-18x19-20x22 mm
- 7 chiavi maschio esagonale \odot 1,5-2-2,5-3-4-5-6 mm
- 1 chiave regolabile a rullino 150 mm
- 1 pinze regolabili cerniera chiusa 250 mm
- 1 tronchesi a taglienti diagonali, finitura industriale \llcorner 160 mm
- 1 forbici per elettricisti lame diritte
- 1 pinze universali a grande effetto, finitura industriale \equiv 180 mm
- 1 pinze a becchi mezzotondi lunghissimi, diritti zigrinati manici ricoperti con 2 strati di PVC antiscivolo, finitura industriale \bullet 160 mm
- 4 giravite lama piatta \bullet 3x75-4x100-5,5x100-6,5x150 mm
- 3 giravite Phillips® \oplus PH0x60-PH1x80-PH2x100 mm
- 1 martello tipo tedesco 300 g
- 1 flessometro 3 m
- 1 cutter con lama a settori 18 mm
- 1 coltello soccorso auto
- 1 torcia LED ad alta luminosità, fino a 500 Lumen

Beta N.

- 32
- 35
- 55
- 96/BGS7
- 111E
- 1048N
- 1082G
- 1128BMX
- 1150G
- 1166G
- 1201E
- 1202E
- 1370
- 1692/3
- 1771
- 1778SOS
- 1833S

5915VU/0

059151021

Assortimento consigliato in abbinamento con C4 - C5 - C5S - C6T



5915VU/1

assortimento di 45 utensili

► Universali

N. pezzi/Descrizione

- 2 punzoni \varnothing 2-3 mm
- 1 bulino \varnothing 4 mm
- 2 scalpelli piatti 125-150 mm
- 1 ugnetti 150 mm
- 14 chiavi combinate 6+14 - 17 - 19 - 21 - 22 - 24 mm
- 9 chiavi maschio esagonale piegate \odot 1,5 - 2 - 2,5 - 3 - 4 - 5 - 6 - 8 - 10 mm
- 1 chiave regolabile a rullino 250 mm
- 1 pinze regolabili cerniera chiusa 250 mm
- 1 tronchesi a taglienti diagonali, finitura industriale \llcorner 160 mm
- 1 forbici per elettricisti lame diritte
- 1 pinze universali a grande effetto, finitura industriale \equiv 180 mm
- 1 pinze a becchi mezzotondi lunghissimi, diritti zigrinati manici ricoperti con 2 strati di PVC antiscivolo, finitura industriale \bullet 160 mm
- 4 giravite lama piatta \bullet 3x75 - 4x100 - 5,5x100 - 6,5x150 mm
- 3 giravite Phillips® \oplus PH0x60 - PH1x80 - PH2x100 mm
- 1 martello tipo tedesco 300 g
- 1 flessometro 5 m
- 1 cutter con lama a settori

Beta N.

- 30
- 32
- 34
- 36
- 42
- 96/SC9
- 111E
- 1048N
- 1082G
- 1128BMX
- 1150G
- 1166G
- 1201E
- 1202E
- 1370
- 1692
- 1771

5915VU/1

059151024

Assortimento consigliato in abbinamento con C8 - C9 - C10 - C10S - C11 - CP15 - CP15L - C16 - CP17 - CP17L - C18



5915VU/2

assortimento di 49 utensili

► Universali

N. pezzi/Descrizione

- 8 chiavi a forchetta 6x7 - 8x9 - 10x11 - 12x13 - 14x15
16x17 - 18x19 - 20x22 mm
- 9 chiavi maschio esagonale piegate \odot 1,5 - 2 - 2,5 - 3 - 4 - 5 - 6 - 8 - 10 mm
- 13 chiavi a bussola esagonali 1/4" \odot 4 - 4,5 - 5 - 5,5 - 6 - 7 - 8 - 9 - 10 - 11 - 12 - 13 - 14 mm
- 1 prolunga - 1/4" 150 mm
- 1 snodo 1/4"
- 1 quadro con impugnatura 1/4"
- 1 quadro scorrevole 1/4"
- 1 cricchetto reversibile 1/4" \otimes
- 1 pinze regolabili cerniera chiusa 250 mm
- 1 forbici per elettricisti lame diritte
- 1 pinze universali a grande effetto, finitura industriale \equiv 180 mm
- 4 giravite lama piatta \bullet 3x75 - 4x100 - 5,5x150 - 6,5x150 mm
- 3 giravite Phillips® \oplus PH0x60 - PH1x80 - PH2x100 mm
- 1 martello tipo tedesco 300 g
- 1 flessometro 3 m
- 1 oliatore in plastica 30 cc
- 1 cutter con lama a settori 18 mm

Beta N.
55/B8N
96/SC9
900
900/21
900/25
900BG/30
900/42
900/55
1048N
1128BMX
1150G
1201E
1202E
1370
1692
1755
1771

5915VU/2

059151027

Assortimento consigliato in abbinamento con C7 - CP15 - C20 - C20L



5915VU/3

assortimento di 74 utensili

► Universali

N. pezzi/Descrizione

- 1 cacciaspina \varnothing 4 mm
- 1 bulino \varnothing 4 mm
- 1 scalpelli piatti 150 mm
- 14 chiavi combinate 6-7-8-10-11-12-13-14-15-16-17-19-22-24 mm
- 9 chiavi maschio esagonale piegate \odot 1,5-10 mm
- 3 chiavi maschio esagonale con impugnatura \odot 4 - 5 - 6 mm
- 1 chiave regolabile a rullino 250 mm
- 13 chiavi a bussola esagonali 1/2" \odot 8-17 - 19 - 22 - 24 mm
- 1 prolunga - 1/2" 125 mm
- 1 prolunga - 1/2" 255 mm
- 1 snodo 1/2"
- 1 quadro maschio 1/2" con spina scorrevole
- 1 cricchetto reversibile 1/2" \otimes
- 8 chiavi a tubo doppie serie leggera 6x7 - 8x9 - 10x11 - 12x13 - 14x15 - 16x17 - 18x19 - 20x22 mm
- 2 spine di manovra per chiavi a tubo 1 - 2
- 1 pinze regolabili cerniera chiusa 250 mm
- 1 pinza autobloccante 240 mm
- 1 tronchesi a grande effetto, a taglienti diagonali, finitura industriale ∇ 160 mm
- 1 forbici per elettricisti lame diritte
- 1 pinze universali a grande effetto, finitura industriale \equiv 180 mm
- 1 pinze a becchi mezzotondi lunghissimi, diritti zigrinati manici ricoperti con 2 strati di PVC anticiscivo, finitura industriale \bullet 160 mm
- 4 giravite lama piatta \bullet 3x75 - 4x100 - 5,5x150 - 6,5x150 mm
- 3 giravite Phillips® \oplus PH0x60 - PH1x80 - PH2x100 mm
- 1 martello tipo tedesco 400 g
- 1 flessometro 5 m
- 1 seghetto
- 1 oliatore in plastica 150 cc
- 1 cutter con lama a settori

Beta N.
31
32
34
42
96/SC9
96T
111E
920A
920/21
920/22
920/25
920/42
920/55
935
940
1048VN
1052
1084G
1128BMX
1150G
1166G
1201E
1202E
1370
1692
1726
1755
1771

5915VU/3

059151028

Assortimento consigliato in abbinamento con C7 - C9 - C10 - C10S - C11 - CP15L - C16 - CP17 - CP17L - C19 - C19L - C20 - C20L



5915VU/4

assortimento di 80 utensili

► Universali

N. pezzi/Descrizione	Beta N.
1 cacciaspina Ø 4 mm	31
1 bulino Ø 4 mm	32
1 scalpelli piatti 150 mm	34
15 chiavi combinate 6-7-8-9-10-11-12-13-14-15-16-17-19-22-24 mm	42
9 chiavi maschio esagonale piegate \odot 1,5+10 mm	96/SC9
1 chiave regolabile a rullino 250 mm	111E
13 chiavi a bussola esagonali 1/2" \odot 8+17 - 19 - 22 - 24 mm	920A
1 prolunga - 1/2" 255 mm	920/22
1 snodo 1/2"	920/25
1 quadro maschio 1/2" con spina scorrevole	920/42
1 cricchetto reversibile 1/2" \otimes	920/55
17 chiavi a pipa doppie esagonali - poligonali 6+22 mm	932/S17
1 pinze a becchi mezzotondi lunghissimi, diritti zigrinati, impugnatura bimatereale, finitura industriale \llcorner 160 mm	1048N
1 pinza autobloccante 240 mm	1052
1 tronchese a grande effetto, a taglienti diagonali, finitura industriale \llcorner 160 mm	1084GBM
1 forbici per elettricisti lame dritte	1128BMX
1 pinze universali a grande effetto, finitura industriale \llcorner 180 mm	1150GBM
1 pinze a becchi mezzotondi lunghissimi, diritti zigrinati, impugnatura bimatereale, finitura industriale \bullet 160 mm	1166GBM
4 giravite lama piatta \bullet 3x75 - 4x100 - 5,5x150 - 6,5x150 mm	1201E
3 giravite Phillips® \oplus PH0x60 - PH1x80 - PH2x100 mm	1202E
1 martello tipo francese 32 mm	1370F
1 flessometro 5 m	1692
1 seghetto	1726
1 oliatore in plastica 150 cc	1755
1 cutter con lama a settori	1771

5915VU/4

059151045

Assortimento consigliato in abbinamento con C20 - C20L



5915VU/5

assortimento di 111 utensili

► Universali

N. pezzi/Descrizione	Beta N.
1 cacciaspina Ø 4 mm	31
1 bulino Ø 4 mm	32
1 scalpelli piatti 150 mm	34
17 chiavi combinate 6-7-8-9-10-11-12-13-14-15-16-17-18-19-20-21-22 mm	42
8 chiavi a forchetta 6x7-8x9-10x11-12x13-14x15-16x17-18x19-20x22 mm	55/S8
9 chiavi maschio esagonale piegate con estremità sferica \odot	96BPC/SC9
1 chiave regolabile a rullino 250 mm	111E
39 Serie di bussole \boxplus e accessori, in cassetta	900/C11
13 Serie di bussole \boxtimes e accessori, in cassetta	920A/C11
1 pinze regolabili cerniera chiusa 250 mm	1048N
1 pinza autobloccante 240 mm	1052
1 tronchese a taglienti diagonali, finitura industriale \llcorner 160 mm	1082G
1 tenaglie per cementisti 220 mm	1098
1 forbici per elettricisti lame dritte	1128BMX
1 pinze universali a grande effetto, finitura industriale \llcorner 180 mm	1150G
1 pinze a becchi mezzotondi lunghissimi, diritti zigrinati manici ricoperti con 2 strati di PVC antiscivolo, finitura industriale \bullet 160 mm	1166G
4 giravite lama piatta \bullet 3x75 - 4x100 - 5,5x100 - 6,5x150 mm	1201E
3 giravite Phillips® \oplus PH0x60 - PH1x80 - PH2x100 mm	1202E
1 martello tipo tedesco 300 g	1370
1 mazzuola con battenti in materiale plastico Ø 35 mm	1390
1 flessometro 3 m	1692/3
1 lime a taglio mezzodolce	1719BMA8/M
1 seghetto 440 mm	1726
1 cutter con lama a settori 18 mm	1771BM
1 torcia LED per ispezioni	1833XS/2

5915VU/5

059151046

Assortimento consigliato in abbinamento con C12 - C41H - C41S - C42H

5915VU/AS

assortimento di 68 utensili

► Universali

N. pezzi/Descrizione

- 1 cacciaspina Ø 4 mm
- 1 bulino Ø 4 mm
- 1 scalpelli piatti 150 mm
- 13 chiavi combinate 1/4 - 5/16 - 3/8 - 7/16 - 1/2 - 9/16 - 5/8 - 11/16 - 3/4 - 13/16 - 7/8 - 15/16 - 1"
- 8 chiavi poligonali curve 1/4"÷1"
- 9 chiavi maschio esagonale piegate brunate ○ 3/64"÷3/8"
- 1 chiave regolabile a rullino 250 mm
- 11 chiavi a bussola poligonali □ 1/2" ○ 3/8 - 7/16 - 1/2 - 9/16 - 5/8 - 11/16 - 3/4 - 13/16 - 7/8 - 15/16 - 1"
- 1 prolunga - 1/2" 125 mm
- 1 prolunga - 1/2" 255 mm
- 1 snodo 1/2"
- 1 quadro maschio 1/2" con spina scorrevole
- 1 cricchetto reversibile 1/2" ⊕
- 1 pinze regolabili cerniera chiusa 250 mm
- 1 pinza autobloccante 240 mm
- 1 tronchesi a grande effetto, a taglienti diagonali, finitura industriale 160 mm
- 1 forbici per elettricisti lame diritte
- 1 pinze universali a grande effetto, finitura industriale = 180 mm
- 1 pinze a becchi mezzotondi lunghissimi, diritti zigrinati, impugnatura bimateriale, finitura industriale ● 160 mm
- 4 giravite lama piatta ● 3x75 - 4x100 - 5,5x150 - 6,5x150 mm
- 3 giravite Phillips® ⊕ PH0x60 - PH1x80 - PH2x100 mm
- 1 martello tipo tedesco 300 g
- 1 flessometro 5 m
- 1 seghetto
- 1 oliatore in plastica 150 cc
- 1 cutter con lama a settori

Beta N.

- 31
- 32
- 34
- 42AS
- 90AS/8
- 96AS/SC9
- 111E
- 920AS
- 920/21
- 920/22
- 920/25
- 920/42
- 920/55
- 1048N
- 1052
- 1084GBM
- 1128BMX
- 1150GBM
- 1166GBM
- 1201E
- 1202E
- 1370
- 1692
- 1726
- 1755
- 1771

5915VU/AS

059151032

Assortimento consigliato in abbinamento con C10 - C20 - C20L

5927VU/M

assortimento di 108 utensili in vassoio morbido in EVA

► Universali

N. pezzi/Descrizione

- 16 chiavi combinate 6-7-8-9-10-11-12-13-14-15-16-17-18-19-21-22 mm
- 1 tronchesi a grande effetto taglienti diagonali 160 mm
- 9 chiavi maschio esagonale piegate ○ 1,5-2-2,5-3-4-5-6-8-10 mm
- 1 pinza universale = 180 mm
- 1 pinza a becchi mezzotondi diritti ● 160 mm
- 3 giravite lama piatta ● 3,5x100-5,5x150-6,5x150 mm
- 3 giravite Phillips® ⊕ PH0x3x60-PH1x4,5x80-PH2x6x100 mm
- 31 inserti colorati con portainseri magnetico in astuccio tascabile ● ○ ⊕ ⊕ ⊕ ⊕
- 1 pinze regolabili cerniera chiusa 250 mm
- 1 martello tipo tedesco 300 mm
- 1 bulino 4 mm
- 1 ugnetti 4 mm
- 13 chiavi a bussola esagonali 1/4" ○ 4-4,5-5-5,5-6-7-8-9-10-11-12-13-14 mm
- 1 prolunga - 1/4" 150 mm
- 1 snodo 1/4"
- 1 quadro maschio 1/4"
- 1 quadro scorrevole 1/4"
- 1 cricchetto reversibile 1/4" ⊕
- 16 chiavi a bussola esagonali 1/2" ○ 10-11-12-13-14-15-16-17-18-19-21-22-24-27-30-32 mm
- 1 snodo 1/2"
- 1 prolunga angolare - 1/2" 125 mm
- 1 quadro scorrevole 1/4"
- 1 cricchetto reversibile 1/2" ⊕
- 1 bussola portainseri

Beta N. TR

- 42 MC10
- 1084BM MC10
- 96SC9 MC10
- 1150BM MC10
- 1166BM MC10
- 1201E MC10
- 1202E MC10
- 860MIX/A31 MC20
- 1048N MC20
- 1370 MC20
- 32 MC20
- 36 MC20
- 900 MC20
- 900/21 MC20
- 900/25 MC20
- 900BG/30C MC20
- 900/42 MC20
- 900/55 MC20
- 920A MC20
- 920/25 MC20
- 920/25 MC20
- 920AN/125 MC20
- 900/42 MC20
- 920/55 MC20
- 895/1 MC20

5927VU/M

059271021

Assortimento consigliato in abbinamento con RSC22 - RSC23 - RSC23C - C27S

5938U/2T

assortimento di 210 utensili in termoformato rigido in ABS

► Universali

N. pezzi/Descrizione

- 7 giravite lama piatta ● 2,5x50 - 3x75 - 3,5x100 - 4x125
5,5x100 - 5,5x150 - 6,5x150 mm
- 6 giravite Phillips® ● PH0x60-PH1x80-PH1x120-PH2x100-PH2x150-PH3x150 mm
- 7 chiavi maschio con impugnatura per viti con impronta Torx® ○ T6-T7-T8-T9-T10-T15-T20
- 1 pinze becchi dritti per anelli elastici, per fori ○ 180 mm
- 1 pinze becchi piegati per anelli elastici, per fori ○ 170 mm
- 1 pinze becchi dritti per anelli elastici, per alberi ● 175 mm
- 1 pinze becchi piegati per anelli elastici, per alberi ● 175 mm
- 1 pinze regolabili cerniera chiusa 250 mm
- 1 pinza autobloccante 240 mm
- 1 tronchesi a grande effetto taglienti diagonali ◄ 160 mm
- 1 pinza universale = 180 mm
- 1 pinza a becchi mezzotondi dritti ● 160 mm
- 1 chiave portainseri a cricchetto reversibile 1/4x5/16
- 13 chiavi a bussola esagonali 1/4" ○ 4-4,5-5-5,5-6-7-8-9-10-11-12-13-14 mm
- 1 cricchetto reversibile 1/4" ● 125 mm
- 1 quadro scorrevole 1/4" 115 mm
- 1 quadro con impugnatura 1/4" 176 mm
- 1 snodo 1/4" 41 mm
- 1 prolunga - 1/4" 150 mm
- 1 portainseri a sgancio rapido con impugnatura 230 mm
- 5 inserti per avvitatori per viti con impronta Spanner ● 4-6-8-10-12 mm
- 8 inserti per avvitatori per viti con impronta Torq-Set® ● 0-1-2-3-4-5-6-8 mm
- 6 inserti per avvitatori per viti con impronta Tri-Wing® ● 1-2-3-4-5-6 mm
- 8 inserti per avvitatori per viti con impronta Tamper Resistant Torx® ● T9-T10-T15-T20-T25-T27-T30-T40
- 11 inserti per avvitatori per viti con impronta Torx® ○ T6-T7-T8-T9-T10-T15-T20-T25-T27-T30-T40
- 3 inserti per avvitatori per viti con impronta a croce Pozidriv® - Supadriv® ● PZ1 - PZ2 - PZ3
- 4 inserti per avvitatori per viti con impronta a croce Phillips® ● PH0 - PH1 - PH2 - PH3
- 8 inserti maschio esagonale per avvitatori ○ 2 - 2,5 - 3 - 4 - 5 - 6 - 8 - 10 mm
- 7 inserti per avvitatori per viti a testa con intaglio ● 0,5x3 - 0,6x4,5 - 0,8x5,5 - 1x5,5 - 1,2x6,5 - 1,2x8 - 1,6x8 mm
- 2 scalpelli piatti nervati 100 - 200 mm
- 1 martello tipo tedesco 300 g
- 1 mazzuola con battenti in materiale plastico Ø 35 mm
- 1 flessometro 5 m
- 1 miniseghetto
- 1 oliatore in plastica
- 1 cutter con lama a settori
- 19 chiavi a bussola esagonali 1/2" ○ 10 - 11 - 12+19 - 20 - 21 - 22 - 23 - 24
26 - 27 - 30 - 32 mm
- 5 chiavi a bussola maschio esagonale 1/2" ○ 5 - 6 - 8 - 10 - 12 mm
- 1 prolunga - 1/2" 125 mm
- 1 prolunga - 1/2" 255 mm
- 1 snodo 1/2"
- 1 quadro maschio 1/2" con spina scorrevole
- 1 cricchetto reversibile 1/2" ●
- 1 bulino Ø 4 mm
- 6 cacciaspina con impugnatura 2-3-4-5-6-8 mm
- 17 chiavi combinate 6-7-8-10-11-12-13-14-16-17-18-19-21-22-24-27-30 mm
- 8 chiavi a forchetta 6x7 - 8x9 - 10x11 - 12x13 - 14x15 - 16x17 - 18x19 - 20x22 mm
- 9 chiavi maschio esagonale piegate ○
- 6 chiavi a T maschio esagonale ○ 2,5 - 3 - 4 - 5 - 6 - 8 mm
- 5 lime a taglio mezzodolce 200 mm
- 11 chiavi maschio esagonale con impugnatura ○ 2 - 2,5 - 3 - 3,5 - 4 - 4,5 - 5 - 6 mm
- 4 termoformati vuoti
- 4 termoformati vuoti

Beta N.	TR
1201E	T211
1202E	T213
1207E/TX	T216
1032	T145
1034	T145
1036	T145
1038	T145
1048N	T153
1052	T153
1084BM	T137
1150BM	T137
1166BM	T137
194	T85
900	T85
900/55	T85
900/42	T85
900BG/30	T85
900/25	T85
900/21	T85
851SR	T85
861SP	T85
861TQS	T85
861TRW	T85
861RTX	T85
861TX	T85
861PZ	T85
861PH	T85
861PE	T85
861LP	T85
35	T234
1370	T234
1390	T234
1692	T289
1725CR	T289
1755	T289
1771	T289
920A	T80
920ME	T80
920/21	T80
920/22	T80
920/25	T80
920/42	T80
920/55	T80
32	T239
31BM	T239
42	T01
55	T33
96/SC9	T33
951	T68
1719BMA8/S5	T236
96T	T50
VP-3SC	VP-3SC
VP-LS	VP-LS
VP-LD	VP-LD



5938U/2T

059381062

Assortimento consigliato in abbinamento con C38



5957U-P

assortimento di 133 utensili - accessori di fissaggio inclusi

► Universali

N. pezzi/Descrizione	Beta N.
6 cacciaspina 2 ÷ 8 mm	31/SP6
6 2 punzoni, 1 bulino, 3 scalpelli con supporto	38/SP6
17 serie di chiavi combinate 6÷22 - 24 - 27 - 30 - 32 mm	42/S17X
12 chiavi a forchetta 6x7 ÷ 30x32 mm	55/S12X
8 chiavi maschio esagonale con impugnatura 2 ÷ 10 mm	96T/S8
8 chiavi maschio piegate	97TX/SC8
per viti con impronta Torx® ⌘ T9 ÷ T40	
1 chiave regolabile a rullino 250 mm	111E
13 chiavi a bussola esagonali 1/2" con guida ⌀ 10 ÷ 22 mm	920A/SB13
8 chiavi a bussola esagonali 1/2" con guida ⌀ 23 ÷ 32 mm	920A/SB8
7 chiavi a bussola a giravite	920LH/SB7
per viti con impronta a croce Phillips® ⌚	
⊕ 1,2x65 - 1,2x8 - 1,6x9 - 2x12mm - PH1-PH2-PH3	
1 pinze becchi dritti per anelli elastici, per fori ⌀ 180 mm	1032
1 pinze becchi piegati per anelli elastici, per fori ⌀ 170 mm	1034
1 pinze becchi dritti per anelli elastici, per alberi ● 175 mm	1036
1 pinze becchi piegati per anelli elastici, per alberi ● 175 mm	1038
1 pinze regolabili cerniera chiusa 250 mm	1048N
1 pinza autobloccante 240 mm	1052
1 cesoia a lame larghe diritte 250 mm	1112
1 forbici per elettricisti lame diritte	1128BMX
8 giravite 2,5x50 - 3x75 - 4x100 - 5,5x125 - 6,5x150 - PH0 - PH1 - PH2	1263/D8
2 martello tipo tedesco 300 - 600 g	1370
1 mazzuola con battenti in materiale plastico 35	1390
1 flessometro 5 m	1692/5
1 flessibile magnetico	1712E/2
1 raschietto a due taglienti 200 mm	1717A
1 raschietto a tre taglienti 200 mm	1717B
5 lime a taglio mezzodolce 200 mm	1719BMA8/S5
1 oliatore in metallo a pressione 200 cc	1751N
1 cutter con lama a settori	1771BM
1 prolunga - 1/2" 125 mm	920/21
1 prolunga - 1/2" 250 mm	920/22
1 snodo 1/2"	920/25
1 quadro maschio 1/2" con spina scorrevole	920/42
1 cricchetto reversibile 1/2" Ⓢ	920/55
1 leva con estremità a punta e piatta curva	963
1 tronchesi a taglienti diagonali ≤ 160 mm	1082BM
1 tronchesi a grande effetto taglienti diagonali ≤ 160 mm	1084BM
1 tronchesi doppia leva taglio frontale ≤ 180 mm	1092V
1 pinza universale = 180 mm	1150BM
1 pinza a becchi mezzotondi dritti ● 160 mm	1166BM
1 pinza a becchi mezzotondi piegati ● 160 mm	1168BM
2 giravite lama piatta ● 8x200 - 10x200 mm	1260
1 giravite per viti con impronta a croce Phillips® ⌚ PH3 8x150mm	1262
1 calibro a corsoio	1650
1 seghetto 420 mm	1725



5958U

assortimento di 85 utensili - accessori di fissaggio inclusi

► Universali

N. pezzi/Descrizione	Beta N.
17 chiavi combinate 6÷22 mm	42
12 chiavi maschio esagonale piegate \odot 2÷10 mm	96N/SC12
13 chiavi a bussola esagonali 1/2" con guida \odot 10÷22 mm	920A/SB13
8 chiavi a bussola esagonali 1/2" con guida \odot 23÷32 mm	920A/SB8
1 prolunga - 1/2" 125 mm	920/21
1 prolunga - 1/2" 255 mm	920/22
1 snodo 1/2"	920/25
1 quadro maschio 1/2" con spina scorrevole	920/42
1 cricchetto reversibile 1/2" \otimes	920/55
1 pinze becchi dritti per anelli elastici, per fori \odot 180 mm	1032
1 pinze becchi dritti per anelli elastici, per alberi \bullet 175 mm	1036
1 pinze regolabili cerniera chiusa 250 mm	1048N
1 pinza autobloccante 240 mm	1052
1 tronchesi a grande effetto taglienti diagonali ∇ 160 mm	1084BM
1 forbici per elettricisti lame diritte	1128BMX
1 pinza universale \equiv 180 mm	1150BM
1 pinza a becchi mezzotondi dritti \bullet 160 mm	1166BM
7 giravite lama piatta \bullet 3x75 - 3,5x100 - 4x125	1260
5,5x150 - 6,5x150 - 8x200 - 10x200 mm	
4 giravite Phillips \oplus PH0x60 - PH1x80	1262/S4
PH2x100 - PH3x150 mm	
1 martello tipo tedesco 300 g	1370
1 mazzuola con battenti in materiale plastico \varnothing 35 mm	1390
1 flessometro 5 m	1692
5 serie di 5 lime 200 mm	1719BMA...S5
1 seghetto	1725
1 oliatore in plastica a pressione 150 cc	1754
1 cutter con lama a settori	1771



5990V1

assortimento di 44 utensili per valigetta portautensili COMBO C99V1, in vassoio morbido in EVA

► Universali

N. pezzi/Descrizione

- 9 chiavi maschio esagonale piegate con estremità sferica ○
- 1 cutter con lama a settori 18 mm
- 1 pinze regolabili cerniera chiusa 250 mm
- 6 2 punzoni, 1 bulino, 2 scalpelli piatti e 1 ugnetto in busta avvolgibile in poliestere
- 3 giravite lama piatta ● 3,5x100-5,5x125-6,5x150 mm
- 3 giravite per viti con impronta a croce Phillips® ⊕ PH0x60-PH1x80-PH2x100 mm
- 1 forbici per elettricisti lame diritte
- 16 chiavi combinate 6-7-8-9-10-11-12-13-14-15-16-17-18-19-21-22 mm
- 1 flessometro 5 mt
- 1 martello tipo tedesco 300 g
- 1 tronchesi a taglienti diagonali, finitura industriale ✂ 160 mm
- 1 pinze universali a grande effetto, finitura industriale = 180 mm

Beta N.
96BPC/SC9
1771
1048N
38/B6N
1260
1262
1128BMX
42
1692/5
1370
1082GBM
1150GBM



5990V1

059900001

Assortimento consigliato in abbinamento con C99V1



5990V3

assortimento di 116 utensili per valigetta portautensili COMBO C99V3/2C, in vassoio morbido in EVA

► Autoriparazione

N. pezzi/Descrizione

- 5 chiavi maschio esagonale con impugnatura
- 1 chiave regolabile a rullino 250 mm
- 1 quadro con impugnatura 1/4"
- 1 giravite cercafase ●
- 1 livella tascabile con base a "V"
- 1 torcia LED per ispezioni
- 31 inserti colorati con portainseri magnetico in astuccio tascabile ● ○ ⊕ ⊕ ⊕ ⊕
- 1 bussola portainseri
- 12 chiavi a bussola esagonali 1/4" ○ 4-4,5-5-5,5-6-7-8-9-10-11-12-13 mm
- 1 prolunga - 1/4" 50 mm
- 1 prolunga - 1/4" 100 mm
- 1 quadro scorrevole 1/4"
- 1 cricchetto reversibile con attacco quadro maschio 1/4" ⊕
- 38 microgiravite con 36 inserti intercambiabili da 4 mm e prolunga magnetica
- 1 mazzuola con battenti in materiale plastico Ø 35mm
- 1 snodo 1/4"
- 13 chiavi a bussola esagonali 1/2" ○ 10-11-12-13-14-15-16-17-18-19-20-21-22 mm
- 1 prolunga - 1/2" 125 mm
- 1 prolunga - 1/2" 255 mm
- 1 snodo 1/2"
- 1 quadro maschio 1/2" con spina scorrevole
- 1 cricchetto reversibile 1/2" ⊕

Beta N.
96T/S5P
111E
900BG/30
1253
1695XS
1833XS/2
860MIX/A31
895
900
900/20
900/20L
900/42
900/55Z
1256/C36-2
1390
900/25
920A
920/21
920/22
920/25
920/42
920/55



5990V3

059900003

Assortimento consigliato in abbinamento con C99V3/2C





5980U/BIKE

assortimento di 90 utensili

► Riparazione biciclette

N. pezzi/Descrizione	Beta N.
5 chiavi combinate 8-9-10-13-14 mm	42
9 serie di chiavi maschio esagonale piegate con estremità sferica ○ 1,5-2-2,5-3-4-5-6-8-10 mm	96BP/SC9
8 chiavi maschio esagonale con impugnatura 2-2,5-3-4-5-6-8-10 mm	96T/S8
8 chiavi maschio con impugnatura per viti con impronta Torx® ⊕ T8-T10-T15-T20-T25-T27-T30-T40	97TTX/S8
1 chiavi regolabili a rullino cromate corte con apertura maggiorata 170 mm	111CM
1 tagliatubi per rame e leghe leggere	334
1 chiavi dinamometriche a scatto con cricchetto reversibile 2+10 Nm	605E
13 chiavi a bussola a mano bocca esagonale ○ 4-4,5-5-5,5-6-7-8-9-10-11-12-13-14 mm	900/SB13
1 prolunga - 1/4"	900/21
1 snodo 1/4"	900/25
1 cricchetto reversibile 1/4" ⊕	900/55
1 tronchesi a taglienti diagonali, finitura industriale 160 mm	1082G
1 forbici per elettricisti lame dritte 145 mm	1128BM
1 pinze universali a grande effetto, finitura industriale = 180 mm	1150G
1 pinze a becchi mezzotondi lunghissimi, dritti zigrinati manici ricoperti con 2 strati di PVC antiscivolo, finitura industriale ● 180 mm	1166G
7 serie giravite 3x75-4x125-5,5x150-6,5x150-PH0x60-PH1x80-PH2x100 mm	1203E/D
1 martello tipo tedesco 300 g	1370
1 mazzuola con battenti in materiale plastico Ø 35 mm	1390
1 calibro a corsoio 150 mm	1650
1 flessometro 3 m	1692/3
1 lima 200 mm	1719BMA...P
1 lima 200 mm	1719BMA...M
1 lima 200 mm	1719BMA...R
1 seghetto 300 mm	1725
1 cutter con lama a settori	1771
1 indicatore usura catena 120 mm	3935
1 pinza per falsamaglia 170 mm	3937
7 chiavi coniche semplici 13-14-15-16-17-18-19 mm	3952/S7
1 chiave per pedali 15 mm	3953
1 tiraraggi nero 3,2mm □	3961 3,2
1 tiraraggi verde 3,3 mm □	3961 3,3
1 tiraraggi rosso 3,5 mm □ 3	3961 3,5
1 tiraraggi professionale □ 3,2 - 4,0 mm	3961U
1 chiave frusta smonta-pignoni 289 mm	3967
1 levagomme 200 mm	3969
3 kit di 3 levagomme, in plastica 113 mm	3969K3
1 leva per arretrare pastiglie freni a disco 222 mm	3991
1 chiave per raddrizzare dischi freno 234 mm	3992

5988H/7M

assortimento di 333 utensili in vassoio morbido in EVA

► Autoriparazione

N. pezzi/Descrizione

- 13 chiavi a bussola a mano lunghe bocca esagonale ○ 8-9-10-11-12-13-14-15-16-17-19-21-22 mm
- 16 chiavi a bussola a mano lunghe bocca esagonale ○ 10-12-13-14-15-16-17-18-19-21-22-23-24-27-30-32 mm
- 7 chiavi a bussola 1/2" per viti con teste a profilo Torx® ○ E12-E14-E16-E18-E20-E22-E24
- 10 chiavi a bussola maschio esagonale 1/2" ○ 5-6-6L-7-8-8L-10-10L-12-12L mm
- 13 chiavi a bussola maschio per viti con impronta Torx® 1/2" ○ T20-T25-T27-T30-T30L-T40-T40L-T45-T50-T50L-T55-T60-T60L
- 8 chiavi a bussola maschio a profilo XZN® ○ 5-6-6-6L-8-8L-10-10L-12L mm
- 18 chiavi combinate 6-7-8-9-10-11-12-13-14-15-16-17-18-19-21-22-24-27 mm
- 7 chiavi poligonali curve 6x7-8x9-10x11-12x13-14x15-16x17-18x19 mm
- 1 adattatore a sgancio rapido 1/4" per chiavi a cricchetto 10 mm
- 1 adattatore a sgancio rapido 3/8" per chiavi a cricchetto 13 mm
- 1 adattatore a sgancio rapido 1/2" per chiavi a cricchetto 19 mm
- 12 chiavi combinate a cricchetto reversibile 8-9-10-11-12-13-14-15-16-17-18-19 mm
- 9 chiavi maschio esagonale piegate con estremità sferica ○ 1,5-2-2,5-3-4-5-6-8-10 mm
- 1 bussola portainseri □1/4-□1/4
- 1 bussola portainseri □1/4-□3/8
- 1 bussola portainseri ○5/16-□1/2
- 13 chiavi a bussola esagonali 1/4" ○ 4-4,5-5-5,5-6-7-8-9-10-11-12-13-14 mm
- 9 chiavi a bussola a mano lunghe bocca esagonale ○ 5-6-7-8-9-10-11-12-13 mm
- 4 chiavi a bussola a giravite per viti con intaglio ● 0,8x4-1x5,5-1,2x6,5-1,2x8 mm
- 5 chiavi a bussola maschio esagonale 1/4" ○ 3-4-5-6-7 mm
- 4 chiavi a bussola a giravite per viti con impronta a croce Phillips® ⊕ PH1-PH2-PH3-PH4
- 7 chiavi a bussola a giravite maschio per viti con impronta Torx® ○ T10-T15-T20-T25-T27-T30-T40
- 1 raccordo con attacco quadro □1/4-■3/8
- 3 prolunga - 1/4" 50-100-150 mm
- 1 snodo 1/4"
- 1 quadro scorrevole 1/4"
- 1 cricchetto reversibile 1/4" ⊕
- 1 quadro con impugnatura 1/4"
- 17 chiavi a bussola esagonali 3/8" ○ 6-7-8-9-10-11-12-13-14-15-16-17-18-19-20-21-22 mm
- 1 raccordo con attacco quadro □3/8-■1/4
- 1 raccordo quadro maschio 1/2" e femmina 3/8" □3/8-■1/2
- 1 prolunga - 3/8" 125 mm
- 1 prolunga - 3/8" 250 mm
- 1 snodo 3/8"
- 1 quadro maschio 3/8" con spina scorrevole
- 1 cricchetto reversibile 3/8" ⊕
- 21 chiavi a bussola esagonali 1/2" ○ 8-10-11-12-13-4-15-16-17-18-19-20-21-22-23-24-26-27-28-30-32 mm
- 2 prolunga angolare - 1/2" 125-250 mm
- 1 raccordo con attacco quadro □1/2-■3/8
- 1 snodo 1/2"
- 1 quadro maschio 1/2" con spina scorrevole
- 1 cricchetto reversibile 1/2" ⊕
- 3 chiavi a bussola per candele 3/8" ○ 16-17,8-20,8 mm
- 31 inserti colorati con portainseri magnetico in astuccio tascabile ● ○ ⊕ ⊕ ⊕ ⊕
- 1 pinze regolabili cerniera chiusa 250 mm
- 1 tronchesi a taglianti diagonali † 160 mm
- 1 pinza universale ■ 180 mm
- 1 pinza becchi piatti diritti ■ 160 mm
- 5 giravite lama piatta ● 3x75-4x100-5,5x100-6,5x150-8x150 mm
- 1 giravite nano lama piatta ● 6,5x30 mm
- 3 giravite Phillips® ⊕ PH1-PH2-PH3
- 1 giravite nano Phillips® ⊕ PH2
- 4 chiavi maschio con impugnatura per viti con impronta Torx® ○ T20-T25-T27-T30
- 6 cacciaspina 2-3-4-5-6-8 mm
- 1 bulino 4 mm
- 3 scalpelli piatti 125-150-75 mm
- 1 ugnetti 125 mm
- 2 martello tipo tedesco 500-1000 g
- 1 magnete telescopico con testa flessibile
- 1 mazzuola con battenti in materiale plastico Ø 35 mm
- 1 flessometro 5 m
- 1 pinze becchi dritti per anelli elastici, per fori ○ 180 mm
- 1 pinze becchi piegati per anelli elastici, per fori ○ 170 mm
- 1 pinze becchi dritti per anelli elastici, per alberi ● 175 mm
- 1 pinze becchi piegati per anelli elastici, per alberi ● 175 mm
- 1 pinza a becchi mezzotondi lunghi lisci ● 140 mm
- 1 tronchese a taglianti diagonali normali † 125 mm
- 4 microgiravite per viti senza testa con intaglio ● 2,0-2,5-3,0-3,5 mm
- 2 microgiravite per viti con impronta a croce Phillips® ⊕ 0-00
- 9 chiavi maschio con impugnatura per viti con impronta Torx® ○ T10-T15-T20-T25-T27-T30-T40-T45-T50
- 1 pinza autobloccante 240 mm
- 1 pinza autobloccante becchi lunghi 175 mm
- 1 pinze in plastica per occlusione tubi
- 1 pinza in plastica per occlusione tubi e manicotti
- 1 pinza in plastica per occlusione tubi e manicotti
- 1 calibro a corsoio
- 1 spessimetro
- 1 raschietto per guarnizioni
- 7 chiavi a bussola poligonale snodate doppie 6x7-8x9-10x11-12x13-14x15-16x17-18x19 mm
- 1 quadro maschio 1/2" snodato con impugnatura
- 1 leva piatta curva con impugnatura 450 mm
- 1 specchietto telescopico 670 mm
- 1 lime a taglio mezzodolce 200 mm
- 1 lime a taglio mezzodolce 200 mm
- 1 lime a taglio mezzodolce 200 mm
- 1 lime a taglio mezzodolce 200 mm
- 1 lime a taglio mezzodolce 200 mm
- 1 spazzola fili d'acciaio

Beta N.	TR
910AL	M125
920AL	M125
920FTX	M125
920PE	M125
920TX	M125
920XZN	M125
42	M25
90	M25
123Q1/4	M25
123Q3/8	M25
123Q1/2	M25
142	M25
96BPC/SC9	M105
895/1	M105
895/3	M105
895/6	M105
900	M105
900L	M105
900LP	M105
900ME	M105
900PH	M105
900TX	M105
900/16	M105
900/...	M105
900/25	M105
900/42	M105
900/55	M105
900BG/30	M105
910A	M105
910/15	M105
910/16	M105
910/21	M105
910/22	M105
910/25	M105
910/42	M105
910/55	M105
920A	M105
920AN	M105
920/15	M105
920/25	M105
920/42	M105
920/55	M105
956E	M105
860MIX/A31	M166
1048N	M166
1082BM	M166
1150BM	M166
1162BM	M166
1290	M166
1290N	M166
1292	M166
1292N	M166
1297TX	M166
31	M231
32	M231
34	M231
36	M231
1370	M231
1712TF	M231
1390	M231
1692	M125
1032	M62
1034	M62
1036	M62
1038	M62
1177BM	M62
1188BM	M62
1257LP	M62
1257PH	M62
977TX	M62
1052	M78
1058	M78
1481PL/A	M78
1481PL/B	M78
1481PL/C	M78
1650	M78
1708/20	M78
1716P	M78
80	M78
920/36A	M78
965	M78
1715	M231
1719BMA8/M	M231
1719BMA8/P	M231
1719BMA8/Q	M231
1719BMA8/R	M231
1719BMA8/T	M231
1737NX	M231

5988H/7M

059881087

Assortimento consigliato in abbinamento con RSC24 da 8 cassette - RSC24A da 8 cassette - RSC24AXL da 8 e 9 cassette - C37 da 8 cassette - C39 da 8 cassette - RSC28 - C59B - C55C8 - C55M8

5988L/4M

assortimento di 273 utensili in vassoio morbido in EVA

► Autoriparazione

N. pezzi/Descrizione

- 13 chiavi a bussola esagonali 1/4" ○ 4-4,5-5-5,5-6-7-8-9-10-11-12-13-14 mm
 9 chiavi a bussola a mano lunghe bocca esagonale ○ 5-6-7-8-9-10-11-12-13 mm
 9 chiavi maschio esagonale piegate con estremità sferica ○ 1,5-2-2,5-3-4-5-6-8-10 mm
 1 bussola portainseriti
 1 bussola portainseriti
 1 bussola portainseriti
 5 chiavi a bussola maschio esagonale 1/4" ○ 3-4-5-6-7 mm
 4 chiavi a bussola a giravite per viti con intaglio ● 0,8x4-1x5,5-1,2x6,5-2x8 mm
 4 chiavi a bussola a giravite per viti con impronta a croce Phillips® ⊕ PH1-PH2-PH3-PH4
 7 chiavi a bussola a giravite maschio per viti con impronta Torx® ⊕ T10-T15-T20-T25-T27-T30-T40
 1 raccordo con attacco quadro □ 1/4 - ■ 3/8
 3 prolunga - 1/4" 50-100-150 mm
 1 snodo 1/4"
 1 quadro con impugnatura 1/4"
 1 quadro scorrevole 1/4"
 1 cricchetto reversibile 1/4" ⊕
 17 chiavi a bussola esagonali 3/8" ○ 6-7-8-9-10-11-12-13-14-15-16-17-18-19-20-21-22 mm
 1 raccordo con attacco quadro □ 3/8 - ■ 1/4
 1 raccordo quadro maschio 1/2" e femmina 3/8" □ 3/8 - ■ 1/2
 1 prolunga - 3/8" 125 mm
 1 prolunga - 3/8" 250 mm
 1 snodo 3/8"
 1 quadro maschio 3/8" con spina scorrevole
 1 cricchetto reversibile 3/8" ⊕
 17 chiavi a bussola esagonali 1/2" ○ 8-10-11-12-13-14-15-16-17-18-19-20-21-22-23-24-26-27-28-30-32 mm
 1 raccordo con attacco quadro □ 1/2 - ■ 3/8
 1 snodo 3/8"
 2 prolunga angolare - 1/2" 125 - 250 mm
 1 quadro maschio 1/2" con spina scorrevole
 1 cricchetto reversibile 1/2" ⊕
 3 chiavi a bussola per candele 3/8" ○ 16-17,8-20,8 mm
 13 chiavi a bussola a mano lunghe bocca esagonale
 ○ 8-9-10-11-12-13-14-15-16-17-19-21-22 mm
 10 chiavi a bussola maschio esagonale 1/2" ○ 5-6-6L-7-8-8L-10-10L-12-12L mm
 7 chiavi a bussola 1/2" per viti con teste a profilo Torx® ⊕ E12-E14-E16-E18-E20-E22-E24
 13 chiavi a bussola maschio per viti con impronta Torx® 1/2" ⊕ T20-T25-T27-T30-T30L-T40-T40L-T45-T50-T50L-T55-T60-T60L
 8 chiavi a bussola maschio a profilo XZN® ○ 5-6-6L-8-8L-10-10L-12L mm
 16 chiavi a bussola a mano lunghe bocca esagonale ○ 10-12-13-14-15-16-17-18-19-21-22-23-24-27-30-32 mm
 1 flessometro 5 m
 18 chiavi combinate 6-7-8-9-10-11-12-13-14-15-16-17-18-19-21-22-24-27 mm
 7 chiavi poligonali curve 6x7-8x9-10x11-12x13-14x15-16x17-18x19 mm
 1 adattatore a sgancio rapido 1/4" per chiavi a cricchetto 10 mm
 1 adattatore a sgancio rapido 3/8" per chiavi a cricchetto 13 mm
 1 adattatore a sgancio rapido 1/2" per chiavi a cricchetto 19 mm
 12 chiavi combinate a cricchetto reversibile 8-9-10-11-12-13-14-15-16-17-18-19 mm
 31 inserti colorati con portainseriti magnetico in astuccio tascabile ● ○ ⊕ ⊕ ⊕ ⊕
 1 pinze regolabili cerniera chiusa 250 mm
 1 tronchesi a taglienti diagonali ✂ 160 mm
 1 pinza universale = 180 mm
 1 pinza becchi piatti diritti = 160 mm
 5 giravite lama piatta ● 3x75-4x100-5,5x100-6,5x150-8x150 mm
 1 giravite nano lama piatta ● 6,5x30 mm
 3 giravite Phillips® ⊕ 4,5x80-6x100-8x150 mm
 1 giravite nano Phillips® ⊕ 6x30 mm
 4 chiavi maschio con impugnatura per viti con impronta Torx® ⊕ T20-T25-T27-T30

Beta N.	TR
900	M105
900L	M105
96BPC/SC9	M105
895/1	M105
895/3	M105
895/6	M105
900ME	M105
900LP	M105
900PH	M105
900TX	M105
900/16	M105
900/...	M105
900/25	M105
900BG/30	M105
900/42	M105
900/55	M105
910A	M105
910/15	M105
910/16	M105
910/21	M105
910/22	M105
910/25	M105
910/42	M105
910/55	M105
920A	M105
920/15	M105
910/25	M105
920AN	M105
920/42	M105
920/55	M105
956E	M105
910AL	M125
920PE	M125
920FTX	M125
920TX	M125
920XZN	M125
920AL	M125
1692/5	M125
42	M25
90	M25
123Q1/4	M25
123Q3/8	M25
123Q1/2	M25
142	M25
860MDX/A31	M166
1048N	M166
1082BM	M166
1150BM	M166
1162BM	M166
1290	M166
1290N	M166
1292	M166
1292N	M166
1297TX	M166



M105



M125



M25



M166

5988U6/M

assortimento di 214 utensili in vassoio morbido in EVA

► Universali

N. pezzi/Descrizione

- 22 chiavi combinate 6-7-8-9-10-11-12-13-14-15-16-17-18-19-20-21-22-24-27-30-32-36 mm
- 11 chiavi a forchetta 6x7-8x9-10x11-12x13-14x15-16x17-18x19-20x22-21x23-24x27-30x32 mm
- 11 chiavi poligonali curve 6x7-8x9-10x11-12x13-14x15-16x17-18x19-20x22-21x23-24x27-30x32 mm
- 9 giravite lama piatta 2,5x50-3x75-4x100-5,5x125-6,5x150-8x200 mm
- 1 giravite per viti a testa con intaglio 4x30 mm
- 4 giravite Phillips® PH0x60-PH1x80-PH2x100-PH3x150 mm
- 1 giravite Phillips® PH1x30 mm
- 12 chiavi maschio con impugnatura per viti con impronta Torx® T6-T7-T8-T9-T10-T15-T20-T25-T27-T30-T40-T45
- 1 giravite cercafase
- 3 punzoni Ø 2-3-4 mm
- 6 cacciaspina Ø 2-3-4-5-6-8 mm
- 1 bulino Ø 4 mm
- 1 scalpelli piatti 150 mm
- 2 scalpelli piatti nervati 200-250 mm
- 1 ugnetti 125 mm
- 1 martello tipo tedesco 500 g
- 1 mazzuola con battenti in materiale plastico Ø 35 mm
- 1 flessometro 3 m
- 1 magnete telescopico con testa flessibile
- 1 lima 200 mm
- 1 lima 200 mm
- 1 lima 200 mm
- 1 lima 200 mm
- 1 lima 200 mm
- 1 spazzola fili d'acciaio
- 1 cutter con lama a settori 18 mm
- 1 pinze becchi dritti per anelli elastici, per fori Ø 180 mm
- 1 pinze becchi piegati per anelli elastici, per fori Ø 170 mm
- 1 pinze becchi dritti per anelli elastici, per alberi Ø 175 mm
- 1 pinze becchi piegati per anelli elastici, per alberi Ø 175 mm
- 1 pinze regolabili cerniera chiusa 250 mm
- 1 pinza autobloccante 240 mm
- 1 tronchesi a taglienti diagonali 160 mm
- 1 tenaglie per cementisti 220 mm
- 1 cesoia a lame larghe diritte 250 mm
- 1 forbici per elettricisti lame dritte
- 1 pinza universale 180 mm
- 1 pinza a becchi mezzotondi dritti 160 mm
- 1 pinza a becchi mezzotondi piegati 160 mm
- 1 bussola portainseri
- 1 bussola portainseri
- 1 bussola portainseri
- 13 chiavi a bussola esagonali 1/4" 4-4,5-5-5,5-6-7-8-9-10-11-12-13-14 mm
- 9 chiavi a bussola a mano lunghe bocca esagonale 5-6-7-8-9-10-11-12-13 mm
- 5 chiavi a bussola maschio esagonale 1/4" 3-4-5-6-7 mm
- 4 chiavi a bussola a giravite per viti con intaglio 0,8x4-1x5,5-1,2x6,5-1,2x8 mm
- 4 chiavi a bussola a giravite per viti con impronta a croce Phillips® PH1-PH2-PH3-PH4
- 7 chiavi a bussola a giravite maschio per viti con impronta Torx® T10-T15-T20-T25-T27-T30-T40
- 1 prolunga - 1/4" 50 mm
- 1 prolunga - 1/4" 100 mm
- 1 prolunga - 1/4" 150 mm
- 1 snodo 1/4"
- 1 quadro con impugnatura 1/4"
- 1 quadro scorrevole 1/4"
- 1 cricchetto reversibile 1/4"
- 21 chiavi a bussola esagonali 1/2" 8-10-11-12-13-14-15-16-17-18-19-20-21-22-23-24-26-27-28-30-32 mm
- 1 raccordo con attacco quadro 125 mm
- 1 snodo 1/2" 250 mm
- 1 prolunga angolare - 1/2"
- 1 prolunga angolare - 1/2"
- 1 quadro maschio 1/2" con spina scorrevole
- 1 cricchetto reversibile 1/2"
- 8 chiavi a bussola 1/2" per viti con teste a profilo Torx® 10-12-14-16-18-20-22-24 mm
- 11 chiavi a bussola a mano lunghe bocca esagonale 10-12-13-14-15-16-17-18-19-21-22 mm

Beta N.	TR
42	M01
55	M30
90	M30
96BPC/SC9	M30
1201E	M213
1201EN	M213
1202E	M213
1202EN	M213
1207E/TX	M213
1253	M213
30	M230
31	M230
32	M230
34	M230
35	M230
36	M230
1370	M230
1390	M230
1692	M230
1712TF	M230
1719BMA..Q	M230
1719BMA..T	M230
1719BMA..P	M230
1719BMA..M	M230
1719BMA..R	M230
1737NX	M230
1771	M230
1032	M129
1034	M129
1036	M129
1038	M129
1048N	M129
1052	M129
1082BM	M129
1098	M129
1112	M129
1128BM	M129
1150BM	M129
1166BM	M129
1168BM	M129
895/1	M100
895/3	M100
895/6	M100
900	M100
900L	M100
900ME	M100
900LP	M100
900PH	M100
900TX	M100
900/20	M100
900/20L	M100
900/21	M100
900/25	M100
900BG/30	M100
900/42	M100
900/55	M100
920A	M100
920/15	M100
920/25	M100
920AN/125	M100
920AN/250	M100
920/42	M100
920/55	M100
920FTX	M100
920AL	M100



M01



M30



M213



M230



M129

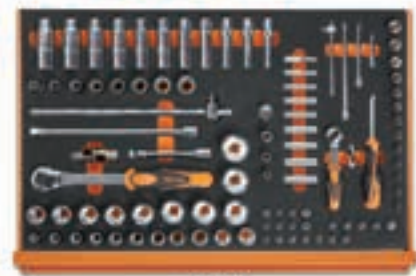

M100

5988U6/M

059881430

Assortimento consigliato in abbinamento con RSC24 da 8 cassetti - RSC24A da 8 cassetti - RSC24AXL da 8-9 cassetti RSC28 - C37 da 8 cassetti - C39 da 8 cassetti - C39SM - C39MD - RSC55 - C59B

5935ET/1MB

assortimento di 96 utensili per cassettera C35, in vassoio morbido in EVA

► Elettrotecnica

N. pezzi/Descrizione

- 1 pinza autobloccante 240 mm
- 1 martello tipo tedesco 500 g
- 1 mazzuola con battenti in materiale plastico Ø 35 mm
- 1 lima 200 mm
- 1 lima 200 mm
- 1 lima 200 mm
- 1 lima 200 mm
- 1 lima 200 mm
- 1 scalpelli piatti nervati 200 mm
- 1 pinze becchi diritti per anelli elastici, per fori ⌀ 180 mm
- 1 pinze becchi piegati per anelli elastici, per fori ⌀ 170 mm
- 1 pinze becchi diritti per anelli elastici, per alberi ⌀ 175 mm
- 1 pinze becchi piegati per anelli elastici, per alberi ⌀ 175 mm
- 1 tronchesi a grande effetto taglienti diagonali 160 mm
- 1 pinza universale 180 mm
- 1 pinza a becchi mezzotondi diritti 160 mm
- 9 chiavi maschio esagonale piegate con estremità sferica Ⓞ
- 1 giravite prensile lama piatta Ⓛ
- 1 giravite prensile Phillips® Ⓢ
- 1 giravite cercafase Ⓛ
- 6 chiavi a bussola esagonale con impegnatura Ⓞ 5,5-6-7-8-10-13 mm
- 4 giravite Phillips® 1000V Ⓢ PH0x60-PH1x80-PH2x100-PH3x150 mm
- 6 giravite lama parallela 1000V Ⓛ 2,5x75-3x100-4x100-5,5x125-6x150-8x175 mm
- 31 inserti colorati con portainseri magnetico in astuccio tascabile Ⓛ Ⓞ Ⓢ Ⓢ Ⓢ
- 1 portainseri magnetico isolato Ⓢ
- 8 chiavi a forchetta 6x7-8x9-10x11-12x13-14x15
16x17-18x19-20x22 mm
- 1 pinze regolabili a cerniera chiusa 250 mm
- 1 tronchesi a taglienti diagonali 1000V 140 mm
- 1 forbici per elettricisti lame diritte con svasatore
- 1 tagliacavi 230 mm
- 1 pinze spellafili 160 mm
- 1 pinza universale 1000V 180 mm
- 1 pinze a becchi mezzotondi lunghissimi 1000V Ⓛ 160 mm
- 1 pinze a becchi mezzotondi lunghissimi piegati Ⓛ 160 mm
- 1 chiave regolabile a rullino 1000V 250 mm
- 1 cutter 1000V
- 1 pinzetta a molla a punte curve arrotondate 1000V
- 1 pinza per capicorda preisolati

Beta N.	TR
1052	MB65
1370	MB65
1390	MB65
1719BMA...Q	MB65
1719BMA...P	MB65
1719BMA...T	MB65
1719BMA...M	MB65
1719BMA...R	MB65
35	MB65
1032	MB65
1034	MB65
1036	MB65
1038	MB65
1084BM	MB65
1150BM	MB65
1166BM	MB65
96BPC/SC9	MB63
1250	MB63
1251	MB63
1253	MB63
943MQ	MB63
1272MQ	MB63
1274MQ	MB63
860MIX/A31	MB63
850MQ	MB63
55	MB64
1048MQ	MB64
1082MQ	MB64
1128BSX	MB64
1132MQ	MB64
1142MQ	MB64
1150MQ	MB64
1166MQ	MB64
1168MQ	MB64
110MQ	MB64
1777MQ	MB64
993MQ	MB64
1602	MB64



MB65



MB64



MB63

5980ET/A

assortimento di 70 utensili

► Elettrotecnica

N. pezzi/Descrizione	Beta N.
1 bulino Ø 4 mm	32
1 scalpelli piatti nervati 150 mm	35
8 chiavi a forchetta 6x7 - 8x9 - 10x11 - 12x13 - 14x15 - 16x17 - 18x19 - 20x22 mm	55/B8N
8 chiavi maschio esagonale, tipo lungo Ø 2+10 mm	96LC/SC8
1 chiave regolabile a rullino 200 mm	111E
1 portainseri magnetico isolato	850MQ
10 inserti con portainseri magnetico	860MIX/A10
1 pinze regolabili a cerniera chiusa 250 mm	1048MQ
1 tronchesi a taglienti diagonali 160 mm	1082BM
1 forbici per elettricisti lame dritte con svasatore	1128BSX
1 tagliacavo 170 mm	1132BM
1 pinza universale 180 mm	1150BM
1 pinza a becchi mezzotondi dritti 160 mm	1166BM
1 pinza a becchi mezzotondi piegati 160 mm	1168BM
1 giravite prensile lama piatta 4x125 mm	1250
1 giravite prensile Phillips PH1x125 mm	1251
1 giravite cercafase	1253
5 giravite lama piatta 2,5x75 - 3,5x100 - 5,5x125 - 6,5x150 mm	1201E
1 giravite per viti a testa con intaglio 4x30 mm	1201EN
4 giravite Phillips PH0x60 - PH1x120 - PH2x150 - PH3x150 mm	1202E
1 giravite Phillips PH2x30 mm	1202EN
4 giravite Phillips 1000V PH0x60 - PH1x80 - PH2x100 - PH3x150 mm	1272MQ
5 giravite lama parallela 1000V 5,5x125 - 3x100 - 4x100 - 6,5x150 - 8x175 mm	1274MQ
1 scalpello piatto con tagliente laterale	1343
1 martello tipo tedesco 300 g	1370
1 mazzuola con battenti in materiale plastico Ø 35 mm	1390
1 pinza per capicorda preisolati	1602
1 nastro isolante in PVC 25 m	BMESB1923NE
1 flessometro 5 m	1692
1 lima 200 mm	1719BMA...M
1 lima 200 mm	1719BMA...R
1 seghetto	1725
1 coltello a serramanico	1777BM



5980ET/A

059801083

Assortimento consigliato in abbinamento con C12 - 2032/TV - 2028/VV

5980ET/B

assortimento di 64 utensili e 200 collari

► Elettrotecnica

N. pezzi/Descrizione

- 3 cacciapina Ø 2 - 3 - 4 mm
- 1 bulino Ø 4 mm
- 1 scalpelli piatti 150 mm
- 8 chiavi a forchetta 6x7 - 8x9 - 10x11 - 12x13 - 14x15 - 16x17 - 18x19 - 20x22 mm
- 9 chiavi maschio esagonale piegate con estremità sferica \odot 1,5 - 2 - 2,5 - 3 - 4 - 5 - 6 - 8 - 10 mm
- 1 sbavatore a raschietto 150 mm
- 6 chiavi a bussola esagonale con impugnatura 1000V \odot 5,5 - 6 - 7 - 8 - 10 - 13 mm
- 1 pinze regolabili a cerniera chiusa 250 mm
- 1 tronchese a taglienti diagonali 1000V \nlessgtr 160 mm
- 1 forbici per elettricisti lame diritte con svasatore
- 1 tagliacavi 230 mm
- 1 pinze spellafili \nlessgtr 160 mm
- 1 pinza universale 1000V \equiv 180 mm
- 1 pinze a becchi mezzotondi lunghissimi 1000V \bullet 160 mm
- 1 giravite cercafase \bullet
- 3 giravite Phillips® 1000V \oplus PH0x60 - PH1x80 - PH2x100 mm
- 4 giravite lama parallela 1000V \bullet 3x100 - 4x100 - 5,5x125 - 6,5x150 mm
- 1 martello tipo tedesco 300 g
- 1 mazzuola con battenti in materiale plastico Ø 35 mm
- 1 pinza per capicorda preisolati
- 1 riga flessibile graduata 250 mm
- 1 punta per tracciare 250 mm
- 1 flessometro 5 m
- 1 livella in alluminio 200 mm
- 1 scalpello per elettricisti 10x200 mm
- 1 traccialinea
- 1 specchietto flessibile 600 mm
- 1 lime a taglio mezzodolce 200 mm
- 1 lime a taglio mezzodolce 200 mm
- 1 tenditore per molle
- 1 seghetto
- 1 pennello
- 1 pinza per collari in Nylon
- 1 oliatore in plastica 80 cc
- 100 fascette in nylon 3,6x200 mm
- 100 fascette in nylon 4,8x300 mm
- 1 cutter con lama a settori
- 1 saldatore 30 W
- 1 torcia LED per ispezioni

Beta N.

- 31
- 32
- 34
- 55/B8N
- 96BPC/SC9
- 345SB
- 943MQ/S6
- 1048MQ
- 1082MQ
- 1128BSX
- 1132MQ
- 1142MQ
- 1150MQ
- 1166MQ
- 1253
- 1272MQ
- 1274MQ
- 1370
- 1390
- 1602
- 1682
- 1688
- 1692
- 1696
- 1701NE3
- 1705
- 1715FL/A
- 1719BMA8/M
- 1719BMA8/R
- 1723
- 1726BM
- 1738
- 1743
- 1755
- 1748N
- 1748N
- 1771BM
- 1814M
- 1833XS/2

5980ET/B

059801084

Assortimento consigliato in abbinamento con C12 - 2029/VV - 2033L/VV - 2036/TV

5980MQ

assortimento di 46 utensili

► Elettrotecnica

N. pezzi/Descrizione

- 7 chiavi a forchetta 1000V 10 - 12 - 13 - 14 - 17 - 19 - 22 mm
- 1 chiave regolabile a rullino 1000V 250 mm
- 6 chiavi a bussola esagonale con impegnatura \odot 5,5 - 6 - 7 - 8 - 10 - 13 mm
- 4 chiavi a T maschio esagonale \odot 4 - 5 - 6 - 8 mm
- 1 pinzetta a molla a punte curve arrotondate 1000V
- 1 pinze regolabili a cerniera chiusa 250 mm
- 1 tronchese a taglienti diagonali 1000V \nlessgtr 160 mm
- 1 forbici per elettricisti
- 1 pinze spellafili \nlessgtr 160 mm
- 1 pinza universale 1000V \equiv 180 mm
- 1 pinze a becchi piatti lunghissimi piegati \equiv 160 mm
- 1 pinze a becchi mezzotondi lunghissimi 1000V \bullet 160 mm
- 1 giravite cercafase \bullet
- 4 giravite Phillips® 1000V \oplus PH0x60 - PH1x80 - PH2x100 - PH3x150 mm
- 5 giravite lama parallela 1000V \bullet 3x100 - 4x100 - 5,5x125 - 6,5x150 - 8x175 mm
- 1 martello tipo tedesco 300 g
- 1 mazzuola con battenti in materiale plastico Ø 35 mm
- 1 flessometro 5 m
- 1 200 mm
- 1 miniseghetto 1000V
- 2 cutter 1000V
- 1 saldatore 30 W
- 1 torcia LED ad alta luminosità, fino a 500 Lumen
- 1 tester combinato di tensione e di continuità

Beta N.

- 52MQ
- 110MQ
- 943MQ
- 951MQ
- 993MQ
- 1048MQ
- 1082MQ
- 1128MQ
- 1142MQ
- 1150MQ
- 1164MQ
- 1166MQ
- 1253
- 1272MQ
- 1274MQ
- 1370
- 1390
- 1692
- 1701NE/3
- 1725MQ
- 1777MQ
- 1814M
- 1833S
- 1847P

5980MQ

059801257

Assortimento consigliato in abbinamento con 2029/VV

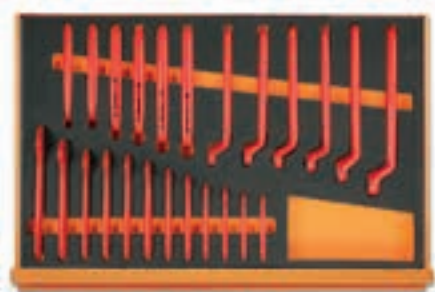

M49

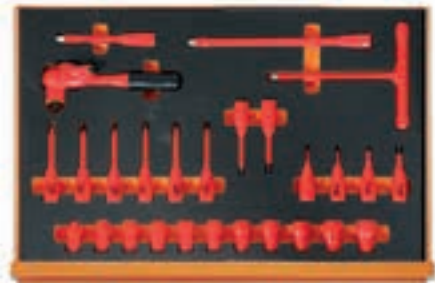

M108



M161

5988 VHB-MQ

assortimento di 66 utensili in vassoio morbido in EVA

► Elettrotecnica

N. pezzi/Descrizione

- 12 chiavi a forchetta 1000V 7-8-10-11-12-13-14-15-16-17-19-22 mm
- 12 chiavi poligonali semplici 7-8-10-11-12-13-14-15-16-17-19-22 mm
- 4 chiavi a bussola maschio esagonale \odot 4-5-6-8 mm
- 11 chiavi a bussola poligonali \odot 7-8-10-11-12-13-14-15-16-17-19 mm
- 6 chiavi a bussola maschio per viti con impronta Torx® \odot T15-T20-T25-T27-T30-T40
- 2 chiavi a bussola maschio a profilo XZN® \odot 8-10 mm
- 1 prolunga quadro maschio e femmina 3/8" 125 mm
- 1 prolunga quadro maschio e femmina 3/8" 250 mm
- 1 quadro maschio 3/8", a T
- 1 cricchetto reversibile con attacco quadro maschio 3/8"
- 1 forbici per elettricisti
- 1 pinze regolabili a cerniera chiusa 250 mm
- 1 tronchese a taglienti diagonali 1000V ∇ 160 mm
- 1 pinza universale 1000V \equiv 180 mm
- 1 pinze a becchi piatti lunghissimi diritti \equiv 160 mm
- 1 pinze a becchi piatti lunghissimi piegati \equiv 160 mm
- 4 giravite Phillips® 1000V \oplus PH0x60 - PH1x80 - PH2x100 - PH3x150 mm
- 4 giravite lama parallela 1000V \bullet 2,5x75 - 3x100 - 4x100 - 5,5x125 mm
- 1 coltello spellacavi isolato

Beta N.	TR
52MQ	M49
89MQ	M49
910MQ/PE	M108
910MQ/B	M108
910MQ/TX	M108
910MQ/XZN	M108
910MQ/21	M108
910MQ/22	M108
910MQ/T	M108
910MQ/55	M108
1128MQ	M161
1048MQ	M161
1082MQ	M161
1150MQ	M161
1162MQ	M161
1164MQ	M161
1272MQ	M161
1274MQ	M161
1777MQU	M161

5988 VHB-MQ

059880300

Assortimento consigliato in abbinamento con RSC51 - RSC23T - RSC24 - RSC24A - RSC24AXL - RSC24L/7 - RSC24L-CAB - RSC28 - C37 - C39 - C39SM - C39MD - C39T - RSC55 C59

5980EL/A

assortimento di 57 utensili

► Elettronica

N. pezzi/Descrizione

- 13 chiavi a forchetta doppie piccole 4+14 mm
- 9 chiavi maschio esagonale piegate \odot 1,5+10 mm
- 1 pinzetta punte fini curve 130 mm
- 1 pinzetta punte fini diritte 150 mm
- 1 pinzetta becchi diritti incrociati 155 mm
- 1 forbici per elettricisti lame diritte
- 1 pinza spellafili ∇ 160 mm
- 1 pinza a becchi mezzotondi diritti \bullet 160 mm
- 1 pinza a becchi piatti lunghi \equiv
- 1 pinza a becchi mezzotondi lunghi piegati \bullet
- 1 pinza universale per elettronica \bullet
- 1 tronchese a taglienti diagonali rasi ∇
- 1 tronchese a taglienti diagonali normali ∇
- 1 giravite prensile lama piatta \bullet 4x125 mm
- 1 giravite prensile Phillips® \oplus PH0x125 mm
- 8 microgiraviti
- 1 martello tipo tedesco 200 g
- 1 flessometro 5 m
- 1 specchietto telescopico
- 3 lime ad ago
- 1 tenditore per molle
- 1 pennello
- 1 oliatore a stilo
- 1 cutter con lama a settori
- 1 pinzetta autobloccante
- 1 saldatore 25 W
- 1 pompetta succhiastagno
- 1 torcia LED per ispezioni

Beta N.	
73/B13N	
96N/SC9	
991	
992	
998	
1128BMX	
1142BM	
1166BM	
1172BM	
1178BM/P	
1178BM	
1185BM	
1188BM	
1250	
1251	
1257LPH/S8	
1370	
1692	
1715	
1720/S3	
1723	
1738	
1756	
1771	
1002	
1814M	
1830T	
1833XS/2	

5980EL/A

059801081

Assortimento consigliato in abbinamento con 2028/VV - 2032/TV - 2033L/VV

5980EL/B

assortimento di 98 utensili

► Elettronica

N. pezzi/Descrizione	Beta N.
13 chiavi a forchetta doppie piccole 4+14 mm	73/B13N
9 chiavi maschio esagonale piegate \odot 1,5+10 mm	96/SC9
8 chiavi maschio con impronta Torx® \odot T9 - T10 - T15 - T20 - T25 - T27 - T30 - T40	97TX/BG8
1 chiave regolabile a rullino 150 mm	111E
18 assortimento 13 bussole e 5 accessori 1/4"	900/C13-5
1 pinzetta a molla a punte fini diritte 130 mm	990
1 pinzetta punte fini curve 130 mm	991
1 pinzetta a molla a punte corte finissime 120 mm	999A
1 forbici per elettricisti lame diritte	1128BMX
1 Pinza spellafili frontale autoregolabile, con dispositivo di taglio 170 mm	1149F
1 pinza universale \equiv 180 mm	1150BM
1 pinza a becchi piatti lunghi \equiv 140 mm	1172BM
1 pinza a becchi mezzotondi lunghi lisci \bullet 140 mm	1177BM
1 pinza a becchi mezzotondi lunghi piegati \bullet 140 mm	1178BM/P
1 tronchese a taglienti diagonali rasi becchi arrotondati ζ 120 mm	1184BM
1 tronchese a taglienti diagonali rasi becchi assotigliati ζ 120 mm	1186BM
1 tronchese a taglienti frontali obliqui rasi ζ	1191BM
8 microgiraviti	1257LPH/S8
1 giravite cercafase \bullet	1253
1 giravite nano lama piatta \bullet 6,5x30 mm	1290N
3 giravite Phillips® \oplus PH0x60 - PH1x80 - PH2x100 mm	1292
2 giravite nano Phillips® \oplus PH1x30 - PH2x30 mm	1292N
5 giravite lama parallela \bullet 2,5x60 - 3x75 - 4x100 - 5x125 - 6,5x150 mm	1294
1 martello tipo tedesco 200 g	1370
1 riga flessibile graduata 150 mm	1682
1 punta per tracciare 220 mm	1688
1 flessometro 5 m	1692
1 specchietto telescopico 670 mm	1715
1 lime ad ago \bullet	1720R
1 lime ad ago \blacktriangle	1720T
1 lime ad ago \blacksquare	1720P
1 tenditore per molle	1723
1 pennello	1738
1 oliatore a stilo	1756
1 cutter con lama a settori	1771BM
1 coltello a serramanico	1777BM
1 pinzetta autobloccante	1002
1 saldatore 25W	1814M
1 pompetta succhiastagno	1830T
1 torcia LED per ispezioni	1833XS/2



5980EL/B

059801082

Assortimento consigliato in abbinamento con 2029/VV - 2033L/VV - 2036/TV

5980ID

assortimento di 35 utensili

► Idraulica

N. pezzi/Descrizione

- 1 scalpelli piatti 150 mm
- 1 scalpelli piatti nervati 200 mm
- 12 chiavi a forchetta 6x7 - 8x9 - 10x11 - 12x13 - 14x15 - 16x17 - 18x19 - 20x22 - 21x23 - 24x27 - 25x28 - 30x32 mm
- 1 chiave regolabile a rullino 250 mm
- 1 tagliatubi per rame e leghe leggere Ø 3÷30 mm
- 1 giratubi svedese 320 mm
- 1 pinza autobloccante 240 mm
- 1 cesoia a lame larghe diritte 300 mm
- 1 forbici per elettricisti lame diritte
- 1 pinze universali a grande effetto, finitura industriale = 180 mm
- 4 giravite lama piatta ● 3x75 - 4x100 - 5,5x150 - 8x150 mm
- 2 giravite Phillips® ⚡ PH1x80 - PH2x100 mm
- 1 martello tipo tedesco 300 g
- 1 metro pieghevole in fibra 2 m
- 1 flessometro 5 m
- 1 livella in alluminio 200 mm
- 1 lima 200 mm
- 1 seghetto
- 1 spazzola fili d'acciaio
- 1 pinze regolabili cerniera chiusa 250 mm

Beta N.

- 34
- 35
- 55/S12X
- 111E
- 334
- 374
- 1052
- 1112
- 1128BMX
- 1150GBM
- 1201E
- 1202E
- 1370
- 1690F
- 1692
- 1696
- 1719BMA...M
- 1725
- 1737NX
- 1048N

5980ID

059801085

Assortimento consigliato in abbinamento con 2009N/BV

5902MT

assortimento di 106 utensili per macchine agricole, edili e movimento terra

► Movimento terra

N. pezzi/Descrizione

- 2 punzoni Ø 3 - 4 mm
- 2 cacciaspina Ø 6 - 8 mm
- 1 bulino Ø 4 mm
- 2 scalpelli piatti nervati 150 - 200 mm
- 18 chiavi combinate 6÷14 - 17 - 19 - 22 - 24 - 27 - 30 - 32 - 36 - 41 mm
- 10 chiavi poligonali curve 6x7 - 8x9 - 10x11 - 12x13 - 14x15 - 16x17 - 18x19 - 20x22 - 24x27 - 30x32 mm
- 10 chiavi maschio esagonale piegate ○ 1,5÷12 mm
- 17 chiavi a bussola esagonali 1/2" ○ 10÷22 - 24 - 27 - 30 - 32 mm
- 1 prolunga - 1/2" 125 mm
- 1 prolunga - 1/2" 255 mm
- 1 snodo 1/2"
- 1 quadro maschio 1/2" con spina scorrevole
- 1 cricchetto con quadro scorrevole 1/2" Ⓢ
- 11 chiavi a bussola esagonali 3/4" ○ 22 - 24 - 27 - 30 - 32 - 36 - 41 - 46 - 50 - 55 - 60 mm
- 1 prolunga - 3/4" 200 mm
- 1 quadro maschio snodato 3/4" con impugnatura
- 1 quadro maschio 3/4" con spina scorrevole
- 1 cricchetto reversibile 3/4" Ⓢ
- 1 leva con estremità a punta e a becco
- 1 pinze regolabili cerniera chiusa 250 mm
- 1 pinza autobloccante ganasce sagomate
- 1 tronchesi a grande effetto, a taglienti diagonali, finitura industriale ⚡ 160 mm
- 1 forbici per elettricisti lame diritte
- 1 pinze universali a grande effetto, finitura industriale = 180 mm
- 1 pinze a becchi mezzotondi lunghissimi, diritti zigrinati, impugnatura bimatereale, finitura industriale ● 160 mm
- 4 giravite lama piatta con esagono di manovra ● 6,5x150 - 8x175 - 10x200 - 12x250 mm
- 3 giravite Phillips® con esagono di manovra ⚡ PH2x150 - PH3x175 - PH4x200 mm
- 1 martello testa tonda penna sferica 900 g
- 1 mazzuola con battenti in materiale plastico Ø 35 mm
- 1 spessimetro
- 1 raschietto a tre taglienti 200 mm
- 5 serie di 5 lime 200 mm
- 1 seghetto

Beta N.

- 30
- 31
- 32
- 35
- 42
- 90
- 96N/B10
- 920A
- 920/21
- 920/22
- 920/25
- 920/42
- 920/50
- 928A
- 928/21
- 928/36A
- 928/42
- 928/55
- 964
- 1048N
- 1055
- 1084GBM
- 1128BMX
- 1150GBM
- 1166GBM
- 1260E
- 1262E
- 1377
- 1390
- 1708/20
- 1717B
- 1719BMA...S5
- 1725

5902MT

059021053

Assortimento consigliato in abbinamento con RSC22 - RSC23 - RSC23C - C39T



5902MT/AS

assortimento di 99 utensili per macchine movimento terra (CATERPILLAR)

► Movimento terra

N. pezzi/Descrizione	Beta N.
2 punzoni Ø 3 - 4 mm	30
2 cacciaspina Ø 6 - 8 mm	31
1 bulino Ø 4 mm	32
2 scalpelli piatti nervati 150 - 200 mm	35
20 chiavi combinate 1/4÷1.1/2"	42AS
6 chiavi poligonali curve 1/4x5/16 - 3/8x7/16 - 1/2x9/16 5/8x3/4 - 11/16x13/16 - 7/8x15/16"	90AS
11 chiavi maschio esagonale piegate ○ 3/64÷3/8"	96AS/B11
10 chiavi a bussola poligonali □ 1/2" ○ 7/16 - 1/2 - 9/16 5/8 - 11/16 - 3/4 - 13/16 - 7/8 - 15/16 - 1"	920AS
1 prolunga - 1/2" 125 mm	920/21
1 prolunga - 1/2" 255 mm	920/22
1 snodo 1/2"	920/25
1 quadro maschio 1/2" con spina scorrevole	920/42
1 cricchetto con quadro scorrevole 1/2" ⊗	920/50
12 chiavi a bussola esagonali □ 3/4", 7/8 - 15/16 - 1 - 1.1/16 - 1.1/8 - 1.1/4 - 1.5/16 1.1/2 - 1.5/8 - 1.11/16 - 1.7/8 - 2"	928AS
1 prolunga - 3/4" 200 mm	928/21
1 quadro maschio snodato 3/4" con impugnatura	928/36A
1 quadro maschio 3/4" con spina scorrevole	928/42
1 cricchetto reversibile 3/4" ⊗	928/55
1 leva con estremità a punta e a becco	964
1 pinze regolabili cerniera chiusa 250 mm	1048N
1 pinza autobloccante ganasce sagomate	1055
1 tronchesi a grande effetto, a taglienti diagonali, finitura industriale ⚡ 160 mm	1084GBM
1 forbici per elettricisti lame diritte	1128BMX
1 pinze universali a grande effetto, finitura industriale = 180 mm	1150GBM
1 pinze a becchi mezzotondi lunghissimi, diritti zigrinati, impugnatura bimatereale, finitura industriale ● 160 mm	1166GBM
4 giravite lama piatta con esagono di manovra ● 6,5x150 - 8x175 - 10x200 - 12x250 mm	1260E
3 giravite Phillips® con esagono di manovra ⊕ PH2x150 - PH3x175 - PH4x200 mm	1262E
1 martello testa tonda penna sferica 900 g	1377
1 mazzuola con battenti in materiale plastico Ø 35 mm	1390
1 spessimetro 150 - 200 mm	1708/20
1 raschietto a tre taglienti 200 mm	1717B
5 serie di 5 lime 200 mm	1719BMA...S5
1 seghetto	1725

5904VG/2M

assortimento di 170 utensili in vassoio morbido in EVA

► Autoriparazione

N. pezzi/Descrizione

- 16 chiavi combinate 6÷21 mm
- 5 chiavi combinate 22 - 24 - 27 - 30 - 32 mm
- 8 chiavi maschio esagonale con impugnatura \odot 2-2,5-3-4-5-6-7-8 mm
- 5 chiavi maschio con impugnatura per viti con impronta Torx® \odot T10-T15-T20-T25-T30
- 7 inserti maschio esagonale \odot 4-5-6-7-8-10-12 mm
- 7 inserti maschio esagonale \odot 4-5-6-7-8-10-12 mm
- 5 inserti a profilo XZN® \odot 5-6-8-10-12 mm
- 5 inserti a profilo XZN® \odot 5-6-8-10-12 mm
- 7 inserti per viti con impronta Torx® \odot T20-T25-T30-T40-T45-T50-T55
- 6 inserti per viti con impronta Torx® \odot T25-T30-T40-T45-T50-T55
- 7 inserti per viti con impronta Tamper Resistant Torx® \odot T20-T25-T30-T40-T45-T50-T55
- 1 bussole portainseri per 867
- 1 bussole portainseri per 867
- 5 giravite lama piatta \bullet 3x75 - 3,5x100 - 4x125 - 5,5x150 - 6,5x150 mm
- 3 giravite per viti con impronta a croce Phillips® \oplus PH0x60 - PH1x80 - PH2x100 mm
- 1 giravite nano lama piatta \bullet 4x30 mm
- 1 giraviti nano Phillips® \oplus PH1x30 mm
- 5 inserti colorati per avvitatori per viti a testa con intaglio \bullet 0,5x3 - 0,6x4,5 - 0,8x5,5 - 1x5,5 - 1,2x6,5 mm
- 8 inserti colorati maschio esagonale per avvitatori \odot 2 - 2,5 - 3 - 4 - 5 - 6 - 8 - 10 mm
- 5 inserti colorati per avvitatori per viti con impronta a croce Phillips® \oplus PH0 - PH1 - PH2 - PH3 - PH4
- 4 inserti colorati per avvitatori per viti con impronta a croce Pozidriv® - Supadriv® \oplus PZ1 - PZ2 - PZ3 - PZ4
- 11 inserti colorati per avvitatori per viti con impronta Torx® \odot T6-T7-T8-T9-T10-T15-T20-T25-T27-T30-T40
- 8 inserti colorati per avvitatori per viti con impronta Tamper Resistant Torx® \odot T9-T10-T15-T20-T25-T27-T30-T40
- 1 portainseri a sgancio rapido con impugnatura 230 mm
- 1 cricchetto reversibile portainseri 100 mm
- 1 prolunga portainseri magnetica 80 mm
- 1 raccordi per avvitatori \blacksquare 1/4 - \square 1/4
- 2 scalpelli piatti nervati 100 - 200 mm
- 1 martello tipo tedesco 300 g
- 1 mazzuola con battenti in materiale plastico \varnothing 35 mm
- 1 prolunga angolare - 1/2" 125 mm
- 1 prolunga angolare - 1/2" 250 mm
- 1 snodo 1/2"
- 1 quadro maschio 1/2" con spina scorrevole
- 1 cricchetto reversibile 1/2" \oplus
- 19 chiavi a bussola esagonali 1/2" \odot 10÷24 - 26 - 27 - 30 - 32 mm
- 1 pinza universale \equiv 180 mm
- 1 pinza a becchi mezzotondi dritti \bullet 160 mm
- 1 tronchesi a grande effetto taglienti diagonali ∇ 160 mm
- 1 pinze becchi dritti per anelli elastici, per fori \odot 180 mm
- 1 pinze becchi piegati per anelli elastici, per fori \odot 170 mm
- 1 pinze becchi dritti per anelli elastici, per alberi \bullet 175 mm
- 1 pinze becchi piegati per anelli elastici, per alberi \bullet 175 mm

Beta N.	TR
	42
	42
	M05
	M06
	96T
	M50
	97TTX
	M55
	867PE
	M86
	867PEL
	M86
	867XZN
	M86
	867XZNL
	M86
	867TX
	M86
	867TXL
	M86
	867RTX
	M86
	867/1
	M86
	867/2
	M86
	1260
	M208
	1262
	M208
	1260N
	M208
	1262N
	M208
	860LP
	M85
	860PE
	M85
	860PH
	M85
	860PZ
	M85
	860TX
	M85
	860RTX
	M85
	851SR
	M85
	860/55
	M85
	882P
	M85
	892/0
	M85
	35
	M234
	1370
	M234
	1390
	M234
	920AN/125
	M83
	920AN/250
	M83
	920/25
	M83
	920/42
	M83
	920/55
	M83
	920A
	M83
	1150BM
	M136
	1166BM
	M136
	1084BM
	M136
	1032
	M145
	1034
	M145
	1036
	M145
	1038
	M145



M05 M06 VPM3



M50 M55 M86



M208 M85 M234



M83 M136 M145

5904VG/2M

059041198

Assortimento consigliato in abbinamento con RSC23T - RSC24 - RSC24A - RSC24AXL - RSC24L/7 - RSC24L-CAB
RSC28 - C37 - C39 - C39T - C39SM - C39MD RSC55 - C59

5904VG/2T

assortimento di 99 utensili in termoformato rigido in ABS

► Autoriparazione

N. pezzi/Descrizione

- 16 chiavi combinate 6÷21 mm
- 5 chiavi combinate 22 - 24 - 27 - 30 - 32 mm
- 19 chiavi a bussola esagonali 1/2" ⌀ 10+24 - 26 - 27 - 30 - 32 mm
- 5 chiavi a bussola maschio esagonale 1/2" ⌀ 5 - 6 - 8 - 10 - 12 mm
- 1 prolunga - 1/2" 125 mm
- 1 prolunga - 1/2" 255 mm
- 1 snodo 1/2"
- 1 quadro maschio 1/2" con spina scorrevole
- 1 cricchetto reversibile 1/2" Ⓢ
- 1 pinze regolabili cerniera chiusa 250 mm
- 1 pinza autobloccante 240 mm
- 1 tronchesi a grande effetto taglienti diagonali 160 mm
- 1 pinza a becchi mezzotondi dritti 160 mm
- 1 pinza universale 180 mm
- 1 pinze becchi dritti per anelli elastici, per fori 180 mm
- 1 pinze becchi dritti per anelli elastici, per alberi 175 mm
- 1 pinze becchi piegati per anelli elastici, per fori 170 mm
- 1 pinze becchi piegati per anelli elastici, per alberi 175 mm
- 2 scalpelli piatti nervati 100 - 200 mm
- 1 martello tipo tedesco 300 g
- 1 mazzuola con battenti in materiale plastico Ø 35 mm
- 4 giravite lama piatta 3x75 - 4x100 - 5,5x150 - 6,5x150 mm
- 3 giravite per viti con impronta a croce Phillips Ⓢ PH0x60 - PH1x80 - PH2x100 mm
- 8 chiavi a forchetta 6x7 - 8x9 - 10x11 - 12x13 - 14x15 - 16x17 - 18x19 - 20x22 mm
- 9 chiavi maschio esagonale piegate ⌀ 1,5 - 2 - 2,5 - 3 - 4 - 5 - 6 - 8 - 10 mm
- 6 chiavi maschio esagonale con impugnatura ⌀ 2 - 2,5 - 3 - 4 - 5 - 6 mm
- 6 chiavi maschio con impugnatura per viti con impronta Torx®

Beta N.	TR
	42
	T05
	42
	T06
	920A
	T80
	920ME
	T80
	920/21
	T80
	920/22
	T80
	920/25
	T80
	920/42
	T80
	920/55
	T80
	1048N
	T153
	1052
	T153
	1084
	T138
	1166
	T138
	1150
	T138
	1032
	T145
	1036
	T145
	1034
	T145
	1038
	T145
	35
	T234
	1370
	T234
	1390
	T234
	1260
	T208
	1262
	T208
	55
	T33
	96/SC9
	T33
	96T
	T52
	97TTX
	T55



T05 T06 T80



T153 T138 T145 T234



T208 T33 T52 T55

5904VG/2T

059041191

Assortimento consigliato in abbinamento con: RSC51 - RSC23T - RSC24 - RSC24A - RSC24AXL - RSC24L/7 - RSC24L-CAB - RSC28 - C37 - C39 - C39SM - C39MD - C39T - RSC55 - C59



5904VG/3

assortimento di 132 utensili

► Autoriparazione

N. pezzi/Descrizione	Beta N.
6 cacciaspina Ø 2÷8 mm	31/B6N
1 bulino Ø 5 mm	32
1 scalpelli piatti nervati 200 mm	35
17 chiavi combinate 6÷22 mm	42
8 chiavi a forchetta 6x7 - 8x9 - 10x11 - 12x13 - 14x15 - 16x17 - 18x19 - 20x22 mm	55
9 chiavi maschio esagonale piegate ○ 1,5 - 2 - 2,5 - 3 - 4 - 5 - 6 - 8 - 10 mm	96N/SC9
11 chiavi maschio esagonale con impugnatura ○ 2÷10 mm	96T/SP11
13 chiavi maschio piegate per viti con impronta Torx® ⊕ T6÷T50	97TX/B13
1 chiave regolabile a rullino 300 mm	111E
13 chiavi a bussola esagonali 1/2" con guida ○ 10÷22 mm	920A/SB13
1 prolunga - 1/2" 125 mm	920/21
1 prolunga - 1/2" 255 mm	920/22
1 snodo 1/2"	920/25
1 quadro maschio 1/2" con spina scorrevole	920/42
1 cricchetto con quadro scorrevole 1/2" ⊕	920/50
6 chiavi a T con bussola snodata ○ 8 - 10 - 12 - 13 - 17 - 19 mm	952
1 leva piatta curva con impugnatura 450 mm	965
2 pinze becchi dritti per anelli elastici, per fori ○ 180 - 225 mm	1032
2 pinze becchi piegati per anelli elastici, per fori ○ 170 - 210 mm	1034
2 pinze becchi dritti per anelli elastici, per alberi ● 175 - 225 mm	1036
2 pinze becchi piegati per anelli elastici, per alberi ● 175 - 220 mm	1038
1 pinze regolabili cerniera chiusa 250 mm	1048N
1 pinza autobloccante 240 mm	1057A
1 tronchesi a grande effetto, a taglienti diagonali, finitura industriale ⚡ 200 mm	1084GBM
1 tronchesi doppia leva taglio frontale ⚡ 200 mm	1092V
1 cesoia a lame larghe diritte 250 mm	1112
1 forbici per elettricisti lame diritte	1128BMX
1 pinze universali a grande effetto, finitura industriale = 180 mm	1150GBM
4 giravite lama piatta ● 3x75 - 4x100 - 5,5x125 - 6,5x150 mm	1260
1 giravite nano lama piatta ● 6,5x30 mm	1260N
2 giravite lama piatta con esagono di manovra ● 8x175 - 10x200 mm	1260E
3 giravite per viti con impronta a croce Phillips® ⊕ PH0x100 - PH1x120 - PH2x100 mm	1262
1 giraviti nano Phillips® ⊕ PH2x30 mm	1262N
1 giravite Phillips® con esagono di manovra ⊕ PH3x175mm	1262E
1 giravite lungo Phillips® ⊕ PH2x400 mm	1262L
1 giravite lungo lama parallela ● 6,5x400 mm	1264L
1 martello tipo tedesco 500 g	1370
1 mazzuola con battenti in materiale plastico Ø 45 mm	1390
1 chiave regolabile a nastro per filtri olio	1491
1 spessimetro	1708/20
5 serie di 5 lime 200 mm	1719BMA...S5
1 seghetto	1726BM
1 oliatore in metallo a pressione 200 cc	1751N

5904VG/3

059041062

Assortimento consigliato in abbinamento con RSC24 - RSC24A - RSC24AXL - RSC24L/7 - RSC24L-CAB - C37
C39 da 7 - 8 cassette - RSC55 - C59

5904VG/3T

assortimento di 102 utensili in termoformato rigido in ABS

► Autoriparazione

N. pezzi/Descrizione

N. pezzi/Descrizione	Beta N.	TR
21 chiavi combinate 6-7-8-9-10-11-12-13-14-15-16-17 18-19-20-21-22-24-27-30-32 mm	42	T05-T06
8 chiavi a forchetta 6x7-8x9-10x11-12x13-14x15 16x17-18x19-20x22 mm	55	T33
9 chiavi maschio esagonale piegate \odot 1,5+10 mm	96/SC9	T33
6 chiavi maschio esagonale con impugnatura \odot 2-2,5-3-4-5-6 mm	96T	T52
8 chiavi a T con bussola snodata \odot 7-8-10-12-13-14-17-19 mm	952	T63
19 chiavi a bussola esagonali 1/2" \odot 10-11-12-13-14-15-16-17-18-19 20-21-22-23-24-26-27-30-32 mm	920A	T83
1 prolunga - 1/2" 125 mm	920/21	T83
1 prolunga - 1/2" 255 mm	920/22	T83
1 snodo 1/2"	920/25	T83
1 quadro maschio 1/2" con spina scorrevole 305 mm	920/42	T83
1 cricchetto reversibile 1/2" \oplus	920/55	T83
1 tronchesi a grande effetto taglienti diagonali ∇ 160 mm	1084BM	T137
1 pinza universale \equiv 180 mm	1150BM	T137
1 pinza a becchi mezzotondi dritti \bullet 160 mm	1166BM	T137
1 pinze becchi dritti per anelli elastici, per fori \odot 180 mm	1032	T145
1 pinze becchi piegati per anelli elastici, per fori \odot 170 mm	1034	T145
1 pinze becchi dritti per anelli elastici, per alberi \bullet 175 mm	1036	T145
1 pinze becchi piegati per anelli elastici, per alberi \bullet 175 mm	1038	T145
1 pinza autobloccante 240 mm	1052	T153
1 pinze regolabili cerniera chiusa 250 mm	1048N	T153
7 giravite lama piatta \bullet 2,5x50 - 3x75 - 3,5x100 - 4x125 - 5,5x100 - 5,5x150 - 6,5x150 mm	1260	T199
6 giravite per viti con impronta a croce Phillips® \oplus PH0x60 - PH0x100 - PH1x80 PH1x120 - PH2x100 - PH2x150 mm	1262	T202
2 scalpelli piatti nervati 100-200 mm	35	T234
1 martello tipo tedesco 300 g	1370	T234
1 mazzuola con battenti in materiale plastico \varnothing 35 mm	1390	T234
1 termoformato vuoto	VP5	



T199 T202 T83



T145 T153 T137 T234



T52 T33 T05 T06



T63 VP5

5904VG/3T

059041510

Assortimento consigliato in abbinamento con RSC23T - RSC24 - RSC24A - RSC24AXL - RSC24L/7 - RSC24L-CAB
RSC28 - C37 - C39 - C39MD - C39SM - C39T - RSC55 - C59

5904VG/5T

assortimento di 153 utensili in termoformato rigido in ABS

► Autoriparazione

N. pezzi/Descrizione

- 5 chiavi a bussola maschio esagonale 1/2" ○ 5 - 6 - 8 - 10 - 12 mm
- 1 prolunga - 1/2" 125 mm
- 1 prolunga - 1/2" 255 mm
- 1 snodo 1/2"
- 1 quadro maschio 1/2" con spina scorrevole
- 1 cricchetto reversibile 1/2" ⊕
- 19 chiavi a bussola esagonali 1/2" ○ 10÷24 - 26 - 27 - 30 - 32 mm
- 16 chiavi combinate 6÷21 mm
- 5 chiavi combinate 22 - 24 - 27 - 30 - 32 mm
- 8 chiavi a T con bussola snodata ○ 7 - 8 - 10 - 12 - 13 - 14 - 17 - 19 mm
- 1 termoformato vuoto
- 1 pinze becchi dritti per anelli elastici, per fori ○ 180 mm
- 1 pinze becchi piegati per anelli elastici, per fori ○ 170 mm
- 1 pinze becchi dritti per anelli elastici, per alberi ● 175 mm
- 1 pinze becchi piegati per anelli elastici, per alberi ● 175 mm
- 7 giravite lama piatta ● 2,5x50 - 3x75 - 3,5x100 - 4x125 - 5,5x100 - 5,5x150 - 6,5x150 mm
- 5 chiavi maschio con impugnatura per viti con impronta Torx® ⊕ T25 - T27 - T30 - T40 - T45
- 6 chiavi maschio esagonale con impugnatura ○ 2 - 2,5 - 3 - 4 - 5 - 6 mm
- 8 chiavi a forchetta 6x7 - 8x9 - 10x11 - 12x13 - 14x15 - 16x17 - 18x19 - 20x22 mm
- 9 chiavi maschio esagonale piegate ○ 1,5 - 2 - 2,5 - 3 - 4 - 5 - 6 - 8 - 10 mm
- 3 giravite lama piatta ● 8x150 - 8x200 - 10x200 mm
- 2 giravite nano lama piatta ● 4x30 - 6,5x30 mm
- 6 giravite Phillips® ⊕ PH0x60 - PH0x100 - PH1x80 - PH1x120 - PH2x100 - PH2x150 mm
- 2 giravite Phillips® ⊕ PH3x150 - PH4x200 mm
- 2 giravite nano Phillips® ⊕ PH1x30 - PH2x30 mm
- 2 scalpelli piatti nervati 100 - 200 mm
- 1 martello tipo tedesco 300 g
- 1 mazzuola con battenti in materiale plastico Ø 35 mm
- 1 pinza universale = 180 mm
- 1 pinza a becchi mezzotondi dritti ● 160 mm
- 1 tronchesi a grande effetto taglienti diagonali ⚡ 160 mm
- 6 inserti per avvitatori per viti con impronta Torx® ⊕ T6÷T15
- 8 inserti per avvitatori per viti con impronta Torx® ⊕ T20÷T55
- 1 bussola portainseri
- 1 bussola portainseri
- 6 chiavi a bussola 1/4" per viti con teste a profilo Torx® ⊕ E4÷E10
- 7 chiavi a bussola 1/2" per viti con teste a profilo Torx® ⊕ E12÷E24
- 3 chiavi a bussola maschio per viti con impronta Torx® 1/2" ⊕ T55L - T60 - T70L
- 1 pinze regolabili cerniera chiusa 250 mm
- 1 pinza autobloccante 240 mm

Beta N.	TR
920ME	T80
920/21	T80
920/22	T80
920/25	T80
920/42	T80
920/55	T80
920A	T80
42	T05
42	T06
952	T63
VP6	VP6
1032	T145
1034	T145
1036	T145
1038	T145
1290	T170
1297TX	T176
96T	T52
55	T33
96N/SC9	T33
1290	T171
1290N	T171
1292	T172
1292	T173
1292N	T173
35	T234
1370	T234
1390	T234
1150BM	T137
1166BM	T137
1084BM	T137
861TX	T112
866TX	T112
895/1	T112
895/6	T112
900FTX	T112
920FTX	T112
920TX	T112
1048N	T153
1052	T153



T80 T05 T06



T63 VP6



T145 T170 T176 T52



T33 T171 T172 T173



T234 T137 T112 T153

5904VG/5T

059041196

Assortimento consigliato in abbinamento con RSC23T - RSC24 da 7-8 cassette - RSC24A da 7-8 cassette - RSC24AXL da 7-8 cassette - RSC24L/7 - RSC24L-CAB - RSC28 - C37 da 7-8 cassette - C39 da 7-8 cassette - C39MD - C39SM RSC55 - C59



5905VG/1

assortimento di 94 utensili per carrozzieri

► Autoriparazione

N. pezzi/Descrizione	Beta N.
1 punzoni Ø 4 mm	30
6 cacciapina Ø 2 - 3 - 4 - 5 - 6 - 8 mm	31/B6N
1 bulino Ø 4 mm	32
1 scalpelli piatti 150 mm	34
1 ugnetti 150 mm	36
17 chiavi combinate 6÷22 mm	42
10 chiavi maschio esagonale piegate ○ 1,5÷12 mm	96/B10
1 chiavi regolabili a rullino fosfatate con scala graduata 300 mm	111EN
12 chiavi a bussola con impugnatura, tipo lungo ○ 4÷14 mm	943BX
1 leva piatta curva con impugnatura 450 mm	965
1 pinze regolabili cerniera chiusa 250 mm	1048N
1 pinza autobloccante 240 mm	1052
1 pinza autobloccante ganasce alluminio 280 mm	1060AL
1 tronchesi a grande effetto, a taglienti diagonali, finitura industriale 160 mm	1084GBM
1 tenaglia per cementisti 250 mm	1098PL
1 cesoia a doppia leva dritta	1122
1 forbici per elettricisti lame dritte	1128BMX
1 pinze universali a grande effetto, finitura industriale = 180 mm	1150GBM
1 giravite Dzus® ●	1201E/DZ
4 giravite lama piatta ● 3x75 - 4x100 - 5,5x150 - 6,5x150 mm	1260
1 giravite nano lama piatta ● 4x30 mm	1260N
2 giravite lama piatta con esagono di manovra ● 10x175 - 12x200 mm	1260E
3 giravite per viti con impronta a croce Phillips® ● PH0x60 - PH1x80 - PH2x100 mm	1262
1 giraviti nano Phillips® ● PH1x30 mm	1262N
1 giravite Phillips® con esagono di manovra ● PH3x175 mm	1262E
7 chiave maschio per viti con impronta Torx® ⦿ T6 - T8 - T10 - T15 - T20 - T25 - T30	1267TX
1 tasso a virgola 1350 g	1303
1 tasso curvo	1305
1 tasso a tacco bombato	1306
1 tasso a rotaia	1310
1 tasso a teste tonde convessa e piana	1314
1 leva a cazzuola	1326
1 leva a cucchiaio pesante	1327
1 leva a gomito e piana	1330
1 lima e portailima	1338A
1 scalpello extrapiatto con paramano	1342PM
1 martello con testa tonda e penna	1345
1 martello con testa tonda e quadra Ø 40 mm	1357Z/45
1 martello tipo tedesco 300 g	1370
1 mazzuola con battenti in materiale plastico Ø 35 mm	1390
1 flessometro 5 m	1692

5905VG/1

059051058

Assortimento consigliato in abbinamento con C25

5905VG/2

assortimento di 118 utensili

► Autoriparazione

N. pezzi/Descrizione	Beta N.
6 2 punzoni, 1 bulino, 2 scalpelli piatti e 1 ugnetto in busta avvolgibile in poliestere	38/B6N
13 chiavi combinate 6÷14 - 17 - 19 - 22 - 24 mm	42
13 chiavi a forchetta 6x7 - 8x9 - 10x11 - 12x13 - 14x15 - 16x17 - 18x19 - 20x22 - 21x23 - 24x26 - 25x28 - 27x29 - 30x32 mm	55
3 chiavi poligonali doppie starter 11x13 - 14x17 - 19x22 mm	83
10 chiavi maschio esagonale piegate \odot 1,5÷12 mm	96N/B10
6 chiavi maschio con impugnatura per viti con impronta Torx® \odot T10 - T15 - T20 - T25 - T30 - T40	97TTX
2 chiavi a bussola Macchina 1/2" \odot 17 - 19 mm	720
20 chiavi a bussola esagonali 1/2" \odot 10÷24 - 26 - 27 - 28 - 30 - 32 mm	920A
1 prolunga - 1/2" 125 mm	920/21
1 prolunga - 1/2" 255 mm	920/22
1 snodo 1/2"	920/25
1 quadro maschio 1/2" con spina scorrevole	920/42
1 cricchetto reversibile 1/2" \odot	920/55
8 chiavi a T con bussola snodata \odot 7 - 8 - 10 - 11 - 13 - 14 - 17 - 19 mm	952
1 chiavi a T con bussola snodata per candele	959
1 \odot 17x19x22x ■ 1/2"	979
1 pinze becchi dritti per anelli elastici, per fori \odot 180 mm	1032
1 pinze becchi piegati per anelli elastici, per fori \odot 170 mm	1034
1 pinze becchi dritti per anelli elastici, per alberi \bullet 175 mm	1036
1 pinze becchi piegati per anelli elastici, per alberi \bullet 175 mm	1038
1 pinze regolabili cerniera chiusa 250 mm	1048N
1 pinza autobloccante 240 mm	1052
1 tronchesi a grande effetto, a taglienti diagonali, finitura industriale ∇ 160 mm	1084GBM
1 cesoia a doppia leva dritta 250 mm	1122
1 forbici per elettricisti lame diritte	1128BMX
1 pinze universali a grande effetto, finitura industriale \equiv 180 mm	1150GBM
1 pinze a becchi mezzotondi lunghissimi, dritti zigrinati, impugnatura bimatereale, finitura industriale \bullet 160 mm	1166GBM
8 giravite lama piatta \bullet 2,5x50 - 3x75 - 3,5x100 - 4x125 - 5,5x125 - 6,5x150 - 8x200 - 10x200 mm	1260
2 giravite lama piatta con esagono di manovra \bullet 10x200 - 12x250 mm	1260E
1 giravite nano lama piatta \bullet 6,5x30 mm	1260N
4 giravite per viti con impronta a croce Phillips® \oplus PH0x60 - PH1x80 - PH2x100 - PH3x150 mm	1262
1 martello tipo tedesco 400 g	1370
1 mazzuola con battenti in materiale plastico \varnothing 35 mm	1390
1 chiave regolabile a nastro per filtri olio	1491
1 provatensione 3÷48 V	1498



5905VG/2

059051044

Assortimento consigliato in abbinamento con C25

5908VG/2T

assortimento di 214 utensili in termoformato rigido in ABS

► Autoriparazione

N. pezzi/Descrizione

- 16 chiavi combinate 6÷21 mm
- 5 chiavi combinate 22 - 24 - 27 - 30 - 32 mm
- 5 cacciapina Ø 2 - 3 - 4 - 5 - 6 mm
- 1 bulino Ø 4 mm
- 12 chiavi a forchetta 6x7 - 8x9 - 10x11 - 12x13 - 14x15 - 16x17
18x19 - 20x22 - 21x23 - 24x26 - 27x29 - 30x32 mm
- 9 chiavi maschio esagonale piegate ○ 1,5 - 2 - 2,5 - 3 - 4 - 5 - 6 - 8 - 10 mm
- 5 chiavi a bussola maschio esagonale 1/2" ○ 5 - 6 - 8 - 10 - 12 mm
- 1 prolunga - 1/2" 125 mm
- 1 prolunga - 1/2" 255 mm
- 1 snodo 1/2"
- 1 quadro maschio 1/2" con spina scorrevole
- 1 cricchetto reversibile 1/2" Ⓢ
- 19 chiavi a bussola esagonali 1/2" ○ 10÷24 - 26 - 27 - 30 - 32 mm
- 1 pinze becchi diritti per anelli elastici, per fori ○ 180 mm
- 1 pinze becchi piegati per anelli elastici, per fori ○ 170 mm
- 1 pinze becchi diritti per anelli elastici, per alberi ● 175 mm
- 1 pinze becchi piegati per anelli elastici, per alberi ● 175 mm
- 1 pinze becchi diritti per anelli elastici, per fori ○ 140 mm
- 1 pinze becchi diritti per anelli elastici, per fori ○ 225 mm
- 1 pinze becchi diritti per anelli elastici, per alberi ● 140 mm
- 1 pinze becchi diritti per anelli elastici, per alberi ● 225 mm
- 9 giravite lama piatta ● 3x75 - 3x100 - 4x100 - 4x150 - 5,5x100 - 5,5x150
6,5x150 - 8x150 - 10x200 mm
- 2 giravite nano lama piatta ● 4x30 - 6,5x30 mm
- 7 giravite per viti con impronta a croce Phillips® ⚙ PH0x60 - PH0x100 - PH1x80 - PH1x120 - PH2x100 - PH2x150 - PH3x150 mm
- 2 giravite nano Phillips® ⚙ PH1x30 - PH2x30 mm
- 8 chiavi a T con bussola snodata ○ 7 - 8 - 10 - 12 - 13 - 14 - 17 - 19 mm
- 2 giravite lungo Phillips® ⚙ PH1x400 - PH2x400 mm
- 3 giravite lungo lama parallela ● 3x300 - 4x400 - 5x400 mm
- 6 chiavi maschio con impugnatura per viti con impronta Torx® ⚙ T10-T15-T20-T25-T27-T30
- 12 chiavi a bussola Macchina 1/2" ○ 10-13-17-18-19-21-22-24-27-30-32 mm
- 1 prolunga Macchina con attacchi quadri maschio e femmina 1/2" 125 mm
- 3 chiavi a bussola Macchina per dadi ruote ○ 17-19-21
- 5 chiavi a bussola maschio esagonale 1/2" ○ 5L - 6L - 7L - 8L - 10L
- 4 chiavi a bussola maschio per viti con impronta Torx® 1/2" ○ T40L - T45L - T55L - T70L
- 3 chiavi a bussola maschio a profilo XZN® ○ M6L - M8L - M12L
- 5 lime a taglio mezzodolce 200 mm
- 1 chiave regolabile a nastro per filtri olio 110 mm
- 1 chiave a bussola quadrata per tappi olio motore ■ 10 mm
- 7 chiavi a bussola maschio esagonale per tappi olio motore ○ 8-9-10-11-12-14-17 mm
- 4 chiavi a bussola maschio quadrato per tappi olio motore ○ 8-9,5-12-13 mm
- 1 chiave a bussola maschio triangolare per tappi olio motore Δ
- 1 chiave a bussola maschio con profilo XZN® per tappi olio motore ○
- 1 chiavi per tappi olio motore
- 2 scalpelli piatti nervati 100 - 200 mm
- 1 martello tipo tedesco 300 g
- 1 mazzuola con battenti in materiale plastico Ø 35 mm
- 1 pinze regolabili cerniera chiusa 250 mm
- 1 pinza autobloccante 240 mm
- 1 pinza universale ■ 180 mm
- 1 pinza a becchi mezzotondi diritti ● 160 mm
- 1 tronchesi a grande effetto taglienti diagonali ⚡ 160 mm
- 11 chiavi a bussola esagonali 3/4" ○ 22-24-27-30-32-34-36-38-41-46-50 mm
- 1 prolunga - 3/4" 200 mm
- 1 prolunga - 3/4" 380 mm
- 1 quadro maschio 3/4" con spina scorrevole 450 mm
- 1 cricchetto reversibile 3/4" Ⓢ
- 1 termoformato vuoto
- 4 chiavi maschio esagonale piegate ○ 13-14-17-19 mm
- 1 chiave regolabile a rullino 300 mm
- 1 leva piatta curva con impugnatura
- 1 cesoia a lame larghe diritte 250 mm
- 1 forbici per elettricisti lame diritte
- 1 martello tipo tedesco 1000 g
- 1 spessimetro
- 1 magnete telescopico punta flessibile
- 1 specchietto telescopico
- 1 raschietto a tre taglienti 200 mm
- 1 seghetto 440 mm
- 1 spazzola fili d'acciaio
- 1 oliatore in metallo a pressione 200 cl
- 1 cutter con lama a settori

Beta N.	TR
42	T05
42	T06
31	T31
32	T31
55	T31
96N/SC9	T31
920ME	T80
920/21	T80
920/22	T80
920/25	T80
920/42	T80
920/55	T80
920A	T80
1032	T145
1034	T145
1036	T145
1038	T145
1032	T146
1032	T146
1036	T146
1036	T146
1260	T167
1262	T168
1262N	T168
952	T63
1262L	T209
1264L	T209
97TTX	T55
720	T111
720/21	T111
720LC	T111
920PE	T113
920TX	T113
920XZN	T113
1719BMA8/S5	T236
1491	T264
1494	T264
1494E	T264
1494Q	T264
1494T	T264
1494XZN	T264
1496C	T264
35	T234
1370	T234
1390	T234
1048N	T153
1052	T153
1150	T138
1166	T138
1084	T138
928A	T105
928/21	T106
928/22	T106
928/42	T106
928/55	T106
VP6	VP6
96N	VP6
111E	VP6
965	VP6
1112	VP6
1128BMX	VP6
1370	VP6
1708/20	VP6
1712	VP6
1715	VP6
1717B	VP6
1726	VP6
1737NX	VP6
1751N	VP6
1771	VP6

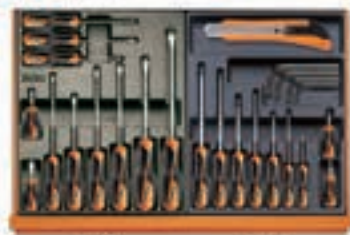

5908VG/2T

059081017

Assortimento consigliato in abbinamento con RSC28

5910VG/3T

assortimento di 202 utensili in termoformato rigido in ABS

► Autoriparazione

N. pezzi/Descrizione

- 16 chiavi combinate 6÷21 mm
- 5 chiavi combinate 22 - 24 - 27 - 30 - 32 mm
- 6 chiavi a bussola poligonale snodate doppie 8x9 - 10x11 - 12x13 - 14x15 - 16x17 - 18x19 mm
- 1 chiave regolabile a nastro per filtri olio 110 mm
- 1 chiave a bussola quadrata per tappi olio motore ■ 10 mm
- 7 chiavi a bussola maschio esagonale per tappi olio motore ○ 8-9-10-11-12-14-17 mm
- 4 chiavi a bussola maschio quadrato per tappi olio motore ○ 8-9-5-12-13 mm
- 1 chiave a bussola maschio triangolare per tappi olio motore Δ
- 1 chiave a bussola maschio con profilo XZN® per tappi olio motore ○
- 1 chiavi per tappi olio motore
- 5 chiavi a bussola maschio esagonale 1/2" ○ 5 - 6 - 8 - 10 - 12 mm
- 1 prolunga - 1/2" 125 mm
- 1 prolunga - 1/2" 255 mm
- 1 snodo 1/2"
- 1 quadro maschio 1/2" con spina scorrevole
- 1 cricchetto reversibile 1/2" ⊕
- 19 chiavi a bussola esagonali 1/2" ○ 10÷24 - 26 - 27 - 30 - 32 mm
- 1 pinze becchi dritti per anelli elastici, per fori ○ 180 mm
- 1 pinze becchi piegati per anelli elastici, per fori ○ 170 mm
- 1 pinze becchi dritti per anelli elastici, per alberi ● 175 mm
- 1 pinze becchi piegati per anelli elastici, per alberi ● 175 mm
- 1 pinze becchi dritti per anelli elastici, per fori ○ 140 mm
- 1 pinze becchi piegati per anelli elastici, per fori ○ 225 mm
- 1 pinze becchi dritti per anelli elastici, per alberi ● 140 mm
- 1 pinze becchi piegati per anelli elastici, per alberi ● 225 mm
- 6 chiavi maschio con impugnatura per viti con impronta Torx® ⊕ T10-T15-T20-T25-T27-T30
- 12 chiavi combinate a cricchetto snodate 8 - 9 - 10 - 11 - 12 - 13 - 14 - 15 - 16 - 17 - 18 - 19 mm
- 1 pinza universale = 180 mm
- 1 pinza a becchi mezzotondi dritti ● 160 mm
- 1 tronchesi a grande effetto taglienti diagonali ⊥ 160 mm
- 1 pinza regolabile a pulsante 240 mm
- 1 pinza autobloccante 240 mm
- 8 chiavi a T con bussola snodata ○ 7 - 8 - 10 - 12 - 13 - 14 - 17 - 19 mm
- 9 giravite lama piatta ● 3x75 - 3,5x100 - 4x100 - 4x150 - 5,5x100 - 5,5x150 - 6,5x150 - 8x150 - 10x200 mm
- 2 giravite nano lama piatta ● 4x30 - 6,5x30 mm
- 6 cacciaspina
- 7 giravite per viti con impronta a croce Phillips® ⊕ PH0x60 - PH0x100 - PH1x80 - PH1x120 - PH2x100 - PH2x150 - PH3x150 mm
- 2 giraviti nano Phillips® ⊕ PH1x30 - PH2x30 mm
- 1 chiave regolabile a rullino 250 mm
- 1 quadro maschio a T snodato 1/2"
- 6 chiavi a T maschio esagonale ○ 2,5-3-4-5-6-8 mm
- 4 chiavi a T con maschio esagonale snodato ○ 4-5-6-8 mm
- 2 martello tipo tedesco 300-500 g
- 2 giravite lungo Phillips® ⊕ PH1x400 - PH2x400 mm
- 3 giravite lungo lama parallela ● 3x300 - 4x400 - 5x400 mm
- 9 chiavi maschio esagonale piegate con estremità sferica ○
- 1 chiavi dinamometriche a scatto ⊕ 8 ÷ 60 Nm
- 1 chiavi dinamometriche a scatto ⊕ 60 ÷ 330 Nm
- 12 chiavi a bussola Macchina
- 1 raccordo quadro maschio 1/2" e femmina 3/8"
- 1 assortimento di 12 chiavi a bussola e 5 accessori 3/4"
- 3 leva con testa snodata piatta curva
- 1 mazzuola antirimbalzo Ø 50 mm
- 1 avvitatore reversibile in materiale composito ⊕

Beta N.	TR
42	T05
42	T06
80	T79
1491	T264
1494	T264
1494E	T264
1494Q	T264
1494T	T264
1494XZN	T264
1496/C	T264
920ME	T80
920/21	T80
920/22	T80
920/25	T80
920/42	T80
920/55	T80
920A	T80
1032	T145
1034	T145
1036	T145
1038	T145
1032	T146
1034	T146
1036	T146
1038	T146
97TTX	T55
142SN	T46
1150BM	T137
1166BM	T137
1084BM	T137
1047	T151
1057A	T151
952	T63
1260	T167
1260N	T167
31/B6N	T168
1262	T168
1262N	T168
111E	T59
920/40	T59
951	T59
953	T59
1370	T59
1262L	T209
1264L	T209
96BPC/SC9	T209
666N/5	T209
666N/30	T209
720/C12	T209
910/16	T209
928A/C12	T209
966/C3	T209
1392	T209
1927P	T209



T05 T06 T79 T264



T80 T145 T146



T55 T46 T137 T151

T63



T167 T168

+ 96BPC/SC9
+ 31/B6N

T59



T209



5910VG/3T

059101068

Assortimento consigliato in abbinamento con C30M

5935VG/1MB

assortimento di 98 utensili per cassettera C35, in vassoio morbido in EVA

► Autoriparazione

N. pezzi/Descrizione

- 21 chiavi combinate 6-7-8-9-10-11-12-13-14-15-16-17-18-19-20-21-22-24-27-30-32 mm
- 8 chiavi a forchetta 6x7-8x9-10x11-12x13-14x15
16x17-18x19-20x22 mm
- 1 pinze regolabili cerniera chiusa 250 mm
- 4 giravite lama piatta ● 3x75-4x100-5x125-6,5x150 mm
- 3 giravite per viti con impronta a croce Phillips® ● PH0x60-PH1x80--PH2x100 mm
- 6 chiave maschio per viti con impronta Torx® ● T8-T10-T15-T20-T25-T30
- 9 chiavi maschio esagonale piegate con estremità sferica ○
- 6 chiavi maschio esagonale con impugnatura ○ 2-2,5-3-4-5-6
- 1 pinza autobloccante 240 mm
- 19 chiavi a bussola esagonali 1/2" ○ 10-11-12-13-14-15-16-17-18-19-20-21
22-23-24-26-27-30-32 mm
- 1 prolunga - 1/2" 125 mm
- 1 prolunga - 1/2" 250 mm
- 1 snodo 1/2"
- 1 quadro maschio 1/2" con spina scorrevole
- 1 cricchetto reversibile 1/2" Ⓢ
- 5 chiavi a bussola maschio esagonale 1/2" ○ 5-6-8-10-12 mm
- 1 pinze becchi dritti per anelli elastici, per fori ○ 180 mm
- 1 pinze becchi piegati per anelli elastici, per fori ○ 170 mm
- 1 pinze becchi dritti per anelli elastici, per alberi ● 175 mm
- 1 pinze becchi piegati per anelli elastici, per alberi ● 175 mm
- 1 scalpelli piatti nervati 200 mm
- 1 tronchesi a grande effetto taglienti diagonali ⚡ 160 mm
- 1 pinza universale = 180 mm
- 1 pinza a becchi mezzotondi dritti ● 160 mm
- 1 martello tipo tedesco 500 g
- 1 mazzuola con battenti in materiale plastico 35 mm

Beta N.	TR
42	MB12
55	MB12
1048N	MB12
1260	MB46
1262	MB46
1267TX	MB46
96BPC/SC9	MB46
96T	MB46
1052	MB46
920A	MB39
920/21	MB39
920/22	MB39
920/25	MB39
920/42	MB39
920/55	MB39
920PE	MB39
1032	MB39
1034	MB39
1036	MB39
1038	MB39
35	MB39
1084BM	MB39
1150BM	MB39
1166BM	MB39
1370	MB39
1390	MB39



MB12



MB39



MB46

5935VG/1MB

059351321

Assortimento consigliato in abbinamento con C35

5940SBK

assortimento di 125 utensili

► Motoriparazione

N. pezzi/Descrizione

- 1 punzoni Ø 2 mm
- 1 bulino Ø 4 mm
- 1 scalpelli piatti 125 mm
- 10 chiavi combinate 6 - 7 - 8 - 10 - 11 - 12 - 13 - 14 - 17 - 19 mm
- 6 chiavi a forchetta 6x7 - 8x9 - 10x11 - 12x13 - 14x15 - 16x17 mm
- 9 chiavi maschio esagonale piegate ○ 1,5 - 2 - 2,5 - 3 - 4 - 5 - 6 - 8 - 10 mm
- 1 chiavi dinamometriche a scatto Ⓢ 3/8", 8÷60 Nm
- 54 Assortimento di 52 inserti con attacco esagonale 10 mm e 2 accessori
- 17 assortimento di 12 chiavi a bussola e 5 accessori
- 1 raccordo quadro maschio 1/2" e femmina 3/8"
- 2 chiavi a bussola per candele ○ 14 - 16 mm
- 1 pinza a becchi mezzotondi lunghissimi ● 283 mm
- 2 pinze becchi dritti per anelli elastici, per fori ○ 140 - 180 mm
- 1 pinze becchi dritti per anelli elastici, per alberi ● 140x1,3 mm
- 1 tronchesi a taglienti diagonali, finitura industriale ⚡ 160 mm
- 1 forbici per elettricisti lame dritte
- 1 pinze universali a grande effetto, finitura industriale = 180 mm
- 1 giravite Dzus® ●
- 4 giravite lama piatta ● 3x75 - 4x100 - 5,5x100 - 6,5x150 mm
- 3 giravite Phillips® ● PH0x60 - PH1x80 - PH2x100 mm
- 1 giravite provacircuito ●
- 1 martello tipo tedesco 300 g
- 1 chiave regolabile a nastro per filtri olio
- 1 spessimetro
- 1 miniseghetto
- 1 spazzola fili d'ottone
- 1 oliatore in plastica a pressione 250 cc

Beta N.	TR
30	
32	
34	
42	
55	
96/SC9	
666N/5	
867/C52	
920A/C12X	
910/16	
956C	
1009L/A	
1032	
1036	
1082G	
1128BM	
1150G	
1201E/DZ	
1201E	
1202E	
1254	
1370	
1491	
1708/13	
1725CR	
1737	
1754	

5940SBK

059401082

Assortimento consigliato in abbinamento con C41H - C41S - C42H

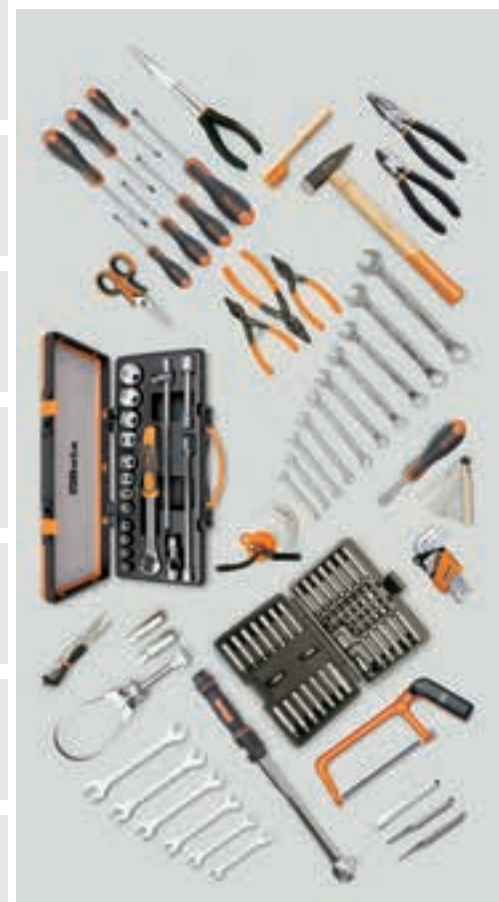

5941VU/M

assortimento di 64 utensili per trolley C41H, in vassoio morbido in EVA

► Universali

N. pezzi/Descrizione

- 16 chiavi combinate 6-7-8-9-10-11-12-13-14-15-16-17-18-19-21-22 mm
- 9 chiavi maschio esagonale piegate ○
- 1 flessometro 5 m
- 19 chiavi a bussola esagonali 1/2" ○ 10-11-12-13-14-15-16-17-18-19-20-21-22-23-24-26-27-30-32 mm
- 1 snodo 1/2"
- 1 quadro maschio 1/2" con spina scorrevole
- 1 cricchetto reversibile 1/2" ⊕
- 2 prolunga angolare - 1/2" 125-250 mm
- 1 chiave regolabile a rullino 250 mm
- 1 pinze regolabili cerniera chiusa 250 mm
- 1 tronchesi a taglienti diagonali, finitura industriale ⚡ 160 mm
- 1 forbici per elettricisti lame diritte 145 mm
- 1 pinze universali a grande effetto, finitura industriale = 180 mm
- 1 pinze a becchi mezzotondi lunghissimi, diritti zigrinati, impugnatura bimatereale, finitura industriale ● 160 mm
- 3 giravite lama piatta ● 3,5x100-5,5x125-6,5x150 mm
- 3 giravite per viti con impronta a croce Phillips® ⊕ PH0-PH1-PH2
- 1 martello tipo tedesco 300 g
- 1 cutter con lama a settori 18 mm

Beta N.	TR
42	MC12
96/SC9	MC12
1692/5	MC12
920A	MC21
920/25	MC21
920/42	MC21
920/55	MC21
920AN	MC21
111E	
1048N	
1082GBM	
1128BMX	
1150GBM	
1166GBM	
1260	
1262	
1370	
1771	



MC21



MC12



5941VU/M

059411002

Assortimento consigliato in abbinamento con C41H

Beta

5945VUM

assortimento di 231 utensili in vassoio morbido in EVA

► Universali

N. pezzi/Descrizione

- 21 chiavi combinate 6-7-8-9-10-11-12-13-14-15-16-17-18-19-20-21-22-24-27-30-32 mm
 9 chiavi maschio esagonale piegate con estremità sferica \odot 1,5-2-2,5-3-4-5-6-8-10 mm
 8 chiavi maschio esagonale con impugnatura \odot 2-2,5-3-4-5-6-7-8 mm
 1 martello tipo tedesco 300 g
 1 mazzuola con battenti in materiale plastico \varnothing 35
 2 scalpelli piatti nervati 100-200 mm
 5 lime a taglio mezzodolce 200 mm
 1 bussola portainseri \square 1/4 - \square 1/4
 1 bussola portainseri \square 1/4 - \square 3/8
 1 bussola portainseri \square 5/16 - \square 1/2
 13 chiavi a bussola esagonali 1/4" \odot 4-4,5-5-5,5-6-7-8-9-10-11-12-13-14 mm
 9 chiavi a bussola a mano lunghe bocca esagonale \odot 5-6-7-8-9-10-11-12-13 mm
 5 chiavi a bussola maschio esagonale 1/4" \odot 3-4-5-6-7 mm
 4 chiavi a bussola a giravite per viti con intaglio \bullet 0,8x4-1x5,5x1,2x6,5-1,2x8 mm
 4 chiavi a bussola a giravite per viti con impronta a croce Phillips® \oplus PH1-PH2-PH3-PH4
 7 chiavi a bussola a giravite maschio per viti con impronta Torx® \otimes T10-T15-T20-T25-T27-T30-T40
 1 raccordo con attacco quadro \square 1/4 - \blacksquare 3/8
 1 prolunga - 1/4" 50 mm
 1 prolunga - 1/4" 100 mm
 1 prolunga - 1/4" 150 mm
 1 snodo 1/4"
 1 quadro con impugnatura 1/4" 176 mm
 1 quadro scorrevole 1/4" 115 mm
 1 cricchetto reversibile 1/4" \otimes 125 mm
 17 chiavi a bussola esagonali 3/8" \odot 6-7-8-9-10-11-12-13-14-15-16-17-18-19-20-21-22 mm
 1 raccordo con attacco quadro \square 3/8 - \blacksquare 1/4
 1 raccordo quadro maschio 1/2" e femmina 3/8" \square 3/8 - \blacksquare 1/2
 1 prolunga - 3/8" 125 mm
 1 prolunga - 3/8" 250
 1 snodo 3/8"
 1 quadro maschio 3/8" con spina scorrevole 210 mm
 1 cricchetto reversibile 3/8" \otimes 200 mm
 21 chiavi a bussola esagonali 1/2" \odot 8-10-11-12-13-14-15-16-17-18-19-20-21-22-23-24-26-27-28-30-32 mm
 1 raccordo con attacco quadro \square 1/2 - \blacksquare 3/8
 1 snodo 1/2"
 1 prolunga angolare - 1/2" 125 mm
 1 prolunga angolare - 1/2" 250 mm
 1 quadro maschio 1/2" con spina scorrevole 305 mm
 1 cricchetto reversibile 1/2" \otimes 275 mm
 3 chiavi a bussola per candele 3/8" \odot 16 mm (5/8")-17,8 (11/16")-20,8 (13/16")
 5 chiavi maschio con impugnatura per viti con impronta Torx® \otimes T10-T15-T20-T25-T30
 1 tronchesi a grande effetto taglienti diagonali \ddagger 160 mm
 1 pinza universale \equiv 180 mm
 1 pinza a becchi mezzotondi dritti \bullet 160 mm
 1 pinze becchi dritti per anelli elastici, per fori \odot 19÷60 mm
 1 pinze becchi piegati per anelli elastici, per fori \odot 19÷60 mm
 1 pinze becchi dritti per anelli elastici, per alberi \bullet 19÷60 mm
 1 pinze becchi piegati per anelli elastici, per alberi \bullet 19÷60 mm
 1 pinze regolabili cerniera chiusa 250 mm
 1 pinza autobloccante 240 mm
 38 microgiravite con 36 inserti intercambiabili da 4 mm e prolunga magnetica
 6 giravite lama piatta \bullet 04x2,5x50-0,5x3x75-0,8x4x100-1,0x5,5x125-1,2x6,5x150-1,2x8x200 mm
 1 giravite per viti a testa con intaglio \bullet 0,8x4x30 mm
 4 giravite Phillips® \oplus PH0x60-PH1x80PH2x100PH3x150 mm
 1 giravite Phillips® \oplus PH1x30 mm
 12 chiavi maschio con impugnatura per viti con impronta Torx® \otimes T06-T07-T08-T09-T10-T15-T20-T25-T27-T30-T40-T45
 1 giravite cercafase \bullet 0,5x3,5x100 mm

Beta N.	TR
42	MM11
96BPC/SC9	MM11
96T	MM61
1370	MM61
1390	MM61
35	MM61
1719BMA8/S5	MM61
895/1	MM105
895/3	MM105
895/6	MM105
900	MM105
900L	MM105
900ME	MM105
900LP	MM105
900PH	MM105
900TX	MM105
900/16	MM105
900/20	MM105
900/20L	MM105
900/21	MM105
900/25	MM105
900BG/30	MM105
900/42	MM105
900/55	MM105
910A	MM105
910/15	MM105
910/16	MM105
910/21	MM105
910/22	MM105
910/25	MM105
910/42	MM105
910/55	MM105
920A	MM105
920/15	MM105
920/25	MM105
920AN	MM105
920AN	MM105
920/42	MM105
920/55	MM105
956E	MM105
97TTX	MM140
1084BM	MM140
1150BM	MM140
1166BM	MM140
1032	MM140
1034	MM140
1036	MM140
1038	MM140
1048N	MM140
1052	MM140
1256/C36-2	MM140
1201E	MM210
1201EN	MM210
1202E	MM210
1202EN	MM210
1207E/TX	MM210
1253	MM210



MM11



MM61



MM105



MM140



MM210



5954VG

assortimento di 138 utensili - accessori di fissaggio inclusi

► Autoriparazione

N. pezzi/Descrizione	Beta N.
5 cacciaspina Ø 2-3-4-5-6 mm	31
1 bulino Ø 4 mm	32
1 scalpelli piatti 125 mm	34
18 chiavi combinate 6÷22 - 24 mm	42
8 chiavi a forchetta 6x7 - 8x9 - 10x11 - 12x13 - 14x15 16x17 - 18x19 - 20x22 mm	55
3 chiavi poligonali curve 12x13 - 14x15 - 17x19 mm	90
13 chiavi maschio esagonale piegate Ø 2÷10 - 12 mm	96
4 chiavi a bussola Macchina 1/2" Ø 17 - 19 - 21 - 22 mm	720
20 chiavi a bussola esagonali 1/2" Ø 10-11-12-13-14-15-16-17 18-19-20-21-22-23-24-26-27-28-30-32 mm	920A
1 prolunga - 1/2"	920/21
1 prolunga - 1/2"	920/22
1 snodo 1/2"	920/25
1 quadro maschio 1/2" con spina scorrevole	920/42
1 cricchetto reversibile 1/2" Ⓢ	920/55
3 chiavi a bussola con impugnatura, tipo lungo Ø 8 - 10 - 13 mm	943BX
10 chiavi a T con bussola snodata Ø 6 - 7 - 8 - 10 - 11 - 12 - 13 - 14 - 17 - 19 mm	952
3 chiavi a bussola per candele Ø 16 - 17,8 - 20,8 mm	956C
1 leva con estremità a punta e a becco	964
1 pinze becchi dritti per anelli elastici, per fori ○	1032
1 pinze becchi piegati per anelli elastici, per fori ○	1034
1 pinze becchi dritti per anelli elastici, per alberi ●	1036
1 pinze becchi piegati per anelli elastici, per alberi ●	1038
1 pinze regolabili cerniera chiusa 250 mm	1048N
1 pinza autobloccante 240 mm	1052
1 pinza autobloccante becchi lunghi 175 mm	1058
1 tronchesi a taglienti diagonali 160 mm	1082BM
1 forbici per elettricisti lame diritte	1128BMX
1 pinza universale = 180 mm	1150BM
1 pinza a becchi mezzotondi dritti ● 160 mm	1166BM
1 giravite provacircuito ● 6÷24V	1254
1 giravite lama piatta ● 8 x 200 mm	1260
1 giravite nano lama piatta ● 6,5x30 mm	1260N
1 giravite per viti con impronta a croce Phillips® ● 8 x 150 mm	1262
1 giraviti nano Phillips® ● PH2x30 mm	1262N
5 chiave maschio per viti con impronta Torx® ⊕ T8 - T10 - T15 - T20 - T25	1267TX
8 giravite	1263/D8
1 martello tipo tedesco 300 g	1370
1 mazzuola antirimbalzo Ø 35 mm	1392
1 pinza molle freni 210 mm	1470
1 pinza per capicorda non isolati	1603
1 flessometro 5 m	1692
1 spessimetro	1708/20
1 flessibile magnetico 1,8 kg	1712E/2
6 lime ad ago 160 mm	1720/B6
1 oliatore in plastica a pressione 150 cc	1754

5954VG

059541054

Assortimento consigliato in abbinamento con C54S-C55C



5957VG

assortimento di 174 utensili - accessori di fissaggio inclusi

► Autoriparazione

N. pezzi/Descrizione	Beta N.
6 cacciaspina Ø 2 - 3 - 4 - 5 - 6 - 8 mm	31/SP6
6 punzoni, 1 bulino, 3 scalpelli con supporto	38/SP6
17 chiavi combinate 6-7-8-10-11-12-13-14-15-16 17-19-21-22-24-27-30 mm	42
12 chiavi a forchetta 6x7 ÷ 30x32 mm	55/S12X
8 chiavi maschio esagonale con impugnatura 2 ÷ 10 mm	96T/S8
1 chiavi maschio esagonale piegate Ø 2,5 ÷ 12 mm	96N/G7
8 chiavi maschio piegate	97TX/SC8
per viti con impronta Torx® Ⓢ T9 ÷ T40	
chiavi a profilo XZN®, cromate Ø M5 ÷ M12	98XZN/B5
1 chiave regolabile a rullino 250 mm	111E
1 chiavi dinamometriche a scatto Ⓢ 1/2", 40÷200 Nm	666N/20
13 chiavi a bussola esagonali 1/2" con guida Ø 10÷22 mm	920A/SB13
8 chiavi a bussola esagonali 1/2" con guida Ø 23÷32 mm	920A/SB8
4 chiavi a bussola a giravite lama piatta 1/2"	920LP
● 1,2x6,5 - 1,2x8 - 1,6x9 - 2x12 mm	
3 chiavi a bussola a giravite lama Phillips® 1/2" Ⓢ PH2 - 3 - 4	920PH
1 prolunga - 1/2" 125 mm	920/21
1 prolunga - 1/2" 255 mm	920/22
1 snodo 1/2"	920/25
1 quadro maschio 1/2" con spina scorrevole	920/42
1 cricchetto reversibile 1/2" Ⓢ	920/55
2 chiavi a bussola Macchina 1/2" Ⓢ 17 - 19 mm	720
10 chiavi a T con bussola snodata	952
○ 7 - 8 - 10 - 11 - 12 - 13 - 14 - 15 - 17 - 19 mm	
3 chiavi a T con bussola snodata per candele 14 - 16 - 20,8 mm	959
1 leva con estremità a punta e piatta curva	963
1 ○ ■ 1/2" - 17 - 19 - 22 mm	979
2 pinze becchi dritti per anelli elastici, per fori Ø 140 - 180 mm	1032
2 pinze becchi piegati per anelli elastici, per fori Ø 130 - 170 mm	1034
2 pinze becchi dritti per anelli elastici, per alberi ● 140x1,3 - 175 mm	1036
2 pinze becchi piegati per anelli elastici, per alberi ● 135x1,3 - 175 mm	1038
1 pinze regolabili cerniera chiusa 250 mm	1048N
1 pinza autobloccante 240 mm	1052
1 tronchesi a taglienti diagonali ⚡ 160 mm	1082BM
1 tronchesi a grande effetto taglienti diagonali ⚡ 160 mm	1084BM
1 tronchesi doppia leva taglio frontale ⚡ 180 mm	1092V
1 cesoia a lame larghe diritte 250 mm	1112
1 forbici per elettricisti lame diritte	1128BMX
1 pinza universale ■ 180 mm	1150BM
1 pinza a becchi mezzotondi dritti ● 160 mm	1166BM
1 pinza a becchi mezzotondi piegati ● 200 mm	1168BM
2 giravite lama piatta ● 8x200 - 10x200 mm	1260
1 giravite per viti con impronta a croce Phillips® Ⓢ PH3x150 mm	1262
8 giravite	1263/D8
2 martello tipo tedesco 300 - 600 g	1370
1 mazzuola con battenti in materiale plastico Ø 35 mm	1390
11 estrattori a rulli per viti prigioniere M5÷M16 mm	1433/C11
1 chiave regolabile a nastro per filtri olio	1491
1 provatensione	1498
1 flessometro 5 m	1692
1 spessimetro	1708/20
1 flessibile magnetico 1,8 kg	1712E/2
1 raschietto a due taglienti 200 mm	1717A
1 raschietto a tre taglienti 200 mm	1717B
5 lime a taglio mezzodolce 200 mm	1719BMA8/S5
1 seghetto	1725
1 oliatore in metallo a pressione 200 cc	1751
1 cutter con lama a settori	1771
1 calibro a corsoio	1650

MODULI MORBIDI

Assortimenti di utensili in moduli morbidi per cassettiere e carrelli.



RSC23T
RSC24
RSC24A
RSC24AXL
RSC24L/7
RSC24L-CAB
RSC28
C30M
C37
C37A
C39
C39T
C39MD
C39SM
RSC51
C57S
C59
RSC55

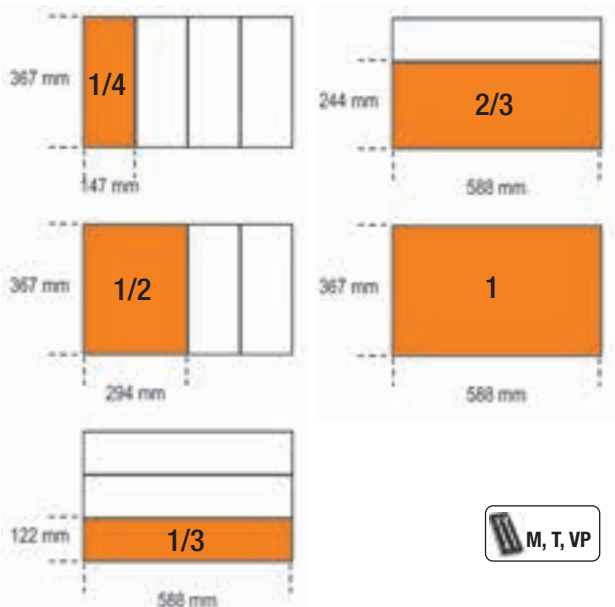

M, T, VP

493÷503
508÷518

M13

11



42SLIM 8-10-11-12
13-14-15-16-17
18-19 mm

1,2 kg



M13 1 024500013
MV13 1 024510013

M25

40



42 6-7-8-9-10-11-12-13-14-15-16-17-18-19-
21-22-24-27 mm
90 6x7-8x9-10x11-12x13-14x15-16x17-
18x19 mm
123Q1/4
123Q3/8
123Q1/2
142 8-9-10-11-12-13-14-15-16-17-18-19 mm

5,1 kg



M25 1 024500025
MV25 1 024510873

M01

22

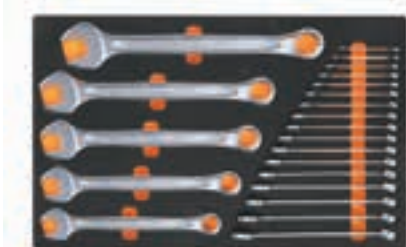

42 6-7-8-9-10-11-12-13-14-15-16-17-18-19-
20-21-22-24-27-30-32-36 mm

4,5 kg



M01 1 024500001
MV10 1 024510010

M02

26



42 6-7-8-9-10-11-12-13-14-15-16-17-18-19-20-21-
22-23-24-25-26-27-28-29-30-32 mm

6,3 kg



M02 1 024500002
MV02 1 024510002

M05

16



42 6-7-8-9-10-11-12
13-14-15-16-17
18-19-20-21 mm

1,5 kg



M05 1 024500005
MV15 1 024510015

M06

5



42 22-24-27-30-32 mm

2,1 kg



M06 1 024500006
MV16 1 024510016

M30

31



55 6x7-8x9-10x11-12x13-14x15-16x17-
18x19-20x22-21x23-24x27-30x32 mm
90 6x7-8x9-10x11-12x13-14x15-16x17-
18x19-20x22-21x23-24x27-30x32 mm
96BPC/SC9 1,5-2-2,5-3-4-5-6-8-10 mm

4,2 kg



M30 1 024500030
MV30 1 024510030



M31

27



42AS 1/4-9/32-5/16-3/8-7/16-1/2-9/16-19/32-5/8-11/16-3/4-13/16-7/8-15/16-1-1.1/16-1.1/8-1.1/4

○ 96BP/AS-SC9 1/16-3/32-1/8-5/32-3/16-7/32-1/4-5/16-3/8

4,5 kg

M31 1 024500031
MV31 1 024510031

M33

17



55 6x7-8x9-10x11-12x13-14x15-16x17-18x19-20x22 mm
○ 96/SC9 1,5+10 mm

1,1 kg

M33 1 024500033
MV33 1 024510033

M38

4



55 21x23-24x26-27x29-30x32 mm

1,7 kg

M38 1 024500038
MV38 1 024510038

M39

36



31 2-3-4-5-6-8 mm
32 4 mm
55 6x7-8x9-10x11-12x13-14x15-16x17-18x19-20x22-21x23-24x26-25x28-27x29-30x32 mm
○ 96/SC12 2-2,5-3-3,5-4-4,5-5-5,5-6-7-8-9-10 mm
○ 96 12-14-17-19 mm

5,7 kg

M39 1 024500039
MV39 1 024510039

M40

7



90 6x7-8x9-10x11-12x13-14x15-16x17-18x19 mm

810 g

M40 1 024500040
MV40 1 024510040

M44

12



141 8-9-10-11-12-13-14-15-16-17-18-19 mm

1,3 kg

M44 1 024500044
MV44 1 024510044

M45

12



142 8-9-10-11-12-13-14-15-16-17-18-19 mm

1,3 kg

M45 1 024500045
MV45 1 024510045

M46

12



142SN 8-9-10-11-12-13-14-15-16-17-18-19 mm

1,4 kg

M46 1 024500046
MV46 1 024510046

M49

24

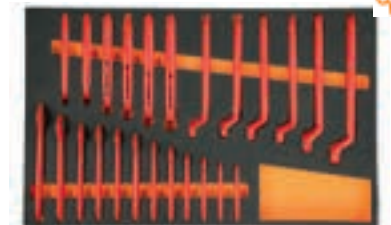

52MQ 7-8-10-11-12-13-14-15-16-17-19-22 mm
89MQ 7-8-10-11-12-13-14-15-16-17-19-22 mm

3,3 kg

M49 1 024500049
MV49 1 024510049

M50

8



○ 96T 2-2,5-3-4-5-6-7-8 mm

1,1 kg

M50 1 024500050
MV50 1 024510051

M52

5



○96T 2,5-3-4-5-6 mm

330 g



M52	1	024500052
MV52	1	024510052

M53

5



○96TBP 2,5-3-4-5-6 mm

350 g



M53	1	024500053
MV52	1	024510052

M55

5



○97TTX T10-T15-T20-T25-T30

330 g



M55	1	024500055
MV55	1	024510055



M60

23



- 96T 2-2,5-3-4-5-6-7-8-10 mm
- 97BTX/SC8 T9-T10-T15-T20-T25-T27-T30-T40
- 944BX 5-6-7-8-10-13 mm

1,9 Kg



M60	1	024500060
MV60	1	024510060

M62

21



- 97TTX T10-T15-T20-T25-T27-T30-T40-T45-T50
- 1032 180 mm
- 1034 170 mm
- 1036 175 mm
- 1038 175 mm
- 1177BM 140 mm
- 1188BM 125 mm
- 1257LP 2-2,5-3-3,5 mm
- 1257PH 0-00

2,3 kg



M62	1	024500875
MV62	1	024510875

M63

8



○952 7-8-10-12-13-14-17-19 mm

3,4 kg



M63	1	024500063
MV63	1	024510063

M65

16

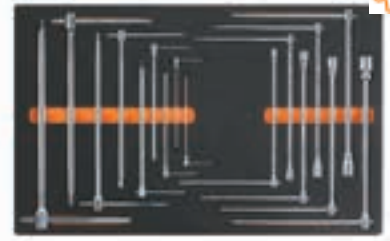

- 950 8-10-12-13-14-17-19 mm
- 951 2,5-3-4-5-6-8-10-12-14 mm

3,6 Kg



M65	1	024500065
MV65	1	024510065

M67

6



○950 7-8-10-12-13-17 mm

1,8 kg



M67	1	024500067
MV67	1	024510067

M69

9



○951 2,5-3-4-5-6-8-10-12-14 mm

1,8 kg



M69	1	024500069
MV69	1	024510069

M75

16



○933 7-8-9-10-11-12-13-14-15-16-17-18-19-21-22-24 mm

5,5 kg



M75	1	024500075
MV75	1	024510075



M78

17



- 80 6x7-8x9-10x11-12x13-14x15-16x17-18x19 mm
- 920/36A
- 965 450 mm
- 1052 240 mm
- 1058 175 mm
- 1481PL/A
- 1481PL/B
- 1481PL/C
- 1650 150 mm
- 1708/20
- 1716P

4,4 kg

M78	1	024500878
MV77	1	024510876

M79

6



- 80 8x9 - 10x11-12x13 -14x15 16x17-18x19 mm

1,3 kg

M79	1	024500079
MV79	1	024510079

M82

29



- 920A 10-11-12-13-14 15-16-17-18-19 20-21-22-23-24 26-27-30-32 mm
- 920ME 5-6-8-10-12 mm
- 920AN/125 125 mm
- 920AN/250 250 mm
- 920/25
- 920/42 305 mm
- ⊕ 920/55

4,1 kg

M82	1	024500082
MV82	1	024510082

M83

24



- 920A 10-11-12-13-14 15-16-17-18-19 20-21-22-23-24 26-27-30-32 mm
- 920AN/125 125 mm
- 920AN/250 250 mm
- 920/25 255 mm
- 920/42 305 mm
- ⊕ 920/55

3,7 kg

M83	1	024500083
MV83	1	024510083

M85

45



- 851SR 230 mm
- 860LP 0,5x3 - 0,6x4,5 - 0,8x5,5 - 1x5,5 - 1,2x6,5 mm
- 860PE 2 - 2,5 - 3 - 4 - 5 - 6 - 8 - 10 mm
- ⊕ 860PH PH0 - PH1 - PH2 - PH3 - PH4
- ⊕ 860PZ PZ1 - PZ2 - PZ3 - PZ4
- ⊕ 860TX T6-T7-T8-T9-T10-T15-T20-T25-T27-T30-T40
- ⊕ 860RTX T9-T10-T15-T20-T25-T27-T30-T40
- 860/55 100 mm
- 882P 80 mm
- 892 ■ 1/4 - □ 1/4

450 g

M85	1	024500085
MV85	1	024510085

M86

46



- 867PE 4-5-6-7-8-10-12 mm
- 867PE/L 4-5-6-7-8-10-12 mm
- 867XZN 5-6-8-10-12 mm
- 867XZN/L 5-6-8-10-12 mm
- ⊕ 867TX T20-T25-T30-T40-T45-T50-T55
- ⊕ 867TX/L T25-T30-T40-T45-T50-T55
- ⊕ 867RTX T20-T25-T30-T40-T45-T50-T55
- 867/1
- 867/2

1,4 kg

M86	1	024500086
MV86	1	024510086

M91

25



- 900 4-4,5-5-5,5-6-7-8-9-10-11-12-13-14 mm
- 900ME 2,5-3-4-5-6-8 mm
- 900/20 50 mm
- 900/21 150 mm
- 900/25 □ 1/4 - ■ 1/4
- 900BG/30
- 900/42
- ⊕ 900/55

560 g

M91	1	024500091
MV90	1	024510090

M92

22



- 910A 6-7-8-9-10-11-12-13-14-15-16-17-18-19-20-21-22 mm
- 910/21 125 mm
- 910/22 250 mm
- 910/25
- 910/42
- ⊕ 910/55

1,5 kg

M92	1	024500092
MV92	1	024510092

M94

26



- 900AS/L 3/16-7/32-1/4-9/32-5/16-11/32-3/8-7/16-1/2-9/16
- 900AS 3/16-7/32-5/32-1/4-9/32-5/16-11/32-3/8-7/16-1/2-9/16
- 900AN 50-100mm
- 900/25
- ⊕ 900/55
- 900/42

930 g

M94	1	024500094
MV94	1	024510094

M96

22



- 920A/AS 3/8-7/16-1/2-9/16-19/32-5/8-11/16-3/4-25/32-13/16-7/8-15/16-1-1.1/16-1.1/18-1.3/16-1.1/4
- 920/25
- 920AN 125-250mm
- 920/42
- ⊕ 920/55

3,8 kg

M96	1	024500096
MV96	1	024510096

M100

98

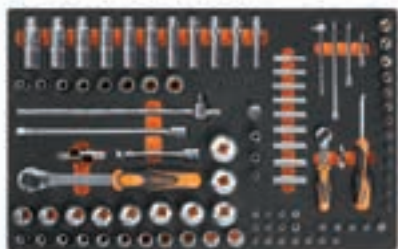

- 895/1
- 895/3
- 895/6
- 900 4-4,5-5-5,5-6-7-8-9-10-11-12-13-14 mm
- 900L 5-6-7-8-9-10-11-12-13 mm
- 900ME 3-4-5-6-7 mm
- 900LP 0,8x4-1x5,5-1,2x6,5-1,2x8 mm
- ⊕ 900PH PH1-PH2-PH3-PH4
- ⊕ 900TX T10-T15-T20-T25-T27-T30-T40
- 900/20 50 mm
- 900/20L 100 mm
- 900/21 150 mm
- 900/25
- 900BG/30
- 900/42
- ⊕ 900/55
- 920A 8-10-11-12-13-14-15-16-17-18-19-20
21-22-23-24-26-27-28-30-32 mm
- 920/15
- 920/25
- 920AN/125 125 mm
- 920AN/250 250 mm
- 920/42
- ⊕ 920/55
- 920FTX 10-12-14-16-18-20-22-24 mm
- 920AL 10-12-13-14-15-16-17-18-19-21-22

6,7 Kg

14" 12"



M100	1	024500100
MV100	1	024510100

M105

116



- 900 4-4,5-5-5,5-6-7-8-9-10-11-12-13-14 mm
- 900L 5-6-7-8-9-10-11-12-13 mm
- 96BPC/SC9 1,5-2-2,5-3-4-5-6-8-10 mm
- 895/1
- 895/3
- 895/6
- 900ME 3-4-5-6-7 mm
- 900LP 0,8x4-1x5,5-1,2x6,5-2x8 mm
- ⊕ 900PH PH1-PH2-PH3-PH4
- ⊕ 900TX T10-T15-T20-T25-T27-T30-T40
- 900/16 □ 1/4 - ■ 3/8
- 900/... 50-100-150 mm
- 900/25
- 900BG/30
- 900/42
- ⊕ 900/55
- 910A 6-7-8-9-10-11-12-13-14-15-16-17-18-19-
20-21-22 mm
- 910/15 □ 3/8 - ■ 1/4
- 910/16 □ 3/8 - ■ 1/2
- 910/21 125 mm
- 910/22 250 mm
- 910/25
- 910/42
- ⊕ 910/55
- 920A 8-10-11-12-13-14-15-16-17-18-19-20-21-
22-23-24-26-27-28-30-32 mm
- 920/15 □ 1/2 - ■ 3/8
- 920/25
- 920AN 125 - 250 mm
- 920/42
- ⊕ 920/55
- 956E 16-17,8-20,8 mm

7,7 kg

14" 38" 12"



M105	1	024500871
MV105	1	024510871

M108

27

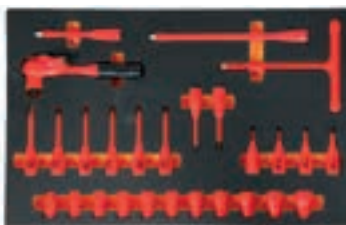

- 910MQ/PE 4-5-6-8 mm
- 910MQ/B 7-8-10-11-12-13-14-15-16-17-19 mm
- ⊕ 910MQ/TX T15-T20-T25-T27-T30-T40
- 910MQ/XZN 8-10 mm
- 910MQ/21 125 mm
- 910MQ/22 250 mm
- 910MQ/T
- 910MQ/55

2,7 kg



M108	1	024500108
MV108	1	024510108

M110

36



- ⊕ 850MQ
- ⊕ 860TX/A10
- 920MQ/A 8-9-10-11-12-13-14-15-16-17-18-19-20
mm
- 920MQ/PE 5-6-8-10-12 mm
- 920MQ/21 125 mm
- 920MQ/22 250 mm
- 920MQ/55A
- 943MQ 6-7-8-10 mm

3,1 kg



M110	1	024500110
MV110	1	024510110

M112

32



- ⊕ 861TX ● 1/4-T6+T15
- ⊕ 866TX ● 5/16-T20+T55
- 895/1 ○ 1/4x□1/4
- 895/6 ○ 5/16x□1/2
- 900FTX □ 1/4-E4+E10
- 920FTX □ 1/2-E12+E24
- 920TX □ 1/2-T55L-T60-T70L

1,3 kg

14" 12"



M112	1	024500112
MV112	1	024510112

M115

54



- ⊕ 666N/20 40-200 Nm
- 920A 13-14-15-16-17-18-19-20-21-22-24-26-
27-30-32 mm
- 920FTX 12-14-16-18-20-22-24 mm
- 920PE 6-7-8-8L-10-10L-12-12L-14-14L
- ⊕ 920TX T20-T25-T27-T30-T40-T45-T50-T55-T60-
T20L-T25L-T27L-T30L-T40L-T45L-T50L
- 920/21 125 mm
- 920/22 255 mm
- 920/25
- 920/42 305 mm
- ⊕ 920/55

7,8 Kg

12"



M115	1	024500115
MV115	1	024510115



M120

75



- 920A 10-11-12-13-14-15-16-17-18-19-20-21-22-24-26-27-30-32 mm
- 920AN/125 125 mm
- 920AN/250 250 mm
- 920/25
- 920/42
- 920AL 10-12-13-14-15-16-17-18-19-22-24-27-30-32 mm
- 920FTX 10-12-14-16-18-20-22-24 mm
- ⊕ 920/55
- 920PE 5-5L-6-6L-7-7L-8-8L-10-10L-12-12L-14-14L
- ⊕ 920TX T20-T25-T27-T30-T40-T45-T50-T55-T60-T20L-T25L-T27L-T30L-T40L-T45L-T50L

6,9 Kg

12"



M120	1	024500120
MV120	1	024510120

M121

46

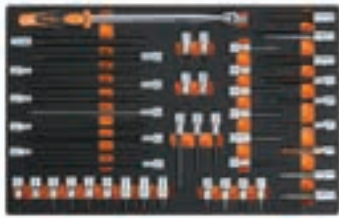

- 920BP 5L-6L-8L-10L-5XL-6XL-8XL mm
- ⊕ 920TX T20-T25-T27-T30-T40L-T45L-T50L-T55L-T60L-T70L
- 920XZN 4-5-6-6L-8-8L-10-10L-12-12L-14-14L-16-18 mm
- ⊕ 920ES 7-9-10-11-12L-14L-16L-7XL-9XL-10XL-11XL-12XL-14XL-16XL mm
- 920/36A

6,3 Kg

12"



M121	1	024500121
MV121	1	024510121

M125

68



- 910AL 8-9-10-11-12-13-14-15-16-17-19-21-22 mm
- 920PE 5-6-6L-7-8-8L-10-10L-12-12L mm
- 920FTX E12-E14-E16-E18-E20-E22-E24
- ⊕ 920TX T20-T25-T27-T30-T30L-T40-T40L-T45-T50-T50L-T55-T60-T60L
- 920XZN 5-6-6L-8-8L-10-10L-12L mm
- 920AL 10-12-13-14-15-16-17-18-19-21-22-23-24-27-30-32 mm
- 1692/5 5 m

7,9 kg

38" 12"



M125	1	024500872
MV125	1	024510872

M126

26



- 928A 19-21-22-24-26-27-28-30-32-34-35-36-38-41-46 mm
- 928ME 14-17-19-22 mm
- 928/15 □ 3/4 - ■ 1/2
- 928/16 □ 3/4 - ■ 1
- 928/21 200 mm
- 928/22 380 mm
- 928/25
- 928/42 450 mm
- ⊕ 928/55

12,4 kg

34"



M126	1	024500126
MV126	1	024510126

M127

23



- 728 19-21-22-24-27-30-32-33-34-35-36-38-40-41-46
- ⊕ 728FTX 20-22-24 mm
- 728/15 □ 3/4 - ■ 1/2
- 728/16 □ 3/4 - ■ 1
- 728/21 175 mm
- 728/22 250 mm
- 728/25

12,5 kg

34"



M127	1	024500127
MV127	1	024510127

M128

50



- 720 10-11-12-13-14-15-16-17-18-19-21-22-24-27-30-32 mm
- 720L 10-11-12-13-14-15-16-17-18-19-21-22-24-27-30-32 mm
- ⊕ 720TX T30-T40-T45-T50-T55
- 720ME 5-6-8-10-12-14-17-19 mm
- 720LC 17-19-21 mm
- 720/21 125 mm
- 720/25

8,9 kg

12"



M128	1	024500128
MV128	1	024510128

M129

13



- 1032 180 mm
- 1034 170 mm
- 1036 175 mm
- 1038 175 mm
- 1048N 250 mm
- 1052 240 mm
- ⊕ 1082BM 160 mm
- 1098 220 mm
- 1112 250 mm
- 1128BM
- ≡ 1150BM 180 mm
- 1166BM 160 mm
- 1168BM 160 mm

3,4 Kg



M129	1	024500129
MV138	1	024510138

M133

3



- ⊕ 1082G 160 mm
- ≡ 1150G 180 mm
- 1166G 160 mm

650 g



M133	1	024500133
MV133	1	024510133

M134

3



- ⊕ 1082GBM 160 mm
- ≡ 1150GBM 180 mm
- 1166GBM 160 mm

750 g



M134	1	024500134
MV134	1	024510134

M135



- 1082MQ 160 mm
- 1150MQ 180 mm
- 1166MQ 160 mm



750 g



M135	1	024500135
MV135	1	024510135

M136



- 1084BM 160 mm
- 1150BM 180 mm
- 1166BM 160 mm



750 g



M136	1	024500136
MV131	1	024510131

M137



- 1084 160 mm
- 1150 180 mm
- 1166 160 mm



650 g



M137	1	024500137
MV132	1	024510132

M145



- 1032 180 mm
- 1034 170 mm
- 1036 175 mm
- 1038 175 mm



640 g



M145	1	024500145
MV145	1	024510145

M153



- 1048N 250 mm
- 1052 240 mm



1 kg



M153	1	024500153
MV154	1	024510154

M161



- 1128MQ
- 1048MQ 250 mm
- 1082MQ 160 mm
- 1150MQ 180 mm
- 1162MQ 160 mm
- 1164MQ 160 mm
- 1272MQ PH0x60 - PH1x80 - PH2x100 - PH3x150 mm
- 1274MQ 2,5x75 - 3x100 - 4x100 - 5,5x125 mm
- 1777MQ/U

3,0 kg



M161	1	024500161
MV161	1	024510161

M162

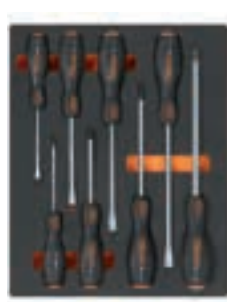

- 1241 5,5x100-6,5x125-8x150-10x200 mm
- 1242 PH1x100-PH2x100 PH3x150-PH4x200 mm



1,4 kg



M162	1	024500162
MV162	1	024510162



M166



860MIX/A31

- 1048N 250 mm
- 1082BM 160 mm
- 1150BM 180 mm
- 1162BM 160 mm
- 1290 3x75-4x100-5,5x100-6,5x150-8x150 mm
- 1290N 6,5x30 mm
- 1292 4,5x80-6x100-8x150 mm
- 1292N 6x30 mm
- 1297TX T20-T25-T27-T30

2,9 kg



M166	1	024500879
MV880	1	024510880

M170



- 1290 2,5x50
- 3x75
- 3,5x100
- 4x125
- 5,5x100
- 5,5x150
- 6,5x150 mm



500 g



M170	1	024500170
MV170	1	024510170

M172



- 1292 PH0x60
- PH0x100
- PH1x80
- PH1x120
- PH2x100
- PH2x150 mm



450 g

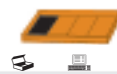

M172	1	024500172
MV172	1	024510172



M174



6

1297TX T8-T10-T15-T20-T25-T30

450 g



M174 1 024500174
MV174 1 024510174

M180



7

1290 3x75
4x100
5,5x150
6,5x150 mm
1292 PH0x60
PH1x80
PH2x100 mm

500 g



M180 1 024500180
MV180 1 024510180

M195

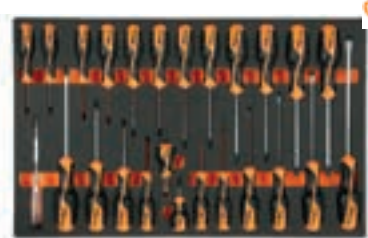

25

1260 2,5x50-3x75-4x100-5,5x125-6,5x150-8x200 mm
1260N 4x30 mm
1262 PH0x60-PH1x80-PH2x100-PH3x150 mm
1262N PH1X30 mm
1267TX T6-T7-T8-T9-T10-T15-T20-T25-T27-T30-T40-T45
1253 3,5x100 mm

2,3 kg



M195 1 024500195
MV195 1 024510195

M201



6

1260 3x75-4x100-6,5x150 mm
1262 PH0x60-PH1x80-PH2x100 mm

500 g



M201 1 024500201
MV201 1 024510201

M204



6

1267TX T8-T10-T15-T20-T25-T30

450 g



M204 1 024500204
MV204 1 024510204

M208



10

1260 3x75
3,5x100
4x125
5,5x150
6,5x150 mm
1262 PH0x60
PH1x80
PH2x100 mm
1260N 4x30 mm
1262N PH1x30 mm

750 g



M208 1 024500208
MV208 1 024510208

M209



10

1260N 4x30 mm
1264 2,5x60 - 3x100
- 4x125 - 5x150 -
6,5x150 mm
1262 PH0x60 - PH1x80 -
PH2x100 mm
1262N PH1x30 mm

820 g



M209 1 024500209
MV208 1 024510208

M213

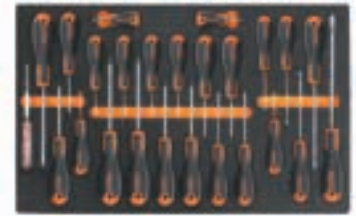

25

1201E 2,5x50-3x75-4x100-5,5x125-6,5x150-8x200 mm
1201EN 4x30 mm
1202E PH0x60-PH1x80-PH2x100-PH3x150 mm
1202EN PH1X30 mm
1207E/TX T6-T7-T8-T9-T10-T15-T20-T25-T27-T30-T40-T45
1253 3,5x100 mm

1,8 Kg



M213 1 024500213
MV210 1 024510210

M214

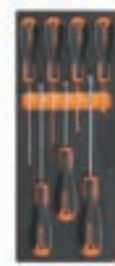

7

1201E 2,5x50-3x75-3,5x100-4x125-5,5x100-5,5x150-6,5x150 mm

500 g



M214 1 024500214
MV211 1 024510211

M216



6

1202E PH0x60-PH1x80-PH1x120-PH2x100-PH2x150-PH3x150 mm

450 g



M216 1 024500216
MV212 1 024510212

M217



7

1207E/TX T6-T7-T8-T9-T10-T15-T20

500 g



M217 1 024500217
MV215 1 024510215



M218



- 1201E 3x75
4x100
5,5x150
6,5x150 mm
- ⊕ 1202E PH0x60
PH1x80
PH2x100 mm

500 g



M218	1	024500218
MV220	1	024510220

M219



- ⊕ 1202E 3x60 - 4,5x80 - 6x100 mm
- 1204E 3x75 - 4x100 - 5x150
6,5x150 mm

590 g



M219	1	024500219
MV220	1	024510220

M222



- ⊕ 1272MQ PH0x60 mm
- ⊕ 1272MQF PH1x80 - PH2x100 mm
- 1274MQF 3,5x100 - 4,5x100 -
5,5x125 - 6,5x150 mm

540 g

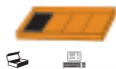

M222	1	024500222
MV222	1	024510222

M226



- 1274MQ 3x100
4x100
5,5x125
6,5x150 mm
- ⊕ 1272MQ PH0x60
PH1x80
PH2x100 mm

500 g



M226	1	024500226
MV226	1	024510226

M227



- 944BX 6-7-8-10-13 mm

420 g



M227	1	024500227
MV227	1	024510227

M230



- 30 Ø 2-3-4 mm
- 31 Ø 2-3-4-5-6-8 mm
- 32 Ø 4 mm
- 34 150 mm
- 35 200-250 mm
- 36 125 mm
- 1370 500 g
- 1390 Ø 35 mm
- 1692 3 m
- 1712TF
- 1719BMA/Q 200 mm
- ▲ 1719BMA/T 200 mm
- 1719BMA/P 200 mm
- ▶ 1719BMA/M 200 mm
- 1719BMA/R 200 mm
- 1737NX
- 1771 18 mm

3,2 Kg



M230	1	024500230
MV230	1	024510230



M231



- 31 2-3-4-5-6-8 mm
- 32 4 mm
- 34 125-150-175 mm
- 36 125 mm
- 1370 500-1000 g
- 1390 Ø 35 mm
- 1712TF 590 mm
- 1715 670 mm
- 1719BMA8/Q 200 mm
- ▲ 1719BMA8/T 200 mm
- 1719BMA8/P 200 mm
- ▶ 1719BMA8/M 200 mm
- 1719BMA8/R 200 mm
- 1737NX

4,7 kg



M231	1	024500877
MV231	1	024510877

M234



- 35 100-200 mm
- 1370 300 g
- 1390 Ø 35 mm

1,3 kg

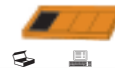

M234	1	024500234
MV232	1	024510232

M236



- 1719BMA/Q 200 mm
- ▲ 1719BMA/T 200 mm
- 1719BMA/P 200 mm
- ▶ 1719BMA/M 200 mm
- 1719BMA/R 200 mm

870 g



M236	1	024500236
MV236	1	024510236

M237

4



35 100-200 mm
1370T 300 mm
1390N Ø 35 mm

1,3 kg



M237 1 024500237
MV232 1 024510232

M240

7



31BM Ø 2-3-4-5-6-8 mm
32 Ø 4 mm

850 g



M240 1 024500240
MV240 1 024510240

M264

16



1491 Ø 65+110 mm
1494 ■ 10 mm
1494E ○ 8-9-10-11-12-14-17 mm
1494Q ○ 8-9,5-12-13 mm
1494T △ 9,5
1494XZN ○ 16
1496C ■ 8x ■ 10 mm

2,1 kg



M264 1 024500264
MV264 1 024510264

M284

9



1128BMX
1130BMX
1719BMA...Q 200 mm
1719BMA...P 200 mm
1719BMA...M 200 mm
1719BMA...R 200 mm
1726BM 400 mm
1728BM (5)
1771BM 170 mm
1778V18 185 mm

2,4 kg



M284 1 024500284
MV284 1 024510284

M285

4



1112 250 mm
1128BM
1726 440 mm
1728BM (5)
1753 200 cc

1,5 kg



M285 1 024500285
MV285 1 024510285

M289

4



1692 5 m
1725CR
1755 30 cc
1771

500 g



M289 1 024500289
MV289 1 024510289

M292

4



111E 250 mm
1128BMX
1692/5 5 m
1771 170 mm

500 g



M292 1 024500292
MV293 1 024510293

M295

4



1650
1682 L=300 mm
1707
1708/20

450 g



M295 1 024500295
MV295 1 024510295

M305

14



1927B
720 12-13-14-15-16-17
18-19-21-22
24-27 mm
720/21

4,2 kg

12V



M305 1 024500305
MV305 1 024510305

M310

14



1927CD
720 12-13-14-15-16-17
18-19-21-22
24-27 mm
720/21

4,0 kg

12V



M310 1 024500310
MV310 1 024510310





M400

29



- 3932U
- 3935 120 mm
- 3937 170 mm
- 3952 13-14-15-16-17-18-19 mm
- 3961 3,2
- 3961 3,3
- 3961 3,5
- 3961U 3,2 - 4,0 mm
- 3969 200 mm (x2)
- 3969K3 113 mm
- 3973/1
- 3973/2
- 3973/3
- 3973/4
- 3984/1 Ø35 mm
- 3984/2 Ø22,8 mm
- 3984/3 Ø23,5 mm
- 3984/4 Ø23 mm
- 3991 222 mm
- 3992 234 mm

3,1 kg



M400	1	024500400
MV400	1	024510400

M401

7

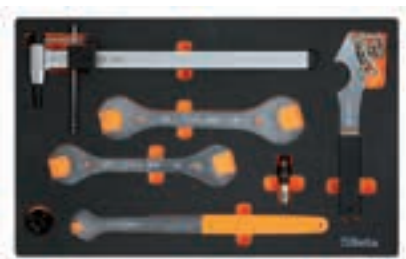

- 3921 440 mm
- 3948
- 3953
- 3955 30x32 - 32x36 mm
- 3967 289 mm
- 3971

2,7 kg



M401	1	024500401
MV401	1	024510401

RSC22 RSC23 RSC23C C27S		503 518
C41S C41H		503

MC10

34



- 42 6-7-8-9-10-11-12
13-14-15-16-17
18-19-21-22 mm
- 96/SC9 1,5-2-2,5-3-4-5-6-8-10 mm
- ⚡ 1084BM 160 mm
- ≡ 1150G 180 mm
- 1166G 160 mm
- 1201E 3,5x100-5,5x150-6,5x150 mm
- ⊕ 1202E PH0x60-PH1x80-PH2x100 mm

3,5 kg



MC10	1	027500011
MCV10	1	027510010

MC12

26



- 42 6-7-8-9-10-11-12-13-14-15-16-17-18-19-21-22 mm
- 96/SC9 1,5-2-2,5-3-4-5-6-8-10 mm
- 1692/5 5 m

2,2 kg



MC12	1	041500012
MCV11	1	041510011



MC20

74



- 860MIX/A31
- 895/1
- 1048N 250 mm
- 1370 300 g
- 32 Ø 4 mm
- 36 Ø 4 mm
- 900 4-4,5-5-5,5-6-7-8-9-10-11-12-13-14 mm
- 900/21 150 mm
- 900/25
- 900BG/30C
- 900/42
- 900/55
- 920A 10-11-12-13-14-15-16-17-18-19-21-22-24-27-30-32 mm
- 920/25
- 920AN/125 125 mm
- 920/42
- 920/55

6 kg

12"



MC20	1	027500020
MCV20	1	027510021

MC21

24



- 920A 10-11-12-13-14-15-16-17-18-19-20-21-22-23-24-26-27-30-32 mm
- 920/25
- 920/42
- ⊕ 920/55
- 920AN 125-250 mm

4,3 kg



MC21	1	041500021
MCV21	1	041510021



C35

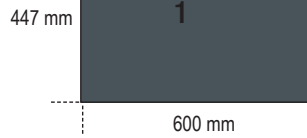

504÷506



MB12



42 6-7-8-9-10-11-12-13-14-15-16-17-18-19-20-21-22-24-27-30-32 mm
 55 6x7-8x9-10x11
 12x13-14x15
 16x17-18x19
 20x22 mm
 1048N 250 mm

5,4 kg



MB12 1 024504212
 MBV13 1 024524213

MB38



- 96T 2-2,5-3-4-5-6-7-8 mm
- 851SR 230 mm
- 860LP 0,5x3 - 0,6x4,5 - 0,8x5,5 - 1x5,5 - 1,2x6,5 mm
- 860PE 2 - 2,5 - 3 - 4 - 5 - 6 - 8 - 10 mm
- ⊕ 860PH PH0 - PH1 - PH2 - PH3 - PH4
- ⊕ 860PZ PZ1 - PZ2 - PZ3 - PZ4
- ⊕ 860RTX T9-T10-T15-T20-T25-T27-T30-T40
- ⊕ 860TX T6-T7-T8-T9-T10-T15-T20-T25-T27-T30-T40
- 860/55 100 mm
- 882P
- 892/0
- 920A 10-11-12-13-14-15-16-17-18-19-20-21-22-23-24-26-27-30-32 mm
- 920/21 125 mm
- 920/22 255 mm
- 920/25
- 920/42
- ⊕ 920/55
- ⊕ 1084BM 160 mm
- ≡ 1150BM 180 mm
- 1166BM 160 mm

5,9 kg



MB38 1 024504238
 MBV35 1 024524235

MB39



- 920A 10-11-12-13-14-15-16-17-18-19-20-21-22-23-24-26-27-30-32 mm
- 920/21 125 mm
- 920/22 255 mm
- 920/25
- 920/42
- ⊕ 920/55
- 920PE 5-6-8-10-12 mm
- 1032 180 mm
- 1034 170 mm
- 1036 175 mm
- 1038 175 mm
- 35 200 mm
- ⊕ 1084BM 160 mm
- ≡ 1150BM 180 mm
- 1166BM 160 mm
- 1370 500 g
- 1390 35 mm

7,2 kg



MB39 1 024504239
 MBV36 1 024524236

MB44



- 1260 2,5x50-3x75-3,5x100-4x100-5,5x125-6,5x150-8x200 mm
- 1260N 4x30-6,5x30 mm
- ⊕ 1262 PH0x60-PH0x100-PH1x80-PH1x120-PH2x100-PH2x150-PH3x150 mm
- ⊕ 1262N PH1x30-PH2x30 mm
- 1253
- 96BPC/SC9
- 951 2,5-3-4-5-6-8 mm

2,8 kg



MB44 1 024504244
 MBV44 1 024524244



MB37



- 920A 10-11-12-13-14-15-16-17-18-19-20-21-22-23-24-26-27-30-32 mm
- 920/21 125 mm
- 920/22 150 mm
- 920/25
- 920/42
- ⊕ 920/55
- 111E 250 mm
- 1052 240 mm
- ⊕ 1084BM 160 mm
- ≡ 1150BM 180 mm
- 1166BM 160 mm
- 1032 180 mm
- 1034 170 mm
- 1036 175 mm
- 1038 175 mm
- 900 4,4-5-5,5-6-7-8-9-10-11-12-13-14 mm
- 900/20 50 mm
- 900/21 150 mm
- 900/25
- 900BG/30
- ⊕ 900/55
- 900/42
- 7,0 kg



MB37 1 024504237
 MBV40 1 024524240

MB45

29



- 1260 2,5x50-3x75-3,5x100-4x100-5,5x100-5x125-6,5x150 mm
- ⊕ 1262 PH0x60-PH0x100-PH1x80-PH1x120-PH2x100-PH2x150 mm
- ⊖ 1267TX T8-T10-T15-T20-T25-T30
- 1052 240 mm
- 96BPC/SC9

2,8 kg

MB45	1	024504245
MBV45	1	024524245

MB46

29



- 1260 3x75-4x100-5,5x125-6,5x150 mm
- ⊕ 1262 PH0x60-PH1x80-PH2x100 mm
- ⊖ 1267TX T8-T10-T15-T20-T25-T30
- 96BPC/SC9
- 96T 2-2,5-3-4-5-6
- 1052 240 mm

2,8 kg

MB46	1	024504246
MBV46	1	024524246

MB47

48



- 1260 3x75-4x100-5,5x125-6,5x150 mm
- ⊕ 1262 PH0x60-PH1x80-PH2x100 mm
- 1260N 4x30 mm
- ⊕ 1262N PH1x30 mm
- 96T 2,5-3-4-5-6-8 mm
- 96BPC/SC9
- 920A 10-11-12-13-14-15-16-17-18-19-20-21-22-23-24-26-27-30-32 mm
- 920/21 125 mm
- 920/22 250 mm
- 920/25
- 920/42
- ⊖ 920/55

5,6 kg

12"

MB47	1	024504247
MBV47	1	024524247

MB56

15



- 1719BMA/Q 200 mm
- ▲ 1719BMA/T 200 mm
- 1719BMA/P 200 mm
- ▶ 1719BMA/M 200 mm
- 1719BMA/R 200 mm
- 1032 180 mm
- 1034 170 mm
- 1036 175 mm
- 1038 175 mm
- 1370T 300 g
- 1390N Ø 35 mm
- 35 200 mm
- 1692 5 mt
- 1725CR 260 mm
- 1771 18 mm

3,7 kg

MB56	1	024504256
MBV56	1	024524256

MB58

17



- 31 Ø 2-3-4-5-6 mm
- 32 Ø 4 mm
- 35 200 mm
- 1112 250 mm
- 1128BMX
- 1370 500 g
- 1390 Ø 45 mm
- 1719BMA...Q 200 mm
- ▲ 1719BMA...T 200 mm
- 1719BMA...P 200 mm
- ▶ 1719BMA...M 200 mm
- 1719BMA...R 200 mm
- 1726 440 mm

4,5 kg

MB58	1	024504258
MBV55	1	024524255



MB59

15



- 1719BMA...Q 200 mm
- ▲ 1719BMA...T 200 mm
- 1719BMA...P 200 mm
- ▶ 1719BMA...M 200 mm
- 1719BMA...R 200 mm
- 31 Ø 4-6 mm
- 32 Ø 4 mm
- 35 125-200 mm
- 1370 300 g
- 1390 Ø 35 mm
- 1692 5 mt
- 1725 420 mm
- 1833XS/2

3,4 kg

MB59	1	024504259
MBV57	1	024524257

MB65

16



- 1719BMA...Q 200 mm
- 1719BMA...P 200 mm
- 1719BMA...T 200 mm
- 1719BMA...M 200 mm
- 1719BMA...R 200 mm
- 35 200 mm
- 1032 180 mm
- 1034 170 mm
- 1036 175 mm
- 1038 175 mm
- 1052 240 mm
- 1084BM 160 mm
- 1150BM 180 mm
- 1166BM 160 mm
- 1370 500 g
- 1390 Ø 35 mm

4,8 kg

MB65	1	024504265
MBV61	1	024524261



MB63

60



- 96BPC/SC9
- 1250 4x125 mm
- ⊕ 1251 PH1x125 mm
- 1253
- 943MQ 5,5-6-7-8-10-13 mm
- ⊕ 1272MQ PH0x60-PH1x80-PH2x100-PH3x150 mm
- 1274MQ 2,5x75-3x100-4x100-5,5x125-6,5x150-8x175 mm
- 860LP 0,5x3 - 0,6x4 - 0,8x5,5
1,0x5,5 - 1,2x6,5 mm
- 860PE 2 - 2,5 - 3 - 4 - 5 - 6
8 - 10 mm
- ⊕ 860PH PH0 - PH1 - PH2 - PH3 - PH4
- ⊕ 860PZ PZ1 - PZ2 - PZ3 - PZ4
- ⊕ 860RTX T9 - T10 - T15 - T20
T25 - T27 - T30 - T40
- 882MSR 50 ○ 1/4 ● 1/4
- 850MQ

3,2 kg

MB63 1 024504263
MBV63 1 024524263

MB64

20



- 55 6x7-8x9-10x11
12x13-14x15
16x17-18x19
20x22 mm
- 1048MQ 250 mm
- 1082MQ 140 mm
- 1128BSX
- 1132MQ 230 mm
- 1142MQ 160 mm
- 1150MQ 180 mm
- 1166MQ 160 mm
- 1168MQ 160 mm
- 110MQ 250 mm
- 1777MQ
- 993MQ
- 1602

4,1 kg

MB64 1 024504264
MBV62 1 024524262



C45PRO

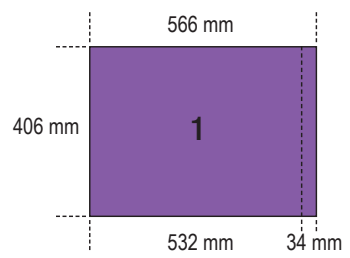

506

MM11

30



- 42 6-7-8-9-10-11-12-13-14-15-16-17-18-19-20-21-22-24-27-30-32 mm
- 96BPC/SC9 1,5-2-2,5-3-4-5-6-8-10 mm

4,5 kg

MM11 1 024580011
MMV10 1 024590010

MM61

17



- 96T 2-2,5-3-4-5-6-7-8 mm
- 1390 Ø 35
- 1370 300 g
- 35 100-200 mm
- 1719BMA8/S5 200 mm

2,9 kg

MM61 1 024580061
MMV61 1 024590061

MM63

8



- 952 7-8-10-12-13-14-17-19 mm

3,4 kg

MM63 1 024580063
MMV63 1 024590063

MM105

107



- 895/1 ○ 1/4 □ 1/4
- 895/3 ○ 1/4 □ 3/8
- 895/6 ○ 5/16 □ 1/2
- 900 4-4,5-5-5,5-6-7-8-9-10-11-12-13-14 mm
- 900L 5-6-7-8-9-10-11-12-13 mm
- 900ME 3-4-5-6-7 mm
- 900LP 0,8x4-1x5,5-1,2x6,5-1,2x8
- ⊕ 900PH PH1-PH2-PH3-PH4
- ⊕ 900TX T10-T15-T20-T25-T27-T30-T40
- 900/16
- 900/... 50-100-150 mm
- 900/25
- 900BG/30 176 mm
- 900/42 115 mm
- 900/55 125 mm
- 910A 6-7-8-9-10-11-12-13-14-15-16-17-18-19-20-21-22 mm
- 910/15 □ 3/8 ■ 1/4
- 910/16 □ 3/8 ■ 1/2
- 910/21 125 mm
- 910/22 250 mm
- 910/25
- 910/42 210 mm
- 910/55 200 mm
- 920A 8-10-11-12-13-14-15-16-17-18-19-20-21-22-23-24-26-27-28-30-32 mm
- 920/15 □ 1/2 ■ 3/8
- 920/25
- 920AN 125-250 mm
- 920/42 305 mm
- 920/55 275 mm
- 956E 16 mm (5/8")-17,8 (11/16")-20,8 (13/16")

7,2 kg

MM105 1 024580105
MMV105 1 024590105



MM140

52



97TTX	T10-T15-T20-T25-T30
1084BM	160 mm
1150BM	180 mm
1166BM	160 mm
1032	180 mm
1034	170 mm
1036	175 mm
1038	175 mm
1048N	250 mm
1052	240 mm
1256/C36-2	

2,2 kg

MM140	1 024580141
MMV142	1 024590142

MM210

25



1201E	2,5x50-3x75-4x100-5,5x125-6,5x150-8x200 mm
1201EN	4x30 mm
1202E	PH0x60-PH1x80-PH2x100-PH3x150 mm
1202EN	PH1X30 mm
1207E/TX	T6-T7-T8-T9-T10-T15-T20-T25-T27-T30-T40-T45
1253	

2,1 kg

MM210	1 024580211
MMV210	1 024590210



MM400

29



3932U	120 mm
3935	170 mm
3937	170 mm
3952	13-14-15-16-17-18-19 mm
3961 3,2	
3961 3,3	
3961 3,5	
3961U	3,2 - 4,0 mm
3969	200 mm (x2)
3969K3	113 mm
3973/1	
3973/2	
3973/3	
3973/4	
3984/1	
3984/2	
3984/3	
3984/4	
3991	222 mm
3992	234 mm

3,1 kg

MM400	1 024580400
MMV400	1 024590400

MM401

7



3921	440 mm
3948	
3953	
3955	30x32 mm - 32x36 mm
3967	289 mm
3971	

2,7 kg

MM401	1 024580401
MMV401	1 024590401

VPM0

termoformato morbido
con vaschetta portaminuterie



VPM0

1 088870350

VPM3

termoformato morbido
con 4 vaschette portaminuterie



VPM3

1 088870353

VPM7

termoformato morbido con 3 vaschette
portaminuterie

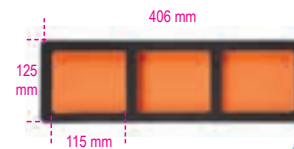

VPM7

1 088870356

VPM8

termoformato morbido con vaschetta
portaminuterie



VPM8

1 088870357

VPM9

termoformato morbido con vaschetta
portaminuterie



VPM9

1 088870358

VPM7-C

termoformato morbido con vaschetta
portaminuterie

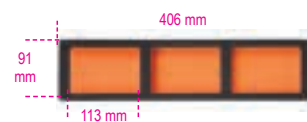

VPM7-C

1 088870360



Termoformati rigidi serie T



Assortimenti di utensili in termoformato per tutti i modelli di cassettiere e per i carrelli.

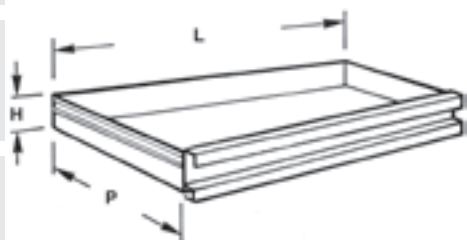

H	LxP
mm	mm
70	588x367



T01



42 6-7-8-10-11-12-13
14-16-17-18-19-21
22-24-27-30 mm



2,7 kg



T01	1 024240001
TV10	1 024000400

T05



42 6-7-8-9-10-11-12
13-14-15-16-17
18-19-20-21 mm



1,5 kg



T05	1 024240005
TV15	1 024000445

T06



42 22-24-27-30-32 mm



2,1 kg



T06	1 024240006
TV16	1 024000446

T13



42SLIM 8-10-11-12
13-14-15-16-17
18-19 mm



1,5 kg



T13	1 024240013
TV13	1 024249913

T18



42MP 6-7-8-9-10-11-12
13-14-15-16-17
18-19-20-21 mm



1,5 kg



T18	1 024240018
TV15	1 024000445

T19



42MP 22-24-27-30-32 mm



2,1 kg



T19	1 024240019
TV16	1 024000446

T22



42AS 5/16-3/8-7/16-1/2
9/16-5/8-11/16-3/4
3/32-1/8-5/32-3/16
1/4-5/16-3/8



1 kg



T22	1 024240022
TV20	1 024000488

T23



42INOX 8-10-11-12-13-14-15-
17-19 mm
96BPINOX 2,5-3-4-5-6-8-10 mm



1 kg



T23	1 024240023
TV23	1 024249906

T31



31 Ø 2-3-4-5-6 mm
 32 Ø 4 mm
 55 6x7-8x9-10x11
 12x13-14x15
 16x17-18x19
 20x22-21x23
 24x26-27x29
 30x32 mm
 ○96N/SC9 1,5+10 mm

3 kg



T31 1 024240031
 TV30 1 024000401

T33



55 6x7-8x9-10x11
 12x13-14x15
 16x17-18x19
 20x22 mm
 ○96/SC9 1,5+10 mm

1 kg



T33 1 024240033
 TV20 1 024000488

T34



55MP 6x7-8x9-10x11
 12x13-14x15
 16x17-18x19
 20x22 mm
 ○96/SC9 1,5+10 mm

1 kg



T34 1 024240034
 TV20 1 024000488

T40



90 6x7-8x9-10x11
 12x13-14x15
 16x17-18x19 mm

810 g



T40 1 024240040
 TV40 1 024000456

T41



90 20x22-21x23
 24x26-25x28
 27x29 mm

1,5 kg



T41 1 024240041
 TV41 1 024000457

T45



142 8-9-10-11-12
 13-14-15-16
 17-18-19 mm

1,3 kg



T45 1 024240045
 TV45 1 024000498

T46



142SN 8-9-10-11-12
 13-14-15-16
 17-18-19 mm

1,5 kg



T46 1 024240046
 TV46 1 024000499

T48



○96BPC/SC9 1,5+10 mm
 142C 8-9-10-11-12
 13-14-15-16
 17-18-19 mm

1,4 kg



T48 1 024240048
 TV47 1 024000763

T50



○96T 2-2,5-3-3,5-4-4,5
 5-6-7-8-10 mm

1,3 kg



T50 1 024240050
 TV50 1 024000764

T52



○96T 2-2,5-3-4-5-6 mm

350 g



T52 1 024240052
 TV52 1 024000765

T53



○96TBP 2,5-3-4-5-6 mm

300 g



T53 1 024240053
 TV52 1 024000765

T55



○97TTX T10-T15-T20
 T25-T27-T30

330 g



T55 1 024240055
 TV55 1 024000766

T57



○ 96TINOX 2,5-3-4-5-6 mm



350 g

T57	1	024240057
TV57	1	024249907

T59



- 111E 250 mm
- 920/40 1/2
- 951 2,5-3-4-5-6-8 mm
- 953 4-5-6-8 mm
- 1370 300 - 500 g

4,7 kg

T59	1	024240059
TV60	1	024000420

T63



○ 952 7-8-10-12-13-14-17-19 mm

3,8 kg

T63	1	024240063
TV63	1	024000471

T64



○ 952FTX E10-E12-E14
○ 953TX T25-T27-T30-T40-T45

3,8 kg

T64	1	024240064
TV63	1	024000471

T65



○ 953 3-3,5-4-5-6-7-8-10 mm

2,8 kg

T65	1	024240065
TV63	1	024000471

T68



○ 951 2,5-3-4-5-6-8 mm

590 g

T68	1	024240068
TV68	1	024000470

T73



○ 930 6x7-8x9-10x11-12x13-14x15-16x17-18x19-20x22 mm
940/1
940/2

1,3 kg

T73	1	024240073
TV73	1	024000418

T75



○ 933 7-8-9-10-11-12-13-14-15-16-17-18-19-21-22-24 mm

4,2 kg

T75	1	024240075
TV75	1	024000422

T76



○ 932 7-8-9-10-11-12-13-14-15-16-17-18-19-21-22-24 mm

4,2 kg

T76	1	024240076
TV75	1	024000422

T77



○ 933 6-7-8-10-11-12-13-14-17-19 mm

1,4 kg

T77	1	024240077
TV77	1	024000474

T79



80 8x9-10x11-12x13-14x15-16x17-18x19 mm

1,3 kg

T79	1	024240079
TV79	1	024000490

T80

29



- 920A 10-11-12-13-14
15-16-17-18-19
20-21-22-23-24
26-27-30-32 mm
- 920ME 5-6-8-10-12 mm
- 920/21 125 mm
- 920/22 255 mm
- 920/25 305 mm
- 920/42 305 mm
- 920/55

4,1 kg

12"

T80	1	024240080
TV80	1	024000403

T81

29



- 920B 10-11-12-13-14
15-16-17-18-19
20-21-22-23-24
26-27-30-32 mm
- 920ME 5-6-8-10-12 mm
- 920/21 125 mm
- 920/22 255 mm
- 920/25 305 mm
- 920/42 305 mm
- 920/55

4,1 kg

12"

T81	1	024240081
TV80	1	024000403

T82

29



- 920A 10-11-12-13-14
15-16-17-18-19
20-21-22-23-24
26-27-30-32 mm
- 920ME 5-6-8-10-12 mm
- 920AN/125 125 mm
- 920AN/250 250 mm
- 920/25 305 mm
- 920/42 305 mm
- 920/55

4,1 kg

12"

T82	1	024240082
TV80	1	024000403

T83

24



- 920A 10-11-12-13-14
15-16-17-18-19
20-21-22-23-24
26-27-30-32 mm
- 920/21 125 mm
- 920/22 255 mm
- 920/25 305 mm
- 920/42 305 mm
- 920/55

3,6 kg

12"

T83	1	024240083
TV83	1	024000402

T85

81



- 861LP 0,5x3 - 0,6x4,5 - 0,8x5,5 - 1x5,5 - 1,2x6,5 - 1,2x8 - 1,6x8 mm
- 861PE 2 - 2,5 - 3 - 4 - 5 - 6 - 8 - 10 mm
- ⊕ 861PH PH0 - PH1 - PH2 - PH3
- ⊕ 861PZ PZ1 - PZ2 - PZ3
- ⊕ 861TX T6-T7-T8-T9-T10-T15-T20-T25-T27-T30-T40
- ⊕ 861RTX T9-T10-T15-T20-T25-T27-T30-T40
- ⊕ 861TRW 1-2-3-4-5-6 mm
- ⊕ 861TQS 0-1-2-3-4-5-6-8-10 mm
- ⊕ 861SP 4-6-8-10-12 mm
- 851SR 230 mm
- 900 4-4,5-5-5,5-6-7-8-9
10-11-12-13-14 mm
- 900/21 150 mm
- 900/25 41 mm
- 900BG/30 176 mm
- 900/42 115 mm
- 900/55 125 mm
- 194 1/4x5/16

1,0 kg

1/4"

T85	1	024240085
TV85	1	024000747

T91

25



- 900 4-4,5-5-5,5-6
7-8-9-10-11
12-13-14 mm
- 900ME 2,5-3-4-5-6-8 mm
- 900/20 50 mm
- 900/21 150 mm
- 900/25 115 mm
- 900BG/30 115 mm
- 900/42 115 mm
- 900/55

560 g

1/4"

T91	1	024240091
TV90	1	024000447

T92

22



- 910A 6-7-8-9-10-11-12-13
14-15-16-17-18-19
20-21-22 mm
- 910/21 125 mm
- 910/22 250 mm
- 910/25 210 mm
- 910/42 210 mm
- 910/55

1,5 kg

3/8"

T92	1	024240092
TV92	1	024000458

T99

16



- 920INOX-A 10-12-13-14-15-16-17
18-19-21-22-24-27
30-32 mm
- 920/55INOX



2,7 kg

12"

T99	1	024240099
TV99	1	024249908

T100

16



- 920A 10-12-13-14-15
16-17-18-19-21
22-24 mm
- 920/21 125 mm
- 920/25 305 mm
- 920/42 305 mm
- 920/55

2,1 kg

12"

T100	1	024240100
TV100	1	024000495

T101

16



- 920B 10-12-13-14-15
16-17-18-19-21
22-24 mm
- 920/21 125 mm
- 920/25 305 mm
- 920/42 305 mm
- 920/55

2,1 kg

12"

T101	1	024240101
TV100	1	024000495

T102

16



- 920AS 3/8-7/16-1/2
9/16-5/8-11/16
3/4-13/16-7/8
15/16-1-1.1/16
- 920/21 125 mm
- 920/25 305 mm
- 920/42 305 mm
- 920/55

2,1 kg

12"

T102	1	024240102
TV100	1	024000495

T103

17



- 900L 6-7-8-9-10-11-12 mm
- 920AL 13-14-16-17-18-19-21-22-24-27 mm

1,1 kg

14" 12"



T103 1 024240103
TV103 1 024000748

T105

11



- 928A 22-24-27-30-32-34-36-38-41-46-50 mm

4,9 kg

34"



T105 1 024240105
TV105 1 024000484

T106

4



- 928/21 200 mm
- 928/22 380 mm
- 928/42 450 mm
- 928/55

4,5 kg

34"



T106 1 024240106
TV106 1 024000485

T111

16



- 720 10-13-15-17-18-19-21-22-24-27-30-32 mm
- 720LC 17-19-21 mm
- 720/21 125 mm

2,7 kg

12"



T111 1 024240111
TV111 1 024000476

T112

32



- 861TX ● 1/4-T6+T15
- 866TX ● 5/16-T20+T55
- 895/1 ○ 1/4x□1/4
- 895/6 ○ 5/16x□1/2
- 900FTX □ 1/4-E4+E10
- 920FTX □ 1/2-E12+E24
- 920TX □ 1/2-T55L-T60-T70L

1,3 kg

14" 12"



T112 1 024240112
TV112 1 024000480

T113

12



- 920PE 5L-6L-7L-8L-10L
- 920TX T40L-T45L T55L-T70L
- 920XZN M6L-M8L-M12L

1,5 kg

12"



T113 1 024240113
TV113 1 024000489

T121

1



- 666N/20 40 - 200 Nm

1,4 kg

12"



T121 1 024240121
TV121 1 024000767

T123

3



- 1082G 160 mm
- 1150G 180 mm
- 1166G 160 mm

550 g



T123 1 024240123
TV135 1 024000762

T124

3



- 1082GBM 160 mm
- 1150GBM 180 mm
- 1166GBM 160 mm

640 g



T124 1 024240124
TV135 1 024000762

T135

3



- 1082MQ 160 mm
- 1150MQ 180 mm
- 1166MQ 160 mm

△ 1000 V

750 g



T135 1 024240135
TV135 1 024000762

T136

2



- 1048MQ 250 mm
- 1777MQ/U

△ 1000 V

700 g



T136 1 024240136
TV136 1 024000438

T137

3



- 1084BM 160 mm
- 1150BM 180 mm
- 1166BM 160 mm

750 g



T137 1 024240137
TV130 1 024000451

T138



- ◄ 1084 160 mm
- ▬ 1150 180 mm
- 1166 160 mm

650 g

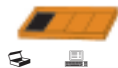

T138	1	024240138
TV130	1	024000451

T140



- 1032 140x0,9 - 180 mm
- 1034 170 mm
- 1036 140x1,3 - 175 mm
- 1038 175 mm
- ◄ 1084 160 mm
- 1128BM

1,1 kg



T140	1	024240140
TV140	1	024000405

T144



- 1048N 250 mm
- 1052 240 mm
- 1112 250 mm
- ▬ 1150 180 mm

1,8 kg



T144	1	024240144
TV143	1	024000409

T145



- 1032 180 mm
- 1034 170 mm
- 1036 175 mm
- 1038 175 mm

640 g



T145	1	024240145
TV145	1	024000448

T146



- 1032 140x0,9 mm
- 1032 225 mm
- 1036 140x1,3 mm
- 1036 225 mm

700 g

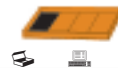

T146	1	024240146
TV146	1	024000449

T151



- 1047 240 mm
- 1057A 240 mm

1,3 kg

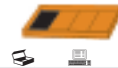

T151	1	024240151
TV150	1	024000462

T153



- 1048N 250 mm
- 1052 240 mm

1,1 kg



T153	1	024240153
TV150	1	024000462

T156



- ◄ 1082 160 mm
- ▬ 1150 180 mm
- 1048N 250 mm

1 kg



T156	1	024240156
TV148	1	024000500

T157



- ◄ 1082BM 160 mm
- ▬ 1150BM 180 mm
- 1048BM 250 mm

1,1 kg

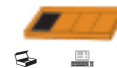

T157	1	024240157
TV148	1	024000500

T160



- 1290 3x75
- 3x100
- 4x100
- 4x150
- 5,5x100
- 5,5x150
- 6,5x150
- 8x150
- 10x200 mm
- 1290N 4x30
- 6,5x30 mm

1,3 kg



T160	1	024240160
TV160	1	024000706

T161



- ⊕ 1292 PH0x60
- PH0x100
- PH1x80
- PH1x120
- PH2x100
- PH2x150
- PH3x150 mm
- ⊕ 1292N PH1x30
- PH2x30 mm

1 kg



T161	1	024240161
TV161	1	024000707

T164



- 952 8-10-13-17-19 mm
- 959 16 mm (5/8") - 20,8 mm (13/16")
- 1260 3x75-4x100-5,5x100-6,5x150-10x200 mm
- ⊕ 1262 PH0x60-PH1x80-PH2x100-PH3x150 mm

5 kg



T164	1	024240164
TV61	1	024000721

T167

11



- 1260 3x75
3x100
4x100
4x150
5,5x100
5,5x150
6,5x150
8x150
10x200 mm
- 1260N 4x30
6,5x30 mm

1,3 kg



T167 1 024240167
TV160 1 024000706

T172

6



Betamax

- 1292 PH0x60
PH0x100
PH1x80
PH1x120
PH2x100
PH2x150 mm

450 g



T172 1 024240172
TV172 1 024000743

T177

8



Betamax

- 1298RTX T9-T10-T15
T20-T25-T27
T30-T40

680 g



T177 1 024240177
TV177 1 024000759

T168

9



- 1262 PH0x60
PH0x100
PH1x80
PH1x120
PH2x100
PH2x150
PH3x150 mm
- 1262N PH1x30
PH2x30 mm

1 kg



T168 1 024240168
TV161 1 024000707

T173

4



Betamax

- 1292 PH3x150
PH4x200 mm
- 1292N PH1x30
PH2x30 mm

560 g



T173 1 024240173
TV173 1 024000744

T180

7



Betamax

- 1290 3x75
4x100
5,5x150
6,5x150 mm
- 1292 PH0x60
PH1x80
PH2x100 mm

480 g



T180 1 024240180
TV180 1 024000701

T170

7



Betamax

- 1290 2,5x50
3x75
3,5x100
4x125
5,5x100
5,5x150
6,5x150 mm

450 g



T170 1 024240170
TV170 1 024000741

T175

7



Betamax

- 1297TX T6-T7-T8-T9
T10-T15-T20

410 g



T175 1 024240175
TV175 1 024000760

T183

5



Betamax

- 1292L PH1x400-PH2x400 mm
- 1294L 3x300-4x400-5x400 mm

580 g



T183 1 024240183
TV183 1 024000497

T171

5



Betamax

- 1290 8x150
8x200
10x200 mm
- 1290N 4x30
6,5x30 mm

750 g



T171 1 024240171
TV171 1 024000742

T176

5



Betamax

- 1297TX T25-T27-T30
T40-T45

640 g



T176 1 024240176
TV176 1 024000761

T198

7



- 1260 3x75
4x100
5,5x150
6,5x150 mm
- 1269PZ PZ0 - PZ1 - PZ2

490 g



T198 1 024240198
TV180 1 024000701

T199



● 1260
2,5x50
3x75
3,5x100
4x125
5,5x100
5,5x150
6,5x150 mm

490 g



T199	1	024240199
TV170	1	024000741

T201



● 1260
8x200
10x150
10x200 mm

● 1260N
4x30
6,5x30 mm

680 g



T201	1	024240201
TV171	1	024000742

T202



⊕ 1262
PH0x60
PH0x100
PH1x80
PH1x120
PH2x100
PH2x150 mm

490 g



T202	1	024240202
TV172	1	024000743

T204



⊕ 1262
PH3x150
PH4x200 mm

⊕ 1262N
PH1x30
PH2x30 mm

610 g



T204	1	024240204
TV173	1	024000744

T205



⊕ 1267TX
T6-T7-T8-T9
T10-T15-T20

460 g



T205	1	024240205
TV175	1	024000760

T206



⊕ 1267TX
T25-T27-T30
T40-T45

710 g



T206	1	024240206
TV176	1	024000761

T207



⊕ 1268RTX
T9-T10-T15
T20-T25-T27-T30

760 g



T207	1	024240207
TV207	1	024000758

T208



● 1260
3x75
4x100
5,5x150
6,5x150 mm

⊕ 1262
PH0x60
PH1x80
PH2x100 mm

530 g



T208	1	024240208
TV180	1	024000701

T209



⊕ 1262L
PH1x400-PH2x400 mm

● 1264L
3x300-4x400-5x400 mm

580 g



T209	1	024240209
TV183	1	024000497

T211



● 1201E
2,5x50
3x75
3,5x100
4x125
5,5x100
5,5x150
6,5x150 mm

490 g



T211	1	024240211
TV170	1	024000741

T213



⊕ 1202E
PH0x60
PH1x80
PH1x120
PH2x100
PH2x150
PH3x150 mm

490 g



T213	1	024240213
TV212	1	024000440

T216



⊕ 1207E/TX
T6-T7-T8-T9
T10-T15-T20

410 g



T216	1	024240216
TV175	1	024000760

T221



- 1201E 3x75
4x100
5,5x150
6,5x150 mm
- ⊕ 1202E PH0x60
PH1x80
PH2x100 mm

530 g



T221 1 024240221
TV180 1 024000701

T226

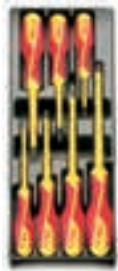

- 1274MQ 3x100
4x100
5,5x125
6,5x150 mm
- ⊕ 1272MQ PH0x60
PH1x80
PH2x100 mm

⚠ 1000 V

460 g



T226 1 024240226
TV180 1 024000701

T227



- 944BX 5-6-7-8-10-13 mm

490 g



T227 1 024240227
TV227 1 024000705

T228



- 1290INOX 3x75 - 4x100 -
5,5x150 - 6,5x150 mm
- ⊕ 1292INOX PH0x60 - PH1x80 -
PH2x100 mm



480 g



T228 1 024240228
TV180 1 024000701

T231



- 1370 400 g
- 1390 Ø 35 mm
- ▲ 1719BMA/T 200 mm
- 1719BMA/P 200 mm
- 1719BMA/M 200 mm

1,7 kg



T231 1 024240231
TV230 1 024000411

T233



- 35 100-200 mm
- 1370F 32 mm
- 1390 Ø 35 mm

1,3 kg



T233 1 024240233
TV232 1 024000452

T234



- 35 100-200 mm
- 1370 300 g
- 1390 Ø 35 mm

1,3 kg



T234 1 024240234
TV232 1 024000452

T236



- 1719BMA/Q 200 mm
- ▲ 1719BMA/T 200 mm
- 1719BMA/P 200 mm
- 1719BMA/M 200 mm
- 1719BMA/R 200 mm

870 g



T236 1 024240236
TV235 1 024000453

T239



- 31BM Ø 2-3-4-5-6-8 mm
- 32 Ø 4 mm

850 g



T239 1 024240239
TV239 1 024000439

T241



- 1500N/1
- 1500N/3
- 1516/1

4,2 kg



T241 1 024240241
TV241 1 024000414

T250

Automotive



- 34 150 mm
- 83/S3 11x13-14x17
19x22 mm
- 1458 175 mm
- 1491
- 1603
- 1708/13 0,05+1 mm

1430 g



T250 1 024240250
TV250 1 024000408

T256

Automotive



- 956E 16 mm (5/8) - 20,8 mm (13/16)
- 956L 16 mm (5/8) - 20,8 mm (13/16)
- 959 16 mm (5/8) - 20,8 mm (13/16)
- 1164 200 mm
- 1708/20 0,05+1 mm

3,2 kg



T256 1 024240256
TV255 1 024000467

T259

40



- 96BP 2,5-3-4-5
6-8-10 mm
- 96N 12 mm
- 860MIX/A31
-
- +
- +
- +
- 895/1

950 g



T259	1	024240259
TV263	1	024000492

T264

16



- 1491 Ø 65÷110 mm
- 1494 ■ 10 mm
- 1494E ○ 8-9-10-11-12-14-17 mm
- 1494Q ○ 8-9,5-12-13 mm
- △ 1494T △ 9,5
- 1494XZN ○ 16
- 1496C ■ 8x ■ 10 mm

2,1 kg



T264	1	024240264
TV264	1	024000466

T270

60



- 430 M3 - 4 - 5 - 6 - 7 - 8 - 9
10 - 12 - 14 - 16 - 18 - 20
- 433 M6x0,75 - M8x1 - M10x1,25
M12x1,5 - M14x1,5
M16x1,5 - M18x1,5
- 440 M3 - 4 - 5 - 6 - 7 - 8 - 9
- 440A M10 - 12 - 14 - 16 - 18 - 20
- 441 M6x0,75 - M8x1,0
- 441A M10x1,25 - M12x1,5
M14x1,5 - M16x1,5
M18x1,5

4,3 kg



T270	1	024240270
TV270	1	024000481

T273

7



- 435/1,5 M3÷M12
- 435/3 M5÷M21
- 436/1 □ 2,0÷5,0 mm
(M3÷M8)
- 436/2 □ 4,6÷8 mm
(M5÷M12)
- 444/1 Ø 25,4 mm
- 444/2 Ø 38,1 mm
- 1707 W 62÷4x1"

2,1 kg



T273	1	024240273
TV272	1	024000482

T281

1



- 1741B 250 mm
- 1741RV2,9K 2,9x6 mm (100)
- 1741RV3,2K 3,2x8 mm (100)
- 1741RV3,8K 3,8x10 mm (100)
- 1741RV4K 4x12 mm (100)

1,4 kg



T281	1	024240281
TV280	1	024000478

T285

4



- 1112 250 mm
- 1128BM -
- 1726 400 mm
- 1728BM (5 pezzi)
- 1753 200 cc

1,5 kg



T285	1	024240285
TV285	1	024000487



T284

10



- 1128BMX
- 1130BMX
- 1719BMA...Q 200 mm
- ▲ 1719BMA...T 200 mm
- 1719BMA...P 200 mm
- ▶ 1719BMA...M 200 mm
- 1719BMA...R 200 mm
- 1726BM 400 mm
- 1728BM
- 1771BM 170 mm
- 1778V18 185 mm

3,3 kg



T284	1	024240284
TV286	1	024249904

T289

4



- 1692 5 m
- 1725CR -
- 1755 30 cc
- 1771 -

500 g



T289	1	024240289
TV290	1	024000455

T291

3



- 1479RB/1
- 1479RB/2
- 1479RB/3

600 g



T291	1	024240291
TV291	1	024000472

T297

3



1651DGTB
1682
1691BM

490 g



T297	1	024240297
TV296	1	024000749

VP1-VP2

termoformati portaminuterie in materiale plastico per tutti i modelli di cassettiere: RSC22, RSC23, RSC23C

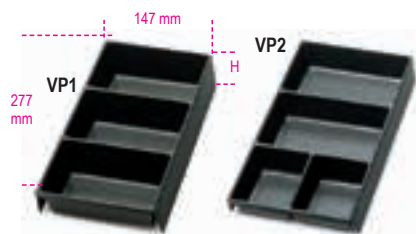

VP1	H mm	1	088880351
VP2	35	1	088880352

VP3-VP4

termoformati portaminuterie in materiale plastico per tutti i modelli di cassettiere e per i carrelli

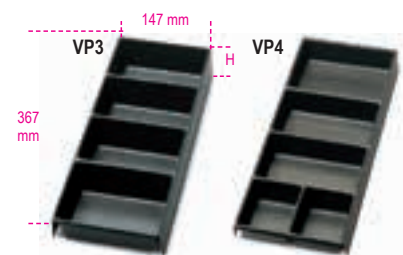

VP3	H mm	1	088880353
VP4	35	1	088880354

VP5

termoformato



VP5	1	088880355
-----	---	-----------

VP6

termoformato



VP6	1	088880359
-----	---	-----------

VP-3SC

termoformati portaminuterie in materiale plastico per cassetiera C38 +C04TSS-7

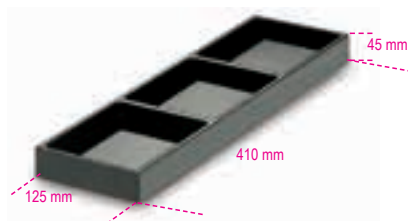

VP-3SC	H mm	45	1	088880356
--------	------	----	---	-----------

VP-LS

termoformati portaminuterie in materiale plastico per cassetiera C38 +C04TSS-7



VP-LS	H mm	45	1	088880357
-------	------	----	---	-----------

VP-LD

termoformati portaminuterie in materiale plastico per cassetiera C38



VP-LD	H mm	45	1	088880358
-------	------	----	---	-----------

8889P1

separatori paralleli per RSC22, RSC23, RSC23C e C27S
cassetto 588x277 mm



8889P1/5	h	50 mm	1	088890005
8889P1/7	h	70 mm	1	088890007

8889C1

separatori incrociati per RSC22, RSC23, RSC23C e C27S
cassetto 588x277 mm



8889C1/5	h	50 mm	1	088890015
8889C1/7	h	70 mm	1	088890017

8889P2

separatori paralleli per cassetto standard
588x367 mm



8889P2/7	h	70 mm	1	088890107
----------	---	-------	---	-----------

8889C2

separatori incrociati per cassetto standard
588x367 mm



8889C2	h	70 mm	1	088890117
--------	---	-------	---	-----------

8889P3

separatori paralleli per RSC24AXL

cassetto 882x367 mm



8889P3	h	70 mm	1	088890207
--------	---	-------	---	-----------

8889C3

separatori incrociati per RSC24AXL

per cassetto 882x367 mm



8889C3	h	70 mm	1	088890217
--------	---	-------	---	-----------

8889P4

separatori paralleli per trolley C41

cassetto 418x205 mm



8889P4	h 70 mm	1	088890307
--------	------------	---	-----------

8889I4

separatori incrociati per trolley C41

cassetto 418x205 mm



8889C4	h 70 mm	1	088890317
--------	------------	---	-----------

8889PS

separatori paralleli per C38 - C45PRO M4/M5/M7/M8

cassetto lato sinistro 570x410 mm



8889PS/7	h 70 mm	1	088890407
----------	------------	---	-----------

8889CS

separatori incrociati per C38 - C45PRO M4/M5/M7/M8

cassetto lato sinistro 570x410 mm



8889CS/7	h 70 mm	1	088890417
----------	------------	---	-----------

8889PD

separatori paralleli per C38

cassetto lato destro 313x410 mm



8889PD/7	h 70 mm	1	088890427
----------	------------	---	-----------

8889CD

separatori incrociati per C38

cassetto lato destro 313x410 mm



8889CD/7	h 70 mm	1	088890437
----------	------------	---	-----------

8889C6

separatori incrociati per C35

cassetto 600x447 mm



8889C6/7,5	h 75 mm	1	088890475
8889C6/10	100 mm	1	088890480
8889C6/15	150 mm	1	088890485
8889C6/20	200 mm	1	088890490

SB

guide portabussole



	L mm		
SB1	210	10	088880201
SB2	280	10	088880202
SB3	360	10	088880203

PM 1/2-Q5

guida magnetica portabussole

12"



PM 1/2-Q5	1	088880233
-----------	---	-----------

MB

molle per guide SB



	□		
MB0	1/4	50	088880210
MB1	3/8	50	088880211
MB2	1/2	50	088880212

KIT/GPS

Kit ganci GPS 40mm con viti VE1

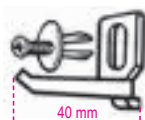

KIT/GPS	50	088880119
---------	----	-----------

VE1

Viti ad espansione



VE1	20	088880120
-----	----	-----------

GM

ganci a molla con viti ad espansione VE1



∅ mm		
6,5	5	088880250
9,5	5	088880251
13	5	088880252
16	5	088880253
19	5	088880254
25	5	088880255

S55/8

supporti per 8 chiavi a forchetta, in lamiera

• fornito completo di 3 viti ad espansione VE1

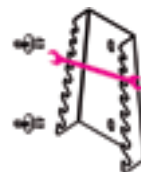

S55/8	1	088880420
55/S8		
55AS/8		
55MP/S8		

S55/12

supporti per 12 chiavi a forchetta, in lamiera

• fornito completo di 3 viti ad espansione VE1

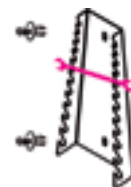

S55/12	1	088880421
55/S12		
55/S12X		
55AS/12		
55MP/S12		

ST2P

supporti portapinzze, in lamiera

• fornito completo di 3 viti ad espansione VE1

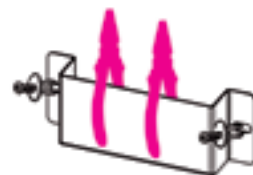

ST2P	1	088880422
------	---	-----------

TSPP

supporti portautensili, in materiale plastico

• fornito completo di 3 viti ad espansione VE1

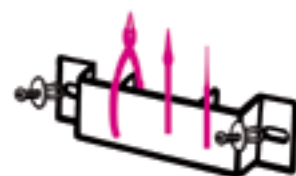

TSPP	1	088880402
------	---	-----------

S952/10

supporti per 10 chiavi a T, in lamiera

- fornito completo di 4 viti ad espansione VE1

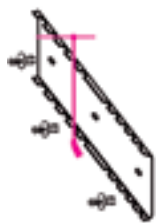

S952/10

1 088880423

S1719BM

supporti per 5 lime, in lamiera

- fornito completo di 3 viti ad espansione VE1



S1719BM

1719BMA: Q-T-P-M-R
1719BMD: Q-T-P-M-R
1719BMX: Q-T-P-M-R

1 088880404

SGN

supporti per 2 giravite nano, in lamiera

- fornito completo di 3 viti ad espansione VE1



SGN

1290N-1292N-1299N/PZ
1260N-1262N-1269N/PZ
1201EN-1202EN-1209EN/PZ

1 088880405

CB/2

termoformato rigido vuoto per bussole e accessori da 1/2"

- solo per C54S

12"

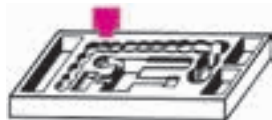

CB/2

920A/920B
10+24+26-27
28-30-32 mm
920/21-920/22-920/25-
920/42-920/55

1 088880411

S42/17

supporti per 17 chiavi combinate, in lamiera

- fornito completo di 3 viti ad espansione VE1



S42/17

42/S17
42MP/S17
42/S17X
42AS/17
142/S17

1 088880428

S951/6

supporti per 6 chiavi a T maschio, in lamiera

- fornito completo di 3 viti ad espansione VE1



S951/6

951/S6
951AS/S6X
951TX/S6

1 088880429

SPG11 - S1203/8

supporti per giravite, in lamiera

- fornito completo di 3 viti ad espansione VE1



SPG11

n.8 Ø = 7 mm
n.2 Ø = 10 mm
n.1 Ø = 12 mm

1 088880910

S1203/8

1203E/S8
1263/D8
1293/S8

1 088880430

S96T/8

supporti per 8 chiavi maschio esagonali con impugnatura, in lamiera

- fornito completo di 3 viti ad espansione VE1



S96T/8

96T/AS8
96T/S8
97TTX/S8

1 088880431

96T/SPV

supporti per 11 chiavi maschio esagonali con impugnatura, in lamiera

- fornito completo di 3 viti ad espansione VE1

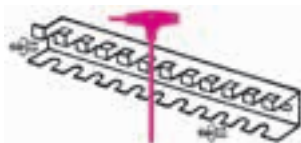

96T/SPV

96T/S11
97TTX/S11

1 000960958





Beta CHEMICALS

Prodotti anaerobici

I prodotti anaerobici garantiscono il completo riempimento delle piccole irregolarità superficiali del metallo in modo da garantire la distribuzione delle sollecitazioni meccaniche su tutta la superficie di collegamento. Si consolidano in totale assenza di ossigeno e sigillano completamente il giunto o la filettatura rispetto ad acqua, gas, oli, carburanti e fluidi industriali. Sono disponibili in tre classi di resistenza: alta (H), media (M) e bassa (L) e in differenti confezionamenti per soddisfare le differenti esigenze.

Sigillante siliconico

- permette di effettuare sigillature elastiche permanenti
- sostituisce le guarnizioni preformate.
- il pratico dosatore consente un'erogazione facile (ad una mano) e una distribuzione precisa e uniforme del prodotto
- polimerizza reagendo all'umidità atmosferica e forma una guarnizione elastica e resistente.

Colla istantanea

Adesivo a base di cianocrilato etilico, per giunzioni strutturali di vari materiali.

Aerosol

Ampia gamma di prodotti in bombolette spray concepiti per sbloccare, ingrassare, lubrificare, pulire, zincare e igienizzare.

Le bombolette sono in acciaio, completamente riciclabili.

Liquidi

Nascono per rimuovere incrostazioni e ruggine da pezzi meccanici e oggetti metallici. Ideali per l'impiego con le vasche di lavaggio a ultrasuoni 1895.



ATTENZIONE

Paesi in cui è possibile distribuire i prodotti della linea Beta Chemicals: Austria, Andorra, Belgio, Emirati Arabi Uniti, Francia, Italia, Nuova Caledonia, Paesi Bassi, Polonia, Portogallo, Principato di Monaco, Regno Unito, Repubblica Ceca, Repubblica d'Irlanda, Repubblica Dominicana, Repubblica Popolare Cinese, Reunion, San Marino, Slovacchia, Slovenia, Spagna, Svizzera, Ungheria

9803H

frenafiletti - forte resistenza

Ideale per bloccaggio permanente di parti che non devono essere smontate.

Per l'applicazione su superfici metalliche passivate come ottone, alluminio e acciaio inox.

Non consente lo smontaggio con utensili manuali.



Temperatura di impiego (°C)	-50/+150
Gioco diametrale (mm)	0,25
Velocità di reazione	10/15
blocco alla mano (minuti)	
Indurimento funzionale (ore)	3-6
Viscosità (mPa.s) 25°C	800/1200
Coppia di svitamento	35-45 Nm
INIZIALE (ISO-10964)	
Coppia di svitamento	30-40 Nm
RESIDUA (ISO-10964)	

ml	flacone	12	098030002
20	flacone	12	098030002
50	flacone	4	098030005
250	flacone	4	098030025
20	flacone	12	098032002
50	flacone	4	098032005
250	flacone	4	098032025

9802M

frenafiletti - media resistenza

Ideale per frenare e bloccare parti soggette a manutenzione e smontaggi periodici.

Permette lo smontaggio con l'uso di utensili manuali.



Temperatura di impiego (°C)	-50/+150
Gioco diametrale (mm)	0,15
Velocità di reazione	10/15
blocco alla mano (minuti)	
Indurimento funzionale (ore)	3-6
Viscosità (mPa.s) 25°C	500/800
Coppia di svitamento	22-30 Nm
INIZIALE (ISO-10964)	
Coppia di svitamento	20-25 Nm
RESIDUA (ISO-10964)	

ml	flacone	12	098020002
20	flacone	12	098020002
50	flacone	4	098020005
250	flacone	4	098020025
20	flacone	12	098022002
50	flacone	4	098022005
250	flacone	4	098022025

9801L

frenafiletti - bassa resistenza

Ideale per frenare particolari in leghe leggere che potrebbero danneggiarsi in fase di smontaggio o per viti di regolazione.

Permette uno smontaggio facile delle parti assemblate.



Temperatura di impiego (°C)	-50/+150
Gioco diametrale (mm)	0,10
Velocità di reazione	10/15
blocco alla mano (minuti)	
Indurimento funzionale (ore)	3-6
Viscosità (mPa.s) 25°C	500/800
Coppia di svitamento	6-10 Nm
INIZIALE (ISO-10964)	
Coppia di svitamento	4-8 Nm
RESIDUA (ISO-10964)	

ml	flacone	12	098010002
20	flacone	12	098010002
50	flacone	4	098010005
250	flacone	4	098010025
20	flacone	12	098012002
50	flacone	4	098012005
250	flacone	4	098012025

9813H

sigillaraccordi - forte resistenza

Ideale per sigillatura permanente di raccordi filettati che non devono essere smontati.

Per l'applicazione su superfici metalliche passivate come ottone, alluminio e acciaio inox.

Non consente lo smontaggio con utensili manuali.



Temperatura (°C)	-50/+200
Gioco diametrale (mm)	0,15
Velocità di reazione	10/15
blocco alla mano (minuti)	
Indurimento funzionale (ore)	3-6
Viscosità (mPa.s) 25°C	40.000/80.000
Coppia di svitamento	35-45 Nm
INIZIALE (ISO-10964)	
Coppia di svitamento	25-35 Nm
RESIDUA (ISO-10964)	

ml	flacone	12	098130002
20	flacone	12	098130002
50	soffietto	6	098130305
50	tubo	4	098130505
250	tubo	4	098130525
20	flacone	12	098132002
50	soffietto	6	098132305
50	tubo	4	098132505
250	tubo	4	098132525

9812M

sigillaraccordi - media resistenza

Ideale per sigillare raccordi filettati soggetti a manutenzione periodica.

Permette lo smontaggio con l'uso di utensili manuali.



Temperatura (°C)	-50/+150
Gioco diametrale (mm)	0,35
Velocità di reazione	12/18
blocco alla mano (minuti)	
Indurimento funzionale (ore)	3-6
Viscosità (mPa.s) 25°C	20.000/40.000
Coppia di svitamento	27-35 Nm
INIZIALE (ISO-10964)	
Coppia di svitamento	20-30 Nm
RESIDUA (ISO-10964)	

ml	flacone	12	098120002
20	flacone	12	098120002
50	soffietto	6	098120305
50	tubo	4	098120505
250	tubo	4	098120525
20	flacone	12	098122002
50	soffietto	6	098122305
50	tubo	4	098122505
250	tubo	4	098122525

9811L

sigillaraccordi- bassa resistenza

Ideale per sigillare raccordi piccoli o a passo fine.

Permette uno smontaggio facile delle parti assemblate.



Temperatura (°C)	-50/+150
Gioco diametrale (mm)	0,20
Velocità di reazione	10/15
blocco alla mano (minuti)	
Indurimento funzionale (ore)	3-6
Viscosità (mPa.s) 25°C	10.000/20.000
Coppia di svitamento	6-10 Nm
INIZIALE (ISO-10964)	
Coppia di svitamento	4-8 Nm
RESIDUA (ISO-10964)	

ml	flacone	12	098110002
20	flacone	12	098110002
50	soffietto	6	098110305
50	tubo	4	098110505
250	tubo	4	098110525
20	flacone	12	098112002
50	soffietto	6	098112305
50	tubo	4	098112505
250	tubo	4	098112525

9823H

guarnizione liquida- alta resistenza

Ideale per sigillare superfici in modo permanente.
Ideale anche per ricostruire sedi cuscinetto o parti usurate.
Non consente lo smontaggio con utensili manuali.



Temperatura (°C)	-50/+150
Gioco diametrale (mm)	0,35
Velocità di reazione	10/16
blocco alla mano (minuti)	
Indurimento funzionale (ore)	3-6
Viscosità (mPa.s) 25°C	100.000/200.000
Coppia di svitamento	35-45 Nm
INIZIALE (ISO-10964)	
Coppia di svitamento	20-30 Nm
RESIDUA (ISO-10964)	

ml			
20	flacone	12	098230002
50	soffietto	6	098230305
50	tubo	4	098230505
250	tubo	4	098230525
20	flacone	12	098232002
50	soffietto	6	098232305
50	tubo	4	098232505
250	tubo	4	098232525

9822M

guarnizione liquida- media resistenza

Ideale per sigillare superfici di parti soggette a manutenzione periodica.
Permette lo smontaggio con l'uso di utensili manuali.



Temperatura (°C)	-50/+150
Gioco diametrale (mm)	0,35
Velocità di reazione	10/15
blocco alla mano (minuti)	
Indurimento funzionale (ore)	3-6
Viscosità (mPa.s) 25°C	40.000/70.000
Coppia di svitamento	25-35 Nm
INIZIALE (ISO-10964)	
Coppia di svitamento	20-30 Nm
RESIDUA (ISO-10964)	

ml			
20	flacone	12	098220002
50	soffietto	6	098220305
50	tubo	4	098220505
250	tubo	4	098220525
20	flacone	12	098222002
50	soffietto	6	098222305
50	tubo	4	098222505
250	tubo	4	098222525

9821L

guarnizione liquida- bassa resistenza

Ideale per sigillare superfici di parti soggette a frequente manutenzione.
Tollerata la leggera contaminazione di olii.
Protegge le filettature da corrosione e grappaggi da corrosione.
Permette uno smontaggio facile delle parti assemblate.



Temperatura (°C)	-50/+150
Gioco diametrale (mm)	0,35
Velocità di reazione	20/30
blocco alla mano (minuti)	
Indurimento funzionale (ore)	3-6
Viscosità (mPa.s) 25°C	60.000/90.000
Coppia di svitamento	7-11 Nm
INIZIALE (ISO-10964)	
Coppia di svitamento	4-9 Nm
RESIDUA (ISO-10964)	

ml			
20	flacone	12	098210002
50	soffietto	6	098210305
50	tubo	4	098210505
250	tubo	4	098210525
20	flacone	12	098212002
50	soffietto	6	098212305
50	tubo	4	098212505
250	tubo	4	098212525

9833H

bloccante - alta resistenza

Ideale per fissaggio di parti che non devono essere smontate.
Adatto fissare dispositivi già installati dove risulta difficoltoso lo smontaggio.
Non consente lo smontaggio con utensili manuali.



Temperatura (°C)	-50/+180
Gioco diametrale (mm)	0,15
Velocità di reazione	10/15
blocco alla mano (minuti)	
Indurimento funzionale (ore)	3-6
Viscosità (mPa.s) 25°C	400/700
Coppia di svitamento	35-45 Nm
INIZIALE (ISO-10964)	
Coppia di svitamento	30-40 Nm
RESIDUA (ISO-10964)	

ml			
20	flacone	12	098330002
50	flacone	4	098330005
250	flacone	4	098330025
20	flacone	12	098332002
50	flacone	4	098332005
250	flacone	4	098332025

9832M

bloccante - media resistenza

Ideale per fissaggio di parti soggette a manutenzione periodica.
Permette lo smontaggio con l'uso di utensili manuali.



Temperatura (°C)	-50/+180
Gioco diametrale (mm)	0,25
Velocità di reazione	12/20
blocco alla mano (minuti)	
Indurimento funzionale (ore)	3-6
Viscosità (mPa.s) 25°C	2000/4000
Coppia di svitamento	25-35 Nm
INIZIALE (ISO-10964)	
Coppia di svitamento	18-28 Nm
RESIDUA (ISO-10964)	

ml			
20	flacone	12	098320002
50	flacone	4	098320005
250	flacone	4	098320025
20	flacone	12	098322002
50	flacone	4	098322005
250	flacone	4	098322025

9831L

bloccante- bassa resistenza

Ideale per fissaggio di parti soggette a manutenzione frequente e di piccole dimensioni.
Permette uno smontaggio facile delle parti assemblate.



Temperatura (°C)	-50/+150
Gioco diametrale (mm)	0,10
Velocità di reazione	10/15
blocco alla mano (minuti)	
Indurimento funzionale (ore)	3-6
Viscosità (mPa.s) 25°C	500/800
Coppia di svitamento	6-10 Nm
INIZIALE (ISO-10964)	
Coppia di svitamento	4-8 Nm
RESIDUA (ISO-10964)	

ml			
20	flacone	12	098310002
50	flacone	4	098310005
250	flacone	4	098310025
20	flacone	12	098312002
50	flacone	4	098312005
250	flacone	4	098312025

9841N

sigillante siliconico nero a reticolazione acetica, resistente ad alte temperature, con pratico erogatore a pressione

Resiste fino a temperature di 240°C

Permette di effettuare sigillature elastiche permanenti. Sostituisce le guarnizioni preformate.

L'erogatore consente una distribuzione facile, precisa e uniforme del prodotto.

Polimerizza reagendo all'umidità atmosferica e forma una guarnizione elastica e resistente.

Ideale per coppe olio, pompe olio, carter, scatole cambio, parti motore non soggette ad alte pressioni e applicazioni che necessitano di resistenza ad alte temperature. Aderisce a substrati non porosi, come vetro, legno verniciato, ceramica e smaltato. Non adatto per PE, PP, PC, PMMA, PTFE, plastica morbida, supporti in neoprene e bituminosi. Non verniciabile.



ml		
200		12 098410120
200		12 098412120

9841R

sigillante siliconico rosso a reticolazione acetica, resistente ad alte temperature, con pratico erogatore a pressione

Resiste fino a temperature di 300°C

Permette di effettuare sigillature elastiche permanenti. Sostituisce le guarnizioni preformate.

L'erogatore consente una distribuzione facile, precisa e uniforme del prodotto.

Polimerizza reagendo all'umidità atmosferica e forma una guarnizione elastica e resistente.

Ideale per porte di forni, piastre, sistemi di riscaldamento, scarichi, termostati, pompe, tubi di riscaldamento, parti motore non soggette ad alte pressioni e tutte le applicazioni dove è necessaria una resistenza alle alte temperature.

Aderisce a substrati non porosi, come vetro, legno verniciato, ceramica e smaltato. Non adatto per PE, PP, PC, PMMA, PTFE, plastica morbida, supporti in neoprene e bituminosi. Non verniciabile.



ml		
200		12 098410020
200		12 098412020

9851

colla istantanea per giunzioni strutturali istantanee

A base di cianoacrilato etilico.

Consente l'adesione di una vasta gamma di materiali come metallo, plastiche, cuoio, legno ed altri svariati tipi di substrato anche in combinazione tra loro.

Velocità di presa Alta.



Temperatura (°C)	-55/+82
Viscosità (mPa.s) 25°C	80-120

g		
5	tubo	24 098510500
20	flacone	12 098510002
50	flacone	10 098510005
5	tubo	24 098512500
20	flacone	12 098512002
50	flacone	10 098512005

9710 - LUBRIBETA universal

sbloccante lubrificante multiuso 7 funzioni

1. Sbloccante;
 2. Lubrificante;
 3. Detergente;
 4. Protettivo antiruggine;
 5. Disossidante per contatti elettrici;
 6. Idrorepellente;
 7. Anticongelante
- Non contiene silicone.



ml		
400		12 097100040
400		12 097101040
400		12 097102040



9712 - Ultra Sblock

sbloccante, super-penetrante

Sbloccante, disossidante e idrorepellente

Ideale per sciogliere la ruggine da dadi, bulloni, viti e ingranaggi.



ml		
400		12 097120040
400		12 097121040
400		12 097122040

9720 - Multi Grease

grasso lubrificante spray multiuso

Particolarmente indicato per la lubrificazione di catene, ingranaggi e parti metalliche in movimento.

Resiste agli attriti e agli agenti atmosferici. Altamente adesivo. Non cola.



ml		
400		12 097200040
400		12 097201040
400		12 097202040

9722 - Lithium Grease

grasso bianco spray al litio

A base di grassi saponificati di litio, titanio e ossidi di zinco. Ideale per ingranaggi, cuscinetti e giunti. Specifico per applicazioni marine.

Fortemente resistente ad acqua, salsedine, agenti atmosferici e alte temperature.

Non cola.



ml		
400		12 097220040
400		12 097221040
400		12 097222040

9724 - PTFE Grease

grasso spray a base di P.T.F.E.

Particolarmente indicato per lubrificazione di catene industriali e movimenti meccanici a forti pressione e rotazioni non elevate.

Adatto per applicazioni su plastica e gomma. Totalmente incolore. Idrorepellente e resistente all'ossidazione.



ml		
400		12 097240040
400		12 097241040
400		12 097242040

9726 - Copper Grease

grasso spray al rame micronizzato

Per lubrificazione di giunti, bulloni, ingranaggi, alberi motore e altre parti metalliche soggette ad elevate temperature (fino a 1.000° C).

Protettivo, anti-usura. Previene l'ossidazione. Non cola.



ml		
400		12 097260040
400		12 097261040
400		12 097262040

9729 - Silic Spray

silicone spray

Adatto per la lubrificazione dei parti in plastica, gomma e metalli.

Protegge dalla corrosione. Distaccante. Antistatico.

Idrorepellente.

Lucidante per legno, plastica e gomma. Non contiene solventi.



ml		
400		12 097290040
400		12 097291040
400		12 097292040

9738 - Cutting Oil

olio da taglio

Ad alto potere lubrificante e protettivo.

Indicato per fresatura, alesatura, filettatura, foratura e lavorazioni per macchine manuali e automatiche.

Elevata resistenza all'ossidazione.

Lavabile con acqua. Non contiene solventi.



ml		
400		12 097380040
400		12 097381040
400		12 097382040

9740 - Brake Cleaner

pulitore per freni

Ideale per la pulizia di dischi e pastiglie freno, motori.

Elimina grasso e catrame, senza lasciare residui.

Ad evaporazione rapida. Non intacca gomma e plastica.



ml		
500		12 097400050
500		12 097401050
500		12 097402050

9741 - Multi Cleaner

detergente, sgrassante multiuso

Detergente e sgrassante per sciogliere grasso, olio, catrame, silicone e colla.

Adatto per pulizia di superfici in metallo, plastica rigida, ceramica, acciaio e alluminio.

Non lascia residui oleosi.



ml		
400		12 097410040
400		12 097411040
400		12 097412040

9742 - Contact Cleaner

pulitore per contatti elettrici ed elettronici

Elimina unto e sporco, senza lasciare residui oleosi.

Ad evaporazione rapida. Non intacca plastica e gomma.



ml		
400		12 097420040
400		12 097421040
400		12 097422040

9743 - SURFACE CLEANER

detergente schiumogeno

Detergente schiumogeno per tutti i tipi di superfici, utensili e tessuti.

A base di sali quaternari di ammonio, crea una schiuma attiva che pulisce e rimuove sporco e unto.

Rimuove i cattivi odori. Non serve risciacquo. Non è un disinfettante.



ml		
500		12 097430050
500		12 097431050
500		12 097432050

9745 - Carb Cleaner

pulitore per carburatori e corpi farfallati

Specifico per la pulizia interna ed esterna di carburatori, condotti di aspirazione e corpi farfallati.

Elimina totalmente i residui carboniosi, depositi e impurità. Non lascia residui oleosi.



ml		
400		12 097450040
400		12 097451040
400		12 097452040

9746 - Clima Cleaner

pulitore per climatizzatori

Pulitore per climatizzatori e condizionatori industriali, civili e auto. Grazie alla sua formulazione schiumogena densa e alla cannuccia in dotazione, consente di eliminare sporco, incrostazioni ed odori all'interno dei condotti, lasciando una gradevole fragranza.



ml		
400	12	097460040
400	12	097461040
400	12	097462040

9749 - Air Spray

aria spray

Aerosol a base di gas compresso. Ideale per eliminare depositi di polvere in fessure, ingranaggi, componenti elettrici, tastiere e meccanismi delicati in genere. L'erogatore con tubicino consente di raggiungere in profondità anche parti poco accessibili.



ml		
400	12	097490040
400	12	097491040
400	12	097492040

9752 - Zinc 98%

zinco chiaro

Con elevato potere coprente, è ideale per zincare parti in ferro.

Fortemente adesivo, crea un film elastico di colore molto chiaro, simile alla zincatura a caldo.

Particolarmente resistente a ossidazione, abrasione e agenti atmosferici.

Può essere sovra-verniciato. Non cola.



ml		
400	12	097520040
400	12	097521040
400	12	097522040

9755 - Welding Spray

antiadesivo per saldatura

Antiadesivo per saldatura senza siliceni. Evita l'adesione di scorie, facilitando e velocizzando l'operazione di saldatura. Da utilizzare su parti da saldare e come protettivo per gli ugelli delle torce di saldatura. Consente lavorazioni successive come verniciatura, zincatura e cromatura. Non produce fumi. Facile da asportare. Non contiene clorurati.



ml		
400	12	097550040
400	12	097551040
400	12	097552040

9765 - Deicer Spray

deghiacciante spray

Deghiacciante e sbrinatoro spray, per sciogliere ghiaccio e brina da vetri e cristalli. Ideale anche per serrature e meccanismi bloccati dal ghiaccio. Agisce fino a -40°C. Non unge e non lascia aloni. Non intacca le superfici trattate, gomma e plastica.



ml		
400	12	097650040
400	12	097651040
400	12	097652040

9775 - Water Stop

impermeabilizzante per tessuti

Impermeabilizzante, idrorepellente per tessuti, cuoio e pelle. Ideale per scarpe, giacche e abiti in genere. Consente di impermeabilizzare i tessuti, senza comprometterne la traspirabilità. Il potere antimacchia rende i tessuti più facilmente lavabili. Migliora la resistenza alla flessione e all'abrasione.



ml		
400	12	097750040
400	12	097751040
400	12	097752040

9881U

detergente industriale alcalino per vasca ultrasuoni.

Detergente industriale alcalino, concentrato, a base acqua. Per pulizia ad ultrasuoni e altri processi di purificazione. Consente una pulizia accurata ed efficace di parti di ricambio e pezzi metallici in genere (iniettori, carburatori, valvole, ecc.). Rimuove oli, grassi, lubrificanti, residui di colla, resine, cere. Adatto anche per la pulizia di parti in alluminio.



Lt		
1	1	098810010
1	1	098812010

9882R

liquido distaccante selettivo di ruggine.

Liquido distaccante selettivo di ruggine a base acqua per ferro, acciaio, acciaio inox, ghisa e cromature. Rimuove lo strato ossidato, senza danneggiare il substrato metallico.

Diluzione: da puro a max 1:1.

Temperatura minima di utilizzo: 15°C.

Tempi utilizzo: 30' - 24/48h (per ruggine consistente).

Biodegradabile e 100% idrosolubile.



Lt		
1	1	098820010
1	1	098822010



Beta

ABRASIVES

Una gamma completa di abrasivi rigidi e flessibili, composta da più di 500 referenze prodotte interamente in Italia. Nata e sviluppata per soddisfare ogni esigenza industriale e professionale di taglio o asportazione di materiale. Con il progetto Beta Abrasives, Beta Utensili afferma la sua volontà di offrire una gamma di prodotti completa e un servizio tecnico assoluto ai professionisti del mercato, garantito dalle competenze produttive apportate da AbraBeta.

DISCHI RIGIDI da taglio e da sbavo



I dischi rigidi rappresentano la categoria più importante di questa nuova famiglia di prodotti, per questo motivo Beta Utensili ha posto la massima attenzione nella scelta dei materiali utilizzati e delle tipologie adottate.

I dischi da taglio e sbavo sono gli strumenti più rapidi e polivalenti per la lavorazione di un'ampia varietà di materiali, mediante l'utilizzo degli utensili più indicati, siano essi smerigliatrici angolari o macchine stazionarie.

FORME dei dischi

T42
disco da taglio con centro depresso

T41
disco da taglio con centro piano

T27
disco da sbavo con centro depresso

TOP
— LINE —

La qualità senza compromessi: destinati ad utilizzatori estremamente esigenti.

PREMIUM
— LINE —

Alta qualità per grandi prestazioni, con un prezzo competitivo, per il miglior rapporto qualità/prezzo.

CERTIFICAZIONI



PITTOGRAMMI presenti sui dischi



Usare occhiali protettivi



Usare guanti protettivi



Usare cuffie antirumore



Usare abbigliamento protettivo



Usare maschera antipolvere



Consultare il manuale d'istruzioni



Disco solo per taglio – non adatto per sbavare



Non usare il disco se danneggiato



Esente da ferro, zinco e cloro ($\leq 0,1\%$)

Validità del prodotto

La validità dei dischi è di 3 anni a partire dalla data di produzione. La dicitura "V01" incisa sulla rondella metallica al centro del disco indica il trimestre di scadenza. Esempio: la dicitura "V07/2022" indica che il disco è stato prodotto nel 3° trimestre 2019 e può essere utilizzata fino alla fine del 3° trimestre 2022.



	Trimestre
V01	Gen-Mar
V04	Apr-Giu
V07	Lug-Set
V10	Ott-Dic



MOLE CON GAMBO

Mole abrasive con gambo per utilizzo con smerigliatrici assiali. Realizzate in varie forme per adattarsi alle differenti lavorazioni e con tre tipologie di abrasivo.



RUOTE CON GAMBO

Le ruote lamellari con gambo sono prodotte con lamelle flessibili per ottenere finiture precise ed omogenee su forme e superfici irregolari.



DISCHI LAMELLARI

I dischi lamellari sono composti da lamelle di tela abrasiva incollate ad un supporto; sono un'ottima scelta per operazioni di sgrossatura e di finitura. In generale, rispetto ai dischi da sbavo, garantiscono un'asportazione più veloce, finitura più omogenea, minori vibrazioni, meno rumore e temperature di lavoro inferiori. Sono disponibili con tele di vari materiali abrasivi con differenti granulometrie e due tipi diversi di supporto.

Esecuzioni

Profilo piano

Si utilizza con un angolo massimo di 15° rispetto al piano di lavoro e permette la lavorazione di superfici piane e spigoli.

Profilo conico

Semplifica le operazioni su superfici accidentate e si utilizza con un angolo tra i 15° e i 25° rispetto al piano di lavoro. Assicura una maggiore superficie di contatto tra il disco e la superficie di lavorazione. Le lamelle possono essere utilizzate fino al loro completo esaurimento.



La qualità senza compromessi: destinati ad utilizzatori estremamente esigenti.



Alta qualità per grandi prestazioni, con un prezzo competitivo, per il miglior rapporto qualità/prezzo.



RUOTE CON FORO

Le ruote lamellari su flangia sono prodotti idonei per la lavorazione di bordi, contorni e superfici irregolari grazie all'elevata flessibilità delle lamelle.



RUOTE PER SATINATRICI

Le ruote (o rulli) per satinatrici Beta rappresentano la soluzione migliore per la finitura di qualsiasi materiale.

Gradi di grana/finitura

C	Grossolana (Coarse)
M	Media (Medium)
F	Fine (Fine)
VF	Molto fine (Very Fine)
UF	Ultra fine



DISCHI RADIALI E DISCHI FIBRATI

Dischi speciali in tessuto non tessuto (TNT) con elevate capacità di lucidatura che permettono lavorazioni veloci e precise.

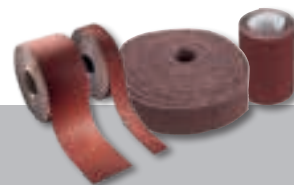

ROTOLI ANTISPRECO

Un'ampia offerta di rotoli antispesco di tela e carta abrasiva e di tessuto non tessuto, di ottima qualità per gli utilizzi più vari.

Per qualsiasi ulteriore informazione si prega di fare riferimento al catalogo dedicato disponibile sul sito Beta:
www.beta-tools.com

11001

dischi abrasivi da taglio per acciaio
esecuzione a **centro depresso**

A30S EN 12413



	Ø	S	F	max.		
	mm	mm	mm	rpm		
11001	115	3,2	22,23	13300	10	110010118
11001	125	3,2	22,23	12200	10	110010128
11001	230	3,2	22,23	6600	10	110010233

11001H

dischi abrasivi da taglio per acciaio
esecuzione a **centro depresso**

come 11001 versione rigida - HARD

A30T EN 12413



	Ø	S	F	max.		
	mm	mm	mm	rpm		
11001H	230	3,2	22,23	6600	10	110010733

11003

dischi abrasivi da taglio per acciaio
esecuzione a **centro piano**

A30T EN 12413



	Ø	S	F	max.		
	mm	mm	mm	rpm		
11003	115	2,5	22,23	13300	10	110030117
11003	125	2,5	22,23	12200	10	110030127
11003	180	2,5	22,23	8500	10	110030182
11003	230	2,5	22,23	6600	10	110030232

11011

dischi abrasivi da sbavo per acciaio
esecuzione a **centro depresso**

A24N EN 12413



	Ø	S	F	max.		
	mm	mm	mm	rpm		
11011	115	6,5	22,23	13300	10	110110115
11011	125	6,5	22,23	12200	10	110110125
11011	180	6,5	22,23	8500	10	110110180
11011	230	6,5	22,23	6600	10	110110230

11011H

dischi abrasivi da sbavo per acciaio
esecuzione a **centro depresso**

come 11011 versione rigida - HARD

A24R EN 12413



	Ø	S	F	max.		
	mm	mm	mm	rpm		
11011H	115	6,5	22,23	13300	10	110110615
11011H	125	6,5	22,23	12200	10	110110625
11011H	180	6,5	22,23	8500	10	110110680
11011H	230	6,5	22,23	6600	10	110110730

11018

dischi abrasivi per troncatura acciaio
esecuzione a **centro piano**

velocità max. 60 m/s

A46N EN 12413



	Ø	S	F	max.		
	mm	mm	mm	rpm		
11018	300	2,5	25,40	4010	10	110180030
11018	350	3,0	25,40	3440	10	110180035
11018	400	3,2	25,40	3010	10	110180040

11019

dischi abrasivi per troncare **acciaio**
esecuzione a **centro piano**

velocità max. 80 m/s

A24N EN 12413



A24N



	Ø	S	F	max.		
	mm	mm	mm	rpm		
11019	300	3,8	25,40	5100	10	110190030
11019	350	4,2	25,40	4400	10	110190035
11019	400	4,5	25,40	3800	10	110190040

11021

dischi abrasivi da taglio per **acciaio e inox**
esecuzione a **centro depresso**

A30Q EN 12413



A30Q



	Ø	S	F	max.		
	mm	mm	mm	rpm		
11021	115	3,2	22,23	13300	10	110210118
11021	125	3,2	22,23	12200	10	110210128
11021	180	3,2	22,23	8500	10	110210183
11021	230	3,2	22,23	6600	10	110210233

11023

dischi abrasivi da sbavo per **acciaio e inox**
esecuzione a **centro depresso**

A24Q EN 12413



A24Q



	Ø	S	F	max.		
	mm	mm	mm	rpm		
11023	115	6,5	22,23	13300	10	110230115
11023	125	6,5	22,23	12200	10	110230125
11023	230	6,5	22,23	6600	10	110230230

11024

dischi abrasivi da taglio per **acciaio e inox**
esecuzione di **spessore sottile** e a **centro depresso**

TOP LINE

A46U EN 12413



TOP
LINE

A46U



	Ø	S	F	max.		
	mm	mm	mm	rpm		
11024	230	2,0	22,23	6600	10	110240230

11031+11038

dischi abrasivi da taglio per **acciaio e inox**
esecuzione di **spessore sottile** e a **centro piano**

TOP LINE

A46U EN 12413



TOP
LINE

A46U



	Ø	S	F	max.		
	mm	mm	mm	rpm		
11031	65	1,0	6,00	24000	25	110310006
11031	65	1,0	10,00	24000	25	110310010
11031	65	1,6	10,00	24000	25	110310020

	Ø	S	F	max.		
	mm	mm	mm	rpm		
11032	76	1,0	6,00	20200	25	110320006
11032	76	1,0	10,00	20200	25	110320010
11032	76	1,6	10,00	20200	25	110320020

	Ø	S	F	max.		
	mm	mm	mm	rpm		
11034	115	1,0	22,23	13300	25	110340022
11034	115	1,2	22,23	13300	25	110340042
11034	115	1,6	22,23	13300	25	110340062

	Ø	S	F	max.		
	mm	mm	mm	rpm		
11035	125	1,0	22,23	12200	25	110350022
11035	125	1,2	22,23	12200	25	110350042
11035	125	1,6	22,23	12200	25	110350062

	Ø	S	F	max.		
	mm	mm	mm	rpm		
11037	180	2,0	22,23	8500	10	110370022

	Ø	S	F	max.		
	mm	mm	mm	rpm		
11038	230	2,0	22,23	6600	10	110380022

11040

dischi abrasivi da taglio per acciaio e inox
esecuzione di spessore sottile e a centro depresso

PREMIUM LINE

A36Q EN 12413



A36Q

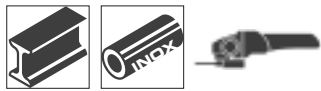

	Ø mm	S mm	F mm	max. rpm		
11040	230	2,0	22,23	6600	10	110400230

11045-11046

dischi abrasivi da taglio per acciaio e inox
esecuzione di spessore sottile e a centro piano

PREMIUM LINE

A46Q EN 12413



A46Q

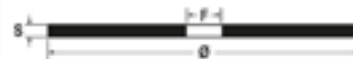
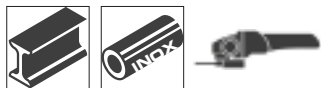

	Ø mm	S mm	F mm	max. rpm		
11045	115	1,0	22,23	13300	25	110450010
11045	115	1,2	22,23	13300	25	110450012
11045	115	1,6	22,23	13300	25	110450016

	Ø mm	S mm	F mm	max. rpm		
11046	125	1,0	22,23	12200	25	110460010
11046	125	1,2	22,23	12200	25	110460012
11046	125	1,6	22,23	12200	25	110460016

11048-11049

dischi abrasivi da taglio per acciaio e inox
esecuzione di spessore sottile e a centro piano

PREMIUM LINE

A36Q EN 12413



A36Q

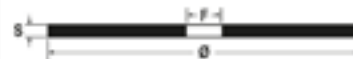

	Ø mm	S mm	F mm	max. rpm		
11048	180	2,0	22,23	8500	10	110480019

	Ø mm	S mm	F mm	max. rpm		
11049	230	2,0	22,23	6600	10	110490019

11050

dischi abrasivi da sbavo per acciaio e ghisa
esecuzione allo zirconio e a centro depresso

ZA24R - EN 12413



ZA24R



	Ø mm	S mm	F mm	max. rpm		
11050	115	6,5	22,23	13300	10	110500115
11050	125	6,5	22,23	12200	10	110500125
11050	230	7,0	22,23	6600	10	110500230

11069

dischi abrasivi da taglio per pietra e marmo
esecuzione a centro depresso

C30S EN 12413



C30S



	Ø mm	S mm	F mm	max. rpm		
11069	115	3,2	22,23	13300	10	110690115
11069	125	3,2	22,23	12200	10	110690125
11069	230	3,2	22,23	6600	10	110690230



11100

mole abrasive con gambo
granuli abrasivi di corindone rosa
forma cilindrica

gambo Ø 3 x 37 mm

EN 12413

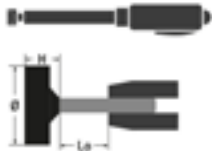

	Ø mm	h mm	max. rpm Lo=13 mm			
11100	4	8	130.000	AR60P5V	25	111000004
11100	6	10	93.100	AR60P5V	25	111000006
11100	8	12	64.500	AR60P5V	25	111000008
11100	10	10	60.100	AR60P5V	25	111000011
11100	10	12	52.700	AR60P5V	25	111000012
11100	12	15	37.300	AR60P5V	25	111000013

11101

mole abrasive con gambo
granuli abrasivi di corindone rosa
forma cilindrica

gambo Ø 6 x 40 mm

EN 12413



	Ø mm	h mm	max. rpm Lo=13 mm			
11101	4	8	130.000	AR60P5V	25	111010004
11101	5	10	130.000	AR60P5V	25	111010005
11101	6	10	130.000	AR60P5V	25	111010006
11101	8	10	119.300	AR60P5V	25	111010008
11101	10	10	95.400	AR60P5V	25	111010010
11101	10	15	95.400	AR60P5V	25	111010011
11101	10	20	86.600	AR60P5V	25	111010012
11101	10	25	72.700	AR60P5V	25	111010013
11101	10	32	58.700	AR60P5V	25	111010014
11101	12	10	79.500	AR60P5V	25	111010015
11101	12	15	79.500	AR60P5V	25	111010016
11101	12	20	79.500	AR60P5V	25	111010017
11101	15	3	63.600	AR60P5V	25	111010018
11101	15	15	63.600	AR60P5V	25	111010019
11101	16	20	59.600	AR46P5V	25	111010020
11101	16	25	56.900	AR46P5V	25	111010021
11101	16	32	45.100	AR46P5V	25	111010022
11101	20	4	47.700	AR60P5V	25	111010023
11101	20	15	47.700	AR46P5V	25	111010024
11101	20	20	47.700	AR46P5V	25	111010025
11101	20	25	46.100	AR46P5V	25	111010026
11101	20	30	38.900	AR46P5V	25	111010027
11101	20	40	29.000	AR46P5V	25	111010028
11101	25	10	38.100	AR60P5V	25	111010030
11101	25	25	37.200	AR36/46P5V	25	111010031
11101	25	40	23.300	AR36/46P5V	10	111010032
11101	30	10	31.800	AR60P5V	25	111010034
11101	30	30	26.200	AR36/46P5V	25	111010035
11101	30	40	19.500	AR36/46P5V	10	111010036
11101	32	20	29.800	AR36P5V	25	111010037
11101	32	32	23.100	AR36P5V	10	111010038
11101	40	10	23.800	AR36/46P5V	25	111010041
11101	40	20	23.800	AR36P5V	10	111010042
11101	40	25	23.400	AR36P5V	10	111010043
11101	40	30	19.700	AR36P5V	10	111010044
11101	40	40	14.700	AR36P5V	10	111010045
11101	50	15	19.000	AR36P5V	10	111010051
11101	50	25	18.800	AR36P5V	10	111010052
11101	60	10	15.900	AR36P5V	10	111010060

11102

mole abrasive con gambo
granuli abrasivi di corindone rosa
forma cilindrica

gambo Ø 6 x 80 mm

EN 12413



	Ø mm	h mm	max. rpm Lo=13 mm			
11102	8	20	100.500	AR60P5V	25	111020008
11102	10	15	95.400	AR60P5V	25	111020010
11102	10	30	62.200	AR60P5V	25	111020020
11102	12	15	79.500	AR60P5V	25	111020022
11102	15	15	63.600	AR60P5V	25	111020035
11102	15	30	51.000	AR46P5V	25	111020040
11102	20	30	38.900	AR46P5V	25	111020060

11105

mole abrasive con gambo
granuli abrasivi di corindone rosa
forma cilindro triangolare

gambo Ø 6 x 40 mm

EN 12413



	Ø mm	h mm	max. rpm Lo=13 mm			
11105	20	65	16.200	AR36/46P5V	25	111050020

11106

mole abrasive con gambo
granuli abrasivi di corindone rosa
forma trapezoidale

gambo Ø 3 x 37 mm

EN 12413



	Ø mm	h mm	max. rpm Lo=13 mm			
11106	6	10	93.100	AR60P5V	25	111060006

11107

mole abrasive con gambo
granuli abrasivi di corindone rosa
forma trapezoidale

gambo Ø 6 x 40 mm

EN 12413

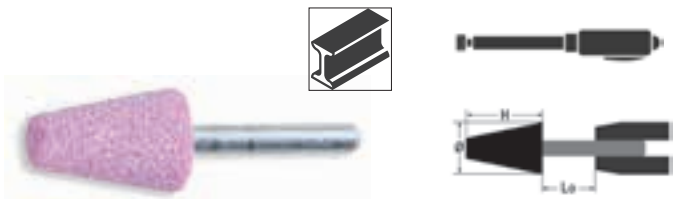

	Ø mm	h mm	max. rpm Lo=13 mm		
11107	12	20	79.500	AR60P5V	25 111070012
11107	15	25	60.400	AR46P5V	25 111070015
11107	20	30	38.900	AR46P5V	25 111070020
11107	25	40	23.300	AR36/46P5V	10 111070025

11110

mole abrasive con gambo
granuli abrasivi di corindone rosa
forma conica arrotondata

gambo Ø 3 x 37 mm

EN 12413

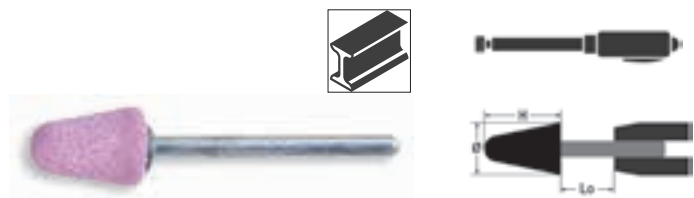

	Ø mm	h mm	max. rpm Lo=13 mm		
11110	10	15	44.300	AR60P5V	25 111100010

11111

mole abrasive con gambo
granuli abrasivi di corindone rosa
forma conica arrotondata

gambo Ø 6 x 40 mm

EN 12413

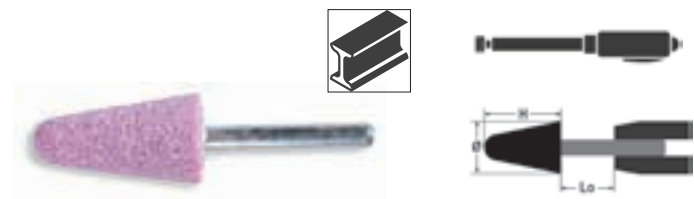

	Ø mm	h mm	max. rpm Lo=13 mm		
11111	10	20	86.600	AR60P5V	25 111110010
11111	15	30	51.000	AR46P5V	25 111110015
11111	16	45	31.400	AR46P5V	25 111110016
11111	20	28	41.500	AR46P5V	25 111110020
11111	20	40	29.000	AR46P5V	25 111110021
11111	30	50	15.100	AR36/46P5V	10 111110030

11115

mole abrasive con gambo
granuli abrasivi di corindone rosa
forma ad ogiva

gambo Ø 3 x 37 mm

EN 12413

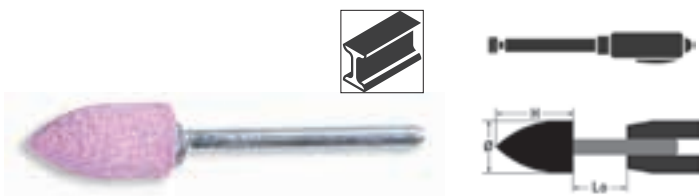

	Ø mm	h mm	max. rpm Lo=13 mm		
11115	10	20	34.700	AR60P5V	25 111150010

11116

mole abrasive con gambo
granuli abrasivi di corindone rosa
forma ad ogiva

gambo Ø 6 x 40 mm

EN 12413

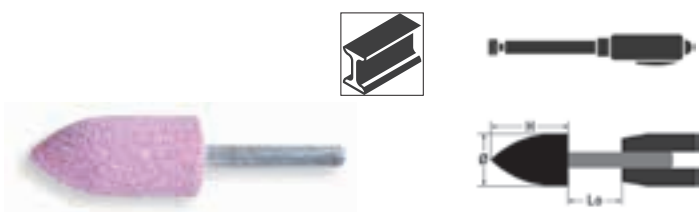

	Ø mm	h mm	max. rpm Lo=13 mm		
11116	10	20	86.600	AR60P5V	25 111160010
11116	18	30	43.000	AR46P5V	25 111160018
11116	20	50	22.500	AR36/46P5V	25 111160020
11116	22	70	13.400	AR36/46P5V	10 111160022

11120

mole abrasive con gambo
granuli abrasivi di corindone rosa
forma cilindro piramidale

gambo Ø 3 x 37 mm

EN 12413

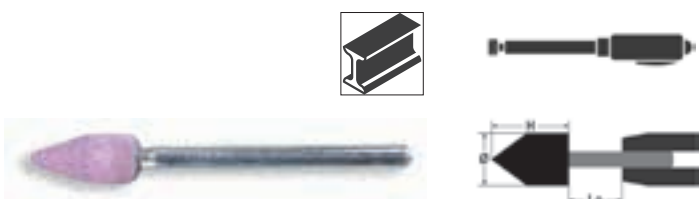

	Ø mm	h mm	max. rpm Lo=13 mm		
11120	6	13	77.800	AR60P5V	25 111200006



11121

mole abrasive con gambo
granuli abrasivi di corindone rosa
forma cilindro piramidale

gambo Ø 6 x 40 mm

EN 12413



	Ø mm	h mm	max. rpm Lo=13 mm		
11121	6	25	100.700	AR60P5V	25 111210007
11121	12	20	79.500	AR60P5V	25 111210012
11121	20	25	46.100	AR46P5V	25 111210020
11121	25	25	37.200	AR36/46P5V	25 111210025
11121	30	30	26.200	AR36/46P5V	25 111210030

11125

mole abrasive con gambo
granuli abrasivi di corindone rosa
forma cilindro arrotondato

gambo Ø 6 x 40 mm

EN 12413



	Ø mm	h mm	max. rpm Lo=13 mm		
11125	6	20	117.700	AR60P5V	25 111250006
11125	25	25	37.200	AR36/46P5V	25 111250025
11125	30	50	15.100	AR36/46P5V	10 111250030
11125	40	40	14.700	AR36P5V	10 111250040

11130

mole abrasive con gambo
granuli abrasivi di corindone rosa
forma sferica

gambo Ø 3 x 37 mm

EN 12413



	Ø mm	h mm	max. rpm Lo=13 mm		
11130	6	6	124.900	AR60P5V	25 111300006
11130	8	8	84.800	AR60P5V	25 111300008
11130	10	10	60.100	AR60P5V	25 111300010

11131

mole abrasive con gambo
granuli abrasivi di corindone rosa
forma sferica

gambo Ø 6 x 40 mm

EN 12413



	Ø mm	h mm	max. rpm Lo=13 mm		
11131	10	10	95.400	AR60P5V	25 111310010
11131	15	15	63.600	AR60P5V	25 111310015
11131	20	20	47.700	AR46P5V	25 111310020
11131	25	25	37.200	AR36/46P5V	25 111310025
11131	30	30	26.200	AR36/46P5V	25 111310030

11132

mole abrasive con gambo
granuli abrasivi di corindone rosa
forma sferica

gambo Ø 6 x 80 mm

EN 12413



	Ø mm	h mm	max. rpm Lo=13 mm		
11132	10	10	95.400	AR60P5V	25 111320010
11132	15	15	63.600	AR60P5V	25 111320015
11132	20	20	47.700	AR46P5V	25 111320020

11135

mole abrasive con gambo
granuli abrasivi di corindone rosa
forma a disco

gambo Ø 6 x 40 mm

EN 12413



	Ø mm	h mm	max. rpm Lo=13 mm		
11135	30	6	31.800	AR60P5V	25 111350030
11135	40	10	23.800	AR36/46P5V	25 111350040

11140

mole abrasive con gambo
granuli abrasivi di corindone grigio/rosa
forma cilindrica

gambo Ø 6 x 40 mm

EN 12413

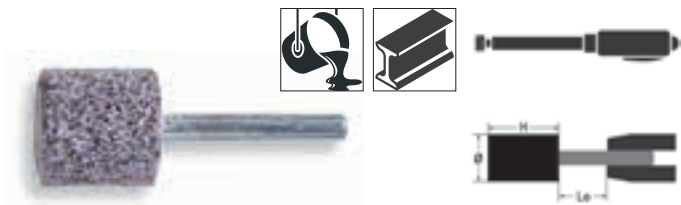

	Ø mm	h mm	max. rpm Lo=13 mm			
11140	20	30	38.900	A/AR24R5V	25	111400020
11140	25	25	37.200	A/AR24R5V	25	111400025
11140	30	30	26.200	A/AR24R5V	25	111400030
11140	50	10	19.000	A/AR24R5V	10	111400050

11141

mole abrasive con gambo
granuli abrasivi di corindone grigio/rosa
forma cilindrica

gambo Ø 8 x 40 mm

EN 12413

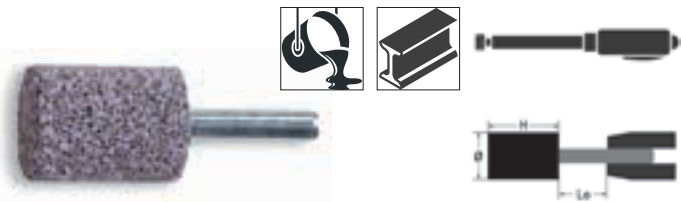

	Ø mm	h mm	max. rpm Lo=13 mm			
11141	20	40	46.800	A/AR24R5V	25	111410020
11141	30	40	31.800	A/AR24R5V	10	111410030
11141	40	40	23.800	A/AR24R5V	10	111410040

11145

mole abrasive con gambo
granuli abrasivi di corindone grigio/rosa
forma ad ogiva

gambo Ø 6 x 40 mm

EN 12413

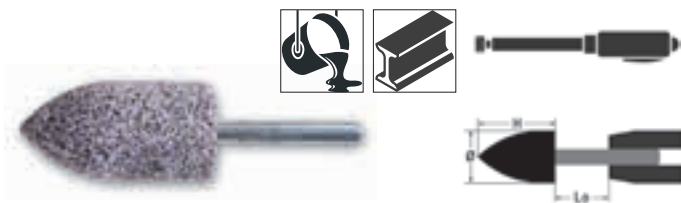

	Ø mm	h mm	max. rpm Lo=13 mm			
11145	20	30	38.900	A/AR24R5V	25	111450020
11145	25	50	18.100	A/AR24R5V	10	111450025

11200A-11200B

dischi lamellari con tela abrasiva allo zirconio
supporto in plastica e lamella singola

Esecuzione piana

PREMIUM LINE

EN 13743

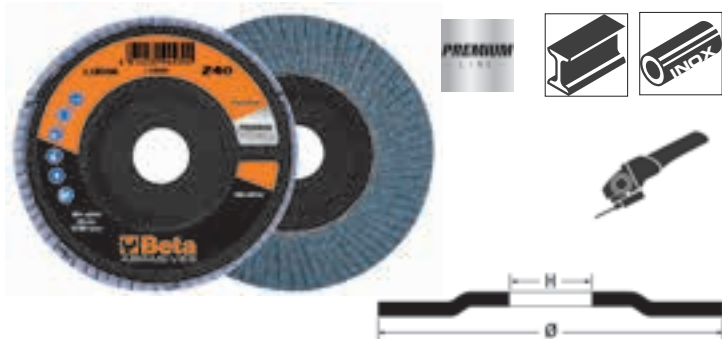

	Ø mm	P	F mm			
11200A	115	40	22,23	10	112000004	
11200A	115	60	22,23	10	112000006	
11200A	115	80	22,23	10	112000008	
11200A	115	120	22,23	10	112000012	

	Ø mm	P	F mm			
11200B	125	40	22,23	10	112000104	
11200B	125	60	22,23	10	112000106	
11200B	125	80	22,23	10	112000108	

11202A-11202C

dischi lamellari con tela abrasiva allo zirconio
supporto in plastica e lamella doppia

Esecuzione piana

PREMIUM LINE

EN 13743

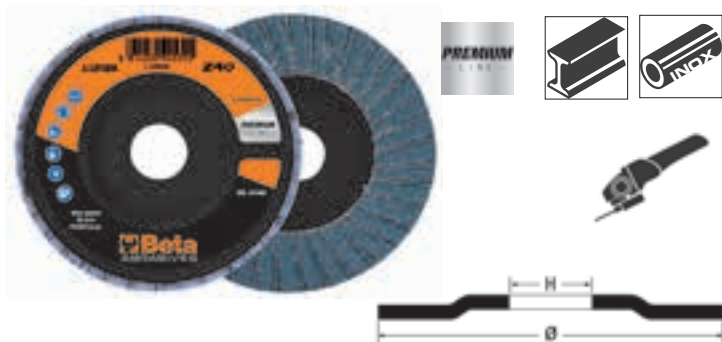

	Ø mm	P	F mm			
11202A	115	40	22,23	10	112020004	
11202A	115	60	22,23	10	112020006	
11202A	115	80	22,23	10	112020008	
11202A	115	120	22,23	10	112020012	

	Ø mm	P	F mm			
11202B	125	40	22,23	10	112020104	
11202B	125	60	22,23	10	112020106	
11202B	125	80	22,23	10	112020108	

	Ø mm	P	F mm			
11202C	180	40	22,23	10	112020204	
11202C	180	60	22,23	10	112020206	

11204A÷11204C

dischi lamellari con tela abrasiva allo zirconio
supporto in fibra di vetro e lamella singola

Esecuzione piana
PREMIUM LINE
EN 13743



	Ø mm	P	F mm		
11204A	115	40	22,23	10	112040004
11204A	115	60	22,23	10	112040006
11204A	115	80	22,23	10	112040008
11204A	115	120	22,23	10	112040012

	Ø mm	P	F mm		
11204B	125	40	22,23	10	112040104
11204B	125	60	22,23	10	112040106
11204B	125	80	22,23	10	112040108

	Ø mm	P	F mm		
11204C	180	40	22,23	10	112040204
11204C	180	60	22,23	10	112040206

11208A-11208B

dischi lamellari con tela abrasiva allo zirconio
supporto in fibra di vetro e lamella doppia

Esecuzione piana
PREMIUM LINE
EN 13743



	Ø mm	P	F mm		
11208A	115	40	22,23	10	112080004
11208A	115	60	22,23	10	112080006

	Ø mm	P	F mm		
11208B	125	40	22,23	10	112080104
11208B	125	60	22,23	10	112080106

11210A÷11210C

dischi lamellari con tela abrasiva allo zirconio
supporto in fibra di vetro e lamella singola

Esecuzione conica
PREMIUM LINE
EN 13743



	Ø mm	P	F mm		
11210A	115	40	22,23	10	112100004
11210A	115	60	22,23	10	112100006
11210A	115	80	22,23	10	112100008
11210A	115	120	22,23	10	112100012

	Ø mm	P	F mm		
11210B	125	40	22,23	10	112100104
11210B	125	60	22,23	10	112100106
11210B	125	80	22,23	10	112100108

	Ø mm	P	F mm		
11210C	180	40	22,23	10	112100204
11210C	180	60	22,23	10	112100206

11212A-11212B

dischi lamellari con tela abrasiva allo zirconio
supporto in plastica e lamella singola

Esecuzione piana
TOP LINE
EN 13743



	Ø mm	P	F mm		
11212A	115	40	22,23	10	112120004
11212A	115	60	22,23	10	112120006
11212A	115	80	22,23	10	112120008
11212A	115	120	22,23	10	112120012

	Ø mm	P	F mm		
11212B	125	40	22,23	10	112120104
11212B	125	60	22,23	10	112120106
11212B	125	80	22,23	10	112120108

11214A÷11214C

dischi lamellari con tela abrasiva allo zirconio
supporto in plastica e lamella doppia

Esecuzione piana
TOP LINE
EN 13743

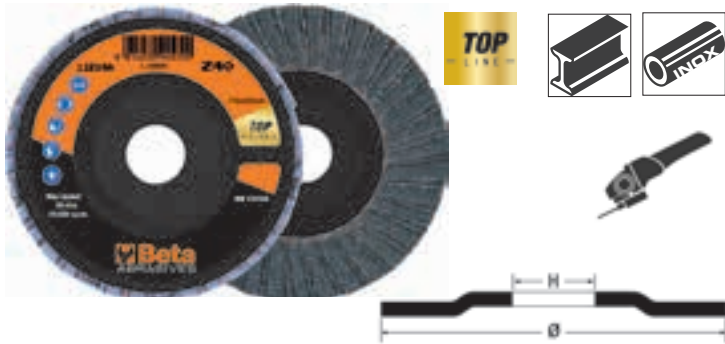

	Ø mm	P	F mm		
11214A	115	40	22,23	10	112140004
11214A	115	60	22,23	10	112140006
11214A	115	80	22,23	10	112140008
11214A	115	120	22,23	10	112140012

	Ø mm	P	F mm		
11214B	125	40	22,23	10	112140104
11214B	125	60	22,23	10	112140106
11214B	125	80	22,23	10	112140108

	Ø mm	P	F mm		
11214C	180	40	22,23	10	112140204
11214C	180	60	22,23	10	112140206

11216A÷11216C

dischi lamellari con tela abrasiva allo zirconio
supporto in fibra di vetro e lamella singola

Esecuzione piana
TOP LINE

EN 13743



	Ø mm	P	F mm		
11216A	115	40	22,23	10	112160004
11216A	115	60	22,23	10	112160006
11216A	115	80	22,23	10	112160008
11216A	115	120	22,23	10	112160012

	Ø mm	P	F mm		
11216B	125	40	22,23	10	112160104
11216B	125	60	22,23	10	112160106
11216B	125	80	22,23	10	112160108

	Ø mm	P	F mm		
11216C	180	40	22,23	10	112160204
11216C	180	60	22,23	10	112160206

11218A-11218B

dischi lamellari con tela abrasiva allo zirconio
supporto in fibra di vetro e lamella doppia

Esecuzione piana
TOP LINE
EN 13743



	Ø mm	P	F mm		
11218A	115	40	22,23	10	112180004
11218A	115	60	22,23	10	112180006

	Ø mm	P	F mm		
11218B	125	40	22,23	10	112180104
11218B	125	60	22,23	10	112180106

11220A÷11220C

dischi lamellari con tela abrasiva allo zirconio
supporto in fibra di vetro e lamella singola

Esecuzione conica
TOP LINE
EN 13743



	Ø mm	P	F mm		
11220A	115	40	22,23	10	112200004
11220A	115	60	22,23	10	112200006
11220A	115	80	22,23	10	112200008
11220A	115	120	22,23	10	112200012

	Ø mm	P	F mm		
11220B	125	40	22,23	10	112200104
11220B	125	60	22,23	10	112200106
11220B	125	80	22,23	10	112200108

	Ø mm	P	F mm		
11220C	180	40	22,23	10	112200204
11220C	180	60	22,23	10	112200206

11222

dischi lamellari con tela abrasiva allo zirconio
supporto in fibra di vetro e lamella doppia

Esecuzione conica
TOP LINE
EN 13743



	Ø mm	P	F mm		
11222B	125	40	22,23	10	112220104
11222B	125	60	22,23	10	112220106
11222B	125	80	22,23	10	112220108

11230A-11230B

dischi lamellari con tela abrasiva al corindone
supporto in plastica e lamella singola

Esecuzione piana
PREMIUM LINE
EN 13743



	Ø mm	P	F mm		
11230A	115	40	22,23	10	112300004
11230A	115	60	22,23	10	112300006
11230A	115	80	22,23	10	112300008
11230A	115	120	22,23	10	112300012
11230B	125	40	22,23	10	112300104
11230B	125	60	22,23	10	112300106

Beta

11232A

dischi lamellari con tela abrasiva al corindone
supporto in plastica e lamella doppia

Esecuzione piana
PREMIUM LINE
EN 13743



	Ø mm	P	F mm		
11232A	115	40	22,23	10	112320004
11232A	115	60	22,23	10	112320006
11232A	115	80	22,23	10	112320008
11232A	115	120	22,23	10	112320012

11234A-11234B

dischi lamellari con tela abrasiva al corindone
supporto in fibra di vetro e lamella singola

Esecuzione piana
TOP LINE
EN 13743



	Ø mm	P	F mm		
11234A	115	40	22,23	10	112340004
11234A	115	60	22,23	10	112340006
11234A	115	80	22,23	10	112340008
11234A	115	120	22,23	10	112340012
11234B	125	40	22,23	10	112340104
11234B	125	60	22,23	10	112340106



11240A-11240B

dischi lamellari con tela abrasiva allo zirconio ceramicato
supporto in plastica e lamella singola

Esecuzione piana
TOP LINE
EN 13743

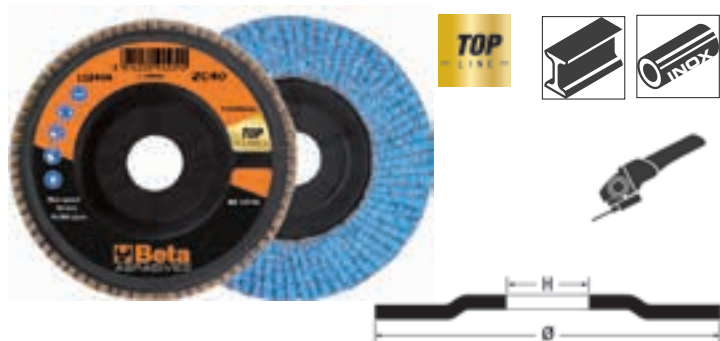

	Ø mm	P	F mm		
11240A	115	40	22,23	10	112400004
11240A	115	60	22,23	10	112400006

	Ø mm	P	F mm		
11240B	125	40	22,23	10	112400104
11240B	125	60	22,23	10	112400106

11242A-11242B

dischi lamellari con tela abrasiva allo zirconio ceramicato
supporto in fibra di vetro e lamella singola

Esecuzione piana
TOP LINE
EN 13743



	Ø mm	P	F mm		
11242A	115	40	22,23	10	112420004
11242A	115	60	22,23	10	112420006

	Ø mm	P	F mm		
11242B	125	40	22,23	10	112420104
11242B	125	60	22,23	10	112420106

11246A

dischi lamellari con tela abrasiva ceramicata
supporto in plastica e lamella singola

Esecuzione piana
TOP LINE
EN 13743



	Ø mm	P	F mm		
11246A	115	40	22,23	10	112460004
11246A	115	60	22,23	10	112460006

11248A-11248B

dischi lamellari con tela abrasiva ceramicata
supporto in fibra di vetro e lamella singola

Esecuzione piana
TOP LINE
EN 13743



	Ø mm	P	F mm		
11248A	115	40	22,23	10	112480004
11248A	115	60	22,23	10	112480006

	Ø mm	P	F mm		
11248B	125	40	22,23	10	112480104
11248B	125	60	22,23	10	112480106

11259

dischi lamellari con lamelle in feltro
supporto in fibra di vetro e lamella singola

Esecuzione piana
TOP LINE



	Ø mm	F mm		
11259	115	22,23	10	112590115
11259	125	22,23	10	112590125



11260÷11268

ruote a lamelle con gambo
lamelle in tela abrasiva al corindone

EN 13743



	Ø mm	h mm	S mm	P		
11260	10	10	3	60	10	112600010
11260	15	15	3	60	10	112600015

	Ø mm	h mm	S mm	P		
11263	30	10	6	60	10	112630006
11263	30	15	6	60	10	112630016
11263	30	15	6	80	10	112630018
11263	30	20	6	40	10	112630024
11263	30	20	6	60	10	112630026
11263	30	20	6	80	10	112630028
11263	30	20	6	120	10	112630032

	Ø mm	h mm	S mm	P		
11264	40	15	6	60	10	112640006
11264	40	15	6	80	10	112640008
11264	40	15	6	120	10	112640012
11264	40	20	6	40	10	112640014
11264	40	20	6	60	10	112640016
11264	40	30	6	40	10	112640024
11264	40	30	6	60	10	112640026

	Ø mm	h mm	S mm	P		
11265	50	20	6	60	10	112650006
11265	50	20	6	80	10	112650008
11265	50	30	6	40	10	112650014
11265	50	30	6	60	10	112650016
11265	50	30	6	80	10	112650018
11265	50	30	6	120	10	112650022

	Ø mm	h mm	S mm	P		
11266	60	20	6	40	10	112660004
11266	60	20	6	60	10	112660006
11266	60	30	6	40	10	112660014
11266	60	30	6	60	10	112660016
11266	60	30	6	80	10	112660018
11266	60	30	6	120	10	112660022
11266	60	40	6	60	10	112660026
11266	60	40	6	80	10	112660028

	Ø mm	h mm	S mm	P		
11268	80	30	6	60	10	112680006
11268	80	30	6	80	10	112680008



11271A÷11271C

ruote in tessuto non tessuto abrasivo con gambo
tessuto in fibre sintetiche al corindone

gambo Ø 6 mm



	Ø mm	h mm	S mm	P		
11271A	40	20	6	C	10	112710001
11271A	40	20	6	M	10	112710002
11271A	40	20	6	F	10	112710003
11271A	40	20	6	VF	10	112710004

	Ø mm	h mm	S mm	P		
11271B	60	30	6	C	10	112710011
11271B	60	30	6	M	10	112710012
11271B	60	30	6	F	10	112710013
11271B	60	30	6	VF	10	112710014

	Ø mm	h mm	S mm	P		
11271C	80	50	6	C	10	112710021
11271C	80	50	6	M	10	112710022
11271C	80	50	6	F	10	112710023
11271C	80	50	6	VF	10	112710024

11276A÷11276C

ruote miste lamelle/tessuto non tessuto con gambo
lamelle in tela abrasiva alternata a tessuto in fibre sintetiche al corindone

gambo Ø 6 mm



	Ø mm	h mm	S mm	P		
11276A	40	20	6	M/60	10	112760006
11276A	40	20	6	M/80	10	112760008
11276A	40	20	6	M/120	10	112760012

	Ø mm	h mm	S mm	P		
11276B	60	30	6	M/60	10	112760016
11276B	60	30	6	M/80	10	112760018
11276B	60	30	6	M/120	10	112760022

	Ø mm	h mm	S mm	P		
11276C	80	50	6	M/60	10	112760036
11276C	80	50	6	M/80	10	112760038
11276C	80	50	6	M/120	10	112760042



11300A÷11300G

ruote lamellari con tela al corindone con foro

EN 13743

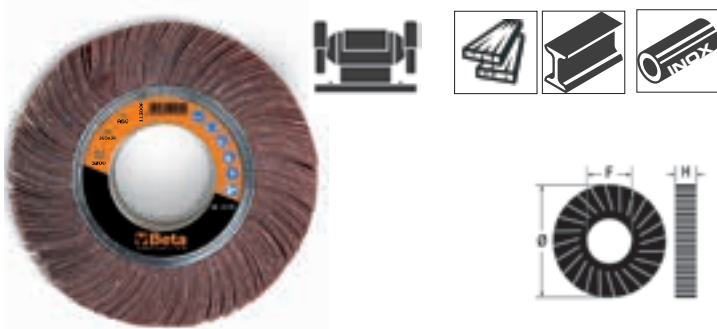

	Ø mm	H mm	P	F mm		
11300A	165	30	40	54	3	113000004
11300A	165	30	60	54	3	113000006
11300A	165	30	80	54	3	113000008
11300A	165	30	120	54	3	113000012
11300A	165	30	180	54	3	113000018
11300A	165	30	220	54	3	113000022

	Ø mm	H mm	P	F mm		
11300B	165	50	40	54	2	113000104
11300B	165	50	60	54	2	113000106
11300B	165	50	80	54	2	113000108
11300B	165	50	120	54	2	113000112
11300B	165	50	180	54	2	113000118
11300B	165	50	220	54	2	113000122

	Ø mm	H mm	P	F mm		
11300C	200	30	40	54	3	113000204
11300C	200	30	60	54	3	113000206
11300C	200	30	80	54	3	113000208
11300C	200	30	120	54	3	113000212
11300C	200	30	180	54	3	113000218

	Ø mm	H mm	P	F mm		
11300D	200	50	40	54	2	113000304
11300D	200	50	60	54	2	113000306
11300D	200	50	80	54	2	113000308
11300D	200	50	120	54	2	113000312
11300D	200	50	180	54	2	113000318
11300D	200	50	220	54	2	113000322

	Ø mm	H mm	P	F mm		
11300E	250	30	40	100	3	113000404
11300E	250	30	60	100	3	113000406
11300E	250	30	80	100	3	113000408
11300E	250	30	120	100	3	113000412

	Ø mm	H mm	P	F mm		
11300F	250	50	40	100	2	113000504
11300F	250	50	60	100	2	113000506
11300F	250	50	80	100	2	113000508
11300F	250	50	120	100	2	113000512
11300F	250	50	180	100	2	113000518
11300F	250	50	220	100	2	113000522

	Ø mm	H mm	P	F mm		
11300G	300	50	40	100	2	113000604
11300G	300	50	60	100	2	113000606
11300G	300	50	80	100	2	113000608

11320

ruote in tessuto non tessuto abrasivo con foro
tessuto in fibre sintetiche al corindone

Ø 200 x 50 mm

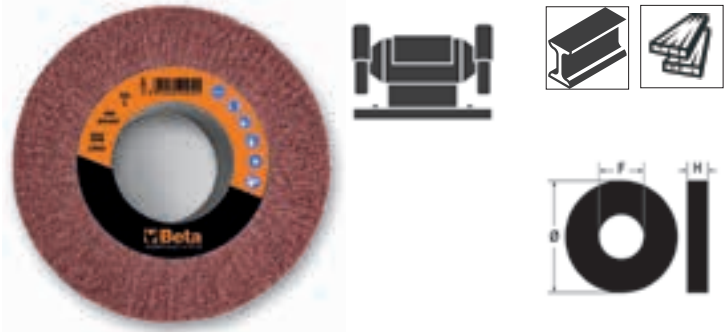

	Ø mm	H mm	P	F mm		
11320	200	50	C	76,2	2	113200006
11320	200	50	M	76,2	2	113200008
11320	200	50	F	76,2	2	113200012
11320	200	50	VF	76,2	2	113200024

11411

ruote lamellari con tela al corindone per satinatrici

Ø 100 x 100 mm

EN 13743

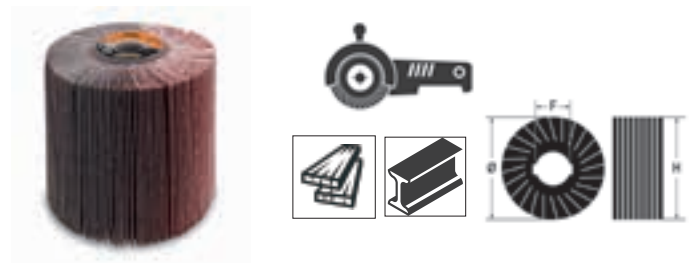

	Ø mm	H mm	P	F mm		
11411	100	100	40	19,1	2	114110004
11411	100	100	60	19,1	2	114110006
11411	100	100	80	19,1	2	114110008
11411	100	100	120	19,1	2	114110012
11411	100	100	240	19,1	2	114110024

11415B

ruote in tessuto non tessuto
fibre sintetiche al corindone per satinatrici

Ø 100 x 100 mm

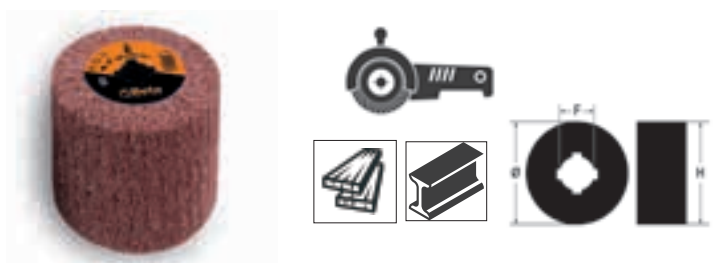

	Ø mm	H mm	P	F mm		
11415B	100	100	C	19,1	2	114150106
11415B	100	100	M	19,1	2	114150108
11415B	100	100	F	19,1	2	114150112
11415B	100	100	VF	19,1	2	114150124

11420B

ruote miste lamelle/tessuto non tessuto per satinatrici
tela abrasiva alternata a fibre sintetiche al corindone

Ø 100 x 100 mm

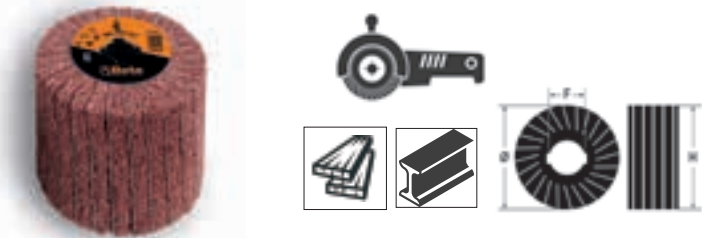

	Ø mm	H mm	P	F mm		
11420B	100	100	C/60	19,1	2	114200106
11420B	100	100	M/80	19,1	2	114200108
11420B	100	100	F/120	19,1	2	114200112
11420B	100	100	VF/240	19,1	2	114200124

11431

dischi radiali in tessuto non tessuto
fibre sintetiche al corindone

Ø 115 mm

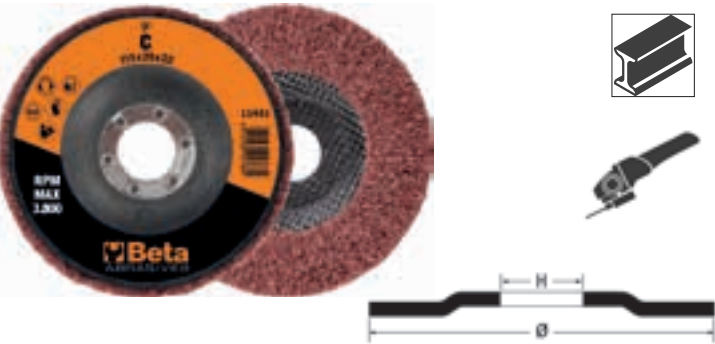

	Ø mm	P	F mm		
11431	115	C	22,23	4	114310006
11431	115	M	22,23	4	114310008
11431	115	F	22,23	4	114310012
11431	115	VF	22,23	4	114310024

11435

dischi radiali miste lamelle/tessuto non tessuto
tela abrasiva alternata a fibre sintetiche al corindone

Ø 115 mm

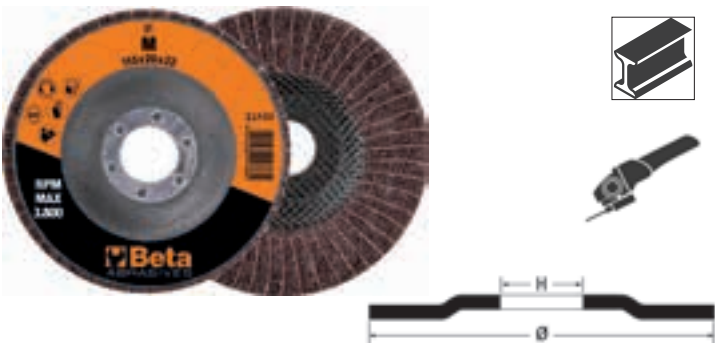

	Ø mm	P	F mm		
11435	115	M/80	22,23	4	114350008
11435	115	M/120	22,23	4	114350012
11435	115	F/150	22,23	4	114350015
11435	115	F/180	22,23	4	114350018

11440A÷11440C

dischi fibrati con tela allo zirconio

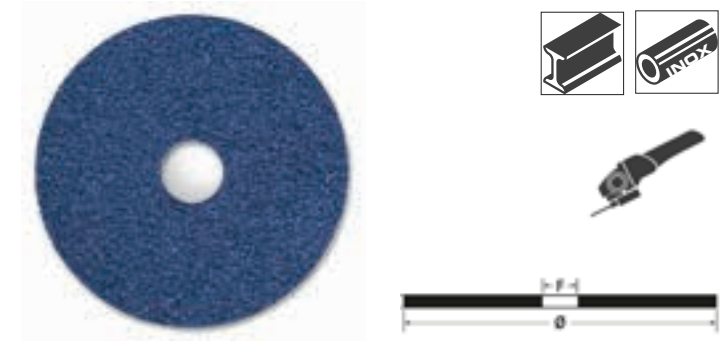

	Ø mm	P	F mm		
11440A	115	24	22	25	114400024
11440A	115	36	22	25	114400036
11440A	115	60	22	25	114400060
11440A	115	120	22	25	114400120

	Ø mm	P	F mm		
11440B	125	24	22	25	114400224
11440B	125	36	22	25	114400236
11440B	125	60	22	25	114400260
11440B	125	120	22	25	114400320

	Ø mm	P	F mm		
11440C	180	24	22	25	114400424
11440C	180	36	22	25	114400436
11440C	180	60	22	25	114400460
11440C	180	120	22	25	114400520

11450A÷11450C

dischi fibrati con tela al corindone



	Ø mm	P	F mm		
11450A	115	24	22	25	114500024
11450A	115	36	22	25	114500036
11450A	115	60	22	25	114500060
11450A	115	120	22	25	114500120

	Ø mm	P	F mm		
11450B	125	24	22	25	114500224
11450B	125	36	22	25	114500236
11450B	125	60	22	25	114500260
11450B	125	120	22	25	114500320

	Ø mm	P	F mm		
11450C	180	24	22	25	114500424
11450C	180	36	22	25	114500436
11450C	180	60	22	25	114500460
11450C	180	120	22	25	114500520

11488PF

plattrelli di fissaggio per dischi fibrati con ghiera M14



	Ø mm		
11488P	115	1	114880115
11488P	125	1	114880125
11488P	180	1	114880180

11491-11493-11495

rotoli antispreco in tela abrasiva al corindone



	H mm	L m	P	
11491	38	50	40	1 114910004
11491	38	50	60	1 114910006
11491	38	50	80	1 114910008
11491	38	50	100	1 114910010
11491	38	50	120	1 114910012
11491	38	50	150	1 114910015
11491	38	50	180	1 114910018
11491	38	50	220	1 114910022
11491	38	50	240	1 114910024
11491	38	50	320	1 114910032
11491	38	50	400	1 114910040

	H mm	L m	P	
11493	50	50	40	1 114930004
11493	50	50	60	1 114930006
11493	50	50	80	1 114930008
11493	50	50	100	1 114930010
11493	50	50	120	1 114930012
11493	50	50	150	1 114930015
11493	50	50	180	1 114930018
11493	50	50	220	1 114930022
11493	50	50	240	1 114930024
11493	50	50	320	1 114930032
11493	50	50	400	1 114930040

	H mm	L m	P	
11495	120	25	40	1 114950004
11495	120	25	60	1 114950006
11495	120	25	80	1 114950008
11495	120	25	100	1 114950010
11495	120	25	120	1 114950012
11495	120	25	180	1 114950018
11495	120	25	240	1 114950024
11495	120	25	400	1 114950040

11498

rotolo antispreco in tessuto non tessuto fibre sintetiche al corindone

h 100 mm x 10 m



	H mm	L m	P	
11498	100	10	M	1 114980008
11498	100	10	F	1 114980012
11498	100	10	VF	1 114980015
* 11498	100	10	UF	1 114980018

*Carburo di silicio



PINZE PER CAPICORDA E CAPICORDA

Codice		Capicorda	Matrice	Range (mm ²)	Utilizzo
1601/PC					Per capicorda telefonia e trasmissione dati 4P/6P/8P
1602				0,75-6	Per capicorda preisolati modello leggero
1602A				0-6	Per capicorda preisolati modello standard
1603				1,25-5,5	Per capicorda non isolati modello leggero
1603A				0-8	Per capicorda non isolati chiusi modello standard
1603B				0-8	Per capicorda non isolati aperti modello standard
1606/2				0,14-10	A grande effetto per capicorda a tubetto
1606A				0,5-6 6-16	Per capicorda a tubetto
1606T				0,1-10	Per capicorda a tubetto, crimpatura su 4 lati
1607				6,48 5,41 1,69	A grande effetto per connettori BNC per cavi coassiali RG 58, RG 59, RG 62, RG 71
1608				0,5-6	Per capicorda preisolati, con regolatore di pressione
1608A				0,75-6	A grande effetto per capicorda preisolati
1609				0,5-2,5	Per capicorda non isolati
1609A				0,5-6	A grande effetto per capicorda non isolati
1609B				10-120	Per capicorda non isolati

1601/PC

pinza a cricchetto per capicorda telefonia e trasmissione dati

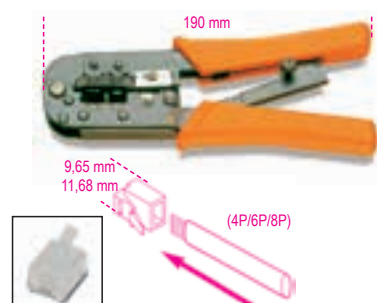

RJ11-RJ12-RJ45

2 016010011

1602

pinza per capicorda preisolati modello leggero



mm²
0,75÷6

5 016020001

1602/C9

pinza per capicorda 1602 con assortimento di 450 capicorda



1602/C9

1 016020045

1602

BM00180	R/6,3	n.	1
BM00280	B/6,3		50
BM00380	G/6,3		50
BM00191	R/6,3		50
BM00291	B/6,3		50
BM00392	G/6,3		50
BM00160	R/1,6		50
BM00260	B/2,3		50
BM00360	G/3,6		50

420x350x35 mm - 1,5 kg



1602A

pinza per capicorda preisolati
modello standard



mm^2
0÷6

2 016020005

1603

pinza per capicorda
non isolati modello leggero

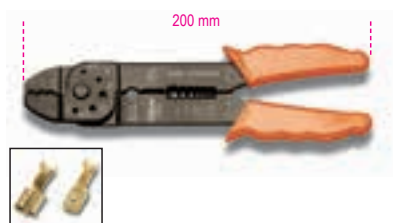

mm^2
1,25÷5,5

5 016030001

1603A

pinza per capicorda non isolati chiusi
modello standard

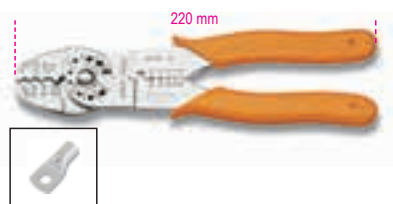

mm^2
0÷8

2 016030005

1603B

pinza per capicorda non isolati aperti
modello standard

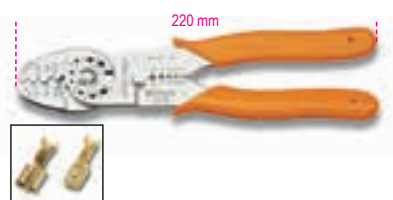

mm^2
0÷8

2 016030010

1606/2

pinza a grande effetto
per capicorda a tubetto



mm^2
0,14÷10

L mm 175
A mm 65
B mm 20

1 016060002

1606A

pinza per capicorda a tubetto



mm^2
1606A6 0,5÷6
1606A16 6÷16

1 016060010
1 016060016

1606A/C9

Pinza per capicorda a tubetto 1606A6
con assortimento di 450 capicorda



1606A/C9

1 016060045

	n.
1606A6	1
BM00601 W/0,5	50
BM00604 N/1,5	100
BM00506 B/2,5	100
BM00508 G/4	100
BM00610 Y/6	100

420x350x35 mm - 2,5 kg



1606T

pinza per capicorda a tubetto,
crimpatura su 4 lati

minore sforzo alla leva



mm^2
0,1÷10

L mm 173
A mm 61
B mm 13

1 016060005

1607

pinza a grande effetto per connettori BNC
per cavi coassiali RG 58, RG 59, RG 62,
RG 71



mm
1607 220

L mm 220
A mm 73
B mm 19

1 016070001

1608

pinza per capicorda preisolati,
con regolatore di pressione

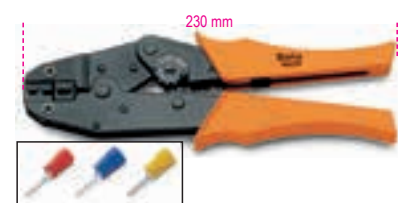

mm^2
0,5÷6

1 016080001





1608/C9

pinza per capicorda 1608
con assortimento di 450 capicorda



1608/C9  1 016080045

1608		n.
BM00180	R/6,3	50
BM00280	B/6,3	50
BM00380	G/6,3	50
BM00191	R/6,3	50
BM00291	B/6,3	50
BM00392	G/6,3	50
BM00160	R/1,6	50
BM00260	B/2,3	50
BM00360	G/3,6	50

 420x350x35 mm -  2 kg

1608A

pinza a grande effetto
per capicorda preisolati



 mm²
0,75÷6  1 016080005



1609

pinza per capicorda non isolati



 mm²
0,5÷2,5  1 016090001

1609A

pinza a grande effetto
per capicorda non isolati



 mm²
0,5÷6  1 016090005

1609B

pinza per capicorda non isolati





L
mm 600  mm²
10÷120  1 016090101



1609C/C5

pinza oleodinamica per capicorda

crimpature esagonali



 mm²
50÷240  1 016090210



 500x300x110 mm -  4 kg

1609M

coppia di matrici per 1609C

crimpature esagonali



	 mm ²	
1609M/16	10-16	1 016090221
1609M/35	25-35	1 016090223
1609M/70	50-70	1 016090225
1609M/120	95-120	1 016090227
1609M/150	150	1 016090229
1609M/185	185	1 016090231
1609M/240	240	1 016090233

1639S

sonda tirafili in nylon

con teste intercambiabili



L
m 10  mm
Ø 4  1 016390010



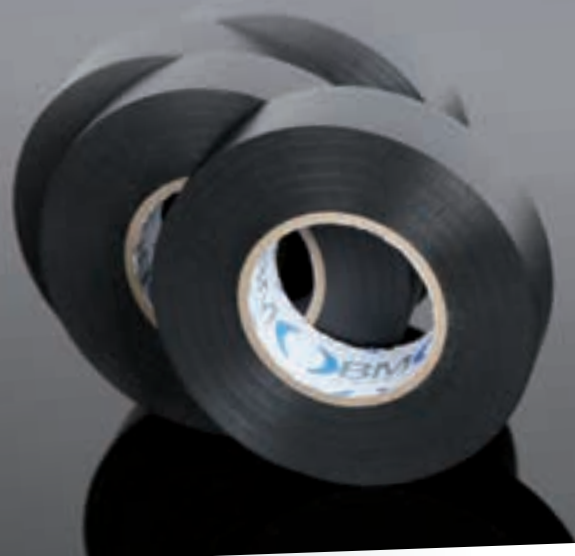
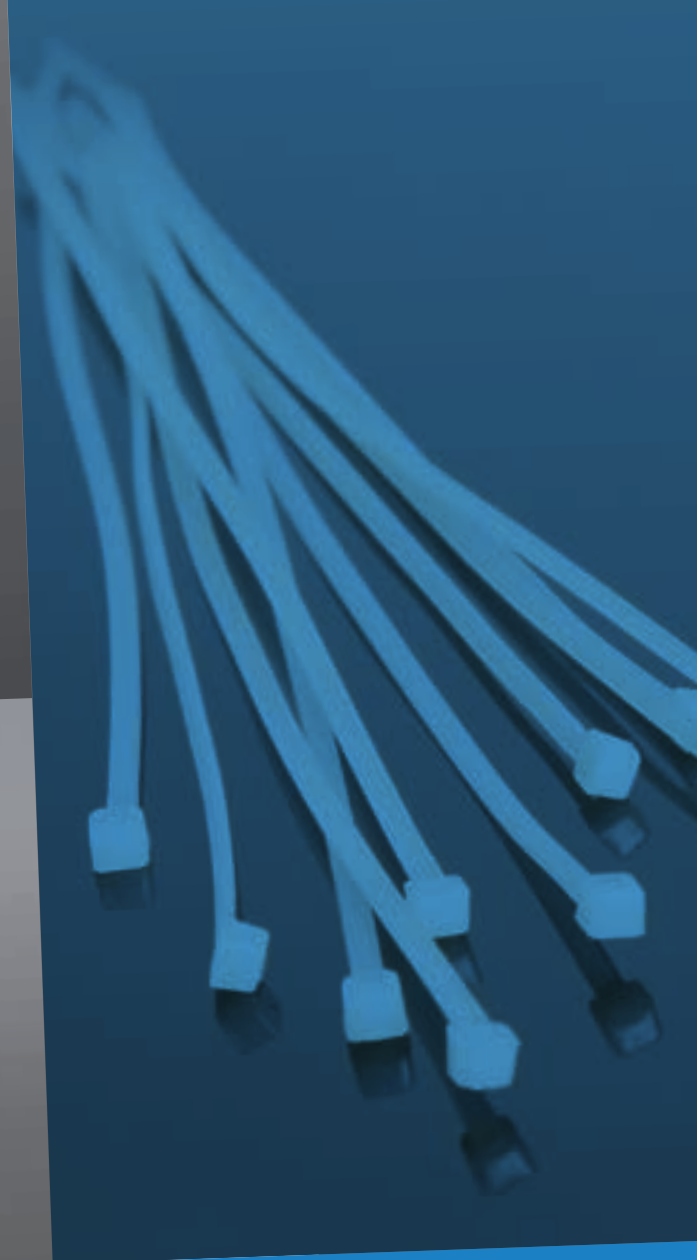
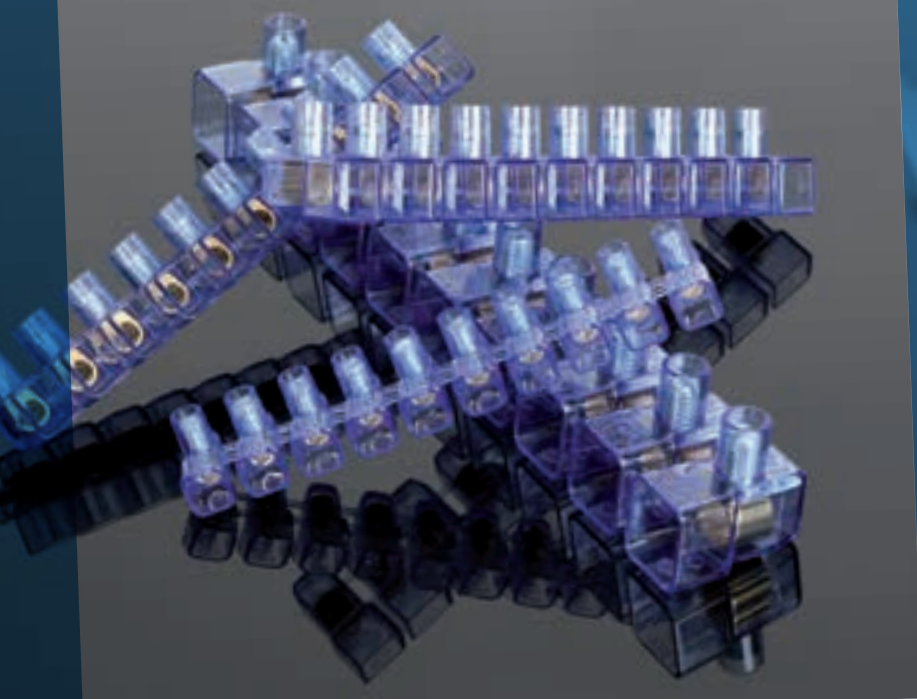

PRODOTTI A MARCHIO BM: TERMINALI, MORSETTIERE, FASCETTE, NASTRI ISOLANTI

BM Group progetta, produce e distribuisce elementi di connessione e prodotti per l'installazione elettrica, dal 1958. Qualità, sicurezza e affidabilità sono da sempre i valori di BM, quei valori che, insieme alla passione per l'eccellenza, hanno portato l'azienda a diventare, passo dopo passo, il punto di riferimento nel mercato del materiale elettrico. Dal 2018 BM Group è parte di Beta Utensili. Un'accurata selezione di prodotti a marchio BM è presentata in questa sezione, ad integrazione della gamma Beta.

QUALITÀ CERTIFICATA



1610-B

terminali preisolati ad occhiello



D mm	mm²	L mm		
4	0,25-1,5	20,6		100 BM00119
5	0,25-1,5	21,8		100 BM00125
5	1,5-2,5	22,4		100 BM00225
6	1,5-2,5	26		100 BM00231
8	1,5-2,5	29,8		100 BM00237
6	4-6	29,1		50 BM00331
8	4-6	34,5		50 BM00337

- indicare nell'ordine il numero di terminali e non di confezioni
- i prezzi indicati sono relativi a 100 pezzi

1614-P

terminali preisolati a puntale

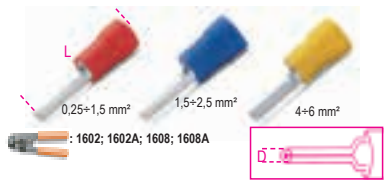

D mm	mm²	L mm		
1,9	0,25-1,5	19		100 BM00151
1,9	1,5-2,5	19		100 BM00251
2,7	4-6	28		50 BM00350

- indicare nell'ordine il numero di terminali e non di confezioni
- i prezzi indicati sono relativi a 100 pezzi

1616-SM

terminali preisolati a spina maschio

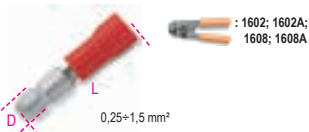

D mm	mm²	L mm		
4	0,25-1,5	21		100 BM00130

- indicare nell'ordine il numero di terminali e non di confezioni
- i prezzi indicati sono relativi a 100 pezzi

1618-SF

terminali preisolati a spina femmina



D mm	mm²	L mm		
3,8	0,25-1,5	23,5		100 BM00140

- indicare nell'ordine il numero di terminali e non di confezioni
- i prezzi indicati sono relativi a 100 pezzi

1620-M

terminali preisolati rapidi maschio

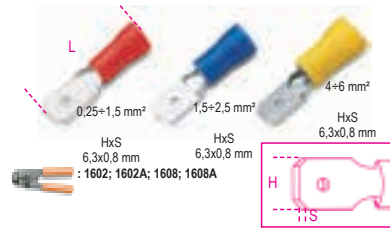

HxS mm	mm²	L mm		
6,3x0,8	0,25-1,5	21		100 BM00180
6,3x0,8	1,5-2,5	21		100 BM00280
6,3x0,8	4-6	24,5		50 BM00380

- indicare nell'ordine il numero di terminali e non di confezioni
- i prezzi indicati sono relativi a 100 pezzi

1622-F

terminali preisolati rapidi femmina



HxS mm	mm²	L mm		
6,3x0,8	0,25-1,5	20,7		100 BM00190
2,8x0,5	0,25-1,5	18,5		100 BM00395
6,3x0,8	1,5-2,5	20,7		100 BM00290
6,3x0,8	4-6	24,5		50 BM00391

- indicare nell'ordine il numero di terminali e non di confezioni
- i prezzi indicati sono relativi a 100 pezzi

1624-FI

terminali rapidi femmina isolati



HxS mm	mm²	L mm		
6,3x0,8	0,25-1,5	22		100 BM00191
6,3x0,8	1,5-2,5	22		50 BM00291
6,3x0,8	4-6	25		50 BM00392

- indicare nell'ordine il numero di terminali e non di confezioni
- i prezzi indicati sono relativi a 100 pezzi

1628-C

connettori di linea preisolati



D mm	mm²	L mm		
1,8	0,25-1,5	25		100 BM00160
2,5	1,5-2,5	26,5		100 BM00260
3,7	4-6	27		50 BM00360

- indicare nell'ordine il numero di terminali e non di confezioni
- i prezzi indicati sono relativi a 100 pezzi

1630-CR

connettori rapidi

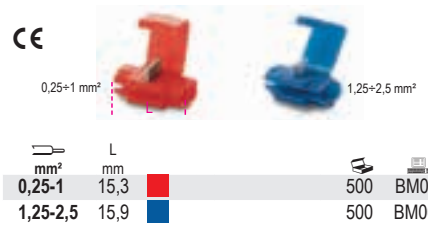

mm²	L mm		
0,25-1	15,3		500 BM00110
1,25-2,5	15,9		500 BM00210

- indicare nell'ordine il numero di terminali e non di confezioni
- i prezzi indicati sono relativi a 100 pezzi

1632-TS

terminali a tubetto singoli



mm²	L mm		
0,5	14		500 BM00601
0,75	14		500 BM00602
1	14		500 BM00603
1,5	14		500 BM00604
2,5	14		250 BM00506
4	17		200 BM00508
6	20		100 BM00610
0,5	14		500 BM00501
0,75	14		500 BM00502
1	14		500 BM00503
1,5	14		500 BM00504
6	20		100 BM00510

- indicare nell'ordine il numero di terminali e non di confezioni
- i prezzi indicati sono relativi a 100 pezzi

1634-TD

terminali a tubetto doppi



mm²	L mm		
2x0,5	15		200 BM00651
2x0,75	15		200 BM00652
2x1	15		200 BM00654
2x1,5	16		200 BM00656
2x2,5	18,5		100 BM00558
2x4	23		100 BM00560
2x6	26		50 BM00661
2X0,5	15		200 BM00551
2X0,75	15		200 BM00552
2X1	15		200 BM00554
2X1,5	16		200 BM00556
2X6	26		50 BM00561

- indicare nell'ordine il numero di terminali e non di confezioni
- i prezzi indicati sono relativi a 100 pezzi



1635-D

morsetti multipli in polipropilene, barrette da 12 poli

Corpo isolante: polipropilene (PP) naturale

Corpo conduttivo: ottone

Vite imperdibile: acciaio zincato

Autoestinguenza: EN 60335-1: 2002+A2:2006 (par. 30.2.3), EN 60695-2-10 a 850°C, EN 60695-2-11

Temperatura d'esercizio: max 85°C

Grado di protezione: IP20

Norme di riferimento: EN 60998-1: 2004, EN 60998-2-1: 2004, EN 60335-1: 2002 + A2: 2006 (par. 30.2.3), IEC/EN 60695-2-11

CE

mm ²	L mm	L1 mm	mm ²		
16	93,7	14,7	2,5	50	BM9200
20,5	116,5	17,2	4	50	BM9201
23,5	139,5	20,1	6	50	BM9202
25,3	175,5	22,5	16	25	BM9203
35,2	228	33,5	25	10	BM9204

1635-S

morsetti di coda per connessioni volanti, barrette da 10 poli

Corpo isolante: policarbonato trasparente UL94 V0

Corpo conduttivo: ottone

Vite imperdibile: acciaio zincato

Autoestinguenza: EN60695-2-10 a 850°C, EN 60335-1:2002

+A2:2006, EN60695-2-11

Temperatura d'esercizio: max 85°C

Grado di protezione: IP20

Norme di riferimento: EN60998-1: EN60998-2-1:2004

mm ²	L mm	L1 mm	S mm	mm ²	N		
1.5	15	7.5	14.5	1.5	2	10	BM991
				0.75	2+4		
2.5	17.5	9	18.2	2.5	2	10	BM992
				1.5	2+3		
				1	2+4		
4	21	10.3	20	4	2	10	BM9924
				2.5	2+3		
				1.5	2+4		
6	22.5	11.8	23	6	2	10	BM993
				4	2+3		
				2.5	2+4		
10	26	14.7	26	10	2	10	BM994
				6	2+3		
				4	2+4		
16	31.8	18.8	32.2	16	2	10	BM995
				10	2+3		
				6	2+4		

i prezzi si riferiscono alla singola barretta

1635-S

mm ²	L mm	L1 mm	S mm	mm ²	N		
25	36.3	22.5	41.9	25	2	25	BM9960
				16	2+3		
				10	2+4		
35	43.5	26.1	49.4	35	2	25	BM9961
				25	2+3		
				16	2+4		



1748-BV2

fascette in nylon, colore naturale

Materiale: Poliammide PA 6.6

Classe di autoestinguenza: UL 94-V2

Temperatura di esercizio: -40°C ÷ +85°C

Temperatura minima d'installazione: -10°C

Resistenza agli agenti chimici: Buona resistenza alle basi, agli olii, ai grassi, ai solventi di cloruro. Limitata resistenza agli acidi. Non resistente ai fenoli

Norme di riferimento: EN 62275:2015-02

Classificazione: tipo 1 (EN); tipo 21 (UL)

CE

A mm	L mm	Ø MAX mm	F MAX N		
2.5	80	14	80	100	BMB0824
2.5	100	20.5	80	100	BMB1025
2.5	120	27	80	100	BMB1225
2.5	160	40	80	100	BMB1625
2.5	200	52.5	80	100	BMB2025
3.6	140	33	180	100	BMB1436
3.6	200	52.5	180	100	BMB2036
3.6	300	106	180	100	BMB2936
3.6	370	105	180	100	BMB3736
4.6	120	24	220	100	BMB1248
4.6	160	36	220	100	BMB1648
4.8	188	46	220	100	BMB1948
4.8	200	50	220	100	BMB2048
4.8	250	65	220	100	BMB2548
4.8	300	81	220	100	BMB3048
4.8	370	103.5	220	100	BMB3748
4.8	390	110	220	100	BMB3948
4.8	430	122.5	220	100	BMB4348
4.8	530	160	220	100	BMB5348
7.6	150	24	550	100	BMB1576
7.6	200	51	550	100	BMB2076
7.6	300	83	550	100	BMB2976
7.6	370	103.5	550	100	BMB3776
7.6	450	130.5	550	100	BMB4576
7.6	540	159	550	100	BMB5476
7.6	750	226	550	100	BMB7576
8.8	550	163.5	800	100	BMB5390
8.8	710	195	800	100	BMB7190
8.8	780	235.5	800	100	BMB7890
9.0	430	130.5	800	100	BMB4390
9.0	810	245	800	100	BMB8190
9.0	1020	295	800	100	BMB1090
9.0	1220	375.5	800	100	BMB1290
9.0	1530	460	800	100	BMB1590

- indicare nell'ordine il numero di fascette e non di confezioni

- i prezzi indicati sono relativi a 100 pezzi

1748V

fascette in nylon, colore verde

Materiale: Poliammide PA 6.6

Classe di autoestinguenza: UL 94-V2

Temperatura di esercizio: -40°C ÷ +85°C

Temperatura minima d'installazione: -10°C

Resistenza agli agenti chimici: Buona resistenza alle basi, agli olii, ai grassi, ai solventi di cloruro. Limitata resistenza agli acidi. Non resistente ai fenoli

Norme di riferimento: EN 62275:2015-02

Classificazione: tipo 1 (EN); tipo 21 (UL)

CE

A mm	L mm	Ø MAX mm	F MAX N		
2.5	100	20.5	80	100	BMV1025
3.6	140	33	180	100	BMV1436
4.8	200	50	220	100	BMV2048
4.8	300	81	220	100	BMV3048

- indicare nell'ordine il numero di fascette e non di confezioni

- i prezzi indicati sono relativi a 100 pezzi

1748N

fascette in nylon, colore nero

UV resistant

Materiale: Poliammide PA 6.6 + carbon black

Classe di autoestinguenza: UL 94-V2

Temperatura di esercizio: -40°C ÷ +85°C

Temperatura minima d'installazione: -10°C

Resistenza agli agenti chimici: Buona resistenza alle basi, agli olii, ai grassi, ai solventi di cloruro. Limitata resistenza agli acidi. Non resistente ai fenoli

Norme di riferimento: EN 62275:2015-02

Classificazione: tipo 1 (EN)

CE

A mm	L mm	Ø mm	F MAX N		
2.5	80	14	80	100	BMN0824
2.5	100	20.5	80	100	BMN1025
2.5	120	27	80	100	BMN1225
2.5	160	40	80	100	BMN1625
2.5	200	52.5	80	100	BMN2025
3.6	140	33	180	100	BMN1436
3.6	200	52.5	180	100	BMN2036
3.6	300	106	180	100	BMN2936
3.6	370	105	180	100	BMN3736
4.6	120	24	220	100	BMN1248
4.6	160	36	220	100	BMN1648
4.8	188	46	220	100	BMN1948
4.8	200	50	220	100	BMN2048
4.8	250	65	220	100	BMN2548
4.8	300	81	220	100	BMN3048
4.8	370	103.5	220	100	BMN3748
4.8	390	110	220	100	BMN3948
4.8	430	122.5	220	100	BMN4348
4.8	530	160	220	100	BMN5348
7.6	150	24	550	100	BMN1576
7.6	200	51	550	100	BMN2076
7.6	300	83	550	100	BMN2976
7.6	370	103.5	550	100	BMN3776
7.6	450	130.5	550	100	BMN4576
7.6	540	159	550	100	BMN5476
7.6	750	226	550	100	BMN7576
8.8	550	163.5	800	100	BMN5390
8.8	710	195	800	100	BMN7190
8.8	780	235.5	800	100	BMN7890
9.0	430	130.5	800	100	BMN4390
9.0	810	245	800	100	BMN8190
9.0	1020	295	800	100	BMN1090
9.0	1220	375.5	800	100	BMN1290
9.0	1530	460	800	100	BMN1590

- indicare nell'ordine il numero di fascette e non di confezioni

- i prezzi indicati sono relativi a 100 pezzi



1748-UL

fascette in nylon, per carichi pesanti,
colore nero

UV and IMPACT resistant

Materiale: Poliammide PA 6.6 + carbon black
Classe di autoestinguenza: UL 94-V2
Temperatura di esercizio: -40°C ÷ +85°C
Temperatura minima d'installazione: -10°C
Resistenza agli agenti chimici: Buona resistenza alle basi, agli olii, ai grassi, ai solventi di cloruro. Limitata resistenza agli acidi. Non resistente ai fenoli
Norme di riferimento: EN 62275:2015-02
Classificazione: tipo 1 (EN); tipo 21 (UL)

CE

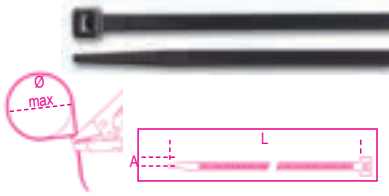

A	L	Ø MAX	F MAX		
mm	mm	mm	N		
12.4	230	57	1200	100	BMN2412
12.4	480	136.5	1200	100	BMN4912
12.4	730	216.1	1200	100	BMN7412
12.4	880	263.9	1200	100	BMN8912
12.4	1000	305	1200	100	BMN1012

- indicare nell'ordine il numero di fascette e non di confezioni
- i prezzi indicati sono relativi a 100 pezzi

1748-N2D

fascette in nylon,
colore nero
UV resistant

Materiale: Poliammide PA 6.6 + carbon black
Classe di autoestinguenza: UL 94-V2
Temperatura di esercizio: -40°C ÷ +85°C
Temperatura minima d'installazione: -10°C
Resistenza agli agenti chimici: Buona resistenza alle basi, agli olii, ai grassi, ai solventi di cloruro. Limitata resistenza agli acidi. Non resistente ai fenoli
Norme di riferimento: EN 62275:2015-02
Classificazione: tipo 1 (EN)

CE



A	L	Ø MAX	F MAX		
mm	mm	mm	N		
9.0	180	40	400	100	BMN1890
9.0	265	62	540	100	BMN2690
9.0	360	93	540	100	BMN3690

- indicare nell'ordine il numero di fascette e non di confezioni
- i prezzi indicati sono relativi a 100 pezzi



1748-BV0

fascette in nylon autoestinguente,
colore bianco

Materiale: Poliammide PA 6.6
Classe di autoestinguenza: UL 94-V0
Temperatura di esercizio: -40°C ÷ +85°C
Temperatura minima d'installazione: -10°C
Resistenza agli agenti chimici: Buona resistenza alle basi, agli olii, ai grassi, ai solventi di cloruro. Limitata resistenza agli acidi. Non resistente ai fenoli
Norme di riferimento: EN 62275:2015-02
Classificazione: tipo 1 (EN)

CE V0

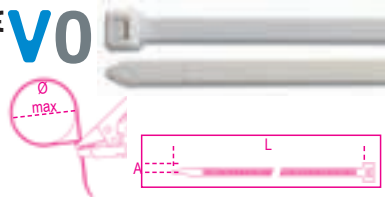

A	L	Ø MAX	F MAX		
mm	mm	mm	N		
2.5	100	20.5	80	100	BMB1025V0
3.6	150	36.0	180	100	BMB1536V0
3.6	200	52.5	180	100	BMB2036V0
4.8	200	49.5	230	100	BMB2048V0
4.8	300	81.0	230	100	BMB3048V0
4.8	370	106.7	230	100	BMB3848V0
7.6	370	106.7	540	100	BMB3876V0

- indicare nell'ordine il numero di fascette e non di confezioni
- i prezzi indicati sono relativi a 100 pezzi

1748-BX

fascette in nylon,
colore blu,
rilevabile da metal detector

Materiale: Poliammide PA 6.6 + polvere metallica
Classe di autoestinguenza: UL 94-V2
Temperatura di esercizio: -40°C ÷ +85°C
Temperatura minima d'installazione: -10°C
Resistenza agli agenti chimici: Buona resistenza alle basi, agli olii, ai grassi, ai solventi di cloruro. Limitata resistenza agli acidi. Non resistente ai fenoli
Norme di riferimento: EN 62275:2015-02
Classificazione: tipo 1 (EN)

CE



A	L	Ø MAX	F MAX		
mm	mm	mm	N		
2.5	100	20.5	80	100	BMBX1025
3.6	150	36.0	180	100	BMBX1536
3.6	200	52.5	180	100	BMBX2036
4.8	200	49.5	230	100	BMBX2048
4.8	300	81.0	230	100	BMBX3048
4.8	370	106.7	230	100	BMBX3848
7.6	370	106.7	540	100	BMBX3876

- indicare nell'ordine il numero di fascette e non di confezioni
- i prezzi indicati sono relativi a 100 pezzi

1748-BL

fascette in nylon con dente in acciaio,
colore naturale

Materiale: Poliammide PA 6.6 + acciaio
Classe di autoestinguenza: UL 94-V2
Temperatura di esercizio: -40°C ÷ +85°C
Temperatura minima d'installazione: -10°C
Resistenza agli agenti chimici: Buona resistenza alle basi, agli olii, ai grassi, ai solventi di cloruro. Limitata resistenza agli acidi. Non resistente ai fenoli
Norme di riferimento: EN 62275:2015-02
Classificazione: tipo 1 (EN)

CE

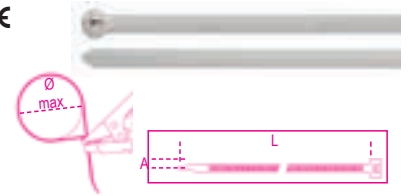

A	L	Ø MAX	F MAX		
mm	mm	mm	N		
2.5	100	20.5	180	100	BMBL1025
2.5	200	52.5	180	100	BMBL2025
3.6	140	33.0	250	100	BMBL1436
4.8	200	49.5	360	100	BMBL2048
4.8	300	81.0	360	100	BMBL3048
4.8	370	103.5	360	100	BMBL3748
7.6	370	103.5	780	100	BMBL3776

- indicare nell'ordine il numero di fascette e non di confezioni
- i prezzi indicati sono relativi a 100 pezzi

1748-NL

fascette in nylon con dente in acciaio,
colore nero,
UV resistant

Materiale: Poliammide PA 6.6 + acciaio + carbon black
Classe di autoestinguenza: UL 94-V2
Temperatura di esercizio: -40°C ÷ +85°C
Temperatura minima d'installazione: -10°C
Resistenza agli agenti chimici: Buona resistenza alle basi, agli olii, ai grassi, ai solventi di cloruro. Limitata resistenza agli acidi. Non resistente ai fenoli
Norme di riferimento: EN 62275:2015-02
Classificazione: tipo 1 (EN)

CE



A	L	Ø MAX	F MAX		
mm	mm	mm	N		
2.5	100	20.5	180	100	BMNL1025
2.5	200	52.5	180	100	BMNL2025
3.6	140	33.0	250	100	BMNL1436
4.8	200	49.5	360	100	BMNL2048
4.8	300	81.0	360	100	BMNL3048
4.8	370	103.5	360	100	BMNL3748
7.6	370	103.5	780	100	BMNL3776

- indicare nell'ordine il numero di fascette e non di confezioni
- i prezzi indicati sono relativi a 100 pezzi



1748-BR

fascette in nylon riutilizzabili,
colore naturale

Materiale: Poliammide PA 6.6
Classe di autoestinguenza: UL 94-V2
Temperatura di esercizio: -40°C ÷ +85°C
Temperatura minima d'installazione: -10°C
Resistenza agli agenti chimici: Buona resistenza alle basi, agli olii, ai grassi, ai solventi di cloruro. Limitata resistenza agli acidi. Non resistente ai fenoli
Norme di riferimento: EN 62275:2015-02
Classificazione: tipo 1 (EN); tipo 21 (UL)

CE

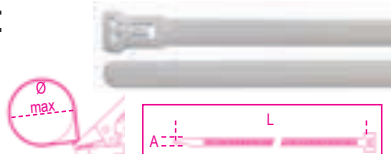

FILE N° E223175

A	L	Ø MAX	F MAX		
mm	mm	mm	N		
7.6	150	40	230	100	BMBR1576
7.6	200	55	230	100	BMBR2076
7.6	300	82	230	100	BMBR3076

- indicare nell'ordine il numero di fascette e non di confezioni
- i prezzi indicati sono relativi a 100 pezzi

1748-BH

fascette in nylon con occhio,
colore naturale

Materiale: Poliammide PA 6.6
Classe di autoestinguenza: UL 94-V2
Temperatura di esercizio: -40°C ÷ +85°C
Temperatura minima d'installazione: -10°C
Resistenza agli agenti chimici: Buona resistenza alle basi, agli olii, ai grassi, ai solventi di cloruro. Limitata resistenza agli acidi. Non resistente ai fenoli
Norme di riferimento: EN 62275:2015-02
Classificazione: tipo 1 (EN); tipo 21 (UL)

CE



FILE N° E223175

A	L	Ø MAX	F MAX		
mm	mm	mm	N		
2.5	110	19.0	80	100	BMBH1125
4.8	200	49.8	230	100	BMBH2048
7.6	305	78.7	550	100	BMBH3076

- indicare nell'ordine il numero di fascette e non di confezioni
- i prezzi indicati sono relativi a 100 pezzi

1748-BP

fascette in nylon ad inserzione,
colore naturale

Materiale: Poliammide PA 6.6
Classe di autoestinguenza: UL 94-V2
Temperatura di esercizio: -40°C ÷ +85°C
Temperatura minima d'installazione: -10°C
Resistenza agli agenti chimici: Buona resistenza alle basi, agli olii, ai grassi, ai solventi di cloruro. Limitata resistenza agli acidi. Non resistente ai fenoli
Norme di riferimento: EN 62275:2015-02
Classificazione: tipo 1 (EN); tipo 21 (UL)

CE

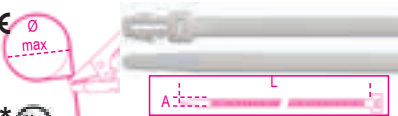

FILE N° E223175

A	L	Ø MAX	F MAX		
mm	mm	mm	N		
3.6	155	37.9	180	100	BMBP1536
4.8	200	50.8	230	100	BMBP2048

- indicare nell'ordine il numero di fascette e non di confezioni
- i prezzi indicati sono relativi a 100 pezzi

1748-BT

fascette in nylon con targhetta trasversale
25x8mm,
colore naturale

Materiale: Poliammide PA 6.6
Classe di autoestinguenza: UL 94-V2
Temperatura di esercizio: -40°C ÷ +85°C
Temperatura minima d'installazione: -10°C
Resistenza agli agenti chimici: Buona resistenza alle basi, agli olii, ai grassi, ai solventi di cloruro. Limitata resistenza agli acidi. Non resistente ai fenoli
Norme di riferimento: EN 62275:2015-02
Classificazione: tipo 1 (EN); tipo 21 (UL)

CE



FILE N° E223175

A	L	Ø MAX	F MAX		
mm	mm	mm	N		
2.5	100	22.0	80	100	BMBT21025
2.5	200	53.5	80	100	BMBT22025

- indicare nell'ordine il numero di fascette e non di confezioni
- i prezzi indicati sono relativi a 100 pezzi

1748-BT2

fascette in nylon con targhetta longitudinale
13x27mm,
colore naturale

Materiale: Poliammide PA 6.6
Classe di autoestinguenza: UL 94-V2
Temperatura di esercizio: -40°C ÷ +85°C
Temperatura minima d'installazione: -10°C
Resistenza agli agenti chimici: Buona resistenza alle basi, agli olii, ai grassi, ai solventi di cloruro. Limitata resistenza agli acidi. Non resistente ai fenoli
Norme di riferimento: EN 62275:2015-02
Classificazione: tipo 1 (EN)

CE



A	L	Ø MAX	F MAX		
mm	mm	mm	N		
4.8	190	51	230	100	BMBT12248

- indicare nell'ordine il numero di fascette e non di confezioni
- i prezzi indicati sono relativi a 100 pezzi

1748-BT3

fascette in nylon con targhetta esterna
20x9mm,
colore naturale

Materiale: Poliammide PA 6.6
Classe di autoestinguenza: UL 94-V2
Temperatura di esercizio: -40°C ÷ +85°C
Temperatura minima d'installazione: -10°C
Resistenza agli agenti chimici: Buona resistenza alle basi, agli olii, ai grassi, ai solventi di cloruro. Limitata resistenza agli acidi. Non resistente ai fenoli
Norme di riferimento: EN 62275:2015-02
Classificazione: tipo 1 (EN)

CE



A	L	Ø MAX	F MAX		
mm	mm	mm	N		
2.5	110	22	80	100	BMBT11125

- indicare nell'ordine il numero di fascette e non di confezioni
- i prezzi indicati sono relativi a 100 pezzi

1748-BA1

basette di fissaggio

Materiale: Poliammide PA 6.6
Classe di autoestinguenza: UL 94-V2
Temperatura di esercizio: -40°C ÷ +85°C
Temperatura minima d'installazione: -10°C
Resistenza agli agenti chimici: Buona resistenza alle basi, agli olii, ai grassi, ai solventi di cloruro. Limitata resistenza agli acidi. Non resistente ai fenoli



SxDxH	Ø	F		
mm	mm	mm		
15.2x9.4x6.8	3.3	3.6	100	BMB0905
22x16.2x10.8	5.2	9	100	BMB0906

- indicare nell'ordine il numero di basette e non di confezioni
- i prezzi indicati sono relativi a 100 pezzi

1748-NA1

basette di fissaggio

Materiale: Poliammide PA 6.6
Classe di autoestinguenza: UL 94-V2
Temperatura di esercizio: -40°C ÷ +85°C
Temperatura minima d'installazione: -10°C
Resistenza agli agenti chimici: Buona resistenza alle basi, agli olii, ai grassi, ai solventi di cloruro. Limitata resistenza agli acidi. Non resistente ai fenoli



SxDxH	Ø	F		
mm	mm	mm		
15.2x9.4x6.8	3.3	3.6	100	BMN0905
22x16.2x10.8	5.2	9	100	BMN0906

- indicare nell'ordine il numero di basette e non di confezioni
- i prezzi indicati sono relativi a 100 pezzi



1748-BA2

basette di fissaggio bidirezionali

Materiale: Poliammide PA 6.6

Classe di autoestinguenza: UL 94-V2

Temperatura di esercizio: -40°C ÷ +85°C

Temperatura minima d'installazione: -10°C

Resistenza agli agenti chimici: Buona resistenza alle basi, agli olii, ai gras-si, ai solventi di cloruro. Limitata resistenza agli acidi. Non resistente ai fenoli

CE

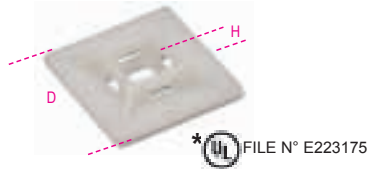

SxDxH mm	F mm		
19x19x5.4	3.6	100	BMB0901
* 28x28x7	4.8	100	BMB0902
* 28x28x5.8	4.8	100	BMB0903

- indicare nell'ordine il numero di basette e non di confezioni

- i prezzi indicati sono relativi a 100 pezzi

1748-NA2

basette di fissaggio bidirezionali

UV resistant

Materiale: Poliammide PA 6.6

Classe di autoestinguenza: UL 94-V2

Temperatura di esercizio: -40°C ÷ +85°C

Temperatura minima d'installazione: -10°C

Resistenza agli agenti chimici: Buona resistenza alle basi, agli olii, ai gras-si, ai solventi di cloruro. Limitata resistenza agli acidi. Non resistente ai fenoli

CE



SxDxH mm	F mm		
19x19x5.4	3.6	100	BMN0901
* 28x28x7	4.8	100	BMN0902
* 28x28x5.8	4.8	100	BMN0903

- indicare nell'ordine il numero di basette e non di confezioni

- i prezzi indicati sono relativi a 100 pezzi

1748-S

fascette autobloccanti in acciaio inossidabile

Materiale: acciaio inox AISI 304

Dispositivo di fissaggio: a sfera

Classe di autoestinguenza: non infiammabile

Plenum rating: AH-1

Resistenza ai raggi UV: eccellente

Temperatura di esercizio: -60°C ÷ +300°C

Temperatura minima d'installazione: -60°C

Resistenza agli agenti chimici: eccellente

Norme di riferimento: EN 62275:2015-02

Classificazione: tipo 2 (EN); tipo 2 (UL)

CE

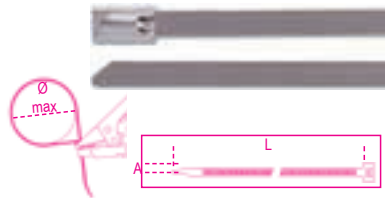

A mm	L mm	ØMAX mm	Trazione N		
4.6	125	38	890	100	BMS1345
4.6	200	61.9	890	100	BMS2045
7.9	200	61.9	1500	100	BMS2079
4.6	290	90.6	890	100	BMS3045
7.9	300	90.6	1500	100	BMS3079
4.6	360	112.8	890	100	BMS3745
7.9	360	112.8	1500	100	BMS3779
7.9	520	163.8	1500	100	BMS5079
4.6	520	163.8	890	100	BMS5245
4.6	680	214.8	890	100	BMS6845
7.9	680	214.8	1500	100	BMS6879
4.6	840	265.7	890	100	BMS8445
7.9	840	265.7	1500	100	BMS8479

- indicare nell'ordine il numero di fascette e non di confezioni

- i prezzi indicati sono relativi a 100 pezzi

1748-SC

fascette autobloccanti in acciaio inossidabile, rivestimento in poliesteri nero

Materiale: acciaio inox AISI 304 + poliesteri

Dispositivo di fissaggio: a sfera

Classe di autoestinguenza: non infiammabile

Plenum rating: AH-1

Resistenza ai raggi UV: eccellente

Temperatura di esercizio: -60°C ÷ +300°C

Temperatura minima d'installazione: -60°C

Resistenza agli agenti chimici: eccellente

Norme di riferimento: EN 62275:2015-02

Classificazione: tipo 2 (EN); tipo 2 (UL)

CE

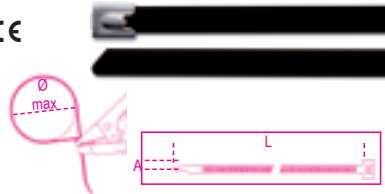

A mm	L mm	ØMAX mm	Trazione N		
4.6	125	38	450	100	BMSC1345
4.6	200	61.9	450	100	BMSC2045
7.9	200	61.9	800	100	BMSC2079
4.6	290	90.6	450	100	BMSC3045
7.9	300	90.6	800	100	BMSC3079
4.6	360	112.8	450	100	BMSC3745
7.9	360	112.8	800	100	BMSC3779
7.9	520	163.8	800	100	BMSC5079
4.6	520	163.8	450	100	BMSC5245
4.6	680	214.8	450	100	BMSC6845
7.9	680	214.8	800	100	BMSC6879
4.6	840	265.7	450	100	BMSC8445
7.9	840	265.7	800	100	BMSC8479

- indicare nell'ordine il numero di fascette e non di confezioni

- i prezzi indicati sono relativi a 100 pezzi

1748-BV

fascette in velcro, riapribili a strappo colore bianco

Materiale: polietilene-poliammide (PE-PA)

Temperatura di esercizio: da -20°C a +60°C

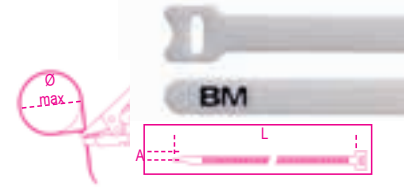

A mm	L mm	Ø MAX mm	F MAX N		
12,7	229	55	180	10	BMBV2312
19	229	55	220	10	BMBV2319

- indicare nell'ordine il numero di fascette e non di confezioni

- i prezzi indicati sono relativi a 100 pezzi

1748-NV

fascette in velcro, riapribili a strappo colore nero

Materiale: polietilene-poliammide (PE-PA)

Temperatura di esercizio: da -20°C a +60°C



A mm	L mm	Ø MAX mm	F MAX N		
12,7	229	55	180	10	BMNV2312

- indicare nell'ordine il numero di fascette e non di confezioni

- i prezzi indicati sono relativi a 100 pezzi

1743

pinza per fascette in Nylon

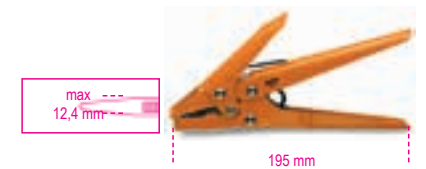

1743 1 017430001

1743T

pinza tagliafascette

• Adatta anche per il taglio di piccoli cavi (3x1.5mm²; 1x17mm²)



1743T 1 017430100

Beta

Beta
QUALITY TOOLS

1748-N

pinze per fascette in nylon con larghezza da 2.5 a 4.8 mm

Taglio automatico al raggiungimento della tensione impostata.
Dotata di regolazione della tensione di serraggio

Materiale: struttura in polimero e fibra di vetro, parti interne in metallo



1748-N 1 BM1100

1748-ST

pinze automatiche per fascette in acciaio inossidabile, per fascette con larghezza fino a 7,9mm e spessore fino a 0,35mm.

Taglio automatico al raggiungimento della tensione impostata.
Tensione di serraggio regolabile su 4 livelli

Materiale: in metallo con struttura in alluminio



1748-ST 1 BM1105

1638M

Guaine termorestringenti basso spessore, in minibox

Rapporto di restringimento: 2:1

Materiale: polietilene

Temperatura di esercizio: da -55°C a +125°C max

Temperatura di restringimento: da +70°C a +110°C

VRMS massima: 600 V

Grado di autoestinguenza della guaina: ritardante di fiamma

VW-1 (UL 1581)

Privo di alogeni



L	Ø1	Ø2		
mm	mm	mm	mm	mm
1,6	12	2,0+0,-0,30,85	1	BMGBS016MNE
2,4	11	3,00+0,-0,311,25	1	BMGBS024MNE
3,2	11	3,5+0,-0,4 1,5	1	BMGBS032MNE
4,8	10	5,5+0,-0,4 2,5	1	BMGBS048MNE
6,4	9	6,5+0,-0,4 3	1	BMGBS064MNE
9,5	7	9,5+0,-0,5 4,5	1	BMGBS095MNE
12,7	6	13,5+0,-0,5 6,5	1	BMGBS127MNE
19	5	21+0,-0,5 10	1	BMGBS190MNE
25,4	3,5	26,0+0,-0,512,5	1	BMGBS254MNE

1639ESB

nastro isolante in PVC

Temperatura d'esercizio: 0-90°C

Carico di rottura: 28N/cm equivalente a 18.6 N/mm²

Allungamento a rottura: 200%

Adesione all'acciaio: 2.2N/cm

Adesione al dorso: 2 N/cm

Rigidità dielettrica: 45kV/mm

Infiammabilità: ritardante la fiamma

Norme di riferimento: IEC 60454-2

Classificazione: CEI EN 60454-3-1-5/F-PVCP/90



S	A	L		
mm	mm	m		
0.15	15	10	10	BMESB1510BI
0.15	15	10	10	BMESB1510BL
0.15	15	10	10	BMESB1510GI
0.15	15	10	10	BMESB1510GR
0.15	15	10	10	BMESB1510GV
0.15	15	10	10	BMESB1510MA
0.15	15	10	10	BMESB1510NE
0.15	15	10	10	BMESB1510RO
0.15	15	10	10	BMESB1510VE
0.15	15	25	10	BMESB1525BI
0.15	15	25	10	BMESB1525BL
0.15	15	25	10	BMESB1525GI
0.15	15	25	10	BMESB1525GR
0.15	15	25	10	BMESB1525GV
0.15	15	25	10	BMESB1525MA
0.15	15	25	10	BMESB1525NE
0.15	15	25	10	BMESB1525RO
0.15	15	25	10	BMESB1525VE
0.15	19	25	10	BMESB1925BI
0.15	19	25	10	BMESB1925BL
0.15	19	25	10	BMESB1925GI
0.15	19	25	10	BMESB1925GR
0.15	19	25	10	BMESB1925GV
0.15	19	25	10	BMESB1925MA
0.15	19	25	10	BMESB1925NE
0.15	19	25	10	BMESB1925RO
0.15	19	25	10	BMESB1925VE
0.15	25	25	8	BMESB2525BI
0.15	25	25	8	BMESB2525BL
0.15	25	25	8	BMESB2525GI
0.15	25	25	8	BMESB2525GR
0.15	25	25	8	BMESB2525GV
0.15	25	25	8	BMESB2525MA
0.15	25	25	8	BMESB2525NE
0.15	25	25	8	BMESB2525RO
0.15	25	25	8	BMESB2525VE
0.15	50	25	4	BMESB5025NE

I prezzi si riferiscono al singolo nastro

1639ESC

nastro isolante in PVC

Temperatura d'esercizio: 0-80°C

Carico di rottura: 28N/cm equivalente a 18.6 N/mm²

Allungamento a rottura: 200%

Adesione all'acciaio: 2.2N/cm

Adesione al dorso: 2.2 N/cm

Rigidità dielettrica: 38kV/mm

Infiammabilità: ritardante la fiamma

Norme di riferimento: ASTM-D-1000 ; UL510

Classificazione: CEI EN 60454-3-1-5/F-PVCP/90



S	A	L		
mm	mm	m		
0.18	19	20	10	BMESB1920NE

I prezzi si riferiscono al singolo nastro

1639ETA

nastro isolante in PVC per temperature estreme

Temperatura d'esercizio: -18 ÷ +105°C

Carico di rottura: 35N/cm equivalente a 19.4 N/mm²

Allungamento a rottura: 300%

Adesione all'acciaio: 3.1N/cm

Adesione al dorso: 2.7 N/cm

Rigidità dielettrica: 55.5kV/mm

Infiammabilità: ritardante la fiamma

Norme di riferimento: ASTM-D-1000 ; UL510

Classificazione: CEI EN 60454-3-1-5/F-PVCP/90



S	A	L		
mm	mm	m		
0.18	19	20	1	BMETA1920NE

1639EAB

nastro isolante autoagglomerante a base di EPR

Temperatura d'esercizio: -40 ÷ +90°C

Carico di rottura: 2.4 N/mm²

Allungamento a rottura: 750%

Rigidità dielettrica: 29.5kV/mm

Infiammabilità: ritardante la fiamma

Norme di riferimento: ASTM-D-4388; ASTM-D-4325

Eccellente resistenza a: umidità, corrosione e agenti chimici



S	A	L		
mm	mm	m		
0.76	19	9	1	BMEAB1909NE





GAMMA BLISTER

Per la tua vendita
a libero servizio!

- **Efficienza espositiva**
- **Migliore visibilità**
- **Codice a barre**



SUPPORTO BLISTER:

- PVC Antistrappo
- 4 formati
- Sistema di fissaggio di nuova generazione con fascetta elastica

42K



mm		
5,5x5,5	5	000429505
6x6	5	000429506
7x7	5	000429507
8x8	5	000429508
9x9	5	000429509
10x10	5	000429510
11x11	5	000429511
12x12	5	000429512
13x13	5	000429513
14x14	5	000429514
15x15	5	000429515
16x16	5	000429516
17x17	5	000429517
18x18	5	000429518
19x19	5	000429519
20x20	3	000429520
21x21	3	000429521
22x22	3	000429522
23x23	3	000429523
24x24	3	000429524
25x25	2	000429525
26x26	2	000429526
27x27	2	000429527
28x28	2	000429528
29x29	2	000429529
30x30	2	000429530
32x32	2	000429532

55K



mm		
6x7	5	000559012
8x9	5	000559021
10x11	5	000559030
10x12	5	000559033
10x13	5	000559035
12x13	5	000559042
12x14	5	000559045
13x17	5	000559051
14x15	5	000559054
14x17	5	000559057
16x17	5	000559060
17x19	2	000559063
18x19	2	000559066
19x22	2	000559069
20x22	2	000559075
21x23	2	000559078
22x24	2	000559081
24x26	2	000559087
24x27	2	000559090
25x28	2	000559096
27x29	2	000559099
27x30	2	000559102
30x32	2	000559108

90K



mm		
6x7	5	000909006
8x9	5	000909012
10x11	5	000909018
12x13	5	000909027
14x15	5	000909033
16x17	5	000909039
18x19	5	000909045
20x22	3	000909051
21x23	2	000909057
24x26	2	000909063
24x27	2	000909067

mm		
25x28	2	000909070
27x29	2	000909073
30x32	2	000909080

93K



mm		
21x22	3	000939021

94K



mm		
8x10	2	000949008
9x11	2	000949009
10x11	2	000949010
11x13	2	000949011
12x14	2	000949012
13x15	2	000949013
14x15	2	000949014
14x17	2	000949015
17x19	2	000949017
19x22	2	000949019
22x24	2	000949022
24x27	2	000949024
30x32	2	000949030

96/SC9



96/SC9	1	000960374
1,5-2-2,5-3-4-5-6-8-10 mm		

96/ST6K



96/ST6K	3	000969370
2,5-3-4-5-6-8 mm		

96N/ST6K



96N/ST6K	3	000969640
2,5-3-4-5-6-8 mm		

96BPA/SC9



96BPA/SC9	1	000961974
1,5-2-2,5-3-4-5-6-8-10 mm		

96BP-CL/SC9



96BP-CL/SC9	1	000961619
1,5-2-2,5-3-4-5-6-8-10 mm		

96BPC/SC9



96BPC/SC9	1	000960354
1,5-2-2,5-3-4-5-6-8-10 mm		

96C/AS



"		
1/16	20	000961702
3/32	20	000961706
1/8	20	000961710
5/32	20	000961714
3/16	20	000961716
7/32	20	000961718
1/4	20	000961720
5/16	10	000961724
3/8	10	000961728

96LBP/SC9



96LBP/SC9	1	000961354
1,5-2-2,5-3-4-5-6-8-10 mm		

96/BGS7



96/BGS7
1,5-2-2,5-3-4-5-6 mm

1 000960367

96/BG7



96/BG7
2,5-3-4-5-6-8-10 mm

1 000960368

96TK



mm	Q	Art.
2	5	000969934
2,5	5	000969935
3	5	000969936
4	5	000969938
5	5	000969940
6	5	000969941
8	3	000969943
10	3	000969945

97BTX/SC8



97BTX/SC8
T9-T10-T15-T20-T25-T27-T30-T40

1 000970164

97BTXL/SC8



97BTXL/SC8
T9-T10-T15-T20-
T25-T27-T30-T40

1 000970364

111E



L mm	Q	Art.
100	3	001110110
150	3	001110115
200	3	001110120
250	3	001110125
300	3	001110130
380	3	001110138
450	2	001110145
600	1	001110160

111EN



L mm	Q	Art.
100	3	001110410
150	3	001110415
200	3	001110420
250	3	001110425
300	3	001110430
380	3	001110438
450	2	001110445

111ER



L mm	Q	Art.
200	3	001110520
250	3	001110525
300	2	001110530

123/K4



123/K4 1 001230504

142K



mm	Q	Art.
6	3	001429006
7	3	001429007
8	3	001429008
9	3	001429009
10	3	001429010
11	3	001429011
12	3	001429012
13	3	001429013
14	2	001429014
15	2	001429015
16	2	001429016
17	2	001429017
18	2	001429018
19	2	001429019
21	1	001429021
22	1	001429022
24	1	001429024

192/S2



192/S2 1 001920070
8x10/12x13 mm
16x17/18x19 mm

195K



mm	Q	Art.
8x10	2	001959010
12x13	2	001959013
14x15	2	001959015
16x18	2	001959018
17x19	2	001959019

374K



374K 1 003749024
L mm 240



850MQ



L mm	1	008500910
233		

855P



L1 mm	1	008550010
240		

860/58K



L mm	1	008609884
126		

860LP



SxA mm	5	008600005
0,5x3		
0,6x4,5		008600010
0,8x5,5		008600015
1x5,5		008600020
1,2x6,5		008600025

860PH



PH	5	008600220
0		
1		008600225
2		008600230
3		008600245
4		008600250

860PZ



PZ	5	008600320
1		
2		008600325
3		008600330
4		008600335

860PE



mm	5	008600101
2		
2,5		008600102
3		008600103
4		008600104
5		008600105
6		008600106
8		008600108
10		008600110

860TX



mm	5	008600704
T6		
T7		008600705
T8		008600710
T9		008600715
T10		008600720
T15		008600725
T20		008600730
T25		008600735
T27		008600740
T30		008600745
T40		008600750

860RTX



mm	5	008600550
T9		
T10		008600555
T15		008600560
T20		008600565
T25		008600570
T27		008600575
T30		008600580
T40		008600585

860/C27

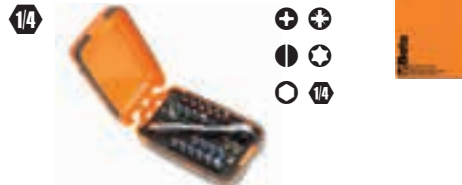

860/C27	1	008600880

860MIX/A10



860MIX/A10	1	008600900

860TX/A10



860TX/A10	1	008600970

860MIX/A31



860MIX/A31	1	008600902

862F/A7



862F/A7	1	008620950

900K



mm	10	009009040
4		
4,5		009009045
5		009009050
5,5		009009055
6		009009060
7		009009070
8		009009080
9		009009090
10		009009100
11		009009110
12		009009120
13		009009130
14		009009140

900/20LK



L mm	5	009009819
100		

900/25K

1/4"



L mm	5	009009830
41	5	009009830

900BG/30K

1/4"



L mm	5	009009834
128	5	009009834

900/55K

3/8"

1/4"



L mm	5	009009870
125	5	009009870

900/55ZK

3/8"

1/4"



L mm	3	009009882
125	3	009009882

900/58K

1/4"



L mm	2	009009884
126	2	009009884

910AK

3/8"



mm	5	009109006
6	5	009109006
7	5	009109007
8	5	009109008
9	5	009109009
10	5	009109010
11	5	009109011
12	5	009109012
13	5	009109013
14	5	009109014
15	5	009109015
16	5	009109016
17	5	009109017
18	5	009109018
19	5	009109019
20	5	009109020
21	5	009109021
22	5	009109022

910/21K

3/8"



L mm	5	009109822
125	5	009109822

910/25K

3/8"



L mm	5	009109830
54,6	5	009109830

910/55K

7/2"

3/8"



L mm	3	009109882
200	3	009109882

910/58K

3/8"



L mm	1	009109884
222	1	009109884

920AK

1/2"



mm	10	009209010
10	10	009209010
11	10	009209011
12	10	009209012
13	10	009209013
14	10	009209014
15	10	009209015
16	10	009209016
17	10	009209017
18	10	009209018
19	10	009209019
20	5	009209020
21	5	009209021
22	5	009209022
23	5	009209023
24	5	009209024
25	5	009209025
26	5	009209026
27	5	009209027
28	5	009209028
29	5	009209029
30	5	009209030
32	5	009209032

920/21K

1/2"



L mm	5	009209822
125	5	009209822

920/25K

1/2"



L mm	5	009209830
75	5	009209830

920/55K

7/2"

1/2"



L mm	3	009209882
275	3	009209882

920/58K

1/2"



L mm	1	009209926
281	1	009209926

935K



mm	5	009359105
6x7	5	009359105
8x9	5	009359111
10x11	5	009359115
12x13	5	009359117
14x15	5	009359126
16x17	5	009359128
18x19	5	009359131
20x22	3	009359138

937K



mm	5	009379006
6x6	5	009379006
7x7	5	009379007
8x8	5	009379008
9x9	5	009379009
10x10	5	009379010
11x11	5	009379011
12x12	5	009379012
13x13	5	009379013
14x14	5	009379014
15x15	5	009379015
16x16	5	009379016
17x17	5	009379017
18x18	5	009379018
19x19	5	009379019
20x20	5	009379020
21x21	3	009379021
22x22	3	009379022

943BKK



mm	Hand	Part No.
5,5	5	009439005
6	5	009439006
7	5	009439007
8	5	009439008
10	3	009439010
13	3	009439013

951K



mm	Hand	Part No.
2	5	009519521
2,5	5	009519525
3	5	009519530
3,5	5	009519535
4	5	009519540
4,5	5	009519545
5	5	009519550
6	5	009519560
8	5	009519580
10	5	009519610

1032K



L mm	Hand	Part No.
140x0,9	5	010329013
140x1,3	5	010329014
180	5	010329017

1033K



L mm	Hand	Part No.
140x0,9	5	010339013
140x1,3	5	010339014
180	5	010339017

1034K



L mm	Hand	Part No.
130x0,9	5	010349013
130x1,3	5	010349014
170	5	010349017

1036K



L mm	Hand	Part No.
140x0,9	5	010369013
140x1,3	5	010369014
175	5	010369017

1037K



L mm	Hand	Part No.
140x0,9	5	010379013
140x1,3	5	010379014
175	5	010379017

1038K



L mm	Hand	Part No.
135x0,9	5	010389013
135x1,3	5	010389014
175	5	010389017

1044K



L mm	Hand	Part No.
250	5	010449250

1044FK



L mm	Hand	Part No.
250	5	010449015



1048NK



L mm	Hand	Part No.
175	3	010489910
250	5	010489915

1048VNK



L mm	Hand	Part No.
175	3	010489111
250	5	010489116

1052K



L mm	Hand	Part No.
140	3	010529014
190	3	010529019
240	3	010529024

1082K



L mm	Hand	Part No.
140	5	010829004
160	5	010829006

1082GK



L mm	Hand	Part No.
140	5	010829064
160	5	010829066



1082BMK



L mm			
140	3	010829034	
160	3	010829036	

1082GBMK



L mm			
140	3	010829264	
160	3	010829266	

1084K



L mm			
160	3	010849006	

1084GK



L mm			
160	5	010849066	

1084BMK



L mm			
160	3	010849036	

1084GBMK



L mm			
160	3	010849266	

1088K



L mm			
160	2	010889006	

1088BMK



L mm			
160	2	010889036	

1096K



L mm			
200	5	010969020	

1098K



L mm			
190	5	010989190	
220	5	010989220	

1098PLK



L mm			
220	5	010989320	

1112K



L mm			
200	2	011129020	

1122K



L mm			
250	2	011229020	

1123K



L mm			
250	2	011239020	

1124K



L mm			
250	2	011249020	

1128BAX



L mm			
150	5	011280088	

1128BMX



L mm			
147	5	011280051	

1128BSX



L mm			
148	5	011280061	

1128FX



L mm			
145	5	011280090	

1128FXS



L mm			
145	5	011280095	

1129BMK



L mm			
145	5	011299000	

1130BMX



L mm			
185	1	011300002	

1132K



L mm			
170	2	011329107	

1132BMK



L mm			
170	2	011329137	

1142BMK



L mm			
160	3	011429036	

1144T



L mm			
112	1	011440060	

1149F



L mm			
175	1	011490010	

1150K



L mm			
160	5	011509046	
180	5	011509048	
200	5	011509050	
220	2	011509052	

1150GK



L mm			
160	5	011509066	
180	5	011509068	
200	5	011509070	
220	2	011509072	

1150BMK



L mm			
160	3	011509146	
180	3	011509148	
200	3	011509150	
220	2	011509152	

1150GBMK



L mm			
160	3	011509266	
180	3	011509268	
200	3	011509270	
220	2	011509272	

1162K



L mm			
160	5	011629006	
200	5	011629010	

1162GK



L mm			
160	5	011629066	
200	5	011629070	

1162BMK



L mm			
160	3	011629036	
200	3	011629040	

1162GBMK



L mm	Hand	Code
160	3	011629266
200	3	011629270

1164K



L mm	Hand	Code
160	5	011649006
200	5	011649010

1164BMK



L mm	Hand	Code
160	3	011649036
200	3	011649040

1166K



L mm	Hand	Code
160	5	011669006
200	5	011669010

1166GK



L mm	Hand	Code
160	5	011669066
200	5	011669070

1166BMK



L mm	Hand	Code
160	3	011669036
200	3	011669040

1166GBMK



L mm	Hand	Code
160	3	011669266
200	3	011669270

1168K



L mm	Hand	Code
160	5	011689006
200	5	011689010

1168GK



L mm	Hand	Code
160	5	011689066
200	5	011689070

1168BMK



L mm	Hand	Code
160	3	011689036
200	3	011689040

1168GBMK



L mm	Hand	Code
160	3	011689266
200	3	011689270

1201E/K



SxAxL mm	Hand	Code
0,4x2,5x50	5	012019203
0,4x2,5x75	5	012019206
0,5x3x75	5	012019209
0,5x3x100	5	012019212
0,6x3,5x75	5	012019218
0,6x3,5x100	5	012019221
0,8x4x100	5	012019230
0,8x4x125	5	012019233
0,8x4x150	5	012019236
1,0x5,5x100	5	012019239
1,0x5,5x125	5	012019240
1,0x5,5x150	5	012019242
1,2x6,5x100	5	012019248
1,2x6,5x125	5	012019250
1,2x6,5x150	5	012019251
1,2x8x150	3	012019257
1,2x8x200	3	012019260
1,6x10x200	3	012019266

1201EN/K



SxAxL mm	Hand	Code
0,8x4x30	3	012019303
1,2x6,5x30	3	012019306

1202E/K



PHxDxL mm	Hand	Code
0x3x60	5	012029203
0x3x100	5	012029206
1x4,5x80	5	012029209
1x4,5x120	5	012029212
2x6x100	5	012029218
2x6x150	5	012029221
3x8x150	3	012029224
4x9,5x200	3	012029227

1202EN/K



PHxDxL mm	Hand	Code
1x4,5x30	3	012029303
2x6x30	3	012029306

1204E/K



SxDxL mm	Hand	Code
0,4x2,5x60	5	012049103
0,6x3x75	5	012049106
0,5x3x100	5	012049109
0,8x4x100	5	012049112
0,8x4x125	5	012049115
1,0x5x125	5	012049118
1,0x5x150	5	012049121
1,2x6,5x150	5	012049124



1207E TX/K



T5	5	012079105
T6	5	012079106
T7	5	012079107
T8	5	012079108
T9	5	012079109
T10	5	012079110
T15	5	012079115
T20	5	012079120
T25	5	012079125
T27	5	012079127
T30	5	012079130
T40	2	012079140
T45	2	012079145

1208E RTX/K



T9	5	012089109
T10	5	012089110
T15	5	012089115
T20	5	012089120
T25	5	012089125
T27	5	012089127
T30	5	012089130
T40	2	012089140

1209E PZ/K



PZ 0	5	012099200
1	5	012099203
2	5	012099206
3	3	012099209
4	3	012099212

1209EN-PZ/K



1	3	012099303
2	3	012099306

1253



SxAxL mm		
0,5x3,5x100	5	012530001

1254



SxAxL mm		
0,5x3x44	5	012540001

1260K



SxAxL mm		
0,4x2,5x50	5	012609003
0,4x2,5x75	5	012609006
0,5x3x75	5	012609009
0,5x3x100	5	012609012
0,6x3,5x75	5	012609018
0,6x3,5x100	5	012609021
0,8x4x100	5	012609030
0,8x4x125	5	012609033
0,8x4x150	5	012609036
1x5,5x100	5	012609039
1x5,5x150	5	012609042
1,5x6,5x100	5	012609048
1,2x6,5x150	5	012609051
1,2x8x150	3	012609057
1,2x8x200	3	012609060
1,6x10x200	3	012609066

1260NK



SxAxL mm		
0,8x4x30	5	012609103
1,2x6,5x30	5	012609106

1260EK



SxAxL mm		
1,2x6,5x150	3	012609156
1,2x8x175	3	012609157
1,6x10x200	2	012609159
2x12x250	2	012609162

1262K



PHxDxL mm		
0x3x60	5	012629003
0x3x100	5	012629006
1x4,5x80	5	012629009
1x4,5x120	5	012629012
2x6x100	5	012629018
2x6x150	5	012629021
3x8x150	3	012629024
4x10x200	3	012629027

1262NK



PHxDxL mm		
1x4,5x30	5	012629103
2x6x30	5	012629106

1262EK



PHxDxL mm		
2x6x150	3	012629153
3x8x175	3	012629156
4x10x200	3	012629159

1264K



SxDxL mm		
0,5x2,5x60	5	012649003
0,6x3x75	5	012649006
0,6x3x100	5	012649009
0,8x4x100	5	012649012
0,8x4x125	5	012649015
1x5x125	5	012649018
1x5x150	5	012649021
1,2x6,5x150	5	012649024

1267TXK



T5	5	012679005
T6	5	012679006
T7	5	012679007
T8	5	012679008
T9	5	012679009
T10	5	012679010
T15	5	012679015
T20	5	012679020
T25	5	012679025
T27	5	012679027
T30	5	012679030
T40	2	012679040
T45	2	012679045

1268RTXK



	🔧	📄
T9	3	012689009
T10	3	012689010
T15	3	012689015
T20	3	012689020
T25	3	012689025
T27	3	012689027
T30	3	012689030
T40	2	012689040

1269PZK



PZ	🔧	📄
0	5	012699000
1	5	012699001
2	5	012699002
3	3	012699003
4	3	012699004

1269N/PZK



PZ	🔧	📄
1	5	012699011
2	5	012699012

1290K



SxAxL mm	🔧	📄
0,4x2,5x50	5	012909003
0,4x2,5x75	5	012909006
0,5x3x75	10	012909009
0,5x3x100	10	012909012
0,6x3,5x75	10	012909018
0,6x3,5x100	10	012909021
0,8x4x100	10	012909030
0,8x4x125	10	012909033
0,8x4x150	10	012909036
1x5,5x100	10	012909039
1x5,5x150	10	012909042
1,2x6,5x100	10	012909048
1,2x6,5x150	10	012909051
1,2x8x150	3	012909057
1,2x8x200	3	012909060
1,6x10x200	3	012909066

1290NK



SxAxL mm	🔧	📄
0,8x4x30	5	012909103
1,2x6,5x30	5	012909106

1290K/INOX



SxAxL mm	🔧	📄
0,4x2,5x50	4	012909403
0,5x3x75	4	012909409
0,8x4x100	4	012909430
1,0x5,5x150	4	012909442
1,2x6,5x150	4	012909451

1292K



PHxDxL mm	🔧	📄
0x3x60	10	012929003
0x3x100	5	012929006
1x4,5x80	10	012929009
1x4,5x120	10	012929012
2x6x100	10	012929018
2x6x150	10	012929021
3x8x150	3	012929024
4x10x200	3	012929027

1292NK



PHxDxL mm	🔧	📄
1x4,5x30	5	012929103
2x6x30	5	012929106

1292K/INOX



PHxDxL mm	🔧	📄
0x3x60	4	012929403
1x4,5x80	4	012929409
2x6x100	4	012929418

1294K



SxDxL mm	🔧	📄
0,5x2,5x60	5	012949003
0,6x3x75	5	012949006
0,8x4x100	5	012949012
1x5x125	5	012949018

1298RTXK



	🔧	📄
T9	5	012989009
T10	5	012989010
T15	5	012989015
T20	5	012989020
T25	5	012989025
T27	5	012989027
T30	5	012989030
T40	2	012989040

1299PZK



PZ	🔧	📄
0	5	012999000
1	5	012999003
2	5	012999006

1299N/PZK



PZ	🔧	📄
1	5	012999021
2	5	012999024

1472VW



L mm	🔧	📄
200	1	014720051

Beta
QUALITY TOOLS

1473P



A Max mm		
53	1	014730020

1497BS

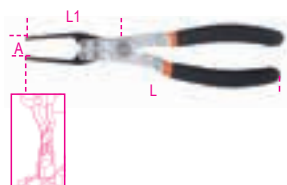

L mm		
230	1	014970190

1497SS



L mm		
245	1	014970195

1497RC



1497RC		
	1	014970351

1600Q 8



1600Q 8		
	1	016000008

1600Q 10



1600Q 8		
	1	016000008

1603K



mm ² 0÷8	5 016039001

1603BK



mm ² 0÷8	2 016039010

1651DGTB

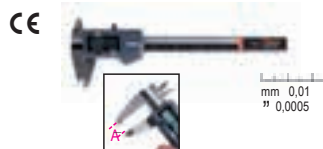

A Max mm		
150	1	016510211
200	1	016510212
300	1	016510213

1651DGTB/IP



A Max mm		
150	1	016510711

1691BM



L m		
5	1	016910205
8	1	016910208
10	1	016910210



1691MG



L m		
5	1	016910405
8	1	016910408
10	1	016910410

1692



L m		
2	5	016920052
3	5	016920053
5	5	016920055
8	5	016920058

1693



IP54



H mm		
100	1	016930020

1729CG



L mm		
310	2	017290200

1729DM 450



L mm		
450	4	017290450

1741U



200 mm

Ø mm	2,4	3	3,2	4	4,8
Alluminio	•	•	•	•	•
Acciaio	•	•	•	•	•
Inox	•	•	•	•	•



1741U 1 017410450

1741B



250 mm

Ø mm	2,4	3,2	4	4,8	5
Alluminio	•	•	•	•	•
Acciaio	•	•	•	•	•
Inox	•	•	•	•	•



1741B 1 017410000

1760K

CE



180 mm

CAT III-1000V



1760K 1 017600140

1762K



Ø mm	2-2,5-3	2	017629001
	3,5-4-4,5		

1771



18 mm

170 mm



1771 10 017710000

1770BM



L mm 140 10 017700050



1771BM



L mm 170 10 017710050



1771HD



L mm 190 5 017710100



1772R



L mm 125 5 017720006



1773A



L mm 180 10 017730000



1777BMT



L mm 170 5 017770050



1777T



L mm 160 5 017770030



1778MT

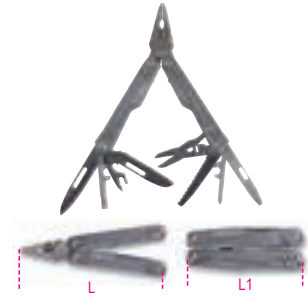

L mm 180 1 017780055



1783



L mm 215 5 017830021
240 5 017830024



1820



1820 30 30W L = 210mm 1 018200003
1820 60 60W L = 220mm 1 018200006
1820 80 80W L = 260mm 1 018200008



1822



1822 120 120W LxA = 250x125 mm	1	018220012
1822 180 180W LxA = 250x125mm	1	018220018
1822 320 320W LxA = 250x140mm	1	018220032

1833S



L mm 150	1	018330002
----------------	---	-----------

1833M



L mm 162	1	018330003
----------------	---	-----------

1833L



L mm 196	1	018330004
----------------	---	-----------

1833XL



L mm 300	1	018330005
----------------	---	-----------

1833L/USB



L mm 240	1	018330054
----------------	---	-----------

1834RR



1834RR	1	018340520
--------	---	-----------

1836AW



1836AW	1	018360051
--------	---	-----------

1836B



1836B	1	018360200
-------	---	-----------



1837F



L mm 460	1	018370050
----------------	---	-----------

1837F/USB



L mm 460	1	018370060
----------------	---	-----------

1838COB



1838COB	1	018380010
---------	---	-----------

1838P

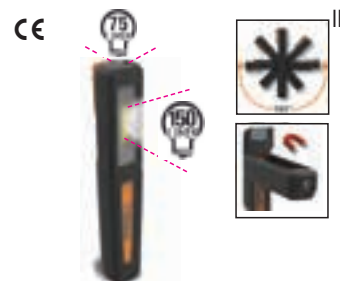

1838P	1	018380005
-------	---	-----------

Beta

1838SLIM

CE

IP54

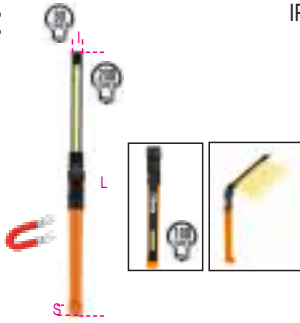

L
mm
307



1 018380221

1838POCKET

CE

IP65
IK07



L
mm
98



1 018380080

1838SW

CE

IP65
IK07



L
mm
260



1 018380142

1839BRW

CE

IP20
IK07



L
mm
101



1 018390002

1860M

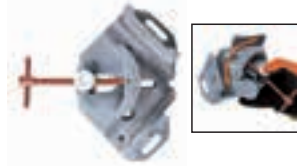

L max
mm
30



1 018600301

1875SP/K3

1/4



1875SP/K3



1 018750010

1949F2

110 mm
95 mm
230 mm



Ø 1/4" GAS BSP



g
125



1 019490028

6888B1/4

supporto blister per bussole 1/4"



6888B1/4



50 068880900

6888B3/8

supporto blister per bussole 3/8"



6888B3/8



50 068880910

6888B1/2

supporto blister per bussole 1/2"



6888B1/2



50 068880920

Beta

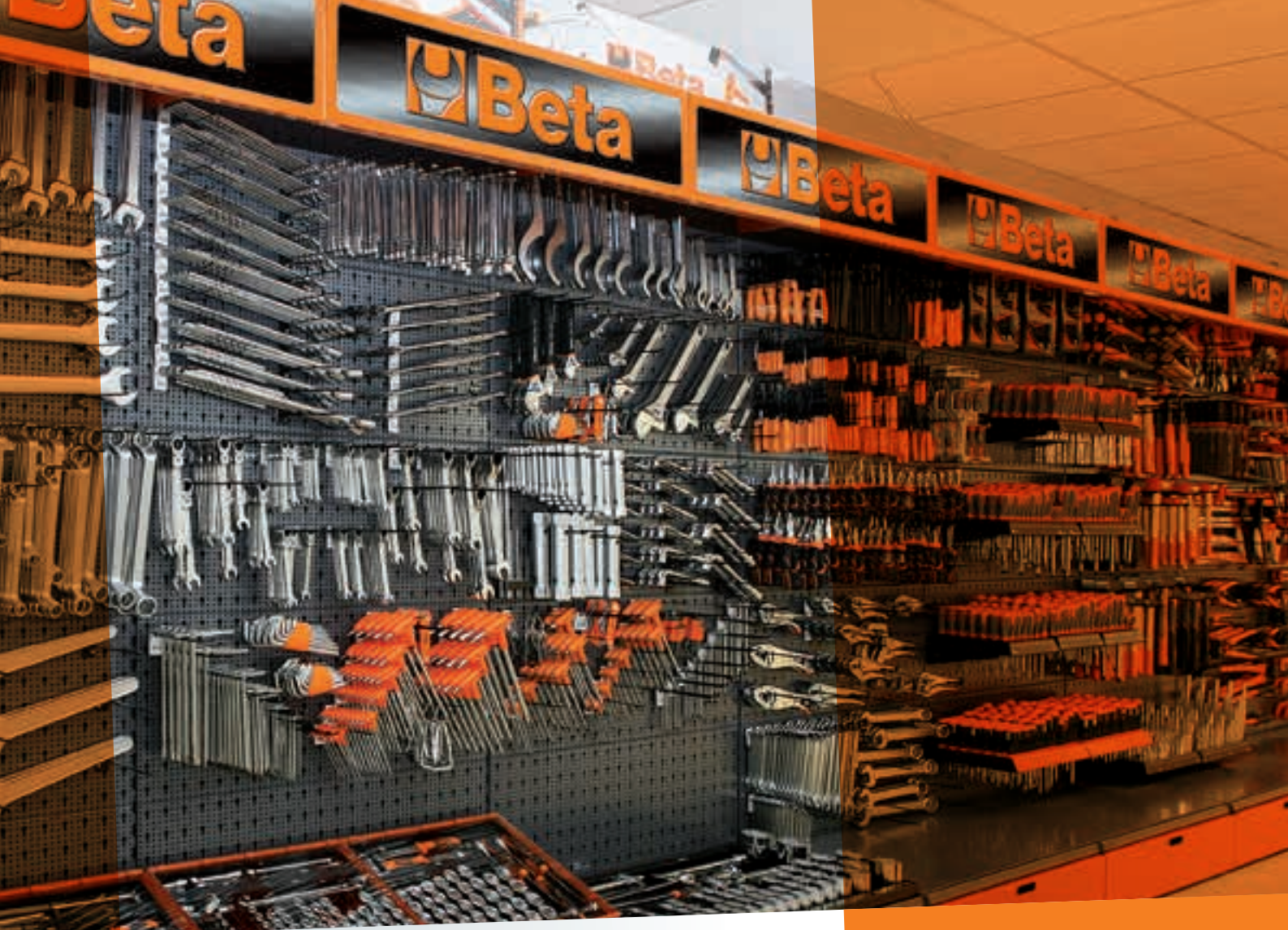

SOLUZIONI
ESPOSITIVE
PER IL PUNTO VENDITA

SHOP
in Shop



PROGETTA il tuo corner Beta

www.beta-tools.com/planner3d/

38/DS1

espositore da parete
con 75 utensili a percussione



495x260x332 mm

Espositore
con assortimento
38/DS1 1 000380701

	n.
30 Ø 2 - 3 - 4 - 5 - 6 mm	5
31 Ø 2 - 3 - 4 - 5 - 6 - 8 - 10 mm	5
32 Ø 3 - 4 - 5 mm	5

Espositore
vuoto
38/DVS1 1 000380751

38/DS2

espositore da parete
con 65 utensili a percussione

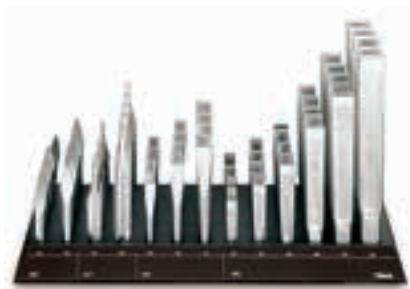

495x260x332 mm

Espositore
con assortimento
38/DS2 1 000380702

	n.
34 125 - 150 - 175 mm	5
35 100 - 125 - 150 - 200 - 250 - 300 mm	5
36 125 - 150 mm	5
37 150 - 200 mm	5

Espositore
vuoto
38/DVS2 1 000380752

942BX/DG

espositore da parete
con 43 chiavi a bussola esagonale
con impugnatura tipo corto



330x260x332 mm

Espositore
con assortimento
942BX/DG 1 009420701

	n.
⊙ 942BX 5 - 5,5 mm	3
6 - 7 mm	6
8 - 9 - 10 mm	5
11 mm	2
12 mm	3
13 mm	5

Espositore
vuoto
942BX/DVG 1 009420751

943BX/DG

espositore da parete
con 43 chiavi a bussola esagonale
con impugnatura tipo lungo



330x260x332 mm

Espositore
con assortimento
943BX/DG 1 009430701

	n.
⊙ 943BX 5 - 5,5 mm	3
6 - 7 mm	6
8 - 9 - 10 mm	5
11 mm	2
12 mm	3
13 mm	5

Espositore
vuoto
943BX/DVG 1 009430751

944BX/DG

espositore da parete
con 43 chiavi a bussola esagonale profonda
con impugnatura tipo lungo



330x260x332 mm

Espositore
con assortimento
944BX/DG 1 009440701

	n.
⊙ 944BX 5 - 5,5 mm	3
6 - 7 mm	6
8 - 9 - 10 mm	5
11 mm	2
12 mm	3
13 mm	5

Espositore
vuoto
944BX/DVG 1 009440751

943MQ/BG

espositore da parete
con 30 chiavi a bussola esagonale
con impugnatura



⚡ 1000 V

330x260x332 mm

Espositore
con assortimento
943MQ/BG 1 009430281

	n.
⊙ 943MQ 5,5 - 6 - 7 - 8 - 10 - 13 mm	5

Espositore
vuoto
943BG-MQ/DV 1 009430285

1203/E1P

espositore da parete
con 82 giravite



495x260x310 mm

Espositore
con assortimento
1203E/E1P

1 012031301

	n.
● 1201	7
0,4x2,5x50 - 0,5x3x75 - 0,6x3,5x100 0,8x4x100 - 0,8x4x125 mm	6
1,0x5,5x100 - 1,0x5,5x150 - 1,2x6,5x150 mm	5
1,2x8x150 mm	7
⊕ 1202	6
PH0x3x60 mm	7
PH1x4,5x80 - PH2x6x100 mm	6
PH3x8x150 mm	5

Espositore
vuoto
1203E/EV1P

1 012031351

1203/E4P

espositore da parete
con 85 giravite



495x260x310 mm

Espositore
con assortimento
1203E/E4P

1 012031304

	n.
● 1201	7
0,4x2,5x50 - 0,5x3x75 - 0,8x4x125 mm	6
1,0x5,5x100 - 1,0x5,5x150 - 1,2x6,5x150 mm	7
● 1204	6
0,4x2,5x60 - 0,5x3x100 - 0,8x4x100 mm	7
1,0x5x125 mm	6
⊕ 1209PZ	7
PZ0x3x60 mm	6
PZ1x4,5x80 - PZ2x6x100 mm	

Espositore
vuoto
1203E/EV4P

1 012031354

1203/E5P

espositore da parete
con 82 giravite



495x260x310 mm

Espositore
con assortimento
1203E/E5P

1 012031305

	n.
⊕ 1202	7
PH0x3x60 mm	6
PH1x4,5x80 - PH1x4,5x120 PH2x6x100 - PH2x6x150 mm	5
PH3x8x150 mm	7
● 1204	6
0,4x2,5x60 - 0,5x3x100 - 0,8x4x100 mm	7
1,0x5x125 mm	6
⊕ 1209PZ	7
PZ0x3x60 mm	6
PZ1x4,5x80 - PZ2x6x100 mm	

Espositore
vuoto
1203E/EV5P

1 012031355

1203/E10P

espositore da parete
con 80 giravite



495x260x310 mm

Espositore
con assortimento
1203E/E10P

1 012031310

	n.
⊖ 1207TX	4
T6	3
T7	7
T8	6
T9 - T10 - T15 - T20 - T25	3
T27 - T30	3
⊕ 1208RTX	6
T9 - T10	6
T15 - T20 - T25	3
T27 - T30	

Espositore
vuoto
1203E/EV10P

1 012031360

1263/E78

Espositore da parete con 78 giravite



495x260x310 mm

Espositore
con assortimento
1263/E78

1 012630510

	n.
● 1260	7
2,5x75-3x75-3,5x100 mm	6
4x100-4x125-5,5x100-5,5x150-6,5x150 mm	4
8x150 mm	7
⊕ 1262	6
PH0x60 mm	7
PH1x80-PH2x100 mm	6
PH3x150	4

Espositore
vuoto
1263/EV78

1 012630511

1263/E74

espositore da parete
con 74 giravite



495x260x310 mm

Espositore
con assortimento
1263/E74

1 012630540

	n.
● 1264	7
2,5x60 mm	3
3x75 mm	4
3x100 - 4x100 mm	2
4x125 - 5x150 mm	4
5x125 - 6,5x150 mm	3
⊕ 1262	7
PH 8x150	6
PH 3x60 - 3x100 mm	10
PH 4,5x80 - 4,5x120 mm	5
PH 6x100 mm	
PH 6x150 mm	

Espositore
vuoto
1263/EV74

1 012630541

1263/E85

espositore da parete
con 85 giravite



495x260x377 mm

Espositore
con assortimento
1263/E85 1 012630550

	n.
● 1260 2,5x50 mm	7
2,5x75 mm	6
3x75 - 3x100 - 3,5x100 mm	7
4x100 - 4x125 - 5,5x125	6
5,5x150 - 6,5x150 mm	4
8x150 mm	4
● 1260E 10x200 mm	3
12x250 mm	2
4x30 - 6,5x30 mm	6

Espositore
vuoto
1263/EV85 1 012630551

1263/E70

espositore da parete
con 70 giravite



495x260x327 mm

Espositore
con assortimento
1263/E70 1 012630560

	n.
⊕ 1262 PH0x60 - PH0x100 mm	7
PH1x80 - PH1x120 mm	6
PH2x100 mm	9
PH2x150 - PH3x150 mm	5
PH4x200 mm	4
⊕ 1262E PH2x150 mm	5
PH3x175 mm	4
⊕ 1262N PH1x30 - PH2x30 mm	6

Espositore
vuoto
1263/EV70 1 012630561

1263/E50

espositore da parete
con 50 giravite



330x260x269 mm

Espositore
con assortimento
1263/E50 1 012630570

	n.
● 1264 2,5x60 - 3x75 - 3x100 mm	7
4x100 - 4x125 - 5x125 - 5x150 mm	6
6,5x150 mm	5

Espositore
vuoto
1263/EV50 1 012630571

1263/E62

espositore da parete
con 62 giravite



495x260x257 mm

Espositore
con assortimento
1263/E62 1 012630590

	n.
⊕ 1267TX T5	5
T6	6
T7	5
T8	6
T9	5
T10 - T15 - T20	6
T25	5
T27 - T30	4
T40 - T45	2

Espositore
vuoto
1263/EV62 1 012630591

1263/E39

espositore da parete
con 39 giravite



330x260x257 mm

Espositore
con assortimento
1263/E39 1 012630595

	n.
⊕ 1268RTX T9x60 - T10x80 - T15x80	6
T20x100 - T25x100 mm	4
T27x115 mm	3
T30x115 mm	2
T40x130 mm	2

Espositore
vuoto
1263/EV39 1 012630596

1263/E40

espositore da parete
con 40 giravite



330x260x327 mm

Espositore
con assortimento
1263/E40 1 012630580

	n.
⊕ 1269 PZ0x60 mm	7
PZ1x80 mm	6
PZ2x100 - PZ3x150 - PZ4x200 mm	5
⊕ 1269N PZ1x30 - PZ2x30 mm	6

Espositore
vuoto
1263/EV40 1 012630581

1273MQ/E1

espositore da parete
con 40 giravite



△ 1000 V ⚡

330x260x332 mm

Espositore
con assortimento
1273MQ/E1

1 012730312

	n.
➕ 1272MQ PH0x60 - PH1x80 mm	5
PH2x100 mm	3
PH3x150 mm	2
● 1274MQ 3x100 - 4x100 - 5,5x125 - 6,5x150 mm	5
8x175 mm	3
10x200 mm	2

Espositore
vuoto
1273BG-MQ/DV

1 012730651

1273MQ/E4

espositore da parete
con 43 giravite



△ 1000 V ⚡

330x260x332 mm

espositore da parete
con assortimento
1273MQ/E4

1 012730315

➕ 1272MQF 4,5x80 - 6x100 mm	3
● 1274MQF 3,5x100 - 4,5x100 - 5,5x125 - 6,5x150 mm	3
➕ 1275MQ/C 4,5x80 - 6x100 mm	5
➕ 1276MQ/C 4,5x80 - 6x100 mm	5
➕ 1279MQ/F 4,5x80 mm	3
6x100 mm	2

Espositore
vuoto
1273BG-MQ/DV4

1 012730655

1293BX/DA

espositore da parete
con 90 giravite



495x260x332 mm

Espositore
con assortimento
1293BX/DA

1 012930701

● 1290 3x75 - 3,5x100 - 4x100 - 4x125 - 5,5x100 - 5,5x150 mm	7
6,5x150 mm	6
8x150 mm	3
10x200 mm	2
● 1290N 4x30 - 6,5x30 mm	3
➕ 1292 PH0x60 - PH1x80 mm	7
PH2x100 mm	6
PH3x150 mm	5
➕ 1292N PH1x30 - PH2x30 mm	3

Espositore
vuoto
1293BX/DVA

1 012930751

1293BX/DD

espositore da parete
con 48 giravite



330x260x332 mm

Espositore
con assortimento
1293BX/DD

1 012930704

● 1294 2,5x60 - 3x75 - 3x100 - 4x100 - 4x150 - 5x125 mm	7
6,5x150 mm	6

Espositore
vuoto
1293BX/DVD

1 012930754

1293BX/DE

espositore da parete
con 42 giravite



330x260x332 mm

Espositore
con assortimento
1293BX/DE

1 012930705

➕ 1299PZ PZ0x60 - PZ1x80 mm	7
PZ2x100 mm	6
PZ3x150 - PZ4x200 mm	5
➕ 1299N/PZ PZ1x30 - PZ2x30 mm	6

Espositore
vuoto
1293BX/DVE

1 012930755

1293BX/DF

espositore da parete
con 59 giravite



330x260x332 mm

Espositore
con assortimento
1293BX/DF

1 012930706

● 1297TX T6 - T8 - T10 - T15 - T20 - T25 - T27 - T30	6
T40	5

Espositore
vuoto
1293BX/DVF

1 012930756

C68

parete espositiva vuota Beta



1000x560x2200 mm

C68/1	1 m	1	068000001
C68/2	2 m	1	068000002
C68/3	3 m	1	068000003
C68/4	4 m	1	068000004
C68/5	5 m	1	068000005
C68/6	6 m	1	068000006
C68/7	7 m	1	068000007
C68/8	8 m	1	068000008
C68/9	9 m	1	068000009
C68/10	10 m	1	068000010

C68N

parete espositiva vuota Beta



1000x560x2200 mm

C68N/1	1 m	1	068000031
C68N/2	2 m	1	068000032
C68N/3	3 m	1	068000033
C68N/4	4 m	1	068000034
C68N/5	5 m	1	068000035
C68N/6	6 m	1	068000036
C68N/7	7 m	1	068000037
C68N/8	8 m	1	068000038
C68N/9	9 m	1	068000039
C68N/10	10 m	1	068000040

C68 G

gondola espositiva vuota



1000x1120x1600 mm

C68G/1	1 m	1	068000051
C68G/2	2 m	1	068000052
C68G/3	3 m	1	068000053
C68G/4	4 m	1	068000054

C88 R/1

parete espositiva vuota Robur



1000x560x2200 mm

C88R/1	1 m	1	088000001
--------	-----	---	-----------



C88NR/1

parete espositiva vuota Robur



1000x560x2200 mm

C88NR/1	1 m	1	088000031
---------	-----	---	-----------

C88VE

vasca espositiva per pareti C88 R/1

adatta ad alloggiare bobine di catena art.8120



C88VE		1	088000120
-------	--	---	-----------

C88SE

espositore per bobine di catena genovese



C88SE		1	088000130
-------	--	---	-----------

1700x600x600 mm

6888

ganci per espositori C60 - C61 - C68 - C88



6888S1	10	068880011
6888S2	10	068880012
6888D1	5	068880021
6888D2	5	068880022
6888D4	5	068880024
6888D5	5	068880025
6888T1	5	068880031
6888T2	5	068880032
6888CT	1	068880044
6888B	1	068880100
6888GA	3	068880120
6888S-1/4	1	068880605
6888S-3/8	1	068880610

6800 VE

vetrina per parete espositiva C68 e C68 R/1



6800VE/1	1 m	1	068000401
6800VE/2	2 m	1	068000402
6800VE/3	3 m	1	068000403
6800VE/4	4 m	1	068000404
6800VE/5	5 m	1	068000405

ACCESSORI C68



6800AE	1	068000145
6800AI	1	068000140
6800AD/P	1	068000143

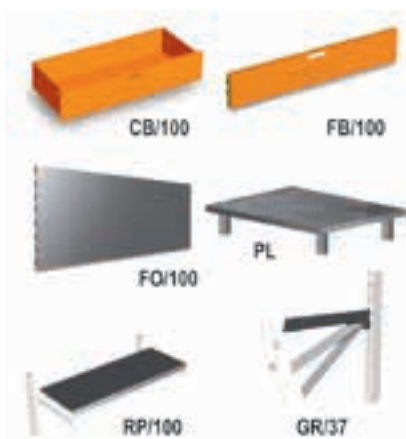

6800CB/100	1	068000104
6800FB/100	1	068000109
6800FO/100	1	068000108
6800PL	1	068000137
6800RP/100	1	068000150
6800GR/37	1	068000159



6800PM/40	1	068000171
6800PM/80	1	068000172

6600 M/14

assortimento 154 utensili, con ganci senza pannello



6600 M/14	1	066000014
-----------	---	-----------

6600 M/22

assortimento 108 utensili, con ganci senza pannello



6600 M/22	1	066000022
-----------	---	-----------

6600 M/27

assortimento 25 utensili, con ganci senza pannello



6600 M/27	1	066000027
-----------	---	-----------

6600 M/29

assortimento 173 utensili, con ganci senza pannello



6600 M/29	1	066000029
-----------	---	-----------

6600 M/33

assortimento 37 utensili, con ganci senza pannello





6600 M/33	1	066000033
-----------	---	-----------

Beta

6600 M/40

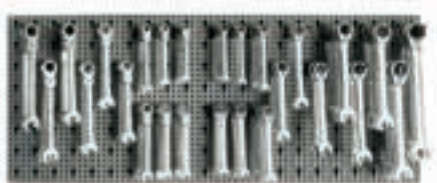
assortimento 100 utensili,
con ganci senza pannello



6600 M/40  1 066000040

6600 M/42

assortimento di 65 utensili,
con ganci senza pannello



6600 M/42  1 066000042

6600 M/44

assortimento 48 utensili,
con ganci senza pannello

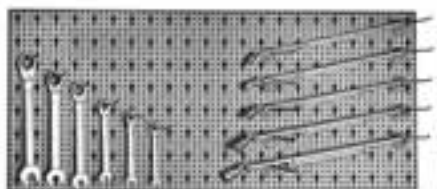

6600 M/44  1 066000044

6600 M/47

assortimento 65 utensili,
con ganci senza pannello



6600 M/47  1 066000047

6600 M/51

assortimento di 257 utensili
con ganci senza pannello



6600 M/51  1 066000051

6600 M/52

assortimento di 176 utensili
con ganci senza pannello



6600 M/52  1 066000052

6600 M/58

assortimento di 150 utensili
con ganci senza pannello



6600 M/58  1 066000058

6600 M/59

assortimento 220 utensili,
con ganci senza pannello



6600 M/59  1 066000059

6600 M/61

assortimento 71 utensili,
con ganci senza pannello



6600 M/61  1 066000061

6600 M/62

assortimento 28 utensili,
con ganci senza pannello



6600 M/62  1 066000062

6600 M/63

assortimento di 110 utensili
con ganci senza pannello



6600 M/63  1 066000063

6600 M/73

assortimento di 68 utensili
con ganci senza pannello



6600 M/73  1 066000073

6600 M/112

assortimento 329 utensili,
con ganci senza pannello

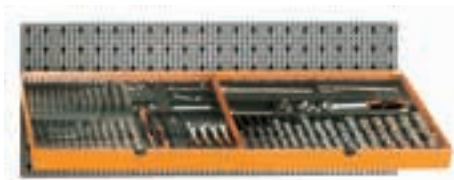

6600 M/112



1 066000112

6600 M/116

assortimento 306 utensili,
con ganci senza pannello

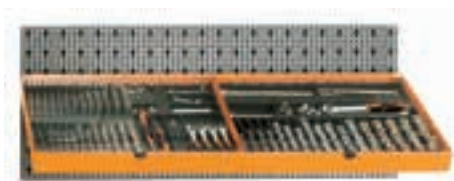

6600 M/116



1 066000116

6600 M/120

assortimento 163 utensili,
con ganci senza pannello

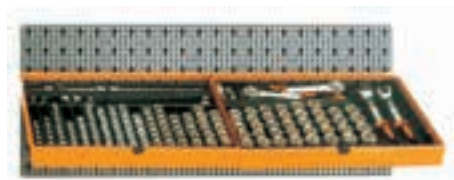

6600 M/120



1 066000120

6600 M/125

assortimento 133 utensili,
con ganci senza pannello

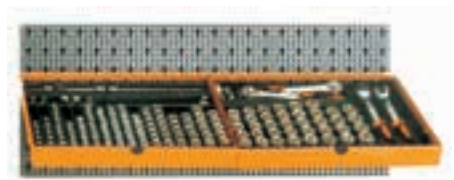

6600 M/125



1 066000125

6600 M/126

assortimento 58 utensili,
con ganci senza pannello



6600 M/126



1 066000126

6600 M/131

assortimento 92 utensili,
con ganci senza pannello



6600 M/131



1 066000131

6600 M/174

assortimento 13 utensili, con ganci senza
pannello



6600 M/174



1 066000174

6600 M/175

assortimento 12 utensili,
con ganci senza pannello



6600 M/175



1 066000175

6600 M/217

assortimento di 74 utensili
con ganci senza pannello



6600 M/217



1 066000217

6600 M/218

assortimento 58 utensili,
con ganci senza pannello



6600 M/218



1 066000218

6600 M/222

assortimento di 74 utensili,
con ganci senza pannello



6600 M/222



1 066000222

6600 M/223

assortimento 58 utensili,
con ganci senza pannello



6600 M/223





1 066000223

6600 M/230

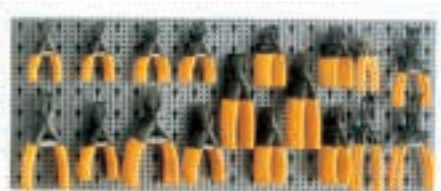
assortimento 78 utensili,
con ganci senza pannello





6600 M/230   1 066000230

6600 M/236

assortimento 31 utensili,
con ganci senza pannello



6600 M/236   1 066000236

6600 M/241

assortimento di 43 utensili,
con ganci senza pannello

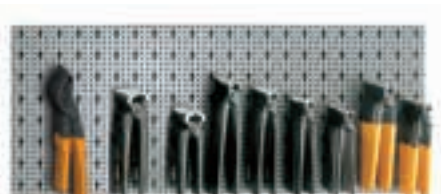



6600 M/241   1 066000241

6600 M/242

assortimento di 91 utensili
con ganci senza pannello





6600 M/242   1 066000242

6600 M/253

assortimento 60 utensili,
con ganci senza pannello





6600 M/253   1 066000253

6600 M/311

assortimento 114 utensili,
con ganci senza pannello





6600 M/311   1 066000311

6600 M/315

assortimento 149 utensili,
con ganci senza pannello





6600 M/315   1 066000315

6600 M/320

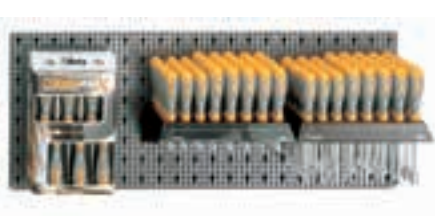
assortimento 98 utensili,
con ganci senza pannello





6600 M/320   1 066000320

6600 M/326

assortimento 155 utensili,
con ganci senza pannello





6600 M/326   1 066000326

6600 M/327

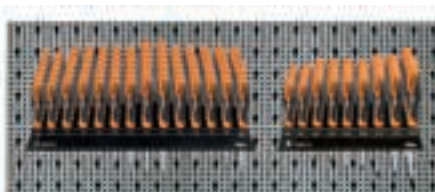
assortimento 101 utensili,
con ganci senza pannello





6600 M/327   1 066000327

6600 M/330

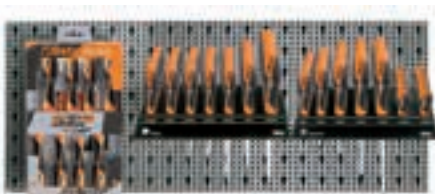
assortimento 110 utensili,
con ganci senza pannello





6600 M/330   1 066000330

6600 M/371

assortimento 162 utensili,
con ganci senza pannello



6600 M/371   1 066000371

6600 M/380

assortimento 71 utensili,
con ganci senza pannello



6600 M/380



1 066000380

6600 M/424

assortimento 36 utensili, con ganci senza
pannello



6600 M/424



1 066000424

6600 M/456

assortimento di 41 utensili,
con ganci senza pannello



6600 M/456



1 066000456

6600 M/406

assortimento 107 utensili,
con ganci senza pannello

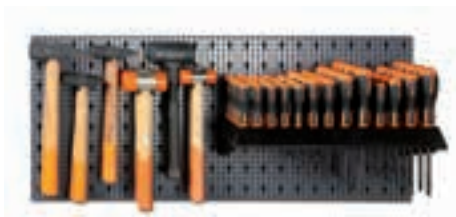

6600 M/406



1 066000406

6600 M/427

assortimento 24 utensili,
con ganci senza pannello



6600 M/427



1 066000427

6600 M/465

assortimento 36 utensili, con ganci senza
pannello



6600 M/465



1 066000465

6600 M/417

assortimento 43 utensili,
con ganci senza pannello



6600 M/417



1 066000417

6600 M/430

assortimento 29 utensili,
con ganci senza pannello



6600 M/430



1 066000430

6600 M/480

assortimento 18 utensili,
con ganci senza pannello

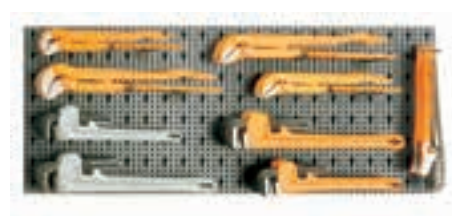

6600 M/480



1 066000480

6600 M/423

assortimento 29 utensili, con ganci senza
pannello



6600 M/423



1 066000423

6600 M/440

assortimento 140 utensili,
con ganci senza pannello

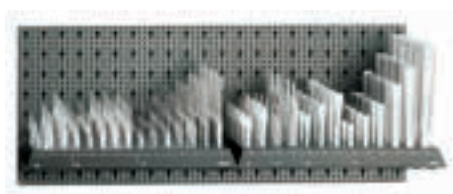

6600 M/440



1 066000440

6600 M/485

assortimento 12 utensili,
con ganci senza pannello



6600 M/485





1 066000485

6600 M/510

assortimento 16 utensili,
con ganci senza pannello





6600 M/510   1 066000510

6600 M/532

assortimento di 24 utensili
con ganci senza pannello





6600 M/532   1 066000532

6600 M/534

assortimento 51 utensili,
con ganci senza pannello





6600 M/534   1 066000534

6600 M/542

assortimento di 53 utensili,
con ganci senza pannello





6600 M/542   1 066000542

6600 M/548

assortimento di 37 utensili,
con ganci senza pannello





6600 M/548   1 066000548

6600 M/561

assortimento 60 utensili,
con ganci senza pannello





6600 M/561   1 066000561

6600 M/583

assortimento di 22 utensili
con ganci senza pannello





6600 M/583   1 066000583

6600 M/643

assortimento 90 utensili,
con ganci senza pannello





6600 M/643   1 066000643

6600 M/650

assortimento 28 utensili,
con ganci senza pannello





6600 M/650   1 066000650

6600 M/657

assortimento 17 utensili,
con ganci senza pannello



6600 M/657   1 066000657

6600 M/658

assortimento di 14 utensili
con ganci senza pannello



6600 M/658   1 066000658



6600 M/716

assortimento 64 utensili,
con ganci senza pannello



6600 M/716

1 066000716

6600 M/813

assortimento 25 utensili, con ganci senza
pannello



6600 M/813

1 066000813

6600 M/842

assortimento 36 utensili, con ganci senza
pannello



6600 M/842

1 066000842

6600 M/852

assortimento di 560 dischi abrasivi rigidi
con ganci senza pannello

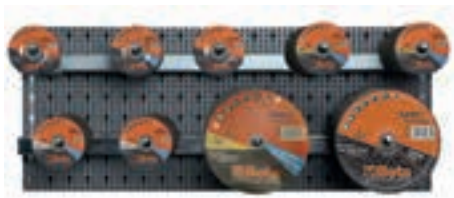

6600 M/852

1 066000852

6600 M/856

assortimento di 560 dischi abrasivi rigidi
con ganci senza pannello



6600 M/856

1 066000856

6600 M/857

assortimento di 560 dischi abrasivi rigidi
con ganci senza pannello



6600 M/857

1 066000857

6600 M/871

assortimento di 120 dischi abrasivi lamellari
con ganci senza pannello



6600 M/871

1 066000871

6600 M/878

assortimento di 100 dischi abrasivi lamellari
con ganci senza pannello



6600 M/878

1 066000878

6600 M/881

assortimento di 410 ruote abrasive con gambo
con vasca espositiva



6600 M/881

1 066000881

Robur

8600 R/11

assortimento 374 accessori per funi,
con ganci senza pannello



8600 R/11

1 086000011

8600 R/12

assortimento 259 accessori per funi,
con ganci senza pannello

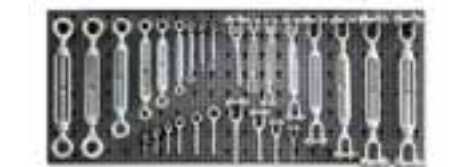

8600 R/12



1 086000012



8600 R/13

assortimento 230 accessori per funi,
con ganci senza pannello





8600 R/13  1  086000013

8600 R/113

assortimento 1862 accessori per funi,
con ganci senza pannello





8600 R/113  1  086000113

8600 R/114

assortimento 1045 accessori per funi,
con ganci senza pannello





8600 R/114  1  086000114

8600 R/225

assortimento 64 accessori GRADO 8
con ganci senza pannello





8600 R/225  1  086000225

8600 R/412

assortimento 348 accessori INOX per funi,
con ganci senza pannello





8600 R/412  1  086000412

8600 R/511

assortimento 11 bobine catena genovese
con vasca espositiva





8600 R/511  1  086000511

8600 R/601

assortimento 50 cricchetti di ancoraggio
con griglie, ripiano e ganci
senza pannello



8600 R/601  1  086000601
C88/R601 1 088000160

8600 R/611

assortimento 52 fasce di sollevamento
con griglie, senza pannello



8600 R/611  1  086000611
C88/R611 1 088000161



 **Beta**



CALZATURE ANTINFORTUNISTICHE

AVVERTENZE

Verificare prima dell'impiego che la calzatura corrisponda alle proprie esigenze di utilizzo e che la categoria di protezione sia corretta in funzione al tipo e al luogo di lavoro. Le calzature prodotte da Beta Utensili sono conformi alle **NORMATIVE EUROPEE** vigenti. La legge responsabilizza il datore di lavoro per quanto riguarda l'adeguatezza del DPI al tipo di rischio presente (caratteristica del DPI e categoria di appartenenza).

OBSOLESCENZA

A causa dei numerosi fattori (umidità durante l'immagazzinamento e modificazione della struttura dei materiali nel tempo) non è possibile stabilire con certezza la durata di immagazzinamento della scarpa. In generale, per calzature interamente in poliuretano o con **fondo in poliuretano** è comunque ipotizzabile una durata massima di **tre anni** dalla data di produzione. Per calzature **interamente in PVC** è ipotizzabile una durata di **cinque anni** dalla data di produzione, mentre per **calzature con tomaia in cuoio, calzature in gomma, materiale termoplastico e EVA** è ipotizzabile una durata massima di **dieci anni** dalla data di produzione. Tale termine si intende per calzature nuove, imballate e conservate in condizioni controllate, evitando forti escursioni termiche e di umidità relativa.

NORMATIVE EUROPEE EN ISO 20345:2011 - EN ISO 20347:2012

CONFORMITÀ ALLA NORMATIVA EN ISO 20345:2011

La norma specifica i requisiti di base e supplementari (facoltativi) per le **calzature di Sicurezza** per usi generali. Le calzature conformi alla normativa EN ISO 20345:2011 sono contraddistinte dalla lettera **"S"** (Safety = Sicurezza) con resistenza del puntale a 200 Joule.

CONFORMITÀ ALLA NORMATIVA EN ISO 20347:2012

La norma specifica i requisiti di base e supplementari (facoltativi) per le **calzature da lavoro che non sono esposte a rischi meccanici** (urto o compressione). Le calzature conformi alla normativa EN ISO 20347:2012 sono contraddistinte dalla lettera **"O"** (Occupational = Professionale). Sono simili per caratteristiche alle calzature precedentemente indicate, le uniche differenze sono la mancanza del puntale di protezione e della lamina antiperforazione.

Oltre ai requisiti di base obbligatori secondo la norma EN ISO 20345:2011, le calzature possono soddisfare anche **requisiti aggiuntivi**. Tali requisiti devono essere identificati con simboli o classi e indicati sull'etichetta applicata alla linguetta della calzatura.

NUOVE NORMATIVE EUROPEE EN ISO 20345:2022 - EN ISO 20347:2022

CONFORMITÀ ALLA NORMATIVA EN ISO 20345:2022

La norma specifica i requisiti di base e supplementari (facoltativi) per le **calzature di Sicurezza** per usi generali. Le calzature conformi alla normativa EN ISO 20345:2022 sono contraddistinte dalla lettera **"S"** (Safety = Sicurezza), sono munite di puntale atto a fornire una protezione contro gli urti di almeno 200 J e contro la compressione di almeno 15 kN.

CONFORMITÀ ALLA NORMATIVA EN ISO 20347:2022

La norma specifica i requisiti di base e supplementari (facoltativi) per le **calzature da lavoro che non sono esposte a rischi meccanici** (urto o compressione). Le calzature conformi alla normativa EN ISO 20347:2022 sono contraddistinte dalla lettera **"O"** (Occupational = Professionale). Sono simili per caratteristiche alle calzature precedentemente indicate, le uniche differenze sono la mancanza del puntale di protezione e della lamina antiperforazione.

Oltre ai requisiti di base obbligatori secondo la norma EN ISO 20345:2022, le calzature possono soddisfare anche **requisiti aggiuntivi**. Tali requisiti devono essere identificati con simboli o classi e indicati sulla calzatura.

Informazioni per calzature con inserto anti-perforazione

La resistenza alla perforazione di questa calzatura è stata misurata in laboratorio utilizzando chiodi e forza standardizzati. Chiodi di diametro inferiore e carichi statici o dinamici più elevati aumentano il rischio di perforazione. In tali circostanze, è necessario prendere in considerazione ulteriori misure preventive. Attualmente nelle calzature DPI sono disponibili tre diversi tipi di inserti resistenti alla perforazione. Essi possono essere inserti in metallo e inserti non metallici e devono essere scelti sulla base di una valutazione dei rischi legati al tipo lavoro. Tutti gli inserti offrono protezione contro il rischio di perforazione, ma ciascuno di essi presenta diversi vantaggi o svantaggi aggiuntivi, tra cui i seguenti:

- **Inserto anti-perforazione metallico:** la resistenza alla perforazione risente meno della forma dell'oggetto tagliente (ad esempio il diametro, la geometria o la forma appuntita), ma a causa di limitazioni nelle dimensioni necessarie per la produzione delle calzature, esso non copre l'intera superficie della parte inferiore della scarpa.
- **Inserto anti-perforazione non metallico:** può essere più leggero, più flessibile e fornire una maggiore area di copertura se confrontato con quello metallico, ma la resistenza alla perforazione può variare maggiormente a seconda della forma dell'oggetto tagliente (ad esempio il diametro, la geometria o la forma appuntita). Sono disponibili due tipi di protezione. Il tipo PS può offrire una protezione più adeguata da oggetti di diametro inferiore rispetto al tipo PL.

REQUISITI BASE + REQUISITI SUPPLEMENTARI CALZATURE

CLASSIFICAZIONE CALZATURE

- **Classe I:** Calzature in cuoio e altri materiali, escluso calzature interamente di gomma e le calzature interamente di materiale polimerico.
- **Classe II:** Calzature interamente in gomma (cioè interamente vulcanizzate) o interamente di materiale polimerico (cioè interamente iniettate).

REQUISITI DI BASE

- **Calzatura completa:** altezza del tomaio; zona del tallone; prestazioni costruttive della suola (costruzione e resistenza al distacco tomaio/ suola); protezione delle dita e caratteristiche del puntale (eccetto EN ISO 20347), proprietà antiscivolo.
- **Tomaia:** caratteristiche dei materiali del tomaio, fodera, linguetta, sottopiede (resistenza allo strappo, all'abrasione, caratteristiche di trazione, permeabilità al vapore acqueo, pH, assorbimento e deassorbimento per il sottopiede e per il plantare).
- **Suola:** costruzione e resistenze allo strappo, all'abrasione, alla flessione, all'idrolisi, al distacco strati della suola e agli olii idrocarburi.

CLASSE DI PROTEZIONE		EN ISO 20345:2011				EN ISO 20347:2012				EN ISO 20345:2011		EN ISO 20347:2012		VALORI MINIMI RICHIESTI
		SB	S1	S2	S3	OB	O1	O2	O3	S4	S5	O4	O5	
	Zona del tallone chiusa	0	X	X	X	0	X	X	X	X	X	X	X	
	Resistenza all'urto del puntale 200 Joule	X	X	X	X	-	-	-	-	X	X	-	-	
A	Calzatura antistatica	0	X	X	X	0	X	X	X	X	X	X	X	Resistenza elettrica > 100 kΩ, ≤ 1000 MΩ
E	Assorbimento di energia nella zona tallone	0	X	X	X	0	X	X	X	X	X	X	X	> 20 Joule
WRU	Penetrazione e assorbimento dell'acqua nel tomaio	0	-	X	X	0	-	X	X	-	-	-	-	Penetrazione: < 0.2 g x 60 min Assorbimento: < 30% x 60 min.
P	Resistenza della suola alla perforazione	0	0	-	X	0	0	-	X	0	X	0	X	> 1100 N
CI	Isolamento dal freddo	0	0	0	0	0	0	0	0	0	0	0	0	Riduzione temp. superficie interna suola: < 10°C
HI	Isolamento dal calore	0	0	0	0	0	0	0	0	0	0	0	0	Aumento temp. superficie interna suola: < 22°C
HRO	Resistenza della suola al calore per contatto	0	0	0	0	0	0	0	0	0	0	0	0	Resistente fino a 300°C
WR	Calzatura resistente all'acqua	0	0	0	0	0	0	0	0	-	-	-	-	Assorbimento: < 3 cm ²
FO	Resistenza della suola agli idrocarburi	0	X	X	X	0	0	0	0	X	X	0	0	Aumento volume della suola < 12%
SRC	Resistenza della suola allo scivolamento	X	X	X	X	X	X	X	X					Requisito SRA + SRB

X	Requisito obbligatorio della categoria di protezione
O	Requisito facoltativo unito a quelli obbligatori, se indicato nella marcatura
-	Requisito non obbligatorio , controllare marcatura scarpa

Calzature antistatiche:

Le calzature antistatiche vanno utilizzate quando sussiste la necessità di ridurre al minimo l'accumulo di cariche elettrostatiche in modo da escludere il pericolo di combustione di sostanze infiammabili e vapori e nel caso in cui persista il rischio di scosse elettriche provenienti da elementi sotto tensione. Le calzature antistatiche non forniscono una protezione contro lo shock elettrico in quanto creano unicamente una resistenza elettrica tra il pavimento e il piede. Qualora non si possa escludere completamente il pericolo di uno shock elettrico, si dovrà ricorrere a precauzioni aggiuntive che dovrebbero fare parte di un programma periodico di prevenzione degli infortuni sul posto di lavoro. Al fine di preservare i requisiti di antistaticità, le calzature non dovranno subire modifiche.

Calzature elettricamente isolanti:

Le calzature elettricamente isolate forniscono protezione limitata elettrica da contatti accidentali con tensioni fino a 1000 V con la riserva che le condizioni di impiego dovranno essere tali da non modificare o alterare la resistenza elettrica con l'influenza dell'umidità. Va specificato che la resistenza elettrica è riferita solamente al fondo della calzatura e non al tomaio.

Classi elettriche calzature:

Classe 00 500V CA oppure 750V CC

Classe 0 1000V CA oppure 1500V CC

Calzature dissipative per ambienti EPA:

Le calzature dissipative sono specifiche per ambienti EPA (ESDS) e permettono alle cariche elettrostatiche presenti sul corpo di chi le indossa di essere dissipate in modo continuo e controllato, in modo da proteggere i componenti e i dispositivi elettronici dai fenomeni elettrostatici. Il valore di riferimento della resistenza al suolo secondo CEI EN 61340-5-1: 2016, per chi lo indossa / calzature / pavimento, è tra < 1 × 10⁹ Ω.

REQUISITI BASE + REQUISITI SUPPLEMENTARI CALZATURE

CLASSIFICAZIONE CALZATURE

- **Classe I:** Calzature in cuoio e altri materiali, escluso calzature interamente di gomma e le calzature interamente di materiale polimerico.
- **Classe II:** Calzature interamente in gomma (cioè interamente vulcanizzate) o interamente di materiale polimerico (cioè interamente iniettate).

REQUISITI DI BASE

- **Calzatura completa:** altezza del tomaio; zona del tallone; prestazioni costruttive della suola (costruzione e resistenza al distacco tomaio/ suola); protezione delle dita e caratteristiche del puntale (eccetto EN ISO 20347), proprietà antiscivolo.
- **Tomaia:** caratteristiche dei materiali del tomaio, fodera, linguetta, sottopiede (resistenza allo strappo, all'abrasione, caratteristiche di trazione, permeabilità al vapore acqueo, pH, assorbimento e deassorbimento per il sottopiede e per il plantare).
- **Suola:** costruzione e resistenze allo strappo, all'abrasione, alla flessione, all'idrolisi, al distacco strati della suola e agli olii idrocarburi.

CLASSE DI PROTEZIONE	EN ISO 20345:2022											EN ISO 20347:2022						VALORI MINIMI RICHIESTI
	SB	S1	S2	S3	S3L	S3S	S6	S7	S7L	S7S	OB	O1	O2	O3	O3L	O3S		
Classe	I o II	I	I	I	I	I	I	I	I	I	I o II	I	I	I	I	I		
Zona del tallone chiusa	0	X	X	X	X	X	X	X	X	X	0	X	X	X	X	X		
Resistenza all'urto del puntale 200 Joule	X	X	X	X	X	X	X	X	X	X	-	-	-	-	-	-		
Suola tassellata	0	0	0	X	X	X	0	X	X	X	0	0	0	X	X	X		
P Resistenza alla perforazione (inserto metallico P)	0	0	0	X	-	-	0	X	-	-	0	0	0	X	-	-	Forza di perforazione ≥ 1100N	
PL Resistenza alla perforazione (inserto non-metallico, prova con chiodo Ø 4,5 mm)	0	0	0	-	X	-	0	-	X	-	0	0	0	-	X	-		
PS Resistenza alla perforazione (inserto non-metallico, prova con chiodo Ø 3,0 mm)	0	0	0	-	-	X	0	-	-	X	0	0	0	-	-	X		
A Calzature antistatiche	0	X	X	X	X	X	X	X	X	X	0	X	X	X	X	X	Resistenza elettrica > 100 kΩ ≤ 1000 kΩ	
HI Isolamento dal calore del complesso soletta	0	0	0	0	0	0	0	0	0	0	0	0	0	0	0	0	Incremento T ≤ 22°C quando appoggiata su piastra alla T di 150°C per 30'	
CI Isolamento dal freddo del complesso soletta	0	0	0	0	0	0	0	0	0	0	0	0	0	0	0	0	Decremento T ≤ 10°C in ambiente a -17°C per 30'	
E Assorbimento di energia nella zona del tallone	0	X	X	X	X	X	X	X	X	X	0	X	X	X	X	X	> 20 Joule	
WR Resistenza all'acqua	0	0	0	0	0	0	X	X	X	X	0	0	0	0	0	0	Nessuna penetrazione dell'acqua	
SC Resistenza all'abrasione del copri punta	0	0	0	0	0	0	0	0	0	0	0	0	0	0	0	0	Nessun foro per tutto lo spessore dopo 8.000 cicli	
SR Resistenza allo scivolamento su pavimento in ceramica con glicerina	X	X	X	X	X	X	X	X	X	X	X	X	X	X	X	X	Prova su piano in ceramica con glicerina.	
WPA Penetrazione ed assorbimento di acqua	0	0	X	X	X	X	-	-	-	-	0	0	X	X	X	X	Assorbimento H2O dopo 60' ≤ 30%	
HRO Resistenza al calore per contatto	0	0	0	0	0	0	0	0	0	0	0	0	0	0	0	0	Contatto a 300°C per 60'' - non fonde	
FO Resistenza agli idrocarburi	0	0	0	0	0	0	0	0	0	0	0	0	0	0	0	0	Incremento di volume del campione di suola < 12 %	
LG Grip sulla scala	0	0	0	0	0	0	0	0	0	0	0	0	0	0	0	0	Larghezza zona centrale della suola > 35 mm	

X	Requisito obbligatorio della categoria di protezione
0	Requisito facoltativo unito a quelli obbligatori, se indicato nella marcatura
-	Requisito non obbligatorio , controllare marcatura scarpa

Calzature parzialmente conduttive

Le calzature parzialmente conduttive devono essere utilizzate se è necessario ridurre al minimo le cariche elettrostatiche nel più breve tempo possibile, ad esempio durante la manipolazione di esplosivi.

Non devono essere utilizzate se non è stato completamente eliminato il rischio di scosse da apparecchiature elettriche o parti sotto tensione con tensione alternata o continua. Per garantire che questa calzatura sia parzialmente conduttiva, è stato specificato che il limite superiore di resistenza è di 100 kΩ nel suo nuovo stato.

Calzature antistatiche

Le calzature antistatiche vanno utilizzate quando sussiste la necessità di ridurre al minimo l'accumulo di cariche elettrostatiche in modo da escludere il pericolo di combustione di sostanze infiammabili e vapori e nel caso in cui persista il rischio di scosse elettriche provenienti da elementi sotto tensione. Le calzature antistatiche non forniscono una protezione contro lo shock elettrico in quanto creano unicamente una resistenza elettrica tra il pavimento e il piede. Qualora non si possa escludere completamente il pericolo di uno shock elettrico, si dovrà ricorrere a precauzioni aggiuntive che dovrebbero fare parte di un programma periodico di prevenzione degli infortuni sul posto di lavoro.

Al fine di preservare i requisiti di antistaticità, le calzature non dovranno subire modifiche.

NB Tutte le calzature certificate con la vecchia normativa mantengono la validità del certificato fino alla scadenza dello stesso.

EN ISO 20345:2011		S1P SRC									
LINEA	ARTICOLO	REQUISITI				SETTORI CONSIGLIATI					📄
		REQUISITI SUPPLEMENTARI		METAL FREE	AUTOMOTIVE	EDILIZIA	ELETTRICITÀ	INDUSTRIA	LOGISTICA SERVIZI	TERMOIDRAULICA	
BASIC PLUS 	7210BKK			X	X	X	X	X	X	X	596
	7216BKK			X	X	X	X	X	X	X	597
FLEX 	7212G	ESD		X	X	X	X	X	X	X	593
	7212B	ESD									593
	7213G	ESD		X	X	X	X	X	X	X	593
FLEX LADY 	7212LG			X	X	X	X	X	X	X	593
EASY PLUS 	7222PEK			X	X	X	X	X	X	X	591
	7223PEK			X	X	X	X	X	X	X	592
	7224PEK			X	X	X	X	X	X	X	592
	7225PEK			X	X	X	X	X	X	X	592
BASIC 	7241BK				X	X	X	X	X	X	588
	7243BK				X	X	X	X	X	X	588
	7246BK				X	X	X	X	X	X	590
	7247BK				X	X	X	X	X	X	590
EASY 	7246E					X	X	X	X	587	
TREKKING 	7248GK				X	X	X	X	X	X	598
	7249GK	RS			X	X	X	X	X	X	598
ACTIVE 	7314AF			X	X	X	X	X	X	X	599
	7316NB	ESD		X	X	X	X	X	X	X	600
	7316NG	ESD		X	X	X	X	X	X	X	600
	7317NA			X	X	X	X	X	X	X	600
SNEAKERS PRO 	7340B				X	X	X	X	X	X	607
O-GRAVITY 	7352A	HRO		X	X	X	X	X	X	X	602
	7352B	HRO		X	X	X	X	X	X	X	602
	7352G	HRO ESD	X	X	X	X	X	X	X	X	602
	7353Y	HRO		X	X	X	X	X	X	X	603
	7372B	HRO	X	X	X	X	X	X	X	X	606
	7376A	HRO	X	X	X	X	X	X	X	X	606
O-GRAVITY LADY 	7352LG	HRO		X	X	X	X	X	X	X	603

EN ISO 20347:2012		O1 SRC										
O-GRAVITY 	7362B	FO HRO		X	X	X	X					605

EN ISO 20347:2012		O2 SRC										
BASIC 	7243FT	FO			X	X					X	589
O-GRAVITY 	7363N	FO HRO		X	X	X	X					605

EN ISO 20345:2011		S3 SRC										
LINEA	ARTICOLO	REQUISITI				SETTORI CONSIGLIATI					📄	
		REQUISITI SUPPLEMENTARI		METAL FREE	AGRICOLTURA	AUTOMOTIVE	EDILIZIA	INDUSTRIA	ELETTRICITÀ	LOGISTICA SERVIZI		OIL & GAS
BASIC PLUS 	7200BKK			X	X	X	X	X	X	X	X	596
	7201BKK			X	X	X	X	X	X	X	X	596
	7310CRK	RS HRO			X	X	X	X		X	X	597
FLEX 	7214FN			X	X	X	X	X	X	X	X	594
	7214G	ESD		X	X	X	X	X	X	X	X	594
	7215FN			X	X	X	X	X	X	X	X	595
	7218FN	RS		X	X	X	X	X	X	X	X	595
7218G	RS ESD		X	X	X	X	X	X	X	X	595	
FLEX LADY 	7214LN			X	X	X	X	X	X	X	X	594
EASY PLUS 	7220PEK			X	X	X	X	X	X	X	X	591
	7221PEK	RS		X	X	X	X	X	X	X	X	591
TREKKING 	7235BK				X	X	X	X	X	X	X	597
	7236BK	RS			X	X	X	X	X	X	X	598
	7238WR	RS HRO WR			X	X	X	X	X	X	X	598
7239B				X	X	X	X	X	X	X	598	
EASY 	7241EN				X	X	X	X	X	X	X	587
	7243EN	RS			X	X	X	X	X	X	X	587
BASIC 	7241CK				X	X	X	X	X	X	X	588
	7243CK	RS			X	X	X	X	X	X	X	589
	7243CR	RS HRO			X	X	X	X	X	X	X	589
	7245BK	RS			X	X	X	X	X	X	X	589
HEAVY DUTY 	7293HM	HRO HI	X		X	X	X	X	X	X	X	608
	7293HN	HRO HI	X		X	X	X	X	X	X	X	608
	7294HM	HRO HI	X		X	X	X	X	X	X	X	609
	7294HMC	HRO HI CI WR	X		X	X	X	X	X	X	X	609
7294HN	RS HRO HI	X		X	X	X	X	X	X	X	609	
ACTIVE 	7315AN			X	X	X	X	X	X	X	X	599
	7318AN			X	X	X	X	X	X	X	X	600
	7320NA			X	X	X	X	X	X	X	X	601
	7321NA	RS		X	X	X	X	X	X	X	X	601
	7322SA			X	X	X	X	X	X	X	X	601
	7323SA	RS		X	X	X	X	X	X	X	X	601
SNEAKERS PRO 	7341N				X	X	X	X	X	X	X	607
	7349RP	HRO		X	X	X	X	X	X	X	X	607
	7350RP	HRO		X	X	X	X	X	X	X	X	608
O-GRAVITY 	7354N	HRO		X	X	X	X	X	X	X	X	603
	7355V	HRO		X	X	X	X	X	X	X	X	603
	7356G	HRO		X	X	X	X	X	X	X	X	604
	7357G	HRO		X	X	X	X	X	X	X	X	604
	7356V	HRO		X	X	X	X	X	X	X	X	604
	7357V	HRO		X	X	X	X	X	X	X	X	605
O-GRAVITY LADY 	7356LN	HRO		X	X	X	X	X	X	X	X	604
O-GRAVITY 	7381N	HRO WR	X	X	X	X	X	X	X	X	X	606
	7382N	HRO WR	X	X	X	X	X	X	X	X	X	606

EN ISO 20345:2011		S5 SRC										
BASIC 	7328A				X	X	X	X	X	X	X	590
	7328N				X	X	X	X	X	X	X	590

EASY



7241EN

scarpe in pelle idrorepellente

- Puntale in acciaio
- Lamina antiperforazione in acciaio elastico

**EN ISO
20345
2011**



EU	UK	mm	Icona	Modello
35	2,5	230		1 072410835
36	3,5	237		1 072410836
37	4,5	244		1 072410837
38	5	250		1 072410838
39	6	257		1 072410839
40	6,5	264		1 072410840
41	7	270		1 072410841
42	8	277		1 072410842
43	9	284		1 072410843
44	10	290		1 072410844
45	10,5	297		1 072410845
46	11	304		1 072410846
47	12	310		1 072410847
48	13	317		1 072410848



CE

S3 SRC

7243EN

scarpe alte in pelle idrorepellente
con rapido sfilamento

- Puntale in acciaio
- Lamina antiperforazione in acciaio elastico

**EN ISO
20345
2011**



EU	UK	mm	Icona	Modello
35	2,5	230		1 072430835
36	3,5	237		1 072430836
37	4,5	244		1 072430837
38	5	250		1 072430838
39	6	257		1 072430839
40	6,5	264		1 072430840
41	7	270		1 072430841
42	8	277		1 072430842
43	9	284		1 072430843
44	10	290		1 072430844
45	10,5	297		1 072430845
46	11	304		1 072430846
47	12	310		1 072430847
48	13	317		1 072430848



CE

S3 RS SRC

7246E

scarpe basse in pelle scamosciata traforata

- Puntale in acciaio
- Lamina antiperforazione in acciaio elastico

**EN ISO
20345
2011**



EU	UK	mm	Icona	Modello
35	2,5	230		1 072460435
36	3,5	237		1 072460436
37	4,5	244		1 072460437
38	5	250		1 072460438
39	6	257		1 072460439
40	6,5	264		1 072460440
41	7	270		1 072460441
42	8	277		1 072460442
43	9	284		1 072460443
44	10	290		1 072460444
45	10,5	297		1 072460445
46	11	304		1 072460446
47	12	310		1 072460447
48	13	317		1 072460448



CE

S1P SRC

BASIC



7241BK

scarpe in pelle

- Punta in acciaio
- Lamina antiperforazione in fibra composita

**EN ISO
20345
2011**

EU	UK	mm
35	2,5	228
36	3,5	235
37	4,5	242
38	5	248
39	6	255
40	6,5	262
41	7	268
42	8	275
43	9	282
44	10	288
45	10,5	295
46	11	302
47	12	308
48	13	315

EU	UK	mm
1		072411235
1		072411236
1		072411237
1		072411238
1		072411239
1		072411240
1		072411241
1		072411242
1		072411243
1		072411244
1		072411245
1		072411246
1		072411247
1		072411248



CE

S1P SRC



7241CK

scarpe in pelle idrorepellente

- Punta in acciaio
- Lamina antiperforazione in fibra composita

**EN ISO
20345
2011**

EU	UK	mm
35	2,5	228
36	3,5	235
37	4,5	242
38	5	248
39	6	255
40	6,5	262
41	7	268
42	8	275
43	9	282
44	10	288
45	10,5	295
46	11	302
47	12	308
48	13	315

EU	UK	mm
1		072411535
1		072411536
1		072411537
1		072411538
1		072411539
1		072411540
1		072411541
1		072411542
1		072411543
1		072411544
1		072411545
1		072411546
1		072411547
1		072411548



CE

S3 SRC



7243BK

scarpe alte in pelle

- Punta in acciaio
- Lamina antiperforazione in fibra composita

**EN ISO
20345
2011**

EU	UK	mm
35	2,5	228
36	3,5	235
37	4,5	242
38	5	248
39	6	255
40	6,5	262
41	7	268
42	8	275
43	9	282
44	10	288
45	10,5	295
46	11	302
47	12	308
48	13	315

EU	UK	mm
1		072431235
1		072431236
1		072431237
1		072431238
1		072431239
1		072431240
1		072431241
1		072431242
1		072431243
1		072431244
1		072431245
1		072431246
1		072431247
1		072431248



CE

S1P SRC



7243CK

scarpe alte in pelle idrorepellente
con rapido sfilamento

- Puntale in acciaio
- Lamina antiperforazione in fibra composita

**EN ISO
20345
2011**



EU	UK	mm	
35	2,5	228	1 072431335
36	3,5	235	1 072431336
37	4,5	242	1 072431337
38	5	248	1 072431338
39	6	255	1 072431339
40	6,5	262	1 072431340
41	7	268	1 072431341
42	8	275	1 072431342
43	9	282	1 072431343
44	10	288	1 072431344
45	10,5	295	1 072431345
46	11	302	1 072431346
47	12	308	1 072431347
48	13	315	1 072431348

CE



S3 RS SRC

7243CR

scarpe alte in pelle idrorepellente
con suola in gomma ad alta resistenza
e rapido sfilamento

- Puntale in acciaio
- Lamina antiperforazione in acciaio elastico

**EN ISO
20345
2011**



EU	UK	mm	
35	2,5	231	1 072430735
36	3,5	238	1 072430736
37	4,5	245	1 072430737
38	5	251	1 072430738
39	6	258	1 072430739
40	6,5	265	1 072430740
41	7	271	1 072430741
42	8	278	1 072430742
43	9	285	1 072430743
44	10	291	1 072430744
45	10,5	298	1 072430745
46	11	305	1 072430746
47	12	311	1 072430747
48	13	318	1 072430748

CE



S3 RS HRO SRC

7243FT

scarpe alte in pelle idrorepellente
senza puntale e lamina antiperforazione

- Senza puntale
- Senza lamina antiperforazione

**EN ISO
20347
2012**



EU	UK	mm	
35	2,5	228	1 072430635
36	3,5	235	1 072430636
37	4,5	242	1 072430637
38	5	248	1 072430638
39	6	255	1 072430639
40	6,5	262	1 072430640
41	7	268	1 072430641
42	8	275	1 072430642
43	9	282	1 072430643
44	10	288	1 072430644
45	10,5	295	1 072430645
46	11	302	1 072430646
47	12	308	1 072430647
48	13	315	1 072430648

CE



O2 FO SRC

7245BK

scarpe alte "saldatore" stringate in pelle idrorepellente con
rapido sfilamento
e protezione frontale con chiusura a strappo

- Puntale in acciaio
- Lamina antiperforazione in fibra composita

**EN ISO
20345
2011**



EU	UK	mm	
35	2,5	228	1 072451235
36	3,5	235	1 072451236
37	4,5	242	1 072451237
38	5	248	1 072451238
39	6	255	1 072451239
40	6,5	262	1 072451240
41	7	268	1 072451241
42	8	275	1 072451242
43	9	282	1 072451243
44	10	288	1 072451244
45	10,5	295	1 072451245
46	11	302	1 072451246
47	12	308	1 072451247
48	13	315	1 072451248

CE



S3 RS SRC

7246BK
scarpe in pelle scamosciata traforata

- Puntale in acciaio
- Lamina antiperforazione in fibra composita

EU	UK	mm		
35	2,5	228	1	072461235
36	3,5	235	1	072461236
37	4,5	242	1	072461237
38	5	248	1	072461238
39	6	255	1	072461239
40	6,5	262	1	072461240
41	7	268	1	072461241
42	8	275	1	072461242
43	9	282	1	072461243
44	10	288	1	072461244
45	10,5	295	1	072461245
46	11	302	1	072461246
47	12	308	1	072461247
48	13	315	1	072461248

CE



S1P SRC

**EN ISO
20345
2011**



7247BK
sandali in pelle traforata

- Puntale in acciaio
- Lamina antiperforazione in fibra composita

EU	UK	mm		
35	2,5	228	1	072471235
36	3,5	235	1	072471236
37	4,5	242	1	072471237
38	5	248	1	072471238
39	6	255	1	072471239
40	6,5	262	1	072471240
41	7	268	1	072471241
42	8	275	1	072471242
43	9	282	1	072471243
44	10	288	1	072471244
45	10,5	295	1	072471245
46	11	302	1	072471246
47	12	308	1	072471247
48	13	315	1	072471248

CE



S1P SRC

**EN ISO
20345
2011**



7328A
stivali di sicurezza "alta visibilità" in PVC nitrilico.
Con battistrada antiscivolo autopulente.

- Puntale in acciaio
- Lamina antiperforazione in acciaio elastico

EU	UK	mm		
38	5	253	1	073280638
39	6	260	1	073280639
40	6,5	267	1	073280640
41	7	273	1	073280641
42	8	280	1	073280642
43	9	287	1	073280643
44	10	293	1	073280644
45	10,5	300	1	073280645
46	11	307	1	073280646
47	12	313	1	073280647

CE



S5 SRC

**EN ISO
20345
2011**



7328N
stivali di sicurezza in PVC nitrilico.
Con battistrada antiscivolo autopulente.

- Puntale in acciaio
- Lamina antiperforazione in acciaio elastico

EU	UK	mm		
38	5	253	1	073280838
39	6	260	1	073280839
40	6,5	267	1	073280840
41	7	273	1	073280841
42	8	280	1	073280842
43	9	287	1	073280843
44	10	293	1	073280844
45	10,5	300	1	073280845
46	11	307	1	073280846
47	12	313	1	073280847

CE



S5 SRC

**EN ISO
20345
2011**



EASY PLUS



7220PEK

scarpe in pelle idrorepellente con inserti in nylon e rinforzo antiabrasione nella zona del puntale

- Puntale in composito
- Lamina antiperforazione in fibra composita

**EN ISO
20345
2011**

METAL
FREE



EU	UK	mm	1
35	2,5	228	1 072200235
36	3,5	235	1 072200236
37	4,5	242	1 072200237
38	5	248	1 072200238
39	6	255	1 072200239
40	6,5	262	1 072200240
41	7	268	1 072200241
42	8	275	1 072200242
43	9	282	1 072200243
44	10	288	1 072200244
45	10,5	295	1 072200245
46	11	302	1 072200246
47	12	308	1 072200247
48	13	315	1 072200248

CE



S3 SRC

7221PEK

scarpe alte in pelle idrorepellente con inserti in nylon, rinforzo antiabrasione nella zona del puntale e rapido sfilamento

- Puntale in composito
- Lamina antiperforazione in fibra composita

**EN ISO
20345
2011**

METAL
FREE



EU	UK	mm	1
35	2,5	228	1 072210235
36	3,5	235	1 072210236
37	4,5	242	1 072210237
38	5	248	1 072210238
39	6	255	1 072210239
40	6,5	262	1 072210240
41	7	268	1 072210241
42	8	275	1 072210242
43	9	282	1 072210243
44	10	288	1 072210244
45	10,5	295	1 072210245
46	11	302	1 072210246
47	12	308	1 072210247
48	13	315	1 072210248

CE



S3 RS SRC

7222PEK

scarpe in pelle scamosciata traforata con inserti in mesh ad alta traspirabilità

- Puntale in composito
- Lamina antiperforazione in fibra composita

**EN ISO
20345
2011**

METAL
FREE



EU	UK	mm	1
35	2,5	228	1 072220135
36	3,5	235	1 072220136
37	4,5	242	1 072220137
38	5	248	1 072220138
39	6	255	1 072220139
40	6,5	262	1 072220140
41	7	268	1 072220141
42	8	275	1 072220142
43	9	282	1 072220143
44	10	288	1 072220144
45	10,5	295	1 072220145
46	11	302	1 072220146
47	12	308	1 072220147
48	13	315	1 072220148

CE



S1P SRC

7223PEK

scarpe in pelle scamosciata con inserti in mesh ad alta traspirazione e rinforzo antiabrasione nella zona del puntale

- Puntale in composito
- Lamina antiperforazione in fibra composita

**EN ISO
20345
2011**

EU	UK	mm	
35	2,5	228	1 072230135
36	3,5	235	1 072230136
37	4,5	242	1 072230137
38	5	248	1 072230138
39	6	255	1 072230139
40	6,5	262	1 072230140
41	7	268	1 072230141
42	8	275	1 072230142
43	9	282	1 072230143
44	10	288	1 072230144
45	10,5	295	1 072230145
46	11	302	1 072230146
47	12	308	1 072230147
48	13	315	1 072230148

CE



S1P SRC

METAL
GO
FREE



7224PEK

scarpe in pelle scamosciata traforata con rinforzo antiabrasione nella zona del puntale

- Puntale in composito
- Lamina antiperforazione in fibra composita

**EN ISO
20345
2011**

EU	UK	mm	
35	2,5	228	1 072240235
36	3,5	235	1 072240236
37	4,5	242	1 072240237
38	5	248	1 072240238
39	6	255	1 072240239
40	6,5	262	1 072240240
41	7	268	1 072240241
42	8	275	1 072240242
43	9	282	1 072240243
44	10	288	1 072240244
45	10,5	295	1 072240245
46	11	302	1 072240246
47	12	308	1 072240247
48	13	315	1 072240248

CE



S1P SRC

METAL
GO
FREE



7225PEK

scarpe in pelle scamosciata traforata

- Puntale in composito
- Lamina antiperforazione in fibra composita

**EN ISO
20345
2011**

EU	UK	mm	
35	2,5	228	1 072250135
36	3,5	235	1 072250136
37	4,5	242	1 072250137
38	5	248	1 072250138
39	6	255	1 072250139
40	6,5	262	1 072250140
41	7	268	1 072250141
42	8	275	1 072250142
43	9	282	1 072250143
44	10	288	1 072250144
45	10,5	295	1 072250145
46	11	302	1 072250146
47	12	308	1 072250147
48	13	315	1 072250148

CE



S1P SRC

METAL
GO
FREE

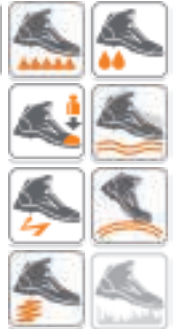

 **Beta**

FLEX



7212B

scarpe in pelle scamosciata, con inserti in mesh.
Con inserto antiabrasione nella zona del puntale
Estremamente flessibili e leggere - peso indicativo misura 42: **490 g**
Non indicate per impieghi gravosi (edilizia, agricoltura, industria pesante)

- Puntale in composito
- Lamina antiperforazione in fibra composita

**EN ISO
20345
2011**

EU	UK	mm	g
35	2.5	228	1 072120235
36	3.5	235	1 072120236
37	4.5	242	1 072120237
38	5	248	1 072120238
39	6	255	1 072120239
40	6.5	262	1 072120240
41	7	268	1 072120241
42	8	275	1 072120242
43	9	282	1 072120243
44	10	288	1 072120244
45	10.5	295	1 072120245
46	11	302	1 072120246
47	12	308	1 072120247
48	13	315	1 072120248



CE

S1P SRC ESD

7212G

scarpe in pelle scamosciata traforata.
Con inserto antiabrasione nella zona del puntale
Estremamente flessibili e leggere - peso indicativo misura 42: **490 g**
Non indicate per impieghi gravosi (edilizia, agricoltura, industria pesante)

- Puntale in composito
- Lamina antiperforazione in fibra composita

**EN ISO
20345
2011**

EU	UK	mm	g
35	2.5	228	1 072120335
36	3.5	235	1 072120336
37	4.5	242	1 072120337
38	5	248	1 072120338
39	6	255	1 072120339
40	6.5	262	1 072120340
41	7	268	1 072120341
42	8	275	1 072120342
43	9	282	1 072120343
44	10	288	1 072120344
45	10.5	295	1 072120345
46	11	302	1 072120346
47	12	308	1 072120347
48	13	315	1 072120348

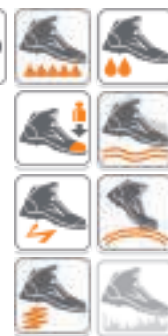

CE

S1P SRC ESD

7212LG

scarpe basse da donna
in pelle scamosciata traforata con inserti in mesh
Estremamente flessibili e leggere
peso indicativo misura 38: **380 g**
Non indicate per impieghi gravosi (edilizia, agricoltura, industria pesante)

- Puntale in composito
- Lamina antiperforazione in fibra composita

**EN ISO
20345
2011**

EU	UK	mm	g
34	2	222	1 072120134
35	2.5	228	1 072120135
36	3.5	235	1 072120136
37	4.5	242	1 072120137
38	5	248	1 072120138
39	6	255	1 072120139
40	6.5	262	1 072120140
41	7	268	1 072120141
42	8	275	1 072120142



CE

S1P SRC

7213G

scarpe in pelle scamosciata traforata con inserti in mesh ad alta traspirazione Estremamente flessibili e leggere - peso indicativo misura 42: **490 g**

Non indicate per impieghi gravosi (edilizia, agricoltura, industria pesante)

EU	UK	mm		
35	2.5	228	1	072130135
36	3.5	235	1	072130136
37	4.5	242	1	072130137
38	5	248	1	072130138
39	6	255	1	072130139
40	6.5	262	1	072130140
41	7	268	1	072130141
42	8	275	1	072130142
43	9	282	1	072130143
44	10	288	1	072130144
45	10.5	295	1	072130145
46	11	302	1	072130146
47	12	308	1	072130147
48	13	315	1	072130148

- Puntale in composito
- Lamina antiperforazione in fibra composita

**EN ISO
20345
2011**



CE

S1P SRC ESD

7214FN

scarpe in action nabuk idrorepellente con inserto antiabrasione nella zona del puntale Estremamente flessibili e leggere - peso indicativo misura 42: **500 g**

Non indicate per impieghi gravosi (edilizia, agricoltura, industria pesante)

EU	UK	mm		
35	2,5	228	1	072140035
36	3,5	235	1	072140036
37	4,5	242	1	072140037
38	5	248	1	072140038
39	6	255	1	072140039
40	6,5	262	1	072140040
41	7	268	1	072140041
42	8	275	1	072140042
43	9	282	1	072140043
44	10	288	1	072140044
45	10,5	295	1	072140045
46	11	302	1	072140046
47	12	308	1	072140047
48	13	315	1	072140048

- Puntale in composito
- Lamina antiperforazione in fibra composita

**EN ISO
20345
2011**



CE

S3 SRC

7214G

scarpe in action nabuk idrorepellente con inserto antiabrasione nella zona del puntale Estremamente flessibili e leggere - peso indicativo misura 42: **500 g**

Non indicate per impieghi gravosi (edilizia, agricoltura, industria pesante)

EU	UK	mm		
35	2.5	228	1	072140235
36	3.5	235	1	072140236
37	4.5	242	1	072140237
38	5	248	1	072140238
39	6	255	1	072140239
40	6.5	262	1	072140240
41	7	268	1	072140241
42	8	275	1	072140242
43	9	282	1	072140243
44	10	288	1	072140244
45	10.5	295	1	072140245
46	11	302	1	072140246
47	12	308	1	072140247
48	13	315	1	072140248

- Puntale in composito
- Lamina antiperforazione in fibra composita

**EN ISO
20345
2011**



CE

S3 SRC ESD

7214LN

scarpe basse da donna in pelle scamosciata idrorepellente con inserto antiabrasione nella zona del puntale Estremamente flessibili e leggere - peso indicativo misura 38: **380 g**

Non indicate per impieghi gravosi (edilizia, agricoltura, industria pesante)

EU	UK	mm		
34	2	222	1	072140134
35	2,5	228	1	072140135
36	3,5	235	1	072140136
37	4,5	242	1	072140137
38	5	248	1	072140138
39	6	255	1	072140139
40	6,5	262	1	072140140
41	7	268	1	072140141
42	8	275	1	072140142

- Puntale in composito
- Lamina antiperforazione in fibra composita

**EN ISO
20345
2011**



CE

S3 SRC

7215FN

mocassini in action nabuk idrorepellente
con inserto antiabrasione nella zona del puntale
Estremamente flessibili e leggere - peso indicativo misura 42: **490 g**
Non indicate per impieghi gravosi (edilizia, agricoltura, industria pesante)

- Puntale in composito
- Lamina antiperforazione in fibra composita

**EN ISO
20345
2011**

EU	UK	mm	
35	2,5	228	1 072150135
36	3,5	235	1 072150136
37	4,5	242	1 072150137
38	5	248	1 072150138
39	6	255	1 072150139
40	6,5	262	1 072150140
41	7	268	1 072150141
42	8	275	1 072150142
43	9	282	1 072150143
44	10	288	1 072150144
45	10,5	295	1 072150145
46	11	302	1 072150146
47	12	308	1 072150147
48	13	315	1 072150148

CE



S3 SRC



7218FN

scarpe alte in action nabuk idrorepellente con inserto antiabrasione nella zona del puntale e rapido sfilamento
Estremamente flessibili e leggere - peso indicativo misura 42: **510 g**
Non indicate per impieghi gravosi (edilizia, agricoltura, industria pesante)

- Puntale in composito
- Lamina antiperforazione in fibra composita

**EN ISO
20345
2011**

EU	UK	mm	
35	2,5	228	1 072180035
36	3,5	235	1 072180036
37	4,5	242	1 072180037
38	5	248	1 072180038
39	6	255	1 072180039
40	6,5	262	1 072180040
41	7	268	1 072180041
42	8	275	1 072180042
43	9	282	1 072180043
44	10	288	1 072180044
45	10,5	295	1 072180045
46	11	302	1 072180046
47	12	308	1 072180047
48	13	315	1 072180048

CE



S3 RS SRC



7218G

scarpe alte in action nabuk idrorepellente con inserto antiabrasione nella zona del puntale. Con rapido sfilamento
Estremamente flessibili e leggere - peso indicativo misura 42: **550 g**
Non indicate per impieghi gravosi (edilizia, agricoltura, industria pesante)

- Puntale in composito
- Lamina antiperforazione in fibra composita

**EN ISO
20345
2011**

EU	UK	mm	
35	2,5	228	1 072180135
36	3,5	235	1 072180136
37	4,5	242	1 072180137
38	5	248	1 072180138
39	6	255	1 072180139
40	6,5	262	1 072180140
41	7	268	1 072180141
42	8	275	1 072180142
43	9	282	1 072180143
44	10	288	1 072180144
45	10,5	295	1 072180145
46	11	302	1 072180146
47	12	308	1 072180147
48	13	315	1 072180148

CE



S3 RS SRC ESD



BASIC PLUS



7200BKK

scarpe in pelle pieno fiore idrorepellente

- Puntale in composito
- Lamina antiperforazione in fibra composita

**EN ISO
20345
2011**

EU	UK	mm		
35	2,5	228	1	072000235
36	3,5	235	1	072000236
37	4,5	242	1	072000237
38	5	248	1	072000238
39	6	255	1	072000239
40	6,5	262	1	072000240
41	7	268	1	072000241
42	8	275	1	072000242
43	9	282	1	072000243
44	10	288	1	072000244
45	10,5	295	1	072000245
46	11	302	1	072000246
47	12	308	1	072000247
48	13	315	1	072000248

CE



S3 SRC

METAL
GO
FREE



7201BKK

scarpe alte in pelle pieno fiore idrorepellente

- Puntale in composito
- Lamina antiperforazione in fibra composita

**EN ISO
20345
2011**

EU	UK	mm		
35	2,5	228	1	072010435
36	3,5	235	1	072010436
37	4,5	242	1	072010437
38	5	248	1	072010438
39	6	255	1	072010439
40	6,5	262	1	072010440
41	7	268	1	072010441
42	8	275	1	072010442
43	9	282	1	072010443
44	10	288	1	072010444
45	10,5	295	1	072010445
46	11	302	1	072010446
47	12	308	1	072010447
48	13	315	1	072010448

CE



S3 SRC

METAL
GO
FREE



7210BKK

scarpe in morbida pelle scamosciata traforata

- Puntale in composito
- Lamina antiperforazione in fibra composita

**EN ISO
20345
2011**

EU	UK	mm		
35	2,5	228	1	072100335
36	3,5	235	1	072100336
37	4,5	242	1	072100337
38	5	248	1	072100338
39	6	255	1	072100339
40	6,5	262	1	072100340
41	7	268	1	072100341
42	8	275	1	072100342
43	9	282	1	072100343
44	10	288	1	072100344
45	10,5	295	1	072100345
46	11	302	1	072100346
47	12	308	1	072100347
48	13	315	1	072100348

CE



S1P SRC

METAL
GO
FREE



7216BKK

sandali in morbida pelle scamosciata
con chiusura a strappo

- Puntale in composito
- Lamina antiperforazione in fibra composita

**EN ISO
20345
2011**

EU	UK	mm	
35	2,5	228	1 072160335
36	3,5	235	1 072160336
37	4,5	242	1 072160337
38	5	248	1 072160338
39	6	255	1 072160339
40	6,5	262	1 072160340
41	7	268	1 072160341
42	8	275	1 072160342
43	9	282	1 072160343
44	10	288	1 072160344
45	10,5	295	1 072160345
46	11	302	1 072160346
47	12	308	1 072160347
48	13	315	1 072160348



7310CRK

scarpe "saldatore" stringate in pelle stampata idrorepellente
con rapido sfilamento e protezione frontale con chiusura
a strappo e cuciture antifiama. Suola in gomma ad alta
resistenza ed inserto antiabrasione nella zona del puntale

- Puntale in composito
- Lamina antiperforazione in fibra composita

**EN ISO
20345
2011**

EU	UK	mm	
35	2,5	227	1 073100335
36	3,5	234	1 073100336
37	4,5	241	1 073100337
38	5	247	1 073100338
39	6	254	1 073100339
40	6,5	261	1 073100340
41	7	267	1 073100341
42	8	274	1 073100342
43	9	281	1 073100343
44	10	287	1 073100344
45	10,5	294	1 073100345
46	11	301	1 073100346
47	12	307	1 073100347
48	13	314	1 073100348



TREKKING



7235BK

scarpe basse in action nabuk idrorepellente
con copripuntale di rinforzo in poliuretano

- Puntale in acciaio
- Lamina antiperforazione in fibra composita

**EN ISO
20345
2011**

EU	UK	mm	
35	2,5	228	1 072350335
36	3,5	235	1 072350336
37	4,5	242	1 072350337
38	5	248	1 072350338
39	6	255	1 072350339
40	6,5	262	1 072350340
41	7	268	1 072350341
42	8	275	1 072350342
43	9	282	1 072350343
44	10	288	1 072350344
45	10,5	295	1 072350345
46	11	302	1 072350346
47	12	308	1 072350347
48	13	315	1 072350348



7236BK

scarpe alte in action nabuk idrorepellente
con rapido sfilamento e copripuntale di rinforzo in poliuretano

- Puntale in acciaio
- Lamina antiperforazione in fibra composita

EU	UK	mm		
35	2,5	228	1	072360335
36	3,5	235	1	072360336
37	4,5	242	1	072360337
38	5	248	1	072360338
39	6	255	1	072360339
40	6,5	262	1	072360340
41	7	268	1	072360341
42	8	275	1	072360342
43	9	282	1	072360343
44	10	288	1	072360344
45	10,5	295	1	072360345
46	11	302	1	072360346
47	12	308	1	072360347
48	13	315	1	072360348

CE



S3 RS SRC

EN ISO
20345
2011



7238WR

scarpe alte in pelle scamosciata con inserti in nylon, suola in gomma
ad alta resistenza e rapido sfilamento Calzatura WR resistente
all'acqua: sottoposta a prova, in una vasca con 3 cm di acqua, dopo
100 lunghezze, l'area totale bagnata all'interno della calzatura non
deve superare i 3 cm² (macchia)

- Puntale in composito
- Lamina antiperforazione in fibra composita

EU	UK	mm		
35	2,5	228	1	072380235
36	3,5	235	1	072380236
37	4,5	242	1	072380237
38	5	248	1	072380238
39	6	255	1	072380239
40	6,5	262	1	072380240
41	7	268	1	072380241
42	8	275	1	072380242
43	9	282	1	072380243
44	10	288	1	072380244
45	10,5	295	1	072380245
46	11	302	1	072380246
47	12	308	1	072380247
48	13	315	1	072380248

CE



S3 RS WR HRO SRC

EN ISO
20345
2011



7239B

stivaletti in pelle nabuk idrorepellente, con inserti in mesh e
copripuntale di rinforzo in poliuretano

- Puntale in acciaio
- Lamina antiperforazione in fibra composita

EU	UK	mm		
39	6	258	1	072390339
40	6,5	265	1	072390340
41	7	271	1	072390341
42	8	278	1	072390342
43	9	285	1	072390343
44	10	291	1	072390344
45	10,5	298	1	072390345
46	11	305	1	072390346
47	12	311	1	072390347
48	13	318	1	072390348

CE



S3 SRC

EN ISO
20345
2011



7248GK

scarpe basse in pelle scamosciata con inserti in nylon
e copripuntale di rinforzo in poliuretano

- Puntale in acciaio
- Lamina antiperforazione fibra composita

EU	UK	mm		
35	2,5	231	1	072480235
36	3,5	238	1	072480236
37	4,5	245	1	072480237
38	5	251	1	072480238
39	6	258	1	072480239
40	6,5	265	1	072480240
41	7	271	1	072480241
42	8	278	1	072480242
43	9	285	1	072480243
44	10	291	1	072480244
45	10,5	298	1	072480245
46	11	305	1	072480246
47	12	311	1	072480247
48	13	318	1	072480248

CE



S1P SRC

EN ISO
20345
2011



7249GK

scarpe alte in pelle scamosciata con inserti in nylon,
rapido sfilamento e copripuntale di rinforzo in poliuretano

- Puntale in acciaio
- Lamina antiperforazione in fibra composita

EU	UK	mm	
35	2,5	231	1 072490235
36	3,5	238	1 072490236
37	4,5	245	1 072490237
38	5	251	1 072490238
39	6	258	1 072490239
40	6,5	265	1 072490240
41	7	271	1 072490241
42	8	278	1 072490242
43	9	285	1 072490243
44	10	291	1 072490244
45	10,5	298	1 072490245
46	11	305	1 072490246
47	12	311	1 072490247
48	13	318	1 072490248

CE



S1P RS SRC

EN ISO
20345
2011



ACTIVE

7314AF

scarpe in pelle scamosciata
con inserti in nylon mesh e carbon

- Puntale in composito
- Lamina antiperforazione in fibra composita

EU	UK	mm	
35	2,5	228	1 073140235
36	3,5	235	1 073140236
37	4,5	242	1 073140237
38	5	248	1 073140238
39	6	255	1 073140239
40	6,5	262	1 073140240
41	7	268	1 073140241
42	8	275	1 073140242
43	9	282	1 073140243
44	10	288	1 073140244
45	10,5	295	1 073140245
46	11	302	1 073140246
47	12	308	1 073140247
48	13	315	1 073140248

CE



S1P SRC

EN ISO
20345
2011

METAL
FREE



7315AN

scarpe in pelle scamosciata e microfibra
idrorepellenti con inserti in carbon

- Puntale in composito
- Lamina antiperforazione in fibra composita

EU	UK	mm	
35	2,5	228	1 073150535
36	3,5	235	1 073150536
37	4,5	242	1 073150537
38	5	248	1 073150538
39	6	255	1 073150539
40	6,5	262	1 073150540
41	7	268	1 073150541
42	8	275	1 073150542
43	9	282	1 073150543
44	10	288	1 073150544
45	10,5	295	1 073150545
46	11	302	1 073150546
47	12	308	1 073150547
48	13	315	1 073150548

CE



S3 SRC

EN ISO
20345
2011

METAL
FREE



7316NG

scarpe in mesh ad alta traspirazione e pelle scamosciata con supporto di stabilità al tallone

- Puntale in composito
- Lamina antiperforazione in fibra composita

EU	UK	mm		
35	2.5	228	1	073160635
36	3.5	235	1	073160636
37	4.5	242	1	073160637
38	5	248	1	073160638
39	6	255	1	073160639
40	6.5	262	1	073160640
41	7	268	1	073160641
42	8	275	1	073160642
43	9	282	1	073160643
44	10	288	1	073160644
45	10.5	295	1	073160645
46	11	302	1	073160646
47	12	308	1	073160647
48	13	315	1	073160648

CE



S1P SRC ESD



7316NB

scarpe in mesh ad alta traspirazione e pelle scamosciata con supporto di stabilità al tallone

- Puntale in composito
- Lamina antiperforazione in fibra composita

EU	UK	mm		
35	2.5	228	1	073160735
36	3.5	235	1	073160736
37	4.5	242	1	073160737
38	5	248	1	073160738
39	6	255	1	073160739
40	6.5	262	1	073160740
41	7	268	1	073160741
42	8	275	1	073160742
43	9	282	1	073160743
44	10	288	1	073160744
45	10.5	295	1	073160745
46	11	302	1	073160746
47	12	308	1	073160747
48	13	315	1	073160748

CE



S1P SRC ESD



7317NA

scarpe in pelle scamosciata traforata con supporto di stabilità al tallone

- Puntale in composito
- Lamina antiperforazione in fibra composita

EU	UK	mm		
35	2,5	228	1	073170135
36	3,5	235	1	073170136
37	4,5	242	1	073170137
38	5	248	1	073170138
39	6	255	1	073170139
40	6,5	262	1	073170140
41	7	268	1	073170141
42	8	275	1	073170142
43	9	282	1	073170143
44	10	288	1	073170144
45	10,5	295	1	073170145
46	11	302	1	073170146
47	12	308	1	073170147
48	13	315	1	073170148

CE



S1P SRC



7318AN

scarpe alte in pelle scamosciata e microfibra idrorepellenti con inserti in carbon

- Puntale in composito
- Lamina antiperforazione in fibra composita

EU	UK	mm		
35	2,5	228	1	073180535
36	3,5	235	1	073180536
37	4,5	242	1	073180537
38	5	248	1	073180538
39	6	255	1	073180539
40	6,5	262	1	073180540
41	7	268	1	073180541
42	8	275	1	073180542
43	9	282	1	073180543
44	10	288	1	073180544
45	10,5	295	1	073180545
46	11	302	1	073180546
47	12	308	1	073180547
48	13	315	1	073180548

CE



S3 SRC



7320NA

scarpe in action nabuk idrorepellente
con rinforzo antiabrasione nella zona del puntale
e supporto di stabilità al tallone

- Puntale in composito
- Lamina antiperforazione in fibra composita

EU	UK	mm	
35	2,5	228	1 073200435
36	3,5	235	1 073200436
37	4,5	242	1 073200437
38	5	248	1 073200438
39	6	255	1 073200439
40	6,5	262	1 073200440
41	7	268	1 073200441
42	8	275	1 073200442
43	9	282	1 073200443
44	10	288	1 073200444
45	10,5	295	1 073200445
46	11	302	1 073200446
47	12	308	1 073200447
48	13	315	1 073200448



CE

S3 SRC



EN ISO
20345
2011



7321NA

scarpe alte in action nabuk idrorepellente
con rapido sfilamento, rinforzo antiabrasione
nella zona del puntale e supporto di stabilità al tallone

- Puntale in composito
- Lamina antiperforazione in fibra composita

EU	UK	mm	
35	2,5	228	1 073210435
36	3,5	235	1 073210436
37	4,5	242	1 073210437
38	5	248	1 073210438
39	6	255	1 073210439
40	6,5	262	1 073210440
41	7	268	1 073210441
42	8	275	1 073210442
43	9	282	1 073210443
44	10	288	1 073210444
45	10,5	295	1 073210445
46	11	302	1 073210446
47	12	308	1 073210447
48	13	315	1 073210448



CE

S3 RS SRC



EN ISO
20345
2011



7322SA

scarpe in tessuto altamente resistente all'abrasione
con supporto di stabilità al tallone

- Puntale in composito
- Lamina antiperforazione in fibra composita

EU	UK	mm	
35	2,5	228	1 073220435
36	3,5	235	1 073220436
37	4,5	242	1 073220437
38	5	248	1 073220438
39	6	255	1 073220439
40	6,5	262	1 073220440
41	7	268	1 073220441
42	8	275	1 073220442
43	9	282	1 073220443
44	10	288	1 073220444
45	10,5	295	1 073220445
46	11	302	1 073220446
47	12	308	1 073220447
48	13	315	1 073220448



CE

S3 SRC



EN ISO
20345
2011



7323SA

scarpe alte in tessuto altamente resistente all'abrasione
con rapido sfilamento e supporto di stabilità al tallone

- Puntale in composito
- Lamina antiperforazione in fibra composita

EU	UK	mm	
35	2,5	228	1 073230435
36	3,5	235	1 073230436
37	4,5	242	1 073230437
38	5	248	1 073230438
39	6	255	1 073230439
40	6,5	262	1 073230440
41	7	268	1 073230441
42	8	275	1 073230442
43	9	282	1 073230443
44	10	288	1 073230444
45	10,5	295	1 073230445
46	11	302	1 073230446
47	12	308	1 073230447
48	13	315	1 073230448



CE

S3 RS SRC



EN ISO
20345
2011



O-GRAVITY



7352A

scarpe in tessuto mesh ad alta traspirazione con inserti in TPU
Supporto di stabilità tallone, collare "slip on" elasticizzato per facilitare la calzatura
e suola in EVA con battistrada in gomma nitrilica ad alta resistenza

- Puntale in composito
- Lamina antiperforazione in fibra composita
- **LEGGEREZZA STRAORDINARIA:** peso indicativo misura 42: 450 grammi

EN ISO 20345 2011

EU	UK	mm	1	2
38	5	254	1	073520038
39	6	261	1	073520039
40	6,5	268	1	073520040
41	7	274	1	073520041
42	8	281	1	073520042
43	9	288	1	073520043
44	10	294	1	073520044
45	10,5	301	1	073520045
46	11	308	1	073520046
47	12	314	1	073520047
48	13	321	1	073520048



CE

S1P HRO SRC

7352B

scarpe in tessuto mesh ad alta traspirazione con inserti in TPU
Supporto di stabilità tallone, collare "slip on" elasticizzato per facilitare la calzatura
e suola in EVA con battistrada in gomma nitrilica ad alta resistenza

- Puntale in composito
- Lamina antiperforazione in fibra composita
- **LEGGEREZZA STRAORDINARIA:** peso indicativo misura 42: 450 grammi

EN ISO 20345 2011

EU	UK	mm	1	2
38	5	254	1	073520138
39	6	261	1	073520139
40	6,5	268	1	073520140
41	7	274	1	073520141
42	8	281	1	073520142
43	9	288	1	073520143
44	10	294	1	073520144
45	10,5	301	1	073520145
46	11	308	1	073520146
47	12	314	1	073520147
48	13	321	1	073520148



CE

S1P HRO SRC

7352G

scarpe in tessuto mesh ad alta traspirazione con inserti in TPU
Supporto di stabilità tallone, **allacciatura tradizionale e calzatura ampia.**
Suola in EVA con battistrada in gomma nitrilica ad alta resistenza

- Puntale in composito
- Lamina antiperforazione in fibra composita
- **LEGGEREZZA STRAORDINARIA:** peso indicativo misura 42: 450 grammi

EN ISO 20345 2011

EU	UK	mm	1	2
38	5	254	1	073520338
39	6	261	1	073520339
40	6,5	268	1	073520340
41	7	274	1	073520341
42	8	281	1	073520342
43	9	288	1	073520343
44	10	294	1	073520344
45	10,5	301	1	073520345
46	11	308	1	073520346
47	12	314	1	073520347
48	13	321	1	073520348



CE

S1P HRO SRC ESD

7352LG

scarpe basse da donna in tessuto mesh ad alta traspirazione con inserti in TPU

Tomaia dotata di speciali maglie riflettenti ad alta visibilità

Supporto di stabilità tallone, collare "slip on" elasticizzato per facilitare la calzata

e suola in EVA con battistrada in gomma nitrilica ad alta resistenza

- Puntale in composito
- Lamina antiperforazione in fibra composita
- **LEGGEREZZA STRAORDINARIA:** peso indicativo misura 38: **390 grammi**

EN ISO 20345 2011

EU	UK	mm		
34	2	228	1	073520234
35	2,5	234	1	073520235
36	3,5	241	1	073520236
37	4,5	248	1	073520237
38	5	254	1	073520238
39	6	261	1	073520239
40	6,5	268	1	073520240
41	7	274	1	073520241
42	8	281	1	073520242



lady



CE

S1P HRO SRC

7353Y

scarpe in tessuto mesh ad alta traspirazione con inserti in TPU

Tomaia dotata di speciali maglie riflettenti ad alta visibilità

Supporto di stabilità tallone, collare "slip on" elasticizzato per facilitare la calzata

e suola in EVA con battistrada in gomma nitrilica ad alta resistenza

- Puntale in fibra di carbonio
- Lamina antiperforazione in fibra composita
- **LEGGEREZZA STRAORDINARIA:** peso indicativo misura 42: **420 grammi**

EN ISO 20345 2011

EU	UK	mm		
38	5	254	1	073530038
39	6	261	1	073530039
40	6,5	268	1	073530040
41	7	274	1	073530041
42	8	281	1	073530042
43	9	288	1	073530043
44	10	294	1	073530044
45	10,5	301	1	073530045
46	11	308	1	073530046
47	12	314	1	073530047
48	13	321	1	073530048



CE

S1P HRO SRC

7354N

scarpe in tessuto mesh idrorepellente con inserti in TPU

Supporto di stabilità tallone, collare "slip on" elasticizzato per facilitare la calzata

e suola in EVA con battistrada in gomma nitrilica ad alta resistenza

- Puntale in composito
- Lamina antiperforazione in fibra composita
- **LEGGEREZZA STRAORDINARIA:** peso indicativo misura 42: **460 grammi**

EN ISO 20345 2011

EU	UK	mm		
38	5	254	1	073540038
39	6	261	1	073540039
40	6,5	268	1	073540040
41	7	274	1	073540041
42	8	281	1	073540042
43	9	288	1	073540043
44	10	294	1	073540044
45	10,5	301	1	073540045
46	11	308	1	073540046
47	12	314	1	073540047
48	13	321	1	073540048



CE

S3 HRO SRC

7355V

scarpe alte in tessuto mesh idrorepellente con inserti in TPU

Supporto di stabilità tallone, collare "slip on" elasticizzato per facilitare la calzata

e suola in EVA con battistrada in gomma nitrilica ad alta resistenza

- Puntale in composito
- Lamina antiperforazione in fibra composita
- **LEGGEREZZA STRAORDINARIA:** peso indicativo misura 42: **465 grammi**

EN ISO 20345 2011

EU	UK	mm		
38	5	254	1	073550038
39	6	261	1	073550039
40	6,5	268	1	073550040
41	7	274	1	073550041
42	8	281	1	073550042
43	9	288	1	073550043
44	10	294	1	073550044
45	10,5	301	1	073550045
46	11	308	1	073550046
47	12	314	1	073550047
48	13	321	1	073550048



CE

S3 HRO SRC

7356G

scarpe in microfibra idrorepellente con inserti in TPU
Supporto di stabilità tallone, collare "slip on" elasticizzato per facilitare la calzatura e suola in EVA con battistrada in gomma nitrilica ad alta resistenza

- Puntale in composito
- Lamina antiperforazione in fibra composita
- **LEGGEREZZA STRAORDINARIA:** peso indicativo misura 42: 460 grammi

**EN ISO
20345
2011**

EU	UK	mm		
38	5	254	1	073560038
39	6	261	1	073560039
40	6,5	268	1	073560040
41	7	274	1	073560041
42	8	281	1	073560042
43	9	288	1	073560043
44	10	294	1	073560044
45	10,5	301	1	073560045
46	11	308	1	073560046
47	12	314	1	073560047
48	13	321	1	073560048



CE

S3 HRO SRC

7356V

scarpe in microfibra idrorepellente con inserti in TPU
Supporto di stabilità tallone, collare "slip on" elasticizzato per facilitare la calzatura e suola in EVA con battistrada in gomma nitrilica ad alta resistenza

- Puntale in composito
- Lamina antiperforazione in fibra composita
- **LEGGEREZZA STRAORDINARIA:** peso indicativo misura 42: 460 grammi

**EN ISO
20345
2011**

EU	UK	mm		
38	5	254	1	073560138
39	6	261	1	073560139
40	6,5	268	1	073560140
41	7	274	1	073560141
42	8	281	1	073560142
43	9	288	1	073560143
44	10	294	1	073560144
45	10,5	301	1	073560145
46	11	308	1	073560146
47	12	314	1	073560147
48	13	321	1	073560148



CE

S3 HRO SRC

7356LN

scarpe basse da donna in microfibra idrorepellente con inserti in TPU
Supporto di stabilità tallone, collare "slip on" elasticizzato per facilitare la calzatura e suola in EVA con battistrada in gomma nitrilica ad alta resistenza

- Puntale in composito
- Lamina antiperforazione in fibra composita
- **LEGGEREZZA STRAORDINARIA:** peso indicativo misura 38: 400 grammi

**EN ISO
20345
2011**

EU	UK	mm		
34	2	228	1	073560234
35	2,5	234	1	073560235
36	3,5	241	1	073560236
37	4,5	248	1	073560237
38	5	254	1	073560238
39	6	261	1	073560239
40	6,5	268	1	073560240
41	7	274	1	073560241
42	8	281	1	073560242



CE

S3 HRO SRC

7357G

scarpe alte in microfibra idrorepellente con inserti in TPU
Supporto di stabilità tallone e suola in EVA con battistrada in gomma nitrilica ad alta resistenza

- Puntale in composito
- Lamina antiperforazione in fibra composita
- **LEGGEREZZA STRAORDINARIA:** peso indicativo misura 42: 480 grammi

**EN ISO
20345
2011**

EU	UK	mm		
38	5	254	1	073570038
39	6	261	1	073570039
40	6,5	268	1	073570040
41	7	274	1	073570041
42	8	281	1	073570042
43	9	288	1	073570043
44	10	294	1	073570044
45	10,5	301	1	073570045
46	11	308	1	073570046
47	12	314	1	073570047
48	13	321	1	073570048



CE

S3 HRO SRC

7357V

scarpe alte in microfibra idrorepellente con inserti in TPU
 Supporto di stabilità tallone, collare elasticizzato per facilitare la calzatura e suola in EVA con battistrada in gomma nitrilica ad alta resistenza

- Puntale in composito
- Lamina antiperforazione in fibra composita
- **LEGGEREZZA STRAORDINARIA:** peso indicativo misura 42: 480 grammi

**EN ISO
20345
2011**

EU	UK	mm	
38	5	254	1 073570138
39	6	261	1 073570139
40	6,5	268	1 073570140
41	7	274	1 073570141
42	8	281	1 073570142
43	9	288	1 073570143
44	10	294	1 073570144
45	10,5	301	1 073570145
46	11	308	1 073570146
47	12	314	1 073570147
48	13	321	1 073570148

CE



S3 HRO SRC



7362B

scarpe "occupational" in tessuto mesh ad alta traspirazione con inserti in TPU
 Supporto di stabilità tallone, collare "slip on" elasticizzato per facilitare la calzatura e suola in EVA con battistrada in gomma nitrilica ad alta resistenza

- Senza puntale
- Senza lamina antiperforazione
- **LEGGEREZZA STRAORDINARIA:** peso indicativo misura 42: 330 grammi

**EN ISO
20347
2012**

EU	UK	mm	
39	6	261	1 073620039
40	6,5	268	1 073620040
41	7	274	1 073620041
42	8	281	1 073620042
43	9	288	1 073620043
44	10	294	1 073620044
45	10,5	301	1 073620045
46	11	308	1 073620046
47	12	314	1 073620047
48	13	321	1 073620048

CE



01 FO HRO SRC



7363N

scarpe "occupational" in tessuto mesh idrorepellente con inserti in TPU
 Supporto di stabilità tallone, collare "slip on" elasticizzato per facilitare la calzatura e suola in EVA con battistrada in gomma nitrilica ad alta resistenza

- Senza puntale
- Senza lamina antiperforazione
- **LEGGEREZZA STRAORDINARIA:** peso indicativo misura 42: 330 grammi

**EN ISO
20347
2012**

EU	UK	mm	
39	6	261	1 073630039
40	6,5	268	1 073630040
41	7	274	1 073630041
42	8	281	1 073630042
43	9	288	1 073630043
44	10	294	1 073630044
45	10,5	301	1 073630045
46	11	308	1 073630046
47	12	314	1 073630047
48	13	321	1 073630048

CE



02 FO HRO SRC



 **Beta**

7372B

scarpe in tessuto intrecciato resistente e ad altissima traspirazione.
Supporto di stabilità tallone, **allacciatura tradizionale e calzata ampia.**
Suola in EVA con battistrada in gomma nitrilica ad alta resistenza.

- Puntale in composito
- Lamina antiperforazione in fibra composita
- **LEGGEREZZA STRAORDINARIA:** peso indicativo misura 42: 450 grammi

**EN ISO
20345
2011**

EU	UK	mm		
38	5	254	1	073720038
39	6	261	1	073720039
40	6,5	268	1	073720040
41	7	274	1	073720041
42	8	281	1	073720042
43	9	288	1	073720043
44	10	294	1	073720044
45	10,5	301	1	073720045
46	11	308	1	073720046
47	12	314	1	073720047
48	13	321	1	073720048



CE

S1P HRO SRC

7376A

sandalo in microfibra traforata e mesh ad alta traspirazione
Supporto di stabilità tallone, **allacciatura tradizionale con lacci elasticizzati e calzata ampia.**
Suola in EVA con battistrada in gomma nitrilica ad alta resistenza

- Puntale in composito
- Lamina antiperforazione in fibra composita
- **LEGGEREZZA STRAORDINARIA:** peso indicativo misura 42: 490 grammi

**EN ISO
20345
2011**

EU	UK	mm		
38	5	254	1	073760038
39	6	261	1	073760039
40	6,5	268	1	073760040
41	7	274	1	073760041
42	8	281	1	073760042
43	9	288	1	073760043
44	10	294	1	073760044
45	10,5	301	1	073760045
46	11	308	1	073760046
47	12	314	1	073760047
48	13	321	1	073760048



CE

S1P HRO SRC

7381N

scarpe impermeabili in tessuto altamente **resistente all'abrasione** con inserti in TPU. Supporto di stabilità tallone, allacciatura tradizionale e **calzata ampia.** Suola in EVA con battistrada in gomma nitrilica ad alta resistenza

- Puntale in composito
- Lamina antiperforazione in fibra composita
- Membrana impermeabilizzante Beta TECH, con sistema "bootie"
- **LEGGERE:** peso indicativo misura 42: 500 grammi

**EN ISO
20345
2011**

EU	UK	mm		
38	5	254	1	073810038
39	6	261	1	073810039
40	6,5	268	1	073810040
41	7	274	1	073810041
42	8	281	1	073810042
43	9	288	1	073810043
44	10	294	1	073810044
45	10,5	301	1	073810045
46	11	308	1	073810046
47	12	314	1	073810047
48	13	321	1	073810048



CE

S3 SRC HRO WR

7382N

scarpe alte **impermeabili** in tessuto altamente **resistente all'abrasione** con inserti in TPU. Supporto di stabilità tallone, allacciatura tradizionale e **calzata ampia.** Suola in EVA con battistrada in gomma nitrilica ad alta resistenza

- Puntale in composito
- Lamina antiperforazione in fibra composita
- Membrana impermeabilizzante Beta TECH, con sistema "bootie"
- **LEGGERE:** peso indicativo misura 42: 550 grammi

**EN ISO
20345
2011**

EU	UK	mm		
38	5	254	1	073820038
39	6	261	1	073820039
40	6,5	268	1	073820040
41	7	274	1	073820041
42	8	281	1	073820042
43	9	288	1	073820043
44	10	294	1	073820044
45	10,5	301	1	073820045
46	11	308	1	073820046
47	12	314	1	073820047
48	13	321	1	073820048



CE

S3 SRC HRO WR

SNEAKERS PRO



7340B

scarpe in tessuto mesh ad alta traspirazione
con inserti in PU Alta Frequenza e rinforzo protettivo
del puntale in crosta scamosciata.
Estremamente leggere - peso indicativo misura 42: **470 g**

- Puntale in alluminio
- Lamina antiperforazione in fibra composita
- Sistema di chiusura FixLock, semplifica la calzata e lo sfilamento della scarpa (in dotazione anche stringhe tradizionali)

**EN ISO
20345
2011**



EU	UK	mm	U	U
36	3,5	238	1	073400236
37	4,5	245	1	073400237
38	5	251	1	073400238
39	6	258	1	073400239
40	6,5	265	1	073400240
41	7	271	1	073400241
42	8	278	1	073400242
43	9	285	1	073400243
44	10	291	1	073400244
45	10,5	298	1	073400245
46	11	305	1	073400246
47	12	311	1	073400247



CE

S1P SRC

7341N

scarpe in micro pelle scamosciata idrorepellente
con inserti in PU Alta Frequenza e rinforzo protettivo
del puntale in crosta scamosciata.
Estremamente leggere - peso indicativo misura 42: **470 g**

- Puntale in alluminio
- Lamina antiperforazione in fibra composita
- Sistema di chiusura FixLock, semplifica la calzata e lo sfilamento della scarpa (in dotazione anche stringhe tradizionali)

**EN ISO
20345
2011**



EU	UK	mm	U	U
36	3,5	238	1	073410236
37	4,5	245	1	073410237
38	5	251	1	073410238
39	6	258	1	073410239
40	6,5	265	1	073410240
41	7	271	1	073410241
42	8	278	1	073410242
43	9	285	1	073410243
44	10	291	1	073410244
45	10,5	298	1	073410245
46	11	305	1	073410246
47	12	311	1	073410247



CE

S3 SRC

7349RP

scarpe in crosta nabukata idrorepellente
con suola in gomma e anello in morbido PU

- Puntale in composito
- Lamina antiperforazione in fibra composita

**EN ISO
20345
2011**

METAL
FREE



EU	UK	mm	U	U
38	5	254	1	073490138
39	6	260	1	073490139
40	6,5	267	1	073490140
41	7	274	1	073490141
42	8	280	1	073490142
43	9	287	1	073490143
44	10	294	1	073490144
45	10,5	300	1	073490145
46	11	307	1	073490146
47	12	314	1	073490147



CE

S3 HRO SRC

7350RP

scarpe alte in crosta nabukata idrorepellente con suola in gomma e anello in morbido PU

- Puntale in composito
- Lamina antiperforazione in fibra composita

**EN ISO
20345
2011**

METAL
FREE



EU	UK	mm	EU	mm
38	5	254	1	073500138
39	6	260	1	073500139
40	6,5	267	1	073500140
41	7	274	1	073500141
42	8	280	1	073500142
43	9	287	1	073500143
44	10	294	1	073500144
45	10,5	300	1	073500145
46	11	307	1	073500146
47	12	314	1	073500147



CE

S3 HRO SRC

HEAVY DUTY



7293HM

scarpe in pelle pieno fiore ingrassata idrorepellente con battistrada in gomma VIBRAM® ad alte prestazioni, inserto antiabrasione sul tallone e copripuntale di rinforzo in poliuretano

- Puntale in fibra di vetro
- Lamina antiperforazione in fibra composita

**EN ISO
20345
2011**

METAL
FREE



EU	UK	mm	EU	mm
39	6	263	1	072930639
40	6,5	270	1	072930640
41	7	276	1	072930641
42	8	283	1	072930642
43	9	289	1	072930643
44	10	296	1	072930644
45	10,5	302	1	072930645
46	11	309	1	072930646
47	12	315	1	072930647
48	13	322	1	072930648



CE

S3 HRO HI SRC

7293HN

scarpe alte in pelle nabuk idrorepellente con SUPPORT SYSTEM per il contenimento laterale della caviglia e rapido sfilamento Battistrada in gomma ad alta resistenza e spunterbo in PU Ampia calzata

- Puntale in acciaio
- Lamina antiperforazione in fibra composita

**EN ISO
20345
2011**

METAL
FREE



E	U	mm	EU	mm
39	6	256	1	072930839
40	6,5	263	1	072930840
41	7	269	1	072930841
42	8	276	1	072930842
43	9	282	1	072930843
44	10	289	1	072930844
45	10,5	295	1	072930845
46	11	302	1	072930846
47	12	308	1	072930847



CE

S3 HRO HI SRC

7294HM

scarpe alte in pelle pieno fiore ingrassata idrorepellente con battistrada in gomma VIBRAM® ad alte prestazioni, inserto antiabrasione sul tallone e copripuntale di rinforzo in poliuretano

- Puntale in fibra di vetro
- Lamina antiperforazione in fibra composita

EU	UK	mm	mm	mm
39	6	263	1	072940639
40	6,5	270	1	072940640
41	7	276	1	072940641
42	8	283	1	072940642
43	9	289	1	072940643
44	10	296	1	072940644
45	10,5	302	1	072940645
46	11	309	1	072940646
47	12	315	1	072940647
48	13	322	1	072940648

CE



S3 HRO HI SRC



EN ISO
20345
2011



7294HMC

scarpe alte in pelle pieno fiore ingrassata idrorepellente con battistrada in gomma VIBRAM® ad alte prestazioni, inserto antiabrasione sul tallone e copripuntale di rinforzo in poliuretano. Dotate di membrana Tepor, waterproof, antivento ed estremamente traspirante

- Puntale in fibra di vetro
- Lamina antiperforazione in fibra composita

EU	UK	mm	mm	mm
39	6	263	1	072940739
40	6,5	270	1	072940740
41	7	276	1	072940741
42	8	283	1	072940742
43	9	289	1	072940743
44	10	296	1	072940744
45	10,5	302	1	072940745
46	11	309	1	072940746
47	12	315	1	072940747
48	13	322	1	072940748

CE



S3 HRO HI CI WR SRC



EN ISO
20345
2011



7294HN

scarpe alte in pelle nabuk idrorepellente con SUPPORT SYSTEM per il contenimento laterale della caviglia e rapido sfilamento Battistrada in gomma ad alta resistenza e spunterbo in PU Ampia calzata

- Puntale in acciaio
- Lamina antiperforazione in fibra composita

EU	UK	mm	mm	mm
39	6	263	1	072940839
40	6,5	269	1	072940840
41	7	276	1	072940841
42	8	282	1	072940842
43	9	289	1	072940843
44	10	295	1	072940844
45	10,5	302	1	072940845
46	11	308	1	072940846
47	12	315	1	072940847

CE



S3 HRO HI RS SRC



EN ISO
20345
2011



 **Beta**

ACCESSORIES

7398 O/G

sottopiedi anatomici in schiuma di EVA con cuscinetto ammortizzante nella zona del tallone (ricambio consigliato per la linea di calzature O-Gravity)



EU	UK		
38	5	1	073981238
39	6	1	073981239
40	6,5	1	073981240
41	7	1	073981241
42	8	1	073981242
43	9	1	073981243
44	10	1	073981244
45	10,5	1	073981245
46	11	1	073981246
47	12	1	073981247
48	13	1	073981248

7398ESD

sottopiede anatomico, traspirante, strato superiore antibatterico, previene dalla formazione di cattivi odori. Ricambio per calzature con certificazione ESD (ElectroStatic Discharge)



EU	UK		
35	2,5	1	073981435
36	3,5	1	073981436
37	4,5	1	073981437
38	5	1	073981438
39	6	1	073981439
40	6,5	1	073981440
41	7	1	073981441
42	8	1	073981442
43	9	1	073981443
44	10	1	073981444
45	10,5	1	073981445
46	11	1	073981446
47	12	1	073981447
48	13	1	073981448

7398T

sottopiede anatomico con isolamento termico WINTHERM. 70% poliestere alluminizzato 30% polietilene, accoppiato con tessuto non tessuto in fibre sintetiche. Antistatico, traspirante, rapida assorbenza, antiodore, antibatterico, antifungo.



WINTHERM

EU	UK		
35	2,5	1	073981335
36	3,5	1	073981336
37	4,5	1	073981337
38	5	1	073981338
39	6	1	073981339
40	6,5	1	073981340
41	7	1	073981341
42	8	1	073981342
43	9	1	073981343
44	10	1	073981344
45	10,5	1	073981345
46	11	1	073981346
47	12	1	073981347
48	13	1	073981348

7398U

sottopiedi anatomici in TPR GEL con elevato effetto ammortizzante, supporto dell'arco plantare e cuscinetto nella zona del tallone



EU	UK		
36 - 40	3,5 - 6,5	1	073980058
41 - 46	7 - 11	1	073980063



7398UP

sottopiedi anatomici in TPE GEL con profumo agrumato, design anatomico e supporto dell'arco plantare



EU	UK		
36 - 40	3,5 - 6	1	073980076
41 - 46	7 - 11	1	073980081

7398GEL

sottopiedi anatomici con inserto in gel



EU	UK		
35	2,5	1	073980835
36	3,5	1	073980836
37	4,5	1	073980837
38	5	1	073980838
39	6	1	073980839
40	6,5	1	073980840
41	7	1	073980841
42	8	1	073980842
43	9	1	073980843
44	10	1	073980844
45	10,5	1	073980845
46	11	1	073980846
47	12	1	073980847
48	13	1	073980848

7398EF

sottopiedi anatomici in schiuma di poliuretano con rialzo ammortizzante nella zona del tallone



EU	UK		
35	2,5	1	073981135
36	3,5	1	073981136
37	4,5	1	073981137
38	5	1	073981138
39	6	1	073981139
40	6,5	1	073981140
41	7	1	073981141
42	8	1	073981142
43	9	1	073981143
44	10	1	073981144
45	10,5	1	073981145
46	11	1	073981146
47	12	1	073981147
48	13	1	073981148

7399 A/N...

confezione 10 paia di stringhe



cm			
100		1	073990010
120		1	073990012
140		1	073990017

I prezzi indicati sono relativi a 10 paia

7421

calze lunghe in spugna elastocompressiva con rinforzi in nylon e cotone su punta e tallone
Pianta in fibra di bamboo, resistente, antimicotico e traspirante



	EU		
M	39-42	1	074210002
L	43-46	1	074210004

7423

calze corte elastocompressive con rinforzi in nylon e cotone su punta e tallone
Pianta in fibra di bamboo, resistente, antimicotico e traspirante



	EU		
M	39-42	1	074230002
L	43-46	1	074230004

7425

calze corte con inserti in texture traspirante e rinforzi in nylon/cotone su punta e tallone
Pianta in nylon intrecciato con fibra di bamboo, resistente, antimicotico e traspirante



	EU		
M	39-42	1	074250002
L	43-46	1	074250004

7427

calze maxi sneaker con inserti protettivi e traspiranti su zona tibia e collo del piede.
Rinforzi in nylon e cotone su punta e tallone e pianta in fibra di bamboo, resistente, antimicotico e traspirante



	EU		
M	39-42	1	074270002
L	43-46	1	074270004

7429

calze maxi sneaker con inserti in texture traspirante e rinforzi in nylon/cotone su punta e tallone
Pianta in nylon intrecciato con fibra di bamboo, resistente, antimicotico e traspirante



	EU		
M	39-42	1	074290002
L	43-46	1	074290004

7431P

due paia di calzini sneaker con inserti in texture traspirante e rinforzi in nylon/cotone su punta e tallone
Pianta in nylon intrecciato con fibra di bamboo, resistente, antimicotico e traspirante.
Un paio di colore nero/arancio e un paio di colore nero/grigio



	EU		
M	39-42	1	074310102
L	43-46	1	074310104



ABBIGLIAMENTO DA LAVORO



La linea di abbigliamento da lavoro ha conquistato nel corso degli anni la fiducia e la preferenza dei professionisti più esigenti. Il successo del prodotto ha generato la costante evoluzione e l'ampliamento della gamma di offerta.

I capi di abbigliamento prodotti da Beta Utensili S.p.a. sono conformi alla seguente normativa: **EN ISO 13688:2013**

Il DPI protegge l'utilizzatore dai rischi fisici di lieve entità come: piccole abrasioni, raggi solari, vento, freddo polveri non nocive ed imbrattamento da materiali non tossici. Tale protezione è riconducibile alla prima categoria del DDL 475 del 04/12/1992.

ISTRUZIONI PER L'UTILIZZO E LA CONSERVAZIONE

Il capo va indossato correttamente in modo che possa proteggere le parti del corpo dell'utilizzatore. Il capo va conservato in un luogo fresco ed asciutto, nel suo imballaggio originale, al riparo da fonti di calore, luce solare, polvere ed agenti atmosferici.

RESTRINGIMENTO

Tutte le fibre naturali si restringono dopo il lavaggio in acqua. Il restringimento può variare dall'1% al 5% in funzione di diversi parametri, in particolare il tipo di fibra e la temperatura dell'acqua.

CORRISPONDENZA TAGLIE

		UOMO						DONNA						
		I	F	D	E	UK	USA	I	F	D	E	UK	USA	
UOMO	XS	46	38	42	40	30	32	XS	38	34	32	34	6	2
	S	48	40	44	42	32	34	S	40	36	34	36	8	4
	M	50	42	46	44	34	36	M	42	38	36	38	10	6
	L	52	44	48	46	36	38	L	44	40	38	40	12	8
	XL	54	46	50	48	38	40	XL	46	42	40	42	14	10
	2XL	56	48	52	50	40	42	2XL	48	44	42	44	16	12
3XL	58	50	54	52	42	44	3XL	50	46	44	46	18	14	
4XL	60	52	56	54	44	46								

MISURE ANATOMICHE EN ISO 13688:2013

UOMO

	XS	S	M	L	XL	2XL	3XL	4XL
A	88-92	92-96	96-104	104-108	108-116	116-124	124-132	132-140
B	79-83	83-87	87-91	91-95	95-100	100-107	107-112	112-120
H	158-164	164-170	170-176	176-182	182-188	188-194	194-200	200-206

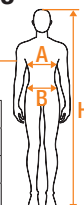

DONNA

	XS	S	M	L	XL	2XL	3XL
B	72-77	77-82	82-87	87-93	93-99	99-105	105-111
H	162-165	164-167	168-171	170-173	172-175	174-177	176-179

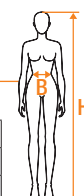

GUIDA ALLA SCELTA ABBIGLIAMENTO LISTINO 2023

Categoria	Linea	Codice Articolo	Pag	Colore	Abbinamenti suggeriti (tessuto e colore uguali al pantalone)									
					Bermuda	Pag	Salopette	Pag	Tuta	Pag	Gilet	Pag	Giacca	Pag
PANTALONI DA LAVORO LEGGERI	Trekking	7610G	614	■	7611G	618								
		7610N	614	■										
	Top Line	7660B	614	■	7661B	618								
		7660G	614	■	7661G	618								
	Stretch	7830SN	616	■	7831SN	618								
	Beta Easy	7860G	616	■	7861G	619	7863G	619	7865G	620	7867G	622	7869G	621
Cotton	7930G	617	■	7931G	619	7933G	620	7935G	620			7939G	621	
PANTALONI DA LAVORO 4 STAGIONI	Trekking	7600G	613	■										
		7600N	613	■										
	Top Line	7650	614	■									7653G	620
		7650B	614	■										
		7818BL	615	■										
		7818CM	615	■	7815CM	618								
		7818G	615	■										
	Stretch	7830ST	616	■	7831ST	618								
	Beta Easy	7840BL	616	■									7849BL	620
	Stretch	7880SC	616	■										
	Beta Easy	7900B	617	■									7909B	621
		7900G	617	■	7901G	619	7903G	619	7905G	620	7907G	622	7909G	621
		7900P	617	■			7903P	619			7907P	622	7909P	621
7900V		617	■									7909V	621	
Multiprotezione	7940	617	■									7949	621	
Lady	7818LN	615	■											

PANTS



7527

jeans da lavoro
in 70% cotone, 27% poliestere e 3% tessuto
elasticizzato
Regular fit

CE

Jeans



XS	S	M	L	XL	XXL	XXXL
46	48	50	52	54	56	58
1	1	1	1	1	1	1
075270046	075270048	075270050	075270052	075270054	075270056	075270058

7528

jeans da lavoro elasticizzati
in 98% cotone e 2% tessuto elasticizzato
Slim fit

CE

Jeans



XS	S	M	L	XL	XXL	XXXL
46	48	50	52	54	56	58
1	1	1	1	1	1	1
075280046	075280048	075280050	075280052	075280054	075280056	075280058

7530

jeans da lavoro elasticizzati
in 98% cotone e 2% tessuto elasticizzato, con
rinforzi in poliestere
Slim fit

CE

Jeans



XS	S	M	L	XL	XXL	XXXL
46	48	50	52	54	56	58
1	1	1	1	1	1	1
075300046	075300048	075300050	075300052	075300054	075300056	075300058

7600G

pantaloni "work trekking" HEAVY
90% nylon, 10% tessuto elasticizzato, 265 g,
tessuto rinforzato su ginocchia e retro, fondo
gamba elasticizzato con chiusura zip verticale
Grigio scuro con dettagli verde fluo
Slim fit

CE

**TREKKING
HEAVY**



XS	S	M	L	XL	XXL	XXXL
46	48	50	52	54	56	58
1	1	1	1	1	1	1
076000000	076000001	076000002	076000003	076000004	076000005	076000006

7600N

pantaloni "work trekking" HEAVY
90% nylon, 10% tessuto elasticizzato, 265 g,
tessuto rinforzato su ginocchia e retro, fondo
gamba elasticizzato con chiusura zip verticale
Nero con dettagli verde fluo
Slim fit

CE

**TREKKING
HEAVY**



XS	S	M	L	XL	XXL	XXXL
46	48	50	52	54	56	58
1	1	1	1	1	1	1
076000100	076000101	076000102	076000103	076000104	076000105	076000106

7610G

pantaloni "work trekking" LIGHT
90% nylon, 10% tessuto elasticizzato, 140 g,
tessuto rinforzato su ginocchia e retro, fondo
gamba elasticizzato e regolabile con coulisse
Grigio scuro con dettagli in giallo
Slim fit

CE

TREKKING
LIGHT



Dimensione	I	II	III
XS	46	1	076100000
S	48	1	076100001
M	50	1	076100002
L	52	1	076100003
XL	54	1	076100004
XXL	56	1	076100005
XXXL	58	1	076100006

7650

pantaloni da lavoro multitasche elasticizzati
90% Nylon -10% spandex, **260 g, antracite**
Tasche per ginocchiere, tasche posteriori e
fondo gamba rinforzati in poliesteri 600D,
cavallo antistrappo

CE



Dimensione	I	II	III
XS	46	1	076500000
S	48	1	076500001
M	50	1	076500002
L	52	1	076500003
XL	54	1	076500004
XXL	56	1	076500005
XXXL	60	1	076500006

7660B

pantaloni da lavoro leggeri, multitasche
elasticizzati
86% Nylon - 14% spandex, **140 g, blu**
Tasche per ginocchiere, tasche posteriori
rinforzate in poliesteri 300D, cavallo
antistrappo
Slim fit

CE



Dimensione	I	II	III
XS	46	1	076600100
S	48	1	076600101
M	50	1	076600102
L	52	1	076600103
XL	54	1	076600104
XXL	56	1	076600105
XXXL	58	1	076600106

7610N

pantaloni "work trekking" LIGHT
90% nylon, 10% tessuto elasticizzato, 140 g,
tessuto rinforzato su ginocchia e retro, fondo
gamba elasticizzato e regolabile con coulisse
Nero con dettagli in giallo
Slim fit

CE

TREKKING
LIGHT



Dimensione	I	II	III
XS	46	1	076100100
S	48	1	076100101
M	50	1	076100102
L	52	1	076100103
XL	54	1	076100104
XXL	56	1	076100105
XXXL	58	1	076100106

7650B

pantaloni da lavoro multitasche elasticizzati
90% Nylon -10% spandex, **260 g, blu**
Tasche per ginocchiere, tasche posteriori e
fondo gamba rinforzati in poliesteri 600D,
cavallo antistrappo

CE



Dimensione	I	II	III
XS	46	1	076500100
S	48	1	076500101
M	50	1	076500102
L	52	1	076500103
XL	54	1	076500104
XXL	56	1	076500105
XXXL	58	1	076500106

7660G

pantaloni da lavoro leggeri, multitasche
elasticizzati
86% Nylon - 14% spandex, **140 g, antracite**
Tasche per ginocchiere, tasche posteriori
rinforzate in poliesteri 300D, cavallo
antistrappo
Slim fit

CE



Dimensione	I	II	III
XS	46	1	076600000
S	48	1	076600001
M	50	1	076600002
L	52	1	076600003
XL	54	1	076600004
XXL	56	1	076600005
XXXL	58	1	076600006

7818G

pantaloni da lavoro multitasche in T/C Canvas 260 g, blu

Tasche per ginocchiere e fondo gamba rinforzati in poliestere 300D, cavallo antistrappo ed inserto in tessuto elasticizzato nell'interno gamba e nella zona lombare per facilitare i movimenti

CE



XS	46	1	078180000
S	48	1	078180001
M	50	1	078180002
L	52	1	078180003
XL	54	1	078180004
XXL	56	1	078180005
XXXL	58	1	078180006

**7818BL**

pantaloni da lavoro multitasche in T/C Canvas 260 g, blu

Tasche per ginocchiere e fondo gamba rinforzati in poliestere 300D, cavallo antistrappo ed inserto in tessuto elasticizzato nell'interno gamba e nella zona lombare per facilitare i movimenti

CE



XS	46	1	078180100
S	48 <td>1</td> <td>078180101</td>	1	078180101
M	50 <td>1</td> <td>078180102</td>	1	078180102
L	52 <td>1</td> <td>078180103</td>	1	078180103
XL	54 <td>1</td> <td>078180104</td>	1	078180104
XXL	56 <td>1</td> <td>078180105</td>	1	078180105
XXXL	58 <td>1</td> <td>078180106</td>	1	078180106

7818CM

pantaloni da lavoro multitasche in T/C Canvas 260 g, camoufflage grigio

Tasche per ginocchiere e fondo gamba rinforzati in poliestere 300D, cavallo antistrappo ed inserto in tessuto elasticizzato nell'interno gamba e nella zona lombare per facilitare i movimenti

CE



XS	46	1	078180300
S	48 <td>1</td> <td>078180301</td>	1	078180301
M	50 <td>1</td> <td>078180302</td>	1	078180302
L	52 <td>1</td> <td>078180303</td>	1	078180303
XL	54 <td>1</td> <td>078180304</td>	1	078180304
XXL	56 <td>1</td> <td>078180305</td>	1	078180305
XXXL	58 <td>1</td> <td>078180306</td>	1	078180306

7818LN

pantaloni da lavoro **da donna** multitasche, neri con dettagli rosa

100% cotone elasticizzato, 220 g
Tasche per ginocchiere e fondo gamba rinforzati in poliestere 300D, cavallo antistrappo ed inserto in tessuto elasticizzato nell'interno gamba per facilitare i movimenti

CE



XS	38	1	078180200
S	40 <td>1</td> <td>078180201</td>	1	078180201
M	42 <td>1</td> <td>078180202</td>	1	078180202
L	44 <td>1</td> <td>078180203</td>	1	078180203
XL	46 <td>1</td> <td>078180204</td>	1	078180204
XXL	48 <td>1</td> <td>078180205</td>	1	078180205
XXXL	50 <td>1</td> <td>078180206</td>	1	078180206

7830SN

pantaloni da lavoro elasticizzati
in T/C Twill 200 g, nero
Slim fit, cavallo antistrappo e vita elasticizzata
ai lati

CE



Taglia	l	Articolo
XS	46	1 078300100
S	48	1 078300101
M	50	1 078300102
L	52	1 078300103
XL	54	1 078300104
XXL	56	1 078300105
XXXL	58	1 078300106

7830ST

pantaloni da lavoro elasticizzati
in T/C Twill 250 g, grigio
Slim fit, cavallo antistrappo e vita elasticizzata
ai lati

CE



Taglia	l	Articolo
XS	46	1 078300000
S	48	1 078300001
M	50	1 078300002
L	52	1 078300003
XL	54	1 078300004
XXL	56	1 078300005
XXXL	58	1 078300006

7840BL

pantaloni da lavoro in T/C twill 245 g, blu
Vita elasticizzata ai lati

CE

Beta EASY



Taglia	l	Articolo
XS	46	1 078400100
S	48	1 078400101
M	50	1 078400102
L	52	1 078400103
XL	54	1 078400104
XXL	56	1 078400105
XXXL	58	1 078400106
XXXXL	60	1 078400107

7860G

pantaloni leggeri da lavoro
in T/C twill 180 g con inserti in Oxford, grigio
Nuovo Design - Migliore vestibilità

CE

Beta EASY

LIGHT



Taglia	l	Articolo
XS	46	1 078600800
S	48	1 078600801
M	50	1 078600802
L	52	1 078600803
XL	54	1 078600804
XXL	56	1 078600805
XXXL	58	1 078600806
XXXXL	60	1 078600807

7880SC

pantaloni da lavoro elasticizzati
in T/C Canvas 290 g, nero
Slim fit, cavallo antistrappo e vita elasticizzata
ai lati

CE



Taglia	l	Articolo
XS	46	1 078800000
S	48	1 078800001
M	50	1 078800002
L	52	1 078800003
XL	54	1 078800004
XXL	56	1 078800005
XXXL	58	1 078800006



7900B

pantaloni da lavoro
in T/C canvas 260 g con inserti in Oxford, blu

CE



XS	46	1	079000700
S	48	1	079000701
M	50	1	079000702
L	52	1	079000703
XL	54	1	079000704
XXL	56	1	079000705
XXXL	58	1	079000706
XXXXL	60	1	079000707

7900P

pantaloni da lavoro
in T/C canvas 260 g con inserti in Oxford, petrol

CE



XS	46	1	079000600
S	48	1	079000601
M	50	1	079000602
L	52	1	079000603
XL	54	1	079000604
XXL	56	1	079000605
XXXL	58	1	079000606
XXXXL	60	1	079000607

7930G

pantaloni da lavoro
100% cotone elasticizzato, 220 g
Slim Fit

CE



XS	46	1	079300300
S	48	1	079300301
M	50	1	079300302
L	52	1	079300303
XL	54	1	079300304
XXL	56	1	079300305
XXXL	58	1	079300306

7900G

pantaloni da lavoro
in T/C canvas 260 g con inserti in Oxford, grigio
Nuovo Design - Migliore vestibilità

CE



XS	46	1	079000800
S	48	1	079000801
M	50	1	079000802
L	52	1	079000803
XL	54	1	079000804
XXL	56	1	079000805
XXXL	58	1	079000806
XXXXL	60	1	079000807

7900V

pantaloni da lavoro
in T/C canvas 260 g con inserti in Oxford, verde

CE



XS	46	1	079000500
S	48	1	079000501
M	50	1	079000502
L	52	1	079000503
XL	54	1	079000504
XXL	56	1	079000505
XXXL	58	1	079000506
XXXXL	60	1	079000507

7940

pantaloni da lavoro **multiprotezione**
in T/C Twill 250 g, blu
protezione da calore, fiamme, arco elettrico,
rischi derivanti da saldatura e protezione da
agenti chimici.

CE



DPI: III^A Categoria
EN ISO 11611:2015 - Classe 1
EN ISO 11612:2015 - A1 B1 C1
EN 1149-5:2018
EN13034:2005+A1:2009 - Type 6
IEC 61482-2:2018 - APC 1

XS	46	1	079400000
S	48	1	079400001
M	50	1	079400002
L	52	1	079400003
XL	54	1	079400004
XXL	56	1	079400005
XXXL	58	1	079400006
XXXXL	60	1	079400007

BERMUDA



7529

bermuda jeans da lavoro elasticizzati
in 98% cotone e 2% tessuto elasticizzato
Slim fit

CE

Jeans



Dimensione	Quantità	Articolo
XS	46	1 075290046
S	48	1 075290048
M	50	1 075290050
L	52	1 075290052
XL	54	1 075290054
XXL	56	1 075290056
XXXL	58	1 075290058

7611G

bermuda "work trekking" LIGHT
90% nylon, 10% tessuto elasticizzato, 140 g,
tessuto rinforzato su retro.
Grigio scuro con dettagli in giallo
Slim fit

CE

TREKING
LIGHT



Dimensione	Quantità	Articolo
XS	46	1 076110000
S	48	1 076110001
M	50	1 076110002
L	52	1 076110003
XL	54	1 076110004
XXL	56	1 076110005
XXXL	58	1 076110006

7661B

bermuda leggeri da lavoro, multitasche
elasticizzati
86% Nylon - 14% spandex, 140 g, blu
Tasche posteriori rinforzate in poliestere 300D,
cavallo antistrappo
Slim fit

CE



Dimensione	Quantità	Articolo
XS	46	1 076610100
S	48	1 076610101
M	50	1 076610102
L	52	1 076610103
XL	54	1 076610104
XXL	56	1 076610105
XXXL	58	1 076610106

7661G

bermuda leggeri da lavoro, multitasche
elasticizzati
86% Nylon - 14% spandex, 140 g, antracite
Tasche posteriori rinforzate in poliestere 300D,
cavallo antistrappo
Slim fit

CE



Dimensione	Quantità	Articolo
XS	46	1 076610000
S	48	1 076610001
M	50	1 076610002
L	52	1 076610003
XL	54	1 076610004
XXL	56	1 076610005
XXXL	58	1 076610006

7815CM

bermuda da lavoro multitasche in T/C Canvas
260 g, camouflage grigio, cavallo antistrappo
ed inserto in tessuto elasticizzato nell'interno
gamba e nella zona lombare per facilitare i
movimenti

CE



Dimensione	Quantità	Articolo
XS	46	1 078150300
S	48	1 078150301
M	50	1 078150302
L	52	1 078150303
XL	54	1 078150304
XXL	56	1 078150305
XXXL	58	1 078150306

7831SN

bermuda da lavoro elasticizzati
in T/C Twill 200 g, nero
Slim fit, cavallo antistrappo e vita elasticizzata
ai lati

CE



Dimensione	Quantità	Articolo
XS	46	1 078310100
S	48	1 078310101
M	50	1 078310102
L	52	1 078310103
XL	54	1 078310104
XXL	56	1 078310105
XXXL	58	1 078310106

7831ST

bermuda da lavoro elasticizzati
in T/C Twill 250 g, grigio
Slim fit, cavallo antistrappo e vita elasticizzata
ai lati

CE



Dimensione	Quantità	Articolo
XS	46	1 078310000
S	48	1 078310001
M	50	1 078310002
L	52	1 078310003
XL	54	1 078310004
XXL	56	1 078310005
XXXL	58	1 078310006

Beta

7861G

bermuda leggeri da lavoro
in T/C twill 180 g con inserti in Oxford, grigio
Nuovo Design - Migliore vestibilità



Taglia	I	Articolo
XS	46	1 078610800
S	48	1 078610801
M	50	1 078610802
L	52	1 078610803
XL	54	1 078610804
XXL	56	1 078610805
XXXL	58	1 078610806
XXXXL	60	1 078610807

7901G

bermuda da lavoro
in T/C canvas 260 g con inserti in Oxford, grigio
Nuovo Design - Migliore vestibilità



Taglia	I	Articolo
XS	46	1 079010800
S	48	1 079010801
M	50	1 079010802
L	52	1 079010803
XL	54	1 079010804
XXL	56	1 079010805
XXXL	58	1 079010806
XXXXL	60	1 079010807

7931G

bermuda da lavoro
in 100% cotone elasticizzato, 220 g
Slim Fit



Taglia	I	Articolo
XS	46	1 079310300
S	48	1 079310301
M	50	1 079310302
L	52	1 079310303
XL	54	1 079310304
XXL	56	1 079310305
XXXL	58	1 079310306



7863G

Salopette leggera da lavoro
in T/C twill 180 g con inserti in Oxford, grigio
Nuovo Design - Migliore vestibilità



Taglia	I	Articolo
XS	46	1 078630800
S	48	1 078630801
M	50	1 078630802
L	52	1 078630803
XL	54	1 078630804
XXL	56	1 078630805
XXXL	58	1 078630806
XXXXL	60	1 078630807

7903G

Salopette da lavoro
in T/C canvas 260 g con inserti in Oxford, grigio
Nuovo Design - Migliore vestibilità



Taglia	I	Articolo
XS	46	1 079030800
S	48	1 079030801
M	50	1 079030802
L	52	1 079030803
XL	54	1 079030804
XXL	56	1 079030805
XXXL	58	1 079030806
XXXXL	60	1 079030807

7903P

Salopette da lavoro
in T/C canvas 260 g con inserti in Oxford, petrol



Taglia	I	Articolo
XS	46	1 079030600
S	48	1 079030601
M	50	1 079030602
L	52	1 079030603
XL	54	1 079030604
XXL	56	1 079030605
XXXL	58	1 079030606
XXXXL	60	1 079030607

7933G

salopette da lavoro
in 100% cotone elasticizzato, 220 g
Slim Fit

CE

Cotton



Dimensione	Quantità	Articolo
XS	1	079330300
S	1	079330301
M	1	079330302
L	1	079330303
XL	1	079330304
XXL	1	079330305
XXXL	1	079330306

7865G

Tuta leggera da lavoro
in T/C twill 180 g con inserti in Oxford, grigio
Nuovo Design - Migliore vestibilità

CE

Beta EASY

LIGHT



Dimensione	Quantità	Articolo
XS	1	078650800
S	1	078650801
M	1	078650802
L	1	078650803
XL	1	078650804
XXL	1	078650805
XXXL	1	078650806
XXXXL	1	078650807

7905G

Tuta da lavoro
in T/C canvas 260 g con inserti in Oxford,
grigio
Nuovo Design - Migliore vestibilità

CE

Beta EASY



Dimensione	Quantità	Articolo
XS	1	079050800
S	1	079050801
M	1	079050802
L	1	079050803
XL	1	079050804
XXL	1	079050805
XXXL	1	079050806
XXXXL	1	079050807

7935G

tuta da lavoro
in 100% cotone elasticizzato, 220 g
Slim Fit

CE

Cotton



Dimensione	Quantità	Articolo
XS	1	079350300
S	1	079350301
M	1	079350302
L	1	079350303
XL	1	079350304
XXL	1	079350305
XXXL	1	079350306

WORK JACKETS



7653G

giacca da lavoro multitasche elasticizzate
90% Nylon -10% spandex, 260g/m2, grigio
antracite

CE



TOP line



Dimensione	Quantità	Articolo
XS	1	076530000
S	1	076530001
M	1	076530002
L	1	076530003
XL	1	076530004
XXL	1	076530005
XXXL	1	076530006

7849BL

giacca da lavoro in T/C twill 245 g, blu
Fascia in vita elasticizzata

CE

Beta EASY



Dimensione	Quantità	Articolo
XS	1	078490100
S	1	078490101
M	1	078490102
L	1	078490103
XL	1	078490104
XXL	1	078490105
XXXL	1	078490106
XXXXL	1	078490107

7869G

giacca leggera da lavoro
in T/C twill 180 g con inserti in Oxford, grigio
Nuovo Design - Migliore vestibilità

CE



XS	1	078690800
S	1	078690801
M	1	078690802
L	1	078690803
XL	1	078690804
XXL	1	078690805
XXXL	1	078690806
XXXXL	1	078690807

7909B

giacca da lavoro
in T/C canvas 260 g con inserti in Oxford, blu

CE



XS	1	079090700
S	1	079090701
M	1	079090702
L	1	079090703
XL	1	079090704
XXL	1	079090705
XXXL	1	079090706
XXXXL	1	079090707

7909G

giacca da lavoro
in T/C canvas 260 g con inserti in Oxford,
grigio
Nuovo Design - Migliore vestibilità

CE



XS	1	079090800
S	1	079090801
M	1	079090802
L	1	079090803
XL	1	079090804
XXL	1	079090805
XXXL	1	079090806
XXXXL	1	079090807

7909P

giacca da lavoro
in T/C canvas 260 g con inserti in Oxford,
petrol

CE



XS	1	079090600
S	1	079090601
M	1	079090602
L	1	079090603
XL	1	079090604
XXL	1	079090605
XXXL	1	079090606
XXXXL	1	079090607

7909V

giacca da lavoro
in T/C canvas 260 g con inserti in Oxford,
verde

CE



XS	1	079090500
S	1	079090501
M	1	079090502
L	1	079090503
XL	1	079090504
XXL	1	079090505
XXXL	1	079090506
XXXXL	1	079090507

7939G

giacca da lavoro
in 100% cotone elasticizzato, 220 g
Slim Fit

CE



XS	1	079390300
S	1	079390301
M	1	079390302
L	1	079390303
XL	1	079390304
XXL	1	079390305
XXXL	1	079390306

7949

giacca da lavoro multiprotezione
in T/C Twill 250 g, blu
protezione da calore, fiamme, arco elettrico,
rischi derivanti da saldatura e protezione da
agenti chimici.

CE



DPI: III^a Categoria
EN ISO 11611:2015 - Classe 1
EN ISO 11612:2015 - A1 B1 C1
EN 1149-5:2018
EN13034:2005+A1:2009 - Type 6
IEC 61482-2:2018 - APC 1



XS	1	079490000
S	1	079490001
M	1	079490002
L	1	079490003
XL	1	079490004
XXL	1	079490005
XXXL	1	079490006
XXXXL	1	079490007



SLEEVELESS JACKETS



7575N

gilet softshell
in 90% nylon, 10% tessuto elasticizzato, 250 g



Dimensione	Quantità	Articolo
S	1	075750301
M	1	075750302
L	1	075750303
XL	1	075750304
XXL	1	075750305
XXXL	1	075750306

7579QN

gilet da lavoro multitasche in doppio materiale.
100% nylon impermeabilizzato 300D e
tessuto softshell 96% poliestere, 4% spandex,
imbottitura in poliestere 160 g
nero/grigio antracite

CE



Dimensione	Quantità	Articolo
S	1	075790201
M	1	075790202
L	1	075790203
XL	1	075790204
XXL	1	075790205
XXXL	1	075790206

7673NG

gilet da lavoro con imbottitura in GRAPHENE
80 g,
parte frontale rinforzata in tessuto softshell
96% poliestere, 4% spandex, parte retro in
100% nylon 20D

grigio antracite (fronte), nero (retro)

Inserto elastico sul giromanica
Antistatico, antibatterico, antivento,
termoregolatore

CE



Dimensione	Quantità	Articolo
S	1	076730001
M	1	076730002
L	1	076730003
XL	1	076730004
XXL	1	076730005
XXXL	1	076730006

7867G

gilet leggero da lavoro
in T/C twill 180 g con inserti in Oxford, grigio
Nuovo Design - Migliore vestibilità

CE



Dimensione	Quantità	Articolo
XS	1	078670800
S	1	078670801
M	1	078670802
L	1	078670803
XL	1	078670804
XXL	1	078670805
XXXL	1	078670806
XXXXL	1	078670807

7907G

gilet da lavoro
in T/C canvas 260 g con inserti in Oxford,
grigio

Nuovo Design - Migliore vestibilità

CE

Beta EASY



Dimensione	Quantità	Articolo
XS	1	079070800
S	1	079070801
M	1	079070802
L	1	079070803
XL	1	079070804
XXL	1	079070805
XXXL	1	079070806
XXXXL	1	079070807

7907P

gilet da lavoro
in T/C canvas 260 g con inserti in Oxford,
petrol

CE

Beta EASY



Dimensione	Quantità	Articolo
XS	1	079070600
S	1	079070601
M	1	079070602
L	1	079070603
XL	1	079070604
XXL	1	079070605
XXXL	1	079070606
XXXXL	1	079070607



JACKETS



7658CM

giacca softshell 94% poliestere, 6% spandex, 290 g, camouflage grigio
Dotato di membrana TPU impermeabile, antivento e traspirante (resistenza a colonne d'acqua 8.000 mm - traspirabilità 8.000 mvp)



Dimensione	Quantità	Articolo
S	1	076580101
M	1	076580102
L	1	076580103
XL	1	076580104
XXL	1	076580105
XXXL	1	076580106

7658N

giacca softshell 94% poliestere, 6% spandex, 290 g, nero Dotato di membrana TPU impermeabile, antivento e traspirante (resistenza a colonne d'acqua 8.000 mm - traspirabilità 8.000 mvp)



Dimensione	Quantità	Articolo
S	1	076580001
M	1	076580002
L	1	076580003
XL	1	076580004
XXL	1	076580005
XXXL	1	076580006

7659N

giacca softshell 94% poliestere, 6% spandex, 290 g con cappuccio e maniche staccabili, nero Dotato di membrana TPU impermeabile, antivento e traspirante (resistenza a colonne d'acqua 8.000 mm - traspirabilità 8.000 mvp)



Dimensione	Quantità	Articolo
S	1	076590001
M	1	076590002
L	1	076590003
XL	1	076590004
XXL	1	076590005
XXXL	1	076590006

7669N

giacca da lavoro leggera, multitasche, elasticizzata, 86% Nylon, 14% spandex, 140 g, nero
Con maniche staccabili e cappuccio a scomparsa.
Resistente all'acqua, antivento



Dimensione	Quantità	Articolo
XS	1	076690000
S	1	076690001
M	1	076690002
L	1	076690003
XL	1	076690004
XXL	1	076690005
XXXL	1	076690006

7670G

giaccone in poliestere Oxford 300D impermeabilizzato, con spalmatura in PU, grigio antracite
Dotato di cappuccio staccabile e rinforzi sulle maniche.
Impermeabile, antivento e traspirante (resistenza a colonne d'acqua 2.000 mm - traspirabilità 2.000 mvp)
Fodera in poliestere 210T, imbottitura in poliestere 120 g corpo, 100 g maniche



Dimensione	Quantità	Articolo
S	1	076700001
M	1	076700002
L	1	076700003
XL	1	076700004
XXL	1	076700005
XXXL	1	076700006

7674NG

piumino da lavoro con imbottitura in GRAPHENE 80 g, parte frontale e dell'avambraccio rinforzata in tessuto softshell 96% poliestere, 4% spandex, parte retro e maniche in 100% nylon 20D grigio antracite (fronte), nero (retro) polsini elasticizzati
Antistatico, antibatterico, antivento, termoregolatore



Dimensione	Quantità	Articolo
S	1	076740001
M	1	076740002
L	1	076740003
XL	1	076740004
XXL	1	076740005
XXXL	1	076740006

7780QN

bomber da lavoro multitasche in doppio materiale.
100% nylon impermeabilizzato 300D e tessuto softshell 96% poliestere, 4% spandex, imbottitura in poliestere 160 g con cappuccio fisso nero/grigio antracite

CE



Dimensione	Quantità	Articolo
S	1	077800201
M	1	077800202
L	1	077800203
XL	1	077800204
XXL	1	077800205
XXXL	1	077800206

7904N

bomber da lavoro imbottito in T/C canvas 270 g, inserti in "Oxford", nero. Imbottitura in poliestere 140 g

CE

Beta EASY



Dimensione	Quantità	Articolo
XS	1	079040800
S	1	079040801
M	1	079040802
L	1	079040803
XL	1	079040804
XXL	1	079040805
XXXL	1	079040806
XXXXL	1	079040807

FLEECE



7637G

felpa tecnica zip lunga 250 g, c/cappuccio fleece 100% poliestere con inserti in tessuto softshell 100D con fleece accoppiato 270 g grigio melange/nero



Dimensione	Quantità	Articolo
XS	1	076370000
S	1	076370001
M	1	076370002
L	1	076370003
XL	1	076370004
XXL	1	076370005
XXXL	1	076370006

7635N

micropile zip corta 180 g nero



Dimensione	Quantità	Articolo
XS	1	076350500
S	1	076350501
M	1	076350502
L	1	076350503
XL	1	076350504
XXL	1	076350505
XXXL	1	076350506

7654B

micropile zip corta elasticizzato 180 g, blu 95% poliestere, 5% spandex



Dimensione	Quantità	Articolo
XS	1	076540100
S	1	076540101
M	1	076540102
L	1	076540103
XL	1	076540104
XXL	1	076540105
XXXL	1	076540106

7654N

micropile zip corta elasticizzato 180 g, nero 95% poliestere, 5% spandex



Dimensione	Quantità	Articolo
XS	1	076540000
S	1	076540001
M	1	076540002
L	1	076540003
XL	1	076540004
XXL	1	076540005
XXXL	1	076540006

7657B

pile zip lunga elasticizzato 280 g, blu 95% poliestere, 5% spandex



Dimensione	Quantità	Articolo
XS	1	076570100
S	1	076570101
M	1	076570102
L	1	076570103
XL	1	076570104
XXL	1	076570105
XXXL	1	076570106

7657N

felpa zip lunga elasticizzato 280 g, nero
95% poliestere, 5% spandex



Dimensione	Quantità	Articolo
XS	1	076570000
S	1	076570001
M	1	076570002
L	1	076570003
XL	1	076570004
XXL	1	076570005
XXXL	1	076570006

7664G

felpa con zip lunga 280 g, grigio
60% cotone, 40% poliestere



Dimensione	Quantità	Articolo
XS	1	076640100
S	1	076640101
M	1	076640102
L	1	076640103
XL	1	076640104
XXL	1	076640105
XXXL	1	076640106

7664N

felpa zip lunga 280 g, nero
60% cotone, 40% poliestere



Dimensione	Quantità	Articolo
XS	1	076640000
S	1	076640001
M	1	076640002
L	1	076640003
XL	1	076640004
XXL	1	076640005
XXXL	1	076640006

7665G

felpa zip lunga, con cappuccio 280 g, grigio
60% cotone, 40% poliestere



Dimensione	Quantità	Articolo
XS	1	076650100
S	1	076650101
M	1	076650102
L	1	076650103
XL	1	076650104
XXL	1	076650105
XXXL	1	076650106

7665N

felpa zip lunga, con cappuccio 280 g, nero
60% cotone, 40% poliestere



Dimensione	Quantità	Articolo
XS	1	076650000
S	1	076650001
M	1	076650002
L	1	076650003
XL	1	076650004
XXL	1	076650005
XXXL	1	076650006



SHIRT & T-SHIRT

7545F

camicia da lavoro a quadretti in flanella,
in 100% cotone, 190 g.



Dimensione	Quantità	Articolo
XS	1	075450200
S	1	075450201
M	1	075450202
L	1	075450203
XL	1	075450204
XXL	1	075450205
XXXL	1	075450206

7547AZ

polo 3 bottoni
in 100% cotone 200 g, azzurro



Dimensione	Quantità	Articolo
XS	2	075470500
S	2	075470501
M	2	075470502
L	2	075470503
XL	2	075470504
XXL	2	075470505
XXXL	2	075470506

7547BL

polo 3 bottoni
in 100% cotone 200 g, blu



Dimensione	Quantità	Articolo
XS	2	075470200
S	2	075470201
M	2	075470202
L	2	075470203
XL	2	075470204
XXL	2	075470205
XXXL	2	075470206

7547G
 polo 3 bottoni
 in 100% cotone 200 g, grigio



XS	2	075470300
S	2	075470301
M	2	075470302
L	2	075470303
XL	2	075470304
XXL	2	075470305
XXXL	2	075470306

7547N
 polo 3 bottoni
 in 100% cotone 200 g, nero



XS	2	075470400
S	2	075470401
M	2	075470402
L	2	075470403
XL	2	075470404
XXL	2	075470405
XXXL	2	075470406

7547R
 polo 3 bottoni
 in 100% cotone 200 g, rosso



XS	2	075470600
S	2	075470601
M	2	075470602
L	2	075470603
XL	2	075470604
XXL	2	075470605
XXXL	2	075470606

7549AZ
 t-shirt work in 100% cotone 150 g, azzurro



XS	5	075490500
S	5	075490501
M	5	075490502
L	5	075490503
XL	5	075490504
XXL	5	075490505
XXXL	5	075490506

7549BL
 t-shirt work in 100% cotone 150 g, blu



XS	5	075490200
S	5	075490201
M	5	075490202
L	5	075490203
XL	5	075490204
XXL	5	075490205
XXXL	5	075490206

7549G
 t-shirt work in 100% cotone 150 g, grigio



XS	5	075490300
S	5	075490301
M	5	075490302
L	5	075490303
XL	5	075490304
XXL	5	075490305
XXXL	5	075490306

7549NE
 t-shirt work in 100% cotone 150 g, nero



XS	5	075490700
S	5	075490701
M	5	075490702
L	5	075490703
XL	5	075490704
XXL	5	075490705
XXXL	5	075490706

7549N
 t-shirt work in 100% cotone 150 g, nero



XS	5	075490400
S	5	075490401
M	5	075490402
L	5	075490403
XL	5	075490404
XXL	5	075490405
XXXL	5	075490406

7549R
 t-shirt work in 100% cotone 150 g, rosso



XS	5	075490600
S	5	075490601
M	5	075490602
L	5	075490603
XL	5	075490604
XXL	5	075490605
XXXL	5	075490606

7550G

t-shirt tecnica da lavoro in poliestere, 120 g con tecnologia 37.5®, grigio con dettagli neri, arancioni e reflex



XS	1	075500400
S	1	075500401
M	1	075500402
L	1	075500403
XL	1	075500404
XXL	1	075500405
XXXL	1	075500406

7550N

t-shirt tecnica da lavoro in poliestere, 120 g con tecnologia 37.5®, nero con dettagli grigi, arancioni e reflex



XS	1	075500500
S	1	075500501
M	1	075500502
L	1	075500503
XL	1	075500504
XXL	1	075500505
XXXL	1	075500506

7557BL

polo a maniche lunghe, 3 bottoni in 100% cotone 200 g, blu



XS	1	075570200
S	1	075570201
M	1	075570202
L	1	075570203
XL	1	075570204
XXL	1	075570205
XXXL	1	075570206

RAIN

7970

pantaloni impermeabili in PVC Tricot, blu

CE



EN 343

XS	1	079700000
S	1	079700001
M	1	079700002
L	1	079700003
XL	1	079700004
XXL	1	079700005
XXXL	1	079700006

7971L

pantaloni impermeabili in poliestere spalmato PVC con cuciture termonastrate, blu
Dotato di elastico in vita e fondo gamba regolabile con bottoni automatici

CE



EN 343

XS	1	079710100
S	1	079710101
M	1	079710102
L	1	079710103
XL	1	079710104
XXL	1	079710105
XXXL	1	079710106

7978L

cappotto impermeabile in poliestere spalmato PVC con cappuccio fisso e cuciture termonastrate, blu
dotato di bottoni automatici che permettono di accorciarlo a 3/4

CE



EN 343

XS	1	079780100
S	1	079780101
M	1	079780102
L	1	079780103
XL	1	079780104
XXL	1	079780105
XXXL	1	079780106



7979

giacca impermeabile in PVC Tricot, blu

CE



EN 343

Dimensione	Codice
S	1 079790001
M	1 079790002
L	1 079790003
XL	1 079790004
XXL	1 079790005
XXXL	1 079790006

UNDERWEAR

7996N

set abbigliamento intimo tecnico maglia intima tecnica maniche lunghe + calzamaglia intima tecnica, 92% poliestere, 8%spandex, 160 g/m², nero



Dimensione	Codice
XS-S	1 079960000
M-L	1 079960002
XL-XXL	1 079960004

ACCESSORIES

7800G

coppia ginocchiere da lavoro



7800G

1 078000500

7980N

cappellino anti pioggia
100% poliestere spalmato PU
con trattamento water repellent



L = Ø 58 cm
XL = Ø 60 cm

1 079800058
1 079800060

7980NC

berretto invernale in pile, 100% poliestere, reversibile (double face), nero - camouflage



7980NC

10 079800112

7980R

berretto invernale con risvolto in 100% acrilico
Imbottitura in 3M Thinsulate™, nero



7980R

10 079800111

7984EG

cintura da lavoro in tessuto elasticizzato e fibbia ad uncino in metallo zinco satinato, taglia unica 120 cm accorciabile, larghezza 37 mm, grigia



7984EG

1 079840520

7984G

cintura da lavoro in 100% TPE e fibbia in metallo zinco cromato
taglia unica 125 cm accorciabile, larghezza 35 mm, nero



7984G

1 079840525

7985

scaldacollo in micropile con regolatore, nero utilizzabile anche come cappello



7985

10 079850111

7104 90

colonnine in plastica con base riempibile



7104 90

H
mm
90

4 071040004

7105 6

catena plastica di delimitazione



7105 6

Ø
mm
6

L
m
25

1 071050006

7109A

cartelli di avvertenza in alluminio



	H mm		
7109A1	140	1	071090001
7109A2	140	1	071090002
7109A3	140	1	071090003
7109A4	140	1	071090004

7109D

cartelli di divieto



	H mm		
7109D1	115	1	071090051
7109D2	115	1	071090052
7109D3	115	1	071090053

7195A

mascherine antipolvere FFP1

CE



7195A	10	071950004
-------	----	-----------

7061TC

occhiali di protezione con lenti in policarbonato trasparente

CE

EASY



EN166:2001
EN170
2C-1.2 1F

7061TC	1	070610001
--------	---	-----------

7076BC

occhiali di protezione con lenti in policarbonato trasparente

CE

SPORT



EN166:2001
EN172
5-1.7 1F

7076BC	1	070760009
--------	---	-----------

7076BD

occhiali di protezione con lenti in policarbonato scuro

CE

SPORT



EN166:2001
EN172
5-3.1 1F

7076BD	1	070760019
--------	---	-----------

7076BP

occhiali di protezione con lenti in policarbonato polarizzato scuro

CE

SPORT



EN ISO 12312-1:2013+A1:2015
EN 1836
3P

7076BP	1	070760029
--------	---	-----------

7076BU

occhiali di protezione con lenti in policarbonato arancioni

CE



EN ISO 12311:2013
UV 500

7076BU	1	070760039
--------	---	-----------

7093BC

occhiali di protezione con lenti in policarbonato trasparente

CE

IMPACT



EN166:2001
EN170
2C-1.2 1F

7093BC	1	070930009
--------	---	-----------

7093BD

occhiali di protezione con lenti in policarbonato scuro

CE

IMPACT



EN166:2001
EN172
5-3.1 1F

7093BD	1	070930019
--------	---	-----------



C62M/W

espositore a manichino



185
cm

65 cm

C62M/W	1	062000360
--------	---	-----------

6200M/B

basi in vetro di ricambio per espositori a manichino C62M/W



6200M/B	1	062000361
---------	---	-----------

C64

parete espositiva vuota abbigliamento e calzature



2400
mm

560
mm

L		
1 m	1	064000021
2 m	1	064000022
3 m	1	064000023
4 m	1	064000024

C64G

gondola espositiva vuota abbigliamento e calzature

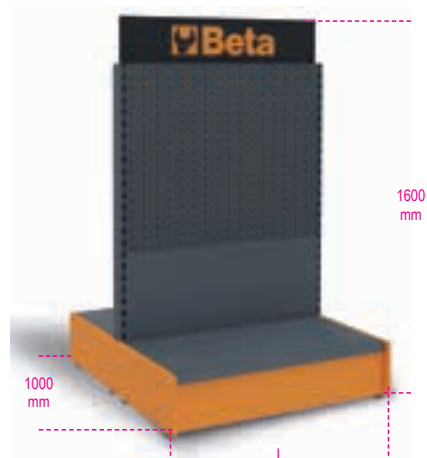

L
1 m 1 064000051
2 m 1 064000052

C64CW

camerino



C64CW 1 064000610

6200AP/S10

set da 10 grucce



6200AP/S10 1 062000331

6800BA

barra abbigliamento



6800BA 1 068000130

6800RS

rastrelliera scarpe



6800RS 1 068000135

6888GS

gancio scarpe per espositore C64



6888GS 2 068880122
170x120 mm

6888GW

gancio per espositore C64



6888GW 2 068880121
400 mm

9562TB

tappeto prova calzature,
con retro gommato antiscivolo



9562TB L 800 H 600 1 095620500

9565S

seduta in lamiera d'acciaio
con sedile in ecopelle sfoderabile



9565S H 60 ø 38 2 095650300

Beta



Robur

Dal 1930, Robur produce linee di accessori per funi allineandosi alla riconosciuta qualità di Beta Utensili, di cui è complemento produttivo.

Esperienza, organizzazione e tecnologia sono i requisiti di un continuo sviluppo determinato dall'attenzione alle esigenze del mercato.

Dal 1984, Robur ha sede in un moderno stabilimento a Sulmona.

 **Confezioni speciali per libero servizio**

CARICHI

WLL: carico massimo di esercizio (per accessori di sollevamento)

WFL: forza limite di lavoro (per accessori non destinati al sollevamento)

BF: forza massima raggiunta dall'articolo durante la prova di trazione statica

LC: tensione di ancoraggio

8147P

novità 2023

pinze di ancoraggio per paranchi manuali
Idonei per travi strutturali come ad esempio travi INP, IPB, IPE, HEA, HEB

CE

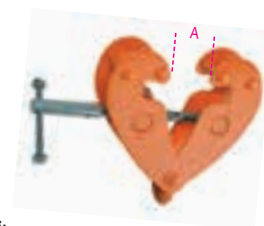

EN13157

Dati tecnici:

- Coefficiente di sicurezza: 4
- Piastra di identificazione seriale

Certificati disponibili:

- Certificato del Fabbricante
- Dichiarazione di Conformità CE
- Rapporto di Prova tipo 2.2 UNI EN10204
- Specifica Prodotto

misura	WLL t	A min mm	A max mm	numero utensili nella confezione	numero codice
1,0	90	180		1	081470210
2,0	90	190		1	081470220
3,0	85	280		1	081470230
5,0	85	280		1	081470250

8105

tenditori a due occhi ad alta resistenza
zincati a caldo

CE



UNI11841:2022

DATI TECNICI

- coefficiente di sicurezza: 5
- trattamento termico canala: normalizzazione
- trattamento termico anelli: bonifica
- codice lotto di fabbricazione

ANALISI DI LABORATORIO

- analisi chimica
- test di trazione

CERTIFICATI DISPONIBILI

- Specifica Prodotto
- Rapporto di Prova tipo 2.2 UNI EN10204
- Certificato di Controllo tipo 3.1 UNI EN10204
- Dichiarazione di Conformità CE

ØxE "	≈ mm	WFL kg		
3/8x6	M10x150	540	5	081050010
1/2x6	M12x150	1000	5	081050011
1/2x9	M12x230	1000	5	081050012
5/8x6	M16x150	1590	2	081050014
5/8x12	M16x300	1590	2	081050015
5/8x9	M16x230	1590	2	081050016
3/4x6	M20x150	2360	2	081050017
3/4x12	M20x300	2360	2	081050018
3/4x9	M20x230	2360	2	081050020
3/4x18	M20x460	2360	2	081050021
7/8x12	M22x300	3270	1	081050022
1x6	M24x150	4540	1	081050024
1x12	M24x300	4540	1	081050025
1x18	M24x460	4540	1	081050026
1.1/4x12	M33x300	6900	1	081050031
1.1/4x18	M33x460	6900	1	081050032
1.1/2x12	M39x300	9710	1	081050034
1.1/2x18	M39x460	9710	1	081050035
1.3/4x18	M45x460	12700	1	081050036

confezioni appendibili



ØxE "			
3/8x6	1	1	081059010
1/2x9	1	1	081059012

Robur

Robur

8109

tenditori a due forcelle ad alta resistenza
zincati a caldo

CE

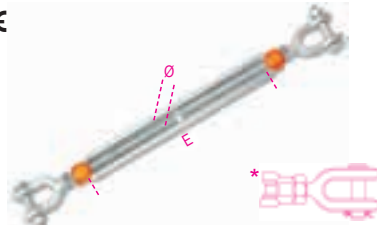

UNI 11841:2022

DATI TECNICI

- coefficiente di sicurezza: 5
- trattamento termico canala: normalizzazione
- trattamento termico anelli: bonifica
- codice lotto di fabbricazione

ANALISI DI LABORATORIO

- analisi chimica
- test di trazione

CERTIFICATI DISPONIBILI

- Specifica Prodotto
- Rapporto di Prova tipo 2.2 UNI EN10204
- Certificato di Controllo tipo 3.1 UNI EN10204
- Dichiarazione di Conformità CE

ØxE "	≈ mm	WFL kg		
3/8x6	M10x150	540	5	081090010
1/2x6	M12x150	1000	5	081090011
1/2x9	M12x230	1000	5	081090012
1/2x12	M12x300	1000	5	081090013
5/8x6	M16x150	1590	2	081090015
5/8x9	M16x230	1590	2	081090016
5/8x12	M16x300	1590	2	081090017
3/4x6	M20x150	2360	2	081090018
3/4x9	M20x230	2360	2	081090020
3/4x12	M20x300	2360	2	081090019
3/4x18	M20x460	2360	2	081090021
7/8x12	M22x300	3270	1	081090022
7/8x18	M22x460	3270	1	081090023
1x6	M24x150	4540	1	081090024
1x12	M24x300	4540	1	081090025
1x18	M24x460	4540	1	081090026
* 1.1/4x12	M33x300	6900	1	081090031
* 1.1/4x18	M33x460	6900	1	081090032
* 1.1/4x24	M33x610	6900	1	081090033
* 1.1/2x12	M39x300	9710	1	081090034
* 1.1/2x18	M39x460	9710	1	081090038
* 1.1/2x24	M39x610	9710	1	081090039
* 1.3/4x18	M45x460	12700	1	081090036

confezioni appendibili



ØxE "			
3/8x6	1	1	081099010
1/2x9	1	1	081099012

8110

tenditori ad occhio e forcella ad alta resistenza
zincati a caldo

CE

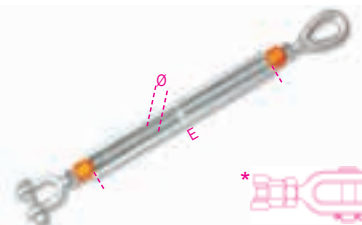

UNI 11841:2022

DATI TECNICI

- coefficiente di sicurezza: 5
- trattamento termico canala: normalizzazione
- trattamento termico anelli: bonifica
- codice lotto di fabbricazione

ANALISI DI LABORATORIO

- analisi chimica
- test di trazione

CERTIFICATI DISPONIBILI

- Specifica Prodotto
- Rapporto di Prova tipo 2.2 UNI EN10204
- Certificato di Controllo tipo 3.1 UNI EN10204
- Dichiarazione di Conformità CE

ØxE "	≈ mm	WFL kg		
1/2x6	M12x150	1000	5	081100006
1/2x9	M12x230	1000	5	081100010
5/8x6	M16x150	1590	2	081100014
5/8x9	M16x230	1590	2	081100015
5/8x12	M16x300	1590	2	081100016
3/4x6	M20x150	2360	2	081100019
3/4x9	M20x230	2360	2	081100020
3/4x12	M20x300	2360	2	081100021
7/8x12	M22x300	3270	1	081100022
1x6	M24x150	4540	1	081100027
1x12	M24x300	4540	1	081100029
* 1.1/4x12	M33x300	6900	1	081100034
* 1.1/4x18	M33x460	6900	1	081100035
* 1.1/2x12	M39x300	9710	1	081100038
* 1.1/2x18	M39x460	9710	1	081100039
* 1.3/4x18	M45x460	12700	1	081100044

* forcella con perno passante e copiglia

8005Z

tenditori a due occhi
zincati

CE

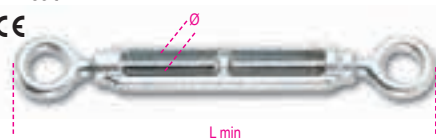

DATI TECNICI

- coefficiente di sicurezza: 4

ANALISI DI LABORATORIO

- analisi chimica
- test di trazione

CERTIFICATI DISPONIBILI

- Specifica Prodotto
- Rapporto di Prova tipo 2.2 UNI EN10204
- Dichiarazione di Conformità CE

Ø mm	≈ mm	L min mm	WFL kg		
M5	3/16	118	115	400	080050105
M6	1/4	130	160	300	080050106
M8	5/16	158	300	200	080050108
M10	3/8	192	470	100	080050110
M11	7/16	206	580	80	080050111
M12	1/2	226	690	60	080050112
M14	9/16	256	940	15	080050114
M16	5/8	290	1290	10	080050116
M18	11/16	358	1660	1	080050118
M20	3/4	358	2130	1	080050120
M22	7/8	400	2630	1	080050122
M24	1"	436	3060	1	080050124
M27	1"1/8	474	4000	1	080050125
M30	1"3/16	498	4860	1	080050130
M33	1"1/4	516	6040	1	080050126
M36	1"3/8	532	6500	1	080050136
M39	1"1/2	544	7900	1	080050139

confezioni speciali

Ø mm	"				
M5	3/16	30	1	080050705	
M6	1/4	30	1	080050706	
M8	5/16	20	1	080050708	
M10	3/8	15	1	080050710	
M11	7/16	15	1	080050711	
M12	1/2	15	1	080050712	

confezioni appendibili

Ø mm	"				
M5	2		1	080059305	
M6	2		1	080059306	
M8	1		1	080059108	
M10	1		1	080059110	
M11	1		1	080059111	
M12	1		1	080059112	
M14	1		1	080059114	
M16	1		1	080059116	

8005T2

tenditori a due occhi FORGIATI A CALDO
canaula a tubo DIN 1478
zincati

CE



DATI TECNICI

• coefficiente di sicurezza: 4

ANALISI DI LABORATORIO

• analisi chimica

• test di trazione

CERTIFICATI DISPONIBILI

• Specifica Prodotto

• Rapporto di Prova tipo 2.2 UNI EN10204

• Dichiarazione di Conformità CE

Ø mm	"	WFL kg			
M12	1/2	690	15	080050512	
M16	5/8	1290	1	080050516	
M20	3/4	2130	1	080050520	
M24	1"	3060	1	080050524	
M27	1.1/8	4000	1	080050527	
M30	1.3/16	4860	1	080050530	
M36	1.3/8	6500	1	080050536	

confezioni appendibili

Ø mm	"				
M12	1		1	080059512	

8006Z

tenditori ad occhio e gancio
zincati

CE

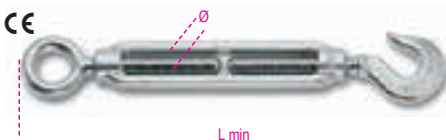

DATI TECNICI

• coefficiente di sicurezza: 4

ANALISI DI LABORATORIO

• analisi chimica

• test di trazione

CERTIFICATI DISPONIBILI

• Specifica Prodotto

• Rapporto di Prova tipo 2.2 UNI EN10204

• Dichiarazione di Conformità CE

Ø mm	"	L min mm	WFL kg		
M5	3/16	121	25	400	080060105
M6	1/4	132	45	250	080060106
M8	5/16	170	95	180	080060108
M10	3/8	204	140	100	080060110
M11	7/16	221	165	15	080060111
M12	1/2	244	300	15	080060112
M14	9/16	284	420	10	080060114
M16	5/8	322	570	1	080060116
M18	11/16	373	700	1	080060118
M20	3/4	391	900	1	080060120
M22	7/8	433	1100	1	080060122
M24	1"	470	1300	1	080060124
M27	1.1/8	503	2300	1	080060127

confezioni speciali

Ø mm	"				
M5	3/16	30	1	080060705	
M6	1/4	30	1	080060706	
M8	5/16	20	1	080060708	
M10	3/8	15	1	080060710	

confezioni appendibili

Ø mm	"				
M5	2		1	080069305	
M6	2		1	080069306	
M8	1		1	080069108	
M10	1		1	080069110	
M11	1		1	080069111	
M12	1		1	080069112	
M14	1		1	080069114	

8007Z

tenditori a due ganci
zincati

CE

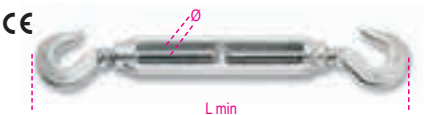

DATI TECNICI

• coefficiente di sicurezza: 4

ANALISI DI LABORATORIO

• analisi chimica

• test di trazione

CERTIFICATI DISPONIBILI

• Specifica Prodotto

• Rapporto di Prova tipo 2.2 UNI EN10204

• Dichiarazione di Conformità CE

Ø mm	"	L min mm	WFL kg		
M5	3/16	124	25	30	080070105
M6	1/4	134	45	30	080070106
M8	5/16	181	95	20	080070108
M10	3/8	211	140	15	080070110
M11	7/16	231	165	15	080070111
M12	1/2	262	300	15	080070112

Ø mm	"	L min mm	WFL kg		
M14	9/16	312	420	1	080070114
M16	5/8	354	570	1	080070116
M18	11/16	388	700	1	080070118
M20	3/4	424	900	1	080070120
M22	7/8	466	1100	1	080070122
M24	1"	504	1300	1	080070124
M27	1.1/8	532	2300	1	080070127

confezioni appendibili

Ø mm	"				
M5	2		1	080079305	
M6	2		1	080079306	
M8	1		1	080079108	
M10	1		1	080079110	
M11	1		1	080079111	
M12	1		1	080079112	

8008N

tenditori a due tronchi
neri

CE

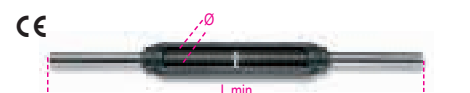

DATI TECNICI

• coefficiente di sicurezza: 4

ANALISI DI LABORATORIO

• analisi chimica

• test di trazione

CERTIFICATI DISPONIBILI

• Specifica Prodotto

• Rapporto di Prova tipo 2.2 UNI EN10204

• Dichiarazione di Conformità CE

Ø mm	"	L min mm	WFL kg		
M5	3/16	160	115	30	080080205
M6	1/4	180	160	30	080080206
M8	5/16	210	300	20	080080208
M10	3/8	250	470	15	080080210
M12	1/2	280	690	15	080080212
M14	9/16	340	940	5	080080214
M16	5/8	380	1290	5	080080216
M18	11/16	410	1660	3	080080218
M20	3/4	440	2130	3	080080220
M22	7/8	480	2630	2	080080222
M24	1"	520	3060	2	080080224
M27	1.1/8	560	4000	1	080080227
M30	1.3/16	560	4860	1	080080230
M33	1.1/4	600	6040	1	080080233
M36	1.3/8	600	6500	1	080080236
M39	1.1/2	600	7900	1	080080239

confezioni appendibili

Ø mm	"				
M5	2		1	080089305	
M6	2		1	080089306	
M8	1		1	080089208	
M10	1		1	080089210	
M12	1		1	080089212	
M14	1		1	080089214	

Robur

8008TZN

tenditori a due tronchi
canaula a tubo DIN 1478
terminali neri, corpo zincato



DATI TECNICI

- coefficiente di sicurezza: 4
- ANALISI DI LABORATORIO
- analisi chimica
- test di trazione
- CERTIFICATI DISPONIBILI
- Specifica Prodotto
- Rapporto di Prova tipo 2.2 UNI EN10204
- Dichiarazione di Conformità CE

Ø mm	≈ "	WFL kg	10	10
M12	1/2	690	10	080080512
M16	5/8	1290	1	080080516
M20	3/4	2130	1	080080520
M24	1	3060	1	080080524
M27	1.1/8	4000	1	080080527
M30	1.3/16	4860	1	080080530
M36	1.3/8	6500	1	080080536

8009Z

tenditori a due forcelle
zincati

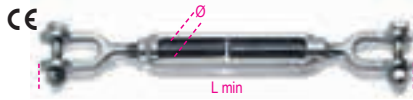

DATI TECNICI

- coefficiente di sicurezza: 4
- ANALISI DI LABORATORIO
- analisi chimica
- test di trazione
- CERTIFICATI DISPONIBILI
- Specifica Prodotto
- Rapporto di Prova tipo 2.2 UNI EN10204
- Dichiarazione di Conformità CE

Ø mm	≈ "	L min mm	WFL kg	15	15
M8	5/16	192	300	15	080090008
M10	3/8	234	470	15	080090010
M12	1/2	274	690	15	080090012
M14	9/16	342	940	1	080090014
M16	5/8	372	1290	1	080090016
M18	11/16	406	1660	1	080090018
M20	3/4	406	2130	1	080090020
M22	7/8	466	2630	1	080090022
M24	1"	486	3060	1	080090024
M27	1.1/8	510	4000	1	080090027
M30	1.3/16	566	4860	1	080090030

confezioni appendibili

Ø mm	1	1	1
M8	1	1	080099008
M10	1	1	080099010
M12	1	1	080099012

8009TZ

tenditori a due forcelle
canaula a tubo DIN 1478
zincati



DATI TECNICI

- coefficiente di sicurezza: 4
- ANALISI DI LABORATORIO
- analisi chimica
- test di trazione
- CERTIFICATI DISPONIBILI
- Specifica Prodotto
- Rapporto di Prova tipo 2.2 UNI EN10204
- Dichiarazione di Conformità CE

Ø mm	≈ "	WFL kg	10	10
M12	1/2	690	10	080090512
M16	5/8	1290	1	080090516
M20	3/4	2130	1	080090520
M24	1	3060	1	080090524
M27	1.1/8	4000	1	080090527
M30	1.3/16	4860	1	080090530

confezioni appendibili

Ø mm	1	1	1
M12	1	1	080099512

8010Z

tenditori ad occhio e forcella
zincati

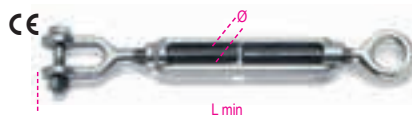

DATI TECNICI

- coefficiente di sicurezza: 4
- ANALISI DI LABORATORIO
- analisi chimica
- test di trazione
- CERTIFICATI DISPONIBILI
- Specifica Prodotto
- Rapporto di Prova tipo 2.2 UNI EN10204
- Dichiarazione di Conformità CE

Ø mm	≈ "	L min mm	WFL kg	20	20
M8	5/16	175	300	20	080100008
M10	3/8	215	470	15	080100010
M12	1/2	250	690	10	080100012
M14	9/16	299	940	10	080100014
M16	5/8	331	1290	1	080100016
M18	11/16	382	1660	1	080100018
M20	3/4	382	2130	1	080100020
M22	7/8	433	2630	1	080100022
M24	1"	461	3060	1	080100024
M27	1.1/8	492	4000	1	080100027
M30	1.3/16	529	4860	1	080100030

confezioni appendibili

Ø mm	1	1	1
M8	1	1	080109008
M10	1	1	080109010
M12	1	1	080109012
M14	1	1	080109014

8010TZ

tenditori ad occhio e forcella
canaula a tubo DIN 1478
zincati



DATI TECNICI

- coefficiente di sicurezza: 4
- ANALISI DI LABORATORIO
- analisi chimica
- test di trazione
- CERTIFICATI DISPONIBILI
- Specifica Prodotto
- Rapporto di Prova tipo 2.2 UNI EN10204
- Dichiarazione di Conformità CE

Ø mm	≈ "	WFL kg	10	10
M12	1/2	690	10	080100612
M16	5/8	1290	1	080100616
M20	3/4	2130	1	080100620
M24	1	3060	1	080100624
M27	1.1/8	4000	1	080100627
M30	1.3/16	4860	1	080100630

8001Z

canaule per tenditori
zincate



DATI TECNICI

- coefficiente di sicurezza: 5
- codice lotto di fabbricazione
- ANALISI DI LABORATORIO
- analisi chimica
- test di trazione
- CERTIFICATI DISPONIBILI
- Specifica Prodotto
- Rapporto di Prova tipo 2.2 UNI EN10204
- Certificato di Controllo tipo 3.1 UNI EN10204
- Dichiarazione di Conformità CE

Ø mm	≈ "	L mm	WFL kg	100	100
M5	3/16	80	115	100	080010105
M6	1/4	80	160	100	080010106
M8	5/16	105	300	25	080010108
M10	3/8	125	470	20	080010110
M11	7/16	135	580	15	080010111
M12	1/2	140	690	20	080010112
M14	9/16	170	940	15	080010114
M16	5/8	190	1290	15	080010116
M18	11/16	205	1660	10	080010118
M20	3/4	220	2130	10	080010120
M22	7/8	240	2630	8	080010122
M24	1"	260	3060	5	080010124
M27	1.1/8	270	4000	1	080010127
M30	1.3/16	280	4860	1	080010130
M33	1.1/4	290	6040	1	080010133
M36	1.3/8	300	6500	1	080010136
M39	1.1/2	300	7900	1	080010139

confezioni appendibili

Ø mm	2	1	1
M5	2	1	080019305
M6	2	1	080019306
M8	1	1	080019108
M10	1	1	080019110
M11	1	1	080019111
M12	1	1	080019112
M14	1	1	080019114
M16	1	1	080019116
M18	1	1	080019118
M20	1	1	080019120
M22	1	1	080019122
M24	1	1	080019124

8001TZ

canaile a tubo per tenditori
zincate

CE



DIN 1478

DATI TECNICI

- coefficiente di sicurezza: 5
- codice lotto di fabbricazione

ANALISI DI LABORATORIO

- analisi chimica
- test di trazione

CERTIFICATI DISPONIBILI

- Specifica Prodotto
- Rapporto di Prova tipo 2.2 UNI EN10204
- Certificato di Controllo tipo 3.1 UNI EN10204
- Dichiarazione di Conformità CE

Ø mm	≈ "	L mm	WFL kg		
M12	1/2	125	690	10	080010512
M16	5/8	170	1290	5	080010516
M20	3/4	200	2130	5	080010520
M24	1	255	3060	3	080010524
* M27	1.1/8	255	4000	1	080010527
M30	1.3/16	255	4860	1	080010530
M36	1.3/8	295	6500	1	080010536
M42	1.5/8	330	9700	1	080010542

* misure non contemplate nella norma.

da M12 a M27 acciaio S235JR

da M30 a M42 acciaio S355JR

confezioni appendibili



Ø mm		
M12	1	080019512
M16	1	080019516
M20	1	080019520
M24	1	080019524

8002ZD

anelli per tenditori,
filettatura destra, zincati



DATI TECNICI

- coefficiente di sicurezza: 4

ANALISI DI LABORATORIO

- analisi chimica
- test di trazione

CERTIFICATI DISPONIBILI

- Specifica Prodotto
- Rapporto di Prova tipo 2.2 UNI EN10204

Ø mm	≈ "	E mm	WFL kg		
M5	3/16	37	115	200	080020105
M6	1/4	40	160	150	080020106
M8	5/16	52	300	100	080020108
M10	3/8	60	470	100	080020110
M11	7/16	65	580	1	080020111
M12	1/2	72	690	50	080020112
M14	9/16	85	940	1	080020114
M16	5/8	95	1290	1	080020116
M18	11/16	103	1660	1	080020118
M20	3/4	110	2130	1	080020120
M22	7/8	120	2630	1	080020122
M24	1"	130	3060	1	080020124
M27	1.1/8	135	4000	1	080020127
M30	1.3/16	140	4860	1	080020130
M33	1.1/4	148	6040	1	080020133
M36	1.3/8	150	6500	1	080020136
M39	1.1/2	150	7900	1	080020139

filetto sinistrorso

Ø mm	≈ "	E mm	WFL kg		
M5	3/16	37	115	1	080020305
M6	1/4	40	160	1	080020306
M8	5/16	52	300	1	080020308
M10	3/8	60	470	1	080020310
M11	7/16	65	580	1	080020311
M12	1/2	72	690	1	080020312
M14	9/16	85	940	1	080020314
M16	5/8	95	1290	1	080020316
M18	11/16	103	1660	1	080020318
M20	3/4	110	2130	1	080020320
M22	7/8	120	2630	1	080020322
M24	1"	130	3060	1	080020324
M27	1.1/8	135	4000	1	080020327
M30	1.3/16	140	4860	1	080020330
M33	1.1/4	148	6040	1	080020333
M36	1.3/8	150	6500	1	080020336
M39	1.1/2	150	7900	1	080020339

8003ZD

ganci per tenditori,
filettatura destra, zincati

CE

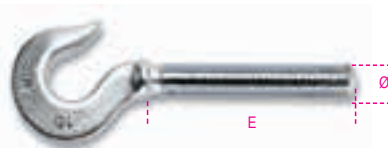

DATI TECNICI

- coefficiente di sicurezza: 4

ANALISI DI LABORATORIO

- analisi chimica
- test di trazione

CERTIFICATI DISPONIBILI

- Specifica Prodotto
- Rapporto di Prova tipo 2.2 UNI EN10204

Ø mm	≈ "	E mm	WFL kg		
M5	3/16	40	25	150	080030105
M6	1/4	40	45	120	080030106
M8	5/16	52	95	100	080030108
M10	3/8	60	140	70	080030110
M11	7/16	65	165	1	080030111
M12	1/2	70	300	30	080030112
M14	9/16	85	420	1	080030114
M16	5/8	95	570	1	080030116
M18	11/16	103	700	1	080030118
M20	3/4	110	900	1	080030120
M22	7/8	120	1100	1	080030122
M24	1"	130	1300	1	080030124
M27	1.1/8	135	2300	1	080030127

filetto sinistrorso

Ø mm	≈ "	WFL kg	E mm		
M5	3/16	40	25	1	080030305
M6	1/4	40	45	1	080030306
M8	5/16	52	95	1	080030308
M10	3/8	60	140	1	080030310
M11	7/16	65	165	1	080030311
M12	1/2	70	300	1	080030312
M14	9/16	85	420	1	080030314
M16	5/8	95	570	1	080030316
M18	11/16	103	700	1	080030318
M20	3/4	110	900	1	080030320
M22	7/8	120	1100	1	080030322
M24	1"	130	1300	1	080030324
M27	1.1/8	135	2300	1	080030327

8004ND

tronchi per tenditori
destri - neri

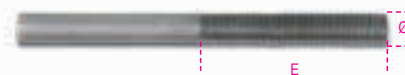

DATI TECNICI

- coefficiente di sicurezza: 4

ANALISI DI LABORATORIO

- analisi chimica
- test di trazione

CERTIFICATI DISPONIBILI

- Specifica Prodotto
- Rapporto di Prova tipo 2.2 UNI EN10204

Ø mm	≈ "	E mm	WFL kg		
M5	3/16	40	115	1	080040005
M6	1/4	44	160	1	080040006
M8	5/16	53	300	1	080040008
M10	3/8	63	470	1	080040010
M12	1/2	70	690	1	080040012
M14	9/16	85	940	1	080040014
M16	5/8	95	1290	1	080040016
M18	11/16	103	1660	1	080040018
M20	3/4	110	2130	1	080040020
M22	7/8	120	2630	1	080040022
M24	1"	130	3060	1	080040024
M27	1.1/8	135	4000	1	080040027
M30	1.3/16	140	4860	1	080040030
M33	1.1/4	150	6040	1	080040033
M36	1.3/8	150	6500	1	080040036
M39	1.1/2	150	7900	1	080040039

filetto sinistrorso

Ø mm	≈ "	E mm	WFL kg		
M5	3/16	40	115	1	080040105
M6	1/4	44	160	1	080040106
M8	5/16	53	300	1	080040108
M10	3/8	63	470	1	080040110
M12	1/2	70	690	1	080040112
M14	9/16	85	940	1	080040114
M16	5/8	95	1290	1	080040116
M18	11/16	103	1660	1	080040118
M20	3/4	110	2130	1	080040120
M22	7/8	120	2630	1	080040122
M24	1"	130	3060	1	080040124
M27	1.1/8	135	4000	1	080040127
M30	1.3/16	140	4860	1	080040130
M33	1.1/4	150	6040	1	080040133
M36	1.3/8	150	6500	1	080040136
M39	1.1/2	150	7900	1	080040139



8009FD

forcelle per tenditori
destre - zincate



DATI TECNICI

• coefficiente di sicurezza: 4

ANALISI DI LABORATORIO

- analisi chimica
- test di trazione

CERTIFICATI DISPONIBILI

- Specifica Prodotto
- Rapporto di Prova tipo 2.2 UNI EN10204

Ø mm	≈ "	E mm	WFL kg		
M8	5/16	53	300	1	080090208
M10	3/8	63	470	1	080090210
M12	1/2	70	690	1	080090212
M14	9/16	85	940	1	080090214
M16	5/8	95	1290	1	080090216
M18	11/16	103	1660	1	080090218
M20	3/4	110	2130	1	080090220
M22	7/8	120	2630	1	080090222
M24	1"	130	3060	1	080090224
M27	1 1/8	135	4000	1	080090227
M30	1 3/16	140	4860	1	080090230

filetto sinistrorso

Ø mm	≈ "	WFL kg	G mm		
M8	5/16	53	300	1	080090408
M10	3/8	63	470	1	080090410
M12	1/2	70	690	1	080090412
M14	9/16	85	940	1	080090414
M16	5/8	95	1290	1	080090416
M18	11/16	103	1660	1	080090418
M20	3/4	110	2130	1	080090420
M22	7/8	120	2630	1	080090422
M24	1"	130	3060	1	080090424
M27	1 1/8	135	4000	1	080090427
M30	1 3/16	140	4860	1	080090430

8048

tiranti ad occhio
destri
neri



UNI 6058

ØxL mm	WFL kg	F mm		
M8x50	430	6	20	080480108
M8x65	430	6	20	080480109
M10x80	690	8	10	080480110
M10x100	690	8	10	080480210
M10x130	690	8	10	080480111
M12x70	1020	10	8	080480212
M12x95	1020	10	8	080480112
M12x125	1020	10	8	080480113
M14x110	1420	12	6	080480114
M16x100	1980	14	6	080480115
M16x130	1980	14	6	080480116
M18x150	2390	16	2	080480118
M20x160	3100	18	2	080480120
M22x180	3890	18	1	080480122
M24x200	4460	20	1	080480124
M24x220	4460	20	1	080480125
M27x220	5900	22	1	080480127

8302Z

viti ad occhio per tasselli
filettatura destra
zincate



DATI TECNICI

• coefficiente di sicurezza: 4

CERTIFICATI DISPONIBILI

- Specifica Prodotto
- Rapporto di Prova tipo 2.2 UNI EN10204

Ø mm	E mm	F mm	WFL kg		
M5	48	8	115	200	083020005
M6	55	10	160	150	083020006
M8	60	12	300	100	083020008
M10	73	14	470	100	083020010
M12	90	17	690	50	083020012

8303Z

ganci per tasselli
filettatura destra
zincati

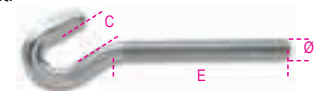

DATI TECNICI

• coefficiente di sicurezza: 4

CERTIFICATI DISPONIBILI

- Specifica Prodotto
- Rapporto di Prova tipo 2.2 UNI EN10204

Ø mm	C mm	E mm	WFL kg		
M5	6,0	48	25	120	083030005
M6	8,0	55	45	100	083030006
M8	10,0	60	95	75	083030008
M10	12,5	73	140	50	083030010
M12	16,0	90	220	20	083030012

8702N - 8702Z - 8702ZC

capicorda a pressare in acciaio forgiato
terminale ad occhio
neri



DATI TECNICI

• codice lotto di fabbricazione

ANALISI DI LABORATORIO

- analisi chimica
- test di trazione

CERTIFICATI DISPONIBILI

- Specifica Prodotto
- Certificato di Controllo tipo 3.1 UNI EN10204

M	ØB mm	ØA mm	ØD mm		
6	6,8	13	19	1	087020106
8	8,8	20	22	1	087020108
9	9,8	20	22	1	087020109
10	10,8	20	22	1	087020110
11	11,8	25	27	1	087020111
12	12,8	25	27	1	087020112
13	13,8	25	27	1	087020113
14	14,8	32	32	1	087020114
15	15,9	32	32	1	087020115
16	17,0	32	32	1	087020116
18	19,0	39	37	1	087020118
19	20,0	39	37	1	087020119
20	21,1	39	37	1	087020120
22	23,2	43	43	1	087020122
24	25,4	50	52	1	087020124
25	26,4	50	52	1	087020125
26	27,4	50	52	1	087020126

La pressatura dei capicorda richiede presse e stampi idonei e può essere eseguita esclusivamente da personale specializzato.

8702Z zincati

M	ØB mm	ØA mm	ØD mm		
6	6,8	13	19	1	087020306
8	8,8	20	22	1	087020308
9	9,8	20	22	1	087020309
10	10,8	20	22	1	087020310
11	11,8	25	27	1	087020311
12	12,8	25	27	1	087020312
13	13,8	25	27	1	087020313
14	14,8	32	32	1	087020314
15	15,9	32	32	1	087020315
16	17,0	32	32	1	087020316
18	19,0	39	37	1	087020318
19	20,0	39	37	1	087020319
20	21,1	39	37	1	087020320
22	23,2	43	43	1	087020322
24	25,4	50	52	1	087020324
25	26,4	50	52	1	087020325
26	27,4	50	52	1	087020326

8702ZC zincati a caldo

M	ØB mm	ØA mm	ØD mm		
6	6,8	13	19	1	087020206
8	8,8	20	22	1	087020208
9	9,8	20	22	1	087020209
10	10,8	20	22	1	087020210
11	11,8	25	27	1	087020211
12	12,8	25	27	1	087020212
13	13,8	25	27	1	087020213
14	14,8	32	32	1	087020214
15	15,9	32	32	1	087020215
16	17,0	32	32	1	087020216
18	19,0	39	37	1	087020218
19	20,0	39	37	1	087020219
20	21,1	39	37	1	087020220
22	23,2	43	43	1	087020222
24	25,4	50	52	1	087020224
25	26,4	50	52	1	087020225
26	27,4	50	52	1	087020226



8709N - 8709Z - 8709ZC

capicorda a pressare in acciaio forgiato
terminale a forcina
neri



DATI TECNICI

• codice lotto di fabbricazione
ANALISI DI LABORATORIO

• analisi chimica
• test di trazione

CERTIFICATI DISPONIBILI

• Specifica Prodotto
• Certificato di Controllo tipo 3.1 UNI EN10204

M	Ø B mm	Ø A mm	Ø C mm		
6	6,8	13	17	1	087090106
8	8,8	20	21	1	087090108
9	9,8	20	21	1	087090109
10	10,8	20	21	1	087090110
11	11,8	25	25	1	087090111
12	12,8	25	25	1	087090112
13	13,8	25	25	1	087090113
14	14,8	32	30	1	087090114
15	15,9	32	30	1	087090115
16	17,0	32	30	1	087090116
18	19,0	39	35	1	087090118
19	20,0	39	35	1	087090119
20	21,1	39	35	1	087090120
22	23,2	43	41	1	087090122
24	25,4	50	51	1	087090124
25	26,4	50	51	1	087090125
26	27,4	50	51	1	087090126

La pressatura dei capicorda richiede presse e stampi idonei e può essere eseguita esclusivamente da personale specializzato.

8709Z zincati

M	Ø B mm	Ø A mm	Ø C mm		
6	6,8	13	17	1	087090306
8	8,8	20	21	1	087090308
9	9,8	20	21	1	087090309
10	10,8	20	21	1	087090310
11	11,8	25	25	1	087090311
12	12,8	25	25	1	087090312
13	13,8	25	25	1	087090313
14	14,8	32	30	1	087090314
15	15,9	32	30	1	087090315
16	17,0	32	30	1	087090316
18	19,0	39	35	1	087090318
19	20,0	39	35	1	087090319
20	21,0	39	35	1	087090320
22	23,2	43	41	1	087090322
24	25,4	50	51	1	087090324
25	26,4	50	51	1	087090325
26	27,4	50	51	1	087090326

8709ZC zincati a caldo

M	Ø B mm	Ø A mm	Ø C mm		
6	6,8	13	17	1	087090206
8	8,8	20	21	1	087090208
9	9,8	20	21	1	087090209
10	10,8	20	21	1	087090210
11	11,8	25	25	1	087090211
12	12,8	25	25	1	087090212
13	13,8	25	25	1	087090213
14	14,8	32	30	1	087090214
15	15,9	32	30	1	087090215
16	17,0	32	30	1	087090216
18	19,0	39	35	1	087090218
19	20,0	39	35	1	087090219
20	21,1	39	35	1	087090220
22	23,2	43	41	1	087090222
24	25,4	50	51	1	087090224
25	26,4	50	51	1	087090225
26	27,4	50	51	1	087090226

8015

morsetti tipo pesante
corpo in acciaio
zincati a caldo

CE

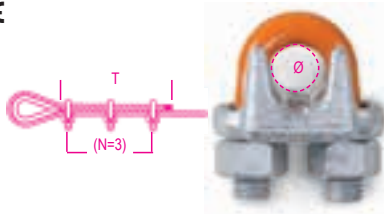

dimensioni EN 13411-5 tipo B

Dati tecnici

• Codice di identificazione

Analisi di laboratorio

• Analisi chimica
• Test coppia di serraggio

Certificati disponibili

• Specifica Prodotto
• Rapporto di Prova tipo 2.2 UNI EN10204
• Certificato del Fabbricante UNI EN13411-5
• Dichiarazione di Conformità CE

Ø mm	Ø "	N x T	Nm		
8	5/16	3x133	40,7	12	080150808
10	3/8	3x165	61	12	080150810
13	1/2	3x292	88	6	080150813
16	5/8	3x305	129	6	080150816
20	3/4	4x460	176	6	080150820
22	7/8	4x480	305	6	080150822
26	1	5x660	305	5	080150826
30	1-1/8	6x860	305	2	080150830

8016

morsetti in acciaio
zincati

CE

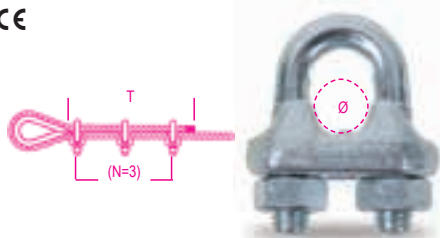

Caratteristiche tecniche:

• Cavallotto in acciaio classe di resistenza 4.6
• Corpo in acciaio S235JR
• Dado in acciaio classe di resistenza 6
• Trattamento superficiale: zincatura elettrolitica AZE EN ISO 4042 senza cromo esavalente

Certificati disponibili:

• Specifica Prodotto
• Rapporto di Prova tipo 2.2 UNI EN10204
• Certificato di Conformità CE

Ø mm	Ø "	N x T	Nm		
3	1/8	3x80	1,53	500	080160003
5	3/16	3x110	3,02	300	080160005
6	1/4	3x120	5,19	200	080160006
8	5/16	5x210	5,19	150	080160008
10	3/8	5x240	12,54	70	080160010
11	7/16	5x260	12,54	70	080160011
12-13	1/2	5x300	24,76	40	080160013
14	9/16	5x295	24,76	35	080160014
16	5/8	5x335	24,76	30	080160016
18	11/16	5x380	42,42	30	080160018
20	3/4	5x540	42,42	30	080160020
22	7/8	7x595	42,42	25	080160022
24-26	1"	7x700	67,56	15	080160026
28	1"1/16	8x840	67,56	5	080160028
30-32	1"1/8	8x990	67,56	5	080160030
34-36	1"1/4	8x1155	105,80	4	080160034
38-40	1"1/2	8x1320	105,80	2	080160040
45-50	2"	8x1500	206	1	080160050

confezioni speciali

Ø mm	"			
3	1/8	100	1	080160703
5	3/16	50	1	080160705
6	1/4	50	1	080160706
8	5/16	30	1	080160708
10	3/8	30	1	080160710
11	7/16	25	1	080160711
12-13	1/2	15	1	080160713

confezioni appendibili

Ø mm	"			
3	6		1	080169403
5	4		1	080169405
6	4		1	080169406
8	4		1	080169408
10	2		1	080169410
11	1		1	080169011
12-13	1		1	080169013
14	1		1	080169014
16	1		1	080169016
18	1		1	080169018
20	1		1	080169020
22	1		1	080169022
24-26	1		1	080169026

8016FR

morsetti in acciaio,
corpo stampato a freddo
zincati

CE

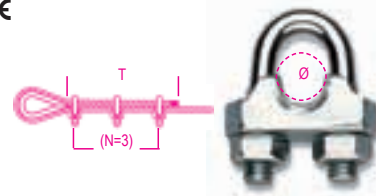

ANALISI DI LABORATORIO

• analisi chimica
CERTIFICATI DISPONIBILI
• Specifica Prodotto
• Rapporto di Prova tipo 2.2 UNI EN10204
• Certificato di Conformità CE

Ø mm	Ø "	N x T	Nm		
3	1/8	3x80	1,25	500	080160253
5	3/16	3x110	2,46	300	080160255
6	1/4	3x120	4,24	200	080160256
8	5/16	5x210	4,24	150	080160258

confezioni appendibili

Ø mm	"			
3	6		1	080169753
5	6		1	080169755
6	4		1	080169756
8	4		1	080169758



8018E

morsetti tipo ENEL, dado alto
corpo in acciaio zincato a caldo
cavallotti e dadi zincati e sigillati



ANALISI DI LABORATORIO

- analisi chimica
- CERTIFICATI DISPONIBILI**
- Specifica Prodotto
- Rapporto di Prova tipo 2.2 UNI EN10204

Ø mm	A mm	L mm	Nm		
4+6	M6	34	4,24	100	080180001

8016U2

morsetti
corpo in ghisa malleabile
zincati

CE

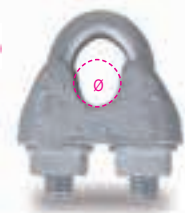
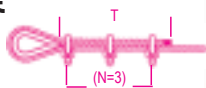

con codice
identificativo

dimensioni EN 13411-5 tipo A

DATI TECNICI

- codice di identificazione
- ANALISI DI LABORATORIO**
- analisi chimica
- test coppia di serraggio
- CERTIFICATI DISPONIBILI**
- Specifica Prodotto
- Rapporto di Prova tipo 2.2 UNI EN10204
- Certificato del Fabbricante UNI EN13411-5
- Dichiarazione di Conformità CE

Ø mm	Ø "	N x T	Nm		
5	3/16	3x156	2,0	300	080160855
6,5	1/4	3x192	3,5	150	080160856
8	5/16	4x320	6	70	080160858
10	3/8	4x320	9	60	080160860
12	1/2	4x384	20	25	080160862
14	9/16	4x448	33	15	080160864
16	5/8	4x512	49	10	080160866
19	3/4	4x512	68	10	080160869
22	7/8	5x680	107	10	080160872
26	1	5x760	147	5	080160876
30	1.1/8	6x984	212	5	080160880
34	1.1/4	6x1080	296	5	080160884
40	1.1/2	6x1176	363	5	080160890

confezioni appendibili

Ø mm			
5	4	1	080169805
6	4	1	080169806
8	4	1	080169808
10	2	1	080169810
12	1	1	080169612
14	1	1	080169614
16	1	1	080169616
19	1	1	080169619
22	1	1	080169622
26	1	1	080169626

8016UGK

morsetti
in ghisa malleabile
corpo ZINCATO A CALDO
cavallotto e dadi GEOMET-GEOKOTE

CE

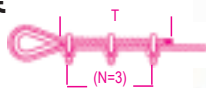

- elevata resistenza
alla corrosione
- codice
identificativo

dimensioni EN 13411-5 tipo A

DATI TECNICI

- codice di identificazione
- ANALISI DI LABORATORIO**
- analisi chimica
- test coppia di serraggio
- CERTIFICATI DISPONIBILI**
- Specifica Prodotto
- Rapporto di Prova tipo 2.2 UNI EN10204
- Certificato del Fabbricante UNI EN13411-5
- Dichiarazione di Conformità CE

Ø mm	Ø "	N x T	Nm		
8	5/16	4x320	6	70	080160758
10	3/8	4x320	9	60	080160760
12	1/2	4x448	33	25	080160762
14	9/16	4x384	20	15	080160764
16	5/8	4x512	49	10	080160766
19	3/4	4x512	68	10	080160769
22	7/8	5x680	107	10	080160772
26	1	5x760	147	5	080160776
30	1.1/8	6x984	212	1	080160780
34	1.1/4	6x1080	296	1	080160784
40	1.1/2	6x1176	363	1	080160790

8018T

morsetti tipo TELECOM,
corpo in ghisa malleabile
zincato a caldo



RUM-MU-21:1980

ANALISI DI LABORATORIO

- analisi chimica
- CERTIFICATI DISPONIBILI**
- Specifica Prodotto
- Rapporto di Prova tipo 2.2 UNI EN10204

Ø mm	A mm	L mm	Nm		
8+10	M8	42	10,20	200	080180003

8020A

radance tipo leggero
zincate

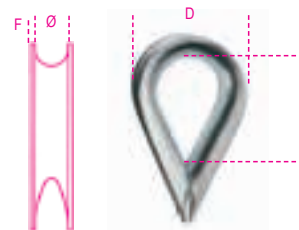

CERTIFICATI DISPONIBILI

- Specifica Prodotto
- Rapporto di Prova tipo 2.2 UNI EN10204

Ø mm	F mm	B mm	D mm		
2-3	1,0	20	18	150	080200503
4	1,2	23	19	150	080200504
5	1,2	24	23	100	080200505
6	1,2	27	28	100	080200506
8	1,4	33	32	50	080200508
10	1,8	41	38	30	080200510
12	2,2	44	45	30	080200512
14	2,2	52	49	50	080200514
16	3,0	58	58	50	080200516
18	3,7	64	68	50	080200518
20	3,7	73	74	35	080200520
22	3,7	83	79	30	080200522
24	3,7	93	88	20	080200525

confezioni speciali

Ø mm	S mm			
2-3	0,8	150	1	080200703
4	1,0	150	1	080200704
5	1,0	100	1	080200705
6	1,0	100	1	080200706
8	1,2	50	1	080200708
10	1,5	30	1	080200710

8021A

radance tipo pesante
per funi in acciaio
zincate

rispetto alla versione leggera, il maggior spessore della lamiera garantisce una superiore resistenza alla deformazione e consente di sfruttare al meglio le proprietà meccaniche della fune di acciaio.

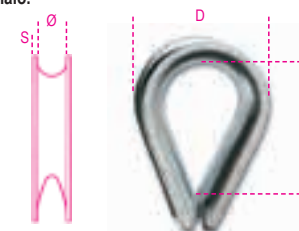

CERTIFICATI DISPONIBILI

- Specifica Prodotto
- Rapporto di Prova tipo 2.2 UNI EN10204

Ø mm	S mm	B mm	D mm		
2-3	0,6	15	16	150	080210103
5	1,7	29	28	120	080210105
6	1,8	33	30	100	080210106
8	2,5	36	37	100	080210108
10	2,5	42	43	80	080210110
12	2,5	48	50	100	080210112
14	2,7	58	57	70	080210114
16	3	61	62	50	080210116
18	3,5	71	71	70	080210118
20	4	79	79	30	080210120
22	4	87	84	25	080210122
24	4	93	92	25	080210124
26	4	103	103	20	080210126
28	5	107	116	1	080210128
30	5	118	121	1	080210130
32	5,5	138	135	1	080210132
35	6	140	147	1	080210135
40	6,0	174	170	1	080210140

8026R

grilli dritti per sollevamento, perno a vite,
acciaio legato ad alta resistenza
staffa zincata a caldo

CE



EN 13889
GRADE 6

DATI TECNICI

- coefficiente di sicurezza minimo: 6
- trattamento termico: bonifica
- codice lotto fabbricazione su perno e staffa

ANALISI DI LABORATORIO

- analisi chimica • analisi metallografica
- test di trazione • test di fatica (min.20.000 cicli)
- test carico di collaudo (2 x wll)

CERTIFICATI DISPONIBILI

- Specifica Prodotto • Rapporto di Prova tipo 2.2 UNI EN10204
- Certificato di Controllo tipo 3.1 UNI EN10204
- Dichiarazione di Conformità CE

ØD mm	ØA mm	H mm	WLL kg		
11	10	17	1000	5	080260210
16	13	21	2000	5	080260212
19	16	27	3250	3	080260216
22	19	32	4750	2	080260219
25	22	37	6500	2	080260222

confezioni appendibili



ØD mm			
16	1	1	080269212
19	1	1	080269216

8029R

grilli per sollevamento a lira, perno a vite
acciaio legato ad alta resistenza
staffa zincata a caldo

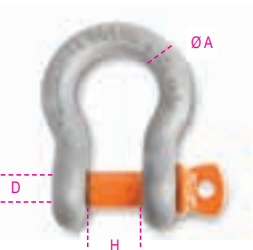

EN 13889
GRADO 6

DATI TECNICI

- coefficiente di sicurezza minimo: 6
- trattamento termico: bonifica
- codice lotto fabbricazione su perno e staffa

ANALISI DI LABORATORIO

- analisi chimica
- analisi metallografica
- test di trazione
- test di fatica (min.20.000 cicli)
- test carico di collaudo (2 x wll)

CERTIFICATI DISPONIBILI

- Specifica Prodotto
- Rapporto di Prova tipo 2.2 UNI EN10204
- Certificato di Controllo tipo 3.1 UNI EN10204
- Dichiarazione di Conformità CE

ØD mm	ØA mm	H mm	WLL kg		
8	6	13	500	20	080290106
10	8	13,5	750	15	080290108
11	10	17	1000	15	080290110
13	11	18,5	1500	10	080290111
16	13	20,5	2000	8	080290112
19	16	27	3250	8	080290116
22	19	32	4750	4	080290120
25	22	37	6500	4	080290122
28	26	43,5	8500	1	080290124

ØD mm	ØA mm	H mm	WLL kg		
32	29	48	9500	1	080290128
35	32	53	12000	1	080290132
38	35	59	13500	1	080290135
42	38	62	17000	1	080290138
50	45	75	25000	1	080290145
57	50	83	35000	1	080290150
65	57	95	42500	1	080290157
70	65	105	55000	1	080290165

confezioni appendibili



ØD mm			
8	1	1	080299106
10	1	1	080299108
11	1	1	080299110
13	1	1	080299111
16	1	1	080299112
19	1	1	080299116

8031R

grilli per sollevamento a lira con dado e
copiglia
acciaio legato ad alta resistenza
staffa zincata a caldo



EN 13889
GRADO 6

DATI TECNICI

- coefficiente di sicurezza minimo: 6
- trattamento termico: bonifica
- codice lotto fabbricazione su perno e staffa

ANALISI DI LABORATORIO

- analisi chimica
- analisi metallografica
- test di trazione
- test di fatica (min.20.000 cicli)
- test carico di collaudo (2 x wll)

CERTIFICATI DISPONIBILI

- Specifica Prodotto
- Rapporto di Prova tipo 2.2 UNI EN10204
- Certificato di Controllo tipo 3.1 UNI EN10204
- Dichiarazione di Conformità CE

ØD mm	ØA mm	H mm	WLL kg		
11	10	17	1000	5	080310110
13	11	18	1500	5	080310111
16	13	21	2000	5	080310112
19	16	27	3250	3	080310116
22	19	32	4750	2	080310120
25	22	37	6500	2	080310122
28	26	43	8500	1	080310124
32	29	48	9500	1	080310128
35	32	53	12000	1	080310132
38	35	59	13500	1	080310135
42	38	62	17000	1	080310138
50	45	75	25000	1	080310145
57	50	83	35000	1	080310150
70	65	105	55000	1	080310165
83	75	127	85000	1	080310183

confezioni appendibili



ØD mm			
16	1	1	080319112
19	1	1	080319116

8032

grilli a lira per sollevamento, perno a foro
quadro
acciaio legato ad alta resistenza
staffa zincata a caldo

CE

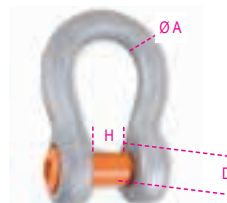

GRADE 6

DATI TECNICI

- coefficiente di sicurezza minimo: 6
- trattamento termico: bonifica
- codice lotto fabbricazione su perno e staffa

ANALISI DI LABORATORIO

- analisi chimica
- analisi metallografica
- test di trazione
- test di fatica (min.20.000 cicli)
- test carico di collaudo (2 x wll)

CERTIFICATI DISPONIBILI

- Specifica Prodotto
- Rapporto di Prova tipo 2.2 UNI EN10204
- Certificato di Controllo tipo 3.1 UNI EN10204
- Dichiarazione di Conformità CE

ØD mm	ØA mm	H mm	WLL kg		
11	10	17	1000	5	080320010
16	13	21	2000	5	080320012
19	16	27	3250	3	080320016
22	19	32	4750	2	080320020
25	22	37	6500	2	080320022

confezioni appendibili



ØD mm			
16	1	1	080329012
19	1	1	080329016

8025

grilli per sollevamento dritti, tipo largo
acciaio al carbonio
zincati

CE



GRADO 4

DATI TECNICI

- coefficiente di sicurezza: 5
- trattamento termico: normalizzazione
- codice lotto di fabbricazione

ANALISI DI LABORATORIO

- analisi chimica • analisi metallografica
- test di trazione

CERTIFICATI DISPONIBILI

- Specifica Prodotto
- Rapporto di Prova tipo 2.2 UNI EN10204
- Certificato di Controllo tipo 3.1 UNI EN10204
- Dichiarazione di Conformità CE

Ø mm	≈ mm	B x C mm	WLL kg		
5	3/16	21x10	70	250	080250005
6	1/4	25x12	100	250	080250006
8	5/16	33x16	250	150	080250008
10	3/8	42x20	400	180	080250010
11	7/16	46x22	500	130	080250011
12	1/2	50x24	600	100	080250012
14	9/16	57x28	800	70	080250014
16	5/8	61x32	1000	10	080250016
18	11/16	65x36	1300	10	080250018
20	3/4	70x40	1600	10	080250020
22	7/8	74x44	2000	10	080250022
25	1"	80x48	2800	2	080250025

confezioni speciali

Ø mm	"			
5	3/16	25	1	080250705
6	1/4	25	1	080250706
8	5/16	25	1	080250708
10	3/8	15	1	080250710
11	7/16	12	1	080250711
12	1/2	12	1	080250712
14	9/16	10	1	080250714

confezioni appendibili



Ø mm				
5	4		1	080259205
6	4		1	080259206
8	2		1	080259208
10	2		1	080259210
11	1		1	080259011
12	1		1	080259012
14	1		1	080259014
16	1		1	080259016
18	1		1	080259018
20	1		1	080259020
22	1		1	080259022
25	1		1	080259025

8026A

grilli per sollevamento diritti, tipo UNI
acciaio al carbonio
zincati

CE

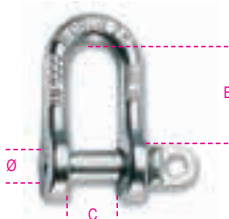

GRADO 4

DATI TECNICI

- coefficiente di sicurezza: 5
- trattamento termico: normalizzazione
- codice lotto fabbricazione
- ANALISI DI LABORATORIO
- analisi chimica
- analisi metallografica
- test di trazione
- CERTIFICATI DISPONIBILI
- Specifica Prodotto
- Rapporto di Prova tipo 2.2 UNI EN10204
- Certificato di Controllo tipo 3.1 UNI EN10204
- Dichiarazione di Conformità CE

Ø mm	"	B x C mm	WLL kg		
12	1/2	42x20	630	35	080260012
14	9/16	46x22	800	30	080260014
16	5/8	50x24	1000	20	080260016
18	11/16	54x26	1300	15	080260018
20	3/4	58x28	1600	10	080260020
22	7/8	69x32	2000	10	080260022
25	1"	79x36	2500	5	080260025
28	1.1/8	90x40	3150	2	080260028
32	1.1/4	100x45	4000	1	080260032
36	1.3/8	110x50	5000	1	080260036
40	1.9/16	120x55	6300	1	080260040
42	1.5/8	131x60	8000	1	080260042
45	1.3/4	143x65	10000	1	080260045
50	2"	155x70	12500	1	080260050

confezioni appendibili



Ø mm				
12	1		1	080269012
14	1		1	080269014
16	1		1	080269016
18	1		1	080269018
20	1		1	080269020
22	1		1	080269022
25	1		1	080269025



8028

grilli per sollevamento a lira
acciaio al carbonio
zincati

CE

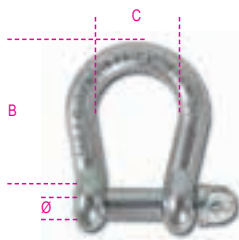

GRADO 4

DATI TECNICI

- coefficiente di sicurezza: 5
- trattamento termico: normalizzazione
- codice lotto fabbricazione
- ANALISI DI LABORATORIO
- analisi chimica
- analisi metallografica
- test di trazione
- CERTIFICATI DISPONIBILI
- Specifica Prodotto
- Rapporto di Prova tipo 2.2 UNI EN10204
- Certificato di Controllo tipo 3.1 UNI EN10204
- Dichiarazione di Conformità CE

Ø mm	"	B x C mm	WLL kg		
5	3/16	20x16	80	100	080280105
6	1/4	24x20	100	70	080280106
8	5/16	32x24	200	35	080280108
10	3/8	40x33	300	25	080280110
12	1/2	48x39	500	15	080280112
14	9/16	56x46	600	7	080280114
16	5/8	64x46	800	10	080280116
18	11/16	71x59	950	5	080280118
20	3/4	80x65	1100	5	080280120
22	7/8	88x72	1500	5	080280122
25	1"	100x81	2000	2	080280125
28	1.1/8	112x91	2600	1	080280128
32	1.1/4	128x104	3200	1	080280132
38	1.1/2	152x124	4500	1	080280138

confezioni appendibili



Ø mm				
5	4		1	080289305
6	4		1	080289306
8	2		1	080289308
10	2		1	080289310
12	1		1	080289112
14	1		1	080289114
16	1		1	080289116
18	1		1	080289118
20	1		1	080289120
22	1		1	080289122

8049 WLL (t)

	A°	M8	M10	M12	M16	M20	M24	M30
	0°	0,3	0,6	1	1,6	2,5	4	6,3
	0°	0,6	1,2	2	3,2	5	8	12,6
	90°	0,3	0,6	1	1,6	2,5	4	6,3
	90°	0,6	1,2	2	3,2	5	8	12,6
	0°/45°	0,4	0,8	1,4	2,2	3,5	5,6	8,8
	45°/60°	0,3	0,6	1	1,6	2,5	4	6,3
	0°/45°	0,6	1,3	2,1	3,4	5,3	8,4	13,2
	45°/60°	0,3	0,6	1	1,6	2,5	4	6,3

8049

golfari maschio per sollevamento,
orientabili a doppia articolazione,
acciaio legato ad alta resistenza

CE

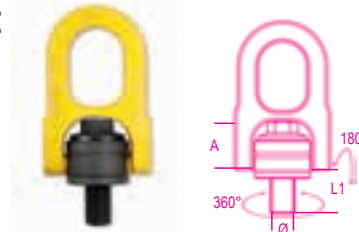

DATI TECNICI

- coefficiente di sicurezza: 5
- trattamento termico: bonifica
- codice lotto fabbricazione
- ANALISI DI LABORATORIO
- analisi chimica
- analisi metallografica
- test di trazione
- test di fatica (20.000 cicli)
- CERTIFICATI DISPONIBILI
- Specifica Prodotto
- Rapporto di Prova tipo 2.2 UNI EN10204
- Certificato di Controllo tipo 3.1 UNI EN10204
- Dichiarazione di Conformità CE

Ø mm	A mm	L1 mm	WLL 90° kg		
M8	31,5	14	300	1	080490008
M10	31,5	17	600	1	080490010
M12	31,5	21	1000	1	080490012
M16	45	27	1600	1	080490016
M20	45	30	2500	1	080490020
M24	60,5	36	4000	1	080490024
M30	60,5	45	6300	1	080490030



8049A WLL (T)										
	8"	M6	M8	M10	M12	M16	M20	M24	M30	M36
	0°	400	600	900	1000	2000	4000	6000	10000	11000
	0°	800	1200	1800	2000	4000	8000	12000	21200	23000
	90°	200	300	450	500	1120	2000	3150	5300	6000
	90°	400	600	900	1000	2000	4000	6000	10000	11000
	45°	250	400	600	700	1400	2800	4250	7100	10700
	45°	200	300	450	500	1120	2000	3150	5300	6000
	0°	400	600	900	1000	2100	4200	6300	11200	10000
	45°	250	400	600	750	1500	3000	4500	8000	10700

8049A

golfari maschio per sollevamento a doppia articolazione, girevole sotto carico con anello saldato in acciaio legato ad alta resistenza

Golfare girevole a 360° e staffa orientabile

CE



DATI TECNICI

- coefficiente di sicurezza: 4
 - trattamento termico: bonifica
 - codice lotto fabbricazione
- ANALISI DI LABORATORIO
- analisi chimica
 - analisi metallografica
 - test di trazione
 - test di fatica (20.000 cicli)
 - carico di collaudo (100% del lotto)
- CERTIFICATI DISPONIBILI
- Specifica Prodotto
 - Rapporto di Prova tipo 2.2 UNI EN10204
 - Certificato di Controllo tipo 3.1 UNI EN10204
 - Dichiarazione di Conformità CE

Ø	E	A	WLL 90°		
mm	mm	mm	kg		
M6	13	30	200	1	080490106
M8	13	30	300	1	080490108
M10	19	30	450	1	080490110
M12	19	30	500	1	080490112
M16	20	30	1120	1	080490116
M20	30	40	2000	1	080490120
M24	30	40	3150	1	080490124
M30	35	50	5300	1	080490130
M36	54	50	8000	1	080490136

8049V

golfari maschio per sollevamento con staffa disassata, acciaio legato ad alta resistenza

Golfare girevole a 360° e staffa orientabile

CE



Dati tecnici

- Coefficiente di sicurezza: 4
 - Trattamento termico: bonifica
 - Codice lotto fabbricazione
- Analisi di laboratorio
- Analisi chimica
 - Analisi metallografica
 - Test di trazione
 - Test di fatica (20.000 cicli)
 - Carico di collaudo (100% del lotto)
- Certificati disponibili:
- Specifica Prodotto
 - Rapporto di Prova tipo 2.2 UNI EN10204
 - Certificato di Controllo tipo 3.1 UNI EN10204
 - Dichiarazione di Conformità CE

Ø	E	B	WLL		
mm	mm	mm	kg		
M12	18	37,5	1000	1	080490312
M16	24	37,5	1500	1	080490316
M20	35,5	54	2500	1	080490320
M24	35,5	54	4000	1	080490324

8068S

staffe a saldare per sollevamento a base singola con molla di posizionamento, corpo in acciaio legato ad alta resistenza

- Minimo ingombro per operazioni di sollevamento
- Dimensionate per 20.000 cicli di lavoro a pieno carico
- Carico di Collaudo applicato sul 100% dei pezzi prima della vendita
- Coefficiente di sicurezza 4 in tutte le direzioni

CE



DATI TECNICI

- Coefficiente di sicurezza: 4
 - Trattamento termico: bonifica
 - Codice lotto fabbricazione
- ANALISI DI LABORATORIO
- Analisi chimica
 - Analisi metallografica
 - Test di trazione
 - Test di fatica (20.000 cicli)
 - Carico di collaudo (100% del lotto)
- CERTIFICATI DISPONIBILI
- Specifica Prodotto
 - Rapporto di Prova tipo 2.2 UNI EN10204
 - Certificato di Controllo tipo 3.1 UNI EN10204
 - Dichiarazione di Conformità CE

WLL	B	M	A		
Kg	mm	mm	mm		
1500	78	37	41	1	080680115
2500	88	40	42	1	080680125
4000	94	42	45	1	080680140
6700	118	51	55	1	080680167

Attenzione:

- L'elemento di accoppiamento deve garantire un'adeguata resistenza meccanica e deve essere idoneo alla saldatura.
- La saldatura deve essere eseguita da personale competente, adeguatamente formato.

8041

golfari maschio per sollevamento, acciaio legato ad alta resistenza grado 8

CE



DATI TECNICI

- coefficiente di sicurezza: 4
 - trattamento termico: bonifica
 - codice lotto fabbricazione
- ANALISI DI LABORATORIO
- analisi chimica
 - analisi metallografica
 - test di trazione
 - test di fatica (20.000 cicli)
 - carico di collaudo (100% del lotto)
- CERTIFICATI DISPONIBILI
- Specifica Prodotto
 - Rapporto di Prova tipo 2.2 UNI EN10204
 - Certificato di Controllo tipo 3.1 UNI EN10204
 - Dichiarazione di Conformità CE

Ø	E	WLL		
mm	mm	kg		
M6	1	11	400	10 080410206
* M8	1,25	13	800	10 080410208
* M10	1,5	17	1000	6 080410210
* M12	1,75	20,5	1600	4 080410212
M14	2	20,5	3000	2 080410214
M16	2,5	30	4000	2 080410217
M18	2,5	27	5000	2 080410218
M20	3,0	36	6000	2 080410221
M22	2,5	30	7000	2 080410222
M24	3	41	8000	2 080410225
M27	3	41	10000	1 080410227
* M30	3,5	45	12000	1 080410230

(*) Caratteristiche meccaniche e materiali EN1677-1

confezioni appendibili

Ø			
mm			
* M8	1	1	080419208
* M10	1	1	080419210
* M12	1	1	080419212

Robur

Robur

8043

golfari femmina per sollevamento,
acciaio legato ad alta resistenza
grado 8

CE



DATI TECNICI

- coefficiente di sicurezza: 4
 - trattamento termico: bonifica
 - codice lotto fabbricazione
- ANALISI DI LABORATORIO
- analisi chimica
 - analisi metallografica
 - test di trazione
 - test di fatica (20.000 cicli)
 - carico di collaudo (100% del lotto)

CERTIFICATI DISPONIBILI

- Specifica Prodotto
- Rapporto di Prova tipo 2.2 UNI EN10204
- Certificato di Controllo tipo 3.1 UNI EN10204
- Dichiarazione di Conformità CE

Ø	mm	F	WLL		
mm	mm	mm	kg		
M6	1	20	400	10	080430206
* M8	1,25	20	800	10	080430208
* M10	1,50	25	1000	6	080430210
* M12	1,75	30	1600	4	080430212
M14	2	35	3000	2	080430214
M16	2,5	40	4000	2	080430217
M18	2,5	40	5000	2	080430218
M20	2,5	50	6000	2	080430221
M22	2,5	50	7000	2	080430222
M24	3	55	8000	2	080430225
M27	3	60	10000	1	080430227
* M30	3,5	60	12000	1	080430230

(* Caratteristiche meccaniche e materiali EN1677-1

confezioni appendibili

Ø	mm		
* M8	1	1	080439208
* M10	1	1	080439210
* M12	1	1	080439212

8040EZ

golfari per sollevamento
maschio, zincati

CE



DIN 580:2018-04(**)

DATI TECNICI

- Coefficiente di sicurezza: 6
 - Trattamento termico: normalizzazione
 - Codice lotto di fabbricazione
- ANALISI DI LABORATORIO
- Analisi chimica
 - Analisi metallografica
 - Test di trazione

CERTIFICATI DISPONIBILI

- Specifica Prodotto
- Rapporto di Prova tipo 2.2 UNI EN10204
- Certificato di Controllo tipo 3.1 UNI EN10204
- Dichiarazione di Conformità CE

Ø	mm	E	WLL		
mm	mm	mm	kg		
* M6	1	11	90	60	080400406
M8	1,25	13	140	60	080400408
M10	1,5	17	230	40	080400410
M12	1,75	20,5	340	20	080400412
* M14	2	20,5	480	20	080400414
M16	2	27	700	10	080400416
* M18	2,5	27	930	10	080400418
M20	2,5	30	1200	10	080400420
* M22	2,5	30	1450	10	080400422
M24	3	36	1800	5	080400424
* M27	3	41	2400	5	080400427
M30	3,5	45	3200	2	080400430
* M33	3,5	54	3900	2	080400433
* M33F	2	54	3900	2	080400434
M36	4	54	4600	2	080400436
* M36F	3	54	4600	2	080400437
M42	4,5	63	6300	1	080400442
* M42F	3	63	6300	1	080400443
M48	5	68	8600	1	080400448
* M48F	3	68	8600	1	080400449
M56	5,5	78	11500	1	080400456
* M56F	4	78	11500	1	080400457
M64	6	90	16000	1	080400464
* M64F	4	90	16000	1	080400465

*Misure dimensionate secondo Fascicolo Tecnico Robur

**Caratteristiche meccaniche e materiali

confezioni appendibili

Ø	mm		
M6	4	1	080409606
M8	4	1	080409608
M10	2	1	080409610
M12	1	1	080409412
* M14	1	1	080409414
M16	1	1	080409416
* M18	1	1	080409418
M20	1	1	080409420
* M22	1	1	080409422
M24	1	1	080409424
* M27	1	1	080409427
M30	1	1	080409430

8040EN

golfari per sollevamento
maschio, neri

CE



DIN 580:2018-04(**)

DATI TECNICI

- Coefficiente di sicurezza: 6
 - Trattamento termico: normalizzazione
 - Codice lotto di fabbricazione
- ANALISI DI LABORATORIO
- Analisi chimica
 - Analisi metallografica
 - Test di trazione

CERTIFICATI DISPONIBILI

- Specifica Prodotto
- Rapporto di Prova tipo 2.2 UNI EN10204
- Certificato di Controllo tipo 3.1 UNI EN10204
- Dichiarazione di Conformità CE

Ø	mm	E	WLL		
mm	mm	mm	kg		
* M6	1	11	90	60	080400306
M8	1,25	13	140	60	080400308
M10	1,5	17	230	40	080400310
M12	1,75	20,5	340	20	080400312
* M14	2	20,5	480	20	080400314
M16	2	27	700	10	080400316
* M18	2,5	27	930	10	080400318
M20	2,5	30	1200	10	080400320
* M22	2,5	30	1450	10	080400322
M24	3	36	1800	5	080400324
* M27	3	41	2400	5	080400327
M30	3,5	45	3200	2	080400330
* M33	3,5	54	3900	2	080400333
* M33F	2	54	3900	2	080400334
M36	4	54	4600	2	080400336
* M36F	3	54	4600	2	080400337
M42	4,5	63	6300	1	080400342
* M42F	3	63	6300	1	080400343
M48	5	68	8600	1	080400348
* M48F	3	68	8600	1	080400349
M56	5,5	78	11500	1	080400356
* M56F	4	78	11500	1	080400357
M64	6	90	16000	1	080400364
* M64F	4	90	16000	1	080400365

*Misure dimensionate secondo Fascicolo Tecnico Robur

**Caratteristiche meccaniche e materiali

confezioni appendibili

Ø	mm		
M6	4	1	080409506
M8	4	1	080409508
M10	2	1	080409510
M12	1	1	080409312
* M14	1	1	080409314
M16	1	1	080409316
* M18	1	1	080409318
M20	1	1	080409320
* M22	1	1	080409322
M24	1	1	080409324
* M27	1	1	080409327
M30	1	1	080409330

8042EZ

golfari per sollevamento
femmina, zincati

CE



DIN582:2018-04(**)

DATI TECNICI

- Coefficiente di sicurezza: 6
- Trattamento termico: normalizzazione
- Codice lotto di fabbricazione

ANALISI DI LABORATORIO

- Analisi chimica
- Analisi metallografica
- Test di trazione

CERTIFICATI DISPONIBILI

- Specifica Prodotto
- Rapporto di Prova tipo 2.2 UNI EN10204
- Certificato di Controllo tipo 3.1 UNI EN10204
- Dichiarazione di Conformità CE

Ø mm	F mm	WLL kg		
* M6	14	90	60	080420406
M8	20	140	60	080420408
M10	25	230	40	080420410
M12	30	340	30	080420412
* M14	30	480	30	080420414
M16	35	700	20	080420416
* M18	35	930	20	080420418
M20	40	1200	10	080420420
* M22	40	1450	10	080420422
M24	50	1800	5	080420424
* M27	55	2400	5	080420427
M30	60	3200	3	080420430
M36	70	4600	2	080420436
* M36F	70	4600	2	080420437
M42	80	6300	1	080420442
* M42F	80	6300	1	080420443
M48	90	8600	1	080420448
* M48F	90	8600	1	080420449

*Misure dimensionate secondo Fascicolo Tecnico Robur

**Caratteristiche meccaniche e materiali

confezioni appendibili



Ø mm			
M6	4	1	080429606
M8	4	1	080429608
M10	2	1	080429610
M12	1	1	080429412
* M14	1	1	080429414
M16	1	1	080429416
* M18	1	1	080429418
M20	1	1	080429420
* M22	1	1	080429422
M24	1	1	080429424
* M27	1	1	080429427
M30	1	1	080429430



8042EN

golfari per sollevamento
femmina, neri

CE



DIN582:2018-04(**)

DATI TECNICI

- Coefficiente di sicurezza: 6
- Trattamento termico: normalizzazione
- Codice lotto di fabbricazione

ANALISI DI LABORATORIO

- Analisi chimica
- Analisi metallografica
- Test di trazione

CERTIFICATI DISPONIBILI

- Specifica Prodotto
- Rapporto di Prova tipo 2.2 UNI EN10204
- Certificato di Controllo tipo 3.1 UNI EN10204
- Dichiarazione di Conformità CE

Ø mm	F mm	WLL kg		
* M6	14	90	60	080420306
M8	20	140	60	080420308
M10	25	230	40	080420310
M12	30	340	30	080420312
* M14	30	480	30	080420314
M16	35	700	20	080420316
* M18	35	930	20	080420318
M20	40	1200	10	080420320
* M22	40	1450	10	080420322
M24	50	1800	5	080420324
* M27	55	2400	5	080420327
M30	60	3200	3	080420330
M36	70	4600	2	080420336
* M36F	70	4600	2	080420337
M42	80	6300	1	080420342
* M42F	80	6300	1	080420343
M48	90	8600	1	080420348
* M48F	90	8600	1	080420349

*Misure dimensionate secondo Fascicolo Tecnico Robur

**Caratteristiche meccaniche e materiali

confezioni appendibili



Ø mm			
M6	4	1	080429506
M8	4	1	080429508
M10	2	1	080429510
M12	1	1	080429312
* M14	1	1	080429314
M16	1	1	080429316
* M18	1	1	080429318
M20	1	1	080429320
* M22	1	1	080429322
M24	1	1	080429324
* M27	1	1	080429327
M30	1	1	080429330

8044

golfari per sollevamento
femmina, neri

CE



UNI 2948

DATI TECNICI

- coefficiente di sicurezza: 4
- trattamento termico: normalizzazione
- codice lotto di fabbricazione

ANALISI DI LABORATORIO

- analisi chimica
- analisi metallografica
- test di trazione

CERTIFICATI DISPONIBILI

- Specifica Prodotto
- Rapporto di Prova tipo 2.2 UNI EN10204
- Certificato di Controllo tipo 3.1 UNI EN10204
- Dichiarazione di Conformità CE

Ø mm	F mm	WLL kg		
M8	25	80	4	080440008
M10	30	160	4	080440010
M12	35	250	4	080440012
M14	40	250	2	080440014
M16	50	400	2	080440016
M20	60	630	2	080440020
M24	75	1000	2	080440024

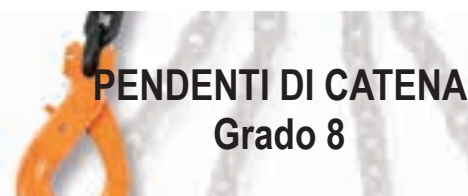

WLL Ton		UNI EN 818	
Ø D mm	0° < β ≤ 45°		45° < β ≤ 60°
	WLL 1	WLL 2	WLL 3
6	1,12	1,6	1,12
7	1,5	2,12	1,5
8	2	2,8	2
10	3,15	4,25	3,15
13	5,3	7,5	5,3
16	8	11,2	8
6	2,36	1,7	
7	3,15	2,24	
8	4,25	3	
10	6,7	4,75	
13	11,2	8	
16	17	11,2	

8091

pendenti per sollevamento
catena a 1 braccio
grado 8

CE



UNI EN 818-4

DATI TECNICI

- coefficiente di sicurezza: 4
 - piastrina di identificazione seriale
- CERTIFICATI ALLEGATI**
- Certificato del Fabbricante UNI EN818-4
 - Dichiarazione di Conformità CE
- CERTIFICATI DISPONIBILI**
- Specifica Prodotto

D mm	L m	WLL ton	📦	📦
6*	1	1,12	1	080910001
6*	2	1,12	1	080910002
6*	3	1,12	1	080910003
6*	4	1,12	1	080910004
7*	1	1,5	1	080910021
7*	2	1,5	1	080910022
7*	3	1,5	1	080910023
7*	4	1,5	1	080910024
8*	1	2	1	080910041
8*	2	2	1	080910042
8*	3	2	1	080910043
8*	4	2	1	080910044
10*	1	3,15	1	080910051
10*	2	3,15	1	080910052
10*	3	3,15	1	080910053
10*	4	3,15	1	080910054
13*	1	5,3	1	080910131
13*	2	5,3	1	080910132
13*	3	5,3	1	080910133
13*	4	5,3	1	080910134
16*	1	8	1	080910161
16*	2	8	1	080910162
16*	3	8	1	080910163
16*	4	8	1	080910164
20	1	12,5	1	080910171
20	2	12,5	1	080910172
20	3	12,5	1	080910173
20	4	12,5	1	080910174

* Imballo in valigetta

8091SL

pendenti per sollevamento
catena a 1 braccio, gancio Self-Locking
grado 8

CE

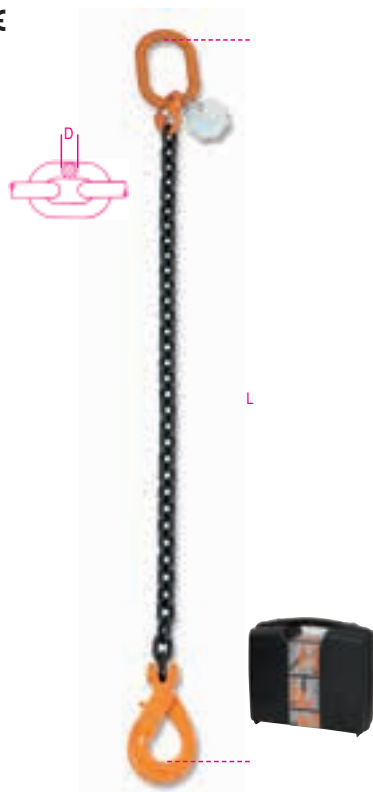

UNI EN 818-4

DATI TECNICI

- coefficiente di sicurezza: 4
 - piastrina di identificazione seriale
- CERTIFICATI ALLEGATI**
- Certificato del Fabbricante UNI EN818-4
 - Dichiarazione di Conformità CE
- CERTIFICATI DISPONIBILI**
- Specifica Prodotto

D mm	L m	WLL ton	📦	📦
6*	1	1,12	1	080910201
6*	2	1,12	1	080910202
6*	3	1,12	1	080910203
6*	4	1,12	1	080910204
7*	1	1,5	1	080910221
7*	2	1,5	1	080910222
7*	3	1,5	1	080910223
7*	4	1,5	1	080910224
8*	1	2	1	080910241
8*	2	2	1	080910242
8*	3	2	1	080910243
8*	4	2	1	080910244
10*	1	3,15	1	080910251
10*	2	3,15	1	080910252
10*	3	3,15	1	080910253
10*	4	3,15	1	080910254
13*	1	5,3	1	080910331
13*	2	5,3	1	080910332
13*	3	5,3	1	080910333
13*	4	5,3	1	080910334
16*	1	8	1	080910361
16*	2	8	1	080910362
16*	3	8	1	080910363
16*	4	8	1	080910364
20	1	12,5	1	080910401
20	2	12,5	1	080910402
20	3	12,5	1	080910403
20	4	12,5	1	080910404

* Imballo in valigetta

8092

pendenti per sollevamento
catena a 2 bracci
grado 8

CE



UNI EN 818-4

DATI TECNICI

- coefficiente di sicurezza: 4
 - piastrina di identificazione seriale
- CERTIFICATI ALLEGATI**
- Certificato del Fabbricante UNI EN818-4
 - Dichiarazione di Conformità CE
- CERTIFICATI DISPONIBILI**
- Specifica Prodotto

D mm	L m	WLL ton	📦	📦
6*	1	1,6	1	080920001
6*	2	1,6	1	080920002
6*	3	1,6	1	080920003
6*	4	1,6	1	080920004
7*	1	2,12	1	080920021
7*	2	2,12	1	080920022
7*	3	2,12	1	080920023
7*	4	2,12	1	080920024
8*	1	2,8	1	080920041
8*	2	2,8	1	080920042
8*	3	2,8	1	080920043
8*	4	2,8	1	080920044
10*	1	4,25	1	080920051
10*	2	4,25	1	080920052
10*	3	4,25	1	080920053
10*	4	4,25	1	080920054
13*	1	7,5	1	080920131
13*	2	7,5	1	080920132
13	3	7,5	1	080920133
13	4	7,5	1	080920134
16*	1	11,2	1	080920161
16	2	11,2	1	080920162
16	3	11,2	1	080920163
16	4	11,2	1	080920164
20	2	17,0	1	080920172
20	3	17,0	1	080920173
20	4	17,0	1	080920174

* Imballo in valigetta



Robur

8092SL

pendenti per sollevamento
catena a 2 bracci, ganci Self-Locking
grado 8

CE



UNI EN 818-4

DATI TECNICI

- coefficiente di sicurezza: 4
 - piastrina di identificazione seriale
- CERTIFICATI ALLEGATI
- Certificato del Fabbricante UNI EN818-4
 - Dichiarazione di Conformità CE
- CERTIFICATI DISPONIBILI
- Specifica Prodotto

D mm	L m	WLL ton	🔧	📄
6*	1	1,6	1	080920201
6*	2	1,6	1	080920202
6*	3	1,6	1	080920203
6*	4	1,6	1	080920204
7*	1	2,12	1	080920221
7*	2	2,12	1	080920222
7*	3	2,12	1	080920223
7*	4	2,12	1	080920224
8*	1	2,8	1	080920241
8*	2	2,8	1	080920242
8*	3	2,8	1	080920243
8*	4	2,8	1	080920244
10*	1	4,25	1	080920251
10*	2	4,25	1	080920252
10*	3	4,25	1	080920253
10*	4	4,25	1	080920254
13*	1	7,5	1	080920331
13*	2	7,5	1	080920332
13*	3	7,5	1	080920333
13*	4	7,5	1	080920334
16*	1	11,2	1	080920361
16*	2	11,2	1	080920362
16*	3	11,2	1	080920363
16*	4	11,2	1	080920364
20	2	17,0	1	080920402
20	3	17,0	1	080920403
20	4	17,0	1	080920404

* Imballo in valigetta

8094

pendenti per sollevamento
catena a 4 bracci
grado 8

CE



UNI EN 818-4

DATI TECNICI

- coefficiente di sicurezza: 4
 - piastrina di identificazione seriale
- CERTIFICATI ALLEGATI
- Certificato del Fabbricante UNI EN818-4
 - Dichiarazione di Conformità CE
- CERTIFICATI DISPONIBILI
- Specifica Prodotto

D mm	L m	WLL ton	🔧	📄
6*	1	2,36	1	080940001
6*	2	2,36	1	080940002
6*	3	2,36	1	080940003
6*	4	2,36	1	080940004
7*	1	3,15	1	080940021
7*	2	3,15	1	080940022
7*	3	3,15	1	080940023
7*	4	3,15	1	080940024
8*	1	4,25	1	080940041
8*	2	4,25	1	080940042
8*	3	4,25	1	080940043
8	4	4,25	1	080940044
10*	1	6,7	1	080940051
10	2	6,7	1	080940052
10	3	6,7	1	080940053
10	4	6,7	1	080940054
13	1	11,2	1	080940131
13	2	11,2	1	080940132
13	3	11,2	1	080940133
13	4	11,2	1	080940134
16	1	17	1	080940161
16	2	17	1	080940162
16	3	17	1	080940163
16	4	17	1	080940164
20	2	26,5	1	080940172
20	3	26,5	1	080940173
20	4	26,5	1	080940174

* Imballo in valigetta

Robur

Robur

8094SL

pendenti per sollevamento
catena a 4 bracci, ganci Self-Locking
grado 8

CE



UNI EN 818-4

DATI TECNICI

- coefficiente di sicurezza: 4
 - piastrina di identificazione seriale
- CERTIFICATI ALLEGATI
- Certificato del Fabbricante UNI EN818-4
 - Dichiarazione di Conformità CE
- CERTIFICATI DISPONIBILI
- Specifica Prodotto

D mm	L m	WLL ton	🔧	📄
6*	1	2,36	1	080940201
6*	2	2,36	1	080940202
6*	3	2,36	1	080940203
6*	4	2,36	1	080940204
7*	1	3,15	1	080940221
7*	2	3,15	1	080940222
7*	3	3,15	1	080940223
7*	4	3,15	1	080940224
8*	1	4,25	1	080940241
8*	2	4,25	1	080940242
8*	3	4,25	1	080940243
8	4	4,25	1	080940244
10*	1	6,7	1	080940251
10	2	6,7	1	080940252
10	3	6,7	1	080940253
10	4	6,7	1	080940254
13	1	11,2	1	080940331
13	2	11,2	1	080940332
13	3	11,2	1	080940333
13	4	11,2	1	080940334
16	1	17	1	080940361
16	2	17	1	080940362
16	3	17	1	080940363
16	4	17	1	080940364
20	2	26,5	1	080940402
20	3	26,5	1	080940403
20	4	26,5	1	080940404

* Imballo in valigetta

8096

pendenti per sollevamento
con ganci accorciatori
catena ad 1 braccio, grado 8

CE



UNI EN 818-4

DATI TECNICI

- coefficiente di sicurezza: 4
 - piastrina di identificazione seriale
- CERTIFICATI ALLEGATI**
- Certificato del Fabbricante UNI EN818-4
 - Dichiarazione di Conformità CE
- CERTIFICATI DISPONIBILI**
- Specifica Prodotto

D mm	L m	WLL ton	📦	📦
6*	1	1,12	1	080960001
6*	2	1,12	1	080960002
6*	3	1,12	1	080960003
6*	4	1,12	1	080960004
7*	1	1,5	1	080960021
7*	2	1,5	1	080960022
7*	3	1,5	1	080960023
7*	4	1,5	1	080960024
8*	1	2	1	080960041
8*	2	2	1	080960042
8*	3	2	1	080960043
8*	4	2	1	080960044
10*	1	3,15	1	080960051
10*	2	3,15	1	080960052
10*	3	3,15	1	080960053
10*	4	3,15	1	080960054
13*	1	5,3	1	080960131
13*	2	5,3	1	080960132
13*	3	5,3	1	080960133
13*	4	5,3	1	080960134
16*	1	8	1	080960161
16*	2	8	1	080960162
16*	3	8	1	080960163
16	4	8	1	080960164
20	1	12,5	1	080960171
20	2	12,5	1	080960172
20	3	12,5	1	080960173
20	4	12,5	1	080960174

* Imballo in valigetta

8096SL

pendenti per sollevamento
con gancio Self-Locking e accorciatore
catena ad 1 braccio, grado 8

CE



UNI EN 818-4

DATI TECNICI

- coefficiente di sicurezza: 4
 - piastrina di identificazione seriale
- CERTIFICATI ALLEGATI**
- Certificato del Fabbricante UNI EN818-4
 - Dichiarazione di Conformità CE
- CERTIFICATI DISPONIBILI**
- Specifica Prodotto

D mm	L m	WLL ton	📦	📦
6*	1	1,12	1	080960201
6*	2	1,12	1	080960202
6*	3	1,12	1	080960203
6*	4	1,12	1	080960204
7*	1	1,5	1	080960221
7*	2	1,5	1	080960222
7*	3	1,5	1	080960223
7*	4	1,5	1	080960224
8*	1	2	1	080960241
8*	2	2	1	080960242
8*	3	2	1	080960243
8*	4	2	1	080960244
10*	1	3,15	1	080960251
10*	2	3,15	1	080960252
10*	3	3,15	1	080960253
10*	4	3,15	1	080960254
13*	1	5,3	1	080960331
13*	2	5,3	1	080960332
13*	3	5,3	1	080960333
13*	4	5,3	1	080960334
16*	1	8	1	080960361
16*	2	8	1	080960362
16*	3	8	1	080960363
16	4	8	1	080960364
20	1	12,5	1	080960401
20	2	12,5	1	080960402
20	3	12,5	1	080960403
20	4	12,5	1	080960404

* Imballo in valigetta

8097

pendenti per sollevamento
con ganci accorciatori
catena a 2 bracci, grado 8

CE



UNI EN 818-4

DATI TECNICI

- coefficiente di sicurezza: 4
 - piastrina di identificazione seriale
- CERTIFICATI ALLEGATI**
- Certificato del Fabbricante UNI EN818-4
 - Dichiarazione di Conformità CE
- CERTIFICATI DISPONIBILI**
- Specifica Prodotto

D mm	L m	WLL ton	📦	📦
6*	1	1,6	1	080970001
6*	2	1,6	1	080970002
6*	3	1,6	1	080970003
6*	4	1,6	1	080970004
7*	1	2,12	1	080970021
7*	2	2,12	1	080970022
7*	3	2,12	1	080970023
7*	4	2,12	1	080970024
8*	1	2,8	1	080970041
8*	2	2,8	1	080970042
8*	3	2,8	1	080970043
8*	4	2,8	1	080970044
10*	1	4,25	1	080970051
10*	2	4,25	1	080970052
10*	3	4,25	1	080970053
10*	4	4,25	1	080970054
13*	1	7,5	1	080970131
13*	2	7,5	1	080970132
13	3	7,5	1	080970133
13	4	7,5	1	080970134
16	1	11,2	1	080970161
16	2	11,2	1	080970162
16	3	11,2	1	080970163
16	4	11,2	1	080970164
20	2	17,0	1	080970172
20	3	17,0	1	080970173
20	4	17,0	1	080970174

* Imballo in valigetta



8097SL

pendenti per sollevamento
con ganci Self-Locking e accorciatori
catena a 2 bracci, grado 8

CE



UNI EN 818-4

DATI TECNICI

- coefficiente di sicurezza: 4
 - piastrina di identificazione seriale
- CERTIFICATI ALLEGATI**
- Certificato del Fabbricante UNI EN818-4
 - Dichiarazione di Conformità CE
- CERTIFICATI DISPONIBILI**
- Specifica Prodotto

D mm	L m	WLL ton		
6*	1	1,6	1	080970201
6*	2	1,6	1	080970202
6*	3	1,6	1	080970203
6*	4	1,6	1	080970204
7*	1	2,12	1	080970221
7*	2	2,12	1	080970222
7*	3	2,12	1	080970223
7*	4	2,12	1	080970224
8*	1	2,8	1	080970241
8*	2	2,8	1	080970242
8*	3	2,8	1	080970243
8*	4	2,8	1	080970244
10*	1	4,25	1	080970251
10*	2	4,25	1	080970252
10*	3	4,25	1	080970253
10*	4	4,25	1	080970254
13*	1	7,5	1	080970331
13*	2	7,5	1	080970332
13	3	7,5	1	080970333
13	4	7,5	1	080970334
16	1	11,2	1	080970361
16	2	11,2	1	080970362
16	3	11,2	1	080970363
16	4	11,2	1	080970364
20	2	17,0	1	080970402
20	3	17,0	1	080970403
20	4	17,0	1	080970404

* Imballo in valigetta

8098

pendenti per sollevamento
con ganci accorciatori
catena a 4 bracci, grado 8

CE



UNI EN 818-4

DATI TECNICI

- coefficiente di sicurezza: 4
 - piastrina di identificazione seriale
- CERTIFICATI ALLEGATI**
- Certificato del Fabbricante UNI EN818-4
 - Dichiarazione di Conformità CE
- CERTIFICATI DISPONIBILI**
- Specifica Prodotto

D mm	L m	WLL ton		
6*	1	2,36	1	080980001
6*	2	2,36	1	080980002
6*	3	2,36	1	080980003
6*	4	2,36	1	080980004
7*	1	3,15	1	080980021
7*	2	3,15	1	080980022
7*	3	3,15	1	080980023
7*	4	3,15	1	080980024
8*	1	4,25	1	080980041
8*	2	4,25	1	080980042
8*	3	4,25	1	080980043
8	4	4,25	1	080980044
10*	1	6,7	1	080980051
10	2	6,7	1	080980052
10	3	6,7	1	080980053
10	4	6,7	1	080980054
13	1	11,2	1	080980131
13	2	11,2	1	080980132
13	3	11,2	1	080980133
13	4	11,2	1	080980134
16	1	17	1	080980161
16	2	17	1	080980162
16	3	17	1	080980163
16	4	17	1	080980164
20	2	26,5	1	080980172
20	3	26,5	1	080980173
20	4	26,5	1	080980174

* Imballo in valigetta

8098SL

pendenti per sollevamento
con ganci Self-Locking e accorciatori
catena a 4 bracci, grado 8

CE



UNI EN 818-4

DATI TECNICI

- coefficiente di sicurezza: 4
 - piastrina di identificazione seriale
- CERTIFICATI ALLEGATI**
- Certificato del Fabbricante UNI EN818-4
 - Dichiarazione di Conformità CE
- CERTIFICATI DISPONIBILI**
- Specifica Prodotto

D mm	L m	WLL ton		
6*	1	2,36	1	080980201
6*	2	2,36	1	080980202
6*	3	2,36	1	080980203
6*	4	2,36	1	080980204
7*	1	3,15	1	080980221
7*	2	3,15	1	080980222
7*	3	3,15	1	080980223
7*	4	3,15	1	080980224
8*	1	4,25	1	080980241
8*	2	4,25	1	080980242
8	3	4,25	1	080980243
8*	4	4,25	1	080980244
10*	1	6,7	1	080980251
10	2	6,7	1	080980252
10	3	6,7	1	080980253
10	4	6,7	1	080980254
13	1	11,2	1	080980331
13	2	11,2	1	080980332
13	3	11,2	1	080980333
13	4	11,2	1	080980334
16	1	17	1	080980361
16	2	17	1	080980362
16	3	17	1	080980363
16	4	17	1	080980364
20	2	26,5	1	080980402
20	3	26,5	1	080980403
20	4	26,5	1	080980404

* Imballo in valigetta

Robur

Robur

8100

catene per sollevamento,
acciaio legato ad alta resistenza
grado 8

CE

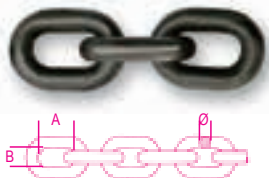

EN 818-2

DATI TECNICI

- coefficiente di sicurezza: 4
- trattamento termico: bonifica
- codice lotto di fabbricazione

ANALISI DI LABORATORIO

- analisi chimica
- analisi metallografica
- test di trazione

CERTIFICATI DISPONIBILI

- Specifica Prodotto
- Rapporto di Prova tipo 2.2 UNI EN10204
- Certificato del Fabbricante EN818-2
- Dichiarazione di Conformità CE

WLL	Ø mm	A	B min		
kg	mm	mm	mm		
1120	6	18	7,8	1	081000011
1500	7	21	11,0	1	081000016
2000	8	24	12,0	1	081000020
3150	10	30	14,5	1	081000032
5300	13	39	20,0	1	081000053
8000	16	48	20,8	1	081000080
12500	20	60	26,0	1	081000125

* ATTENZIONE: il prodotto viene consegnato in un unico spezzone di catena, salvo diversa indicazione in fase d'ordine!

8085R

campanelle per sollevamento,
acciaio legato ad alta resistenza

CE



EN 1677-4
GRADO 8

DATI TECNICI

- coefficiente di sicurezza: 4
 - trattamento termico: bonifica
 - codice lotto fabbricazione
- ### ANALISI DI LABORATORIO
- analisi chimica, analisi metallografica
 - test carico di prova (WLL x 2,5)
 - test di trazione
 - test di fatica (min. 20.000 cicli)

CERTIFICATI DISPONIBILI

- Specifica Prodotto
- Rapporto di Prova tipo 2.2 UNI EN10204
- Certificato di Controllo tipo 3.1 UNI EN10204
- Dichiarazione di Conformità CE

WLL	Ø mm	A	B		
kg	mm	mm	mm		
* 1600	7	110	60	1	080850215
2120	8	110	60	1	080850220
3150	10	135	75	1	080850232
5300	13	160	90	1	080850253
8000	16	180	100	1	080850280
11200	19	200	110	1	080850311
16000	20	260	140	1	080850316
17000	22	300	160	1	080850317

Il carico di lavoro è relativo all'utilizzo con imbragature ad 1 braccio. (*) Abbinata a catena Ø 6, WLL= 1120 kg.

8086

campanelle per sollevamento triple,
acciaio legato ad alta resistenza
grado 8

CE

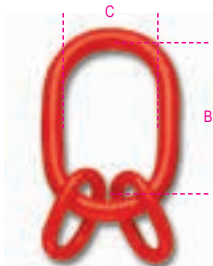

EN 1677-4

DATI TECNICI

- coefficiente di sicurezza: 4
 - trattamento termico: bonifica
 - codice lotto fabbricazione
- ### ANALISI DI LABORATORIO
- analisi chimica, analisi metallografica
 - test carico di prova (WLL x 2,5)
 - test di trazione
 - test di fatica (min. 20.000 cicli)

CERTIFICATI DISPONIBILI

- Specifica Prodotto
- Rapporto di Prova tipo 2.2 UNI EN10204
- Certificato di Controllo tipo 3.1 UNI EN10204
- Dichiarazione di Conformità CE

WLL	Ø mm	B	C		
kg	mm	mm	mm		
* 3150	7	135	75	1	080860021
4250	8	160	90	1	080860042
6700	10	180	100	1	080860067
11200	13	200	110	1	080860100
17000	16	260	140	1	080860117
21200	18	340	180	1	080860121
26500	20	350	190	1	080860126

Il carico di lavoro è riferito a imbragature 3 o 4 bracci e angolo β inferiore a 45°.

(*) Abbinata a catena Ø 6mm, WLL= 2360 kg

8090R

maglie di giunzione per sollevamento,
acciaio legato ad alta resistenza
grado 8

CE

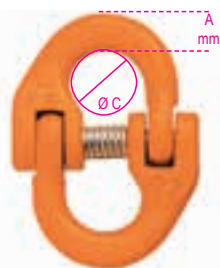

EN 1677-1

DATI TECNICI

- coefficiente di sicurezza: 4
 - trattamento termico: bonifica
 - codice lotto fabbricazione
- ### ANALISI DI LABORATORIO
- analisi chimica, analisi metallografica
 - test carico di prova (WLL x 2,5)
 - test di trazione
 - test di fatica (min. 20.000 cicli)

CERTIFICATI DISPONIBILI

- Specifica Prodotto
- Rapporto di Prova tipo 2.2 UNI EN10204
- Certificato di Controllo tipo 3.1 UNI EN10204
- Dichiarazione di Conformità CE

WLL	Ø mm	Ø C	A		
kg	mm	max	mm		
1120	6	13	7,5	1	080900111
1500	7	18	9	1	080900115
2000	8	18	11	1	080900120
3150	10	22	13,0	1	080900131
5300	13	30	16	1	080900153
8000	16	32	22	1	080900180
12500	20	40	25	1	080900312

8060R

ganci per sollevamento
tipo Clevis a forcella,
acciaio legato ad alta resistenza
grado 8

CE



EN 1677-2

DATI TECNICI

- coefficiente di sicurezza: 4
 - trattamento termico: bonifica
 - codice lotto perno, linguetta, corpo
- ### ANALISI DI LABORATORIO
- analisi chimica, analisi metallografica
 - test di trazione
 - test di fatica (min. 20.000 cicli)
 - carico di collaudo (100% del lotto)

CERTIFICATI DISPONIBILI

- Specifica Prodotto
- Rapporto di Prova tipo 2.2 UNI EN10204
- Certificato di Controllo tipo 3.1 UNI EN10204
- Dichiarazione di Conformità CE

WLL	Ø mm	C		
kg	mm	mm		
1120	6	19	1	080600111
1500	7	19	1	080600115
2000	8	21	1	080600120
3150	10	27	1	080600132
5300	13	35	1	080600153
8000	16	48	1	080600180
12500	20	54	1	080600225

8058R

ganci per sollevamento
tipo self-locking a forcella
acciaio legato ad alta resistenza
grado 8

CE



EN 1677-3

DATI TECNICI

- coefficiente di sicurezza: 4
 - trattamento termico: bonifica
 - codice lotto fabbricazione
- ### ANALISI DI LABORATORIO
- analisi chimica, analisi metallografica
 - test di trazione
 - test di fatica (min. 20.000 cicli)
 - carico di collaudo (100% del lotto)

CERTIFICATI DISPONIBILI

- Specifica Prodotto
- Rapporto di Prova tipo 2.2 UNI EN10204
- Certificato di Controllo tipo 3.1 UNI EN10204
- Dichiarazione di Conformità CE

WLL	Ø mm	J min		
kg	mm	mm		
1120	6	28	1	080580112
2000	7-8	34	1	080580120
3150	10	44	1	080580132
5300	13	52	1	080580153
8000	16	67	1	080580180
12500	20	77	1	080580225

8061R

ganci accorciatori a forcella
con sicura di bloccaggio,
acciaio legato ad alta resistenza
grado 8

CE



EN 1677-1

DATI TECNICI

- coefficiente di sicurezza: 4
- trattamento termico: bonifica
- codice lotto fabbricazione

ANALISI DI LABORATORIO

- analisi chimica, analisi metallografica
- test di trazione
- test di fatica (min. 20.000 cicli)

- carico di collaudo (100% del lotto)

CERTIFICATI DISPONIBILI

- Specifica Prodotto
- Rapporto di Prova tipo 2.2 UNI EN10204
- Certificato di Controllo tipo 3.1 UNI EN10204
- Dichiarazione di Conformità CE

WLL	Ø	E		
kg	mm	mm		
1120	6	8	1	080610211
2000	7-8	11	1	080610220
3150	10	13	1	080610231
5300	13	17	1	080610253
8000	16	20	1	080610280
12500	20	24	1	080610312

8052

ganci per sollevamento ad occhio,
acciaio legato ad alta resistenza
grado 8

CE



EN 1677-2

DATI TECNICI

- coefficiente di sicurezza: 4
- trattamento termico: bonifica
- codice lotto fabbricazione

ANALISI DI LABORATORIO

- analisi chimica, analisi metallografica
- test carico di prova (2,5 x wll)
- test di trazione • test di fatica (min. 20.000 cicli)
- carico di collaudo (100% del lotto)

CERTIFICATI DISPONIBILI

- Specifica Prodotto
- Rapporto di Prova tipo 2.2 UNI EN10204
- Certificato di Controllo tipo 3.1 UNI EN10204
- Dichiarazione di Conformità CE

WLL	C		
kg	mm		
8052	800	18	1 080520008
8052	1120	22,5	1 080520011
8052	2000	30	1 080520020
8052	3150	36	1 080520031
8052	4000	39,5	1 080520040

8055S	5400	32	1 080550145
8055S	8000	43	1 080550170
8055S	11500	53	1 080550215
8055S	16000	58	1 080550260
8055S	22000	78	1 080550320

8057R

ganci per sollevamento
tipo self-locking ad occhio,
acciaio legato ad alta resistenza
grado 8

CE



EN 1677-3

DATI TECNICI

- coefficiente di sicurezza: 4
- trattamento termico: bonifica
- codice lotto fabbricazione

ANALISI DI LABORATORIO

- analisi chimica, analisi metallografica
- test di trazione
- test di fatica (min. 20.000 cicli)
- carico di collaudo (100% del lotto)

CERTIFICATI DISPONIBILI

- Specifica Prodotto
- Rapporto di Prova tipo 2.2 UNI EN10204
- Certificato di Controllo tipo 3.1 UNI EN10204
- Dichiarazione di Conformità CE

WLL	Ø	J min	ØB		
kg	mm	mm	mm		
1120	6	28	22	1	080570112
2000	7-8	34	25	1	080570120
3150	10	44	32	1	080570132
5300	13	54	40	1	080570153

8063

ganci per sollevamento
orientabili (non sotto carico)
acciaio legato alta resistenza
grado 8

CE



EN 1677-1

DATI TECNICI

- coefficiente di sicurezza: 4
- trattamento termico: bonifica
- codice lotto fabbricazione

ANALISI DI LABORATORIO

- analisi chimica, analisi metallografica
- test di trazione • test di fatica (min. 20.000 cicli)
- carico di collaudo (100% del lotto)

CERTIFICATI DISPONIBILI

- Specifica Prodotto
- Rapporto di Prova tipo 2.2 UNI EN10204
- Certificato di Controllo tipo 3.1 UNI EN10204
- Dichiarazione di Conformità CE

WLL	A	E		
kg	mm	mm		
800	32	20,5	1	080630008
1120	38	20,5	1	080630011
2000	44,5	22	1	080630020
3150	44,5	27	1	080630031

8063SL

ganci autoserranti
orientabili (non sotto carico)
acciaio legato alta resistenza
grado 8

CE

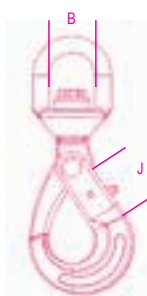

EN 1677-1

Dati tecnici

- Coefficiente di sicurezza: 4
- Trattamento termico: bonifica
- Codice lotto fabbricazione

Analisi di laboratorio

- Analisi chimica, analisi metallografica
- Test di trazione
- Test di fatica (min. 20.000 cicli)
- Carico di collaudo (100% del lotto)

Certificati disponibili

- Specifica Prodotto
- Rapporto di Prova tipo 2.2 UNI EN10204
- Certificato di Controllo tipo 3.1 UNI EN10204
- Dichiarazione di Conformità CE

WLL	Ø	B	J		
kg	mm	mm	mm		
1120	6	32	45	1	080630311
2000	8	35	59	1	080630320
3150	10	42	54	1	080630331
5300	13	49	83	1	080630353

8064S

ganci per sollevamento
orientabili (non sotto carico)
acciaio al carbonio
grado 4

CE



EN 1677-5

DATI TECNICI

- coefficiente di sicurezza: 5
- trattamento termico: bonifica
- codice lotto fabbricazione
- analisi chimica, analisi metallografica
- test carico di prova (WLL x 2,5)
- test di trazione • test di fatica (min. 20.000 cicli)

CERTIFICATI DISPONIBILI

- Specifica Prodotto
- Rapporto di Prova tipo 2.2 UNI EN10204
- Certificato di Controllo tipo 3.1 UNI EN10204
- Dichiarazione di Conformità CE

WLL	B	C		
kg	mm	mm		
800	31	20	1	080640107
1000	40	22	1	080640110
1600	47	23	1	080640115
2000	47	27	1	080640120
3200	64	35	1	080640130
5000	77	43	1	080640150
7500	90	53	1	080640175
10000	96	58	1	080640199

8065SC

ganci per sollevamento
girevoli sotto carico, con cuscinetto
acciaio al carbonio
grado 4

CE

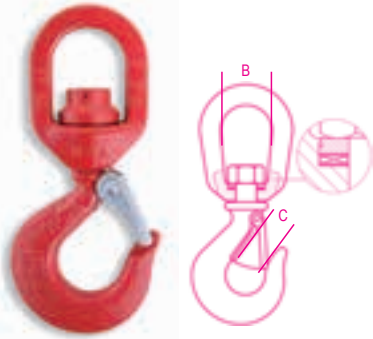

EN 1677-5

DATI TECNICI

- coefficiente di sicurezza: 5
- trattamento termico: bonifica
- codice lotto fabbricazione
- ANALISI DI LABORATORIO
- analisi chimica, analisi metallografica
- test carico di prova (WLL x 2,5)
- test di trazione
- test di fatica (min. 20.000 cicli)

CERTIFICATI DISPONIBILI

- Specifica Prodotto
- Rapporto di Prova tipo 2.2 UNI EN10204
- Certificato di Controllo tipo 3.1 UNI EN10204
- Dichiarazione di Conformità CE

WLL kg	B mm	C mm	
800	38	20	1 080650107
1000	38	22	1 080650110
1600	47	23	1 080650115
2000	47	27	1 080650120
3200	54	35	1 080650130
5000	72	43	1 080650150
7500	82	53	1 080650175

8062

ganci scorsoi,
acciaio legato ad alta resistenza

CE

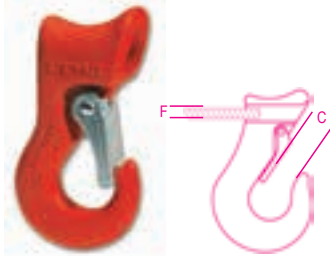

DATI TECNICI

- coefficiente di sicurezza: 5
- trattamento termico: bonifica
- codice lotto fabbricazione
- ANALISI DI LABORATORIO
- analisi chimica, analisi metallografica
- test carico di prova (WLL x 2,5)
- test di trazione

CERTIFICATI DISPONIBILI

- Specifica Prodotto
- Rapporto di Prova tipo 2.2 UNI EN10204
- Certificato di Controllo tipo 3.1 UNI EN10204
- Dichiarazione di Conformità CE

WLL kg	C mm	F mm	
1500	19	10-13	1 080620013
2000	21	16	1 080620016
3000	26	18	1 080620018
5000	34	22-25	1 080620025

8051S

ganci per sollevamento con sicura
acciaio al carbonio
zincati

CE



GRADO 4

DATI TECNICI

- coefficiente di sicurezza: 4
- trattamento termico: normalizzazione
- codice lotto di fabbricazione

ANALISI DI LABORATORIO

- analisi chimica
- analisi metallografica
- test di trazione

CERTIFICATI DISPONIBILI

- Specifica Prodotto
- Rapporto di Prova tipo 2.2 UNI EN10204
- Certificato di Controllo tipo 3.1 UNI EN10204
- Dichiarazione di Conformità CE

WLL kg	C mm	F mm	
250	14	12	10 080510202
500	18	16,5	5 080510205

confezioni appendibili

WLL kg			
250	1	1	080519202
500	1	1	080519205

8135

pinze di sollevamento lamiere
con anello di sospensione snodato

CE



EN13155

Dati tecnici:

- Coefficiente di sicurezza: 3
- Piastra di identificazione seriale

Certificati disponibili:

- Certificato del Fabbricante
- Dichiarazione di Conformità CE
- Rapporto di Prova tipo 2.2 UNI EN10204
- Manuale d'uso e manutenzione

WLL t	A mm	kg	
0,75	0-15	2	1 081350005
1,0	0-20	5	1 081350010
2,0	0-25	8	1 081350020
3,0	0-30	15	1 081350032
5,0	0-50	23	1 081350050

8143

paranco manuale a catena

CE



EN13157

Dati tecnici:

- Coefficiente di sicurezza: 4
- Piastra di identificazione seriale

Certificati disponibili:

- Certificato del Fabbricante
- Dichiarazione di Conformità CE
- Rapporto di Prova tipo 2.2 UNI EN10204
- Specifica Prodotto

WLL t	L m	H mm	sforzo / effort kg	
0,5	3	285	27	1 081430005
1	3	315	44	1 081430010
2	3	380	44	1 081430020
3	3	475	45	1 081430030
5	3	600	47	1 081430050

0,5	6	285	27	1 081430105
1	6	315	44	1 081430110
2	6	380	44	1 081430120
3	6	475	45	1 081430130
5	6	600	47	1 081430150

Robur

8146

paranco a leva

CE



H

EN13157

DATI TECNICI

- coefficiente di sicurezza: 4
 - piastra di identificazione seriale
- CERTIFICATI DISPONIBILI**
- Certificato del Fabbricante
 - Dichiarazione di Conformità CE
 - Rapporto di Prova tipo 2.2 UNI EN10204
 - Specifica Prodotto

WLL	t	Lm	H	sforzo / effort		
	t	Lm	mm	kg		
0,75	1,5	320	21*		1	081460008
1,5	1,5	380	41*		1	081460015
3,0	1,5	480	41		1	081460030
6,0	1,5	600	46		1	081460060

0,75	3,0	320	21*		1	081460108
1,5	3,0	380	41*		1	081460115
3,0	3,0	480	41		1	081460130
6,0	3,0	600	46		1	081460160

H= distanza minima tra i ganci

* con sistema di protezione da sovraccarico



8146C

paranco a leva compatto

CE



H

EN13157

Dati tecnici:

- Coefficiente di sicurezza: 4
 - Piastra di identificazione seriale
- Certificati disponibili:**
- Certificato del Fabbricante
 - Dichiarazione di Conformità CE
 - Rapporto di Prova tipo 2.2 UNI EN10204
 - Specifica Prodotto

WLL	t	Lm	H	sforzo / effort		
	t	Lm	mm	kg		
0,25	1,5	230	20,7		1	081460002

H= distanza minima tra i ganci

8149S/A

sacco raccogli catena paranchi
in tessuto colore nero



A	C	8143	8143			
mm	mm	t	Lm			
100	250	0,5 - 1	3/6 - 3/6		1	081490510
120	350	2 - 3	3/6 - 3		1	081490512
150	450	3 - 5	6 - 3/6		1	081490515

8147C

carrelli di traslazione a catena
per paranchi manuali

Idonei per travi strutturali come ad esempio travi INP, IPB, IPE, HEA, HEB

CE

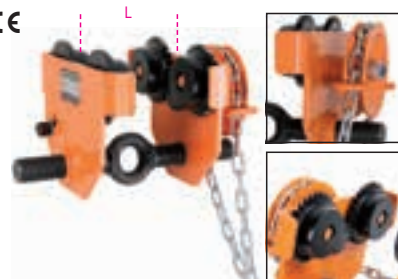

EN 13157

Dati tecnici:

- Coefficiente di sicurezza: 4
- Piastra di identificazione seriale

Certificati disponibili:

- Certificato del Fabbricante
- Dichiarazione di Conformità CE
- Rapporto di Prova tipo 2.2 UNI EN10204
- Specifica Prodotto

WLL	L min	L max	ØF		
t	mm	mm	Lm		
1,0	58	220	3	1	081470510
2,0	66	220	3	1	081470520
3,0	74	220	3	1	081470530
5,0	90	220	3	1	081470550

Articolo fornito smontato: deve essere assemblato prima dell'utilizzo in accordo al manuale istruzioni.

8147S

carrelli di traslazione a spinta
per paranchi manuali

Idonei per travi strutturali come ad esempio travi INP, IPB, IPE, HEA, HEB

CE



EN 13157

Dati tecnici:

- Coefficiente di sicurezza: 4
- Piastra di identificazione seriale

Certificati disponibili:

- Certificato del Fabbricante
- Dichiarazione di Conformità CE
- Rapporto di Prova tipo 2.2 UNI EN10204
- Specifica Prodotto

WLL	L min	L max	ØF		
t	mm	mm	mm		
0,5	50	220	25	1	081470005
1,0	58	220	30	1	081470010
2,0	66	220	40	1	081470020

Articolo fornito smontato: deve essere assemblato prima dell'utilizzo in accordo al manuale istruzioni.

Robur

Robur

8147P

pinze di ancoraggio per paranchi manuali

Idonei per travi strutturali come ad esempio travi INP, IPB, IPE, HEA, HEB

CE

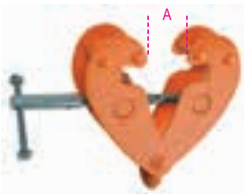

EN13157

Dati tecnici:

- Coefficiente di sicurezza: 4
- Piastra di identificazione seriale

Certificati disponibili:

- Certificato del Fabbricante
- Dichiarazione di Conformità CE
- Rapporto di Prova tipo 2.2 UNI EN10204
- Specifica Prodotto

WLL t	A min mm	A max mm		
1,0	90	180	1	081470210
2,0	90	190	1	081470220
3,0	85	280	1	081470230
5,0	85	280	1	081470250

8148

argano manuale a fune passante,
corpo in lega di alluminio
completo di leva di azionamento, fune e
gancio

Leggero e portatile, l'argano manuale a fune Robur è conforme alla norma EN 13157, è realizzato con materiali di alta qualità ed è idoneo per il sollevamento, il traino, il tensionamento e il fissaggio di carichi in tutte le direzioni tramite la leva di azionamento.

Generalmente utilizzato mediante un collegamento ad un punto di ancoraggio fisso, permette un'elevata precisione nel posizionamento del carico e garantisce un funzionamento sicuro in qualsiasi direzione: orizzontale, verticale o inclinato. Il suo design compatto e maneggevole ne agevola l'installazione e l'utilizzo.

L'argano manuale Robur consente l'utilizzo di funi senza limiti di lunghezza e, previa verifica della struttura di sostegno, è possibile aumentarne la portata, di un fattore di 2, 3, 4 o più, utilizzando rulli di rinvio e ganci con bozzello in accordo alla norma di riferimento.

CE

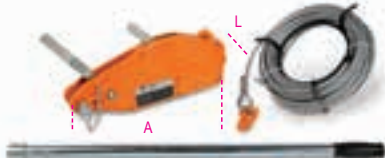

EN 13157

- Coefficiente di sicurezza 4:1

WLL t	L m	A mm		
0,8	20	426	1	081480008
1,6	20	545	1	081480016
3,2	20	660	1	081480032
0,8	30	426	1	081480108
1,6	30	545	1	081480116
3,2	30	660	1	081480132

Robur

8148F

funi a trefoli in acciaio zincato
avvolte su crociera
con gancio alta resistenza

CE



WLL t	L m	ØF		
0,8	20	8,3	1	081480520
1,6	20	11	1	081480521
3,2	20	16	1	081480523

0,8	30	8,3	1	081480530
1,6	30	11	1	081480531
3,2	30	16	1	081480533

8120

catene tipo Genovese
per collegamenti statici,
zincate



DATI TECNICI

- coefficiente di sicurezza: 4
- CERTIFICATI DISPONIBILI
- Specifica Prodotto
- Rapporto di Prova tipo 2.2 UNI EN10204

Ø mm	nr	WFL kg	m		
1,5	10	8	150	1	081200015
1,6	12	15	150	1	081200016
2,2	14	25	75	1	081200022
2,7	16	40	75	1	081200027
3,0	17	55	75	1	081200030
3,4	18	100	60	1	081200034
3,8	19	110	50	1	081200038
4,4	20	200	40	1	081200044
4,8	21	250	30	1	081200048
5,5	22	300	25	1	081200055
5,8	23	310	25	1	081200058
6,5	24	400	25	1	081200065
7,0	25	450	25	1	081200070
7,5	26	550	20	1	081200075
* 8,0	27	600	25	1	081200080
* 9,0	28	800	25	1	081200090
* 10,0	30	1000	20	1	081200100
* 12,0	32	1400	15	1	081200120

Attenzione: prodotto NON destinato al sollevamento
(*) confezionati in MATASSE

8120B

catene tipo Genovese
per collegamenti statici,
zincate



DATI TECNICI

- coefficiente di sicurezza: 4
- CERTIFICATI DISPONIBILI
- Specifica Prodotto
- Rapporto di Prova tipo 2.2 UNI EN10204

Ø mm	nr	WFL kg	m		
1,5	10	8	200	1	081200315
1,6	12	15	200	1	081200316
2,2	14	25	100	1	081200322
2,7	16	40	100	1	081200327
3,0	17	55	75	1	081200330
3,4	18	100	100	1	081200334
3,8	19	110	75	1	081200338
4,4	20	200	50	1	081200344
4,8	21	250	50	1	081200348
5,5	22	300	40	1	081200355
5,8	23	310	30	1	081200358
6,5	24	400	30	1	081200365
7,0	25	450	25	1	081200370
7,5	26	550	25	1	081200375
8,0	27	600	15	1	081200380
9,0	28	800	15	1	081200390
10,0	30	1000	10	1	081200400
12,0	32	1400	8	1	081200420

Attenzione: prodotto NON destinato al sollevamento

8120D

catene calibrate DIN766
zincatura elettrolitica
a richiesta può essere fornita nella lunghezza desiderata
(>30m)



Dati tecnici:

- Coefficiente di sicurezza: 4
- Certificati disponibili:
- Specifica Prodotto
- Rapporto di Prova tipo 2.2 UNI EN10204

Ø mm	P mm	WFL kg	m		
4	16	200	30	1	081200640
5	18,5	320	30	1	081200650
6	18,5	400	30	1	081200660
7	22	630	30	1	081200670
8	24	800	30	1	081200680
10	28	1250	30	1	081200700

catene calibrate DIN766,
zincatura A CALDO

Ø mm	P mm	WFL kg	m		
4	16	200	30	1	081200840
5	18,5	320	30	1	081200850
6	18,5	400	30	1	081200860
7	22	630	30	1	081200870
8	24	800	30	1	081200880
10	28	1250	30	1	081200900

Robur

8129

catena di delimitazione in metallo zincato e verniciata bianca e rossa

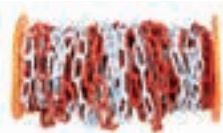

Ø mm	m	1
5	30	081290050

Attenzione: prodotto NON destinato al sollevamento o ancoraggio

8074

moschettoni zincati

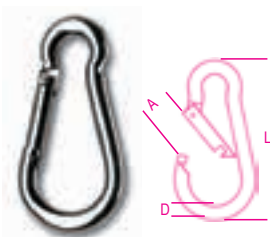

DIN 5299

DATI TECNICI

- coefficiente di sicurezza: 4
- CERTIFICATI DISPONIBILI
- Specifica Prodotto
- Rapporto di Prova tipo 2.2 UNI EN10204

DxL mm	A mm	WFL kg		
* 4x40	6	20	100	080740040
5x50	7	30	100	080740050
6x60	8	40	100	080740060
7x70	9	60	50	080740070
8x80	11	75	50	080740080
9x90	12	100	25	080740090
10x100	13	120	25	080740100
11x120	16	140	20	080740101
12x140	22	140	15	080740102
13x160	24	200	10	080740103
* 14x180	32	250	5	080740104

*Misure non contemplate nella norma

8074A

moschettoni con anello zincati



DIN 5299

DATI TECNICI

- coefficiente di sicurezza: 4
- CERTIFICATI DISPONIBILI
- Specifica Prodotto
- Rapporto di Prova tipo 2.2 UNI EN10204

øAxL mm	D mm	WFL kg		
5x50	7,4	30	50	080740405
6x60	8,7	40	50	080740406
8x80	10,5	75	25	080740408
10x100	13,3	120	10	080740410

8074G

moschettoni con ghiera zincati

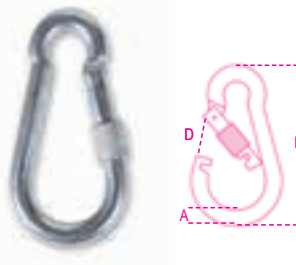

DATI TECNICI

- coefficiente di sicurezza: 4
- CERTIFICATI DISPONIBILI
- Specifica Prodotto
- Rapporto di Prova tipo 2.2 UNI EN10204

øAxL mm	D mm	WFL kg		
5x50	7,5	30	50	080740305
6x60	8,5	40	50	080740306
8x80	10,3	75	25	080740308
10x100	10,6	120	10	080740310

8080

maglie rapide di giunzione zincate

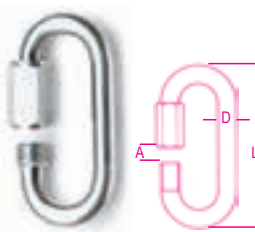

DATI TECNICI

- coefficiente di sicurezza: 4
- CERTIFICATI DISPONIBILI
- Specifica Prodotto
- Rapporto di Prova tipo 2.2 UNI EN10204

DxL mm	A mm	WFL kg		
3,5x36	5	20	100	080800003
4x40	6	30	100	080800004
5x49	6	50	100	080800005
6x57	8	60	100	080800006
7x66	8	100	50	080800007
8x74	11	140	50	080800008
9x80	11	160	25	080800009
10x89	11	220	25	080800010
12x105	15	300	20	080800012
14x125	16,5	400	3	080800014

8080FM

false maglie, zincate

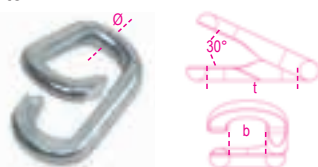

Dati tecnici:

- Coefficiente di sicurezza: 4
- Certificati disponibili:
- Specifica Prodotto
- Rapporto di Prova tipo 2.2 UNI EN10204

M	ød mm	b mm	t mm		
4	3,8	8,6	21,5	100	080800204
5	4,7	11,1	25,8	50	080800205
6	5,3	13,8	32,0	30	080800206
7	6,5	16,8	37,0	10	080800207
8	8,0	18,0	38,0	10	080800208

8082

Anelli acciaio zincato

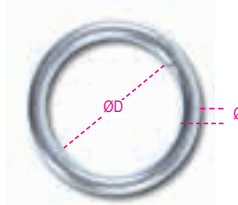

CERTIFICATI DISPONIBILI

- Rapporto di Prova tipo 2.2 UNI EN10204

Ø mm	ØD mm	WFL kg		
4	20	75	50	080820004
5	30	125	20	080820005
6	40	185	10	080820006
7	50	265	5	080820007
8	60	350	5	080820008

8083

ganci a "S" acciaio zincato

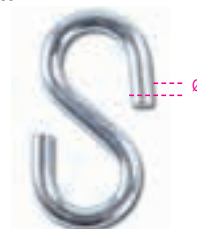

CERTIFICATI DISPONIBILI

- Rapporto di Prova tipo 2.2 UNI EN10204

Ø mm	L mm	WFL kg		
3	33	4	100	080830003
4	40	5	60	080830004
5	47	12	50	080830005
6	59	18	30	080830006
8	79	33	10	080830008

8114

tornichetti girevoli a un occhio allungato tipo Marche, zincati

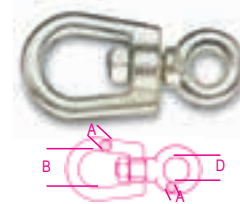

DATI TECNICI

- coefficiente di sicurezza: 4
- codice di identificazione
- ANALISI DI LABORATORIO
- test di trazione
- CERTIFICATI DISPONIBILI
- Specifica Prodotto
- Rapporto di Prova tipo 2.2 UNI EN10204
- Certificato di Controllo tipo 3.1 UNI EN10204

A mm	B mm	D mm	WFL kg		
8	30	16	250	10	081140008
10	38	18	300	10	081140010
12	42	20	650	5	081140012
14	48	22	820	5	081140014
16	57	24	1000	3	081140016
18	64	26	1600	3	081140018
20	72	30	2000	1	081140020
22	80	34	2500	1	081140022

8116

tornichetti girevoli
a due occhi allungati
tipo Sicilia, zincati

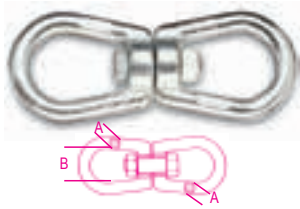

DATI TECNICI

- coefficiente di sicurezza: 4
- codice di identificazione

ANALISI DI LABORATORIO

- test di trazione

CERTIFICATI DISPONIBILI

- Specifica Prodotto
- Rapporto di Prova tipo 2.2 UNI EN10204
- Certificato di Controllo tipo 3.1 UNI EN10204

A mm	B mm	WFL kg		
6	23	140	10	081160006
8	30	250	10	081160008
10	38	300	5	081160010
12	42	650	5	081160012
14	48	820	3	081160014
16	57	1000	3	081160016
18	64	1600	1	081160018
20	72	2000	1	081160020
22	80	2500	1	081160022

8317SZ

morsetti simplex
zincati

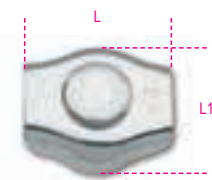

CERTIFICATI DISPONIBILI

- Rapporto di Prova tipo 2.2 UNI EN10204

Ø mm	L mm	L1 mm		
2	15	14	100	083170102
3	18	16	100	083170103
4	20	19	100	083170104
5	24	23	50	083170105
6	30	27	30	083170106
8	36	34	20	083170108
10	42	37	10	083170110

8317DZ

morsetti duplex
zincati

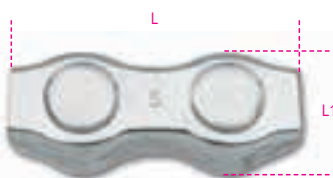

CERTIFICATI DISPONIBILI

- Rapporto di Prova tipo 2.2 UNI EN10204

Ø mm	L mm	L1 mm		
2	30	14	50	083170002
3	35	15	50	083170003
4	40	18	50	083170004
5	50	21	25	083170005
6	60	25	20	083170006
8	76	33	10	083170008
10	95	37	10	083170010

8381SL

collari per sostegno tubazioni
serie leggera
zincati

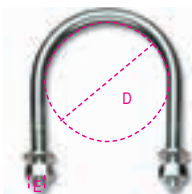

CERTIFICATI DISPONIBILI

- Specifica Prodotto
- Rapporto di Prova tipo 2.2 UNI EN10204

D mm	D gas "	E mm		
11	1/8"	M6	100	083810201
14	1/4"	M6	100	083810202
18	3/8"	M6	100	083810203
22	1/2"	M6	100	083810204
27	3/4"	M6	100	083810205
34	1"	M6	100	083810206
43	1 1/4"	M6	100	083810207
49	1 1/2"	M8	50	083810208
61	2"	M8	50	083810209
77	2 1/2"	M8	25	083810210
89	3"	M8	25	083810211
102	3 1/2"	M8	25	083810212
115	4"	M8	25	083810213
140	5"	M8	25	083810215
168	6"	M10	25	083810218
220	8"	M10	10	083810220

8381SP

collari per sostegno tubazioni
serie pesante
zincati

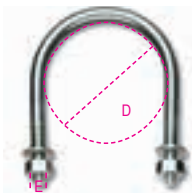

CERTIFICATI DISPONIBILI

- Specifica Prodotto
- Rapporto di Prova tipo 2.2 UNI EN10204

D mm	D gas "	E mm		
22	1/2"	M8	100	083810301
27	3/4"	M8	100	083810302
34	1"	M8	100	083810303
43	1 1/4"	M8	100	083810304
49	1 1/2"	M10	25	083810305
61	2"	M10	25	083810306
77	2 1/2"	M10	25	083810307
89	3"	M10	25	083810308
102	3 1/2"	M12	25	083810309
115	4"	M12	15	083810310
140	5"	M12	15	083810312
168	6"	M16	15	083810315
220	8"	M16	10	083810320
274	10"	M16	1	083810374
274	10"	M20	1	083810375
324	12"	M20	1	083810386
408	16"	M24	1	083810508

8383C

collari quadrati
zincati a caldo
Dadi flangiati

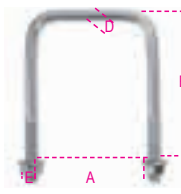

CERTIFICATI DISPONIBILI

- Specifica Prodotto
- Rapporto di Prova tipo 2.2 UNI EN10204

A mm	E mm	B mm	D mm		
70	M10	110	8,55	130	083830070
80	M10	120	8,55	110	083830080
90	M10	130	8,55	100	083830090
100	M10	155	8,55	90	083830100
120	M10	175	8,55	70	083830120

8383P

piastre per collari quadrati
zincate a caldo



CERTIFICATI DISPONIBILI

- Specifica Prodotto
- Rapporto di Prova tipo 2.2 UNI EN10204

	L mm		
8383P 150	150	150	083830214
8383C/70-80			
/90-100			
8383P 170	170	120	083830217
8383C/100-120			

8515Z

tirafili per agricoltura
zincati



D mm	H mm	L mm		
20	25	93	50	085150002
24,5	30	100	50	085150003

8515V

tendifili per agricoltura
verniciati



D mm	H mm	L mm		
20	25	93	50	085150102
24,5	30	100	50	085150103



8515CH

chiavette per tendifili zincate



L mm	OA mm	OB mm		
90	8	7,5	20	085150901

8531

grilli tipo pesca zincati a caldo



CERTIFICATI DISPONIBILI
• Rapporto di Prova tipo 2.2 UNI EN10204

Ø mm	D mm	WFL kg		
20	18	1600	1	085310018
22	20	2500	1	085310020

8532

grilli tipo pesca con perno quadro, verniciati neri



CERTIFICATI DISPONIBILI
• Rapporto di Prova tipo 2.2 UNI EN10204

Ø mm	D mm	WFL kg		
20	20	1600	1	085320020
22	22	2500	1	085320022

8535

uncini tipo pesca zincati

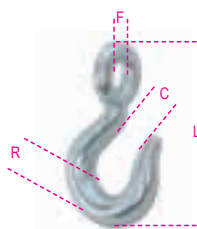

CERTIFICATI DISPONIBILI
• Rapporto di Prova tipo 2.2 UNI EN10204

R mm	C mm	F mm	L mm		
26	27,5	34	156	1	085350006
30	36,5	40	185	1	085350007

8130

catene antifurto in acciaio legato cementate e bonificate zincate



CERTIFICATI DISPONIBILI
• Rapporto di Prova tipo 2.2 UNI EN10204

Ø mm	L mm		
6	800	1	081300068
8	1000	1	081300081
8	1200	1	081300082
10	1500	1	081300105

8130A

catene antifurto con anello acciaio legato, cementate e bonificate zincate



Ø mm	L mm		
10	900	1	081300209

8131Z

catene antifurto con lucchetto



Ø mm	L mm	8139Z Ø mm		
6	800	8	1	081310060

8131DL

bloccadisco con catena antifurto 8130A



Ø mm	L mm		
10	900	1	081310209

8139DL

lucchetti bloccadisco moto, acciaio temprato, PVC antiurto confezionato in blister

• fornito con nr.3 chiavi, cavo segnalatore, astuccio
• adatto a catene 10mm



Ø mm	L mm	H mm		
14	108	56	1	081390214

8139Z

lucchetti per catene antifurto, corpo in lega di zinco confezionato in blister

• fornito con nr.3 chiavi mappate
• adatto a catene 6, 8, 10mm

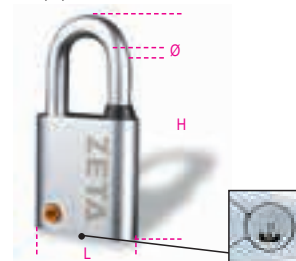

CERTIFICATI DISPONIBILI
• Rapporto di Prova tipo 2.2 UNI EN10204

Ø mm	L mm	H mm		
8	45	90	1	081390008

8139ZCH

n.3 chiavi di ricambio neutre per lucchetti 8139Z



8139ZCH	1	081390909
---------	---	-----------

adatte per lucchetti Ø8 e Ø10

8050 D1÷D45

kit sicure e ricambi per ganci di sollevamento



8050D1	1	080500945
8064S-8065SC/800		
8055S/1250		
8050D2	1	080500946
8064S-8065SC/1000-8062/1500-		
8055S/1600		
8050D3	1	080500947
8064S-8065SC/1600-2000		
8055S/2500-3200		
8050D4	1	080500948
8064S-8065SC/3200		
8055S/5400		
8050D5	1	080500949
8064S-8065SC/5000		
8055S/8000		

8050D6	1	080500950
8064S/7500		
8055S/11500		
8050D11	1	080500955
8062/2000		
8050D12	1	080500956
8062/3000		
8050D13	1	080500957
8062/5000		
8050D22	1	080500966
8064S/10000		
8055S/16000		
8050D23	1	080500967
8055S/22000		
8050D24	1	080500969
8051S/250		
8050D25	1	080500970
8051S/500		
8050D30	1	080500975
8061F/8000		
8050D32	1	080500977
8060/8000		
8050D33	1	080500978
8052/800		
8050D34	1	080500979
8052/1120		
8050D35	1	080500980
8052/2000		
8050D36	1	080500981
8052/3150		
8050D37	1	080500982
8052/4000		
8050D38	1	080500983
8060R/1120		
8050D53	1	080500994
8060R/1500		
8050D39	1	080500984
8060R/2000		
8050D40	1	080500985
8060R/3150		
8050D41	1	080500986
8060R/5300		
8050D42	1	080500987
8063/800		
8050D43	1	080500988
8063/1120		
8050D44	1	080500989
8063/2000		
8050D45	1	080500990
8063/3150		



8050D46	1	080500991
8061R/1120		
8050D47	1	080500992
8061R/2000		
8050D48	1	080500993
8061R/3150		
8050D54	1	080500995
8061R/5300		



8050 D49	1	080500849
8057R - 8058R - 8063SL /1120		
8050 D50	1	080500850
8057R - 8058R - 8063SL /2000		
8050 D51	1	080500851
8057R - 8058R - 8063SL /3150		
8050 D52	1	080500852
8057R - 8058R - 8063SL /5300		

8058R/PS

kit perni e spine per ganci 8058R-8061R



	Ø mm		
8058R/PS	6	1	080580512
8058R/PS	7-8	1	080580520
8058R/PS	10	1	080580532
8058R/PS	13	1	080580553

8060R/PS

kit perni e spine per ganci 8060R



	Ø mm		
8060R/PS	6	1	080600511
8060R/PS	7	1	080600515
8060R/PS	8	1	080600520
8060R/PS	10	1	080600532
8060R/PS	13	1	080600553

8135/KLA1

kit leve di azionamento per pinze di sollevamento 8135



8135	t		
0,75	1	081350605	
1,00	1	081350610	
2,00	1	081350615	
3,00	1	081350620	
5,00	1	081350625	

La responsabilità della riparazione è a carico del soggetto che la effettua.

8135/KCA

kit camme per pinze di sollevamento 8135



8135	t		
0,75	1	081350630	
1,00	1	081350635	
2,00	1	081350640	
3,00	1	081350645	
5,00	1	081350650	

La responsabilità della riparazione è a carico del soggetto che la effettua.

8135/KMO

kit molle per pinze di sollevamento 8135



8135	t		
0,75	1	081350655	
1,00	1	081350660	
2,00	1	081350665	
3,00	1	081350670	
5,00	1	081350675	

La responsabilità della riparazione è a carico del soggetto che la effettua.

8135/KGF

kit ganasce fisse per pinze di sollevamento 8135



8135	t		
0,75	1	081350705	
1,00	1	081350710	
2,00	1	081350720	
3,00	1	081350730	
5,00	1	081350750	

La responsabilità della riparazione è a carico del soggetto che la effettua.

8135/KGM

kit ganasce mobili per pinze di sollevamento 8135



8135	t		
0,75	1	081350805	
1,00	1	081350810	
2,00	1	081350820	
3,00	1	081350830	
5,00	1	081350850	

La responsabilità della riparazione è a carico del soggetto che la effettua.

8143/RKL

kit linguette gancio superiore e inferiore per paranchi manuali a catena 8143



8143	WLL t		
0,5	1	081430500	
1,0	1	081430501	
2,0	1	081430502	
3,0	1	081430503	
5,0	1	081430504	

8143/RPC

kit perni blocco catena su gancio per paranchi manuali 8143



8143	WLL t		
0,5	1	081430510	
1,0	1	081430511	
2,0	1	081430512	
3,0	1	081430513	
5,0	1	081430514	

Robur

8143/RPF

kit perni fine corsa
per paranchi a catena 8143



8143 WLL t		
0,5	1	081430520
1,0	1	081430521
2,0	1	081430522
3,0	1	081430523
5,0	1	081430524

8143/RKCI

kit corpi ganci inferiori
per paranchi a catena 8143



8143 WLL t		
0,5	1	081430560
1,0	1	081430561
2,0	1	081430562
3,0	1	081430563
5,0	1	081430564

8146/RK

kit sicure, perni, finecorsa
per paranchi manuali a LEVA 8146C-8146



8146C-8146 WLL t		
0,25	1	081460902

8146/RKL

kit linguette gancio superiore e inferiore
per paranchi manuali a leva 8146



8146 WLL t		
0,75	1	081460500
1,5	1	081460501
3,0	1	081460502
6,0	1	081460503

8146/RPC

kit perni blocco catena su gancio
per paranchi manuali a leva 8146



8146 WLL t		
0,75	1	081460510
1,5	1	081460511
3,0	1	081460512
6,0	1	081460513

8146/RKFC

kit finecorsa
per paranchi manuali a leva 8146



8146 WLL t		
0,75	1	081460520
1,5	1	081460521
3,0	1	081460522
6,0	1	081460523

8146/RKCI

kit corpi ganci inferiori
per paranchi manuali a leva 8146



8146 WLL t		
0,75	1	081460560
1,5	1	081460561
3,0	1	081460562
6,0	1	081460563

8148/RA

crociera per fune argani manuali 8148



8148 t		
0,8	1	081480900
1,6	1	081480901
3,2	1	081480902

8148/RKS

set 3 spine di sicurezza
da sovraccarico
per argani manuali 8148



8148 t		
0,8	1	081480903
1,6 - 3,2	1	081480904

8148/RKCM

set 2 cappucci manico
per argani manuali 8148



8148/RKCM		
	1	081480905

8148/RKCL

set 2 cappucci leva
per argani manuali 8148



8148RKCL		
	1	081480906

8148/RP

perni di ancoraggio
per argani manuali 8148



8148 t		
0,8	1	081480907
1,6	1	081480908
3,2	1	081480909

8148/RKG

set 2 guaine di protezione
per argani manuali 8148



8148 t		
0,8	1	081480910
1,6	1	081480911
3,2	1	081480912

8149

catene per paranchi,
acciaio legato ad alta resistenza
verniciata nera

CE

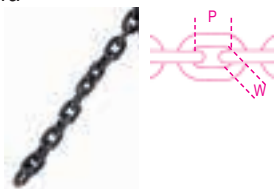

EN 818-7

DATI TECNICI

- coefficiente di sicurezza: 4
- trattamento termico: bonifica
- codice lotto di fabbricazione

ANALISI DI LABORATORIO

- analisi chimica
- analisi metallografica
- test di trazione

CERTIFICATI DISPONIBILI

- Specifica Prodotto
- Rapporto di Prova tipo 2.2 EN10204
- Certificato di Collaudo tipo 3.1 EN10204
- Dichiarazione di Conformità CE

Ø mm	WLL Kg	P mm	W min		
4	500	12	4,8	1	081490012
5	800	15	6,0	1	081490015
6	1100	18	7,2	1	081490018
6,3	1200	19	7,6	1	081490019
8	2000	24	9,6	1	081490024
10	3200	30	12	1	081490030

* ATTENZIONE: il prodotto viene consegnato in un unico spezzone di catena, salvo diversa indicazione in fase d'ordine!

8149CM

catene a mano per paranchi 8143



Ø mm	B mm	t mm		
4,8	8,2	22,2	1	081490901

*Viene consegnato un unico spezzone di catena aperto che deve essere chiuso dall'utilizzatore alla lunghezza desiderata (salvo diversa indicazione in fase d'ordine)

8149CM/RA

anello saldato di ricambio
catena a mano per paranchi 8143



L m	Ø mm	B mm		
3	4,8	8,2	1	081490903
6	4,8	8,2	1	081490906

*Anello chiuso saldato. Leggere attentamente il manuale per la sostituzione della catena.



Forze di rottura (BF)
indicata sulle specifiche
tecniche online
WWW.ROBURITALY.COM

8205

tenditore a due occhi
inox AISI 316

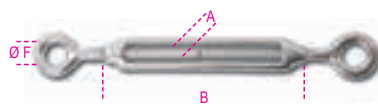

ANALISI DI LABORATORIO

- analisi chimica
- test di trazione

CERTIFICATI DISPONIBILI

- Specifica Prodotto
- Rapporto di Prova tipo 2.2 UNI EN10204

A mm	B mm	Ø F mm	WFL kg		
M4	62	8	75	10	082050204
M5	72	11	115	10	082050205
M6	92	12	160	8	082050206
M8	122	14	300	8	082050208
M10	150	16	470	4	082050210
M12	201	18	690	1	082050212
M14	225	22	940	1	082050214
M16	244	26	1290	1	082050216
M20	295	29	2130	1	082050220
M24	350	33	3000	1	082050224

8206

tenditore ad occhio e gancio
inox AISI 316

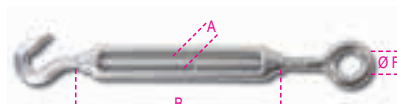

ANALISI DI LABORATORIO

- analisi chimica
- test di trazione

CERTIFICATI DISPONIBILI

- Specifica Prodotto
- Rapporto di Prova tipo 2.2 UNI EN10204

A mm	B mm	Ø F mm	WFL kg		
M5	72	11	25	10	082060205
M6	92	12	45	5	082060206
M8	122	14	95	5	082060208
M10	150	16	140	1	082060210
M12	201	18	300	1	082060212
M14	225	22	420	1	082060214
M16	244	26	570	1	082060216
M20	295	29	875	1	082060220

8207

tenditore a due ganci
inox AISI 316

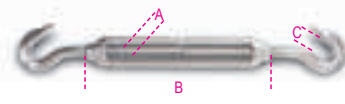

ANALISI DI LABORATORIO

- analisi chimica
- test di trazione

CERTIFICATI DISPONIBILI

- Specifica Prodotto
- Rapporto di Prova tipo 2.2 UNI EN10204

A mm	B mm	C mm	WFL kg		
M5	72	9	25	10	082070205
M6	92	9	45	5	082070206
M8	122	10	95	5	082070208
M10	150	12	140	1	082070210
M12	201	14	300	1	082070212
M14	225	15	420	1	082070214
M16	244	16	570	1	082070216
M20	295	19	875	1	082070220

8209

tenditore a due forcelle
inox AISI 316

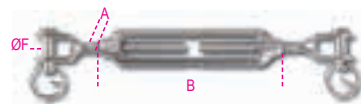

ANALISI DI LABORATORIO

- analisi chimica
- test di trazione

CERTIFICATI DISPONIBILI

- Specifica Prodotto
- Rapporto di Prova tipo 2.2 UNI EN10204

A mm	B mm	Ø F mm	WFL kg		
M5	72	5	115	5	082090205
M6	92	6	160	5	082090206
M8	122	8	300	5	082090208
M10	150	10	470	1	082090210
M12	201	12	690	1	082090212
M14	225	14	940	1	082090214
M16	244	16	1290	1	082090216
M20	295	20	2130	1	082090220
M24	350	24	3060	1	082090224

8210

tenditore a due forcelle con canaula a tubo
inox AISI 316



ANALISI DI LABORATORIO

- analisi chimica
- test di trazione

CERTIFICATI DISPONIBILI

- Specifica Prodotto
- Rapporto di Prova tipo 2.2 UNI EN10204

A mm	B mm	Ø F mm	WFL kg		
M5	81	5	115	3	082100205
M6	92	6	160	3	082100206
M8	112	8	300	1	082100208
M10	121	10	470	1	082100210
M12	150	12	690	1	082100212
M14	169	14	940	1	082100214
M16	190	16	1290	1	082100216
M20	220	20	2130	1	082100220

8210FTP

tenditori a forcella e terminale a pressare
canaula a tubo
inox Aisi 316

Acciaio con Nichel, Cromo e Molibdeno per una maggiore
resistenza alla corrosione.



ANALISI DI LABORATORIO

- analisi chimica
- test di trazione

CERTIFICATI DISPONIBILI

- Specifica Prodotto
- Rapporto di Prova tipo 2.2 UNI EN10204

Ø	A	ØD	WFL		
mm	mm	mm	kg		
M5	159	2,70	150	2	082100605
M6	179	3,30	250	2	082100606
M8	216	4,30	350	1	082100608
M10	241	5,30	550	1	082100610
M12	300	6,30	1000	1	082100612
M14	345	7,30	1350	1	082100614
M16	383	8,30	1625	1	082100616
M20	484	10,50	2125	1	082100620

8201T

canaule a tubo
inox AISI 316



ANALISI DI LABORATORIO

- analisi chimica
- test di trazione

CERTIFICATI DISPONIBILI

- Specifica Prodotto
- Rapporto di Prova tipo 2.2 UNI EN10204

Ø	Ø	WFL	L		
mm	"	kg	mm		
M6	1/4	160	95	5	082010406
M8	5/16	300	105	5	082010408
M10	3/8	470	125	3	082010410
M12	1/2	690	150	3	082010412
M14	9/16	940	165	1	082010414
M16	5/8	1290	190	1	082010416
M20	3/4	2130	210	1	082010420

8210F

forcelle per tenditori
inox AISI 316

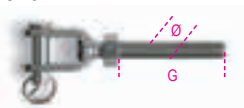

Analisi di laboratorio:

- Analisi chimica
- Test di trazione

Certificati disponibili:

- Specifica Prodotto
- Rapporto di Prova tipo 2.2 UNI EN10204

Ø	≈	G	WFL		
mm	"	mm	kg		
M5	3/16	38,5	115	4	082100305
M6	1/4	49	160	4	082100306
M8	5/16	56	300	4	082100308
M10	3/8	61	470	2	082100310
M12	1/2	81	690	2	082100312
M14	9/16	93	940	2	082100314

filetto sinistrorso

Ø	≈	G	WFL		
mm	"	mm	kg		
M5	3/16	38,5	115	4	082100405
M6	1/4	49	160	4	082100406
M8	5/16	56	300	4	082100408
M10	3/8	61	470	2	082100410
M12	1/2	81	690	2	082100412
M14	9/16	93	940	2	082100414

8248

tiranti ad occhio
INOX 316L
destri



UNI 6058

ANALISI DI LABORATORIO

- analisi chimica
- test di trazione

CERTIFICATI DISPONIBILI

- Specifica Prodotto
- Rapporto di Prova tipo 2.2 UNI EN10204

ØxL	F		
mm	mm		
8x120	6	1	082480008
10x80	8	1	082480010
10x130	8	1	082480012
12x95	10	1	082480016
12x125	10	1	082480018

8249

viti ad occhio per tasselli
inox AISI 316



ANALISI DI LABORATORIO

- analisi chimica
- test di trazione

CERTIFICATI DISPONIBILI

- Specifica Prodotto
- Rapporto di Prova tipo 2.2 UNI EN10204

A	ØB	D	WFL		
mm	mm	mm	kg		
M5	11	50	100	10	082490205
M6	13	55	160	10	082490206
M8	17	60	300	5	082490208
M10	21	80	470	5	082490210
M12	25	120	690	2	082490212

8249G

ganci per tasselli
inox AISI 316



ANALISI DI LABORATORIO

- analisi chimica
- test di trazione

CERTIFICATI DISPONIBILI

- Specifica Prodotto
- Rapporto di Prova tipo 2.2 UNI EN10204

A	E	ØF	WFL		
mm	mm	mm	kg		
M5	39	9	25	5	082490305
M6	43	10,5	45	5	082490306
M8	57	14,5	95	3	082490308

8216

morsetti
inox AISI 316

CE

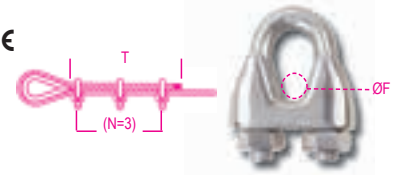

ANALISI DI LABORATORIO

- analisi chimica

- test coppia di serraggio

CERTIFICATI DISPONIBILI

- Specifica Prodotto
- Rapporto di Prova tipo 2.2 UNI EN10204
- Certificato di Conformità CE

Ø F	"	T	N		
mm					
2	5/64	80	3	20	082160202
3	1/8	80	3	20	082160203
4	5/32	80	3	20	082160204
5	3/16	110	3	20	082160205
6	1/4	120	5	10	082160206
8	5/16	210	5	10	082160208
10	3/8	240	5	8	082160210
12-13	1/2	300	5	5	082160213
16	5/8	335	5	5	082160216
20	3/4	540	5	5	082160220
22	7/8	595	7	3	082160222

confezioni appendibili



Ø F				
mm				
2	4	1	082169402	
3	4	1	082169403	
4	4	1	082169404	
5	2	1	082169405	
6	2	1	082169406	
8	2	1	082169408	
10	2	1	082169410	

8220

radance, tipo pesante
inox AISI 316

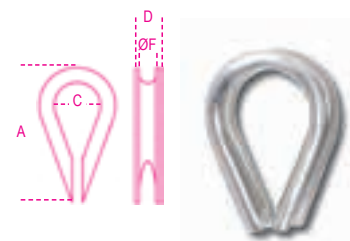

ANALISI DI LABORATORIO

- analisi chimica

CERTIFICATI DISPONIBILI

- Specifica Prodotto
- Rapporto di Prova tipo 2.2 UNI EN10204

Ø F	D	A	C		
mm	mm	mm	mm		
2	4,5	21	7,5	15	082200202
3	6	24	10	15	082200203
4	6,6	28	11	10	082200204
5	8,5	30	13	10	082200205
6	10	37	15	10	082200206
8	12,5	51	23	5	082200208
10	14,6	56	27	5	082200210
12	18	68	32	5	082200212
14	19	69	34	5	082200214
16	22	83	37	5	082200216
18	23	81	38	1	082200218
20	27,8	105	45	1	082200220
22	29,6	112	45	1	082200222

8225
grilli dritti
inox AISI 316



ANALISI DI LABORATORIO

- analisi chimica
 - test di trazione
- CERTIFICATI DISPONIBILI**
- Specifica Prodotto
 - Rapporto di Prova tipo 2.2 UNI EN10204

ø D mm	"	A mm	WFL kg		
4	5/32	8	50	20	082250204
5	3/16	11	70	20	082250205
6	1/4	13	100	10	082250206
8	5/16	17	250	10	082250208
10	3/8	21	400	8	082250210
12	1/2	25	600	3	082250212
16	5/8	32	1000	1	082250216
19	3/4	38	1600	1	082250219
22	7/8	43	2000	1	082250222
25	1	46	2800	1	082250225

8227
grilli dritti lunghi
inox AISI 316



ANALISI DI LABORATORIO

- analisi chimica
 - test di trazione
- CERTIFICATI DISPONIBILI**
- Specifica Prodotto
 - Rapporto di Prova tipo 2.2 UNI EN10204

ø D mm	"	A mm	WFL kg		
4	5/32	8	50	10	082270204
5	3/16	10	70	10	082270205
6	1/4	13,5	100	5	082270206
8	5/16	17	250	5	082270208
10	3/8	21	400	2	082270210
12	1/2	25	600	1	082270212

8228
grilli a lira
inox AISI 316

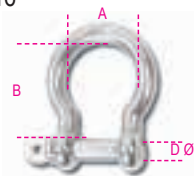

ANALISI DI LABORATORIO

- analisi chimica
 - test di trazione
- CERTIFICATI DISPONIBILI**
- Specifica Prodotto
 - Rapporto di Prova tipo 2.2 UNI EN10204

ø D mm	A mm	B mm	WFL kg		
4	13	20	60	10	082280204
5	17	23	80	10	082280205
6	20	27	100	10	082280206
8	28	36	200	5	082280208
10	36	44	300	5	082280210
12	41	53	500	5	082280212
16	54	74	800	1	082280216
19	66	86	1100	1	082280219

8240F
golfari per sollevamento inox A4
maschio, FORGIATI

CE



DATI TECNICI

- coefficiente di sicurezza: 6
 - codice lotto di fabbricazione
- ANALISI DI LABORATORIO**
- analisi chimica
 - analisi metallografica
 - test di trazione
- CERTIFICATI DISPONIBILI**
- Specifica Prodotto
 - Rapporto di Prova tipo 2.2 UNI EN10204
 - Certificato di Controllo tipo 3.1 UNI EN10204
 - Dichiarazione di Conformità CE

ø mm	WLL mm	WLL kg		
M6	1,0	120	4	082400406
* M8	1,25	200	4	082400408
* M10	1,5	400	4	082400410
* M12	1,75	600	4	082400412
* M14	2	1000	2	082400414
* M16	2	1200	2	082400416
* M20	2,5	2000	2	082400420
* M24	3	2700	2	082400424
* M30	3,5	4000	1	082400430

(* Caratteristiche dimensionali DIN 580:2010
WLL incrementato in base a Fascicolo Tecnico Robur
(garantito per accoppiamenti inox-inox)

8240
golfari maschio,
inox AISI 316



ANALISI DI LABORATORIO

- analisi chimica
 - test di trazione
- CERTIFICATI DISPONIBILI**
- Specifica Prodotto
 - Rapporto di Prova tipo 2.2 UNI EN10204

A mm	B mm	ø C mm	WFL kg		
M6	41	15	90	10	082400206
M8	50	20	140	10	082400208
M10	62	25	230	5	082400210
M12	74	30	340	5	082400212

8242F
golfari per sollevamento inox A4
femmina, FORGIATI

CE



DATI TECNICI

- coefficiente di sicurezza: 6
 - codice lotto di fabbricazione
- ANALISI DI LABORATORIO**
- analisi chimica
 - analisi metallografica
 - test di trazione
- CERTIFICATI DISPONIBILI**
- Specifica Prodotto
 - Rapporto di Prova tipo 2.2 UNI EN10204
 - Certificato di Controllo tipo 3.1 UNI EN10204
 - Dichiarazione di Conformità CE

ø mm	WLL mm	WLL kg		
M6	1,0	120	4	082420406
* M8	1,25	200	4	082420408
* M10	1,5	400	4	082420410
* M12	1,75	600	4	082420412
* M14	2	1000	2	082420414
* M16	2	1200	2	082420416
* M20	2,5	2000	2	082420420
* M24	3	2700	2	082420424
* M30	3,5	4000	1	082420430

(* Caratteristiche dimensionali DIN 582:2010
WLL incrementato in base a Fascicolo Tecnico Robur
(garantito per accoppiamenti inox-inox)



8242

golfari femmina,
inox AISI 316



A	B	ø C	WFL		
mm	mm	mm	kg		
M6	27	15	90	10	082420206
M8	36	20	140	10	082420208
M10	45	25	230	5	082420210
M12	55	30	340	5	082420212

8274

moschettoni
inox AISI 316

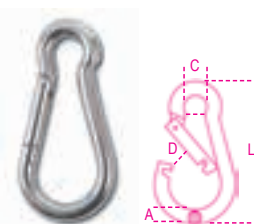

ANALISI DI LABORATORIO

- analisi chimica
- test di trazione

CERTIFICATI DISPONIBILI

- Specifica Prodotto
- Rapporto di Prova tipo 2.2 UNI EN10204

ø A x L	ø C	D	WFL		
mm	mm	mm	kg		
4,5x40	6,5	6	20	20	082740204
5x50	7	6,5	30	20	082740205
6x60	8,5	7,5	40	10	082740206
7x70	10	9	60	10	082740207
8x80	12	10	75	10	082740208
9x90	12,5	10,5	100	10	082740209
10x100	15	13	120	8	082740210
11x120	19	18	140	1	082740211
12x140	22	21	140	1	082740212
13x160	22	26	200	1	082740213

8274A

moschettoni con anello
inox AISI 316

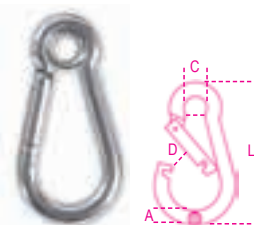

ANALISI DI LABORATORIO

- analisi chimica
- test di trazione

CERTIFICATI DISPONIBILI

- Specifica Prodotto
- Rapporto di Prova tipo 2.2 UNI EN10204

ø A x L	ø C	D	WFL		
mm	mm	mm	kg		
5x50	6,5	7	30	10	082740405
6x60	7,5	7,5	40	5	082740406
8x80	9,5	10	75	5	082740408

8274G

moschettoni con ghiera
inox AISI 316

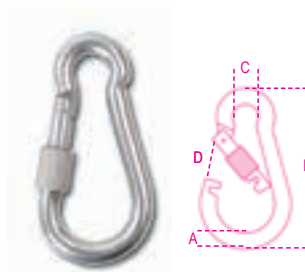

ANALISI DI LABORATORIO

- analisi chimica
- test di trazione

CERTIFICATI DISPONIBILI

- Specifica Prodotto
- Rapporto di Prova tipo 2.2 UNI EN10204

ø A x L	ø C	D	WFL		
mm	mm	mm	kg		
6x60	8,5	6,5	40	5	082740306
8x80	12	8,5	75	5	082740308
10x100	15	12	120	3	082740310

8276

moschettoni asimmetrici
inox AISI 316

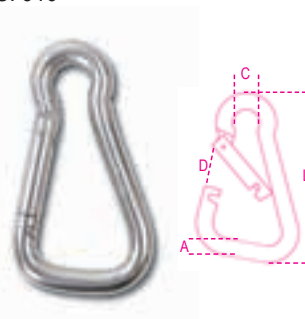

ANALISI DI LABORATORIO

- analisi chimica
- test di trazione

CERTIFICATI DISPONIBILI

- Specifica Prodotto
- Rapporto di Prova tipo 2.2 UNI EN10204

ø A x L	ø C	D	WFL		
mm	mm	mm	kg		
6x60	8,5	10	40	5	082760206
8x80	12	14	75	5	082760208
10x100	15	18	120	3	082760210

Robur

8276G

moschettoni asimmetrici con ghiera
inox AISI 316



ANALISI DI LABORATORIO

- analisi chimica
- test di trazione

CERTIFICATI DISPONIBILI

- Specifica Prodotto
- Rapporto di Prova tipo 2.2 UNI EN10204

ø A x L	ø C	D	WFL		
mm	mm	mm	kg		
6x60	8,5	9	40	3	082760306
8x80	12	12,5	75	3	082760308
10x100	15	16	120	3	082760310

8278

moschettoni trapezoidali
inox AISI 316

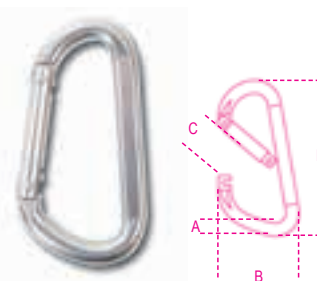

ANALISI DI LABORATORIO

- analisi chimica
- test di trazione

CERTIFICATI DISPONIBILI

- Specifica Prodotto
- Rapporto di Prova tipo 2.2 UNI EN10204

ø A x L	B	C	WFL		
mm	mm	mm	kg		
8x80	45	14	75	3	082780208
10x100	55	16	120	3	082780210

Robur

8280

maglie di giunzione
inox AISI 316

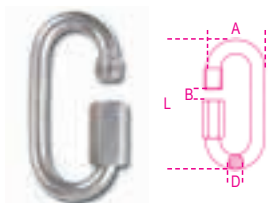

ANALISI DI LABORATORIO

- analisi chimica
 - test di trazione
- CERTIFICATI DISPONIBILI**
- Specifica Prodotto
 - Rapporto di Prova tipo 2.2 UNI EN10204

ø D x L	A	B	WFL		
mm	mm	mm	mm	kg	
3,5x35	17	5	20	10	082800203
4x40	19	6	30	10	082800204
5x50	23	7	50	5	082800205
6x60	26	8	60	5	082800206
7x70	30	9	100	5	082800207
8x80	33	10	140	2	082800208
10x90	40	12	220	2	082800210
12x100	47	14	300	1	082800212

8250

moschettoni a gancio con sicura
inox AISI 316



ANALISI DI LABORATORIO

- analisi chimica
 - test di trazione
- CERTIFICATI DISPONIBILI**
- Specifica Prodotto
 - Rapporto di Prova tipo 2.2 UNI EN10204

L	A	ø B	WFL		
mm	mm	mm	kg		
50	25	8	40	5	082500205
70	31	12,5	90	5	082500207
100	47	20	190	2	082500210

8264

moschettoni a girello
inox AISI 316

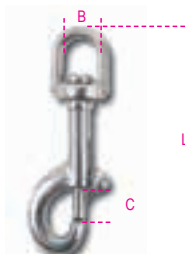

ANALISI DI LABORATORIO

- analisi chimica
 - test di trazione
- CERTIFICATI DISPONIBILI**
- Specifica Prodotto
 - Rapporto di Prova tipo 2.2 UNI EN10204

B	L	C	WFL		
mm	mm	mm	kg		
12	88	12	60	5	082640212
16	90	12	60	5	082640216
19	93	12	60	2	082640219

8267

moschettoni a gancio con girello e sicura
inox AISI 316

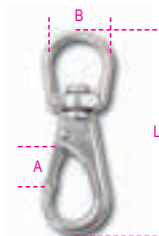

ANALISI DI LABORATORIO

- analisi chimica
 - test di trazione
- CERTIFICATI DISPONIBILI**
- Specifica Prodotto
 - Rapporto di Prova tipo 2.2 UNI EN10204

A	L	B	WFL		
mm	mm	mm	kg		
10	87	21	30	5	082670210
12	118	22	70	2	082670213

8272

girelli a due occhi
inox AISI 316

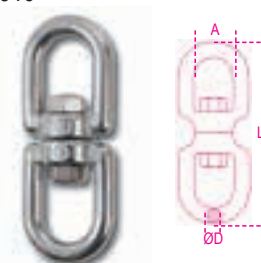

ANALISI DI LABORATORIO

- analisi chimica
 - test di trazione
- CERTIFICATI DISPONIBILI**
- Specifica Prodotto
 - Rapporto di Prova tipo 2.2 UNI EN10204

ø D	A	L	WFL		
mm	mm	mm	kg		
4	11	50	90	5	082720204
5	13	60	115	5	082720205
6	15	66	140	5	082720206
8	19	90	250	3	082720208
10	23	112	300	1	082720210
13	33	148	650	1	082720213
16	38	184	1000	1	082720216
19	40	223	1600	1	082720219

8273

girelli a sgancio rapido
con occhio girevole
inox AISI 316

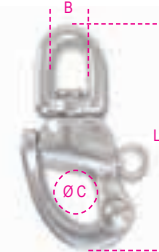

ANALISI DI LABORATORIO

- analisi chimica
 - test di trazione
- CERTIFICATI DISPONIBILI**
- Specifica Prodotto
 - Rapporto di Prova tipo 2.2 UNI EN10204

ø C x L	B	WFL	BF		
mm	mm	mm	kg		
12x70	12	230	1100	1	082730012
16x85	14,50	440	2000	1	082730016
22x120	20	700	3500	1	082730022

8282S

ganci a "S" simmetrici
inox AISI 316

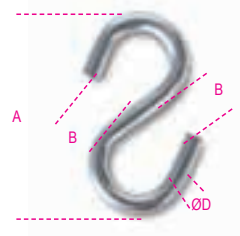

ANALISI DI LABORATORIO

- analisi chimica
 - test di trazione
- CERTIFICATI DISPONIBILI**
- Specifica Prodotto
 - Rapporto di Prova tipo 2.2 UNI EN10204

ø D	B	A	WFL		
mm	mm	mm	kg		
3	5,5	34	4	40	082820303
4	7,0	40	5	30	082820304
5	9,0	46	12	20	082820305
6	10	54	18	15	082820306

8284

terminali gancio a pellicano
inox AISI 316



ANALISI DI LABORATORIO

- analisi chimica
 - test di trazione
- CERTIFICATI DISPONIBILI**
- Specifica Prodotto
 - Rapporto di Prova tipo 2.2 UNI EN10204

ø C	B	L	WFL		
mm	mm	mm	kg		
6	11	73	200	3	082840006
8	14	98	300	3	082840008
10	23	143	450	1	082840010

8285

terminali a forcella
inox AISI 316

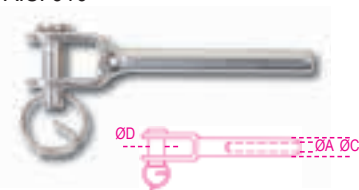

ANALISI DI LABORATORIO

- analisi chimica
 - test di trazione
- CERTIFICATI DISPONIBILI**
- Specifica Prodotto
 - Rapporto di Prova tipo 2.2 UNI EN10204

ø A	ø C	ø D	WFL		
M	mm	mm	kg		
3	6,3	6	180	5	082850203
4	7,5	8	200	3	082850204
5	9	10	330	2	082850205
6	12,5	12	720	2	082850206
7	12,5	12	850	2	082850207
8	15,5	16	1120	2	082850208
10	18	16	1300	2	082850210
12	20	19	2400	2	082850212

8286

terminali ad occhio
inox AISI 316



ANALISI DI LABORATORIO

- analisi chimica
 - test di trazione
- CERTIFICATI DISPONIBILI
- Specifica Prodotto
 - Rapporto di Prova tipo 2.2 UNI EN10204

Ø D	Ø A	Ø C	WFL		
M	mm	mm	kg		
3	6,5	6,3	180	5	082860203
4	8,5	7,5	200	3	082860204
5	10	9	330	2	082860205
6	12,5	12,6	720	2	082860206
7	12,5	14,2	850	2	082860207
8	14,5	16	1120	2	082860208
10	16,4	18	1300	2	082860210
12	19,3	20	2400	2	082860212

8287

terminali a tubo
inox AISI 316

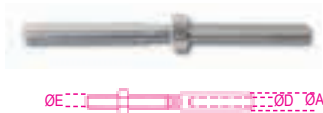

ANALISI DI LABORATORIO

- analisi chimica
 - test di trazione
- CERTIFICATI DISPONIBILI
- Specifica Prodotto
 - Rapporto di Prova tipo 2.2 UNI EN10204

Ø D	Ø A	E	WFL		
M	mm	mm	kg		
3	6,2	M6	180	5	082870203
4	7,5	M8	200	3	082870204
5	8,7	M10	330	2	082870205
6	12,6	M12	720	2	082870206
7	12,6	M14	850	2	082870207
8	16	M16	1120	2	082870208
10	18	M16	1300	2	082870210
12	20	M20	2400	2	082870212

8290

ponticelli
inox AISI 316



ANALISI DI LABORATORIO

- analisi chimica
- CERTIFICATI DISPONIBILI
- Specifica Prodotto
 - Rapporto di Prova tipo 2.2 UNI EN10204

Ø A	B	Ø C	L		
mm	mm	mm	mm		
5	18	4,3	40	5	082900205
6	22	5,2	44	5	082900206
8	23	5,2	51	5	082900208

8381SX

collari per sostegno tubazioni,
acciaio inox

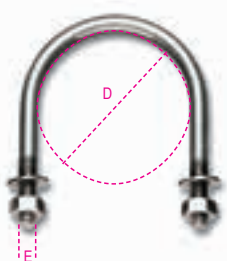

AISI 304

ANALISI DI LABORATORIO

- analisi chimica
- CERTIFICATI DISPONIBILI
- Rapporto di Prova tipo 2.2 UNIEN10204

D	D	E		
mm	gas	mm		
11	1/8"	M6	20	083810401
14	1/4"	M6	20	083810402
18	3/8"	M6	20	083810403
22	1/2"	M6	20	083810404
27	3/4"	M6	20	083810405
34	1"	M6	20	083810406
43	1 1/4"	M6	20	083810407
49	1 1/2"	M8	10	083810408
61	2"	M8	10	083810409
77	2 1/2"	M8	10	083810410
89	3"	M8	10	083810412
115	4"	M8	10	083810413
168	6"	M10	1	083810416
220	8"	M10	1	083810418

8279

catene tipo Genovese
per collegamenti statici
INOX Aisi 304



DATI TECNICI

- coefficiente di sicurezza: 4
- CERTIFICATI DISPONIBILI
- Specifica Prodotto
 - Rapporto di Prova tipo 2.2 UNI EN10204

Ø mm	nr	WFL		
		kg	m	
2	13	20	50	1 082790020
3	17	55	50	1 082790030
4	19	100	50	1 082790040
5	21	250	40	1 082790050
6	23	310	30	1 082790060
8	27	400	15	1 082790080
10	30	1000	10	1 082790400

Attenzione: prodotto NON destinato al sollevamento



8293

systemi di legatura a cricchetto AISI 304
nastro in poliestere ad alta tenacità LC 300kg
ganci uncino

in confezione appendibile

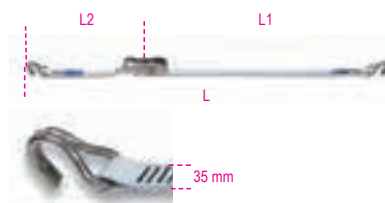

L	L2	L1	STF		
m	mm	mm	daN		
6	5700	300	100	1	082930106

LC = 300 kg

8297C

systemi di legatura ad anello
con mini cricchetto AISI 304
nastro in poliestere ad alta tenacità LC 700kg

in confezione appendibile

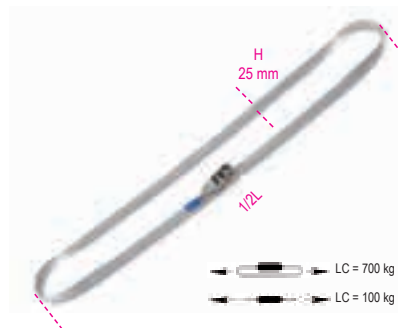

L	H		
m	mm		
5	25	1	082970350

LC = 700 kg

8297F

2 sistemi di legatura ad anello
con fibbia AISI 304
nastro in poliestere ad alta tenacità LC 250kg

in confezione appendibile

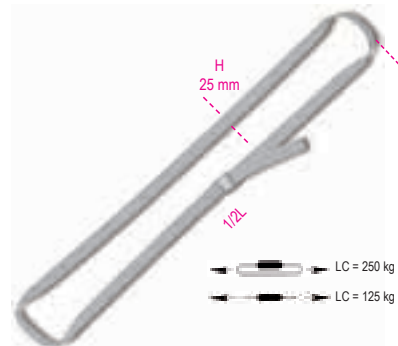

L	H		
m	mm		
3	25	1	082970230

LC = 250 kg

BRACHE DI NASTRO IN POLIESTERE UNI EN1492-1 e UNI EN1492-2

DATI TECNICI

- coefficiente di sicurezza: 7
- codice lotto di fabbricazione

ANALISI DI LABORATORIO

- test di trazione

CERTIFICATI DISPONIBILI

- Specifica Prodotto
- Rapporto di Prova tipo 2.2 UNI EN10204
- Certificato del Fabbricate UNI EN1492
- Dichiarazione di Conformità CE

	1t	0,8t	2t	1,4t	1t
	1t	0,8t	2t	1,4t	1t
	2t	1,6t	4t	2,8t	2t
	3t	2,4t	6t	4,2t	3t
	4t	3,2t	8t	5,6t	4t
	5t	4t	10t	7t	5t
	6t	4,8t	12t	8,4t	6t
	8t	6,4t	16t	11,2t	8t
	10t	8t	20t	14t	10t
	12t	9,6t	24t	16,8t	12t
	15t	12t	30t	21t	15t
	20t	16t	40t	28t	20t
	25t	20t	50t	35t	25t
	30t	24t	60t	42t	30t
	40t	32t	80t	56t	40t
	50t	40t	100t	70t	50t

8150

brache per sollevamento 1t viola
nastro piatto a due strati, asole rinforzate,
poliestere alta tenacità (PES)

CE



UNI EN 1492-1

L m	H mm	WLL ton		
0,5	30	1	1	081500005
1	30	1	1	081500010
1,5	30	1	1	081500015
2	30	1	1	081500020
2,5	30	1	1	081500025
3	30	1	1	081500030
3,5	30	1	1	081500035
4	30	1	1	081500040
5	30	1	1	081500050
6	30	1	1	081500060
8	30	1	1	081500080



8153

brache per sollevamento 2t verde
nastro piatto a due strati, asole rinforzate,
poliestere alta tenacità (PES)

CE



UNI EN 1492-1

L m	H mm	WLL ton		
1	60	2	1	081530010
1,5	60	2	1	081530015
2	60	2	1	081530020
2,5	60	2	1	081530025
3	60	2	1	081530030
3,5	60	2	1	081530035
4	60	2	1	081530040
5	60	2	1	081530050
6	60	2	1	081530060
8	60	2	1	081530080
10	60	2	1	081530100

8156

brache per sollevamento 3t giallo
nastro piatto a due strati, asole rinforzate,
poliestere alta tenacità (PES)

CE

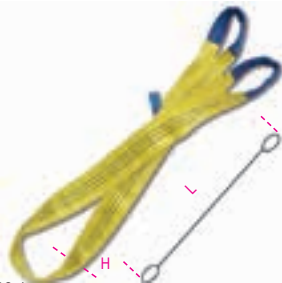

UNI EN 1492-1

L m	H mm	WLL ton		
1	90	3	1	081560010
1,5	90	3	1	081560015
2	90	3	1	081560020
2,5	90	3	1	081560025
3	90	3	1	081560030
3,5	90	3	1	081560035
4	90	3	1	081560040
5	90	3	1	081560050
6	90	3	1	081560060
8	90	3	1	081560080
10	90	3	1	081560100
12	90	3	1	081560120

8157

brache per sollevamento 4t grigio
nastro piatto a due strati, asole rinforzate,
poliestere alta tenacità (PES)

CE



UNI EN 1492-1

L m	H mm	WLL ton		
2	120	4	1	081570020
3	120	4	1	081570030
4	120	4	1	081570040
5	120	4	1	081570050
6	120	4	1	081570060
8	120	4	1	081570080
10	120	4	1	081570100
12	120	4	1	081570120

8158

brache per sollevamento 5t rosso
nastro piatto a due strati, asole rinforzate,
poliestere alta tenacità (PES)

CE



UNI EN 1492-1

L m	H mm	WLL ton		
2	150	5	1	081580020
3	150	5	1	081580030
4	150	5	1	081580040
5	150	5	1	081580050
6	150	5	1	081580060
8	150	5	1	081580080
10	150	5	1	081580100
12	150	5	1	081580120



8159

brache per sollevamento 6t marrone
nastro piatto a due strati, asole rinforzate,
poliestere alta tenacità (PES)

CE



UNI EN 1492-1

L m	H mm	WLL ton		
2	180	6	1	081590020
3	180	6	1	081590030
4	180	6	1	081590040
5	180	6	1	081590050
6	180	6	1	081590060
8	180	6	1	081590080
10	180	6	1	081590100

8160

brache per sollevamento 8t blu
nastro piatto a due strati, asole rinforzate,
poliestere alta tenacità (PES)

CE



UNI EN 1492-1

L m	H mm	WLL ton		
3	240	8	1	081600030
4	240	8	1	081600040
5	240	8	1	081600050
6	240	8	1	081600060
8	240	8	1	081600080
10	240	8	1	081600100

8161

brache per sollevamento 10t arancio
nastro piatto a due strati, asole rinforzate,
poliestere alta tenacità (PES)

CE

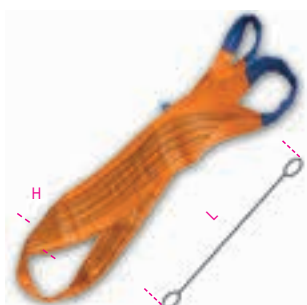

UNI EN 1492-1

L m	H mm	WLL ton		
3	300	10	1	081610030
4	300	10	1	081610040
5	300	10	1	081610050

L m	H mm	WLL ton		
6	300	10	1	081610060
8	300	10	1	081610080
10	300	10	1	081610100
12	300	10	1	081610120

8170

brache per sollevamento 1t
nastro ad anello continuo, viola
tessuto in poliestere ad alta tenacità (PES)

CE



UNI EN 1492-2

L m	WLL ton	H mm		
0,5	1	45	1	081700010
1	1	45	1	081700020
1,5	1	45	1	081700030
2,5	1	45	1	081700050
2	1	45	1	081700040
3	1	45	1	081700060
4	1	45	1	081700080
5	1	45	1	081700100

8173

brache per sollevamento 2t
nastro ad anello continuo, verde
tessuto in poliestere ad alta tenacità (PES)

CE

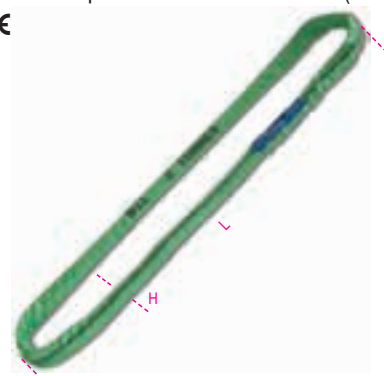

UNI EN 1492-2

L m	H mm	WLL ton		
0,5	50	2	1	081730010
1	50	2	1	081730020
1,5	50	2	1	081730030
2	50	2	1	081730040
2,5	50	2	1	081730050
3	50	2	1	081730060
4	50	2	1	081730080
5	50	2	1	081730100
6	50	2	1	081730120
8	50	2	1	081730160

Robur

8176

brache per sollevamento 3t
nastro ad anello continuo, giallo
tessuto in poliestere ad alta tenacità (PES)

CE



UNI EN 1492-2

L m	H mm	WLL ton		
0,5	60	3	1	081760010
1	60	3	1	081760020
1,5	60	3	1	081760030
2	60	3	1	081760040
2,5	60	3	1	081760050
3	60	3	1	081760060
4	60	3	1	081760080
5	60	3	1	081760100
6	60	3	1	081760120
8	60	3	1	081760160

8177

brache per sollevamento 4t
nastro ad anello continuo, grigio
tessuto in poliestere ad alta tenacità (PES)

CE



UNI EN 1492-2

L m	H mm	WLL ton		
0,5	65	4	1	081770010
1	65	4	1	081770020
1,5	65	4	1	081770030
2	65	4	1	081770040
2,5	65	4	1	081770050
3	65	4	1	081770060
4	65	4	1	081770080
5	65	4	1	081770100
6	65	4	1	081770120
8	65	4	1	081770160

Robur

8178

brache per sollevamento 5t
nastro ad anello continuo, rosso
tessuto in poliestere ad alta tenacità (PES)

CE

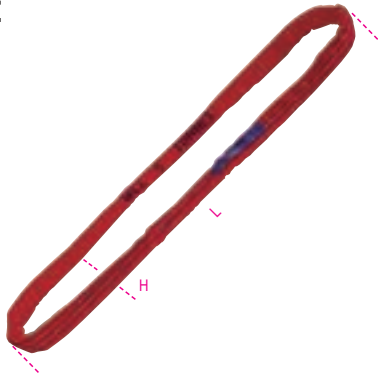

UNI EN 1492-2

L m	H mm	WLL ton	
0,5	70	5	1 081780010
1	70	5	1 081780020
1,5	70	5	1 081780030
2	70	5	1 081780040
2,5	70	5	1 081780050
3	70	5	1 081780060
4	70	5	1 081780080
5	70	5	1 081780100
6	70	5	1 081780120
8	70	5	1 081780160

8179M

brache per sollevamento 6t
nastro ad anello continuo, marrone
tessuto in poliestere ad alta tenacità (PES)

CE

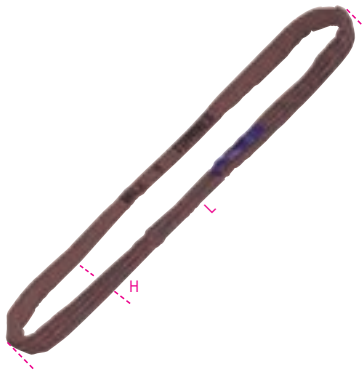

UNI EN 1492-2

L m	H mm	WLL ton	
1	80	6	1 081790020
1,5	80	6	1 081790030
2	80	6	1 081790040
2,5	80	6	1 081790050
3	80	6	1 081790060
4	80	6	1 081790080
5	80	6	1 081790100
6	80	6	1 081790120
8	80	6	1 081790160

8179B

brache per sollevamento 8t
nastro ad anello continuo, blu
tessuto in poliestere ad alta tenacità (PES)

CE

UNI EN 1492-2

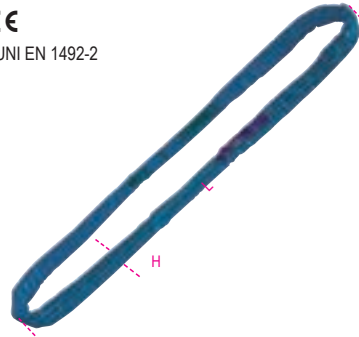

L m	H mm	WLL ton	
1	85	8	1 081790220
1,5	85	8	1 081790230
2	85	8	1 081790240
2,5	85	8	1 081790250
3	85	8	1 081790260
4	85	8	1 081790280
5	85	8	1 081790300
6	85	8	1 081790320
8	85	8	1 081790360

8179A

brache per sollevamento 10t+50t
nastro ad anello continuo, arancio
tessuto in poliestere ad alta tenacità (PES)

CE

UNI EN 1492-2

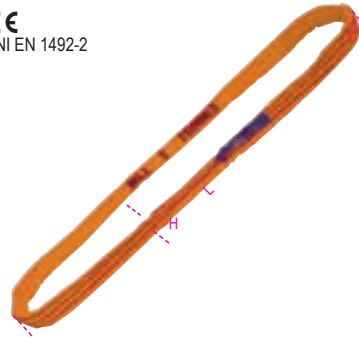

L m	H mm	WLL ton	
1	95	10	1 081790502
1,5	95	10	1 081790503
2,5	95	10	1 081790505
2	95	10	1 081790504
3	95	10	1 081790506
4	95	10	1 081790508
5	95	10	1 081790510
6	95	10	1 081790512
8	95	10	1 081790516
10	95	10	1 081790520

2	100	12	1 081791204
2,5	100	12	1 081791205
3	100	12	1 081791206
3,5	100	12	1 081791207
4	100	12	1 081791208
4,5	100	12	1 081791209
5	100	12	1 081791210
5,5	100	12	1 081791211
6	100	12	1 081791212
6,5	100	12	1 081791213
7	100	12	1 081791214
7,5	100	12	1 081791215
8	100	12	1 081791216
8,5	100	12	1 081791217
9	100	12	1 081791218
9,5	100	12	1 081791219
10	100	12	1 081791220

2	110	15	1 081791504
2,5	110	15	1 081791505
3	110	15	1 081791506
3,5	110	15	1 081791507
4	110	15	1 081791508
4,5	110	15	1 081791509
5	110	15	1 081791510
5,5	110	15	1 081791511
6	110	15	1 081791512
6,5	110	15	1 081791513

L m	H mm	WLL ton	
7	110	15	1 081791514
7,5	110	15	1 081791515
8	110	15	1 081791516
8,5	110	15	1 081791517
9	110	15	1 081791518
9,5	110	15	1 081791519
10	110	15	1 081791520

2	130	20	1 081792004
2,5	130	20	1 081792005
3	130	20	1 081792006
3,5	130	20	1 081792007
4	130	20	1 081792008
4,5	130	20	1 081792009
5	130	20	1 081792010
5,5	130	20	1 081792011
6	130	20	1 081792012
6,5	130	20	1 081792013
7	130	20	1 081792014
7,5	130	20	1 081792015
8	130	20	1 081792016
8,5	130	20	1 081792017
9	130	20	1 081792018
9,5	130	20	1 081792019
10	130	20	1 081792020

2	135	25	1 081792504
2,5	135	25	1 081792505
3	135	25	1 081792506
3,5	135	25	1 081792507
4	135	25	1 081792508
4,5	135	25	1 081792509
5	135	25	1 081792510
5,5	135	25	1 081792511
6	135	25	1 081792512
6,5	135	25	1 081792513
7	135	25	1 081792514
7,5	135	25	1 081792515
8	135	25	1 081792516
8,5	135	25	1 081792517
9	135	25	1 081792518
9,5	135	25	1 081792519
10	135	25	1 081792520

2	160	30	1 081793004
2,5	160	30	1 081793005
3	160	30	1 081793006
3,5	160	30	1 081793007
4	160	30	1 081793008
4,5	160	30	1 081793009
5	160	30	1 081793010
5,5	160	30	1 081793011
6	160	30	1 081793012
6,5	160	30	1 081793013
7	160	30	1 081793014
7,5	160	30	1 081793015
8	160	30	1 081793016
8,5	160	30	1 081793017
9	160	30	1 081793018
9,5	160	30	1 081793019
10	160	30	1 081793020

2	165	40	1 081794004
2,5	165	40	1 081794005
3	165	40	1 081794006
3,5	165	40	1 081794007
4	165	40	1 081794008
4,5	165	40	1 081794009
5	165	40	1 081794010
5,5	165	40	1 081794011
6	165	40	1 081794012
6,5	165	40	1 081794013
7	165	40	1 081794014
7,5	165	40	1 081794015
8	165	40	1 081794016
8,5	165	40	1 081794017
9	165	40	1 081794018
9,5	165	40	1 081794019
10	165	40	1 081794020

3	180	50	1 081795006
3,5	180	50	1 081795007
4	180	50	1 081795008
4,5	180	50	1 081795009
5	180	50	1 081795010
5,5	180	50	1 081795011
6	180	50	1 081795012
6,5	180	50	1 081795013
7	180	50	1 081795014
7,5	180	50	1 081795015
8	180	50	1 081795016
8,5	180	50	1 081795017
9	180	50	1 081795018
9,5	180	50	1 081795019
10	180	50	1 081795020

Robur

8166

guaine antiabrasione per brache di sollevamento, in poliestere ad alta tenacità (PES) con sottostrato elastomerico



H	ø	L		
mm	mm	m		
70	45	3	1	081660073
80	52	3	1	081660083
110	70	3	1	081660103
155	100	3	1	081660153
170	110	3	1	081660170
235	150	4	1	081660235

H			
mm			
70	8150	8170-8173	081660073
80	8153	8176	081660083
110	8153-8156	8177-8178	081660103
155	8157	8178-8179A 8179B-8179M	081660153
170	8158	-	081660170
235	8159	-	081660235

8090F

maglie di giunzione da sollevamento, per brache in poliestere, acciaio legato ad alta resistenza grado 8

CE

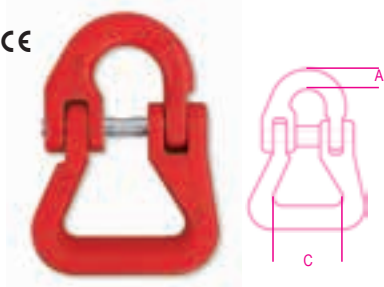

EN 1677-1

DATI TECNICI

- coefficiente di sicurezza: 4
- trattamento termico: bonifica
- codice lotto fabbricazione

ANALISI DI LABORATORIO

- analisi chimica, analisi metallografica
- test carico di prova (WLL x 2,5)
- test di trazione

- test di fatica (min. 20.000 cicli)

CERTIFICATI DISPONIBILI

- Specifica Prodotto
- Rapporto di Prova tipo 2.2 UNI EN10204
- Certificato di Controllo tipo 3.1 UNI EN10204
- Dichiarazione di Conformità CE

WLL	ø	A	C		
kg	mm	mm	mm		
2000	7-8	10,5	40	1	080900220
3150	10	12	50	1	080900232
5300	13	17	60	1	080900253
8000	16	21	75	1	080900280

Robur

SISTEMI DI ANCORAGGIO E LEGATURA

UNI EN 12195

DATI TECNICI

- coefficiente di sicurezza: 2
- codice di identificazione

ANALISI DI LABORATORIO

- test pretensionabilità cricchetto
- test di deformazione parti metalliche
- test di trazione sistema completo

CERTIFICATI DISPONIBILI

- Specifica Prodotto
- Rapporto di Prova tipo 2.2 UNI EN10204

8180

sistemi di ancoraggio a cricchetto LC 750kg nastro in poliestere ad alta tenacità (PES) ganci a uncino

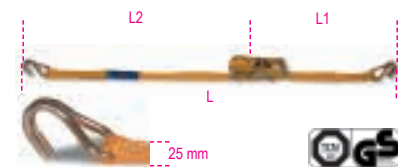

EN 12195-2

L	L2	L1	STF		
m	mm	mm	daN		
4	3750	250	200	1	081800004
6	5750	250	200	1	081800006
8	7750	250	200	1	081800008

LC = 750 kg

8181

sistemi di ancoraggio a cricchetto LC 1000kg nastro in poliestere ad alta tenacità (PES) ganci a uncino



EN 12195-2

L	L2	L1	STF		
m	mm	mm	daN		
4	3600	400	180	1	081810004
6	5600	400	180	1	081810006
8	7600	400	180	1	081810008

LC = 1000 kg

8181S

sistemi di ancoraggio a cricchetto LC 1000kg nastro in poliestere ad alta tenacità (PES) ganci sponda

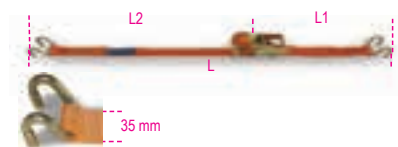

EN 12195-2

L	L2	L1	STF		
m	mm	mm	daN		
6	5600	400	180	1	081810206

LC = 1000 kg

8182E

sistemi di ancoraggio a cricchetto per interni
furgoni e autocarri, LC 1000kg
nastro in poliestere ad alta tenacità (PES)

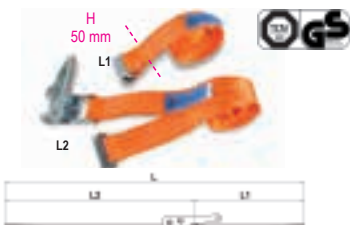

EN 12195-2

L	L2	L1	STF	
m	mm	mm	daN	
4	3500	500	220	1 081820440

LC = 1000 kg

	L2	L1	
	mm	mm	
8182EL parte lunga	2500		1 081820942
8182EC parte corta e cricchetto		1500	1 081820945

8182T

sistemi di ancoraggio a cricchetto LC 1500kg
nastro in poliestere ad alta tenacità (PES)
ganci a uncino

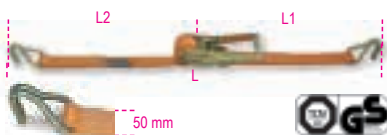

EN 12195-2

L	L2	L1	STF	
m	mm	mm	daN	
8,5	8100	400	300	1 081821085
10,5	10100	400	300	1 081821105

LC = 1500 kg

8182TS

sistemi di ancoraggio a cricchetto LC 1500kg
nastro in poliestere ad alta tenacità (PES)
ganci sponda

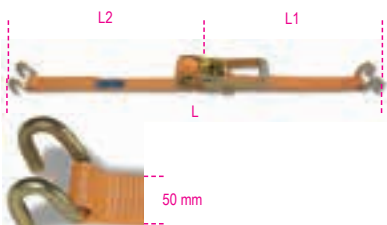

EN 12195-2

L	L2	L1	STF	
m	mm	mm	daN	
8,5	8100	400	300	1 081821285
10,5	10100	400	300	1 081821305

LC = 1500 kg

8182

sistemi di ancoraggio a cricchetto LC 2000kg
nastro in poliestere ad alta tenacità (PES)
ganci a uncino

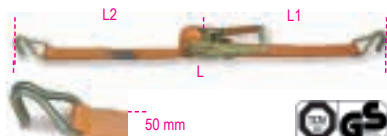

EN 12195-2

L	L2	L1	STF	
m	mm	mm	daN	
4,5	4100	400	300	1 081820045
6,5	6100	400	300	1 081820065
8,5	8100	400	300	1 081820085
10,5	10100	400	300	1 081820105
14,5	14100	400	300	1 081820145
16,5	16100	400	300	1 081820165

LC = 2000 kg

	L2	L1	
	mm	mm	
8182LP parte lunga	8100		1 081820902
8182SP parte corta e cricchetto		400	1 081820905

8182S

sistemi di ancoraggio a cricchetto LC 2000kg
nastro in poliestere ad alta tenacità (PES)
ganci sponda

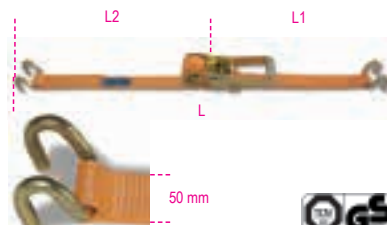

EN 12195-2

L	L2	L1	STF	
m	mm	mm	daN	
6,5	6100	400	400	1 081820265
8,5	8100	400	350	1 081820285
10,5	10100	400	350	1 081820305

LC = 2000 kg

	L2	L1	
	mm	mm	
8182SLP parte lunga	8100		1 081820912
8182SSP parte corta e cricchetto		400	1 081820915



8182GD

sistemi di ancoraggio a cricchetto LC 2000kg
nastro in poliestere ad alta tenacità (PES)
con ganci delta



EN 12195-2

L	L2	L1	STF	
m	mm	mm	daN	
8,5	8100	400	300	1 081820485

LC = 2000 kg

8182A

sistemi di ancoraggio a cricchetto con 2 asole
nastro in poliestere ad alta tenacità (PES)
LC 2000kg



EN 12195-2

L	L2	L1	STF	
m	mm	mm	daN	
8,5	8100	400	300	1 081820585

LC = 2000 kg

8182H

sistemi di ancoraggio a cricchetto LC 2500kg
nastro in poliestere ad alta tenacità (PES)
ganci a uncino

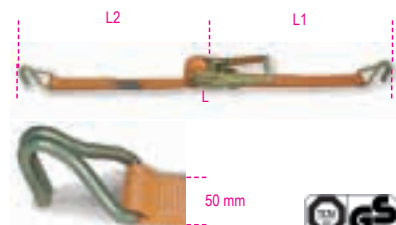

EN 12195-2

L	L2	L1	STF	
m	mm	mm	daN	
6,5	6100	400	300	1 081820406
8,5	8100	400	300	1 081820408
10,5	10100	400	300	1 081820410
14,5	14100	400	300	1 081820414

LC = 2500 kg

Robur

8182H/2

sistemi di ancoraggio a cricchetto LC 2500kg
nastro in poliestere ad alta tenacità (PES)
ganci sponda

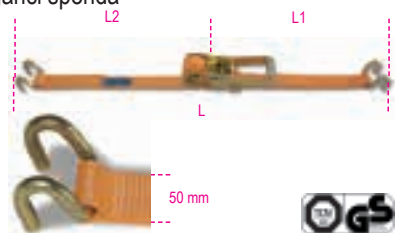

EN 12195-2

L m	L1 mm	L2 mm	STF daN		
8,5	8100	400	300	1	081820385

LC = 2500 kg

8184

sistemi di ancoraggio a cricchetto inverso a
leva lunga LC 2500kg
nastro in poliestere ad alta tenacità (PES)
ganci a uncino



EN12195-2

L m	L2 mm	L1 mm	STF daN		
6,5	6100	400	500	1	081840065
8,5	8100	400	500	1	081840085
10,5	10100	400	500	1	081840105

LC = 2500 kg

8183

sistemi di ancoraggio a cricchetto LC 5000kg
nastro in poliestere ad alta tenacità (PES)
ganci a uncino



EN 12195-2

L m	L2 mm	L1 mm	STF daN		
8,5	8000	500	500	1	081830085
12,5	12000	500	500	1	081830125

LC = 5000 kg

8190

tendicatena di ancoraggio a cricchetto
con due ganci per catene
di ancoraggio 8190B Ø 8 e 10mm
Grado 8



EN12195/3

DATI TECNICI

- coefficiente di sicurezza: 2
- trattamento termico: ganci bonificati
- codice lotto

ANALISI DI LABORATORIO

- analisi chimica, analisi metallografica
- test di trazione

CERTIFICATI DISPONIBILI

- Specifica Prodotto
- Rapporto di Prova tipo 2.2 UNI EN10204
- Certificato di Controllo tipo 3.1 UNI EN10204

Ø mm	LC daN	Ø mm	LC daN		
10	6300	8	4000	1	081900010

* ATTENZIONE: il prodotto può essere utilizzato con
catena 8mm con opportuna riduzione del carico (LC
4000daN)

8190B

catene di ancoraggio carichi
per tendicatena a cricchetto 8190
Grado 8

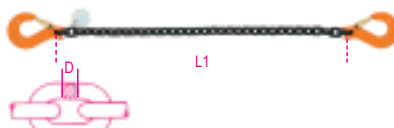

EN12195/3

DATI TECNICI

- coefficiente di sicurezza: 2
- trattamento termico: bonifica
- piastrina di identificazione seriale

ANALISI DI LABORATORIO

- analisi chimica, • analisi metallografica
- test carico di rottura

CERTIFICATI ALLEGATI

- Certificato del Fabbricante
- Rapporto di Prova tipo 2.2 UNI EN10204
- Specifica Prodotto

Ø mm	LC daN	L m	L1 m		
8	4000	3,5	3,30	1	081901308
10	6300	3,5	3,28	1	081901310

Robur

8185

sistemi di ancoraggio ad anello LC 1500kg
con cricchetto tenditore
nastro in poliestere ad alta tenacità (PES)



EN 12195-2

L m	STF daN		
5	200	1	081850005
8	200	1	081850008

8186

sistemi di ancoraggio ad anello LC 2000kg
con cricchetto tenditore
nastro in poliestere ad alta tenacità (PES)



EN 12195-2

L m	STF daN		
5	180	1	081860005
8	180	1	081860008

Robur

8187

sistemi di ancoraggio ad anello LC 4000kg
con cricchetto tenditore
nastro in poliestere ad alta tenacità (PES)



EN 12195-2

L m	STF daN		
5	350	1	081870005
8	350	1	081870008

8188C

sistemi di legatura ad anello LC 800kg
con cricchetto tenditore
nastro in poliestere ad alta tenacità (PES)

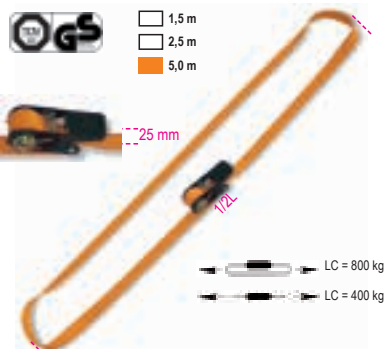

EN 12195-2

L m	STF daN		
1,5	72	3	081880315
2,5	72	3	081880325
5	72	3	081880350

8188CG/25

sistemi di legatura con 2 ganci ed asole,
cricchetto tenditore LC 400kg
nastro in poliestere ad alta tenacità (PES)



EN 12195-2

L m	L1 mm	L2 mm	STF daN		
3	480	170	120	1	081880430
5	480	170	120	1	081880450

8188CU/25

sistemi di legatura con ganci uncino,
cricchetto tenditore LC 400kg
nastro in poliestere ad alta tenacità (PES)

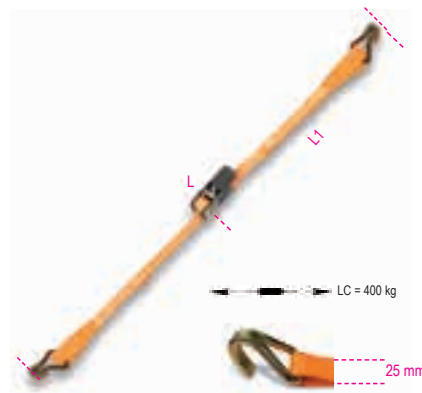

EN 12195-2

L m	L1 mm	L2 mm		
5	300	4700	1	081880750

8188F

sistemi di legatura ad anello LC 200kg
con fibbia di serraggio
nastro in polipropilene ad alta tenacità (PP)

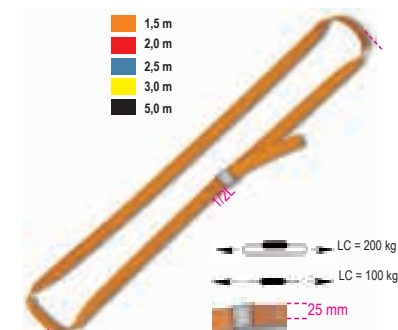

EN 12195-2

L m			
1,5	10	081880215	
2,0	10	081880220	
2,5	10	081880225	
3,0	10	081880230	
5,0	6	081880250	

8188F35

sistemi di legatura ad anello LC 500kg
con fibbia di serraggio
nastro in polipropilene ad alta tenacità (PP)



EN 12195-2

L m			
5	1	081880295	

8188VFG2

sistemi di legatura con 2 ganci ed asole,
fibbia di serraggio LC 250kg
nastro in polipropilene ad alta tenacità (PP)



EN 12195-2

L m	L1 mm	L2 mm		
3	450	110	1	081881530

8189

nastro di legatura
poliestere (PES), in rotoli
pezze con lunghezza variabile: minima continua garantita 30m



H mm	L m	LC kg		
25	100	750	1	081890902
35	100	1000	1	081890903
50	100	2000	1	081890905

8189A

tappetino antiscivolo
per il fissaggio del carico



L m	H mm	S mm	μ		
5	250	8	0,6	1	081890525

8189PA

2 protezioni angolari
per nastri di ancoraggio in poliestere



L1xL2 mm	H1 mm	H2 mm		
135x90	60	18	1	081890090

Articolo	Rapporto di Prova 2.2 (UNI EN 10204)	Certificato di Controllo 3.1 (UNI EN 10204)	Certificato del fabbricante	Dichiarazione di Conformità CE
8001Z	✓	✓		✓
8001TZ	✓	✓		✓
8002ZD	✓			
8003ZD	✓			
8004ND	✓			
8005Z	✓			✓
8005TZ	✓			✓
8006Z	✓			✓
8007Z	✓			✓
8008N	✓			✓
8008TZN	✓			✓
8009FD	✓			
8009Z	✓			✓
8009TZ	✓			✓
8010Z	✓			✓
8010TZ	✓			
8015	✓		✓	✓
8016	✓			✓
8016DA	✓			✓
8016FR	✓			
8016U2	✓		✓	✓
8016UGK	✓		✓	✓
8018E	✓			
8018T	✓			
8020A	✓			
8021A	✓			
8025	✓	✓		✓
8026A	✓	✓		✓
8026R	✓	✓		✓
8028	✓	✓		✓
8029R	✓	✓		✓
8031R	✓	✓		✓
8032	✓	✓		✓
8040EN	✓	✓		✓
8040EZ	✓	✓		✓
8042EN	✓	✓		✓
8042EZ	✓	✓		✓
8041	✓	✓		✓
8043	✓	✓		✓
8044	✓	✓		✓
8048	✓			
8049	✓	✓		✓
8049A	✓	✓		✓
8049V	✓	✓		✓
8051S	✓	✓		✓
8052	✓	✓		✓
8057R	✓	✓		✓
8058R	✓	✓		✓
8060R	✓	✓		✓
8061R	✓	✓		✓
8062	✓	✓		✓
8063	✓	✓		✓
8063SL	✓	✓		✓
8064S	✓	✓		✓
8065SC	✓	✓		✓
8068G	✓	✓		✓
8074	✓			
8074A	✓			
8074G	✓			
8080	✓			
8080FM	✓			
8085R	✓	✓		✓
8086	✓	✓		✓
8090	✓	✓		✓
8090F	✓	✓		✓

Articolo	Rapporto di Prova 2.2 (UNI EN 10204)	Certificato di Controllo 3.1 (UNI EN 10204)	Certificato del fabbricante	Dichiarazione di Conformità CE
8090R	✓	✓		✓
8091			✓	✓
8091SL			✓	✓
8092			✓	✓
8092SL			✓	✓
8094			✓	✓
8094SL			✓	✓
8096			✓	✓
8096SL			✓	✓
8097			✓	✓
8097SL			✓	✓
8098			✓	✓
8098SL			✓	✓
8100	✓	✓		✓
8105	✓	✓		✓
8109	✓	✓		✓
8110	✓			
8114	✓			
8116	✓			
8120 - 8120D	✓			
8120B	✓			
8130A	✓			
8135	✓		✓	✓
8139DL	✓			
8143	✓		✓	✓
8146	✓		✓	✓
8146K	✓		✓	✓
8147C-S-P	✓		✓	✓
8148	✓		✓	✓
8149	✓			✓
8150	✓		✓	✓
8153	✓		✓	✓
8156	✓		✓	✓
8157	✓		✓	✓
8158	✓		✓	✓
8159	✓		✓	✓
8160	✓		✓	✓
8161	✓		✓	✓
8166	✓			
8170	✓		✓	✓
8173	✓		✓	✓
8176	✓		✓	✓
8177	✓		✓	✓
8178	✓		✓	✓
8179M-B-A	✓		✓	✓
8180	✓			
8181	✓			
8181S	✓			
8182	✓			
8182A-GD	✓			
8182E	✓			
8182H-H2	✓			
8182M	✓			
8182S	✓			
8182T	✓			
8182T-TS	✓			
8182TS	✓			
8185	✓			
8186	✓			
8187	✓			
8188C	✓			
8188CG/25	✓			
8188CU	✓			
8188F	✓			
8188VF/35	✓			

Articolo	Rapporto di Prova 2.2 (UNI EN 10204)	Certificato di Controllo 3.1 (UNI EN 10204)	Certificato del fabbricante	Dichiarazione di Conformità CE
8188FG2	✓			
8190	✓	✓		
8190B	✓		✓	
8302Z	✓			
8303Z	✓			
8317DZ	✓			
8317SZ	✓			
8381SL	✓			
8381SP	✓			
8383C	✓			
8383P	✓			
8515V	✓			
8515Z	✓			
8531	✓			
8532	✓			
8535	✓			
8201T	✓			
8205	✓			
8206	✓			
8207	✓			
8209	✓			
8210	✓			
8210F	✓			
8210FTP	✓			
8216	✓			✓
8220	✓			
8225	✓			
8227	✓			
8228	✓			
8240	✓			
8240F	✓	✓		✓
8242	✓			
8242F	✓	✓		✓
8248	✓			
8249	✓			
8249G	✓			
8250	✓			
8264	✓			
8267	✓			
8272	✓			
8273	✓			
8274	✓			
8274A	✓			
8274G	✓			
8276	✓			
8276G	✓			
8278	✓			
8280	✓			
8282	✓			
8282S	✓			
8284	✓			
8285	✓			
8286	✓			
8287	✓			
8290	✓			
8293	✓			
8297C	✓			
8297F	✓			
8381SX	✓			
8702...	✓	✓		
8709...	✓	✓		



Beta Collection



È una linea di prodotti esclusivi pensati e realizzati come espressione del carattere Beta che comprende oltre 200 creazioni originali di altissima qualità: attrezzature sportive, abbigliamento tecnico e una molteplicità di oggettistica personalizzata. Ideali per dar vita ad iniziative promozionali, e per trascorrere momenti di svago.



9500TL

softshell in tessuto poliestere 100%, 320g, composto da tre strati, guscio esterno in microfibra, membrana intermedia impermeabile e traspirante, interno in pile



Dimensione	Quantità	Articolo
S	1	095000051
M	1	095000052
L	1	095000053
XL	1	095000054
XXL	1	095000055

9501TLD

felpa donna in cotone 80%, poliestere 20%, 320 g



Dimensione	Quantità	Articolo
S	1	095010061
M	1	095010062
L	1	095010063
XL	1	095010064

9501TL

felpa uomo in cotone 80%, poliestere 20%, 320 g



Dimensione	Quantità	Articolo
S	1	095010051
M	1	095010052
L	1	095010053
XL	1	095010054
XXL	1	095010055

9502TL

polo 100% cotone piqué, 210 g



S	1	095020051
M	1	095020052
L	1	095020053
XL	1	095020054
XXL	1	095020055

9504TL

giacca in tessuto esterno 100% poliestere con trattamento idrorepellente



S	1	095040051
M	1	095040052
L	1	095040053
XL	1	095040054
XXL	1	095040055

9508TL

giacca impermeabile, 100% poliestere, tascabile



S	1	095080051
M	1	095080052
L	1	095080053
XL	1	095080054
XXL	1	095080055

9599 GARAGE

polo in poliestere traspirante Beta Garage, 175 g, colore nero



S	1	095999011
M	1	095999012
L	1	095999013
XL	1	095999014
XXL	1	095999015

9505TL

gilet in tessuto esterno 100% poliestere con trattamento idrorepellente, imbottitura 100 gr e tasca interna



S	1	095050051
M	1	095050052
L	1	095050053
XL	1	095050054
XXL	1	095050055

9510W

camicia uomo elasticizzata a manica lunga, 120 g/m2 97% cotone, 3% elastan. Bianca, con logo nero. Carrè posteriore con due pieghe laterali, colletto semi francese. Bottoni bianchi, due bottoni al polsino. Vestibilità slim



XS	1	095100100
S	1	095100101
M	1	095100102
L	1	095100103
XL	1	095100104
XXL	1	095100105

9503TL

T-shirt 100% cotone jersey, 160 g



S	1	095030051
M	1	095030052
L	1	095030053
XL	1	095030054
XXL	1	095030055

9572LB

t-shirt Beta-March, 100% cotone, 200 g arancione con inserti neri



S	1	095720801
M	1	095720802
L	1	095720803
XL	1	095720804
XXL	1	095720805

9534WO

polo 2 bottoni in cotone jersey, 200 g, bianco con inserti arancioni



S	1	095340031
M	1	095340032
L	1	095340033
XL	1	095340034
XXL	1	095340035

9534B0

polo 2 bottoni in cotone jersey, 200 g, blu con inserti grigi



S	1	095340071
M	1	095340072
L	1	095340073
XL	1	095340074
XXL	1	095340075

9537TL

pile 100% poliestere



S	1	095370051
M	1	095370052
L	1	095370053
XL	1	095370054
XXL	1	095370055

9580S

occhiali da sole, modello "Summer"

CE



EN ISO 12312-1:2013+A1:2015
UV400
FILTER CAT. III

9580S	1	095800100
-------	---	-----------

9593S

smartwatch, touchscreen, fitness tracker, cinturino in silicone



9593S	1	095930200
-------	---	-----------

9593SB

smart bracelet, touchscreen, fitness tracker, multifunzione, con cardiofrequenzimetro, contapassi, monitoraggio del sonno, con cinturino in silicone, nero

Compatibilità: IOS 8.2 o superiori/ Android 4.4 o superiori
Bluetooth 4.2
IP67

CE



IP67

9593SB	1	095930205
--------	---	-----------

9593M

orologio con movimento automatico, cassa in acciaio, water resistant 5 ATM, cinturino in acciaio



9593M	1	095930120
-------	---	-----------

9593A

cronografo, cassa in acciaio, water resistant 5ATM, cinturino in silicone



9593A	1	095930050
-------	---	-----------

9593W

orologio analogico, cassa in plastica soft touch con ghiera in metallo, water resistant 3ATM, cinturino in silicone



9593W	1	095930150
-------	---	-----------

9544C

trolley dimensioni formato cabina con 4 ruote doppie, lucchetto TSA, porta USB + jack 3,5 mm



9544C	L cm	S cm	H cm	1	095440101
	40	20	55		

 Beta

9557J 2.0

borsone in poliestere spalmato/poliestere oxford 600D, dimensioni 47x28x25 cm



	L	S	H		
	cm	cm	cm		
9557J 2.0	47	25	28	1	095570020

9557N

borsa "Racing" realizzata in tessuto laminato PVC, totalmente impermeabile



	L	S	H		
	cm	cm	cm		
9557N	35	35	80	1	095570001

9541F

zaino in poliestere spalmato/poliestere oxford 600D, dimensioni 50x33x16 cm



	L	S	H		
	cm	cm	cm		
9541F	33	16	50	1	095410011

9541PC

zaino da lavoro multitasche, con tasca interna porta computer, in 100% poliestere

- zaino con 3 scomparti, tutti con zip esterna waterproof
- primo scomparto con tasca porta PC
- maniglia superiore imbottita
- presa USB
- tasca laterale a rete porta borraccia/ombrello
- inserto porta-occhiali su spallaccio
- cinghia al petto regolabile



	L	S	H		
	cm	cm	cm		
9541PC	34	18	52	1	095410041

9541S

zainetto con coulisse in poliestere 210D impermeabile cm 33x45



	L	H		
	cm	cm		
9541S	33	45	1	095410031

9541BIKE

zainetto in poliestere oxford, dimensioni 41x24x16 cm



	L	S	H		
	cm	cm	cm		
9541BIKE	24	16	41	1	095410021

95740

guanto da lavoro, con polsino elastico elasticizzato, pollice ed indice rinforzati, in pelle sintetica che consente l'uso di dispositivi touchscreen

CE



M	1	095740202
L	1	095740203
XL	1	095740204
XXL	1	095740205

9574B

guanto da lavoro, con polsino elastico elasticizzato, pollice ed indice rinforzati, in pelle sintetica che consente l'uso di dispositivi touchscreen

CE



M	1	095740102
L	1	095740103
XL	1	095740104
XXL	1	095740105

9525TL

cappellino Top Line



9525TL	1	095250010

9525F

cappellino con visiera piatta e regolazione in plastica



9525F	1	095250099

9525/B

cappellino, 100% cotone, taglia unica regolabile, ricamo diretto sul frontale, sui lati e sul retro, bianco



9525B	5	095251031

9521

ombrello in nylon T210 con fusto in alluminio, nero, 3 sezioni, automatico



9521

1 095210000

95210B

ombrello in nylon 210T, diametro 100 cm



95210B

100 cm

1 095210021

9599CB-N2

city bike Atala®, telaio in Hi-Ten Tig TKK 700c, cambio Shimano® Tourney RD-TZ50 6 velocità, freni V-brake®, cerchi in alluminio 28", dotata di portapacco, cavalletto e campanello, nero opaco



9599CB-N2

1 095990031

9599CB-W

city bike Atala®, telaio in alluminio, cambio Shimano® 6 velocità, freni V-Brake® cerchi in alluminio 28"



9599CB-W

1 095990023

9598W-N

mountain bike Whistle®, telaio in alluminio, forcella Suntour XCT30 29" 100 mm, cambio Shimano RD-TX500 7 velocità, freni idraulici Shimano BR-M200 e cerchi 29" in alluminio, arancione fluo/ antracite opaco



9598W-N M

1 095980130

9598W-N L

1 095980132

9598WHP-N

mountain bike Whistle®, telaio in alluminio, forcella Suntour XCM PL 29" 100 mm con remote lockout, cambio Shimano XT RD-M8100 Shadow Plus, 12 velocità, freni idraulici Shimano BL-MT201/BR-MT200 e cerchi 29" in alluminio, bianco/ rosso opaco



9598WHP-N M

1 095980140

9598WHP-N L

1 095980142

9515M

maglia in tessuto tecnico, traspirante e a rapida asciugatura; inserti laterali in rete



S

1 095150051

M

1 095150052

L

1 095150053

XL

1 095150054

XXL

1 095150055

XXXL

1 095150056

9516B

pantaloncini in Lycra 180 g, traspiranti, a rapida asciugatura, con elastico in vita per una migliore vestibilità



S

1 095160051

M

1 095160052

L

1 095160053

XL

1 095160054

XXL

1 095160055

XXXL

1 095160056

9539CB

casco di protezione per ciclismo su strada e mountain bike con frontino removibile - taglie regolabili



S-M

1 095390010

L-XL

1 095390011

9542M

maglia maniche corte in microfibra traspirante, zip lunga coperta, tre tasche posteriori di cui 1 con zip, elastico in silicone a fondo maglia



S

1 095420051

M

1 095420052

L

1 095420053

XL

1 095420054

XXL

1 095420055

XXXL

1 095420056

Beta
QUALITY TOOLS

9542C

salopette in lycra, elastico siliconato fondo gamba, fondello antibatterico ad alta traspirabilità



Dimensione	Quantità	Articolo
S	1	095420061
M	1	095420062
L	1	095420063
XL	1	095420064
XXL	1	095420065
XXXL	1	095420066

9542GW

giubbino invernale realizzato in tessuto antivento ad alta traspirabilità e in tessuto garzato; zip lunga, fascia elastica in vita senza silicone; polsino aderente in Lycra; inserti rifrangenti posteriori; 3 tasche esterne posteriori, di cui 1 con zip



Dimensione	Quantità	Articolo
S	1	095420101
M	1	095420102
L	1	095420103
XL	1	095420104
XXL	1	095420105
XXXL	1	095420106



9542G

maglia invernale in tessuto traspirante, garzato internamente, zip lunga, tre tasche posteriori, elastico in silicone a fondo maglia



Dimensione	Quantità	Articolo
S	1	095420012
M	1	095420013
L	1	095420014
XL	1	095420015
XXL	1	095420016
XXXL	1	095420017

9542S

calzamaglia in lycra garzata con fondello antibatterico ad alta traspirabilità



Dimensione	Quantità	Articolo
S	1	095420022
M	1	095420023
L	1	095420024
XL	1	095420025
XXL	1	095420026
XXXL	1	095420027

9542AT

giilet antivento in tessuto accoppiato traspirante, zip lunga



Dimensione	Quantità	Articolo
S	1	095420072
M	1	095420073
L	1	095420074
XL	1	095420075
XXL	1	095420076
XXXL	1	095420077

9542AL

giubbino antivento in tessuto accoppiato traspirante, zip lunga



Dimensione	Quantità	Articolo
S	1	095420042
M	1	095420043
L	1	095420044
XL	1	095420045
XXL	1	095420046
XXXL	1	095420047

9543C

copricollo tubolare, multifunzione, 100% microfibra di poliestere, senza cuciture



Dimensione	L (cm)	H (cm)	Quantità	Articolo
9543C	25	50	1	095430100



9523T

borraccia termica in acciaio inox, 500 ml, tecnologia doppio strato, senza aria tra le pareti, tappo antigoccia arancione

- 24 ore fresco
- 12 ore caldo



EC1935/EC2023

9523T ml 500 L mm 255 1 095230050

9528B

borraccia in polietilene, 500ml



9528B ml 500 1 095280005

9597P

pompa a colonna con manometro

- adattatore per il gonfiaggio di qualsiasi tipo di valvola (Schrader, Presta/Scloverand, Regina)
- Max 12 bar/ 180psi



9597P 1 095970100

9524SC

garage Beta in miniatura per collezionisti



1:18 1 095240018

9548KB

balance bike, telaio in acciaio e ruota 12" con camera d'aria, età consigliata: + 3 anni, peso massimo < 30 kg



9548KB 1 095480110

9548KB 20

mountain bike da bambino Atala® 20", telaio in acciaio Hi-Ten Tig 20", forcella ammortizzata 30 mm, cambio Shimano Tourney RD-TY21SS 6V, freni in alluminio V-brake e cerchi in alluminio, 36 fori, giallo fluo/ blu opaco



9548KB 20 1 095480120

9548KB 24

mountain bike da bambino Atala® 24", telaio in acciaio Hi-Ten Tig 24", forcella ammortizzata, cambio Shimano Tourney RD-TYZ50 6V, freni in alluminio V-brake e cerchi in alluminio, 36 fori, arancio fluo opaco



9548KB 24 1 095480122



9547WSK

"Kinder Work Station", banco da lavoro con utensili per bambini a partire da 3 anni

CE



9547WSK H cm 74 1 095473801

9547T

"Kinder trolley", carrello attrezzi con utensili per bambini a partire da 3 anni

CE



9547T 1 095470100

9548G

"Kinder Garage" a 6 piani, con autolavaggio, ascensore e rampe



9548G H cm 69 1 095480100

9561V 2,5

bandiera a vela mt 2,5x0,50
con asta in alluminio
basamento a croce completo di zavorra a
ciambella



	L	H		
	mt	mt		
9561V 2,5	0,50	2,5	1	095610200

9561VV 2,5

bandiera a vela mt 2x0,50
con asta



	L	H		
	mt	mt		
9561VV 2,5	0,50	2,5	1	095610201

9561VV

bandiera a vela mt 3,50x0,75
con asta



	L	H		
	mt	mt		
9561VV	0,75	3,50	1	095610101

9561V

bandiera a vela mt 4x0,75
con asta in metallo cromato
basamento in graniglia di cemento 50 cm



	L	H		
	mt	mt		
9561V	0,75	4	1	095610001

9559

striscione monofacciale in TNT,
modulo da 3x0,8 m o multipli



	L	H		
	m	m		
9559	3	0,8	1	095591001

9559/30MT

rotolo 10 loghi Beta in TNT



	L	H		
	m	m		
9559/30MT			1	095591031

9590B

bandiera in nylon serigrafato
140x215 cm



	L	H		
	cm	cm		
9590B	215	140	1	095900000

9577R

tuta da lavoro, **stile racing**, in tessuto
elasticizzato, 4 way stretch, 260 g,
nero e arancione, con inserti bianchi e reflex

CE



	I			
	cm			
S	48	1	095770151	
M	50	1	095770152	
L	52	1	095770153	
XL	54	1	095770154	
XXL	56	1	095770155	
XXXL	58	1	095770156	

9579C

camice in poliestere/cotone



	M		1	095791002
	L		1	095791003
	XL		1	095791004

9565BBQ

barbecue in lamiera d'acciaio con griglia e
braciere

Dotato di coperchio con morsetto per la chiusura.
Griglia in acciaio cromato (conforme alla normativa italiana
DM 21.03.73 e regolamento CE 1935/2004 in riferimento
all'idoneità del materiale a contatto con gli alimenti), dotata di
maniglie e piedini d'appoggio.



	H	ø		
	cm	cm		
9565BBQ	88	59	1	095650100

9565T

tavolo in lamiera d'acciaio con piano in legno
multistrato di betulla verniciato.

Fornito con doppio KIT di tubi distanziali (7 o 20 cm) per
regolare l'altezza a piacere.



	H	ø		
	cm	cm		
9565T	95→108	70	1	095650200

9565S

seduta in lamiera d'acciaio
con sedile in ecopelle sfoderabile



	H cm	ø cm	
9565S	60	38	2 095650300

9565ICE

portaggiaccio in lamiera d'acciaio

Dotato di coperchio di chiusura, con contenitore antigraffio, certificato per uso alimentare. L'interno del fusto è laccato con vernice antiruggine e resistente all'acqua. Nel contenitore si possono collocare ghiaccio e bottiglie/lattine da raffreddare.



	H cm	ø cm	
9565ICE	60	38	1 095650400

9565K

tavolo 9565T con due sedute 9565S



9565K			1 095650500
-------	--	--	-------------

9563G

poltrone per ufficio, per ospiti



9563G			1 095630050
-------	--	--	-------------

9563U

poltrona per ufficio, ergonomica, con braccioli



9563U			1 095630020
-------	--	--	-------------

9549ABW

auricolari Wireless Bluetooth V5.0, con microfono integrato, ricarica magnetica, base di ricarica con attacco USB-C, nero

CE



	L mm	H mm	S mm	
9549ABW	61	34,5	41	1 095490091

9549SBW

speaker Bluetooth wireless, portatile, 6 funzioni

versione Bluetooth 5.0

FUNZIONI:

- Bluetooth play
- TF card play
- USB play
- audio jack 3.5 mm
- radio FM
- funzione chiamata

CE



	L mm	S mm	H mm	
9549SBW	73	73	124	1 095490072

9549BP

batteria portatile, 10000mAh



9549BP				1 095490052
--------	--	--	--	-------------

9549CR

multicavo di ricarica 4 in 1, in nylon intrecciato, con carica rapida

- USB tipo-A per connessione dell'alimentatore
- Lightning per connessione modelli Apple
- Micro USB connettore di ricarica
- USB-C connettore per sola ricarica
- USB-C connettore per ricarica e trasmissione dati



	L mm		
9549CR	120		1 095490042

9549MPC

base di ricarica multi-presa, 6 porte USB per ricarica multipla fino a potenza assorbita massima di 65W

- 4 porte USB, 5V 2.4A
 - 1 porta USB, Q.C 3.0
 - 1 porta USB-C, 20W PD
- con interruttore ON/OFF separato
con schermo LED per verificare potenziale totale, numero della porta e intensità di corrente

CE



	L mm	S mm	H mm	
9545MPC	110	72	35	1 095490082

9549BRW

base di ricarica wireless, con funzione **quick charger** e **indicatore dello stato di carica**

- Cavo USB-USB Type C incluso, per collegamento a trasformatore, lunghezza 1 mt
- Compatibile con tutti i dispositivi abilitati alla ricarica wireless
- Input: DC 5V/2A, 9V/2A, 12V/1.5A
- Output: 5W/ 7.5W/ 10W/ 15W

CE



Ø mm
H mm

9549BRW 58 6 1 095490100

9549C

chiavetta USB, 32GB



9549C 1 095490062

9547

calcolatrice da tavolo

CE



9547 1 095470000

9594

orologio da parete dotato di termometro ed igrometro, diametro 26 cm



9594 26 1 095940051

9526P

macchina per caffè espresso a capsule

compatibile con cialde Lavazza™, Espresso Point™ per uso professionale



9526P 1 095260010

9527 6T

set 6 tazzine caffè



9527 6T 1 095270001

9527MUG

tazza "mug" con coperchio e fascia in silicone



9527MUG 1 095270020

9522A

apribottiglie con impugnatura ergonomica



9522A 1 095220010

9523A

borraccia in alluminio, 500ml



9523A 500 1 095230005

9586K

coltellino multiuso in acciaio, 10 funzioni



9586K 1 095860100

9526RMN

set 2 mazzi di 55 carte ramino Modiano®



9526RMN 1 095260001

9592B/C50

set 50 penne



9592B/C50 1 095920050

9592B/P

penne personalizzate



9592B/P 500 095920051

9592MB

penna a sfera Parker®



9592MB 1 095920060

9592M/50

set 50 matite



9592M/50 1 095920100

9588M

termoformato morbido con 1 penna e 2 block notes



9588M 1 095880011

9596

portabadge in poliestere con moschettone in metallo e filo portatelefono



9596 10 095961001

9595C

portachiave in pelle



9595C 1 095950011

9595T

portachiave in metallo cromato, in bustina di velluto



9595T 1 095950021

9595 C25

portachiave in metallo cromato con gancio in gomma



9595 C25 1 095950031

9569P

shopper in polietilene, con soffiati laterali



9569P L 34 H 44 50 095691001

9569S

shopper in TNT con soffietto, 38x42 cm



9569S L 38 H 42 50 095690051

9569MS-2

shopper in polipropilene, ad alta resistenza



9569MS-2 L 45 H 40 5 095690055

9569MS

shopper in polipropilene, ad alta resistenza, con doppi manici



9569MS L 60 H 40 5 095690052

9587 9x14

taccuino, 9x14 cm



9587 9X14 L 9 H 14 5 095870009

9587 13x21

taccuino, 13x21 cm



9587 13X21 L 13 H 21 5 095870013

9588S/10...

set di 10 block notes



9588S/10A 1 095881001
21x29 cm
9588S/10B 1 095881002
15x21 cm
9588S/10C 1 095881003
10x15 cm
9588S/10D 1 095880054
7,5x10,5 cm



9588/10PI

set di 10 blocchetti per appunti con fogli adesivi



9588S/10PI
7,5x7,5 cm

1 095880055

9589A/36

confezione da 36 rotoli di nastro adesivo per imballo, logo Beta, avana



9589A/36

1 095890035

9589B/36

confezione da 36 rotoli di nastro adesivo per imballo, logo Beta, bianco



9589B/36

1 095890036

9562TB

tappeto prova calzature, con retro gommato antiscivolo



9562TB
L mm 800
H mm 600

1 095620500

9562T2

tappeto per banco da lavoro 200x160 cm

- protegge il suolo da perdite d'olio, benzina e rispetta l'ambiente
- facile da pulire, fondo gommato ed antiscivolo



9562T2
L cm 200
H cm 160

1 095620200

9562T1

tappeto da officina 100X80 cm

- particolarmente indicato per l'utilizzo sotto smontagomme per moto BETA 3071 e 3071B
- facile da pulire, fondo gommato e antiscivolo



9562T1
L cm 100
H cm 80

1 095620150

9562T3

tappeto da officina 300x160 cm

- particolarmente indicato per l'utilizzo sotto ponti sollevatori moto
- protegge il suolo da perdite d'olio, benzina e rispetta l'ambiente
- facile da pulire, fondo gommato e antiscivolo



9562T3
L cm 300
H cm 160

1 095620300

9562P2

tappeto con logo BETA 200x80 cm

- particolarmente indicato per utilizzi con arredo officina C55, C45 o come tappeto sottomoto
- protegge il suolo da perdite d'olio, benzina e rispetta l'ambiente
- facile da pulire, fondo gommato ed antiscivolo



9562P2
L cm 200
H cm 80

1 095620400

9562P12

rotolo tappeto multi logo 12 m x 80 cm

- permette di personalizzare la lunghezza del tappeto in base alle esigenze dell'utilizzatore
- protegge il suolo da perdite d'olio, benzina e rispetta l'ambiente
- facile da pulire, fondo gommato ed antiscivolo



9562P12
L m 12
H cm 80

1 095620425



SERVIZIO DI TARATURA DINAMOMETRIA

Beta Utensili SpA dispone di attrezzature certificate **Accredia (LAT)** per la taratura di chiavi dinamometriche fino a 2000 Nm, in conformità alla norma **UNI EN ISO 6789:2017**.

Presso il Laboratorio Beta è possibile eseguire la calibrazione dei seguenti articoli:



Chiavi a slittamento, a disinnesto o scatto



Chiavi non graduate



Chiavi a lettura



Chiavi digitali



Giravite dinamometrici



Dynatester

Per alcune chiavi dinamometriche è possibile richiedere la certificazione destrorsa, sinistrorsa o entrambe. La norma prevede un controllo su tre punti con cinque campionamenti per punto.

E' possibile inoltre richiedere certificazioni Accredia di chiavi e Dynatester, sarà nostra cura verificarle e mandarle al centro accreditato che rilascerà il certificato.

La validità dei certificati, secondo quanto previsto dalla norma UNI EN ISO 6789 è pari a 5.000 cicli oppure un anno. Sulle chiavi nuove la validità del certificato parte dal primo utilizzo.

Beta Utensili S.p.A.
Via Volta 18 - 20845 Sovico (MB) Italy
Tel +39 039 201711 - Fax +39 039 2513742
www.beta-tools.com - e-mail: info@beta-

CERTIFICATE OF CALIBRATION
L'utensile dinamometrico identificato in questo documento è conforme alla norma **ISO 6789-2:2017**
The torque tool identified in this document is declared to be in conformance with: **ISO 6789-2:2017**

Modello: **666N/2** Seriale: **7910828478**
Model: Serial number:

Campo di applicazione: **5,0 + 25,0 N m**
Torque range:

Temperatura: **20,0°C** Umidità relativa: **< 90%**
Temperature Relative humidity:

I valori osservati rientrano nel ±3% del valore di misura dichiarato dal costruttore.
The observed values fall within the maximum ±3% measurement error claimed by the manufacturer.

Valore impostato Set Torque N m	Valori riscontrati Claimed Value Sensa orario Declared torque N m					Valore medio Mean Value N m	Incertezza relativa estesa Relative Uncertainty (k=2)	Intervallo incertezza relativa Standard Interval (k=2)
5.0	5.055	5.010	4.993	5.017	4.973	5.010	2,95%	3,24%
15.0	15.006	14.958	14.936	14.975	14.906	14.956	1,01%	3,24%
25.0	25.190	25.141	25.166	25.132	25.119	25.150	0,61%	1,31%

La strumentazione utilizzata per la calibrazione ha una rintracciabilità internazionale attraverso il seguente laboratorio di calibrazione che è accreditato secondo la ISO 17025:2005.
The test equipment used in the performance of the above calibration has international traceability through the following calibration laboratory which is UKAS accredited to ISO 17025:2005.

Modello Tester: **FMT 60** Seriale: **107078**
Tester Model: Serial Number:

Certificato n°: **226343** UKAS Laboratorio n°: **0256**
Cert No: UKAS Laboratory No:

La strumentazione ha un errore relativo di max 0.10% e un intervallo di incertezza relativa di 0.28%. Il massimo errore relativo misurato è inferiore a ¼ della massima deviazione permessa sull'utensile.
The torque measurement device has a maximum relative error of 0.10% and a relative measurement uncertainty interval of 0.28%. The measured relative error is therefore less than ¼ of the maximum permissible relative deviation of the torque tool.

Data: **16 April 2018** Responsabile: **F. Sacchet**
Date: Responsible Person:

Per usufruire di questo servizio rivolgiti al tuo rivenditore di fiducia

ARTICOLI ELIMINATI - ARTICOLI SOSTITUTIVI/CONSIGLIATI

	ARTICOLO ELIMINATO
	ARTICOLO SOSTITUTIVO
	ARTICOLO CONSIGLIATO

96AS/G7	000960745		
111 100	001110010	111E 100	001110110
111 150	001110015	111E 150	001110115
111 200	001110020	111E 200	001110120
111 250	001110025	111E 250	001110125
111 300	001110030	111E 300	001110130
111 380	001110038	111E 380	001110138
111 450	001110045	111E 450	001110145
111 600	001110060	111E 600	001110160
111N 100	001110210	111EN 100	001110410
111N 150	001110215	111EN 150	001110415
111N 200	001110220	111EN 200	001110420
111N 250	001110225	111EN 250	001110425
111N 300	001110230	111EN 300	001110430
111N 380	001110238	111EN 380	001110438
111N 450	001110245	111EN 450	001110445
111G 200	001110620	111CM 170	001110770
111G 250	001110625	111CM 220	001110722
111G 300	001110630	111CM 270	001110727
111HS 200	001114020	111E-HS 200	001114120
111HS 250	001114025	111E-HS 250	001114125
111HS 300	001114030	111E-HS 300	001114130
111HS 380	001114038	111E-HS 380	001114138
111HS 450	001114045	111E-HS 450	001114145
111K 100	001119010		
111K 150	001119015		
111K 200	001119020		
111K 250	001119025		
111K 300	001119030		
410/SPV1	004100420	410/SPVP1	004100421
410/SPV2	004100426	410/SPVP2	004100427
412/SPV1	004120420	410/SPVP1	004100421
412/SPV2	004120426	410/SPVP2	004100427
414/SPV1	004140420	410/SPVP1	004100421
414/SPV2	004140426	410/SPVP2	004100427
415/SPV1	004150420	410/SPVP1	004100421
415/SPV2	004150426	410/SPVP2	004100427
442 22	004420022		
442 24	004420024		
564-3R/VA	005640603	564-3R/V	005640613
564-4R/VA	005640604	564-4R/V	005640614
588	005880001	680/3	006800000
677/50	006770050	677/600	006770006
677/70	006770070	677/800	006770008
677/100	006770100	677/1000	006770010
677/CV1	006770450	677/CVN1	006770455
677/C50	006770606	677/C600	006770607

677/C70	006770611	677/C800	006770612
677/C100	006770615	677/C1000	006770616
677/C150	006770620	677/C1500	006770621
677/CP200	006770720	677/CP2000	006770721
680/2,5	006800002	680/30	006800003
680/40	006800040	680/350	006800035
680/100	006800100	680/2100	006800210
920/55L	009200927		
970OT 65	009700165		
970OT 80	009700180		
970OT 96	009700196		
970OT 111	009700211		
970EA 98	009700398		
970EB 110	009700410		
970EB 95	009700595		
970Q 56	009700756		
970Q 60	009700760		
970C 80	009700808		
970C 95	009700815		
970C 100	009700820		
970C 109	009700829		
970C 115	009700835		
970C 120	009700840		
1046 240	010460240	1044F 250	010440015
1046 400	010460400		
1046K 240	010469240	1044FK 250	010449015
1048 175	010480010	1048N 175	010480910
1048 250	010480015	1048N 250	010480915
1048 300	010480020	1048N 300	010480920
1048V 175	010480110	1048VN 175	010480111
1048V 250	010480115	1048VN 250	010480116
1048V 300	010480120	1048VN 300	010480121
1048K 175	010489010	1048NK 175	010489910
1048VK 250	010489025	1048VNK 250	010489116
1048VK 175	010489110	1048VNK 175	010489111
1048K 250	010489250	1048NK 250	010489915
1309	013090001		
1313	013130001		
1362	013620010	1362B	013620011
1450GC	014500005		
1461/C3B	014610032		
1461/C8G	014610084		
1461/C10G	014610103		
1461/C11G	014610113		
1461/C12G	014610124		
1461/C13A	014610133		
1461/C17B	014610171		
1461/C22B	014610223		
1461/C31B	014610232		

1473Q	014730005		
1498MN/12	014980000	1498BC/12	014980040
1569/A	015690011	1569/SB	015690016
1569/B	015690015	1569/SB	015690017
1590 75	015900307		
1590 125	015900312		
1640K	016400001		
1640T 22,5	016400022		
1640T 25,5	016400025		
1640T 32,5	016400032		
1640T 55,5	016400055		
1640Q 45	016400065		
1640A	016400080		
1640P/9	016400088		
1640P/19	016400089		
1640	016400100		
1651DGT 150	016510111	1651DGTB 150	016510211
1651DGT 200	016510112	1651DGTB 200	016510212
1651DGT/IP	016510611	1651DGTB/IP	016510711
1658DGT25	016580325	1658DGTB 25	016580525
1658DGT50	016580350	1658DGTB 50	016580550
1729	017290001		
1729LR	017290010		
1751 200	017510002	1751N 200	017510020
1751 300	017510003	1751N 300	017510030
1751 500	017510005	1751N 500	017510050
1751 750	017510007	1751N 750	017510075
1751R	017510010	1751NR	017510110
1751 1000	017510011	1751N 1000	017510100
1778D	017780060	1778P	017780088
1778U	017780070	1778AN	017780065
1836A	018360050	1836AW	018360051
1838SL	018380101		
1838S	018380122	1838SW	018380142
1860 160A	018600006	1860BHT/160A	018600179
1860RC/140A	018600604		
1860RC/160A	018600606		
1937 2,5	019370000		
1947M	019470021	1947H	019470011
1947M-ST	019470025		
1947M-T	019470026		
1947M-P	019470027		
1949F	019490027	1949F2	019490028
1949G	019490035		
2029/RT	020290900	C9/RT	021090900
2060/VV	020600101		
2200-COVER RSC22	022000910		
2251-O	022510011		
2252-O	022520001		
2252-R	022520003		

ARTICOLI ELIMINATI - ARTICOLI SOSTITUTIVI/CONSIGLIATI

	ARTICOLO ELIMINATO
	ARTICOLO SOSTITUTIVO
	ARTICOLO CONSIGLIATO

2300-COVER RSC23	023000920		
2300-COVER RSC23T	023000930		
TV110	024000477		
T56	024240056		
T110	024240110	T111	024240111
TV56	024249901		
M199	024500199	M201	024500201
M202	024500202	M201	024500201
MV130	024510130		
MV153	024510153		
MV199	024510199		
MV202	024510202		
MV292	024510292		
MV165	024510874		
MBV11	024524211		
MBV34	024524234		
MMV140	024590140		
MCV20	027510020		
3000M/RLS	030000206	3000L/RLS	030000212
3000M/LT	030000220	3000L	030000210
C35/6G	035000062	C35/6GM	035000162
C35/7G	035000072	C35/7GM	035000172
C35/8G	035000082	C35/8GM	035000182
C35/9G	035000092	C35/9GM	035000192
3500/P	035000502		
4100-COVER C41H	041000930		
C43	043000003	C42H	042000002
C45PRO PA	045000280	C45PRO PAS	045000290
C50S-O	050000301	RSC51-FO	051000300
C50S-G	050000302	RSC51-A	051000307
C50S-R	050000303	RSC51-R	051000303
5000MS	050000901	2400 RSC24/MP	024004900
C59A-O	059000001	C59A-O	059000011
C59B-O	059000002	C59B-O	059000012
C59C-O	059000003	C59C-O	059000013
C59A-G	059000021	C59A-A	059000031
C59B-G	059000022	C59B-A	059000032
C59C-G	059000023	C59C-A	059000033
C59A-R	059000041	C59A-R	059000051
C59B-R	059000042	C59B-R	059000052
C59C-R	059000043	C59C-R	059000053
5904VU/2M	059041202	5904VU/2M	059041212
7051MP	070510001		
7212FG 35	072120035	7212G 35	072120335
7212FG 36	072120036	7212G 36	072120336
7212FG 37	072120037	7212G 37	072120337
7212FG 38	072120038	7212G 38	072120338

7212FG 39	072120039	7212G 39	072120339
7212FG 40	072120040	7212G 40	072120340
7212FG 41	072120041	7212G 41	072120341
7212FG 42	072120042	7212G 42	072120342
7212FG 43	072120043	7212G 43	072120343
7212FG 44	072120044	7212G 44	072120344
7212FG 45	072120045	7212G 45	072120345
7212FG 46	072120046	7212G 46	072120346
7212FG 47	072120047	7212G 47	072120347
7212FG 48	072120048	7212G 48	072120348
7213FG 35	072130035	7213G 35	072130135
7213FG 36	072130036	7213G 36	072130136
7213FG 37	072130037	7213G 37	072130137
7213FG 38	072130038	7213G 38	072130138
7213FG 39	072130039	7213G 39	072130139
7213FG 40	072130040	7213G 40	072130140
7213FG 41	072130041	7213G 41	072130141
7213FG 42	072130042	7213G 42	072130142
7213FG 43	072130043	7213G 43	072130143
7213FG 44	072130044	7213G 44	072130144
7213FG 45	072130045	7213G 45	072130145
7213FG 46	072130046	7213G 46	072130146
7213FG 47	072130047	7213G 47	072130147
7213FG 48	072130048	7213G 48	072130148
7217FG 35	072170235	7212B 35	072120235
7217FG 36	072170236	7212B 36	072120236
7217FG 37	072170237	7212B 37	072120237
7217FG 38	072170238	7212B 38	072120238
7217FG 39	072170239	7212B 39	072120239
7217FG 40	072170240	7212B 40	072120240
7217FG 41	072170241	7212B 41	072120241
7217FG 42	072170242	7212B 42	072120242
7217FG 43	072170243	7212B 43	072120243
7217FG 44	072170244	7212B 44	072120244
7217FG 45	072170245	7212B 45	072120245
7217FG 46	072170246	7212B 46	072120246
7217FG 47	072170247	7212B 47	072120247
7217FG 48	072170248	7212B 48	072120248
7219FY 35	072190035	7214G 35	072140235
7219FY 36	072190036	7214G 36	072140236
7219FY 37	072190037	7214G 37	072140237
7219FY 38	072190038	7214G 38	072140238
7219FY 39	072190039	7214G 39	072140239
7219FY 40	072190040	7214G 40	072140240
7219FY 41	072190041	7214G 41	072140241
7219FY 42	072190042	7214G 42	072140242
7219FY 43	072190043	7214G 43	072140243
7219FY 44	072190044	7214G 44	072140244
7219FY 45	072190045	7214G 45	072140245
7219FY 46	072190046	7214G 46	072140246
7219FY 47	072190047	7214G 47	072140247

7219FY 48	072190048	7214G 48	072140248
7328EA 38	073280538	7328A 38	073280638
7328EA 39	073280539	7328A 39	073280639
7328EA 40	073280540	7328A 40	073280640
7328EA 41	073280541	7328A 41	073280641
7328EA 42	073280542	7328A 42	073280642
7328EA 43	073280543	7328A 43	073280643
7328EA 44	073280544	7328A 44	073280644
7328EA 45	073280545	7328A 45	073280645
7328EA 46	073280546	7328A 46	073280646
7328EA 47	073280547	7328A 47	073280647
7328EN 38	073280738	7328N 38	073280838
7328EN 39	073280739	7328N 39	073280839
7328EN 40	073280740	7328N 40	073280840
7328EN 41	073280741	7328N 41	073280841
7328EN 42	073280742	7328N 42	073280842
7328EN 43	073280743	7328N 43	073280843
7328EN 44	073280744	7328N 44	073280844
7328EN 45	073280745	7328N 45	073280845
7328EN 46	073280746	7328N 46	073280846
7328EN 47	073280747	7328N 47	073280847
7340R 36	073400436		
7340R 37	073400437		
7340R 38	073400438		
7340R 39	073400439		
7340R 40	073400440		
7340R 41	073400441		
7340R 42	073400442		
7340R 43	073400443		
7340R 44	073400444		
7340R 45	073400445		
7340R 46	073400446		
7340R 47	073400447		
7525 XS	075250046	7530 XS	075300046
7525 S	075250048	7530 S	075300048
7525 M	075250050	7530 M	075300050
7525 L	075250052	7530 L	075300052
7525 XL	075250054	7530 XL	075300054
7525 XXL	075250056	7530 XXL	075300056
7525 XXXL	075250058	7530 XXXL	075300058
7579T S	075790001	7579QN S	075790201
7579T M	075790002	7579QN M	075790202
7579T L	075790003	7579QN L	075790203
7579T XL	075790004	7579QN XL	075790204
7579T XXL	075790005	7579QN XXL	075790205
7579T XXXL	075790006	7579QN XXXL	075790206
7634G XS	076340100	7637G XS	076370000
7634G S	076340101	7637G S	076370001
7634G M	076340102	7637G M	076370002
7634G L	076340103	7637G L	076370003
7634G XL	076340104	7637G XL	076370004

ARTICOLI ELIMINATI - ARTICOLI SOSTITUTIVI/CONSIGLIATI

	ARTICOLO ELIMINATO
	ARTICOLO SOSTITUTIVO
	ARTICOLO CONSIGLIATO

7634G XXL	076340105	7637G XXL	076370005
7634G XXXL	076340106	7637G XXXL	076370006
7634B XS	076340200		
7634B S	076340201		
7634B M	076340202		
7634B L	076340203		
7634B XL	076340204		
7634B XXL	076340205		
7634B XXXL	076340206		
7780T S	077800101	7780QN S	077800201
7780T M	077800102	7780QN M	077800202
7780T L	077800103	7780QN L	077800203
7780T XL	077800104	7780QN XL	077800204
7780T XXL	077800105	7780QN XXL	077800205
7780T XXXL	077800106	7780QN XXXL	077800206
7810 S	078100101	7600G S	076000001
7810 M	078100102	7600G M	076000002
7810 L	078100103	7600G L	076000003
7810 XL	078100104	7600G XL	076000004
7810 XXL	078100105	7600G XXL	076000005
7812 S	078120001	7610G S	076100001
7812 M	078120002	7610G M	076100002
7812 L	078120003	7610G L	076100003
7812 XL	078120004	7610G XL	076100004
7812 XXL	078120005	7610G XXL	076100005
7813 S	078130001	7611G S	076110001
7813 M	078130002	7611G M	076110002
7813 L	078130003	7611G L	076110003
7813 XL	078130004	7611G XL	076110004
7813 XXL	078130005	7611G XXL	076110005
7816G XS	078160000	7818G XS	078180000
7816G S	078160001	7818G S	078180001
7816G M	078160002	7818G M	078180002
7816G L	078160003	7818G L	078180003
7816G XL	078160004	7818G XL	078180004
7816G XXL	078160005	7818G XXL	078180005
7816G XXXL	078160006	7818G XXXL	078180006
7816BL XS	078160100	7818BL XS	078180100
7816BL S	078160101	7818BL S	078180101
7816BL M	078160102	7818BL M	078180102
7816BL L	078160103	7818BL L	078180103
7816BL XL	078160104	7818BL XL	078180104
7816BL XXL	078160105	7818BL XXL	078180105
7816BL XXXL	078160106	7818BL XXXL	078180106
7817N S	078170101	7600N S	076000101
7817N M	078170102	7600N M	076000102
7817N L	078170103	7600N L	076000103

7817N XL	078170104	7600N XL	076000104
7817N XXL	078170105	7600N XXL	076000105
7819B S	078190101	7610N S	076100101
7819B M	078190102	7610N M	076100102
7819B L	078190103	7610N L	076100103
7819B XL	078190104	7610N XL	076100104
7819B XXL	078190105	7610N XXL	076100105
8021 3	080210003	8021A 3	080210103
8021 5	080210005	8021A 5	080210105
8021 6	080210006	8021A 6	080210106
8021 8	080210008	8021A 8	080210108
8021 10	080210010	8021A 10	080210110
8021 12	080210012	8021A 12	080210112
8021 14	080210014	8021A 14	080210114
8021 16	080210016	8021A 16	080210116
8021 18	080210018	8021A 18	080210118
8021 20	080210020	8021A 20	080210120
8021 22	080210022	8021A 22	080210122
8021 24	080210024	8021A 24	080210124
8021 26	080210026	8021A 26	080210126
8021 28	080210028	8021A 28	080210128
8021 30	080210030	8021A 30	080210130
8021 32	080210032	8021A 32	080210132
8021 35	080210035	8021A 35	080210135
8041 M16	080410216	8041HP M16	080410217
8041 M20	080410220	8041HP M20	080410221
8043 M16	080430216	8043HP M16	080430217
8043 M24	080430224	8043HP M24	080430225
8050D29	080500974		
8057 5,3	080570053	8057R 5,3	080570153
8058 8,0	080580080	8058 8,0	080580180
8060 8	080600080	8060R 8000	080600180
8061F 8	080610180	8061R 8,0	080610280
8085 8,0	080850080	8085 8,0	080850280
8085 11,2	080850190	8085 11,2	080850311
8090 8,0	080900080	8090 8,0	080900180
8131Z 6X800	081310068		
8131Z 8X1000	081310081		
8131Z 8X1200	081310082		
8131Z 10X1500	081310105		
8135/KLA 0,75	081350905	8135/KLA1 0,75	081350605
8135/KLA 0,75	081350905	8135/KCA 0,75	081350630
8135/KLA 0,75	081350905	8135/KMO 0,75	081350655
8135/KLA 1,0	081350910	8135/KLA1 1,0	081350610
8135/KLA 1,0	081350910	8135/KCA 1,0	081350635
8135/KLA 1,0	081350910	8135/KMO 1,0	081350660
8135/KLA 2,0	081350920	8135/KLA1 2,0	081350615
8135/KLA 2,0	081350920	8135/KCA 2,0	081350640
8135/KLA 2,0	081350920	8135/KMO 2,0	081350665
8135/KLA 3,0	081350930	8135/KLA1 3,0	081350620
8135/KLA 3,0	081350930	8135/KCA 3,0	081350645
8135/KLA 3,0	081350930	8135/KMO 3,0	081350670

8135/KLA 5,0	081350950	8135/KLA1 5,0	081350625
8135/KLA 5,0	081350950	8135/KCA 5,0	081350650
8135/KLA 5,0	081350950	8135/KMO 5,0	081350675
8139Z 10	081390009		
8143/RK 0,5	081430905	8143/RKL 0,5	081430500
8143/RK 0,5	081430905	8143/RPC 0,5	081430510
8143/RK 0,5	081430905	8143/RPF 0,5	081430520
8143/RK 1,0	081430915	8143/RKL 1,0	081430501
8143/RK 1,0	081430915	8143/RPC 1,0	081430511
8143/RK 1,0	081430915	8143/RPF 1,0	081430521
8143/RK 2,0	081430920	8143/RKL 2,0	081430502
8143/RK 2,0	081430920	8143/RPC 2,0	081430512
8143/RK 2,0	081430920	8143/RPF 2,0	081430522
8143/RK 3,0	081430930	8143/RKL 3,0	081430503
8143/RK 3,0	081430930	8143/RPC 3,0	081430513
8143/RK 3,0	081430930	8143/RPF 3,0	081430523
8143/RK 5,0	081430950	8143/RKL 5,0	081430504
8143/RK 5,0	081430950	8143/RPC 5,0	081430514
8143/RK 5,0	081430950	8143/RPF 5,0	081430524
8146/RK 0,75	081460908	8146/RKL 0,75	081460500
8146/RK 0,75	081460908	8146/RPC 0,75	081460510
8146/RK 0,75	081460908	8146/RKFC 0,75	081460520
8146/RK 1,5	081460915	8146/RKL 1,5	081460501
8146/RK 1,5	081460915	8146/RPC 1,5	081460511
8146/RK 1,5	081460915	8146/RKFC 1,5	081460521
8146/RK 3,0	081460930	8146/RKL 3,0	081460502
8146/RK 3,0	081460930	8146/RPC 3,0	081460512
8146/RK 3,0	081460930	8146/RKFC 3,0	081460522
8146/RK 6,0	081460960	8146/RKL 6,0	081460503
8146/RK 6,0	081460960	8146/RPC 6,0	081460513
8146/RK 6,0	081460960	8146/RKFC 6,0	081460523
9557J 3.0	095570030		
9577M S	095770051	9577R S	095770151
9577M M	095770052	9577R M	095770152
9577M L	095770053	9577R L	095770153
9577M XL	095770054	9577R XL	095770154
9811L T100 (1-2)	098110510		
9811L T100 (3)	098112510		
9812M T100 (1-2)	098120510		
9812M T100 (3)	098122510		
9813H T100 (1-2)	098130510		
9813H T100 (3)	098132510		
9821L T100 (1-2)	098210510		
9821L T100 (3)	098212510		
9822M T100 (1-2)	098220510		
9822M T100 (3)	098222510		
9823H T100 (1-2)	098230510		
9823H T100 (3)	098232510		
9851 500 (1-2)	098510050		
9851 500 (3)	098512050		
11050 180X7	110500180		

Abbigliamento da lavoro	612÷630
Accessori per funi Robur	631÷671
Accessori Inox per funi	658÷663
Accessori portautensili per armadietti, cassetti e pareti	518÷520
Aerografi	337
Argani manuali e accessori	652÷658
Armadi per officina	420÷422,439
Armadietti portautensili	390, 419
Arredamento Officina	398÷440
Artigli prensili flessibili	222
Ascia antiscintilla	314
Aspiratore per liquidi	259
Aspiratori per solidi e liquidi	256-257
Assortimenti di utensili	441÷492
Assortimenti utensili in moduli	494÷517
Attrezzi per il ripristino delle filettature	46-47
Autoriparazione	117÷126, 160÷166, 170÷211, 231÷239
Avvolgicavo automatici con portalamпада	248÷250
Avvolgitubo automatici per aria/acqua	337
Banchi da lavoro	389,391-392,394÷397,402÷404, 407, 430-431,
Barre dinamometriche	62, 67÷69
Bauli portautensili	349, 351
Beta Abrasives	527÷543
Beta BM	547÷553
Beta Chemicals	521÷526
Beta Collection	672÷683
Bloccante	523
Bordatubi	32-33
Borse portautensili	333, 336÷338
Bulini	10
Cacciaspina	9, 306, 509
Calibratore per tubi multistrato	31
Calibri a corsoio	213-214
Carrello contenitore elettrico	386
Carrello pieghevole	355, 375
Carrelli portautensili	368÷370,385, 387-388, 413, 435
Carrello porta cassettiere	358
Cartelli di avvertenza e divieto	629
Cassettiere mobili	360÷368, 374÷381, 408-409, 431
Cassettiere per industria	357÷359, 372-373, 377-378, 382,
Cassettiere portatili	357÷359, 372-373, 377-378, 382,
Catene e colonnine in plastica di delimitazione	628
Cesoie	136-137
Cesoie a cricchetto per tubi PVC	30
Cestelli portautensili	348÷351
Chiavi a bussola con impugnatura	113-114, 291, 570
Chiavi a bussola Macchina, accessori e assortimenti	70÷74
Chiavi a bussola snodate doppie	15, 496,
Chiavi a bussola, accessori e assortimenti 1/4"	86÷93
Chiavi a bussola, accessori e assortimenti 3/8"	93÷98, 289-290, 309
Chiavi a bussola, accessori e assortimenti 1/2"	99÷108, 290-291, 303, 310
Chiavi a bussola, accessori e assortimenti 3/4"	108-109, 310-311
Chiavi a bussola, accessori e assortimenti 1"	109-110
Chiavi a cricchetto	25÷27, 296
Chiavi a forchetta	14-15, 289, 295, 307
Chiavi a percussione	14-15, 307-308
Chiavi a pipa	112-113, 296, 311



Chiavi a settore	23-24, 64, 309
Chiavi a T con bussola esagonale e Torx®	115÷117
Chiavi a T maschio esagonale e Torx®	115÷117, 291, 311
Chiavi a tubo	111-112
Chiavi a zampa di gallo	96
Chiavi combinate	11÷13, 25-26, 296, 302, 307
Chiavi di manovra antiscintilla per valvole	307÷311
Chiavi e barre dinamometriche	60÷69, 289, 296
Chiavi maschio esagonale e Torx® con impugnatura	21÷23, 191, 295, 303,
Chiavi maschio esagonale e Torx®, piegate	18-23
Chiavi maschio piegate a profilo XZN®	23
Chiavi per ponteggi	17, 308
Chiavi per quadristi	213
Chiavi per raccordi	17
Chiavi poligonali	15,÷17, 289, 295, 307-308
Chiavi regolabili a rullino	24, 63, 289, 295, 303, 309
Colla istantanea	524
Coltelli	241, 293, 314,
Combo valigette e accessori	352÷356
Comparatori	215
Compassi	216-217
Compressori a leva per grasso	229
Contafiletti	221
Contalitri per olio	259
Curvatubi	34-35
Cuscino sollevatore	242
Cutter	240
Deghiacciante	526
Detergenti	525-526
Dischi abrasivi	529÷531, 542
Dischi lamellari	535÷539
Dischi magnetici solleva lamiere per saldatura	255
Estrattori a due griffe	201÷205, 211
Estrattori a tre griffe	202÷205, 211
Estrattori coni Morse	44
Estrattori idraulici	211
Estrattori per mozzi ruote	205-206
Estrattori per viti e prigionieri danneggiati	170-171
Estrattori vari	201÷211
Faretti	245
Fasce e funi per sollevamento	664÷667
Fascette	550÷553
Fascette in velcro	552
Filiere e assortimenti	47÷51
Flessibili magnetici	221
Flessometri e metri	218
Forbici	138, 242, 314
Forbici per elettricisti	137-138, 291, 297
Frenafili	522
Frese coniche	41-42
Fustelle	135-136
Gamma blister	554÷568
Giramaschi e girafiliera	46, 49
Giratubi	33-34, 296, 303, 309
Giravite a battere	149-150
Giravite a percussione	158-159
Giravite a squadra	149
Giravite BetaEVOX	146÷148



Giravite BetaGrip	152÷155, 292-293
Giravite BetamaX	157÷159, 304, 312
Giravite bivalenti	155-156
Giravite cercafase	150
Giravite dinamometrici	60
Giravite prensili	150
Golfari	640÷643
Goniometri per serraggi angolari	61
Goniometri semplici	216
Grasso spray	524-525
Grilli per sollevamento	639-640,655
Guanti isolanti	293
Guarnizione liquida	523
Guaine isolanti	553
Idraulica, vari	28÷35
Ingrassatore a leva	230
Inserti per avvitatori e portainseriti	25, 78÷85, 150-151, 155, 289
Impermeabilizzante	526
Lampade	244÷248
Leve	123, 221, 311
Lime	161, 223÷226, 314
Livelle e stadie	219-220
Magnetizzatore-smagnetizzatore	145
Martelli	162, 166÷168, 312, 298-299, 304
Martinetto idraulico	211
Maschera per saldatura	255-256
Mascherina antipolvere	629
Maschi e assortimenti	43÷45
Matita per falegnami	218
Mazze	169, 313
Mazzette	169, 313
Mazzuole	169-170, 299, 313,
Microgiravite	151
Micrometri	214
Misuratori ambientali	237-238
Misuratori di coppia elettronici Dynatester	70
Misuratori laser	218
Moduli portautensili	493÷518
Mole abrasive con gambo	532÷535
Moltiplicatori di coppia	55-56
Morse magnetiche per saldatura	255
Morse parallele da banco	212
Morse ribaltabili da banco, per idraulica	35
Morsetti	212
Morsetti di coda	549
Morsetti per funi	637-638
Multimetri	234-235
Nastro isolante	553
Occhiali di protezione	629
Oliatori	230-231
Pala antiscintilla	314
Paranchi manuali e accessori	650÷652
Pareti portautensili	365, 376, 393, 414, 416-417,436-437
Pedana rialzata	239
Pendenti di catena per sollevamento	644÷650
Pennello	227
Piccone antiscintilla	314



Pinza foralamiera	133
Pinza fustellatrice	238
Pinza piegalamiera	133
Pinze a becchi lunghi e lunghissimi	128, 140÷144, 292, 298, 311
Pinze amperometriche	235-236
Pinze autobloccanti	131÷133, 297, 303
Pinze per anelli elastici di sicurezza	129-130, 173, 209, 296-297, 311
Pinze per capicorda e capicorda	544÷546
Pinze per elettronica	143-144
Pinze per fascette	552
Pinze per saldatura	255
Pinze per sollevamento lamiere	649
Pinze regolabili	130-132, 140-141, 184, 297, 303, 312,
Pinze torcifilo	238
Pinze universali	140-141, 292, 298, 303, 312
Pinzette a molla	126÷128, 291
Pistola per olio	259
Pistole per colla	250
Pistole per sigillanti	229
Pistole termiche	250
Polifusori e matrici	28
Pompa oleodinamica	163
Pompe per barili	259
Pompette per dissaldare	254
Porta attrezzi con cintura	344
Portacarta	365
Portaflaconi	365-366
Portaminuterie magnetici	239
Postazione di lavoro mobile	371
Prodotti elettrici	544÷553
Protezioni per cassettiere	381
Provatensione	237
Pulitore spray	525-526
Punte elicoidali cilindriche per forare	36÷42
Punte per forare, filettare e svasare	47
Punte per tracciare	217-218
Punte speciali per saldature	41
Punteruoli	222
Punzoni	9, 306
Radance	638
Raggimetri	221
Rapportatore d'angoli	216
Raschietti	173, 186, 222, 240, 314
Righe graduate	217, 299
Rinvio angolare	84
Ripara plastiche	166
Rivettatrici e rivetti	227÷229
Rotoli antispreco	543
Ruote lamellari e in tessuto	540÷542
Saldatori	253-254
Saldatrici	254-255
Sbavatori per tubi	31
Sbloccante spray	524
Scalpelli	10, 294, 302, 306, 314
Scalpelli per carrozzieri	126, 161
Scalpelli per edilizia	220
Scarpe antinfortunistiche	583÷611
Segaccio per legno	226



Seggiolini con rotelle	265÷267
Seghe e frese a tazza e accessori	51÷53
Seghetti e lame	226
Serraggiunti e stretto	212
Sigillaraccordi	522
Silicone sigillante	524
Silicone spray	525
Siringa per olio	231
Sistemi di ancoraggio	663, 667÷670
Soluzioni per il punto vendita	569÷582, 629-630
Sollevatori per bici	283
Sonda tirafili	546
Spaccadadi	221
Spatole	226, 314
Spazzole	227, 314
Specchietti	222
Spellacavi e spellafili	139-140
Spessimetri	221
Squadre	215-216
Squadre magnetiche per saldatori	255
Supporto per avvitatore pneumatico	324
Tachimetro digitale	236
Tagliacavi	139, 291
Tagliafuni di acciaio	135
Tagliatubi	28÷30, 32, 309
Tappeto da lavoro	266, 278, 293, 397, 652
Tappeto isolante	293
Tappeto protezione ginocchia	266
Tenaglie	134-135
Tenditori per funi e accessori	632÷637
Tenditore per molle	226
Terminali preisolati	548
Termocamera	237
Termometri	237
Termopiastre per tubi plastici	28
Torçe	243-244
Traccialinea e polvere	221
Trolley portautensili	345-346, 348-349, 383-38
Troncabulloni	135
Tronchesi a taglienti diagonali e frontali	133-134
Tronchesi per elettronica	144-145
Ugnetti	10
Utensili a batteria	315
Utensili anticaduta	294÷300
Utensili antiscintilla	306÷314
Utensili in acciaio inossidabile	301÷305
Utensili isolati 1000V	287÷293
Utensili per biciclette	282÷286
Utensili per motocicli	276÷281
Utensili pneumatici ed accessori	318÷340
Valigie portautensili	342÷346, 352÷355
Vasca di lavaggio ad ultrasuoni	263-264
Ventose	238
Videoscopio elettronico	123
Zaini portautensili	347-348
Zinco spray	526

Automotive



Alesatori per sedi iniettori	122
Aspiratore di vapori iniettori Diesel	122
Asta telescopica	239
Attrezzi per centraggio frizioni	172
Attrezzi per estrazione autoradio	238
Attrezzi per pistoni	173
Attrezzi per pulegge distribuzione	177
Attrezzi per rimozione cristalli	238
Attrezzi per sostituzione piattelli valvole	180
Attrezzi per tubi scarico	184
Attrezzo levabolli	162-163
Attrezzo per pistoncini freni a disco	181
Attrezzo per smagliatura catene	280
Avviatori	198
Barre di torsione per dadi ruote	77
Calibri a corsoio per dischi e tamburi freni	73
Calibro per battistrada pneumatici	221
Caricabatteria	198÷200
Carrello per cambi/trasmissioni	388
Carrello per movimentazione veicoli	268
Carrello sottoscocca	268
Cavalletti	268
Cavalletti per moto	277
Chiave per braccetti sterzo	210
Chiave per turbine	184
Chiavi a bussola Macchina per dadi ruote	72-73
Chiavi a bussola Macchina quadre per dadi ruote Isuzu	76
Chiavi a bussola per dadi mozzi ruote	124
Chiavi a bussola per iniettori Diesel	118-119
Chiavi a bussola per perni balestre	209
Chiavi a bussola per sonda Lambda	119
Chiavi a croce per dadi ruote	124
Chiavi e bussole per candele d'accensione	118
Chiavi per filtri gasolio	193
Chiavi per filtri olio motore	190÷193
Chiavi per ghiera galleggiante serbatoio	187
Chiavi per raccordi carburante	176
Chiavi per sensori di temperatura	120
Chiavi per tappi scarico olio motore	194-195
Chiavi per valvole metano	189-190
Densimetro per liquido anticongelante	233
Densimetro per liquido batteria	233
Estrattore per raschiavetri	239

INDICE ALFABETICO UTENSILI PER AUTORIPARAZIONE



Estrattori per giunti omocinetici	210
Estrattori per pioli	185
Estrattori per snodi sferici	210
Fustelle per sensori parcheggio	165
Gru idraulica pieghevole	270
Imbuto	232, 314
Inseritori a percussione per cuscinetti conici e paraoli	211
Lamina modellabile in alluminio	232
Lavaggio auto interni/esterni	256-257, 265
Lettini sottomacchina	266-267
Leva per cambio DSG	172
Leva per estrazione testine braccio oscillante	210
Levagomme	123, 285
Leve per carrozzieri	161
Lime per carrozzieri	161
Martelli per carrozzieri	162
Messa in fase	173-176
Morsetti alzavalvola	162
Perni guida montaggio ruote	125
Attrezzi verifica bolli carrozzeria ø 80	163
Pinza per anelli di tenuta valvole	173
Pinza per anelli elastici di sicurezza SP	173
Pinza per copertura plastiche delle ruote	125
Pinza per equilibratura ruote	126
Pinza per graffette	238
Pinze per anelli stringitubo	182-183
Pinze per cappucci candele	184
Pinze per freni	180
Pinze per occlusione tubi e manicotti	187
Pinze per raccordi rapidi tubi carburante	187
Pinze per relè	195-196
Pistola per gonfiaggio pneumatici	336
Pompa per taratura e controllo iniettori Diesel	122
Postazione mobile per strumenti diagnosi	385
Presse idrauliche	271-272
Pressori per molle ammortizzatori	209
Protezioni per auto	266
Protezioni per ruote	124
Provatensione	196
Rabboccatori per batterie	231
Recuperatori olio esausto	257-258
Rilevatore di segnale	236
Sabbiatrice da banco	264
Smerigliavalvole pneumatico	173
Sollevatore ruote truck	268
Sollevatori idraulici a bottiglia	269
Sollevatori idraulici a ruote	273-274
Sollevatori idraulici da fossa	270-271

INDICE ALFABETICO UTENSILI PER AUTORIPARAZIONE

	
Sollevatori oleopneumatici	275
Sostegni motore	269
Spatoline in acciaio Inox	161
Spazzola per morsetti batteria	227
Spessimetri per carrozzieri	162
Spotter carrellato per carrozzeria	164÷165
Stabilizzatore di tensione	201
Stazione di ricarica climatizzatori	262÷263
Stazione per cambio automatico	260
Stazioni lavaggio componenti motore	265
Stetoscopio	201
Strumenti estrazione liquido freni	179-180
Strumenti per controllo impianto raffreddamento	233
Strumento per controllo compressione motori a benzina e Diesel	121-122
Tallonatori per gomme	336
Tassi per carrozzieri	160-161
Tenditori per molle	170
Tester digitale pressione e compressione	177÷180
Tester per batteria e impianti di ricarica	201
Tirabolli pneumatico	164
Utensile per rimozione guarnizioni	206
Utensili per airbag	172
Utensili per bobine candele	183
Utensili per connessioni elettriche	196
Utensili per estrazione silent block	211
Utensili per impianti di condizionamento	188
Utensili per iniettori Diesel Common Rail	121
Utensili per riempimento filtri gasolio	186
Utensili per rimozione candeelette preriscaldamento	121-122
Utensili per valvole pneumatici	124-125
Utensili per veicoli pesanti	124
Vasca per pulizia pezzi	263÷265
Vasche per recupero liquidi	258-259

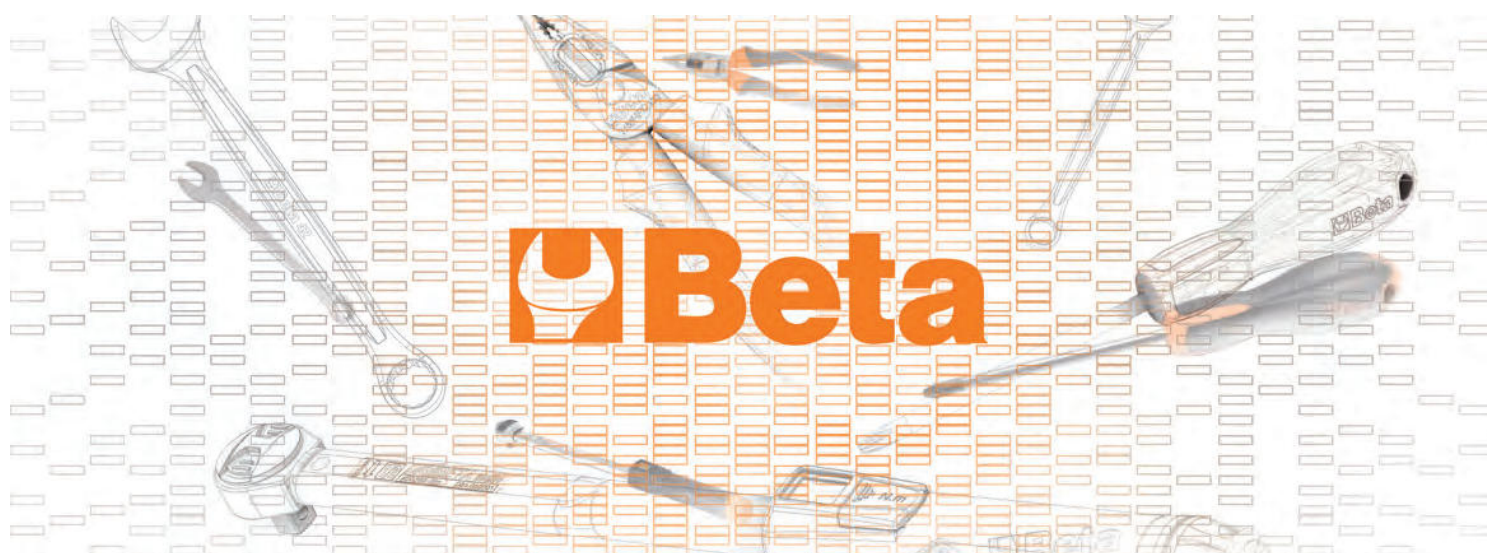

INDICE ALFANUMERICO

1

100	24	1032HS	296	1081	133	1126	137	1149F	140
100/KIT	24	1032BA	311	1082	133	1127	137	11491	543
110BA	309	1032K	559	1082BM	133	1128BAX	137	11493	543
110MQ	289	1033	129	1082G	133	1128BMX	137	11495	543
111CM	24	1033K	559	1082GBM	134	1128BMX/F	137	11498	543
111E	24	1034	129	1082MQ	291	1128BM	138	1150	140
111EN	24	1034L	129	1082BM-HS	297	1128BSX	138	1150G	140
111ER	24	1034HS	297	1082INOX	303	1128FX	138	1150BM	141
111E-HS	295	1034K	559	1082BA	312	1128FXS	138	1150GBM	141
111INOX	303	1036	129	1082GK	559	1128MQ	291	1150HPC	141
120	25	1036HS	297	1082K	559	1128BAX-HS	297	1150MQ	292
120/B6N	25	1036BA	311	1082BMK	560	1129BM	138	1150BM-HS	298
123/K4	25	1036K	559	1082GBMK	560	1129BMK	561	1150INOX	303
123E1/4	25	1037	129	1084	134	1130BMX	138	1150BA	312
123Q1/2	25	1037K	559	1084BM	134	11300A	541	1150BMK	561
123Q1/4	25	1038	129	1084G	134	11300B	541	1150GBMK	561
123Q3/8	25	1038HS	297	1084GBM	134	11300C	541	1150GK	561
141	25	1038K	559	1084MQ	291	11300D	541	1150K	561
141/B	25	1039	130	1084BMK	560	11300E	541	1153	141
141/S	25	1044	130	1084GBMK	560	11300F	541	1153INOX	303
142	25	1044F	130	1084GK	560	11300G	541	1162	141
142/B	26	1044FK	559	1084K	560	1131CK	138	1162BM	142
142/S	26	1044K	559	1088	134	1132	139	1162G	142
142/SC9I-E	26	1046BA	312	1088BM	134	1132BM	139	1162GBM	142
142AS	26	1047	130	1088MQ	291	11320	541	1162MQ	292
142AS/S	26	1047BM	130	1088BM-HS	297	1132MQ	291	1162BA	312
142C	26	1048BM	130	1088BMK	560	1132BM-HS	298	1162BMK	561
142C/A	26	1048N	130	1088K	560	1132BMK	561	1162GK	561
142HS	296	1048N/D3	130	1092V	134	1132K	561	1162K	561
142K	556	1048VN	130	1094V	134	1133	139	1162GBMK	562
142MC	26	1048MQ	291	1095N	134	1133RL	139	1164	142
142MC/SC9I-E	26	1048BM-HS	297	1096	134	1134	139	1164BM	142
142SN	26	1048INOX	303	1096K	560	1134A	139	1164MQ	292
142SN/S	26	1048NK	559	1098	135	1134A/RL	139	1164BMK	562
142SN/SC9	26	1048VNK	559	1098PL	135	1134RL	139	1164K	562
186	27	1050	131	1098K	560	1137BA	312	1166	142
187	27	1051	131	1098PLK	560	1137BA/RC	312	1166BM	142
187/B5	27	1051GM	131	1100BA 600	312	11411	541	1166G	142
188	27	1051L	131	1101	135	11415B	541	1166GBM	142
192	27	1051XL	131	1101R	135	1142BM	139	1166MQ	292
192/S2	27	1052	131	1102	135	11420B	542	1166BM-HS	298
194	27	1052HS	297	1103	135	1142MQ	292	1166BA	312
195	27	1052BA	312	1103R	135	1142BMK	561	1166BMK	562
195/B5	27	1052K	559	1104	135	1143	139	1166GBMK	562
195AS	27	1053	131	1104R	135	1143R	139	1166GK	562
195AS/B	27	1054	131	1105	135	11431	542	1166K	562
195K	556	1055	131	1105/C10T	136	11435	542	1168	142
195P	27	1055D	131	1105/C16T	136	1144D	139	1168G	142
195P/B5	27	1056	131	1105/C32T	136	1144D/RG	139	1168BM	143
1002	128	1057A	132	1105AD-50	136	1144D/RL	139	1168GBM	143
1008	128	1058	132	1105T20	136	1144G	139	1168MQ	292
1008BM	128	1059	132	1105T30	136	1144G/RL	140	1168BM-HS	298
1009	128	1060	132	1105T50	136	1144L	140	1168BMK	562
1009L/A	128	1061	132	1112	136	1144T	140	1168GBMK	562
1009L/B	128	1062	132	1114	136	11440A	542	1168GK	562
1009L/C	128	1062AL	132	1118	136	11440B	542	1168K	562
1009L/D	128	1062GM	132	1120A	136	11440C	542	1169/D3	143
1009L/DP	128	1063	132	1120ARL - ARG	136	11450A	542	1169BM/D3	143
1009L/DP-S2	128	1064	133	1122	136	11450B	542	1169G/D3	143
1010	128	1065F	133	1122 - 1125MOL	137	11450C	542	1169GBM/D3	143
1010BM	128	1065P	133	1122K	560	1148A	140	1171BM	143
1010MQ	291	1066	133	1123	137	1148A/R	140	1172BM	143
1031/S4	129	1067	133	1123K	560	1148B	140	1172BM/P	143
1032	129	1077	133	1124	137	1148B/R	140	1173BM	144
		1078	133	1124K	560	1148P	140	1175BM	144
		1080D	133	1125	137	11488PF	543	1177BM	144

INDICE ALFANUMERICO

1177BM/Z	144	1253A	150	1269PZ	155	1294L	158	1366B	164
1178BM	144	1254	150	1269PZ/S4	155	1294HS	298	1366KF	164
1178BM/P	144	1256/C36-2	150	1269N/PZK	564	1294K	564	1366S	164
1182BM	144	1256LP	150	1269PZK	564	1295	158	1366S KIT	164
1183BM	144	1256PE	150	1270BA	312	1295/C14	159	1366S/R1	164
1184BM	145	1256PH	150	1272MQ	292	1297TX	159	1366S/R2	164
1185BM	145	1256PZ	150	1272MQ/S	292	1297TX/D6	159	1366S/R3	164
1186BM	145	1256/20	151	1272MQF	292	1297TX/L	159	1366S/R4	164
1188BM	145	1256/30	151	1272BA	312	1297TX/L-S5	159	1366S/R5	164
1190BM	145	1256RTX	151	1273MQ/D6	292	1297TX/S12	159	1366SL	164
1191BM	145	1256TX	151	1273MQF/D6	292	1298RTX	159	1366ST	164
1191BM/L	145	1257BE	151	1273MQ/E1	573	1298RTX/S8	159	1366S/R10	165
1191R/5-M	145	1257ES	151	1273MQ/E4	573	1298RTXK	564	1366S/R11	165
1200MS	145	1257ESB/S8	151	1274MQ	292	1299N/PZ	159	1366S/R12	165
1201E	146	1257LP	151	1274MQF	292	1299PZ	159	1366S/R13	165
1201E/DZ	146	1257LP/S	151	1274MQ/S	293	1299PZ/S6	159	1366S/R14	165
1201E/S6	146	1257LPH/S8	151	1275MQ/C	293	1299HS	298	1366S/R21	165
1201EN	146	1257PH	151	1276MQ/C	293	1299N/PZK	564	1366S/R22	165
1201E/K	562	1257TX	151	1277BA	312	1299PZK	564	1366S/R24	165
1201EN/K	562	1257TX/S	151	1279MQ	293	1302	160	1366S/R25	165
1202E	147	1260	152	1279MQ/F	293	1303	160	1366S/R26	165
1202E/S4	147	1260/S6	152	1279MQ/S	293	1304	160	1366S/R6	165
1202EL	147	1260N	152	1281BG	155	1305	160	1366S/R7	165
1202EN	147	1260E	153	1281LP	155	1305Z	160	1366S/R8	165
1202E/K	562	1260MC	153	1281PB	155	1306	160	1366S/R9	165
1202EN/K	562	1260EK	563	1281PM	155	1307	160	1367/K10	165
1203E/D	147	1260K	563	1281/B28A	156	1308	160	1367/S4	165
1203E/S	147	1260NK	563	1281BG/A9	156	1310	160	1368	166
1203/E10P	571	1262	153	1281BG/B28NA	156	1312	160	1368G/C2U	166
1203/E1P	571	1262/S4	153	1281BG-TX/A8	156	1314	161	1368G/CV	166
1203/E4P	571	1262E	153	1281LPH	156	1326	161	1368G/K400	166
1203/E5P	571	1262L	153	1281PE	156	1327	161	1368G/OD	166
1204E	147	1262MC	153	1281PH	156	1328	161	1368G/SD	166
1204E/S5	147	1262N	153	1281PZ	156	1329	161	1369/C11	166
1204EL	148	1262EK	563	1281RTX	156	1330	161	1370	166
1204E/K	562	1262K	563	1281TX	156	1331	161	1370/MR...	167
1205E/ES	148	1262NK	563	1290	157	1335BM	161	1370F	167
1205E/ES-S8	148	1263/D...	153	1290/S	157	1337/S5	161	1370F/MR...	167
1206E/BP	148	1263/S12	154	1290N	157	1338	161	1370FT	167
1206E/BP-S7	148	1263MC/D8	154	1290HS	298	1338A - 1338B	161	1370T	167
1207E/TX	148	1263/E74	571	1290INOX	304	1338R9 - 1338R12	161	1370T-HS	298
1207E/TX-D	148	1263/E78	571	1290K	564	1342	161	1370T-HS	299
1207E TX/K	563	1263/E39	572	1290K/INOX	564	1342PM	161	1370INOX	304
1208E/RTX	148	1263/E40	572	1290NK	564	1342PMR	161	1370BA	312
1208E/RTX-D	148	1263/E50	572	1292	157	1343	161	1370BA/MR	313
1208E RTX/K	563	1263/E62	572	1292/S4	157	1344	162	1370BA/PL	313
1209E/PZ	148	1263/E70	572	1292L	157	1344A/VW	162	1374F	167
1209E/PZ-S4	148	1263/E85	572	1292N	157	1345	162	1374F/MR...	167
1209EN/PZ	148	1264	154	1292HS	298	1351	162	1375	167
1209E PZ/K	563	1264/S5	154	1292INOX	304	1353	162	1375/MR	167
1209EN-PZ/K	563	1264L	154	1292K	564	1357Z/45	162	1375A	167
1229LP	149	1264K	563	1292NK	564	1359T	162	1375B	167
1229LP/S	149	1265ES	154	1292K/INOX	564	1360/K6	162	1375BA/PL	313
1229LPH/A6	149	1265ES/S8	154	1293/D...	158	1360/KP3	162	1376X	167
1229PH	149	1266BP	154	1293/S...	158	1360G	162	1376X/MR	168
1236B	149	1266BP/S8	154	1293BP	158	1361/C12	162	1376XT	168
1238B	149	1267TX	154	1293BP/S	158	1361/K9	162	1376XT/MR	168
1241	149	1267MC/TX	155	1293ES	158	1362B	163	1377	168
1242	149	1267MC/TX-D7	155	1293ES/S7	158	1364SCP	163	1377/MR...	168
1243/D7	149	1267TX/D7	155	1293INOX/D9	304	1364SE	163	1377T	168
1243LP/D6	149	1267TX/S13	155	1293BX/DA	573	1364SP	163	1377INOX	304
1243/S11	150	1267TXK	563	1293BX/DD	573	1364SV	163	1377BA	313
1250	150	1268RTX	155	1293BX/DE	573	1365/K13	163	1377BA/PL	313
1251	150	1268RTX/S8	155	1293BX/DF	573	1365P10	163	1378	168
1252/S5	150	1268RTXK	564	1294	158	1366A	163	1378/MR...	168
1253	150	1269N/PZ	155	1294/S7	158	1366/K5	164	1379F	168

INDICE ALFANUMERICO

1379F/MR...	168	1455SVP/R...	173	1467LF/RC	180	1478/3P	185	1488 - 1488L	190
1379BA	313	1457/B4	173	1467T/C6	180	1478/K3	185	1488/1	190
1380	168	1458	173	1467TU	180	1478NSS	185	1488R...	190
1380/MR...	168	1460F	173	1468N	180	1478T	185	1489/31T	190
1380S	168	1461/C5G	173	1470	180	1479	185	1489/33	190
1380S/MR...	168	1461/C6B	173	1470FT	180	1479/B27	185	1489/33P	191
1380T	169	1461/C11A	174	1470PF	180	1479L/S2	185	1489/C14	191
1380BA	313	1461/C12A	174	1471	180	1479LB/C5	185	1489/E	191
1380BA/MR	313	1461/C13B	174	1471A	180	1479L/K4	186	1489/Y	191
1380BA/PL	313	1461/C18B	174	1471CF	181	1479LV/S3	186	1489R	191
1381	169	1461/C20G	174	1471CM	181	1479ML/B17	186	1490	191
1381/MR...	169	1461/C6G	174	1471CM/E11	181	1479ML/S3	186	1490/R1 - 1490/R2	191
1381T	169	1461/C7B	174	1471GF	181	1479N/S5	186	1490F	191
1381BA	313	1461/C8B	174	1471M/50	181	1479RB/1	186	1491	191
1381BA/MR	313	1461/C9B	174	1471M/C22	181	1479RB/2	186	1491A	191
1381BA/PL	313	1461/C21G	175	1471M/P	181	1479RB/3	186	1491R	191
1385	169	1461/C23B	175	1471M/W50	181	1479U/13	186	1491T	191
1385/MR	169	1461/C24B	175	1471PN/B1	181	1479U/32	186	1492/1 - 1492/2	192
1390	169	1461/C25G	175	1471PN/B2	181	1480	186	1492T	192
1390/MR...	169	1461/C27G	175	1471PN/B3	181	1481/C12	186	1493	192
1390N	169	1461/C28B	175	1471PN/B4	181	1481K/S4	187	1493/C30	192
1390NR	169	1461/C29B	175	1471PN/B5	181	1481PL	187	1493/PF	192
1390R	169	1461/C30G	175	1471PT/C5	181	1481PL/S3	187	1493AL	192
1390HS	299	1461/C32G	175	1471D2	182	1481T/C12	187	1493AL 4S	192
1390BA	313	1461/C33B	176	1471T/C5	182	1482	187	1493B	192
1390BA/R	313	1462/KD	176	1472	182	1482/8 - 1482/10	187	1493B/S5	192
1391	169	1462/KI	176	1472AU	182	1482A/1	187	1493/C19	193
1391A	170	1462/KMRC	176	1472AU/P	182	1482A/3	187	1493/C7	193
1392	170	1462/KU	176	1472AU/RP	182	1482A/5	187	1493AL CF	193
1392R	170	1462/MB	176	1472B/RNLT	182	1482B	187	1493DSG	193
1392HS	299	1462CF	176	1472FC	182	1482SN	187	1493FF	193
1393	170	1462CF/C6	176	1472FC/GE	182	1482C	188	1493FT	193
1410/M	170	1462CF-SN	176	1472FC/L	182	1482D	188	1493H	193
1428	170	1462CF-SN/C6	176	1472FCA	182	1483K/12	188	1493HK	193
1428/SB11	170	1462/EI	177	1472R/AU	182	1483K/22	188	1493J	193
1428L	170	1462AD/BSC	177	1472FCL/RP	182	1483KV-PT/S7	188	1493VW	193
1428L/B3	170	1462AD/SMN	177	1472H	183	1484	188	1493/S-U	194
1429	171	1462PIM	177	1472MT/VW	183	1484PSA	188	1493C/ADB	194
1429/SB7	171	1463/KIT	177	1472TM	183	1485BP	188	1493U/ADB	194
1430/...	171	1464CBD	177	1472VW	183	1485BPM	188	1493X	194
1430/S	171	1464IC	177	1473	183	1485FCA/K2	188	1493Y	194
1431/...	171	1464T	177	1473A	183	1485FCA/T	188	1494	194
1431/C5	171	1464T/SP80	177	1473FN	183	1485FCA/TS	188	1494BMW	194
1433	171	1464ADB	178	1473P	183	1485FRD/T	188	1494E	194
1433/C11	171	1464AP	178	1473T	183	1485KIT	189	1494FPC	194
1435	171	1464AP T	178	1474/C4	183	1485MJ	189	1494MAN	194
1435/1	171	1464AP T16X12	178	1474E/VW	183	1485MRC/T	189	1494MRC	194
1435/1R	171	1464APB	178	1474E/VW2	183	1485PMTJ	189	1494T/C5	194
1435R	171	1464FAP	178	1474DL	184	1485R	189	1494VW	194
1437/C12	172	1464FG	178	1474G	184	1485R/P10	189	1494/C14A	195
1438	172	1464FG/CP4	178	1474L	184	1485R/P17	189	1494M	195
1438DCT	172	1464IC/RK	178	1475U	184	1485TC	189	1494Q	195
1438DCT/S	172	1464PB	178	1476	184	1485VAG	189	1494T	195
1438DSG	172	1464PF	179	1476/RC	184	1485VAG/K2	189	1494VW/K	195
1438EVO	172	1464PT	179	1476A	184	1485VLV/T	189	1494VW/KT	195
1438K/DSG-2	172	1464TDI	179	1476A/RC	184	1486/10	189	1494XZN	195
1438K/PWR	172	1464VD	179	1476C/1	184	1486/20	190	1495/C6	195
1438R	172	1465	179	1476GT	184	1486/30	190	1495M	195
1439/K7	172	1466/C5	179	1476PSA	184	1486/40	190	1495T	195
1440/...	173	1466L 11	179	1476T	184	1486/50	190	1496/C	195
1445/1 - 1445/2	173	1466TLF	179	1477/C10	184	1486/60	190	1497D	195
1452K	173	1467	179	1477D	185	1486/70	190	1497/C23	196
1452PN/K	173	1467/RK1	180	1477D/S5	185	1486/80	190	1497/C94	196
1454P	173	1467/RK2	180	1477K/7	185	1486/90	190	1497/S3	196
1455SVP	173	1467LF/2	180	1478	185	1487/K2	190	1497BS	196

INDICE ALFANUMERICO

1497KB/S3	196	1529	205	1585GI/5 - 6 - 7	211	1654	214	1700N	220
1497P	196	1529/C7	205	1589PI/50 - 100 - 150	211	1654DGT	214	1700N/PM	220
1497RC	196	1529/PG	205	1589VI	211	1656	214	1701N	220
1497SS	196	1529PI	205	1590	212	1657DGT/2	214	1701N/PM	220
1497TE	196	1530/C16	205	1591	212	1658/...	214	1701NE/...	220
1498	196	1530/C5	205	1593	212	1658/C4	214	1701PMR	220
1498BC/12	197	1531/C7	206	1594	212	1658DGTB	214	1701BA	314
1498LT/12	197	1532	206	1595	212	1658SP/1	215	1702N	220
1498LT/12-R7	197	1533/...	206	1599B	212	1659	215	1702N/PM	220
1498LT/12-SF	197	1533PR/1 - 2 - 3	206	1599F	212	1662/1 - 1662/2	215	1702PMR	220
1498MN/12-C	197	1534/...	206	1599GI	212	1662AN	215	1703BA/A	314
1498MN/12-P	197	1535/C...	206	1599GR	212	1662DGT/A	215	1703BA/P	314
1498MN/12-R	197	1539	206	1599P	212	1662SP0	215	1703BA/PL	314
1498MN/12-U	197	1540	206	1599T	212	1662SP2	215	1704	221
1498/12	198	1542/1 - 1542/2	207	1599G	213	1666	215	1704A	221
1498/12-24 R20	198	1544/...	207	1600Q 10	213	1666A	215	1704C	221
1498/24	198	1545/C5M	207	1600Q 8	213	1668	215	1705	221
1498/2A	198	1547/C6	207	1601/PC	544	1668A	216	1705PT	221
1498/4A	198	1547KP	207	1602A-HS	299	1670	216	1706DGT	221
1498B12/R02	198	1547P	207	1602BA	314	1670A	216	1707	221
1498LT/12-24	198	1547PC/2	207	1602/C10	544	1672	216	1707A/1 - 2 - 3	221
1498SA/2A-4A	198	1547PL/2	207	1602A	545	1672A	216	1708/8 - 13 - 20	221
1498/16A	199	1549	207	1603	544	1674A	216	1708HS/21	299
1498/25A	199	1550U	208	1603A	545	1676	216	1709/10 - 1709/18	221
1498/2A-8A-PR	199	1550U/CGS-R	208	1603B	545	1678/C3	216	1710	221
1498/4A-8A CO	199	1550U/M	208	1603BK	565	1679	216	1712E/1 - 2 - 3	221
1498/4A-8A CP	199	1550U/MRC-ABE	208	1603K	565	1679/PR	216	1712TF	221
1498/8A	199	1550U/MRC-C	208	1604	545	1680	216	1713M	222
1498/120A	200	1550U/S...	208	1606/3	545	1680A	217	1714	222
1498/40A	200	1550U/SS187	208	1606A	545	1680B	217	1715	222
1498SM	200	1551/C20	208	1606A/C10	545	1680C	217	1715B/R5L	222
1498SM-A	200	1552/C9	208	1606T	545	1682	217	1715FL/A	222
1498SM-C	200	1555/Q	209	1607	545	1682HS	299	1715FL/B	222
1498SM-CP	200	1555/QS	209	1608	545	1683	217	1715R/FL	222
1498TB/6-12	200	1555C	209	1608/C10	546	1685/C7	217	1716A	222
1498PC	201	1555S/BMW-RNT	209	1608A	546	1687/S4	217	1716P	222
1498ST/TB	201	1556/1A	209	1609A	546	1687A	217	1716Q	222
1498ST/TB ROT	201	1556/2A	209	1609B	546	1687AC	217	1716R	222
1498TB/12-24	201	1557	209	1609C/C6	546	1687D	217	1716U	222
1498TC	201	1557/S3	209	1609M	546	1687U	217	1717A	222
1499	201	1557V	209	1610	546	1688	217	1717B	222
1500/...	201	1558/C4	130	1610-B	548	1688A	217	1717C	222
1500/SP	201	1558/C13	209	1614-P	548	1688M	218	1717D	222
1500GI/...	201	1558P	209	1616-SM	548	1688PC	218	1717T	222
1500N/...	202	1559	210	1618-SF	548	1688PC/R	218	1717T RS	222
1500N/G...	202	1559V/8T	210	1620-M	548	1690F	218	1717T RT	222
1500N/SP	202	1560/2	210	1622-F	548	1690L	218	1717V	223
1501/1 - 2 - 3	202	1560A	210	1624-FI	548	1691BM	218	1717V R	223
1501G/1 - 2 - 3	202	1561/...	210	1628-C	548	1691MG	218	1717BA	314
1501Z/S - P - R	202	1562D	210	1630-CR	548	1692	218	1717BA/1	314
1502/...	202	1563/C4	210	1632-TS	548	1692HS	299	1718A...M	223
1505V	202	1565/1 - 2 - 3	210	1634-TD	548	1693	218	1718A...P	223
1505/C5	203	1566/GO1	210	1635-D	549	1693M	218	1718A...Q	223
1506	203	1566N	210	1635-S	549	1694/L	219	1718A...R	223
1508/1 - 1508/2	203	1566P	210	1638M	553	1694A/L	219	1718A...T	223
1511/1 - 2 - 3	203	1566R	210	1639S	546	1694B/L	219	1718D...M	223
1515/1 - 2 - 3	203	1567	210	1639EAB	553	1695XS	219	1718D...P	223
1516/1 - 2 - 3	203	1568	211	1639ESB	553	1696	219	1718D...Q	223
1517	203	1569/F	211	1639ESC	553	1696A	219	1718D...R	223
1517C/...	204	1569/SB	211	1639ETA	553	1696B	219	1718D...S5	223
1518/...	204	1569CP	211	1650	213	1696D	219	1718D...T	223
1518U/...	204	1570/3	211	1650FD	213	1696S	219	1718A...S5	224
1519/...	204	1580/8I	211	1650FT	213	1697	220	1719BMA...M	224
1520/1 - 1520/2	205	1580GL	211	1651DGTB	213	1699L	220	1719BMA...P	224
1521/1 - 1521/2	205	1585/5I - 6I - 7I	211	1651DGTB/IP	214	1699L/1	220	1719BMA...Q	224
1528	205			1652	214	1699Q	220	1719BMA...R	224

INDICE ALFANUMERICO

1719BMA...T	224	1742KR	228	1757A	231	1767PMC	239	1833RB-L/USB	243
1719BMD...M	224	1742R-A/M...	228	1758	231	1767PMR	239	1833XS/1	243
1719BMD...P	224	1742R-AL/M...	228	1758ADB-D	231	1768	239	1833XS/2	243
1719BMD...Q	224	1742A/C	229	1758A	232	1770	239	1833L	244
1719BMD...R	224	1742A/KR	229	1758ADB-45°	232	1770A	240	1833M	244
1719BMD...T	224	1743HS	299	1758B	232	1770BM	240	1833S	244
1719BMX...M	224	1743T	552	1758B/K5	232	1770RL	240	1833XL	244
1719BMX...P	224	1744	552	1758B-1,6	232	1771	240	1834RR	244
1719BMX...Q	224	1748-BV3	549	1758B-RNT	232	1771BM	240	1836AW	244
1719BMX...T	224	1748N	549	1758LG	232	1771HD	240	1836B	244
1719BM/RL	225	1748V	549	1758M	232	1771RL	240	1837F	244
1719BM/RR	225	1748-BL	550	1758R	232	1772H	240	1837F/USB	244
1719BMA...B5	225	1748-BV1	550	1758VT	232	1772M	240	1837C	245
1719BMA...S5	225	1748-BX	550	1758VT/L	233	1772R	240	1837M	245
1719BMB/P	225	1748-N2D	550	1758BA	314	1772RL/2	240	1837RB-F/USB	245
1719BMC	225	1748-NL	550	1759	233	1772H-HS	300	1837S	245
1719BMD...B5	225	1748-UL	550	1759A	233	1773A	240	1838FLASH	245
1719BMD...S5	225	1748-BA2	551	1759B	233	1773RL	240	1838POCKET	245
1719BMR	225	1748-BH	551	1759HD/3	233	1774	240	1838RB/FLASH	245
1719BMX...R	225	1748-BP	551	1759HD/RR	233	1774A	240	1838/11LED	246
1719BMX...S5	225	1748-BR	551	1759HD/TRUCK	233	1774A/RL	240	1838AM	246
1719R/...	225	1748-BT	551	1759LR	233	1774S	240	1838COB	246
1719BA12	314	1748-BT2	551	1759TT	233	1776BA	314	1838P	246
1719BA8	314	1748-BT3	551	1760DGT	234	1777BM	241	1838RA/10-11LED	246
1720/...	225	1748-NA2	551	1760DGT/2	234	1777BMT	241	1838RB/10LED	246
1720/B	225	1748-BA3	552	1760/OHM	235	1777T	241	1838RR/11LED	246
1720/S	225	1748-BV	552	1760/RMS	235	1777MQ/C	293	1838RV/11LED	246
1720D/...	226	1748-NA3	552	1760B	235	1777MQ/U	293	1838SLIM	246
1720D/B	226	1748-NV	552	1760PA/80	235	1777RL/U	293	1838E	247
1721/B6	226	1748-S	552	1760PA/AC	235	1778AN	241	1838E-BT	247
1723	226	1748-SC	552	1760S	235	1778AX	241	1838SW	247
1725	226	1748-N	553	1760/RSE	236	1778CM	241	1838UV	247
1725CR	226	1748-ST	553	1760/TC2	236	1778M7	241	1839/R1	247
1725MQ	293	1749	229	1760DGT-R3	236	1778P	241	1839/R2	247
1726	226	1749A	229	1760K	236	1778SCL	241	1839/R4	247
1726BM	226	1749A/RB	229	1760PA/AC-DC	236	1778SOS	241	1839/R5	247
1727	226	1749A/RT	229	1760PA/AC-DC2000	236	1778V18	241	1839/R6	247
1727BM	226	1749AC	229	1760R/TC2	236	1778X	241	1839BRW	247
1727HS	299	1750	229	1760/IR1000	237	1778MT	242	1840BM	248
1727BA	314	1750CG	229	1760/IR1600	237	1778SOS-HS	300	1842LED/ABM	248
1728...	226	1750R/1 - 1750R/2	229	1760/IR500	237	1781	242	1842LED/BM	248
1728BA	314	1750RC	229	1760LX	237	1783	242	1842	249
1729CG	226	1750RP/1 - 1750RP/2	229	1760PT	237	1784	242	1843	249
1729DM 450	226	1750RT	229	1760TMC	237	1784BA	314	1844	249
1730	226	1750KG10	230	1760WM	238	1800/100	242	1844SCK	249
1730M	226	1750M	230	1760BHS	299	1808	253	1845	249
1730V 38	226	1750M3	230	1761	238	1812 150	253	1846	249
1730INOX	304	1750TA	230	1761RS/1	238	1814M	253	1846R-LED/BM	249
1736A	227	1750TLA	230	1762	238	1820	253	1847	250
1737	227	1750HS	299	1762K	566	1820 60	253	1848	250
1737AC	227	1751N	230	1763	238	1820 80	253	1850D	250
1737B	227	1751NR	230	1763G/S500	238	1822	253	1850E	250
1737NX	227	1752	230	1764/K5	238	1822 180	253	1851VK	250
1737BA	314	1752R	230	1765/C24	238	1822 320	253	1851VK-12C	250
1738	227	1753	230	1766	238	1823 60	253	1851VK-12V	250
1739B	227	1753R	230	1766/8	238	1823R/60	253	1852R1750	250
1740A	227	1754	231	1766A	238	1824R	253	1852S-CC	250
1740B	227	1755	231	1766ER	239	1825B	253	1852S-CNT	250
1741B	227	1756	231	1766ER/VW	239	1827	253	1852 S-PIATTE	251
1741B/C5	228	1756B	231	1766G	239	1827PC	253	1852S-F	251
1741BP	228	1756C	231	1766I	239	1827PCL	253	1852S-FLESS	251
1741RV...K	228	1756C-2OR	231	1766L	239	1827/K	254	1852S-KR/CNT	251
1741U	228	1756D	231	1766LI	239	1827F	254	1852S-L	251
1742	228	1756D-2OR	231	1766T	239	1827PFL	254	1860BH R/CM	254
1742/C4	228	1756G	231	1767A	239	1830T	254	1860BH R/CS	254
1742A	228	1757	231	1767B	239	1833L/USB	243	1860BH/120A	254

INDICE ALFANUMERICO

1860BH/160A	254	1885/C2-R7	262	1919F1/2	340	1935F	329	1949DGT/2	336
1860BH/200A	254	1885/C3	262	1919F1/4	340	1936/4A	329	1949F2	336
1860BHT R/CM	255	1885/C3-R1	262	1919F3/8	340	1936/5A	329	1949GPA	336
1860BHT R/CS	255	1885/C3-R10	262	1919L	340	1936/7A	329	1949GPN	336
1860BHT/160A	255	1885/C3-R2	262	1919ML	340	1937	329	1949M	336
1860DM	255	1885/C3-R3	262	1919RB-F	340	1937KC	329	1949R	336
1860EI	255	1885/C3-R4	262	1919RB-FE1/4	340	1937R/P	329	1949T	336
1860M	255	1885/C3-R5	262	1919RF-F	340	1937C...	330	1950BZK	336
1860PMIG	255	1885/C3-R6	262	1919RF-FE1/4	340	1937K...	330	1951	337
1860RG	255	1885/C3-R7	262	1919RM-F	340	1937KL	330	1951A	337
1860SQ	255	1885/C3-R8	262	1919RM-FE1/4	340	1937KL-D	330	1952	337
1870	256	1885/C3-R9	262	1919SC	340	1937M	330	1957 115-750W	316
1870I	256	1885/XC60	262	1921B1	321	1937M-01÷11	330	1957 125-1400W	317
1870-20/5S	257	1889	260	1921M1	321	1937N10	330	1957 230-2400W	317
1870-72 /FC	257	1889CF	260	1921M2	321	1937N10-GR	330	1972/13	315
1870-72/FL	257	1893/134A	262	1921N3	321	1937N20	330	1984/18QM	315
1872L	256	1893/1234YF	263	1922P1	321	1937N20-GR	331	1995MQ/G1 - G2	293
1872L 35/5S	257	1893TR/1234YF	263	1922P2	321	1938	331	1995MQ/T	293
1872L 35/FC	257	1893TR/134A	263	1922P3	321	1938R/L	331	1996MQ/GM	293
1873	256	1893TR/CI	263	1924F	321	1938R/S5	331	1996MQ/T	293
1873-30/5S	257	1895 13	263	1924B	322	1940	331	1996SVG	293
1874	257	1895 6	263	1924CD	322	1940/C6	331	11001H	529
1874-50/5S	257	1895/S	263	1924XM	322	1940/S5	331	11002	529
1874-50/FC	257	1895G	263	1927B	322	1940E10	331	11003	529
1875LT	257	1895 27	264	1927B/K5	322	1940MT	331	11011	529
1875SP/K3	257	1895/RC	264	1927CD	322	1940S...	331	11011H	529
1877	257	1897	264	1927CD/K3	323	1940E10/MT	332	11018	529
1877A	258	1897/CRB	264	1927P	323	1940E10/S...	332	11019	530
1877F	258	1897/G	264	1927P/K3	323	1940E10/S5	332	11021	530
1878 2	258	1897/MV	264	1927PAL	323	1942A	332	11023	530
1878 3	258	1898/B	264	1927XM	323	1942LR	332	11024	530
1878 4	258	1898/K40	264	1927XM/K5	323	1944A	332	11031+11039	530
1878 8	258	1898/D	265	1927AN	324	1944AR 2	332	11032	530
1878 11	259	1898/M	265	1927G	324	1944N	332	11034	530
1878 30	259	1898/S	265	1927SP-AM	324	1944PA	332	11035	530
1879	259	1899A	265	1928CD	324	1945S	332	11037	530
1879 6	259	1899SI	265	1928DA	324	1945S/G...	332	11038	530
1879/FUEL	259	1900M 8X15 - 1900M	337	1928DAL	324	1945C	333	11040	531
1879R/K4	259	10X15		1928XM	324	1945C/G...	333	11045	531
1880	259	1900S 8x10	337	1928K4	325	1945C/GP...	333	11046	531
1880ADB	259	1914	337	1930A	325	1945P	333	11048	531
1881	259	1915B	337	1930CD	325	1945P/S...	333	11049	531
1882	259	1915C	338	1930LA	325	1946C4,8	333	11050	531
1883	259	1915C/L	338	1930LH	325	1946T	333	11069	531
1883NC	259	1915D	338	1930PA	325	1946C/T...	334	11100	532
1884	260	1915E	338	1930HLA	326	1946C7,8	334	11101	532
1884/C12	260	1915E/XL	338	1930ZL	326	1946KF	334	11102	532
1884N/C8	260	1916G	338	1931AN10	326	1946KF/M...	334	11105	532
1885	260	1916GF	338	1931CD10	326	1947	334	11106	532
1885/C1	261	1916GFE	338	1931CD13	326	1947G	334	11107	533
1885/C1-R1	261	1916I	338	1931CD6	326	1947G2	334	11110	533
1885/C1-R2	261	1916JF	338	1932B10	327	1947H	334	11111	533
1885/C1-R3	261	1916JM	338	1932B13	327	1948	335	11115	533
1885/C1-R4	261	1916P	338	1932RS13	327	1948PR	335	11116	533
1885/C1-R5	261	1916S	339	1933	327	1949BC	335	11120	533
1885/C1-R6	261	1917F	339	1933AN90-H	327	1949BC/RU	335	11121	534
1885/C1-R7	261	1917JF	339	1933IH	327	1949P	335	11125	534
1885/C1-R8	261	1917JM	339	1933ILH	327	1949U5	335	1112K	560
1885/C2	261	1917M	339	1933AN90	328	1949U5/A	335	11130	534
1885/C2-R1	261	1917RG	339	1933I	328	1949U5/B	335	11131	534
1885/C2-R2	261	1917SP	339	1933IL	328	1949U5/C	335	11132	534
1885/C2-R3	261	1917ST	339	1933L	328	1949U5/D	335	11135	534
1885/C2-R4	261	1918	339	1934BV	328	1949U5/E	335	11140	535
1885/C2-R5	261	1918N	339	1934MAV	328	1949U5/F	335	11141	535
1885/C2-R6	261	1918R	339	1934MAV70	328	1949U5/G	335	11145	535
		1919FE1/4	339						

INDICE ALFANUMERICO

11200A	535	2002/BV13	344	31BM/D6	9	345SB2	31	3000L	266
11200B	535	2002/BV42	344	31L	10	345SC	31	3000L/RLS	266
11202A	535	2005MPU	344	31SE	10	345SI	31	3000M/PLM	371
11202B	535	2005PA/D	344	32	10	345SI/R	31	3002	266
11202C	535	2005PA/E	344	32AU	10	345U	31	3002/RLS	266
11204A	536	2005PA/S	344	32AUR	10	345U/A	31	3003	267
11204B	536	2009ID	344	32BA	306	349	31	3003/RLS	267
11204C	536	2009N/BV	344	34	10	349/SMAS	31	3003C	267
11208A	536	2028/VV	344	34BA	306	349/SMM	31	3003C/RLS	267
11208B	536	2028E	344	34INOX	302	350	32	3003PRO	267
11210A	536	2029/VV	345	35	10	351C	32	3003PRO/PM	267
11210B	536	2029E	345	35HS	294	351P	32	3003PRO/RCR	267
11210C	536	2032/TE	345	35PM	10	352C/U	32	3003PRO/RRG	267
11212A	536	2032/TV	345	35PMR	10	352U	32	3003PRO/RT	267
11212B	536	2033L	345	36	10	353N	32	3003PRO/SP	267
11214A	537	2033L/VV	345	37	10	353N/C6	32	3004	267
11214B	537	2036/TV	345	37PM	10	353NM	32	3006	268
11214C	537	2036E	345	37PMR	10	355	32	3006 R/RG	268
11216A	537	2037/TV	345	38/DS1	570	357F3	32	3006 R/RGF	268
11216B	537	2038/TV	346	38/DS2	570	357R/F3	32	3007	268
11216C	537	2041UC	346	39BA	307	358	33	3007 R/RG	268
11218A	537	2051N	346	39INOX	302	358RL	33	3007 R/RGF	268
11218B	537	2055HB	346	310	27	359	33	3008	268
11220A	537	2080/VG	265	310/C4	28	359CH	33	3009	268
11220B	537	2080/V6	346	310/C8	28	360	33	3009R/GR4	269
11220C	537	2080/V6-U	346	310B	27	360HS	296	3010/T...	269
11223	538	2080/D10	347	311	28	360R/...	33	3010H	269
11230A	538	2080/V12	347	330	28	361N	33	3010V	269
11230B	538	2080/V12-...	347	330BA	309	362	33	3011/T	269
11232A	538	2115P L-MQ32	291	330BA/2R	309	362INOX	303	3012	269
11234A	538	2115PI/BIKE-HOME	350	330R/A	28	362R/...	33	3012C	269
11234B	538	2250-O	265	330R/I	28	363	33	3012I	269
11240A	539	2252	265	331C	28	363BA	309	3014	270
11240B	539	2252KR4	265	332	29	363R/...	33	3014 SAR	270
11242A	539	2254A	266	334	29	365	33	3014R/GR5	270
11242B	539	2254C	266	334R	29	365R/...	33	3014SAR/1	270
11246A	539	2254F	266	334R/I	29	366	33	3014SAR/2	270
11248A	539	2254K	266	336	29	374	34	3014SAR/RR	270
11248B	539	2254SM	266	338	29	374K	556	3023	270
11259	539	2254T	266	338R	29	374R/...	34	3025	270
11260	540	2258-O	266	338R/I	29	375	34	3025/PF	270
11263	540	2300ST/KIT	359	338RP	29	376	34	3025/RF	270
11264	540	2400 RSC24/PC	365	339A	29	378	34	3025/RG	270
11265	540	2400 RSC24/PD	365	339A/R	29	378BA	309	3026 0,3	270
11266	540	2400 RSC24/PF	365	340	29	383	34	3026 0,5	271
11268	540	2400 RSC24/PF-	365	340C	30	383R	34	3026 1,0	271
11271A	540	2400 RSC24/PL	365	340C/KRL	30	384	34	3026/R 1,0	271
11271B	540	2400 RSC24/SPC	365	340RL	29	384RC	34	3026/R0,3	271
11271C	540	2400 RSC24/MP	366	341	30	386A/RC	34	3026/R0,5	271
11276A	540	2400-COVER RSC24	381	341B	30	386A	35	3026/S	271
11276B	540	2400-COVER	381	341B/RL	30	386BA	309	3026/SA	271
11276C	540	RSC24AXL		341B/RM	30	387	34	3026/SAM	271
		2499PC	366	341RL	30	387R	34	3026/SP	271
		2499PF	366	342	30	388	34	3027 10	271
		2499PF/M	366	342A	30	388A	34	3027 20	271
2001/B26	342			342A/MOL	30	388C/C8	34	3027 100	272
2001/BV	342			342A/RL	30	389/K4	35	3027 30	272
2001/BZV	342			342MOL	30	392C	35	3027 50	272
2001/BZ24 MQ	343	30	9	342P	30	392RG/C	35	3027/KP	272
2001/BZ27 VU	343	30BA	306	342P/RL	30	393	35	3027/KPP50	272
2002/BV12	343	31	9	342RL	30	395	35	3027/IPR	272
2002/BV6	343	31/B6N-LSE	10	345	31	395T	35	3028 20	272
2002/BV7-ZIP	343	31/B6N	9	345C	31	398	35	3028SP/20	272
2002/BV8	343	31BA	306	345SB	31	399	35	3028 30	273
2002/BV9	343	31BA/C	306	345SB/R	31	399R/...	35	3028 50	273
2002/BVL6	343	31BM	9					3028SP/30	273

2

3

INDICE ALFANUMERICO

3028SP/50	273	3092	281	3992	286	420A	41	437K/12	47
3029/2T	273	3093/E	281	4		420B	41	437K/16	47
3029/2T-L/R5	273	3093/U	281			421	41	437K/33	47
3029/2T-L/R6	273	3094PA	281			421/SP6	41	437P	46
3029/2T-L/RP	273	3095	281			422	41	437U/09	47
3029L/2T	273	3099E	281			423	41	437U/E-M...	47
3030/2T	273	3099T	281			423A	41	437U/PM	47
3030/2T-R5	273	3500/P-M	373			424	41	438...	47
3030/2T-R6	273	3700/PC	376			424/SP	41	438A	47
3030/2TRP	274	3700/PF	376			425	42	440	47
3030H/2T	274	3700/PFL	376			425/SP	42	440A	48
3033/3T	274	3700/PLA	376		426	42	440ASC	48	
3033E/3T	274	3700/PLL	376		426/SP	42	440ASF	48	
3033S 3T/R2	274	3700-COVER C37	381		426MD-3/CP3	42	440ASG	48	
3035	274	3910	283		426MD-3/CT3	42	440ASW	48	
3036	274	3912PP	283		426MD-3/F3	42	440B	48	
3040C	277	3912TP	283		426MD-3/FA3	42	441	48	
3040C/S1	277	3912TP/A	283		426MD-3/OG3	42	441A	48	
3040C/S2	277	3912TP/C	283		426MD/CP	43	441B	49	
3041C	277	3912TP/FOX	283		426MD/CT	43	442	49	
3041C/12	277	3912TP/QRE	283		426MD/F	43	443	49	
3041C/16	277	3912TP/ROAD	283		426MD/FA	43	444	49	
3042C	277	3912TP/RS	283		426MD/OG	43	444G	49	
3043C	277	3912TP/ST	283		426MD/OV	43	446/C30	49	
3043C/ 41+47	277	3916MMP	284		426MD/S	43	446/C48	49	
3047C	277	3918MML	284		426MD/SP10	43	446/C110	50	
3048C	277	3921	284		426MD/T	43	446ASC/C37	50	
3050/CC	277	3923	284		426MD/TA	43	446ASF/C29	50	
3050/600	278	3927	284		426MD-3/A9	43	446ASG/C23	50	
3050/KA	278	3932U	284		426MD-3/OV3	43	446ASW/C36	50	
3050/LA	278	3935	284		426MD-3/S3	43	447/C37	51	
3050/MS	278	3937	284		426MD-3/T3	43	447/C53	51	
3050/MV	278	3948	284		426MD-3/TA3	43	447/C70	51	
3054	278	3952	284		426SB	42	450	51	
3055M	278	3952/S	284		426SB/SP	42	450/C13	52	
3057	278	3953	284		426T	42	450/C15	52	
3061/2T	274	3955	284		426T/SP	42	450/C21	52	
3061/2T-P100	274	3961 3,2	284		427	44	450/C9	52	
3061/2T-P50	274	3961 3,3	284		428/C14	44	450AD	51	
3065/20-10T	275	3961 3,5	285		428FC	44	450AL	51	
3065/40-20T	275	3961U	285		428FP	44	450PA/1	52	
3067/60-15T	275	3962MV	285		429/C14	44	450PA/2	52	
3067/70-13T	275	3962SH	285		429FC	44	450PR	52	
3070B	278	3963P	285		429FP	44	451	52	
3070B/10	279	3964	285		430	44	451GA	53	
3070BE/B	279	3965	285		430/SP	44	451PA	53	
3070BE/F	279	3965C	285		430ASC	45	451PR	53	
3070BE/K	279	3967	285		430ASW	45	452	53	
3070BE/S	279	3969	285		431	45	452GA	53	
3071A	279	3969K3	285		431/SP	45	460	53	
3071B	279	3971	285		433	45	460G	53	
3071RS	279	3972	285		433ASF	45	460PP	53	
3072N	280	3973/1	285		433ASG	45	4900-COVER C49	385	
3073	280	3973/2	285		434	45	5		
3075/CM	280	3973PF	285		435	46			
3075/K10	280	3973/3	286		435G	46		52	13
3075A	280	3973/4	286		436	46		52MQ	289
3075B 55	280	3975	286		436L	46		53	13
3075MV	280	3984/1	286		436R	46		55	13
3079/21	280	3984/2	286		437C	46		55/B12N	14
3080/C15	280	3984/3	286		437C/...	46		55/B8N	14
3080R/CS3	280	3984/4	286		437C/RM14	46		55/S	14
3081	280	3984/5	286		437K/8	46		55/SP	14
3085	280	3984/6	286		437K/9	46	55AS	14	
3091	281	3991	286		437K/10	47	55AS/S	14	
					419T	41			

INDICE ALFANUMERICO

55BA	307	5915VU/AS	463	667N	67	6600 M/424	579	720AS	72
55BA-AS	307	5927VU/M	463	668N	67	6600 M/427	579	720B	72
55HS	295	5935VI/2MB	449	668RG	67	6600 M/430	579	720FRD	73
55K	555	5935ET/1MB	472	668RGC	67	6600 M/440	579	720FTX	73
55MP	14	5935VG/1MB	488	669N	68	6600 M/456	579	720FTX/SB	73
55MP/S	14	5938U/2T	464	671B/C10	68	6600 M/465	579	720IC	73
58	14	5940SBK	488	671B/C5	68	6600 M/480	579	720LS	123
58BA	307	5941VU/M	489	671N/C10	68	6600 M/485	579	720L	72
58BA-AS	307	5945VUM	490	671N/C20	68	6600 M/510	580	720L/S3	72
560/C12	55	5954VI	451	671N/C30	68	6600 M/532	580	720LC	72
560/C2	55	5954VG	491	674/C	69	6600 M/534	580	720LC/C3	72
560/C3	55	5957VI	450	677	69	6600 M/542	580	720LC/PM5	72
560/C3PLUS	55	5957U-P	465	677/C	69	6600 M/548	580	720LC/S5	72
560/C4+	55	5957VG	492	677/CP200	69	6600 M/561	580	720LCL	73
560/C6	55	5958U	466	677/CV - 678/CV	69	6600 M/583	580	720LCL/C3	73
561/1	55	5980U/BIKE	468	678/C	69	6600 M/643	580	720MC	71
562-1/VA - 562-2/VA	56	5980ET/A	473	680TC	70	6600 M/650	580	720MC/C13	71
562VV-A	56	5980/MQ	474	682	70	6600 M/657	580	720ME	73
564-3R/V - 564-4R/V	56	5980ET/B	474	6200M/B	629	6600 M/658	580	720ME/C8	73
565-1R/VA - 565-2R/VA - 565-3R/VA	56	5980EL/A	475	6200AP/S10	630	6600 M/716	581	720MRC	73
		5980EL/B	476	6600 M/14	575	6600 M/813	581	720S	72
565-4R/VB	56	5980ID	477	6600 M/22	575	6600 M/842	581	720S/SB6	72
565-5R/VB	56	5988U/7M	459	6600 M/27	575	6600 M/852	581	720TC	73
565VV-B	56	5988H/7M	469	6600 M/29	575	6600 M/856	581	720TC/S5	73
567-4R/VB	56	5988L/4M	470	6600 M/33	575	6600 M/857	581	720TX	73
567-5R/VB	56	5988U/6M	471	6600 M/40	576	6600 M/871	581	720TX/C6	73
581	60	5988 VHB-MQ	475	6600 M/42	576	6600 M/878	581	720XZN	74
583	60	5990V1	467	6600 M/44	576	6600 M/881	581	727/ES16	74
583/C31	60	5990V3	467	6600 M/47	576	6800 VE	575	727/ES16TX	74
590 - 592	60			6600 M/51	576	6800BA	630	727/C16	75
594	60			6600 M/52	576	6800RS	630	727/ES22	75
596 - 598	60			6600 M/58	576	6888B1/2	568	727/ES22TX	75
599DGT	61	600	61	6600 M/59	576	6888B1/4	568	727/ES32	75
599DGT-AN	61	601C	61	6600 M/61	576	6888B3/8	568	727PI/16	74
5700LAMP	393	601CA	61	6600 M/62	576	6888	575	727PI/16 1/2	74
5902VI	443	603	62	6600 M/63	576	6888GS	630	727PI/22	75
5902MT	477	604B	62	6600 M/73	576	6888GW	630	727PI/32	75
5902MT/AS	478	605E	62	6600 M/112	577			728	75
5904VI/1T	443	606MQ/50	289	6600 M/116	577			728/C10	75
5904VI/2T	444	610/5	62	6600 M/120	577			728/15	76
5904VI/3T	445	610L/5	62	6600 M/125	577	73	15	728/16	76
5904VU/1M	452	610L/5L	62	6600 M/126	577	73/B13N	15	728/21	76
5904VU/2M	453	611	62	6600 M/131	577	73/S	15	728/22	76
5904VU/2T	454	612 ÷ 614	62	6600 M/174	577	78	15	728/22L	76
5904VU/3T	455	614/50	62	6600 M/175	577	78AS	15	728/25	76
5904VU/4T	456	615	63	6600 M/217	577	78BA	307	728/OR - 728/SP	76
5904VG/2M	479	616 - 617 - 619	63	6600 M/218	577	78BA-AS	308	728AS	75
5904VG/2T	480	621	63	6600 M/222	577	710	70	728B	76
5904VG/3	481	622	63	6600 M/223	577	710/16	70	728FTX	75
5904VG/3T	482	641	63	6600 M/230	578	710/20	70	728L	76
5904VG/5T	483	642	63	6600 M/236	578	710/C10	70	728L/S	76
5905VG/1	484	643	63	6600 M/241	578	710/21	71	728LQ	76
5905VG/2	485	644	63	6600 M/242	578	710/22	71	728LS	76
5908VI/2T	446	650A	63	6600 M/253	578	710/25	71	728ME	75
5908VU/2T	457	650H	64	6600 M/311	578	710/OR... - 710/SP...	71	729	76
5908VG/2T	486	652	64	6600 M/315	578	720	71	729/15	103
5910VI/3	447	653	64	6600 M/320	578	720/C12	71	729/16	77
5910VI/3T	448	654	64	6600 M/326	578	720/C24	71	729/21	77
5910VG/3T	487	659/15	64	6600 M/327	578	720/C6	71	729/21L	77
5914VU/M	458	659/16	64	6600 M/330	578	720/15	74	729/22	77
5915VU/0	460	665	65	6600 M/371	578	720/16	74	729/25	77
5915VU/1	460	665LB	66	6600 M/380	579	720/20	74	729/OR... - 729/SP...	77
5915VU/2	461	665SW	66	6600 M/406	579	720/21	74	729L	77
5915VU/3	461	666HS	296	6600 M/417	579	720/22	74	729LS	77
5915VU/4	462	666N	66	6600 M/423	579	720/25	74	729T	77
5915VU/5	462	666N LBF.IN	67			720/OR... - 720/SP...	74		

INDICE ALFANUMERICO

730	77	7294HM	609	7549N	626	7905G	620	861RIBE	81
730/15	78	7294HMC	609	7549NE	626	7907G	622	861RTX	81
730/21	78	7294HN	609	7549R	626	7907P	622	861SP	81
730/25	78	7310CRK	597	7550G	627	7909B	621	861TX	80
730L	77	7314AF	599	7550N	627	7909G	621	861TQS	81
733/15	78	7315AN	599	7557BL	627	7909P	621	861TRW	81
7041LCD/4S	255	7316NB	600	7575N	622	7909V	621	861TX/C	81
7041LCD/4S-VE	255	7316NG	601	7579QN	622	7930G	617	861XZN	81
7041LCD/4S-VI	255	7317NA	600	7600G	613	7931G	619	862F/A7	557
7042LCD	256	7318AN	600	7600N	613	7933G	620	862F	82
7042LCD/RV	256	7320NA	600	7610G	614	7935G	620	862LP	81
7042LCD/RV-INT	256	7321NA	601	7610N	614	7939G	621	862PH	81
7043	256	7322SA	601	7611G	618	7940	617	862PE	82
7061TC	629	7323SA	601	7635N	624	7949	621	862PH/L	82
7076BC	629	7328A	590	7637G	624	7970	627	862PH-XL	82
7076BD	629	7328N	590	7650	614	7971L	627	862PZ	82
7076BP	629	7340B	607	7650B	614	7978L	627	862TX	82
7076BU	629	7341N	607	7653G	620	7979B	628	862TX/L	82
7093BC	629	7349RP	607	7654B	624	7980N	628	862TX-XL	82
7093BD	629	7350RP	608	7654N	624	7980NC	628	866LP	82
7104 90	628	7352A	602	7657B	624	7980R	628	866PH	82
7105 6	628	7352B	602	7657N	625	7984EG	628	866PZ	82
7109A	629	7352G	602	7658CM	623	7984G	628	866PE	83
7109D	629	7352LG	603	7658N	623	7985	628	866RTX	83
7195A	629	7353Y	603	7659N	623	7996N	628	866TX	83
7200BKK	596	7354N	603	7660B	614			867/...	84
7201BKK	596	7355V	603	7660G	614			867/C20	84
7210BKK	596	7356G	604	7661B	618			867/C38	84
7212B	593	7356LN	604	7661G	618	80	15	867/C52	84
7212G	593	7356V	604	7664G	625	80/S	15	867PE	83
7212LG	593	7357G	604	7664N	625	83	15	867PE/L	83
7213G	594	7357V	605	7665G	625	83/S	15	867RIBE	83
7214FN	594	7362B	605	7665N	625	83AS	16	867RTX	83
7214G	594	7363N	605	7669N	623	83AS/S	16	867RTX/L	83
7214LN	594	7372B	606	7670G	623	88	16	867RIBE/L	84
7215FN	595	7376A	606	7673NG	622	88/S7	16	867TX	83
7216BKK	597	7381N	606	7674NG	623	89BA	308	867TX/L	83
7218FN	595	7382N	606	7780QN	624	89MQ	289	867XZN	83
7218G	595	7398 0/G	610	7800G	628	850MQ	289	867XZN/L	83
7220PEK	591	7398ESD	610	7815CM	618	851	78	882	84
7221PEK	591	7398GEL	610	7818BL	615	851SR	78	882AN	84
7222PEK	591	7398T	610	7818CM	615	852	116	882M	84
7223PEK	592	7398U	610	7818G	615	855P	78	882M1	84
7224PEK	592	7398UP	610	7818LN	616	860/58K	557	882MSR	85
7225PEK	592	7398EF	611	7830SN	616	860/C27	557	882P	85
7235BK	597	7399 A/N...	611	7830ST	616	860/55	79	892	85
7236BK	598	7421	611	7831SN	618	860/58	79	895	85
7238WR	598	7423	611	7831ST	618	860/C38P	80	897	85
7239B	598	7425	611	7840BL	616	860LP	557	897L	85
7241EN	587	7427	611	7849BL	620	860MIX/A10	557	8001Z	634
7241BK	588	7429	611	7860G	616	860MIX/A31	557	8001Z-K	634
7241CK	588	7431P	611	7861G	619	860PE	557	8001TZ	635
7243EN	587	7527	613	7863G	619	860PH	557	8001TZ-K	635
7243BK	588	7528	613	7865G	620	860PZ	557	8002ZD	635
7243CK	589	7529	618	7867G	622	860PE/A10	79	8002ZS	635
7243CR	589	7530	613	7869G	621	860PHZ/A10	79	8003ZD	635
7243FT	589	7545F	625	7880SC	616	860RTX	557	8003ZS	635
7245BK	589	7547AZ	625	7900B	617	860TX	557	8004ND	635
7246E	587	7547BL	625	7900G	617	860TX/A10	557	8004NS	635
7246BK	590	7547G	626	7900P	617	861/C61P	81	8005Z	632
7247BK	590	7547N	626	7900V	617	861LP	80	8005TZ	633
7248GK	598	7547R	626	7901G	619	861PE	80	8005TZ-K	633
7249GK	599	7549AZ	626	7903G	619	861PH	80	8005Z-K	633
7293HM	608	7549BL	626	7903P	619	861PH/C	80	8006Z	633
7293HN	608	7549G	626	7904N	624	861PZ	80	8006Z-K	633
						861PZ/C	80		

8

INDICE ALFANUMERICO

8007Z	633	8060R/PS	656	8146/RKCI	657	8205	658	8600 R/601	582
8007Z-K	633	8061R - 8061F	649	8146/RKFC	657	8206	658	8600 R/611	582
8008N	633	8062	650	8146/RKL	657	8207	658	8702N	636
8008N-K	633	8063	649	8146/RPC	657	8209	658	8702Z	636
8008TZN	634	8063SL	649	8147C	651	8210	658	8702ZC	636
8009TZ	634	8064S	649	8147S	651	8210F	659	8709N	637
8009TZ-K	634	8065SC	650	8147P	652	8210FTP	659	8709Z	637
8009Z	634	8068S	641	8148	652	8216	659	8709ZC	637
8009Z-K	634	8074	653	8148F	652	8216-K	659	8872	300
8009FD	636	8074A	653	8148/RA	657	8220	659	8872A	300
8009FS	636	8074G	653	8148/RKCL	657	8225	660	8872AS	300
8010TZ	634	8080	653	8148/RKCM	657	8227	660	8873	300
8010Z	634	8080FM	653	8148/RKG	657	8228	660	8877	300
8010Z-K	634	8082	653	8148/RKS	657	8240	660	8877M	300
8015	637	8083	653	8148/RP	657	8240F	660	8879	300
8016	637	8085R	648	8149S/A	651	8242F	660	8880	300
8016FR	637	8086	648	8149	658	8242	661	8883	300
8016FR-K	637	8090R - 8090	648	8149CM	658	8248	659	8889C1	518
8016-K	637	8090F	667	8149CM/RA	658	8249	659	8889C2	518
8016U2	638	8091	644	8150	664	8249G	659	8889C3	518
8016UGK	638	8091SL	644	8153	664	8250	662	8889P1	518
8016U-K	638	8092	644	8156	664	8264	662	8889P2	518
8018E	638	8092SL	645	8157	664	8267	662	8889P3	518
8018T	638	8094	645	8158	664	8272	662	8889C6	519
8020A	638	8094SL	645	8159	665	8273	662	8889CD	519
8021A	638	8096	646	8160	665	8274	661	8889CS	519
8025	639	8096SL	646	8161	665	8274A	661	8889I4	519
8025-K	640	8097	646	8166	667	8274G	661	8889P4	519
8026R	639	8097SL	647	8170	665	8276	661	8889PD	519
8026R-K	639	8098	647	8173	665	8276G	661	8889PS	519
8026A	640	8098SL	647	8176	665	8278	661		
8026A-K	640	8100	648	8177	665	8279	663		
8028	640	8105	632	8178	666	8280	662	9	
8028-K	640	8105-K	632	8179A	666	8282S	662	90	16
8029R	639	8109	632	8179B	666	8284	662	90/B&N	16
8029R-K	639	8109-K	632	8179M	666	8285	662	90/S	16
8031R	639	8110	632	8180	667	8286	663	90/SP	16
8031R-K	639	8114	653	8181	667	8287	663	90AS	16
8032	639	8116	654	8181S	667	8290	663	90AS/S	16
8032-K	639	8120	652	8182	668	8293	663	90BA	308
8040EN	642	8120B	652	8182A	668	8297C	663	90K	555
8040EN-K	642	8120D	652	8182E	668	8297F	663	91	17
8040EZ	642	8120DZC	652	8182GD	668	8302Z	636	91BA	308
8040EZ-K	642	8129	653	8182H	668	8303Z	636	91HS	295
8041	641	8130	655	8182S	668	8317DZ	654	91HS-C	295
8041-K	641	8130A	655	8182T	668	8317SZ	654	92	17
8042EN	643	8131DL	655	8182TS	668	8381SL	654	92BA	308
8042EN-K	643	8131Z	655	8182H/2	669	8381SP	654	92HS	295
8042EZ	643	8135	650	8183	669	8381SX	663	93	17
8042EZ-K	643	8135/KCA	656	8184	669	8383C	654	93BA	308
8043	642	8135/KGF	656	8185	669	8383P	654	93C	17
8043-K	642	8135/KGM	656	8186	669	8515V	654	93HS	295
8044	643	8135/KLA1	656	8187	670	8515Z	654	93K	555
8048	636	8135/KMO	656	8188C	670	8515CH	655	94	17
8049	640	8139DL	655	8188CG/25	670	8531	655	94/S	17
8049A	641	8139Z	655	8188CU/25	670	8532	655	94K	555
8049V	641	8139ZCH	655	8188F	670	8535	655	95	17
8050 D	655	8143	650	8188F35	670	8600 R/11	581	95/S	17
8051S	650	8143/RKL	656	8188VFG2	670	8600 R/12	581	95BA	308
8051S-K	650	8143/RPC	656	8189	670	8600 R/113	582	95FTX	17
8052 - 8055S	649	8143/RKCI	657	8189A	670	8600 R/114	582	95FTX/S	17
8057R - 8057	649	8143/RPF	657	8189PA	670	8600 R/13	582	96	18
8058R - 8058	648	8146	651	8190	669	8600 R/225	582	96/B	18
8058R/PS	656	8146C	651	8190B	669	8600 R/412	582	96/BG7	18
8060R - 8060	648	8146/RK	657	8201T	659	8600 R/511	582	96/BGS7	18
								96/SC12	18

INDICE ALFANUMERICO

96/SC9	18	97BTXL	23	900FTX/SB9	87	910AN	96	920/25	103
96/ST	18	97BTXL/SC8	23	900FL	88	910A/C10	97	920/35A	103
96/ST6K	555	97RTX	23	900K	557	910A/C16	97	920/36A	103
96AS	19	97RTX/B	23	900L	86	910A/C16Q	97	920/38	103
96AS/B	19	97RTX/SC8	23	900L/SB	86	910A/C16HR	98	920/40	103
96AS/BG7	19	97TTX	23	900LP	87	910A/C17	98	920/42	103
96AS/SC9	19	97TTX/S	23	900M/R55	110	910A/C29	98	920/44	103
96AS/T	19	97TTX/SP	23	900MB	86	910AS/C13	98	920/46	103
96BA	308	97TTXHHS	295	900MB/L	86	910AS/MBM-C18	98	920/50	104
96BA/BP	308	97TX	22	900MB/SB	86	910B	93	920/50F	104
96BAF-AS	309	97TX/B	22	900MC	86	910B/SB	93	920/55	104
96BP	20	97TX/BG8	22	900MC/LP	87	910B/SN	94	920/55LC	104
96BP/SC9	20	97TX/G	22	900MC/PH	87	910BL	94	920/55Q	104
96BPC	20	97TX/SC8	22	900MC/TX	88	910BL/SB	94	920/55X	104
96BPC/SC9	20	97TX/ST	22	900ME	88	910BP	95	920/56A	104
96BP-CL	20	98XZN	23	900ME/SB8	88	910BP/SB6L	95	920/58	104
96BP-CL/SC9	20	98XZN/B	23	900M/35	89	910B/C10	97	920/C37	107
96BP/AS	21	99	23	900M/55	90	910B/C16	98	920/R50	111
96BP/ASB	21	99 VN/...	24	900MB/C19	91	910B/C16Q	98	920/R55	111
96BP/AS-SC9	21	99BA	309	900MB/C28	91	910B/C29	98	920/R55LC	111
96BPA	21	99SQ	23	900MC/C24	92	910CF	96	920/R55Q	111
96BPA/SC9	21	99ST	24	900MC/C32	92	910CF/SB	96	920/R55X	111
96BPINOX	302	900	86	900PH	87	910E-HS/56	296	920/55INOX	303
96BPINOX-AS	302	900/R55	110	900PH/SB4	87	910FTX	94	920/R55INOX	303
96BPINOX-AS/B9	302	900/R55-Z	110	900PZ	87	910FTX/SB	94	920/21K	558
96C-AS/SC9	19	900/20LK	557	900PE/AS	88	910FTX/L	95	920/25K	558
96C/AS	19	900/25K	558	900PT	88	910FTX/LSB	95	920/55K	558
96INOXBP/B	302	900/55K	558	900TX	88	910FTX/XL	95	920/58K	558
96L	20	900/55ZK	558	900TX/SB	88	910FTX-XL/C10	95	920A/AS	100
96L/SC12	20	900/58K	558	900T/44	89	910LP	95	920A-AS/SB11	100
96L/SP8	20	900/SB	86	900U	87	910M/R55	111	920AS	100
96LBP	20	900/...	88	900U/SB	87	910MQ/21	289	920AS/L	100
96LBP/SC9	20	900/16	88	900U/C12M	92	910MQ/22	289	920AS/SB11	100
96LC	19	900/25	88	902A/C22	93	910MQ/B	289	920ASL/SB11	100
96LC/SC12	20	900/32	89	902R/C6	93	910MQ/PE	289	920AN	103
96LC/SC8	20	900/35A	89	910/R55	111	910MQ/PT	289	920A/C11	105
96N	18	900/40	89	910/R55Q	111	910MQ/TX	289	920A/C12	105
96N/B	19	900/42	89	910/R55X	111	910MQ/XZN	289	920A/C12X	105
96N/G	19	900/55	89	910/21K	558	910MQ/55	290	920A/C20	105
96N/SC12	19	900/55Z	89	910/25K	558	910MQ/C16	290	920A/C20Q	105
96N/SC9	19	900/58	90	910/55K	558	910MQ/T	290	920A/C20X	105
96N/ST	19	900/C11	90	910/58K	558	910ME	95	920A/C21	106
96N/ST6K	555	900/C11Z	90	910/15	96	910ME/SB	95	920A/C21X	106
96T	21	900/C12MR	90	910/16	96	910M/35	96	920A/C33	106
96T/AS	21	900/C39N	90	910/20 - 910/21 -	96	910M/55	97	920A/C17M	107
96T/S11	21	900/C39U	90	910/22		910M/56	97	920A/C17MR	107
96T/S6	21	900/C12MZ	91	910/25	96	910PE	95	920AS/C10	107
96T/SP	21	900/C13-5	91	910/36A	97	910PE/AS	95	920AS/C15	107
96T/SPV	520	900/C13-8	91	910/40	97	910PE/SB	95	920AS/C17X	107
96TAS/S	21	900/C24	91	910/42	97	910PH	95	920AS/MBM-C21	107
96TBP	22	900/C11HR	93	910/46	97	910PH/SB4	95	920A/C17HR	108
96TBP/S6	22	900AS	86	910/55	97	910PT	96	920AK	558
96TBP-HS	295	900AS/MB	86	910/55Q	97	910PT/SB	96	920A	99
96THS	295	900AS/SB11	86	910/58	97	910TX	96	920A/SB13	99
96THS-AS	295	900AS/L	87	910AK	558	910TX/SB	96	920A/SB8	99
96TINOX	303	900AS/MBL	87	910A	93	910XZN	96	920AL	99
96TINOX/S6	303	900AN	88	910A/SB	93	911BA	309	920AL/SB11	99
96TINOX-AS	303	900AS/C10	92	910AL	93	911BA/16	309	920BP	101
96TINOX-AS/S8	303	900AS/C17-MBM	92	910AL/SB14	93	911BA/20	309	920BP/SB	101
96TK	556	900AS/MB-C17	92	910A/AS	94	911BA/55	309	920B/C11	105
97BTX	22	900BG/30K	558	910A-AS/SB13	94	914MQ/A	290	920B/C12	105
97BTX/B	22	900BG/30	89	910AS	94	914MQ-A/S4	290	920B/C12X	105
97BTX/SC8	22	900BG/30C	89	910AS/L	94	920/15	103	920B/C20	105
97BTX-C	22	900E-HS/56	296	910AS/SB13	94	920/16	103	920B/C20X	106
97BTX-C/SC8	22	900FTX	87	910AS/SN	94	920/20+920/23	103	920B/C21	106
				910ASL/SB12	94				

INDICE ALFANUMERICO

920B/C21X	106	921BA/50	310	944BX/D	114	960PI/S	122	991	126
920B/C30Q	106	921BA/R50	310	944BX/S	114	960PMC	122	992	126
920B/C33	106	921BA-AS	310	944BX/DG	570	960RPI	122	993	126
920B	99	926BA	310	949	114	960S	119	993G	127
920B/SB13	99	926BA/15	310	949/S6	114	960SL	119	993MQ	291
920B/SB8	99	926BA/22	310	950	114	960SN	119	993PL	126
920BL	99	926BA/42	310	950/S	114	960T/A	119	994	127
920BL/SB11	99	926BA/50	311	951	115	960T/B	119	994MQ	291
920ES	102	926BA/R50	311	951/S	115	960T/C11	119	994PL	127
920ES/SB	102	928.../C12	109	951/SP	115	960T/C	120	994TF	127
920ES/XL-SB	102	928/15	109	951AS	115	960T/D	120	996	127
920E-HS/55LC	296	928/16	109	951AS/S	115	960T/E	120	998	127
920FTX	100	928/20 - 928/21 -	109	951BA	311	960T/F	120	999	127
920FTX/C	100	928/22		951K	559	960T/G	120	999/B6N	127
920FTX/L	100	928/25	109	951MQ	291	960T/H	120	999A	127
920FTX/LSB	100	928/36A	109	951TX	115	960T/I	120	999B	127
920FTX/SB	100	928/42	109	951TX/S	115	960T/L	120	999C	127
920INOX-A	303	928/55	109	952	116	960T/M	120	999D	127
920LH/SB7	101	928/R55	111	952/S	116	960UC	122	999E	127
920LP	101	928/R55X	111	952AS	116	960VTC	122	999G	127
920ME	101	928A	108	952FTX	116	960YP	121	9500TL	672
920ME/SB	101	928AS	108	952FTX/S	117	961BA	311	9501TL	672
920ME/C	102	928AS/C12	109	952L	116	961P6	123	9501TLD	672
920M/35	103	928B	108	953	117	961P6/S	123	9502TL	673
920M/35L	103	928B/C12	109	953/S	117	962	123	9503TL	673
920M/55	104	928ME	108	953TX	117	962C	123	9504TL	673
920M/56	104	929	109	953TX/S	117	962M	123	9505TL	673
920MC/C14	105	929/15	110	955	117	962P	123	9508TL	673
920M/R55	111	929/21 - 929/22	110	956C	117	963	123	9510W	673
920MQ/21	290	929/42	110	956E	117	963BA	311	9515M	676
920MQ/22	290	929/55	110	956F	117	964	123	9516B	676
920MQ/55A	290	929/55PR	110	956L	118	964BA	311	9521	676
920MQ/A	290	929/C8	110	957	118	964BA/L	311	9521OB	676
920MQ/PE	290	929/R55	111	959	118	965	123	9522A	681
920MQ/T	290	930	111	959R	118	965/S	123	9523T	678
920MQ/C16	291	930/C	111	960	118	965BA	311	9523A	681
920MC	99	930/S	111	960/22EP	120	966/C3	123	9524SC	678
920PE	101	932	112	960/C6	120	966BA	311	9525/B	675
920PE/AS	101	932/S	112	960/D	120	966BA/V	311	9525F	675
920PE/C	101	932HS	296	960A	118	969/C5	124	9525TL	675
920PE/SB	101	933	112	960AVE	121	969B	124	9526P	681
920PE-AS/SB6	101	933/S	112	960AVL	122	970B	124	9526RMN	681
920PH	101	935	112	960AD/TP2	177	970IVECO	124	9527 6T	681
920PH/SB4	101	935/S	112	960BC	118	971/C8	124	9527MUG	681
920RTX	102	935K	558	960BC/C5	118	972/C10	124	9528B	678
920RTX/SB	102	937	112	960BC/P 28	118	972/C4BMW	124	9534WO	673
920TX	102	937/S	112	960BT/B	118	973	124	9534BO	674
920TX/C	102	937BA	311	960CMB	121	978 - 979	124	9537TL	674
920TX/L-SB4	102	937K	558	960CMB/R2	121	982	125	9539CB	676
920TX/SB	102	940	112	960CMD	121	983 PM/R-DA	125	9541BIKE	675
920TX/C17	108	941	113	960CMD/R1	121	983PM	125	9541F	675
920U	100	941/S	113	960ER	119	984	125	9541PC	675
920U/SB13	100	942BX	113	960EPC	121	985/B7	125	9541S	675
920U/SB4	100	942BX/S	113	960EPC/L	121	985F	125	9542M	676
920U/C17M	108	942BX/DG	570	960E-PI/P	121	985M	125	9542AL	677
920XZN	102	943BX	113	960F	119	986 48	125	9542AT	677
920XZN/LS	102	943BX/D	113	960G	119	986 78	125	9542C	677
920XZN/SB12	102	943BX/S	113	960H/C4	119	986PT	125	9542G	677
920XZN/SB7	102	943BXX	559	960KC-M8/M9/M10	121	987	125	9542GW	677
921BA	310	943BX/DG	570	960KPC	122	987AR	126	9542S	677
921BA/15	310	943FL	113	960L	119	987P	126	9543C	677
921BA/16	310	943FL/S	113	960M	119	988/K4	126	9544C	674
921BA/21 - 921BA/22	310	943MQ	291	960P	122	989	126	9547T	678
921BA/25	310	943MQ/S	291	960PI	122	989A	126	9547WSK	678
921BA/42	310	943MQ/BG	570	960PI/C19	122	989B	126	9547	681
		944BX	114			990	126		

INDICE ALFANUMERICO

9548G	678	9597P	678	C11 - 2111	349	C45PRO M7	432	C55M4	410
9548KB	678	9598WHP-N	676	C12 - 2112	349	C45PRO M7A/W	429	C55M7	410
9548KB 20	678	9598W-N	676	C13	349	C45PRO M7A/X	429	C55M8	411
9548KB 24	678	9599 GARAGE	673	C14	349	C45PRO M8	433	C55MA	412
9549ABW	680	9599CB-N2	676	C16 - 2116	350	C45PRO MA	434	C55MDO	412
9549BP	680	9599CB-W	676	C18 - 2118	350	C45PRO ML	434	C55MP	418
9549CR	680	9711 - LUBRIBETA	524	C19 - 2119 - C19L - 2119L	351	C45PRO MS	433	C55MS	413
9549MPC	680	universal				C45PRO MWS/W	430	C55P/2MDX-SX	414
9549SBW	680	9713 - Ultra Sblock	524	C20 - C20L - 2120	351	C45PRO MWS/X	429	C55P/MCD	414
9549BRW	681	9721 - Multi Grease	524	C20TSS	304	C45PRO PAS	436	C55PB/3	401
9549C	681	9723 - Lithium Grease	524	C22B	351	C45PRO PF	436	C55PFA-0,8	416
9557J 2.0	675			C22P	351	C45PRO PFE	437	C55PFA-1,0	414
9557N	675	9725 - PTFE Grease	525	C22W	351	C45PRO PM	438	C55PM	414
9559	679	9727 - Copper Grease	525	C25	368	C45PRO PML	438	C55PM/M0,8	416
9559/30MT	679			C27S	369	C45PRO RD	433	C55PRO B/2	402
9561V	679	9730 - Silic Spray	525	C30M	371	C45PRO SL	436	C55PRO B/2,8	403
9561V 2,5	679	9739 - Cutting Oil	525	C35/6GM	372	C45PRO SS	436	C55PRO B-D4	404
9561VV	679	9741 - Brake Cleaner	525	C35/7GM	373	C45PRO T3	435	C55PS	417
9561VV 2,5	679	9742 - Multi Cleaner	525	C35/8GM	373	C45PRO TC	435	C55PSE	417
9562T1	278	9743 - Contact Cleaner	525	C35/9GM	373	C45PRO W	424	C55PT0,8x0,6	416
9562T3	278	9744 - Surface Cleaner	525	C37/6	375	C45PRO X	423	C55PT1,0x0,6	415
9562T2	397			C37/7	374	C45PW/1-0,7MT	430	C55PTE-0,8	416
9562TB	630	9746 - Carb Cleaner	525	C37/8	375	C45PW/2-1,3MT	430	C55PTE-1,0	415
9562P12	683	9747 - Clima Cleaner	526	C37A/7	375	C45PW/3-2,0MT	431	C55RB	407
9562P2	683	9750 - Air Spray	526	C38	377	C45PX/1-0,7MT	430	C55STR	422
9563G	680	9753 - Zinc 98%	526	C38C	378	C45PX/2-1,3MT	430	C55T3	413
9563U	680	9756 - Welding Spray	526	C38L	377	C45PX/3-2,0MT	431	C56	394
9565S	630	9766 - De-icer Spray	526	C38L A	377	C45STR	439	C56B	394
9565BBQ	679	9776 - Water Stop	526	C38T	378	C48M	386	C56M	395
9565T	679	9801L	522	C39/6	380	C48P	386	C56P O	389
9565ICE	680	9802M	522	C39/7	379	C51	387	C56PL O	389
9565K	680	9803H	522	C39/8	380	C54S	390	C56W	394
9569MS	682	9811L	522	C39MD	382	C55	400	C57SA	391
9569MS-2	682	9812M	522	C39SM	382	C55/1PF	416	C57SB	392
9569P	682	9813H	522	C39T	380	C55/2PM	415	C57SC	392
9569S	682	9821L	523	C41H	383	C55/PF	414	C57SD	391
9572LB	673	9822M	523	C41H/CE	383	C55/PL-1,024	407	C57SP	393
9574B	675	9823H	523	C41S	383	C55A1	420	C58B	395
9574O	675	9831L	523	C42H	384	C55A1/R42	420	C58M	395
9577R	679	9832M	523	C45LMP	440	C55A2	421	C58M/PA	396
9579C	679	9833H	523	C45PRO ACT	435	C55A2/R70	421	C58P	393
9580S	674	9841N	524	C45PRO AS1	439	C55AB	401	C59A	396
9586K	681	9841R	524	C45PRO AS2	439	C55AC	418	C59B	397
9587 13x21	682	9852	524	C45PRO AW	424	C55AE	417	C59C	397
9587 9x14	682	9881U	264	C45PRO AX	424	C55AT1	422	C62M/W	629
9588M	682	9882R	264	C45PRO BPW-1,3	428	C55AT2	422	C64/1	629
9588S/10...	682	9899 CV/A	110	C45PRO BPW-2,0	428	C55B PT/2	407	C64CW	630
9588/10PI	683	9899 CV/B	110	C45PRO BPX-1,3	427	C55B PT/2,8	407	C64G/1	630
9589A/36	683	9899 CV/C	110	C45PRO BPX-2,0	428	C55B/1	419	C68	574
9589B/36	683			C45PRO BW	425	C55B/2	402	C68 G	574
9590B	679			C45PRO BX	425	C55B/2,8	403	C68N	574
9592B/C50	681			C45PRO C5	431	C55B/G	405	C88 R/1	574
9592B/P	681	C04TSS-7	368	C45PRO C7	431	C55B/GAA	405	C88NR/1	574
9592M/50	681	C04TSS-8	305	C45PRO CAI/W	438	C55B/GAE	406	C88SE	574
9592MB	681	C3	347	C45PRO CAI/X	438	C55B/GDP	405	C88VE	574
9593A	674	C4 - 2104	347	C45PRO CORNER/W	437	C55B/GDS	405	C99	352
9593M	674	C5 - 2105	347	C45PRO CORNER/X	437	C55B/GE	406	C99C-V3	355
9593S	674	C5S	347	C45PRO CW	427	C55B/VS	407	C99M	356
9593SB	674	C6T - 2106	348	C45PRO CX	427	C55B-D4	404	C99P	355
9593W	674	C7 - 2107	348	C45PRO DW	426	C55C	419	C99P12-V0	353
9594	681	C8 - 2108	348	C45PRO DX	425	C55C7	408	C99PC	356
9595 C25	682	C8B	348	C45PRO EW	426	C55C8	409	C99PP	356
9595C	682	C9 - 2109	348	C45PRO EX	426	C55CS	411	C99P-V3	356
9595T	682	C9/RT	348	C45PRO M3A	434	C55KAI	418	C99T	356
9596	682	C10 - 2110	348	C45PRO M4	432	C55KAS	418	C99T-V3	356
		C10S - 2110S	349	C45PRO M5	432	C55M2	409	C99V0	352

INDICE ALFANUMERICO

C99V0-P12	353	M125	498	MC20	504	T45	509	T201	515
C99V1	354	M126	499	MC21	504	T46	509	T202	515
C99V2	354	M127	499	MM105	506	T48	509	T204	515
C99V3/2C	355	M128	499	MM11	506	T50	509	T205	515
CA49-G	385	M129	499	MM140	507	T52	509	T206	515
CB/2	520	M133	499	MM210	507	T53	509	T207	515
CB52	388	M134	499	MM400	507	T55	509	T208	515
CD23S	358	M135	499	MM401	507	T57	510	T209	515
CP	440	M136	499	MM61	506	T59	510	T211	515
CP15 - 2115	349	M137	499	MM63	506	T63	510	T213	515
CP15L - 2115	350	M145	499	P		T64	510	T216	515
CP17 - CP17L - 2117	350	M153	500				T65	510	T221
CP51	388	M161	500	PM 1/2-Q5	102	T68	510	T226	516
CX49-G	385	M162	500	PM/5C	440	T73	510	T227	516
G, K		M166	500	PM/6C	440	T75	510	T228	516
		M170	500	PV	393	T76	510	T231	516
GM	519	M172	500	R		T77	510	T233	516
KIT/GPS	519	M174	500				T79	510	T234
M		M180	500			T80	511	T236	516
		M195	500	RSC22	357	T81	511	T239	516
M01	494	M201	500	RSC23	358	T82	511	T241	516
M02	494	M204	501	RSC23C	358	T83	511	T250	516
M05	494	M208	501	RSC23T	359	T85	511	T256	516
M06	494	M209	501	RSC24/5	361	T91	511	T259	517
M13	494	M213	501	RSC24/6	361	T92	511	T264	517
M25	494	M214	501	RSC24/7	360	T99	511	T270	517
M30	494	M216	501	RSC24/8	361	T100	511	T273	517
M33	494	M217	501	RSC24A/6	362	T101	511	T281	517
M31	494	M218	501	RSC24A/7	362	T102	511	T284	517
M33	494	M219	501	RSC24A/8	362	T103	512	T285	517
M38	494	M222	501	RSC24AXL/7	363	T105	512	T289	517
M39	495	M226	501	RSC24AXL/8	364	T106	512	T291	517
M40	495	M227	502	RSC24AXL/9	364	T111	512	T297	518
M44	495	M230	502	RSC24L/7	367	T112	512	TSPP	519
M45	495	M231	502	RSC24L-CAB	367	T113	512	V	
M46	495	M234	502	RSC28	370	T121	512		
M49	495	M236	502	RSC51	387	T123	512	VE1	519
M50	495	M237	502	S		T124	512	VP1 - VP2	518
M52	495	M240	502				T135	512	VP3 - VP4
M53	495	M264	502	S42/17	520	T136	512	VP5	518
M55	495	M284	503	S55/12	519	T137	512	VP6	518
M60	496	M285	503	S55/8	519	T138	513	VP-3SC	518
M62	496	M289	503	S96T/8	520	T140	513	VP-LD	518
M63	496	M292	503	S951/6	520	T144	513	VP-LS	518
M65	496	M295	503	S952/10	520	T145	513	VPM	507
M67	496	M305	503	S1719BM	520	T146	513	VPM0	507
M69	496	M310	503	SB	519	T151	513	VPM3	507
M75	496	M400	503	SGN	520	T153	513	VPM7	507
M78	496	M401	503	SPC	440	T156	513	VPM7-C	507
M79	496	MB	519	SPG11 - S1203/8	520	T157	513	VPM8	507
M82	496	MB12	504	ST2P	519	T160	513	VPM9	507
M83	497	MB37	504	T		T161	513		
M85	497	MB38	504				T164	513	
M86	497	MB39	504	T01	508	T167	514		
M91	497	MB44	505	T05	508	T168	514		
M92	497	MB45	505	T06	508	T170	514		
M94	497	MB46	505	T13	508	T171	514		
M96	497	MB47	505	T18	508	T172	514		
M100	497	MB56	505	T19	508	T173	514		
M105	498	MB58	505	T22	508	T175	514		
M108	498	MB59	505	T23	508	T176	514		
M110	498	MB63	506	T31	509	T177	514		
M112	498	MB64	506	T33	509	T180	514		
M115	498	MB65	506	T34	509	T183	514		
M120	498	MC10	504	T40	509	T198	514		
M121	498	MC12	504	T41	509	T199	515		

CONDIZIONI GENERALI DI VENDITA

Gli ordini trasmessi per l'acquisto di prodotti dalla Beta Utensili SpA (d'ora in poi "Beta" o "Società") comportano l'accettazione automatica e senza riserve delle presenti Condizioni Generali di Vendita che costituiscono parte integrante del contratto di vendita. Eventuali deroghe alle stesse saranno efficaci solo se concordate per iscritto dalle parti e limitatamente alle vendite cui si riferiscono.

PRODOTTI

I pesi, le dimensioni, i prezzi, i colori e gli altri dati figuranti nei cataloghi, prospetti, circolari, od altri documenti illustrativi della Società, hanno carattere di indicazioni approssimative.

Beta si riserva di variare in qualsiasi momento, senza preavviso, i dati tecnici o costruttivi dei suoi prodotti.

ORDINI

Le presenti Condizioni Generali di Vendita si intendono approvate dall'acquirente con la trasmissione dell'ordine, ordine che viene ricevuto dalla Società sempre con la clausola "salvo approvazione della casa". Beta può accettare l'ordine mediante spedizione della merce, conformemente all'art. 1327 c.c..

Nell'ordine deve essere specificato il codice dell'articolo e la relative quantità. Le quantità minime sono indicate nel listino per ciascun articolo. Ordini non corrispondenti ad esse, od ai loro multipli, verranno automaticamente adeguati senza previa autorizzazione al Cliente.

RIMANENZE

La Società si riserva la facoltà di evadere l'ordine tutto o in parte ovvero in diverse riprese. Nell'eventualità di ordini non completamente evasi Beta invierà tramite e-mail una distinta riepilogativa delle rimanenze di detti ordini che, salvo espressa richiesta contraria, saranno incluse nella o nelle spedizioni successive. Previa specifica richiesta del Cliente tali informazioni verranno trasmesse via fax.

TERMINI DI CONSEGNA

Eventuali termini di consegna, comunque e dovunque previsti, avranno valore puramente indicativo. La Società declina ogni responsabilità per il caso di ritardo nella consegna che non derivi da suo dolo o colpa grave. Il mancato rispetto dei termini di consegna, purché contenuto in un ragionevole lasso di tempo, non dà diritto al Cliente di richiedere un risarcimento, né di annullare gli Ordini, a meno che, avuto riguardo alla normale tollerabilità ed alla natura del contratto ed alla fornitura, la stessa non abbia più importanza per il Cliente. In questo caso l'onere probatorio sarà a carico del Cliente stesso.

Salvo il caso di dolo o colpa grave della Società, è espressamente escluso qualsiasi risarcimento del danno per mancata o ritardata consegna dei prodotti.

GESTIONE ORDINI, SPEDIZIONI E IMBALLI

Le spedizioni sono effettuate franco destino, con mezzi di trasporto a scelta della Società per gli ordini netti superiori ad € 600,00.

Per gli ordini inferiori ad € 600,00 verrà addebitato a titolo di contributo spese di trasporto il seguente importo:

contributo fisso di € 10,00 fino ad € 199,99

contributo pari al 3,50% da € 200,00 ad € 599,99.

L'imballo è gratuito quando non richiesto di tipo particolare.

Il trasferimento dei rischi relativi ai prodotti ha luogo al momento della loro consegna al Vettore: conseguentemente, i prodotti viaggiano a rischio e pericolo del destinatario anche in caso di spedizione porto franco.

L'Acquirente che sia già cliente abituale potrà utilizzare il **nostro servizio rapido** anche per quantità diverse dall'unità di confezionamento previste. Il costo del servizio verrà addebitato nella misura forfetaria del 6% in sede di fatturazione e le spese di spedizione saranno a carico del Cliente.

PREZZI

L'indicazione di prezzo contenuta in cataloghi, listini, ecc. è meramente indicativa e potrà quindi subire variazioni senza necessità di preventiva informazione. Salvo diverso accordo tra le parti, la merce sarà fatturata ai prezzi in vigore al momento della spedizione.

I prezzi si intendono al netto di iva, di eventuali imposte o tasse, nonché di tributi, diritti ed oneri fiscali o di qualsiasi specie eventualmente gravanti sul contratto che restano a carico esclusivo del Cliente.

PAGAMENTI

Il pagamento deve essere corrisposto direttamente presso la sede della Società in Via Volta n. 18 - 20845 SOVICO (MB) ovvero alla persona munita di autorizzazione scritta con le modalità e nei termini indicati nella fattura.

Sconti per pagamenti a breve termine vanno calcolati sull'importo netto della merce, escluso imballo, spese postali o di trasporto e iva. Trascorsi 15 giorni dalla data della fattura o dal periodo concordato, si intende revocato il beneficio dello sconto condizionato e pertanto la rimessa andrà effettuata per il totale della fattura. Il ritardato pagamento rispetto alla data pattuita darà luogo all'addebito degli interessi di mora di cui all'art. 5 del D.Lgs. 231/02 e produrrà la perdita per il Cliente del beneficio del termine ai sensi dell'art. 1186 cod. civ., rendendo immediatamente esigibili eventuali somme non ancora scadute.

Il Cliente non è autorizzato ad effettuare alcuna deduzione dal prezzo pattuito (ad es. in caso di pretesi difetti dei prodotti), se non previo accordo scritto con la Società.

GARANZIA

I prodotti venduti da Beta sono garantiti in relazione a vizi o difetti di fabbricazione; la garanzia è limitata alla sostituzione o riparazione dei prodotti riconosciuti difettosi presso la sede della Società, con esclusione di qualsiasi diritto al risarcimento dei danni. La suddetta garanzia non si applica a prodotti che presentano normale usura, segni di manomissione o di uso improprio. Le spese di trasporto dei prodotti da sostituire o riparare e dei prodotti sostituiti o riparati sono a carico dell'Acquirente. In presenza dei presupposti di cui al comma precedente Beta sostituirà o riparerà gratuitamente il Prodotto riscontrato difettoso all'origine se reso franco sede della Società con relativo documento di trasporto sul quale dovranno essere indicati, oltre alla dicitura merce difettosa, gli estremi della fattura emessa all'atto della vendita.

Salvo il caso di dolo o colpa grave, la Società sarà tenuta, in caso di vizi o mancanza di qualità dei prodotti, unicamente alla riparazione o sostituzione dei prodotti difettosi. È inteso che la suddetta garanzia (consistente nell'obbligo di riparare o sostituire i prodotti) comprende e sostituisce ogni garanzia o responsabilità della Società (sia contrattuale che extracontrattuale) comunque originata dai prodotti forniti (ad es. risarcimento del danno, mancato guadagno ecc.).

RECLAMI

Il Cliente deve denunciare gli eventuali vizi e difetti dei prodotti forniti o l'eventuale mancata o difforme fornitura di tutto o parte dell'Ordine d'Acquisto, a pena di decadenza, entro il termine di 8 (otto) giorni da calcolarsi rispettivamente dalla data di consegna dei prodotti (vizi apparenti) e/o da quella della scoperta dei vizi o difetti (vizi occulti). Nel caso di vizi palesi la denuncia dovrà essere fatta per iscritto a mezzo di lettera raccomandata a.r..

Eventuali contestazioni non danno diritto al Cliente di sospendere o comunque ritardare i pagamenti dei prodotti oggetto di contestazione né, tanto meno, di altre forniture.

La garanzia non opera nel caso in cui l'Acquirente abbia eseguito o fatto eseguire interventi da parte di terzi sui prodotti, senza il preventivo consenso scritto di Beta. La merce difettosa, qualora non presenti inconvenienti dovuti a normale logorio, errato uso o evidente manomissione, verrà riparata o sostituita gratuitamente solo se restituita in porto franco presso la sede della Società, indicando nel documento di accompagnamento la causale e gli estremi della fattura relativa.

RESI

Eventuali resi di merce vengono accettati solo se preventivamente concordati e autorizzati per iscritto; contrariamente saranno rispediti al mittente con trasporto a proprio carico.

In ogni caso nel documento di accompagnamento devono essere indicati la causale del reso ed il numero di autorizzazione ricevuto.

Tali resi dovranno essere inviati presso la sede della Società in Via Volta n. 18 - 20845 SOVICO (MB).

FORO COMPETENTE

Le presenti Condizioni Generali di Vendita sono regolate dalle leggi della Repubblica Italiana. Per tutto quanto non espressamente regolato dalle presenti condizioni, sarà applicata la normativa del codice civile.

Per qualsiasi controversia derivante dal contratto di vendita disciplinati dalle presenti Condizioni Generali di Vendita o ad esso collegata sarà esclusivamente competente il Foro di Monza, fatte comunque salve diverse inderogabili norme di legge.

CONDIZIONI GENERALI DI VENDITA

Gli ordini trasmessi per l'acquisto di prodotti Robur dalla Beta Utensili SpA (d'ora in poi "Beta" o "Società") devono essere inviati alla nostra sede produttiva di Sulmona e comportano l'accettazione automatica e senza riserve delle presenti Condizioni Generali di Vendita che costituiscono parte integrante del contratto di vendita. Eventuali deroghe alle stesse saranno efficaci solo se concordate per iscritto dalle parti e limitatamente alle vendite cui si riferiscono.

PRODOTTI

I pesi, le dimensioni, i prezzi, i colori e gli altri dati figuranti nei cataloghi, prospetti, circolari, od altri documenti illustrativi della Società, hanno carattere di indicazioni approssimative.

Beta si riserva di variare in qualsiasi momento, senza preavviso, i dati tecnici o costruttivi dei suoi prodotti.

ORDINI

Le presenti Condizioni Generali di Vendita si intendono approvate dall'acquirente con la trasmissione dell'ordine, ordine che viene ricevuto dalla Società sempre con la clausola "salvo approvazione della casa". Beta può accettare l'ordine mediante spedizione della merce, conformemente all'art. 1327 c.c..

Nell'ordine deve essere specificato il codice dell'articolo e la relative quantità.

Le quantità minime sono indicate nel listino per ciascun articolo. Ordini non corrispondenti ad esse, od ai loro multipli, verranno automaticamente adeguati senza previa autorizzazione al Cliente.

RIMANENZE

La Società si riserva la facoltà di evadere l'ordine tutto o in parte ovvero in diverse riprese. Nell'eventualità di ordini non completamente evasi Beta invierà tramite e-mail una distinta riepilogativa delle rimanenze di detti ordini che, salvo espressa richiesta contraria, saranno incluse nella o nelle spedizioni successive. Previa specifica richiesta del Cliente tali informazioni verranno trasmesse via fax.

TERMINI DI CONSEGNA

Eventuali termini di consegna, comunque e dovunque previsti, avranno valore puramente indicativo. La Società declina ogni responsabilità per il caso di ritardo nella consegna che non derivi da suo dolo o colpa grave. Il mancato rispetto dei termini di consegna, purché contenuto in un ragionevole lasso di tempo, non dà diritto al Cliente di richiedere un risarcimento, né di annullare gli Ordini, a meno che, avuto riguardo alla normale tollerabilità ed alla natura del contratto ed alla fornitura, la stessa non abbia più importanza per il Cliente. In questo caso l'onere probatorio sarà a carico del Cliente stesso.

Salvo il caso di dolo o colpa grave della Società, è espressamente escluso qualsiasi risarcimento del danno per mancata o ritardata consegna dei prodotti.

GESTIONE ORDINI, SPEDIZIONI E IMBALLI

Le spedizioni sono effettuate franco destino con addebito delle spese in fattura con mezzi di trasporto a scelta della Società.

L'imballo è gratuito quando non richiesto di tipo particolare.

Il trasferimento dei rischi relativi ai prodotti ha luogo al momento della loro consegna al Vettore: conseguentemente, i prodotti viaggiano a rischio e pericolo del destinatario anche in caso di spedizione porto franco.

L'Acquirente che sia già cliente abituale potrà utilizzare il **nostro servizio rapido** anche per quantità diverse dall'unità di confezionamento previste. Il costo del servizio verrà addebitato nella misura forfetaria del 6% in sede di fatturazione e le spese di spedizione saranno a carico del Cliente.

PREZZI

L'indicazione di prezzo contenuta in cataloghi, listini, ecc. è meramente indicativa e potrà quindi subire variazioni senza necessità di preventiva informazione. Salvo diverso accordo tra le parti, la merce sarà fatturata ai prezzi in vigore al momento della spedizione.

I prezzi si intendono al netto di iva, di eventuali imposte o tasse, nonché di tributi, diritti ed oneri fiscali o di qualsiasi specie eventualmente gravanti sul contratto che restano a carico esclusivo del Cliente.

PAGAMENTI

Il pagamento deve essere corrisposto direttamente presso la sede della Società in Via Volta n. 18, 20845 Sovico (MB) ovvero alla persona munita di

autorizzazione scritta con le modalità e nei termini indicati nella fattura.

Sconti per pagamenti a breve termine vanno calcolati sull'importo netto della merce, escluso imballo, spese postali o di trasporto e iva. Trascorsi 15 giorni dalla data della fattura o dal periodo concordato, si intende revocato il beneficio dello sconto condizionato e pertanto la rimessa andrà effettuata per il totale della fattura.

Il ritardato pagamento rispetto alla data pattuita darà luogo all'addebito degli interessi di mora di cui all'art. 5 del D.Lgs. 231/02 e produrrà la perdita per il Cliente del beneficio del termine ai sensi dell'art. 1186 cod. civ., rendendo immediatamente esigibili eventuali somme non ancora scadute.

Il Cliente non è autorizzato ad effettuare alcuna deduzione dal prezzo pattuito (ad es. in caso di pretesi difetti dei prodotti), se non previo accordo scritto con la Società.

GARANZIA

I prodotti venduti da Beta sono garantiti in relazione a vizi o difetti di fabbricazione; la garanzia è limitata alla sostituzione o riparazione dei prodotti riconosciuti difettosi presso la sede della Società, con esclusione di qualsiasi diritto al risarcimento dei danni. La suddetta garanzia non si applica a prodotti che presentano normale usura, segni di manomissione o di uso improprio. Le spese di trasporto dei prodotti da sostituire o riparare e dei prodotti sostituiti o riparati sono a carico dell'Acquirente. In presenza dei presupposti di cui al comma precedente Beta sostituirà o riparerà gratuitamente il Prodotto riscontrato difettoso all'origine se reso franco sede della Società con relativo documento di trasporto sul quale dovranno essere indicati, oltre alla dicitura merce difettosa, gli estremi della fattura emessa all'atto della vendita.

Salvo il caso di dolo o colpa grave, la Società sarà tenuta, in caso di vizi o mancanza di qualità dei prodotti, unicamente alla riparazione o sostituzione dei prodotti difettosi. È inteso che la suddetta garanzia (consistente nell'obbligo di riparare o sostituire i prodotti) comprende e sostituisce ogni garanzia o responsabilità della Società (sia contrattuale che extracontrattuale) comunque originata dai prodotti forniti (ad es. risarcimento del danno, mancato guadagno ecc.).

RECLAMI

Il Cliente deve denunciare gli eventuali vizi e difetti dei prodotti forniti o l'eventuale mancata o difforme fornitura di tutto o parte dell'Ordine d'Acquisto, a pena di decadenza, entro il termine di 8 (otto) giorni da calcolarsi rispettivamente dalla data di consegna dei prodotti (vizi apparenti) e/o da quella della scoperta dei vizi o difetti (vizi occulti). Nel caso di vizi palesi la denuncia dovrà essere fatta per iscritto a mezzo di lettera raccomandata a.r..

Eventuali contestazioni non danno diritto al Cliente di sospendere o comunque ritardare i pagamenti dei prodotti oggetto di contestazione né, tanto meno, di altre forniture.

La garanzia non opera nel caso in cui l'Acquirente abbia eseguito o fatto eseguire interventi da parte di terzi sui prodotti, senza il preventivo consenso scritto di Beta. La merce difettosa, qualora non presenti inconvenienti dovuti a normale logorio, errato uso o evidente manomissione, verrà riparata o sostituita gratuitamente solo se restituita in porto franco presso la sede della Società, indicando nel documento di accompagnamento la causale e gli estremi della fattura relativa.

RESI

Eventuali resi di merce vengono accettati solo se preventivamente concordati e autorizzati per iscritto; contrariamente saranno rispediti al mittente con trasporto a proprio carico.

In ogni caso nel documento di accompagnamento devono essere indicati la causale del reso ed il numero di autorizzazione ricevuto.

Tali resi dovranno essere inviati presso la sede produttiva della Società in Zona Industriale - Contrada S. Nicola - 67039 SULMONA (AQ).

FORO COMPETENTE

Le presenti Condizioni Generali di Vendita sono regolate dalle leggi della Repubblica Italiana. Per tutto quanto non espressamente regolato dalle presenti condizioni, sarà applicata la normativa del codice civile.

Per qualsiasi controversia derivante dal contratto di vendita disciplinati dalle presenti Condizioni Generali di Vendita o ad esso collegata sarà esclusivamente competente il Foro di Monza, fatte comunque salve diverse inderogabili norme di legge.

ORGANIZZAZIONE DI VENDITA

**Beta****Robur****VALLE D'AOSTA****PIEMONTE:** Torino, Novara, Vercelli, Biella, Verbano-Cusio-Ossola**MARCO MARTORANA**

Cell. 392.4135190
mezzarana@libero.it
marco.martorana1969@hotmail.it

LIGURIA**PIEMONTE:** Alessandria, Asti, Cuneo**ALESSANDRO DE SANCTIS**

Cell. 348.3008699
Fax 019.90085
alessanc@libero.it

LOMBARDIA SUD OVEST: Lodi, Pavia, Milano città, provincia Sud Milano**LUIGI FUMAGALLI SAS**

Cell. 335.214487
lfrappresentanze@tiscalinet.it

LOMBARDIA NORD EST: Provincia Est Milano, Bergamo, Lecco**AVIDANO SIMEONI**

Cell. 335.5296941
ufficio@avidanosimeoni.it

LOMBARDIA NORD OVEST: provincia Nord Milano, Monza, Como, Sondrio, Varese**SIGI & AGI SRL****Sig. Gianluca D'auria**

Tel. 333.9191400
Cell. 345.7996019
info@sigieagi.com

LOMBARDIA SUD EST: Brescia, Mantova, Cremona**VENETO:** Verona**MARCO VESENTINI**

Cell. 346.0831683
Fax 0376.809741
info@marcovesentini.it

TRENTINO ALTO ADIGE**VENETO:** Vicenza**TARGA SERGIO & C. SAS**

Cell. 348.4112065
targa_s70@yahoo.it

VENETO: Padova, Rovigo, Belluno, Treviso, Venezia**FRIULI VENEZIA GIULIA****NICOLA MION**

Cell. 335.8427204
Fax 0422.452468
n.mion@virgilio.it

EMILIA ROMAGNA: Modena, Parma, Reggio Emilia, Piacenza**MARCO PERVILLI**

Cell. 335.7013227
m.pervilli@gmail.com

EMILIA ROMAGNA: Bologna, Ferrara, Ravenna, Forlì-Cesena, Rimini**REP. SAN MARINO****RIEM - MARCO MALAGUTI**

Tel. 051.6257778
Cell. 335.5488324
Fax 051/6257627
info@nuovariem.com

TOSCANA**STEFANO CAMERINI**

Cell. 347.5084765
Fax 055.289350
camerini.stefano@tiscali.it

MARCHE - UMBRIA**ALEX CAPPANERA**

Cell. 339.4718269
Fax 0731.205528
alex@cappanera.it

ABRUZZO - MOLISE:  **Beta****MAURO BISOGNINI**

Tel. 071.2862055
Cell. 333.2250049
info@maurobisognini.it
www.maurobisognini.it

ABRUZZO - MOLISE:  **Robur****FRANCESCO BIBONE**

Cell. 328/2827915
Fax 085.2058663
fbibone@yahoo.it

LAZIO**DANIELE MARINELLI**

Tel. 06.8177774
Cell. 335.5394617
Fax 06.39725066
marinelliagenzia@tiscali.it

CAMPANIA: Benevento, Caserta, Napoli Nord**ANTONINO SCOGNAMIGLIO**

Cell. 335.5281534
Fax 081.2140299
antonino.scognamiglio@fastwebnet.it

CAMPANIA: Avellino, Salerno, Napoli Sud**ESPOSITO RAPPRESENTANZE**

Cell. 335.6212740
Fax 081.2140299
alfredo-esposito@fastwebnet.it

PUGLIA**NICOLA MORISCO**

Cell. 335.5489086
Tel. 080/5016492
info@moriscorappresentanze.it

BASILICATA**VINCENZO GALLITELLI**

Cell. 335.1436354
vincenzo.gallitelli@libero.it

CALABRIA**DOMENICO ARAGONA**

Cell. 337.872220 (Domenico)
Cell. 339.8740220 (Francesco)
Fax 0984.465320
aragonarappresentanze@gmail.com

SICILIA EST: Messina, Catania, Siracusa, Ragusa, Enna**SALVATORE TUDISCO**

Cell. 335.8064374
Cell. 335.6273038 (Biagio Amato: SR, RG)
info@agenziatudisco.it

SICILIA OVEST: Palermo, Trapani, Caltanissetta, Agrigento**DANIELE MARGIOTTA**

Cell. 334.8016524
danielemargiotta@tiscali.it

SARDEGNA: Oristano, Cagliari, Carbonia-Iglesias, Medio Campidano**PI.CO - LUCIANO COMPARETTI**

Cell. 349.4977448
Fax 070.513150
pico.comparetti@gmail.com

SARDEGNA: Sassari, Nuoro, Ogliastra, Olbia-Tempio**PI.CO - SALVATORE PILLA**

Cell. 349.4977449
Fax 079.501493
pico.pilla@gmail.com



IL NOSTRO **SERVIZIO RAPIDO**

1. Possibilità di acquistare qualsiasi articolo a listino senza obbligo di quantità
 2. Consegna in tutta Italia nelle 24 ore per ordini pervenuti entro le ore 11.00 (48 ore per Basilicata, Calabria, Sardegna, Sicilia)
- A. Gli ordini devono essere inviati unicamente tramite fax al numero 800.978.377 o via e-mail a: servizio.rapido@beta-tools.it
- B. Il costo del servizio verrà addebitato nella misura forfettaria del 6% in sede di fatturazione
- C. Le spese di spedizione sono a carico del cliente



È possibile effettuare il ritiro della merce con mezzi propri ai seguenti indirizzi:

- 📍 Magazzino sede Beta - via Volta 18, 20845 Sovico (MB)
- 📍 Polo logistico TIESSE S.p.a. - Via Arno 8
20098 San Giuliano Milanese (Mi)
- 📍 GEODIS CL ITALIA S.p.a - SP23 località Cascina Postino
26815 Massalengo (LO)



8 Unità
produttive
IN ITALIA



Circa **900**
collaboratori

11 Filiali
nel mondo

Presenti in più
di **100 Paesi**
nel mondo
con oltre **250**
importatori



BETA UTENSILI S.p.A. - 20845 Sovico (MB)
Via A. Volta, 18 - Tel. 039.2077.1 - Fax 039.2010742
www.beta-tools.com

Sede produttiva Accessori per funi Robur:
67039 Sulmona (AQ) Zona industriale - C.da S. Nicola
Tel. 0864.2504.1 - Fax 0864.253132
www.roburity.com - info@roburity.com

LA STORIA DELL' UTENSILERIA ITALIANA

- 1923** ● Alessandro Ciceri fonda ad Erba (CO) la stamperia "Alessandro Ciceri & Figli", specializzata in stamperie di ferro e acciaio.
- 1939** ● Viene depositato il marchio Beta e l'Azienda si specializza nella **produzione di utensili per uso professionale**, realizzati nello stabilimento di Sovico (MB), ancora attuale sede aziendale.
- 1960** ● Beta Utensili conta già 200 dipendenti, si afferma in Italia quale realtà emergente nel settore dell'utensileria a mano professionale ed esporta i propri prodotti all'estero.
- 1969** ● Nasce il rivoluzionario **carrello "Tank"** in lamiera arancione, il colore che, da quel momento in poi, renderà inconfondibile lo stile del marchio Beta.
- 1971** ● Beta Utensili entra nel mondo delle **competizioni motoristiche**, dapprima in Formula 1, poi nelle gare di rally e nel mondo del Motorsport.
- 1973** ● Si inaugura lo **stabilimento di Castiglione d'Adda (LO)**, che si aggiunge a quello storico di Sovico (MB).
- 1975** ● Arriva il primo grande successo in Formula 1 con la **March-Beta Utensili** di colore arancione di Vittorio Brambilla che vince il Gran Premio d'Austria nel diluvio di Zeltweg.
- 1980** ● Continua l'espansione nei più importanti mercati Europei con la **costituzione progressiva di filiali Beta Utensili** in Francia, Gran Bretagna, Olanda, Spagna, Polonia e Ungheria.
- 1984** ● Apre il **terzo stabilimento** dell'azienda a **Sulmona (AQ)**. Qui ha inizio, nella forgia, la produzione delle iconiche chiavi combinate 42 e vengono prodotti e testati gli accessori per il sollevamento a marchio Robur.
- 1995** ● In soli 8 mesi l'Azienda ottiene la certificazione **Sistema di Qualità ISO 9001**.
- 2000** ● La presentazione del nuovo catalogo Beta Utensili conferma il **continuo processo di crescita**. Raddoppia la gamma dei prodotti in offerta e le oltre 10.000 referenze vengono suddivise in 22 famiglie di prodotto.
- 2002** ● L'offerta Beta Utensili viene ulteriormente ampliata con l'introduzione della gamma di **abbigliamento e calzature da lavoro**.
- 2009** ● Beta espande ulteriormente i propri mercati aprendo la nuova filiale Beta Cina.
- 2012** ● Apre la filiale Beta Brasile.
- 2016** ● Beta introduce il nuovo sistema modulare per l'arredo officina RSC55.
- 2018** ● Inizia il percorso di consolidamento del **Gruppo Beta** con l'acquisizione di **BM S.p.A.**, leader nella produzione e commercializzazione di capicorda e sistemi di connessione elettrica. Si susseguono le acquisizioni di **3D Beta S.r.l.**, società specializzata nella progettazione e produzione di sistemi di arredo officina su misura e **VGF S.r.l.**, specialista nella verniciatura a polveri di arredi in metallo. La strategia di crescita del Gruppo continua con le acquisizioni di **Abra Beta S.p.A.** ed **Elpa Abrasivi S.r.l.**, leader nella produzione di abrasivi, ampliando così la propria offerta di articoli professionali.
- 2020** ● Nasce **Beta Tools USA**, un passo importante nella strategia di espansione sul mercato nordamericano.
- 2023** ● **Da 100 anni un percorso di crescita continuo** che arriva fino ad oggi, con una gamma che include **30 famiglie di prodotto** e oltre **16.000 referenze**, realizzate per rispondere alle esigenze dei professionisti e garantire qualità e prestazioni costanti nel tempo, seguendo il principio **Beta Well Done**, perché in Beta esiste un solo modo di fare le cose: farle bene.



1923 Alessandro Ciceri & Figli



1939 Reparto forgia



1955 Reparto tranciatura



1960 Progettazione



1969 Carrello Tank



1974 Pubblicità assortimenti



1975 Vittorio Brambilla



2002 Abbigliamento e calzature da lavoro

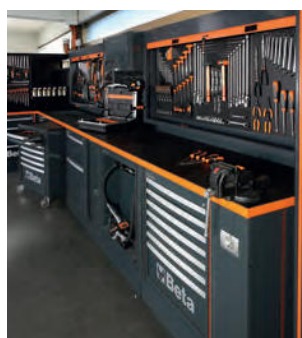

2016 Arredo officina RSC55

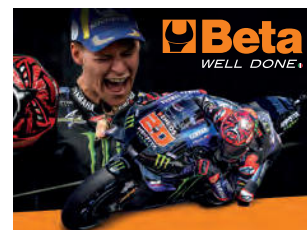

2022 Fabio Quartararo, Beta Ambassador

QUALITÀ CERTIFICATA

Beta dal 2018 si fregia del prestigioso marchio **TÜV**, ottenuto superando gli stretti controlli del protocollo di prova EK5/TA5.

Il protocollo EK5/TA5 prevede 31 caratteristiche costruttive ben definite, stringenti test statici e test di comportamento dinamico. Altri test definiscono la resistenza alle alte e basse temperature, la durata delle marcature nel tempo e la resistenza alla corrosione.

Il raggiungimento di questi traguardi premia la progettazione esperta, la realizzazione accurata e i controlli stringenti che Beta attua nella produzione di cassettiere e che ne hanno garantito fino ad oggi il grande successo.



CONTROLLO E QUALITÀ

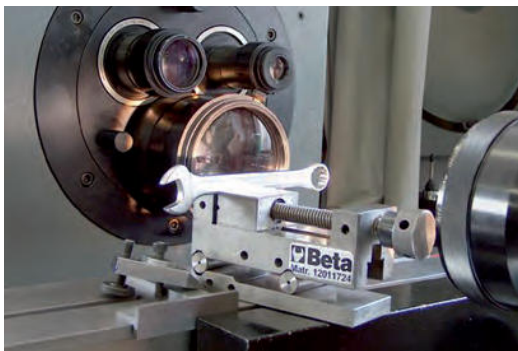

Per Beta la qualità ha un significato semplice e concreto: ciò che soddisfa in modo completo le esigenze e le aspettative dei professionisti che fanno del nostro prodotto uno strumento fondamentale per il loro lavoro.

L'utensile non è solo studiato e realizzato correttamente per adempiere alla sua funzione, ma garantisce la ripetitività delle prestazioni in modo omogeneo nel tempo.

La qualità in Beta non si esprime solo con un'attenta politica industriale e commerciale, ma permea ogni divisione aziendale con il medesimo orientamento al raggiungimento di obiettivi sempre più ambiziosi in termini di soddisfazione della clientela.

È su questo concetto che Beta ha costruito la sua storia.

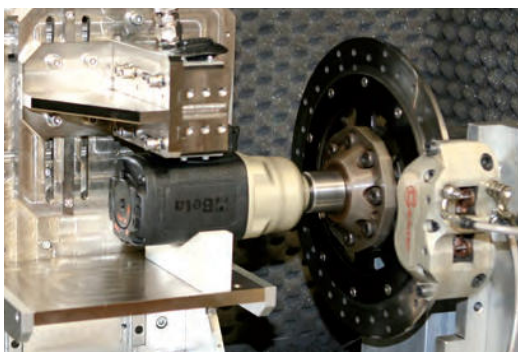

**Qualità Beta,
l'aspetto più
concreto**

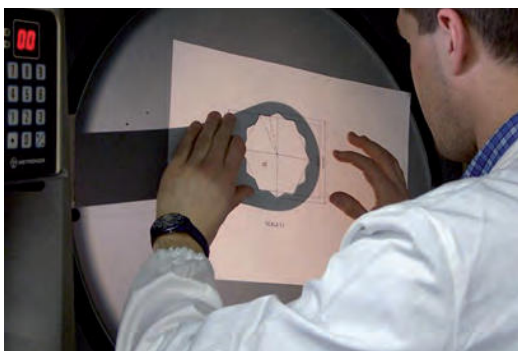

**La qualità degli
utensili Beta
è la sintesi
di tecniche antiche
e nuove tecnologie.**



Dal 1995 i processi produttivi sono certificati conformi agli standard del Sistema di Qualità ISO 9001



PROFESSIONALITÀ E COMPETENZA AL SERVIZIO DELL'INDUSTRIA



Gli utensili Beta sono da sempre protagonisti nella manutenzione industriale grazie alla storica e capillare presenza dei nostri partner distributori lungo tutta la penisola.

Grazie alla qualità ed alle alte prestazioni i prodotti Beta supportano ogni esigenza professionale e sono scelti quotidianamente da importanti industrie dell'automotive, dell'energia, dell'aeronautica, del navale e molti altri settori in Italia e nel mondo. Ma è il forte legame con i nostri distributori sul territorio che ci permette di servire tante delle piccole, medie e grandi industrie italiane, vero motore del nostro Paese.

Con l'obiettivo di migliorare ulteriormente il servizio di consulenza e portare innovazione e competenze nel fitto tessuto industriale italiano continuiamo ad investire con la squadra di **Sales Manager Industria**, professionisti a cui rivolgersi per:

- ▶ Identificazione di nuove opportunità di business
- ▶ Soluzioni operative presso le industrie
- ▶ Supporto tecnico - commerciale
- ▶ Ottimizzazione delle dotazioni di utensili nei reparti produttivi
- ▶ Personalizzazione delle isole di lavoro
- ▶ Aggiornamenti su tutte le novità di prodotto



La costante interazione con gli utilizzatori, sempre supportata dalla collaborazione con i nostri partner distributivi, è uno dei punti cardine del nostro miglioramento continuo nel comparto industriale.

Rivolgetevi al vostro agente Beta di zona per avere il contatto dei **Sales Manager Industria** a vostra disposizione per supportarvi nel servizio e contribuire ad accrescere il vostro business.



LOGISTICA



22.000 m²
di superficie



16.000
i codici gestiti
con oltre **27.000**
unità di carico



**Consegne
veloci, accurate
e complete**



ORGANIZZAZIONE DEL LAVORO

5S è una metodologia di organizzazione dell'area di lavoro di origine giapponese. Trae il nome dalla trascrizione occidentale di 5 parole giapponesi: **seiri, seiton, seiso, seiketsu e shitsuke**.

Seguendo i 5 passaggi identificati dalle parole si ottiene un metodo sistematico e ripetibile per l'ottimizzazione degli standard di lavoro e per il miglioramento delle performance operative.



SEIRI

Seleziona

Elimina il superfluo dallo spazio di lavoro e mantieni solo gli strumenti di cui hai bisogno.



SEITON

Sistematizza

Crea ordine: ogni cosa al suo posto e un posto per ogni cosa.



SEISO

Sistema

Pulisci il tuo spazio di lavoro e mantieni l'ordine nel tempo.



SEIKETSU

Standardizza

Stabilisci delle metodologie ripetitive per continuare a razionalizzare le risorse e gli spazi, definendo uno standard da seguire.



SHITSUKE

Supporta

Sostieni e diffondi questo modo di pensare e di agire in tutte le attività aziendali.



BENEFICI



Risparmio di tempo e riduzione dei costi



Miglioramento della qualità e della produttività



Riduzione degli infortuni sul lavoro



Incremento dell'efficienza



PRIMA



DOPO

PRESENZA COMPETENTE

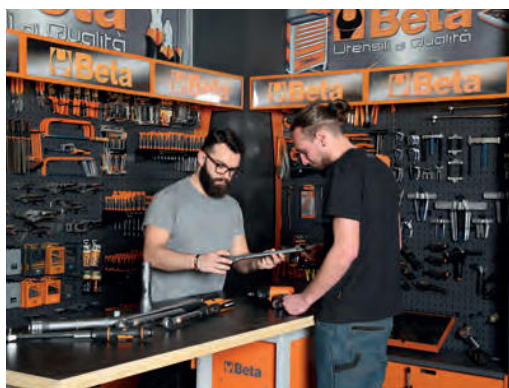

I **Promotori Tecnici** guidano la flotta dei Van dimostrativi Beta fino ai luoghi di lavoro per ascoltare le esigenze di chi utilizza ogni giorno gli utensili in modo professionale. È uno scambio reciproco di informazioni, indicazioni, consigli e soluzioni, che arricchiscono la conoscenza di entrambe le parti.

I Van Beta sono allestiti con le ultime novità e con le attrezzature più complesse: l'utilizzatore può testare i prodotti, vedere come funzionano, e valutarne qualità e caratteristiche.



**Unità
dimostrativa**

Fabio Quartararo

2022 MotoGP
World Championship



Partnership 2022

 **Beta**

50 Years in Motorsports

PARTNERSHIP

2022



TEAM
speedup

ALONSO LOPEZ
Moto2 World
Championship



Technical
Partner



Beta | **aprilia**
RACING TEAM



998069102

