

INNOVATION
SINCE 1929.

CATALOGO GENERALE

AGGIORNATO AL 08/04/2021

Fami nasce come azienda specializzata nella produzione di allestimenti industriali. Negli anni vengono investite importanti risorse ed energie per valorizzare la professionalità, tessere una ricca rete di relazioni, trasformare la ricerca sui materiali in prodotti sempre più funzionali ed innovativi e di elevata qualità. Fami è una realtà consolidata, si sviluppa in divisioni produttive su una superficie di 230 mila mq. di cui 95 mila coperti e dove operano 400 persone. Ha quattro filiali all'estero, Germania, Polonia, Svizzera, Austria e distributori autorizzati in tutto il mondo. Ogni anno vengono utilizzati otto milioni di chili di ferro e acciaio. La produzione è totalmente interna al gruppo con una divisione specializzata nell'arredo industriale ed una nell'allestimento di veicoli commerciali.



ECOLOGIA

Eco-sostenibilità e sviluppo sostenibile sono argomenti di grande attualità, scaturiti dalla presa di coscienza che i cicli cambiamenti e rinnovamenti devono compiersi nel rispetto dei delicati equilibri ambientali, e soprattutto, che le risorse destinate alle generazioni future non devono essere depauperate. Presto spiegata la ragione per cui Fami S.r.l., da sempre al passo con le innovazioni tecnologiche, ha conquistato il primato di azienda eco sostenibile nel mondo dell'arredo industriale, implementando sui tetti dei capannoni aziendali un impianto fotovoltaico su una superficie di copertura di 45.000 mq. L'impianto è composto di ben 6140 pannelli di silicio policristallino, ottimi per qualità e stabilità di rendimento, costante e garantito per circa 25 anni, che occupano una superficie complessiva di 9824 mq, producendo il 44% del fabbisogno annuo dell'azienda.



BRAND

Store Van è un marchio del gruppo FAMI, nasce nel 2003 dalla volontà della proprietà e dalla necessità di coprire una richiesta di mercato molto precisa, quella dell'allestimento dei veicoli commerciali. Store Van si sviluppa, con i suoi studi di progettazione e produzione, all'interno della casa madre FAMI, respira la stessa aria innovativa e ne condivide la filosofia e la gestione manageriale. Store Van è presente con i suoi affiliati in tutto il territorio nazionale ed europeo ed è proiettata ad uno sviluppo più capillare e coordinato. Store Van è un marchio giovane, che continua la tradizione e conferma l'affidabilità di una grande azienda. Nasce sotto i migliori auspici e come FAMI, crede ed è caratterizzato dalla duttilità del proprio prodotto, elemento che lo distingue e che l'ha fatto diventare oggi motivo d'orgoglio dell'intero gruppo industriale e partner valido per i suoi clienti. L'incremento dell'efficienza produttiva e il rendimento inteso come qualità del tempo impiegato è di grande importanza per ogni azienda, ecco perché Store Van propone la sua gamma di accessori d'allestimento per furgoni commerciali. Store Van, studia, progetta, realizza, produce ed allestisce tutti gli spazi interni, avvalendosi di soluzioni ed accessori progettati e personalizzati ad ogni tipo di richiesta.



www.storevan.com



COSA UTILIZZIAMO

METALLO

Se al principio veniva lavorata con rudimentali attrezzi manuali, nel corso del tempo è stata tranciata, deformata ed assemblata dalla forza impetuosa delle prime presse, per giungere ai nostri giorni, contraddistinti dall'avvento dell'elettronica, a subire trattamenti produttivi dedicati con cui il metallo viene modellato, forato, assemblato e rivestito per fornire prodotti esclusivi. Grazie all'utilizzo di processi produttivi industrializzati, a tecnologie all'avanguardia e alla competente professionalità da primato dello staff, negli stabilimenti Fami entra la materia prima ed esce l'oggetto finito e performante che il cliente si aspetta.



LEGNO

Il legno è sempre stato un materiale vivo e come tale, durante le lavorazioni deve essere trattato con molta cautela. È necessario conoscerlo per scegliere il corretto senso di taglio, la giusta attrezzatura per modellarlo e il rivestimento appropriato che ne esalti le caratteristiche. Le essenze utilizzate sono molto nobili: il faggio tipo di legno molto duro e resistente, risulta perfettamente adattabile al contatto con parti metalliche mentre la betulla, che manifesta un ottimale rapporto peso/resistenza, è usata per i rivestimenti ai veicoli commerciali.

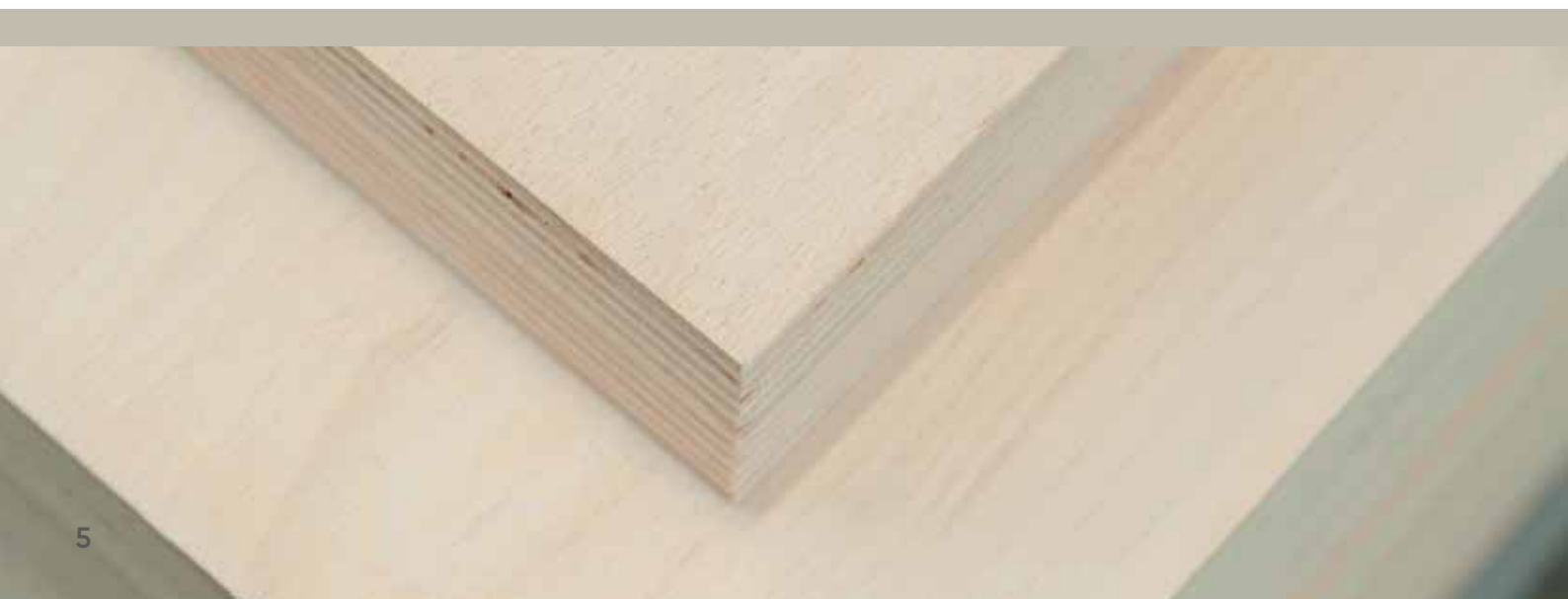

PROCESSI PRODUTTIVI

METALLO

Sfruttare al massimo le possibilità offerte dalla tecnologia più avanzata - sia in termini di automazione che di gestione della produzione - e dedicare particolare attenzione alle dinamiche del "fare bene" sono le risorse salienti di una realtà aziendale di successo. La divisione del metallo dispone di tutte le attrezzature che possono trasformare un semplice foglio di lamiera in oggetto finito e funzionante: le linee automatiche di lavorazione, le isole robotizzate di assemblaggio e gli impianti di verniciatura automatici sono solo alcune delle potenzialità in forza al settore produttivo di Fami. Il personale addestrato e capace, che gestisce e sprona l'azienda a ricercare soluzioni sempre più idonee a lavorare il metallo, è la nostra punta di diamante, il propulsore imprescindibile che spinge alla quotidiana accelerazione verso lo sviluppo.



LEGNO

Anche la lavorazione del legno è altamente meccanizzata, fruendo di un pantografo a controllo numerico che, programmaticamente, pratica le lavorazioni sul pezzo per ottenere il componente necessario. Il legno viene prelevato e trasportato nei pressi delle linee di lavorazione, dove dei robot gestiscono le operazioni di prelievo e caricamento dello stesso nelle macchine per le lavorazioni, mentre altri eseguono, automaticamente, la sostituzione degli utensili necessari alla pratica di applicazione d'inserti filettati, alla realizzazione di fori di riscontro e alla sagomatura.

VERIFICA LA CONSEGNA DEI TUOI ORDINI



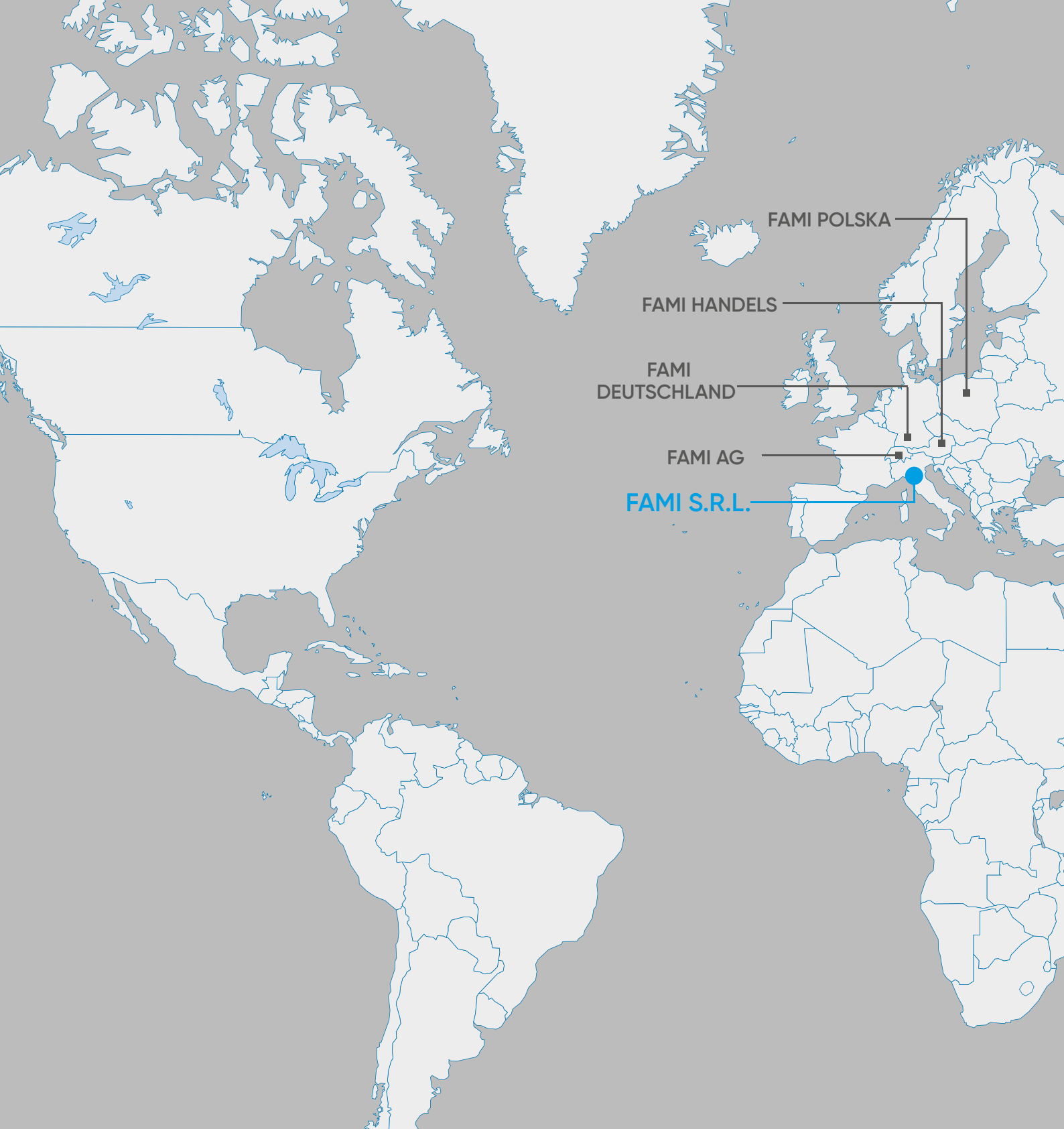

FAMI POLSKA

FAMI HANDELS

FAMI
DEUTSCHLAND

FAMI AG

FAMI S.R.L.

FAMI S.R.L.

Via Stazione Rossano, 13
36027 Rosà (VI) - ITALY
phone: + 39 0424 585455
fax: +39 0424 585470
commerciale@famispa.com
www.famispa.com
EXPORT DEPARTMENT
phone: +39 0424 585455
fax: +39 0424 585472
export@famispa.com
www.famispa.com

FAMI DEUTSCHLAND

Fami Deutschland GmbH
Riedweg, 14
89340 Leipheim, Deutschland
phone: +49 8221 2787-0
fax: +49 8221 2787-27
info@fami.de - www.fami.de

FAMI AG

Industrie Süd
8573 Siegershausen, Switzerland
phone: +41/71 - 6991914
fax: +41/71 - 6991912
info@fami-ag.ch - www.fami-ag.ch



FAMI HANDELS GmbH
Triester Strasse, 136
1230 Wien
Austria
phone: +43/1 - 6629889
fax: +43/1 - 662988915
office@fami.at
www.fami.at

FAMI POLSKA Sp. z o.o.
Ul. Wielkopolska, 3 E
26-100 Radom, Polska
phone: +48/48 - 3845850
fax: +48/48 - 3845851
famipoland@fami.com.pl
www.fami.com.pl

INDICE

	ARMADI	15-501
	ECOLOGIA	502-517
	SISTEMI PORTAUTENSILI NC	518-635
	POSTAZIONI DI LAVORO	636-673
	BANCHI DA LAVORO	674-883
	CARRELLI	884-935
	SISTEMI DI STOCCAGGIO	936-1113
	SCAFFALI	1114-1257



MASTER	15
· 408x573mm (18x27 EH)	37
· 561x573mm (27x27 EH)	57
· 714x573mm (36x27 EH)	77
· 1020x573mm (54x27 EH)	109
· 561x726mm (27x36 EH)	137
· 714x726mm (36x36 EH)	159
· 867x726mm (45x36 EH)	191
· 1020x726mm (54x36 EH)	213
· 1190x726mm (64x36 EH)	239
· 1428x726mm (78x36 EH)	261
· angoli 727x726 (36x36 EH)	283



STANDARD	295
· 564x726mm (27x36 EH)	299
· 717x726mm (36x36 EH)	307
· 1023x726mm (54x36 EH)	307



FLEXA	318
· 564x600mm (27x27 EH)	321
· 717x600mm (36x27 EH)	331
· 1023x600mm (54x27 EH)	343
· angoli 602x600mm (27 EH)	351



MATERIALE DI SEPARAZIONE	356
---------------------------------	------------



PERFOM	368
· A 110	372
· A 120	376
· A 140	382



· A 124	386
· A 130	392
· A 220	396



· A 700	406
· A 500	412
· A 300	418
· A 800	424
· A 600	432
· A 400	438



PERFOM GS/FS	446
· GS 130	450
· GS 230	451
· GS 140	452
· GS 240	453
· GS 150	456
· GS 250	457
· GS 160	458
· GS 260	459
· GS 170	462
· GS 180	486



· GS 190	467
----------	-----



· FS 1000	468
· FS 1100	469
· FS 1200	470
· FS 700/730	494



· perfom multiuso	472
-------------------	-----



STANDARD CS	477
--------------------	------------



MASTER CS	492
------------------	------------

ECOLOGIA

502



ARMADI DI SICUREZZA PER VERNICI E SOLVENTI, FITOSANITARI 504

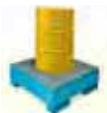

VASCHE E CARRELLI PORTA FUSTI 506



SUPPORTI FUSTI 508



PORTA CISTERNA IN ACCIAIO 509



MASTER FO 510

SISTEMI PORTAUTENSILI NC

518



NC COMBI - PERFOM 518
· boccole 523



NC COMBI
· 1064x512 mm 528
· 1073x685 mm 530



NC PERFOM
· 1023x555 mm (54x27 EH) 538
· 2046x600 mm (54x27 EH) 542



NC MASTER 550
· 36x27 EH 554
· 54x27 EH 577
· 36x36 EH 599
· 54x36 EH 616

POSTAZIONI DI LAVORO













636



DYNAMIC 636
· 1000 mm (larghezza) 644
· 1500 mm (larghezza) 645
· 2000 mm (larghezza) 647
· piano lavoro ad angolo 652







BANCHI DA LAVORO













674

	WORK MASTER	678		WORK ROL-STANDARD	802
	WORK STANDARD	710		WORK MOBILE-MASTER	816
	WORK STEEL UP - ROL UP	724		WORK MOBILE-FLEXA	830
	WORK STEEL	734		WORK-ESA	840
	WORK SYSTEM	766		WORK LOOK	844
	WORK ROL-MASTER	784		SEDIE/MORSE/GANCI	874

CARRELLI

884

	CLEVER SMALL • 904x515 mm	888		COMBI • 945x525 mm • 1135x625 mm • 1425x825 mm • 1425x525 mm • 1425x625 mm	902 908 914 920 924
	CLEVER LARGE • 1024x615 mm	892		COMBI CR • 765x560 mm • 555x445 mm	930 933
	COMBI CE	896		CARRELLO SCALA	934

	EURO BOX	946		METALLO	1030
	· Euro box	959		· cassette in metallo	1034
	· Euro box light	968		· cassette forate	1036
	NESTABLE BOX	974		· contenitori in metallo	1038
	· Nestable box	976		· containers metallici	1044
	· Nestable box light	978		· pallets in lamiera	1045
	PICKING BOX	982		· containers in rete	1048
	STORAGE BOX	990		SMART	1060
	RK BOX	996		SLICK	1084
	VISUAL BOX	1008		SYSTEM TR	1092
	· Sistema verticale	1025		STORAGE DOMINO	1108
	STEP MAT	1029		PERFOM AK	1118
					

SCAFFALI

1114



SYSTEM ST 1126

- configura il tuo scaffale 2000 mm 1134
- configura il tuo scaffale 2200 mm 1140
- configura il tuo scaffale 2500 mm 1144
- configura il tuo scaffale 3000 mm 1148
- carrello scala 1175
- scaffalatura porta pneumatici 1176



SYSTEM SR-MASTER 1182



SYSTEM AR 1248

TUTTO IN ORDINE



ART. M 33 A100 E2 12 NY FD

Dim. mm 714x726x1023 H

Armadio serie Master con 7 cassetti completo di set di suddivisione e predisposizione utensili Beta.

Colore acciaio grigio chiaro RAL 7035 + blu genziana RAL 5010

Colore plastiche sky blue

UTENSILI ESCLUSI

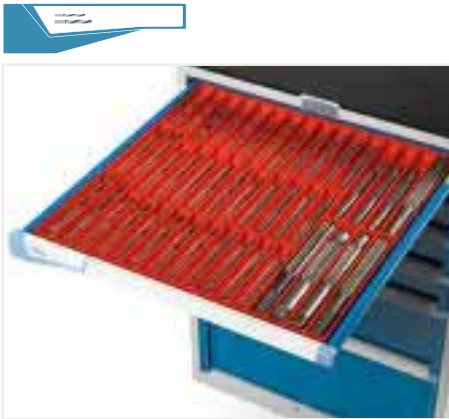

CASSETTO 1 - H 50 mm

Set composto da 16 divisori a 4 canali e 65 divisori trasversali 36 mm

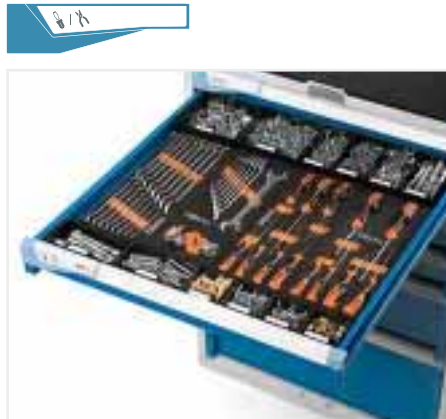

CASSETTO 2 - H 75 mm

*Set di predisposizione per termoformati Beta 4 Unit
UTENSILI E TERMOFORMATO ESCLUSI



CASSETTO 3 - H 75 mm

*Set di predisposizione per termoformati Beta 4 Unit
UTENSILI E TERMOFORMATO ESCLUSI



CASSETTO 4 - H 100 mm

*Set di predisposizione per termoformati Beta 4 Unit
UTENSILI E TERMOFORMATO ESCLUSI



CASSETTO 5 - H 100 mm

Set composto da 3 divisori longitudinali fessurati 610 mm e 15 divisori trasversali 149 mm



CASSETTO 6 - H 200 mm

Set composto da 2 divisori longitudinali fessurati 610 mm e 3 divisori trasversali 200 mm



CASSETTO 7 - H 300 mm

1 divisore longitudinale fessurato 610 mm

***SET DI PREDISPOSIZIONE PER TERMOFORMATO BETA**

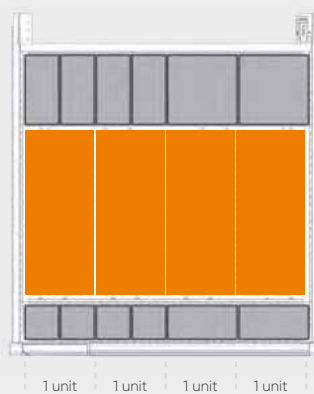

TUTTO IN ORDINE



ART. M 32 R080 P2 12 NR FD

Dim. mm 780x573x988 H

Armadio serie Master con 6 cassetti completo di set di suddivisione e predisposizione utensili Beta.

Ruote in gomma antritraccia sintetica Ø 125 mm

Colore acciaio grigio chiaro RAL 7035 + blu genziana RAL 5010

Colore plastiche sky blue

UTENSILI ESCLUSI



CASSETTO 1 - H 75 mm

Set composto da 12 divisori a 4 canali e 50 divisori trasversali 36 mm
UTENSILI ESCLUSI



CASSETTO 2 - H 75 mm

*Set di predisposizione per termoformati Beta 4 Unit
UTENSILI E TERMOFORMATO ESCLUSI



CASSETTO 3 - H 100 mm

*Set di predisposizione per termoformati Beta 4 Unit
UTENSILI E TERMOFORMATO ESCLUSI



CASSETTO 4 - H 100 mm

Set composto da 3 divisori longitudinali fessurati 455 mm e 8 divisori trasversali 149 mm



CASSETTO 5 - H 150 mm

Set composto da 2 divisori longitudinali fessurati 455 mm e 3 divisori trasversali 200 mm



CASSETTO 6 - H 200 mm

1 divisorio longitudinale fessurato 455 mm

***SET DI PREDISPOSIZIONE PER TERMOFORMATO BETA**

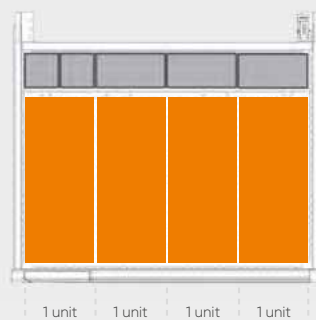

TUTTO IN ORDINE



ART. M CA C270 S0 12 04 FD

Dim. mm 2000x750x840 H

Banco serie Master con 3 cassetti completo di set di suddivisione e predisposizione utensili Beta.

Ruote in gomma antitraccia sintetica Ø 125 mm

Colore acciaio grigio chiaro RAL 7035 + blu genziana RAL 5010

Colore plastiche sky blue

UTENSILI ESCLUSI

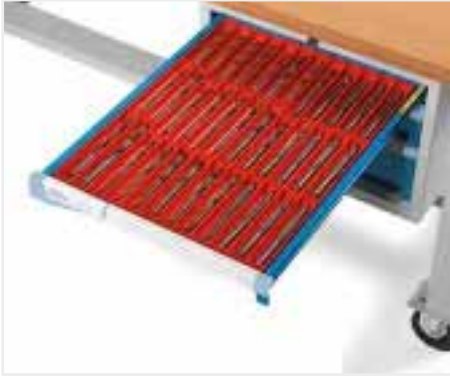

CASSETTO 1 - H 50 mm

Set composto da 12 divisori a 4 canali e 50 divisori trasversali 36 mm
UTENSILI ESCLUSI



CASSETTO 2 - H 100 mm

*Set di predisposizione per termoformati Beta
4 Unit
UTENSILI E TERMOFORMATO ESCLUSI



CASSETTO 3 - H 150 mm

Set composto da 2 divisori longitudinali fessurati 610 mm e 3 divisori trasversali 149 mm

***SET DI PREDISPOSIZIONE PER TERMOFORMATO BETA**

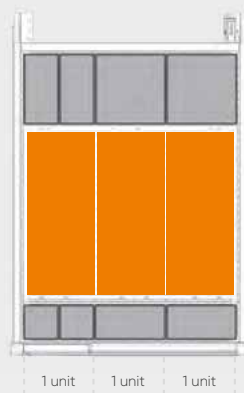

INNOVAZIONE
ELEGANZA
FLESSIBILITÀ

L'ARMADIO CHE CAMBIA GLI ARMADI

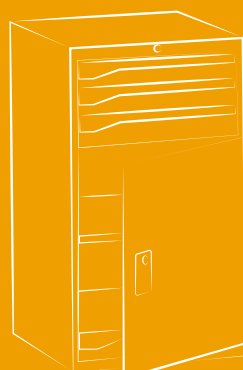
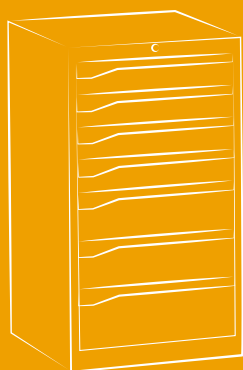



MASTER

ARMADIO MASTER

L'idea nasce nel 2009 con l'obiettivo di reinventare il concetto di armadio. Per reinventare qualcosa bisogna reinventare se stessi. Così Fami ha ripensato il proprio reparto ricerca & sviluppo, con 6 nuovi cervelli, ingegneri meccanici ed elettronici specializzati nell'automazione e nell'industrializzazione del progetto.

Armadio progettato per soddisfare e adattarsi alle esigenze del cliente. Un prodotto che implica una precisione produttiva e operativa mai vista prima. Una simbiosi di tecnologia e funzionalità atta ad ottimizzare il flusso di lavoro.

300
prototipi

1.000.000
test

4 ANNI
di sviluppo

4
brevetti

1
modello di DESIGN unico al mondo

3 TIPOLOGIE DI CHIUSURA



CHIUSURA CON CILINDRO (KEY)



CHIUSURA CON CODICE NUMERICO (CODE)



CHIUSURA CON CODICE NUMERICO CON TELECOMANDO (REMOTE)

2 SOFTWARE GRATUITI



PERSONALIZZAZIONE DELLE ETICHETTE



DOWNLOAD STORICO EVENTI PER SERRATURA A CODICE

2 TIPOLOGIE DI ESTRAZIONE



ESTRAZIONE FLESSIBILE

92% = 100 kg

96% = 75 kg

100% = 50 kg



ESTRAZIONE TELESCOPICA

100% = 200 kg

5 CARATTERISTICHE CHE LO RENDONO UNICO



SISTEMI DI CHIUSURA AD ELEVATA SICUREZZA ANTIELUSIVA



CONO VISIVO DEL CASSETTO MAGGIORE DEL 30% RISPETTO AGLI STANDARD FAMI

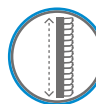

INNOVATIVA ASTA ANTIRIBALTAMENTO A MOVIMENTO VERTICALE, PER UNA MAGGIORE SILENZIOSITÀ E DURATA NEL TEMPO



CASSETTO SETTABILE PER ESTRAZIONE E PORTATA DIRETTAMENTE DAL CLIENTE



CONFIGURABILE CON PORTE A BATTENTE, PORTE SCORREVOLI E TAPPARELLE

CARATTERISTICHE TECNICHE

COLORI

ARMADIO

10 colori per la parte metallica

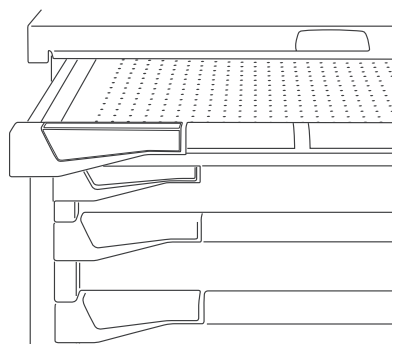

8 colori per gli accessori di plastica

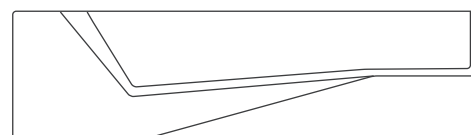

MANIGLIA FRONTALE

CODICI

CODIFICA ARMADIO MASTER

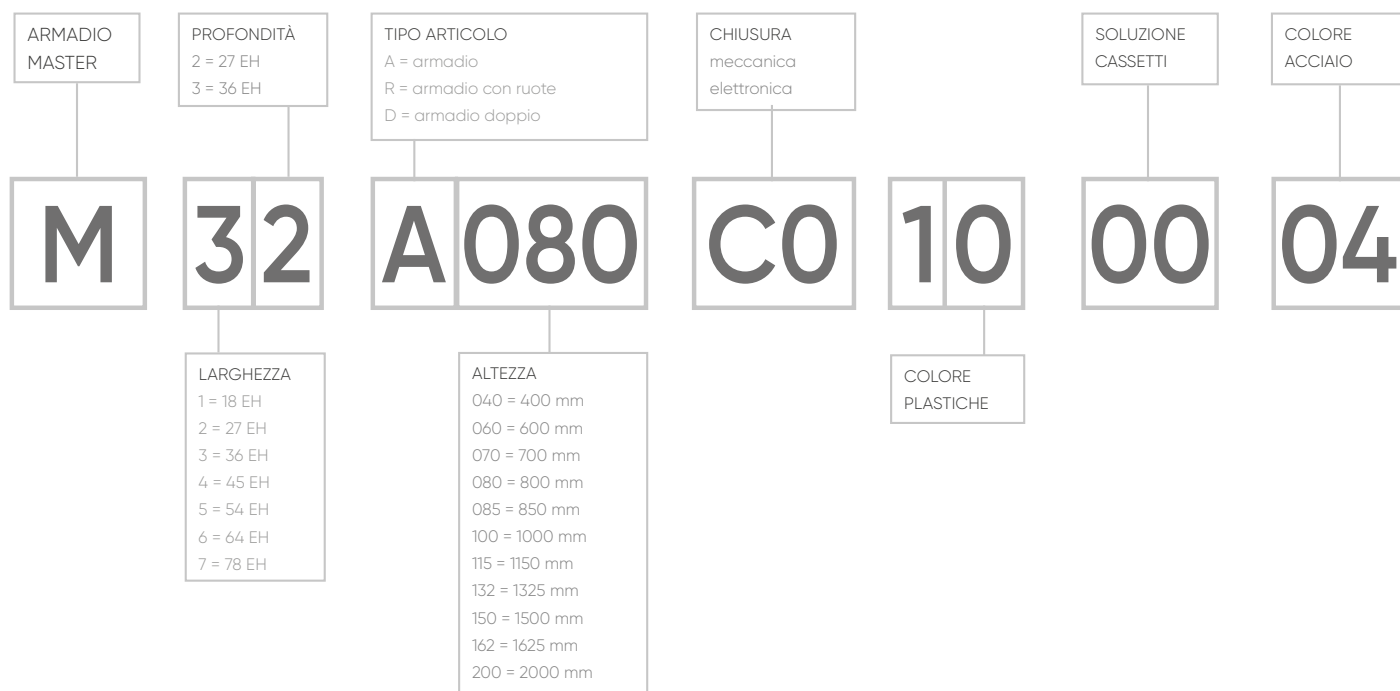

ASTA VERTEBRATA

È IL CUORE E IL CERVELLO DEL SISTEMA

L'asta è in profilato d'alluminio e rimane sempre fissa, senza ruotare. Il movimento di chiusura è ottenuto da tasselli che si spostano verticalmente sfruttando una delle forze elementari della fisica: la gravità. Più il movimento è semplice, più la durata del componente è garantita.

L'asta è forata a passo 25 mm e consente l'applicazione di più teste di chiusura. Questo permette di dividere l'accesso ai cassette in più gruppi. La divisione dei gruppi è configurabile in altezza.

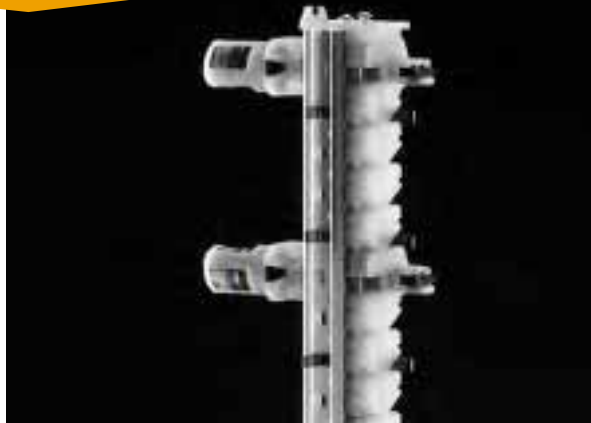

BREVETTATO

SISTEMA MECCANICO CHIUSURA CON CILINDRO

Sistema di trasmissione dal cilindro della serratura alla testa dell'asta vertebra a filo di acciaio con guaina elastica e movimento lineare.

La serratura a cilindro è suddivisa in 23 diverse serie: ogni serie ha una numerazione delle chiavi compresa tra 1 e 160, per un totale di 3.680 diverse combinazioni.

PUSH TO OPEN- APERTURA SINGOLA DEI CASSETTI

Rispetto ai comuni sistemi che prevedono l'aggiunta di ulteriori componenti sul frontale, l'apertura singola dei cassette è integrata nel cilindro. Per aprirli, basta ruotare la chiave e premere il cilindro della serratura. Meno componenti servono per un meccanismo, meno possibilità di rottura ci sono.



BREVETTATO

✓ syCONTROL

Gestione meccanica o elettronica della serratura ad elevata sicurezza.

SOFTWARE PER IL CONTROLLO DEGLI EVENTI

Software di reporting gratuito e scaricabile da:
www.sylogik.com/sycontrol.

Visualizzazione degli ultimi 1000 eventi con data, ora, user e tipo di evento.
Per avere sempre sotto controllo ogni apertura, ogni accesso.

SISTEMA ELETTRONICO

La serratura a codice numerico comanda l'apertura e la chiusura dell'asta vertebra e della porta. Gestisce fino a 10 utenti con codice numerico da 3 a 8 cifre. Il download storico degli eventi è possibile tramite cavo collegando il tastierino al pc. Disponibili su richiesta fino a 10 telecomandi.



LIBERTÀ CONFIGURABILE

ESTRAZIONE FLESSIBILE

Nuova guida ad estrazione flessibile con regolazione meccanica del fermo posteriore del cassetto/piano estraibile, in 3 diverse posizioni. Permette di ottenere 3 portate differenti: 50, 75, 100 kg.

✓ syFLEX

Sistema di apertura brevettato che permette di configurare l'estrazione e la portata direttamente dall'utilizzatore.

BREVETTATO

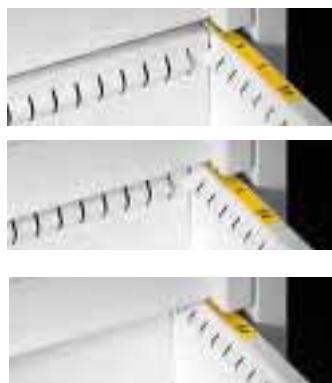

92%	100
96%	75
100%	50

ESTRAZIONE TELESCOPICA

Nuova guida ad estrazione telescopica (estraiibilità 100%) che garantisce una portata di 200 kg nelle 10 dimensioni disponibili dell'armadio Master.



I cassetti/piani estraibili della serie Master possono montare indipendentemente sia le guide ad estrazione flessibile che telescopica.

WEB TO PRINT

SYLOGIK
smart solutions

Il frontale del cassetto diventa una vera interfaccia visiva.

- Personalizzabile con elementi estetici e decorativi
- Input utente: etichette per la descrizione e catalogazione del contenuto
- Output utente: possibilità di inserire messaggi visivi o descrittivi sulla maniglia

✓ syFRONT

Servizio Web to Print gratuito per la personalizzazione delle etichette da applicare nella maniglia del cassetto.

www.sylogik.com/syfront



SOFTWARE DI STAMPA ETICHETTE

Personalizza A & B
FREE SOFTWARE

Utilizza il modello A & B

- online e gratuito
- gestisce immagini, testi, 8 tipi di codice a barre
- collegabile a tabelle di calcolo (Excel) per stampare etichette seriali o progressive

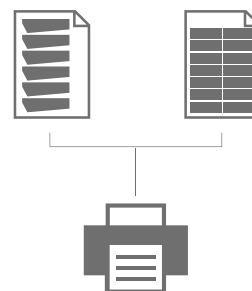

IL PRIMO ARMADIO AL MONDO CON CUSCINETTO FRONTALE

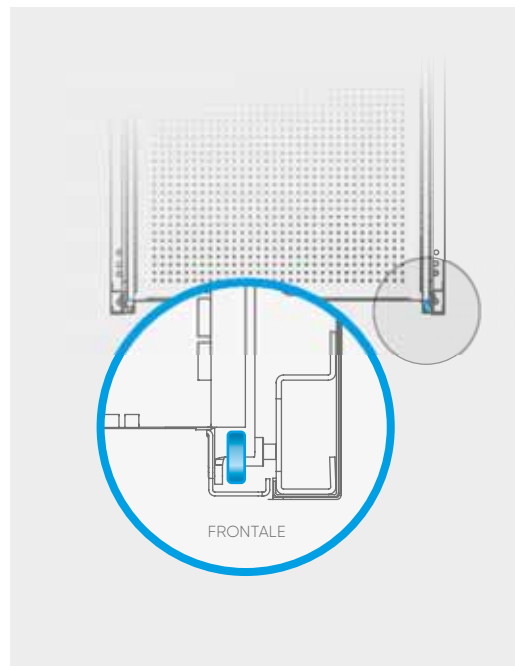
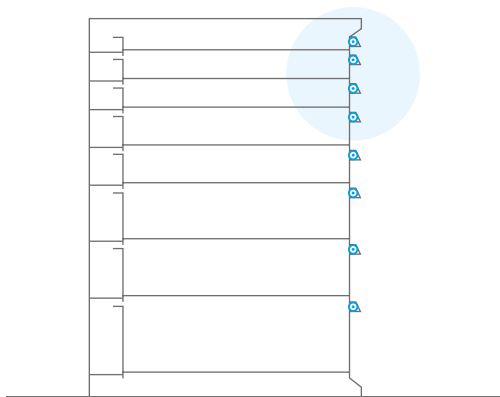

PIÙ UN MECCANISMO È SEMPLICE
PIÙ È EFFICACE

La guida semplice è stata allungata quanto l'armadio. Il cuscinetto anteriore è stato spostato oltre il frontale del cassetto. Risultato: netto miglioramento della percentuale di estrazione e dell'utilizzo del volume del cassetto. Il cono d'ombra è nullo nei cassetti più alti anche se questi sono regolati con portata 100 kg.

BREVETTATO

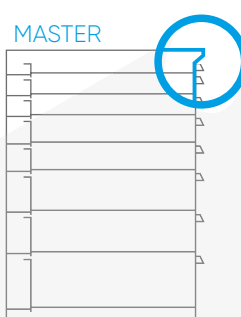
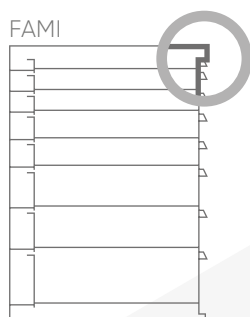
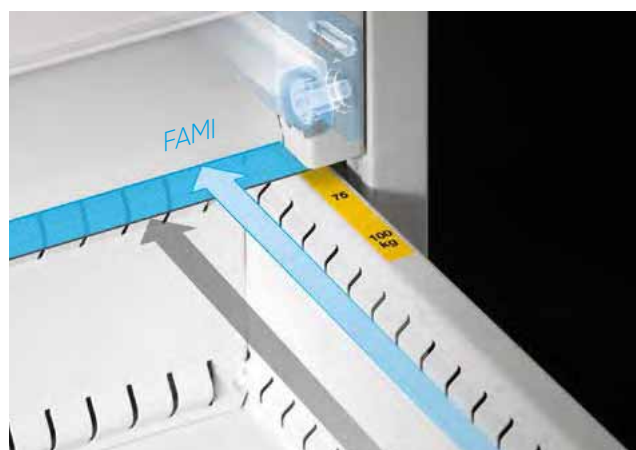

+ 30% rispetto al classico armadio Fami



MAGGIORE CONO VISIVO





PORTA SCORREVOLE



TAPPARELLA

**PORTA
BATTENTE**



SERRATURE

CHIUSURA CON CILINDRO

La chiusura a cilindro comanda l'apertura e la chiusura dell'asta vertebrata e della porta. È suddivisa in 23 diverse serie: ogni serie ha una numerazione delle chiavi compresa tra 1 e 160, per un totale di 3.680 diverse combinazioni.

PER ARMADI SENZA RUOTE

Chiusura a cilindro per l'apertura e la chiusura dei cassetti e della porta tramite la rotazione della chiave.

	C0	C1	C2
	il numero di serie della serratura sarà casuale tra 1 e 23	il numero di serie della serratura sarà indicato dal cliente tra 1 e 23	il numero di serie della serratura sarà indicato dal cliente tra 1 e 23
	tutte le chiavi avranno numerazione DIVERSA	tutte le chiavi avranno numerazione DIVERSA	tutte le chiavi avranno numerazione UGUALE

PER ARMADI CON RUOTE - Push To Open

Chiusura a cilindro per l'apertura e la chiusura dei cassetti tramite la rotazione della chiave. Nella fase di sblocco sarà necessario tenere premuto il cilindro per aprire il cassetto, evitandone l'apertura accidentale quando gli armadi sono in movimento.

	S0	S1	S2
	il numero di serie della serratura sarà casuale tra 1 e 23	il numero di serie della serratura sarà indicato dal cliente tra 1 e 23	il numero di serie della serratura sarà indicato dal cliente tra 1 e 23
	tutte le chiavi avranno numerazione DIVERSA	tutte le chiavi avranno numerazione DIVERSA	tutte le chiavi avranno numerazione UGUALE

CHIAVE PASSEPARTOUT ART. M 00 PF.. 0000 00 00



CHIUSURA A CILINDRO PER CORPO ARMADIO



Il passepartout apre tutte le serrature della stessa serie tra 1 e 23

CHIUSURA A CILINDRO PER PORTE A BATTENTE E SCORREVOLI

Il passepartout apre tutte le serrature della stessa serie tra 1 e 23

TUTTE LE CHIUSURE A CILINDRO SONO FORNITE DI SERIE CON 2 CHIAVI





CHIUSURA CON CODICE NUMERICO

La chiusura a codice numerico comanda l'apertura e la chiusura dell'asta vertebrata e della porta. Gestisce fino a 10 utenti con codice numerico da 3 a 8 cifre e ulteriori 10 utenti con telecomando. Il download storico degli eventi è possibile tramite cavo collegando il tastierino al pc. Disponibili su richiesta fino a 10 telecomandi.

PER ARMADI SENZA RUOTE

Chiusura con codice numerico per l'apertura e la chiusura dei cassetti e della porta.



E2	T2	P5
apertura/chiusura ASTA gestione fino a 10 utenti codice numerico da 3 a 8 cifre download storico degli eventi	apertura/chiusura ASTA + PORTA gestione fino a 10 utenti codice numerico da 3 a 8 cifre download storico degli eventi	apertura/chiusura PORTA gestione fino a 10 utenti codice numerico da 3 a 8 cifre download storico degli eventi
alimentazione a batteria	alimentazione a batteria	alimentazione a batteria

PER ARMADI CON RUOTE - Push To Open

Chiusura con codice numerico per l'apertura e la chiusura dei cassetti e della porta. Nella fase di sblocco sarà necessario premere un tasto dedicato sul tastierino, garantendo la sicurezza degli armadi in movimento.



P2	A1	P5
apertura/chiusura ASTA gestione fino a 10 utenti codice numerico da 3 a 8 cifre download storico degli eventi	apertura/chiusura ASTA + PORTA gestione fino a 10 utenti codice numerico da 3 a 8 cifre download storico degli eventi	apertura/chiusura PORTA gestione fino a 10 utenti codice numerico da 3 a 8 cifre download storico degli eventi
alimentazione a batteria	alimentazione a batteria	alimentazione a batteria

TELECOMANDO PER CHIUSURA CON CODICE NUMERICO



ART. M 00 VRC0 00 00 00 00
Modulo ricevitore con telecomando

ART. M 00 VRC0 00 00 01 00
Telecomando aggiuntivo



PER L'USO DEL TELECOMANDO È NECESSARIO ABBINARE ALLA CHIUSURA CON CODICE NUMERICO IL MODULO RICEVITORE



SU RICHIESTA È POSSIBILE AVERE LA SERRATURA ALIMENTATA DA RETE ELETTRICA



GOMMA STANDARD

RUOTA FISSA IN GOMMA STANDARD

ART.	Ø mm	portata kg	C mm	
C RG BAC11 100	100	75	128	
C RG BAC12 125	125	100	155	



RUOTA FISSA IN GOMMA STANDARD

ART.	Ø mm	portata kg	C mm	
C RG BAC13 150	150	115	180	
C RG BAC15 200	200	205	240	



RUOTA GIREVOLE CON FRENO IN GOMMA STANDARD

ART.	Ø mm	portata kg	C mm	
C RG DAC11 100	100	75	128	
C RG DAC12 125	125	100	155	



RUOTA GIREVOLE CON FRENO IN GOMMA STANDARD

ART.	Ø mm	portata kg	C mm	
C RG DAC13 150	150	115	180	
C RG DAC15 200	200	205	240	



NYLON

RUOTA FISSA IN NYLON

ART.	Ø mm	portata kg	C mm	
C RN BAD10 100	100	125	128	
C RN BAD11 125	125	180	155	



RUOTA FISSA IN NYLON

ART.	Ø mm	portata kg	C mm	
C RN BADO4 160	160	300	200	



RUOTA GIREVOLE CON FRENO IN NYLON

ART.	Ø mm	portata kg	C mm	
C RN DAD10 100	100	125	128	
C RN DAD11 125	125	180	155	



RUOTA GIREVOLE CON FRENO IN NYLON

ART.	Ø mm	portata kg	C mm	
C RN DAD04 160	160	300	200	



GOMMA ANTITRACCIA SINTETICA

RUOTA FISSA IN GOMMA ANTITRACCIA SINTETICA

ART.	Ø mm	portata kg	C mm
C RG BPH22 125	125	100	155



RUOTA FISSA IN GOMMA ANTITRACCIA SINTETICA

ART.	Ø mm	portata kg	C mm
C RG BPH25 160	160	200	200



RUOTA GIREVOLE CON FRENO IN GOMMA ANTITRACCIA SINTETICA

ART.	Ø mm	portata kg	C mm
C RG DPH22 125	125	100	155



RUOTA GIREVOLE CON FRENO IN GOMMA ANTITRACCIA SINTETICA

ART.	Ø mm	portata kg	C mm
C RG DPH25 160	160	200	200



GOMMA ELASTICA

RUOTA FISSA IN GOMMA ELASTICA

ART.	Ø mm	portata kg	C mm
C RG BCE15 125	125	180	155



RUOTA FISSA IN GOMMA ELASTICA

ART.	Ø mm	portata kg	C mm
C RG BCE15 160	160	300	200



RUOTA GIREVOLE CON FRENO IN GOMMA ELASTICA

ART.	Ø mm	portata kg	C mm
C RG DCE15 125	125	180	155



RUOTA GIREVOLE CON FRENO IN GOMMA ELASTICA

ART.	Ø mm	portata kg	C mm
C RG DCE15 160	160	300	200



POLIURETANO

RUOTA FISSA IN POLIURETANO

ART.	Ø mm	portata kg	C mm
C RN BDD31 125	125	180	155



RUOTA FISSA IN POLIURETANO

ART.	Ø mm	portata kg	C mm
C RN BDD44 160	160	300	200



RUOTA GIREVOLE CON FRENO IN POLIURETANO

ART.	Ø mm	portata kg	C mm
C RN DDD31 125	125	180	155



RUOTA GIREVOLE CON FRENO IN POLIURETANO

ART.	Ø mm	portata kg	C mm
C RN DDD44 160	160	300	200



A = PORTATA DELLE RUOTE

Per calcolare la portata dell'armadio con ruote in gomma standard, gomma antitraccia e nylon Ø 100 mm seguire la formula: $(A \times 3) - 55$ kg
La portata dell'armadio con ruote in gomma elastica, poliuretano e nylon Ø 125 mm è di 400 kg

18x27 EH

Per calcolare la portata dell'armadio con ruote in gomma standard, gomma antitraccia e nylon Ø 100 mm seguire la formula: $(A \times 3) - 65$ kg
La portata dell'armadio con ruote in gomma elastica, poliuretano e nylon Ø 125 mm è di 400 kg

27x27 EH

Per calcolare la portata dell'armadio seguire la formula: $(A \times 3) - 120$ kg
ATTENZIONE: per motivi di sicurezza la portata dell'armadio con ruote non può superare i 600 kg

36x27 EH

Per calcolare la portata dell'armadio seguire la formula: $(A \times 3) - 170$ kg
ATTENZIONE: per motivi di sicurezza la portata dell'armadio con ruote non può superare i 600 kg

54x27 EH

Per calcolare la portata dell'armadio seguire la formula: $(A \times 3) - 65$ kg
ATTENZIONE: per motivi di sicurezza la portata dell'armadio con ruote non può superare i 600 kg

27x36 EH



A = PORTATA DELLE RUOTE

36x36 EH

Per calcolare la portata dell'armadio seguire la formula: $(A \times 3) - 140$ kg
ATTENZIONE: per motivi di sicurezza la portata dell'armadio con ruote non può superare i 600 kg

45x36 EH

Per calcolare la portata dell'armadio seguire la formula: $(A \times 3) - 160$ kg
ATTENZIONE: per motivi di sicurezza la portata dell'armadio con ruote non può superare i 600 kg

54x36 EH

Per calcolare la portata dell'armadio seguire la formula: $(A \times 3) - 180$ kg
ATTENZIONE: per motivi di sicurezza la portata dell'armadio con ruote non può superare i 600 kg.

64x36 EH





Per calcolare la portata dell'armadio seguire la formula: $(A \times 3) - 200$ kg
ATTENZIONE: per motivi di sicurezza la portata dell'armadio con ruote non può superare i 600 kg.

78x36 EH

Per calcolare la portata dell'armadio seguire la formula: $(A \times 3) - 220$ kg
ATTENZIONE: per motivi di sicurezza la portata dell'armadio con ruote non può superare i 600 kg.









Gamma colori ACCIAIO

 GRIGIO RAL 7000 .01	 VERDE RAL 6011 .02
 BLU RAL 5012 .04	 GRIGIO RAL 7035 .08
 BIANCO GRIGIASTRO RAL 9002 .1F	 ROSSO RUBINO RAL 3003 .1G
 BLU GENZIANA RAL 5010 .34	 BIANCO PURO RAL 9010 .35
 GRIGIO ANTRACITE RAL 7016 .39	 BLU CAPRI RAL 5019 .48



● ART. M 12 A100 CO 10 AW 04
H = 1000 mm - 7 cassetti

Gamma colori PLASTICHE

 DARK GREY .M0	 MEDITERRANEAN BLUE .M1	 SKY BLUE .M2	 GLAMOUR RED .M3
 RED CARPET .M4	 JUICE ORANGE .M5	 SUNNY YELLOW .M6	 FOREST GREEN .M7

LEGENDA



PORTATA
CASSETTO/
PIANO



ESTRAZIONE
CASSETTO/
PIANO



CHIUSURA
ARMADIO



LE PORTATE SONO NETTE E SI RIFERISCONO A PESI UNIFORMEMENTE DISTRIBUITI

H 400 mm



ART.		kg			
M 12 A040 C0 10 02 04		50-75-100	100-96-92%	key	
M 12 A040 E2 10 02 04		50-75-100	100-96-92%	code	

H 400 mm



ART.		kg			
M 12 A040 C0 10 03 04		50-75-100	100-96-92%	key	
M 12 A040 E2 10 03 04		50-75-100	100-96-92%	code	

H 600 mm



ART.		kg			
M 12 A060 C0 10 20 04		50-75-100	100-96-92%	key	
M 12 A060 E2 10 20 04		50-75-100	100-96-92%	code	

H 600 mm



ART.		kg			
M 12 A060 C0 10 21 04		50-75-100	100-96-92%	key	
M 12 A060 E2 10 21 04		50-75-100	100-96-92%	code	

H 600 mm



ART.		kg			
M 12 A060 C0 10 22 04		50-75-100	100-96-92%	key	
M 12 A060 E2 10 22 04		50-75-100	100-96-92%	code	

H 600 mm



ART.		kg			
M 12 A060 C0 10 17 04		50-75-100	100-96-92%	key	porta 425 mm profondità 598 mm
M 12 A060 T2 10 17 04		50-75-100	100-96-92%	code	

H 700 mm



ART.				
M 12 A070 C0 10 34 04		50-75-100	100-96-92%	key
M 12 A070 E2 10 34 04		50-75-100	100-96-92%	code

H 700 mm



ART.				
M 12 A070 C0 10 31 04		50-75-100	100-96-92%	key
M 12 A070 E2 10 31 04		50-75-100	100-96-92%	code

H 700 mm



porta 425 mm profondità 598 mm

ART.				
M 12 A070 C0 10 30 04		50-75-100	100-96-92%	key
M 12 A070 T2 10 30 04		50-75-100	100-96-92%	code

H 700 mm



porta 600 mm profondità 598 mm

ART.				
M 12 A070 C0 10 36 04		50-75-100	100-96-92%	key
M 12 A070 P5 10 36 04		50-75-100	100-96-92%	code

H 800 mm



ART.				
M 12 A080 C0 10 56 04		50-75-100	100-96-92%	key
M 12 A080 E2 10 56 04		50-75-100	100-96-92%	code

H 800 mm



porta 425 mm profondità 598 mm

ART.				
M 12 A080 C0 10 57 04		50-75-100	100-96-92%	key
M 12 A080 T2 10 57 04		50-75-100	100-96-92%	code

H 1000 mm

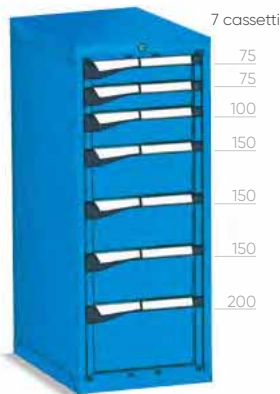

H 1000 mm



porta 625 mm

profondità 598 mm

ART.				
● M12A100C010AW04	50-75-100	100-96-92%		key
M12A100E210AW04	50-75-100	100-96-92%		code

ART.				
M12A100C010BD04	50-75-100	100-96-92%		key
M12A100T210BD04	50-75-100	100-96-92%		code



ART. M 12 A080 E2 14 NB 01

H 818 mm



ART.				
M 12 R060 S0 10 20 04		50-75-100	100-96-92%	key
M 12 R060 P2 10 20 04		50-75-100	100-96-92%	code

Portata armadio 245 kg - Altezza armadio senza ruote mm 663

H 818 mm



ART.				
M 12 R060 S0 10 21 04		50-75-100	100-96-92%	key
M 12 R060 P2 10 21 04		50-75-100	100-96-92%	code

Portata armadio 245 kg - Altezza armadio senza ruote mm 663

H 918 mm



ART.				
M 12 R070 S0 10 35 04		50-75-100	100-96-92%	key
M 12 R070 P2 10 35 04		50-75-100	100-96-92%	code

Portata armadio 245 kg - Altezza armadio senza ruote mm 763

H 918 mm



porta 425 mm

ART.				
M 12 R070 S0 10 30 04		50-75-100	100-96-92%	key
M 12 R070 A1 10 30 04		50-75-100	100-96-92%	code

Portata armadio 245 kg - Altezza armadio senza ruote mm 763



2 ruote girevoli con freno in gomma standard Ø 125 mm
2 ruote fisse in gomma standard Ø 125 mm

ART. M 12 A100 T2 16 NC 35



ART. M 12 R070 SO 11 35 35



CONFIGURA IL TUO ARMADIO

SCEGLI
l'altezza

SCEGLI
la chiusura

SCEGLI
il colore

M12	A040	C5	10 00	01
-----	------	----	-------	----

ARMADIO VUOTO



Portata corpo
armadio 3100 kg

M12	ALTEZZA		CHIUSURA		10 00	COLORE	
	Model	Height (mm) / Useful (mm)	Key/Code	Description		Code	Color Name
	A040	400 mm (utile 300 mm)	X0	senza asta e senza serratura		01	RAL 7000
	A060	600 mm (utile 500 mm)	C5*	senza serratura		02	RAL 6011
	A070	700 mm (utile 600 mm)	C0*	KEY chiusura a cilindro		1G	RAL 3003
	A080	800 mm (utile 700 mm)	C1*	KEY chiusura a cilindro		1F	RAL 9002
	A100	1000 mm (utile 900 mm)	C2*	KEY chiusura a cilindro		48	RAL 5019
			E2*	CODE codice numerico		39	RAL 7016
			T2*	CODE codice numerico		04	RAL 5012
						08	RAL 7035
						35	RAL 9010
						34	RAL 5010

*COMPLETA DI ASTA VERTEBRATA

ARMADIO VUOTO predisposto per ruote



M12	ALTEZZA		CHIUSURA		10 00	COLORE	
	Model	Height (mm) / Useful (mm)	Key/Code	Description		Code	Color Name
	R060	663 mm (utile 500 mm)	S0	KEY chiusura a cilindro		01	RAL 7000
	R070	763 mm (utile 600 mm)	S1	KEY chiusura a cilindro		02	RAL 6011
			S2	KEY chiusura a cilindro		1G	RAL 3003
			P2	CODE codice numerico		1F	RAL 9002
			A1	CODE codice numerico		48	RAL 5019
						39	RAL 7016
						04	RAL 5012
						08	RAL 7035
						35	RAL 9010
						34	RAL 5010

COMPLETO DI ASTA VERTEBRATA, PIANO A 4 BORDI CON COPERTURA IN PVC, COPPIA MANIGLIE, COPPIA PIASTRE
Dim. ingombro mm 434x647



CASSETTI AD ESTRAZIONE FLESSIBILE

ART. CON kit plastiche Dark Grey	ART. SENZA kit plastiche*	Dim. utili mm	H frontale mm	kg	
M 12 C050 01 10 OF __	M 12 C050 01 00 OF __	294x447x31 H	50	50 - 75 - 100	100% - 96% - 92%
M 12 C075 01 10 OF __	M 12 C075 01 00 OF __	294x447x56 H	75	50 - 75 - 100	100% - 96% - 92%
M 12 C100 01 10 OF __	M 12 C100 01 00 OF __	294x447x81 H	100	50 - 75 - 100	100% - 96% - 92%
M 12 C125 01 10 OF __	M 12 C125 01 00 OF __	294x447x106 H	125	50 - 75 - 100	100% - 96% - 92%
M 12 C150 01 10 OF __	M 12 C150 01 00 OF __	294x447x131 H	150	50 - 75 - 100	100% - 96% - 92%
M 12 C200 01 10 OF __	M 12 C200 01 00 OF __	294x447x181 H	200	50 - 75 - 100	100% - 96% - 92%
M 12 C250 01 10 OF __	M 12 C250 01 00 OF __	294x447x231 H	250	50 - 75 - 100	100% - 96% - 92%
M 12 C300 01 10 OF __	M 12 C300 01 00 OF __	294x447x281 H	300	50 - 75 - 100	100% - 96% - 92%

* ABBINARE AL CODICE ARTICOLO UNO DEI KIT PLASTICHE DISPONIBILI NELLA TABELLA SOTTOSTANTE



CASSETTI AD ESTRAZIONE TELESCOPICA

ART. CON kit plastiche Dark Grey	ART. SENZA kit plastiche*	Dim. utili mm	H frontale mm	kg	
M 12 C075 01 10 OT __	M 12 C075 01 00 OT __	294x447x56 H	75	200	100%
M 12 C100 01 10 OT __	M 12 C100 01 00 OT __	294x447x81 H	100	200	100%
M 12 C125 01 10 OT __	M 12 C125 01 00 OT __	294x447x106 H	125	200	100%
M 12 C150 01 10 OT __	M 12 C150 01 00 OT __	294x447x131 H	150	200	100%
M 12 C200 01 10 OT __	M 12 C200 01 00 OT __	294x447x181 H	200	200	100%
M 12 C250 01 10 OT __	M 12 C250 01 00 OT __	294x447x231 H	250	200	100%
M 12 C300 01 10 OT __	M 12 C300 01 00 OT __	294x447x281 H	300	200	100%

* ABBINARE AL CODICE ARTICOLO UNO DEI KIT PLASTICHE DISPONIBILI NELLA TABELLA SOTTOSTANTE

KIT PLASTICHE PER CASSETTI E PIANI ESTRAIBILI



GAMMA COLORI PLASTICHE	ART.
MEDITERRANEAN BLUE	M 10 PLS1 00 00 00 M1
SKY BLUE	M 10 PLS1 00 00 00 M2
GLAMOUR RED	M 10 PLS1 00 00 00 M3
RED CARPET	M 10 PLS1 00 00 00 M4
JUICY ORANGE	M 10 PLS1 00 00 00 M5
SUNNY YELLOW	M 10 PLS1 00 00 00 M6
FOREST GREEN	M 10 PLS1 00 00 00 M7



PIANI ESTRAIBILI AD ESTRAZIONE FLESSIBILE

ART. CON kit plastiche Dark Grey	ART. SENZA kit plastiche*	Dim. utili mm	H frontale mm	kg	
M 12 C057 01 10 OF _ _	M 12 C057 01 00 OF _ _	294x447	70	50 - 75 - 100	100% - 96% - 92%

* ABBINARE AL CODICE ARTICOLO UNO DEI KIT PLASTICHE DISPONIBILI NELLA TABELLA SOTTOSTANTE



PIANI ESTRAIBILI AD ESTRAZIONE TELESCOPICA

ART. CON kit plastiche Dark Grey	ART. SENZA kit plastiche*	Dim. utili mm	H frontale mm	kg	
M 12 C057 01 10 OT _ _	M 12 C057 01 00 OT _ _	294x447	70	200	100%

* ABBINARE AL CODICE ARTICOLO UNO DEI KIT PLASTICHE DISPONIBILI NELLA TABELLA SOTTOSTANTE



PIANO REGOLABILE

ART.	Dim. utili mm	H totale mm	kg
M 12 PR25 00 00 01 _ _	351x478	60	70

INSERIBILE DAVANTI ALL'ASTA VERTEBRATA

KIT PLASTICHE PER CASSETTI E PIANI ESTRAIBILI



GAMMA COLORI PLASTICHE	ART.
MEDITERRANEAN BLUE	M 10 PLS1 00 00 00 M1
SKY BLUE	M 10 PLS1 00 00 00 M2
GLAMOUR RED	M 10 PLS1 00 00 00 M3
RED CARPET	M 10 PLS1 00 00 00 M4
JUICY ORANGE	M 10 PLS1 00 00 00 M5
SUNNY YELLOW	M 10 PLS1 00 00 00 M6
FOREST GREEN	M 10 PLS1 00 00 00 M7



ART. M 12 R070 SO 11 35 35

🔑 PORTE A BATTENTE CON CILINDRO

PORTE A BATTENTE ALTEZZA TOTALE - REVERSIBILE



H ARMADIO mm	TIPO DI CHIUSURA	ART. CON kit plastiche Dark Grey 	ART. SENZA kit plastiche* 
600	 C0 KEY chiusura a cilindro	M 10 P050 C0 10 00 __	M 10 P050 C0 00 00 __
	 C1 KEY chiusura a cilindro	M 10 P050 C1 10 00 __	M 10 P050 C1 00 00 __
	 C2 KEY chiusura a cilindro	M 10 P050 C2 10 00 __	M 10 P050 C2 00 00 __
700	 C0 KEY chiusura a cilindro	M 10 P060 C0 10 00 __	M 10 P060 C0 00 00 __
	 C1 KEY chiusura a cilindro	M 10 P060 C1 10 00 __	M 10 P060 C1 00 00 __
	 C2 KEY chiusura a cilindro	M 10 P060 C2 10 00 __	M 10 P060 C2 00 00 __











* ABBINARE AL CODICE ARTICOLO UNO DEI KIT PLASTICHE DISPONIBILI NELLA TABELLA A DESTRA



LA PORTA DEVE ESSERE ASSOCIATA OBBLIGATORIAMENTE AGLI ARMADI CON LA CHIUSURA:
C5 (SENZA SERRATURA) OPPURE **X0** (SENZA ASTA VERTEBRATA E SENZA SERRATURA)

PORTE A BATTENTE ALTEZZA PARZIALE - REVERSIBILE



H INGOMBRO PORTA mm	TIPO DI CHIUSURA	ART. CON kit plastiche Dark Grey 	ART. SENZA kit plastiche* 
425	 C0 KEY chiusura a cilindro	M 10 P042 C0 10 01 __	M 10 P042 C0 00 01 __
	 C1 KEY chiusura a cilindro	M 10 P042 C1 10 01 __	M 10 P042 C1 00 01 __
	 C2 KEY chiusura a cilindro	M 10 P042 C2 10 01 __	M 10 P042 C2 00 01 __
525	 C0 KEY chiusura a cilindro	M 10 P052 C0 10 01 __	M 10 P052 C0 00 01 __
	 C1 KEY chiusura a cilindro	M 10 P052 C1 10 01 __	M 10 P052 C1 00 01 __
	 C2 KEY chiusura a cilindro	M 10 P052 C2 10 01 __	M 10 P052 C2 00 01 __
625	 C0 KEY chiusura a cilindro	M 10 P062 C0 10 01 __	M 10 P062 C0 00 01 __
	 C1 KEY chiusura a cilindro	M 10 P062 C1 10 01 __	M 10 P062 C1 00 01 __
	 C2 KEY chiusura a cilindro	M 10 P062 C2 10 01 __	M 10 P062 C2 00 01 __

* ABBINARE AL CODICE ARTICOLO UNO DEI KIT PLASTICHE DISPONIBILI NELLA TABELLA A DESTRA



PORTE A BATTENTE CON CODICE NUMERICO

PORTE A BATTENTE ALTEZZA TOTALE - APERTURA SOLO A DESTRA



H ARMADIO mm	TIPO DI CHIUSURA	ART. CON kit plastiche Dark Grey	ART. SENZA kit plastiche*
600	P5 CODE codice numerico	M 10 P050 P5 10 00 _ _	M 10 P050 P5 00 00 _ _
700	P5 CODE codice numerico	M 10 P060 P5 10 00 _ _	M 10 P060 P5 00 00 _ _

* ABBINARE AL CODICE ARTICOLO UNO DEI KIT PLASTICHE DISPONIBILI NELLA TABELLA SOTTOSTANTE



LA PORTA DEVE ESSERE ASSOCIATA OBBLIGATORIAMENTE AGLI ARMADI CON LA CHIUSURA:

C5 (SENZA SERRATURA) OPPURE **X0** (SENZA ASTA VERTEBRATA E SENZA SERRATURA)

PORTE A BATTENTE ALTEZZA PARZIALE - REVERSIBILE



H INGOMBRO PORTA mm	TIPO DI CHIUSURA	ART. CON kit plastiche Dark Grey	ART. SENZA kit plastiche*
425	A4 maniglia senza tastierino	M 10 P042 A4 10 01 _ _	M 10 P042 A4 00 01 _ _
525	A4 maniglia senza tastierino	M 10 P052 A4 10 01 _ _	M 10 P052 A4 00 01 _ _
625	A4 maniglia senza tastierino	M 10 P062 A4 10 01 _ _	M 10 P062 A4 00 01 _ _

* ABBINARE AL CODICE ARTICOLO UNO DEI KIT PLASTICHE DISPONIBILI NELLA TABELLA SOTTOSTANTE



LA PORTA DEVE ESSERE ASSOCIATA OBBLIGATORIAMENTE AGLI ARMADI CON LE CHIUSURE:

UTILIZZARE LA SERRATURA **T2** PER L'ARMADIO SENZA RUOTE

UTILIZZARE LA SERRATURA **A1** PER L'ARMADIO CON RUOTE

TELECOMANDO



ART.	
M 00 VRC0 00 00 00 00	Modulo ricevitore con telecomando
M 00 VRC0 00 00 01 00	Telecomando aggiuntivo

KIT PLASTICHE PER PORTE A BATTENTE



GAMMA COLORI PLASTICHE	ART. KEY	ART. CODE
MEDITERRANEAN BLUE	M 00 PLS0 00 00 20 M1	M 00 PLS0 00 00 21 M1
SKY BLUE	M 00 PLS0 00 00 20 M2	M 00 PLS0 00 00 21 M2
GLAMOUR RED	M 00 PLS0 00 00 20 M3	M 00 PLS0 00 00 21 M3
RED CARPET	M 00 PLS0 00 00 20 M4	M 00 PLS0 00 00 21 M4
JUICY ORANGE	M 00 PLS0 00 00 20 M5	M 00 PLS0 00 00 21 M5
SUNNY YELLOW	M 00 PLS0 00 00 20 M6	M 00 PLS0 00 00 21 M6
FOREST GREEN	M 00 PLS0 00 00 20 M7	M 00 PLS0 00 00 21 M7



PIANO SUPERIORE A 3 BORDI

ART.	dim. mm	
M 12 T023 AG 00 31 07	408x573x23 H	

Piano rivestito in pvc per ARMADIO SINGOLO. Colore nero



PIANO SUPERIORE A 4 BORDI

ART.	dim. mm	
M 12 T023 AG 00 41 07	408x573x23 H	

Piano rivestito in pvc per ARMADIO SINGOLO. Colore nero



ART. M 00 T023 AG 00 FO 00
FORATURA PIANO SUPERIORE DELL'ARMADIO
PER IL FISSAGGIO DEL PIANO A 4 BORDI



PIANO SUPERIORE IN MULTIPLEX

ART.	dim. mm	
M 12 T040 MU 00 01 00	408x573x40 H	

Per ARMADIO SINGOLO



PIANO SUPERIORE IN MDF DIM. 408x573x32 mm H

ART.	rifiniture	per armadio	
M 12 T030 MD GM 21 07	1 profilo laterale	finale dx o sx	

Piano in MDF con copertura in gomma antiolio. Colore nero



PIANO SUPERIORE IN MDF DIM. 408x573x32 mm H

ART.	rifiniture	per armadio	
M 12 T030 MD GM 11 07	-	centrale	

Piano in MDF con copertura in gomma antiolio. Colore nero



PIANO SUPERIORE IN MDF DIM. 408x573x32 mm H

ART.	rifiniture	per armadio	
M 12 T030 MD GM 01 07	2 profili laterali	singolo	

Piano in MDF con copertura in gomma antiolio. Colore nero



ART. M 00 T030 MD 00 FO 00
FORATURA PIANO SUPERIORE DELL'ARMADIO PER IL FISSAGGIO DEL
PIANO IN MDF E DEL PIANO IN MULTIPLEX
COMPRESIVO DI VITI PER IL FISSAGGIO



RIFINITURA
GOMMA
ANTIOLIO



APPLICAZIONE
PIANO IN MDF

ZOCCOLO DI RIALZO ALTEZZA 50 mm



ART.		dim. mm	
M 12 Z050 00 00 00 _ _		406x572x50 H	

ZOCCOLO DI RIALZO ALTEZZA 100 mm



ART.		dim. mm	
M 12 Z100 00 00 00 _ _		406x572x100 H	



RUOTA FISSA IN GOMMA STANDARD

ART.	Ø mm	portata armadio kg	C mm
C RG BAC11 100	100	170	128
C RG BAC12 125	125	245	155



RUOTA GIREVOLE CON FRENO IN GOMMA STANDARD

ART.	Ø mm	portata armadio kg	C mm
C RG DAC11 100	100	170	128
C RG DAC12 125	125	245	155



RUOTA FISSA IN NYLON

ART.	Ø mm	portata armadio kg	C mm
C RN BAD10 100	100	320	128
C RN BAD11 125	125	400	155



RUOTA GIREVOLE CON FRENO IN NYLON

ART.	Ø mm	portata armadio kg	C mm
C RN DAD10 100	100	320	128
C RN DAD11 125	125	400	155



RICAMBI - FISSAGGIO

SERRATURA DI RICAMBIO

ART. M 00 CSRO 8800 00 00
Serratura di ricambio con due chiavi



CHIAVE DI RICAMBIO

ART. M 00 CF00 0000 00 00

Specificare sempre il numero indicato nella serratura a cilindro dove si vuole sostituire la chiave



PASSEPARTOUT

ART. M 00 PF.. 0000 00 00

Disponibile in 23 serie, con numerazione da F 01 a F 23.

Passepartout serie F 01
Passepartout serie F 02
Passepartout serie F ..

ART. M 00 PF01 00 00 00 00
ART. M 00 PF02 00 00 00 00
ART. M 00 PF.. 00 00 00 00

SET FISSAGGIO TRA ARMADI

ART. M 00 FISO 00 00 00 99

Set di fissaggio armadio-armadio con 4 viti complete di dadi M8

ART. M 00 SVRO 00 00 00 99

Foratura e viteria per il fissaggio dei due armadi sovrapposti

SET DI FISSAGGIO A PAVIMENTO



ART. F AG 9200 00 99

Coppia staffe zincate per il fissaggio a pavimento dell'armadio

ART. F AG 9204 00 99

2 tasselli "HILTI" adatti per pavimenti in calcestruzzo non fessurato maggiore o uguale alla classe C20/25
Trazione consigliata del tassello: 2,9 kN
Diametro tassello: Ø 6 mm



MANIGLIA DI RICAMBIO

ART. M 00 PLSO 0000 22 MO

Maniglia di ricambio per porte disponibile in colore Dark Grey.



ALTRI COLORI A RICHIESTA



GLI ARMADI DEVONO ESSERE FISSATI A PAVIMENTO O A PARETE
SE SOVRAPPosti DEVONO ESSERE FISSATI OBBLIGATORIAMENTE A PARETE E LA LORO PORTATA DIVISA PER DUE



MASTER

408x573 mm

Born To Be Extreme

ARMADIO VUOTO senza asta vertebrata e senza chiusura



H 400 mm
H utile 300 mm



H 600 mm
H utile 500 mm



H 700 mm
H utile 600 mm



H 800 mm
H utile 700 mm



H 1000 mm
H utile 900 mm



M 12 A040 X0 10 00 _ _

M 12 A060 X0 10 00 _ _

M 12 A070 X0 10 00 _ _

M 12 A080 X0 10 00 _ _

M 12 A100 X0 10 00 _ _

ASTA VERTEBRATA



L'asta vertebrata è composta da un profilo in alluminio estruso forato a passo 25 mm per l'inserimento della molla antiribaltamento. L'asta antiribaltamento viene fornita completa di accessori in plastica e struttura superiore predisposta per la chiusura a cilindro o elettronica.

ART.	H utile inserimento cassette mm
M 00 V030 00 00 00 00	300
M 00 V050 00 00 00 00	500
M 00 V060 00 00 00 00	600
M 00 V070 00 00 00 00	700
M 00 V075 00 00 00 00	750
M 00 V090 00 00 00 00	900

CHIUSURA CON CILINDRO (KEY)



CHIUSURA CON CILINDRO COMPLETA DI:

- 1 serratura a cilindro con 2 chiavi
- 1 filo in acciaio con guaina
- 1 gruppo percussore anteriore
- 1 gruppo cursore posteriore

ART.

M 12 V000 C0 00 00 00

C0

CHIUSURA A CILINDRO CON NUMERAZIONE DIVERSA

M 12 V000 C1 00 00 00

C1

CHIUSURA A CILINDRO PER GRUPPI DI 160 NUMERI

M 12 V000 C2 00 00 00

C2

CHIUSURA A CILINDRO CON NUMERAZIONE UGUALE

For Experts Only

CHIUSURA CON CODICE NUMERICO (CODE)



ART.	
M 12 V000 E2 00 00 00	E2 APERTURA/CHIUSURA ASTA (alimentazione a batteria)
M 12 V000 E5 00 00 00	E5 APERTURA/CHIUSURA ASTA (alimentazione da rete elettrica)
M 12 V000 T2 00 00 00	T2 APERTURA/CHIUSURA ASTA + PORTA (alimentazione a batteria)
M 12 V000 T3 00 00 00	T3 APERTURA/CHIUSURA ASTA + PORTA (alimentazione da rete elettrica)

ART. TELECOMANDO

M 00 VRC0 00 00 00 00	Modulo ricevitore con telecomando
M 00 VRC0 00 00 01 00	Telecomando aggiuntivo



PIANI PER SERRATURE E PIANI REGOLABILI

PIANO SUPERIORE PER SERRATURE



ART.		H frontale mm	kg
M 12 PS46 00 10 00 __		46	150

Dim. mm 357x571x46 h

PIANO INFERIORE PER SERRATURE



ART.		H frontale mm	kg
M 12 PS46 10 10 00 __		46	150

Dim. mm 357x571x46 h

PIANO REGOLABILE



ART.		H totale mm	kg
M 12 PR25 00 00 01 __		60	70

Dim. utili mm 351x478x60 h

PIANO REGOLABILE FESSURATO



ART.		H frontale mm	kg
M 12 PR35 10 00 01 __		35	100

Dim. mm 357x568x35 h

18x27 EH

MATERIALE DI SEPARAZIONE

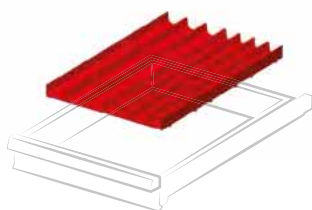

ART. per altezza frontale mm

F FH 8205 02 00 50 - 300

Set composto da: 3 divisori 4 canali, 3 divisori 3 canali, 16 divisori trasversali 36 mm, 7 divisori trasversali 47 mm

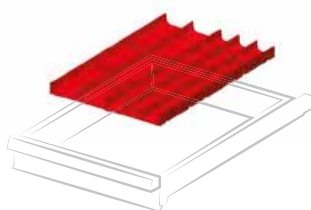

ART. per altezza frontale mm

F FH 8205 03 00 50 - 300

Set composto da: 3 divisori 3 canali, 3 divisori 2 canali, 15 divisori trasversali 47 mm, 8 divisori trasversali 73 mm

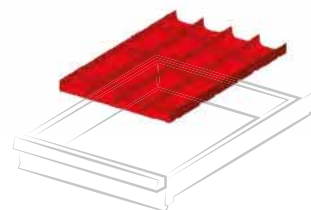

ART. per altezza frontale mm

F FH 8205 04 00 50 - 300

Set composto da: 6 divisori 2 canali, 18 divisori trasversali 73 mm

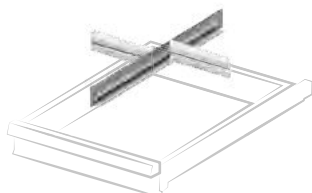

ART. per altezza frontale mm

F FH 8005 08 00 50

F FH 8007 08 00 75

F FH 8010 08 00 100 - 125

F FH 8015 08 00 150

F FH 8020 08 00 200 - 250

F FH 8030 08 00 300

Set composto da: 1 divisorio longitudinale fessurato 455 mm, 2 divisori trasversali 149 mm

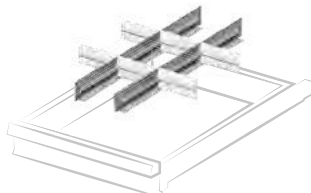

ART. per altezza frontale mm

F FH 8005 09 00 50

F FH 8007 09 00 75

F FH 8010 09 00 100 - 125

F FH 8015 09 00 150

Set composto da: 2 divisori longitudinali fessurati 455 mm, 6 divisori trasversali 98 mm

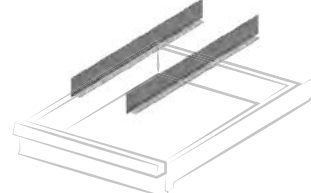

ART. per altezza frontale mm

F FH 8405 13 00 50

F FH 8407 13 00 75

F FH 8410 13 00 100 - 125

F FH 8415 13 00 150

F FH 8420 13 00 200 - 250

Set composto da: 2 divisori longitudinali non fessurati 455 mm

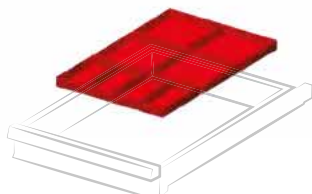

ART. per altezza frontale mm

F FH 8205 18 00 50

F FH 8207 18 00 75

F FH 8210 18 00 100 - 125

Set composto da: 4 cassette divisorio 150x75 mm, 4 cassette divisorio 150x150 mm

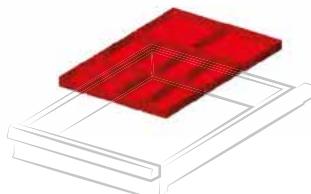

ART. per altezza frontale mm

F FH 8205 17 00 50

F FH 8207 17 00 75

Set composto da: 4 cassette divisorio 75x75 mm, 6 cassette divisorio 150x75 mm, 2 cassette divisorio 150x150 mm

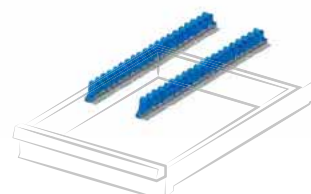

ART. per altezza frontale mm

F FH 8605 19 00 50 - 300

Set composto da: 2 supporti multiuso 440 mm

CONFIGURA IL CASSETTO FAMI CON UTENSILI BETA

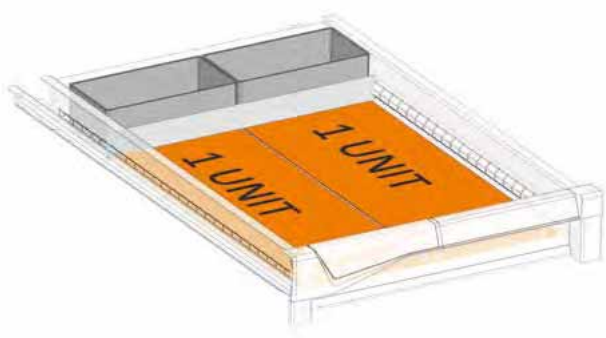

ART. F FH 0707 50 07

Set predisposizione cassetto per termoformati Beta composto da:
n. 2 F HC 6471 00 07
n. 1 F HA 3160 00 00

1 unit = 1 termoformato Beta 367x147 mm



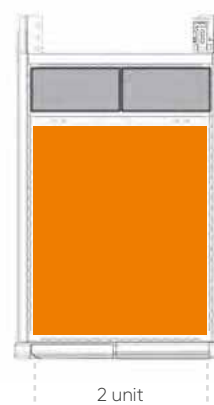
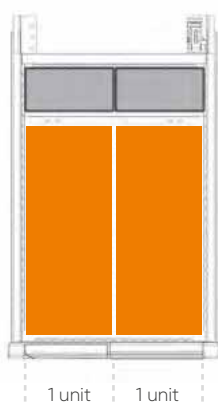

2 unit = 1 termoformato Beta 367x294 mm

ESEMPI DI UTILIZZO TERMOFORMATO













Gamma colori ACCIAIO

	
GRIGIO RAL 7000 .01	VERDE RAL 6011 .02
	
BLU RAL 5012 .04	GRIGIO RAL 7035 .08
	
BIANCO GRIGIASTRO RAL 9002 .1F	ROSSO RUBINO RAL 3003 .1G
	
BLU GENZIANA RAL 5010 .34	BIANCO PURO RAL 9010 .35
	
GRIGIO ANTRACITE RAL 7016 .39	BLU CAPRI RAL 5019 .48



● ART. M 22 A100 CO 10 AZ 04
H = 1000 mm - 7 cassetti

Gamma colori PLASTICHE

			
DARK GREY .M0	MEDITERRANEAN BLUE .M1	SKY BLUE .M2	GLAMOUR RED .M3
			
RED CARPET .M4	JUICE ORANGE .M5	SUNNY YELLOW .M6	FOREST GREEN .M7

LEGENDA



PORTATA
CASSETTO/
PIANO



ESTRAZIONE
CASSETTO/
PIANO



CHIUSURA
ARMADIO



LE PORTATE SONO NETTE E SI RIFERISCONO A PESI UNIFORMEMENTE DISTRIBUITI.

H 400 mm



ART.					
M 22 A040 C0 10 04 04		50-75-100	100-96-92%	key	
M 22 A040 E2 10 04 04		50-75-100	100-96-92%	code	

H 400 mm



ART.					
M 22 A040 C0 10 02 04		50-75-100	100-96-92%	key	
M 22 A040 E2 10 02 04		50-75-100	100-96-92%	code	

H 600 mm



ART.					
M 22 A060 C0 10 20 04		50-75-100	100-96-92%	key	
M 22 A060 E2 10 20 04		50-75-100	100-96-92%	code	

H 600 mm



ART.					
M 22 A060 C0 10 17 04		50-75-100	100-96-92%	key	porta 425 mm profondità 598 mm
M 22 A060 T2 10 17 04		50-75-100	100-96-92%	code	

H 700 mm



ART.					
M 22 A070 C0 10 31 04		50-75-100	100-96-92%	key	
M 22 A070 E2 10 31 04		50-75-100	100-96-92%	code	

H 700 mm



ART.					
M 22 A070 C0 10 30 04		50-75-100	100-96-92%	key	porta 425 mm profondità 598 mm
M 22 A070 T2 10 30 04		50-75-100	100-96-92%	code	

H 800 mm



ART.				
M 22 A080 C0 10 54 04		50-75-100	100-96-92%	key
M 22 A080 E2 10 54 04		50-75-100	100-96-92%	code

H 800 mm



ART.				
M 22 A080 C0 10 56 04		50-75-100	100-96-92%	key
M 22 A080 E2 10 56 04		50-75-100	100-96-92%	code

H 850 mm



ART.				
M 22 A085 C0 10 93 04		50-75-100	100-96-92%	key
M 22 A085 E2 10 93 04		50-75-100	100-96-92%	code

H 850 mm



ART.				
M 22 A085 C0 10 94 04		50-75-100	100-96-92%	key
M 22 A085 E2 10 94 04		50-75-100	100-96-92%	code

H 850 mm



ART.				
M 22 A085 C0 10 95 04		50-75-100	100-96-92%	key
M 22 A085 E2 10 95 04		50-75-100	100-96-92%	code

H 850 mm



ART.				
M 22 A085 C0 10 97 04		50-75-100	100-96-92%	key
M 22 A085 T2 10 97 04		50-75-100	100-96-92%	code

H 1000 mm



H 1000 mm



porta 625 mm

profondità 598 mm

ART.				
● M 22 A100 C0 10 AZ 04		50-75-100	100-96-92%	key
M 22 A100 E2 10 AZ 04		50-75-100	100-96-92%	code

ART.				
M 22 A100 C0 10 BD 04		50-75-100	100-96-92%	key
M 22 A100 T2 10 BD 04		50-75-100	100-96-92%	code



ART. M 22 A100 T2 16 BC 48

H 818 mm



ART.				
M 22 R060 SO 10 20 04		50-75-100	100-96-92%	key
M 22 R060 P2 10 20 04		50-75-100	100-96-92%	code

Portata armadio 235 kg - Altezza armadio senza ruote mm 663

H 818 mm



ART.				
M 22 R060 SO 10 21 04		50-75-100	100-96-92%	key
M 22 R060 P2 10 21 04		50-75-100	100-96-92%	code

Portata armadio 235 kg - Altezza armadio senza ruote mm 663

H 918 mm



ART.				
M 22 R070 SO 10 31 04		50-75-100	100-96-92%	key
M 22 R070 P2 10 31 04		50-75-100	100-96-92%	code

Portata armadio 235 kg - Altezza armadio senza ruote mm 763

H 918 mm



ART.				
M 22 R070 SO 10 32 04		50-75-100	100-96-92%	key
M 22 R070 P2 10 32 04		50-75-100	100-96-92%	code

Portata armadio 235 kg - Altezza armadio senza ruote mm 763



2 ruote girevoli con freno in gomma standard Ø 125 mm
2 ruote fisse in gomma standard Ø 125 mm

H 1018 mm



ART.		kg		
M 22 R080 S0 10 54 04		50-75-100	100-96-92%	key
M 22 R080 P2 10 54 04		50-75-100	100-96-92%	code

Portata armadio 235 kg - Altezza armadio senza ruote mm 863

H 1018 mm



ART.		kg		
M 22 R080 S0 10 56 04		50-75-100	100-96-92%	key
M 22 R080 P2 10 56 04		50-75-100	100-96-92%	code

Portata armadio 235 kg - Altezza armadio senza ruote mm 863

H 1068 mm



ART.		kg		
M 22 R085 S0 10 93 04		50-75-100	100-96-92%	key
M 22 R085 P2 10 93 04		50-75-100	100-96-92%	code

Portata armadio 235 kg - Altezza armadio senza ruote mm 913

H 1068 mm



ART.		kg		
M 22 R085 S0 10 94 04		50-75-100	100-96-92%	key
M 22 R085 P2 10 94 04		50-75-100	100-96-92%	code

Portata armadio 235 kg - Altezza armadio senza ruote mm 913



2 ruote girevoli con freno in gomma standard Ø 125 mm
2 ruote fisse in gomma standard Ø 125 mm

H 1218 mm



H 1218 mm



ART.				
M 22 R100 S0 10 AY 04		50-75-100	100-96-92%	key
M 22 R100 P2 10 AY 04		50-75-100	100-96-92%	code

Portata armadio 235 kg - Altezza armadio senza ruote mm 1063

ART.				
M 22 R100 S0 10 AZ 04		50-75-100	100-96-92%	key
M 22 R100 P2 10 AZ 04		50-75-100	100-96-92%	code

Portata armadio 235 kg - Altezza armadio senza ruote mm 1063



2 ruote girevoli con freno in gomma standard Ø 125 mm
2 ruote fisse in gomma standard Ø 125 mm



ART. M ZA 0600 00 00 00 PA



ART. M 22 A100 T2 16 BC 48



ART. M 22 R070 P2 10 NE 1F

CONFIGURA IL TUO ARMADIO

	SCEGLI l'altezza	SCEGLI la chiusura		SCEGLI il colore
M22	A040	C5	10 00	01

ARMADIO VUOTO



Portata corpo
armadio 3100 kg

M22	ALTEZZA		CHIUSURA		10 00	COLORE	
	Model	Height (mm) (useful mm)	Icon	Description		Code	Color Name
	A040	400 mm (utile 300 mm)	X0	senza asta e senza serratura		01	RAL 7000
	A060	600 mm (utile 500 mm)	C5*	senza serratura		02	RAL 6011
	A070	700 mm (utile 600 mm)	C0*	KEY chiusura a cilindro		1G	RAL 3003
	A080	800 mm (utile 700 mm)	C1*	KEY chiusura a cilindro		1F	RAL 9002
	A085	850 mm (utile 750 mm)	C2*	KEY chiusura a cilindro		48	RAL 5019
	A100	1000 mm (utile 900 mm)	E2*	CODE codice numerico		39	RAL 7016
	A150	1500 mm (utile 1400 mm)	T2*	CODE codice numerico		04	RAL 5012
	A200	2000 mm (utile 1900 mm)				08	RAL 7035
					35	RAL 9010	
					34	RAL 5010	

*COMPLETO DI ASTA VERTEBRATA

ARMADIO VUOTO predisposto per ruote



M22	ALTEZZA		CHIUSURA		10 00	COLORE	
	Model	Height (mm) (useful mm)	Icon	Description		Code	Color Name
	R060	663 mm (utile 500 mm)	S0	KEY chiusura a cilindro		01	RAL 7000
	R070	763 mm (utile 600 mm)	S1	KEY chiusura a cilindro		02	RAL 6011
	R080	863 mm (utile 700 mm)	S2	KEY chiusura a cilindro		1G	RAL 3003
	R085	913 mm (utile 750 mm)	P2	CODE codice numerico		1F	RAL 9002
	R100	1063 mm (utile 900 mm)	A1	CODE codice numerico		48	RAL 5019
						39	RAL 7016
						04	RAL 5012
						08	RAL 7035
					35	RAL 9010	
					34	RAL 5010	

COMPLETO DI ASTA VERTEBRATA, PIANO A 4 BORDI CON COPERTURA IN PVC, COPPIA MANIGLIE, COPPIA PIASTRE
Dim. ingombro mm 587x647



CASSETTI AD ESTRAZIONE FLESSIBILE

ART. CON kit plastiche Dark Grey	ART. SENZA kit plastiche*	Dim. utili mm	H frontale mm	kg	
M 22 C050 0110 OF __	M 22 C050 01 00 OF __	447x447x31 H	50	50 - 75 - 100	100% - 96% - 92%
M 22 C075 0110 OF __	M 22 C075 01 00 OF __	447x447x56 H	75	50 - 75 - 100	100% - 96% - 92%
M 22 C100 0110 OF __	M 22 C100 01 00 OF __	447x447x81 H	100	50 - 75 - 100	100% - 96% - 92%
M 22 C125 0110 OF __	M 22 C125 01 00 OF __	447x447x106 H	125	50 - 75 - 100	100% - 96% - 92%
M 22 C150 0110 OF __	M 22 C150 01 00 OF __	447x447x131 H	150	50 - 75 - 100	100% - 96% - 92%
M 22 C200 0110 OF __	M 22 C200 01 00 OF __	447x447x181 H	200	50 - 75 - 100	100% - 96% - 92%
M 22 C250 0110 OF __	M 22 C250 01 00 OF __	447x447x231 H	250	50 - 75 - 100	100% - 96% - 92%
M 22 C300 0110 OF __	M 22 C300 01 00 OF __	447x447x281 H	300	50 - 75 - 100	100% - 96% - 92%

* ABBINARE AL CODICE ARTICOLO UNO DEI KIT PLASTICHE DISPONIBILI NELLA TABELLA SOTTOSTANTE



CASSETTI AD ESTRAZIONE TELESCOPICA

ART. CON kit plastiche Dark Grey	ART. SENZA kit plastiche*	Dim. utili mm	H frontale mm	kg	
M 22 C075 0110 OT __	M 22 C075 01 00 OT __	447x447x56 H	75	200	100%
M 22 C100 0110 OT __	M 22 C100 01 00 OT __	447x447x81 H	100	200	100%
M 22 C125 0110 OT __	M 22 C125 01 00 OT __	447x447x106 H	125	200	100%
M 22 C150 0110 OT __	M 22 C150 01 00 OT __	447x447x131 H	150	200	100%
M 22 C200 0110 OT __	M 22 C200 01 00 OT __	447x447x181 H	200	200	100%
M 22 C250 0110 OT __	M 22 C250 01 00 OT __	447x447x231 H	250	200	100%
M 22 C300 0110 OT __	M 22 C300 01 00 OT __	447x447x281 H	300	200	100%

* ABBINARE AL CODICE ARTICOLO UNO DEI KIT PLASTICHE DISPONIBILI NELLA TABELLA SOTTOSTANTE

KIT PLASTICHE PER CASSETTI E PIANI ESTRAIBILI



GAMMA COLORI PLASTICHE	ART.
MEDITERRANEAN BLUE	M 20 PLS1 00 00 00 M1
SKY BLUE	M 20 PLS1 00 00 00 M2
GLAMOUR RED	M 20 PLS1 00 00 00 M3
RED CARPET	M 20 PLS1 00 00 00 M4
JUICY ORANGE	M 20 PLS1 00 00 00 M5
SUNNY YELLOW	M 20 PLS1 00 00 00 M6
FOREST GREEN	M 20 PLS1 00 00 00 M7



PIANI ESTRAIBILI AD ESTRAZIONE FLESSIBILE

ART. CON kit plastiche Dark Grey	ART. SENZA kit plastiche*	Dim. utili mm	H frontale mm	kg	
M 22 C057 0110 OF __	M 22 C057 01 00 OF __	447x447	70	50 - 75 - 100	100% - 96% - 92%

* ABBINARE AL CODICE ARTICOLO UNO DEI KIT PLASTICHE DISPONIBILI NELLA TABELLA SOTTOSTANTE



PIANI ESTRAIBILI AD ESTRAZIONE TELESCOPICA

ART. CON kit plastiche Dark Grey	ART. SENZA kit plastiche*	Dim. utili mm	H frontale mm	kg	
M 22 C057 0110 OT __	M 22 C057 01 00 OT __	447x447	70	200	100%

* ABBINARE AL CODICE ARTICOLO UNO DEI KIT PLASTICHE DISPONIBILI NELLA TABELLA SOTTOSTANTE



PIANO REGOLABILE

ART.	Dim. utili mm	H totale mm	kg
M 22 PR25 00 00 01 __	504x478	60	70

INSERIBILE DAVANTI ALL'ASTA VERTEBRATA

KIT PLASTICHE PER CASSETTI E PIANI ESTRAIBILI



GAMMA COLORI PLASTICHE	ART.
MEDITERRANEAN BLUE	M 20 PLS1 00 00 00 M1
SKY BLUE	M 20 PLS1 00 00 00 M2
GLAMOUR RED	M 20 PLS1 00 00 00 M3
RED CARPET	M 20 PLS1 00 00 00 M4
JUICY ORANGE	M 20 PLS1 00 00 00 M5
SUNNY YELLOW	M 20 PLS1 00 00 00 M6
FOREST GREEN	M 20 PLS1 00 00 00 M7



ART. M 22 A150 C0 11 NA 50

🔑 PORTE A BATTENTE CON CILINDRO

PORTE A BATTENTE ALTEZZA TOTALE - REVERSIBILE



H ARMADIO mm	TIPO DI CHIUSURA	ART. CON kit plastiche Dark Grey 	ART. SENZA kit plastiche* 
600	 C0 KEY chiusura a cilindro	M 20 P050 C0 10 00 __	M 20 P050 C0 00 00 __
	 C1 KEY chiusura a cilindro	M 20 P050 C1 10 00 __	M 20 P050 C1 00 00 __
	 C2 KEY chiusura a cilindro	M 20 P050 C2 10 00 __	M 20 P050 C2 00 00 __
700	 C0 KEY chiusura a cilindro	M 20 P060 C0 10 00 __	M 20 P060 C0 00 00 __
	 C1 KEY chiusura a cilindro	M 20 P060 C1 10 00 __	M 20 P060 C1 00 00 __
	 C2 KEY chiusura a cilindro	M 20 P060 C2 10 00 __	M 20 P060 C2 00 00 __











* ABBINARE AL CODICE ARTICOLO UNO DEI KIT PLASTICHE DISPONIBILI NELLA TABELLA A DESTRA



LA PORTA DEVE ESSERE ASSOCIATA OBBLIGATORIAMENTE AGLI ARMADI CON LA CHIUSURA:
C5 (SENZA SERRATURA) OPPURE **X0** (SENZA ASTA VERTEBRATA E SENZA SERRATURA)

PORTE A BATTENTE ALTEZZA PARZIALE - REVERSIBILE



H INGOMBRO PORTA mm	TIPO DI CHIUSURA	ART. CON kit plastiche Dark Grey 	ART. SENZA kit plastiche* 
425	 C0 KEY chiusura a cilindro	M 20 P042 C0 10 01 __	M 20 P042 C0 00 01 __
	 C1 KEY chiusura a cilindro	M 20 P042 C1 10 01 __	M 20 P042 C1 00 01 __
	 C2 KEY chiusura a cilindro	M 20 P042 C2 10 01 __	M 20 P042 C2 00 01 __
525	 C0 KEY chiusura a cilindro	M 20 P052 C0 10 01 __	M 20 P052 C0 00 01 __
	 C1 KEY chiusura a cilindro	M 20 P052 C1 10 01 __	M 20 P052 C1 00 01 __
	 C2 KEY chiusura a cilindro	M 20 P052 C2 10 01 __	M 20 P052 C2 00 01 __
625	 C0 KEY chiusura a cilindro	M 20 P062 C0 10 01 __	M 20 P062 C0 00 01 __
	 C1 KEY chiusura a cilindro	M 20 P062 C1 10 01 __	M 20 P062 C1 00 01 __
	 C2 KEY chiusura a cilindro	M 20 P062 C2 10 01 __	M 20 P062 C2 00 01 __

* ABBINARE AL CODICE ARTICOLO UNO DEI KIT PLASTICHE DISPONIBILI NELLA TABELLA A DESTRA



PORTE A BATTENTE CON CODICE NUMERICO



PORTE A BATTENTE ALTEZZA TOTALE - APERTURA SOLO A DESTRA

H ARMADIO mm	TIPO DI CHIUSURA	ART. CON kit plastiche Dark Grey	ART. SENZA kit plastiche*
600	P5 CODE codice numerico	M 20 P050 P5 10 00 _ _	M 20 P050 P5 00 00 _ _
700	P5 CODE codice numerico	M 20 P060 P5 10 00 _ _	M 20 P060 P5 00 00 _ _

* ABBINARE AL CODICE ARTICOLO UNO DEI KIT PLASTICHE DISPONIBILI NELLA TABELLA SOTTOSTANTE



LA PORTA DEVE ESSERE ASSOCIATA OBBLIGATORIAMENTE AGLI ARMADI CON LA CHIUSURA:
C5 (SENZA SERRATURA) OPPURE **X0** (SENZA ASTA VERTEBRATA E SENZA SERRATURA)

PORTE A BATTENTE ALTEZZA PARZIALE - REVERSIBILE



H INGOMBRO PORTA mm	TIPO DI CHIUSURA	ART. CON kit plastiche Dark Grey	ART. SENZA kit plastiche*
425	A4 maniglia senza tastierino	M 20 P042 A4 10 01 _ _	M 20 P042 A4 00 01 _ _
525	A4 maniglia senza tastierino	M 20 P052 A4 10 01 _ _	M 20 P052 A4 00 01 _ _
625	A4 maniglia senza tastierino	M 20 P062 A4 10 01 _ _	M 20 P062 A4 00 01 _ _

* ABBINARE AL CODICE ARTICOLO UNO DEI KIT PLASTICHE DISPONIBILI NELLA TABELLA SOTTOSTANTE



LA PORTA DEVE ESSERE ASSOCIATA OBBLIGATORIAMENTE AGLI ARMADI CON LE CHIUSURE:
UTILIZZARE LA SERRATURA **T2** PER L'ARMADIO SENZA RUOTE
UTILIZZARE LA SERRATURA **A1** PER L'ARMADIO CON RUOTE

TELECOMANDO



ART.	
M 00 VRC0 00 00 00 00	Modulo ricevitore con telecomando
M 00 VRC0 00 00 01 00	Telecomando aggiuntivo

KIT PLASTICHE PER PORTE A BATTENTE



GAMMA COLORI PLASTICHE	ART. KEY	ART. CODE
MEDITERRANEAN BLUE	M 00 PLS0 00 00 20 M1	M 00 PLS0 00 00 21 M1
SKY BLUE	M 00 PLS0 00 00 20 M2	M 00 PLS0 00 00 21 M2
GLAMOUR RED	M 00 PLS0 00 00 20 M3	M 00 PLS0 00 00 21 M3
RED CARPET	M 00 PLS0 00 00 20 M4	M 00 PLS0 00 00 21 M4
JUICY ORANGE	M 00 PLS0 00 00 20 M5	M 00 PLS0 00 00 21 M5
SUNNY YELLOW	M 00 PLS0 00 00 20 M6	M 00 PLS0 00 00 21 M6
FOREST GREEN	M 00 PLS0 00 00 20 M7	M 00 PLS0 00 00 21 M7



PIANO SUPERIORE A 3 BORDI

ART.	dim. mm	
M 22 T023 AG 00 31 07	561x573x23 H	

Piano rivestito in pvc per ARMADIO SINGOLO. Colore nero



PIANO SUPERIORE A 4 BORDI

ART.	dim. mm	
M 22 T023 AG 00 41 07	561x573x23 H	

Piano rivestito in pvc per ARMADIO SINGOLO. Colore nero



ART. M 00 T023 AG 00 FO 00
FORATURA PIANO SUPERIORE DELL'ARMADIO
PER IL FISSAGGIO DEL PIANO A 4 BORDI



PIANO SUPERIORE IN MULTIPLEX

ART.	dim. mm	
M 22 T040 MU 00 01 00	561x573x40 H	

Per ARMADIO SINGOLO



PIANO SUPERIORE IN MDF DIM. 561x573x32 mm H

ART.	rifiniture	per armadio	
M 22 T030 MD GM 21 07	1 profilo laterale	finale dx o sx	

Piano in MDF con copertura in gomma antiolio. Colore nero



PIANO SUPERIORE IN MDF DIM. 561x573x32 mm H

ART.	rifiniture	per armadio	
M 22 T030 MD GM 11 07	-	centrale	

Piano in MDF con copertura in gomma antiolio. Colore nero



PIANO SUPERIORE IN MDF DIM. 561x573x32 mm H

ART.	rifiniture	per armadio	
M 22 T030 MD GM 01 07	2 profili laterali	singolo	

Piano in MDF con copertura in gomma antiolio. Colore nero



ART. M 00 T030 MD 00 FO 00
FORATURA PIANO SUPERIORE DELL'ARMADIO PER IL FISSAGGIO DEL
PIANO IN MDF E DEL PIANO IN MULTIPLEX
COMPRESIVO DI VITI PER IL FISSAGGIO

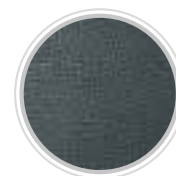

RIFINITURA
GOMMA
ANTIOLIO



APPLICAZIONE
PIANO IN MDF



ZOCCOLO DI RIALZO ALTEZZA 50 mm

ART.	dim. mm	
M 22 Z050 00 00 00	559x572x50 H	



ZOCCOLO DI RIALZO ALTEZZA 100 mm

ART.	dim. mm	
M 22 Z100 00 00 00	559x572x100 H	

RUOTA FISSA IN GOMMA STANDARD

ART.	Ø mm	portata armadio kg	C mm
C RG BAC11 100	100	160	128
C RG BAC12 125	125	235	155



RUOTA GIREVOLE CON FRENO IN GOMMA STANDARD

ART.	Ø mm	portata armadio kg	C mm
C RG DAC11 100	100	160	128
C RG DAC12 125	125	235	155



RUOTA FISSA IN NYLON

ART.	Ø mm	portata armadio kg	C mm
C RN BAD10 100	100	310	128
C RN BAD11 125	125	400	155



RUOTA GIREVOLE CON FRENO IN NYLON

ART.	Ø mm	portata armadio kg	C mm
C RN DAD10 100	100	310	128
C RN DAD11 125	125	400	155



RICAMBI - FISSAGGIO

SERRATURA DI RICAMBIO

ART. M 00 CSR0 8800 00 00

Serratura di ricambio con due chiavi



CHIAVE DI RICAMBIO

ART. M 00 CF00 0000 00 00

Specificare sempre il numero indicato nella serratura a cilindro dove si vuole sostituire la chiave



PASSEPARTOUT

ART. M 00 PF.. 0000 00 00

Disponibile in 23 serie, con numerazione da F 01 a F 23.

Passepartout serie F 01
Passepartout serie F 02
Passepartout serie F ..

ART. M 00 PF01 00 00 00 00
ART. M 00 PF02 00 00 00 00
ART. M 00 PF.. 00 00 00 00

SET FISSAGGIO TRA ARMADI

ART. M 00 FISO 00 00 00 99

Set di fissaggio armadio-armadio con 4 viti complete di dadi M8

ART. M 00 SVRO 00 00 00 99

Foratura e viteria per il fissaggio dei due armadi sovrapposti

SET DI FISSAGGIO A PAVIMENTO



ART. F AG 9200 00 99

Coppia staffe zincate per il fissaggio a pavimento dell'armadio

ART. F AG 9204 00 99

2 tasselli "HILTI" adatti per pavimenti in calcestruzzo non fessurato maggiore o uguale alla classe C20/25
Trazione consigliata del tassello: 2,9 kN
Diametro tassello: Ø 6 mm



MANIGLIA DI RICAMBIO

ART. M 00 PLS0 0000 22 M0

Maniglia di ricambio per porte disponibile in colore Dark Grey.



ALTRI COLORI A RICHIESTA



GLI ARMADI DEVONO ESSERE FISSATI A PAVIMENTO O A PARETE
SE SOVRAPPOSTI DEVONO ESSERE FISSATI OBBLIGATORIAMENTE A PARETE E LA LORO PORTATA DIVISA PER DUE

MASTER

561x573 mm

Born To Be Extreme

ARMADIO VUOTO senza asta vertebrata e senza chiusura



H 400 mm
H utile 300 mm



H 600 mm
H utile 500 mm



H 700 mm
H utile 600 mm



H 800 mm
H utile 700 mm



H 850 mm
H utile 750 mm



M 22 A040 X0 10 00 _ _

M 22 A060 X0 10 00 _ _

M 22 A070 X0 10 00 _ _

M 22 A080 X0 10 00 _ _

M 22 A085 X0 10 00 _ _

ASTA VERTEBRATA



L'asta vertebrata è composta da un profilo in alluminio estruso forato a passo 25 mm per l'inserimento della molla antiribaltamento. L'asta antiribaltamento viene fornita completa di accessori in plastica e struttura superiore predisposta per la chiusura a cilindro o elettronica.

ART.	H utile inserimento cassette mm
M 00 V030 00 00 00 00	300
M 00 V050 00 00 00 00	500
M 00 V060 00 00 00 00	600
M 00 V070 00 00 00 00	700
M 00 V075 00 00 00 00	750
M 00 V090 00 00 00 00	900

ART.	H utile inserimento cassette mm
M 00 V105 00 00 00 00	1050
M 00 V122 00 00 00 00	1225
M 00 V140 00 00 00 00	1400
M 00 V152 00 00 00 00	1525
M 00 V190 00 00 00 00	1900

CHIUSURA CON CILINDRO (KEY)



CHIUSURA A CILINDRO COMPLETA DI:

- 1 serratura a cilindro con 2 chiavi
- 1 filo in acciaio con guaina
- 1 gruppo percussore anteriore
- 1 gruppo cursore posteriore

ART.	
M 22 V000 C0 00 00 00	C0 CHIUSURA A CILINDRO CON NUMERAZIONE DIVERSA
M 22 V000 C1 00 00 00	C1 CHIUSURA A CILINDRO PER GRUPPI DI 160 NUMERI
M 22 V000 C2 00 00 00	C2 CHIUSURA A CILINDRO CON NUMERAZIONE UGUALE

For Experts Only



H 1000 mm
H utile 900 mm



H 1500 mm
H utile 1400 mm



H 2000 mm
H utile 1900 mm



M 22 A100 X0 10 00 __

M 22 A150 X0 10 00 __

M 22 A200 X0 10 00 __

CHIUSURA CON CODICE NUMERICO (CODE)



ART.

M 22 V000 E2 00 00 00

E2

APERTURA/CHIUSURA ASTA (alimentazione a batteria)

M 22 V000 E5 00 00 00

E5

APERTURA/CHIUSURA ASTA (alimentazione da rete elettrica)

M 22 V000 T2 00 00 00

T2

APERTURA/CHIUSURA ASTA + PORTA (alimentazione a batteria)

M 22 V000 T3 00 00 00

T3

APERTURA/CHIUSURA ASTA + PORTA (alimentazione da rete elettrica)

ART. TELECOMANDO

M 00 VRC0 00 00 00 00

Modulo ricevitore
con telecomando

M 00 VRC0 00 00 01 00

Telecomando aggiuntivo



PIANI PER SERRATURE E PIANI REGOLABILI

PIANO SUPERIORE PER SERRATURE



ART.



H frontale mm

kg

M 22 PS46 00 10 00 __

46

150

Dim. mm 510x571x46 h

PIANO INFERIORE PER SERRATURE



ART.



H frontale mm

kg

M 22 PS46 10 10 00 __

46

150

Dim. mm 510x571x46 h

PIANO REGOLABILE



ART.



H totale mm

kg

M 22 PR25 00 00 01 __

60

70

Dim. utili mm 504x478x60 h

PIANO REGOLABILE FESSURATO



ART.



H frontale mm

kg

M 22 PR35 10 00 01 __

35

100

Dim. mm 510x568x35 h

27x27 EH

MATERIALE DI SEPARAZIONE

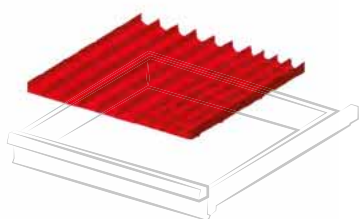

ART. per altezza frontale mm

F FH 8405 02 00 50 - 300

Set composto da: 3 divisori 4 canali, 6 divisori 3 canali, 16 divisori trasversali 36 mm, 7 divisori trasversali 47 mm

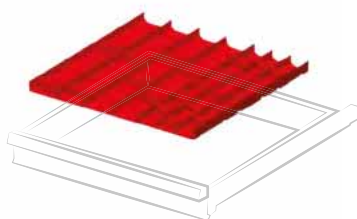

ART. per altezza frontale mm

F FH 8405 03 00 50 - 300

Set composto da: 3 divisori 3 canali, 6 divisori 2 canali, 15 divisori trasversali 47 mm, 8 divisori trasversali 73 mm

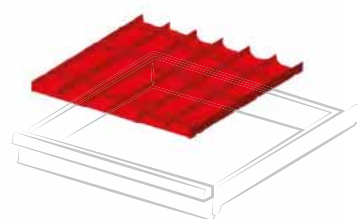

ART. per altezza frontale mm

F FH 8405 04 00 50 - 300

Set composto da: 9 divisori 2 canali, 18 divisori trasversali 73 mm

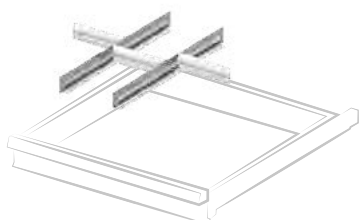

ART. per altezza frontale mm

F FH 8405 08 00 50

F FH 8407 08 00 75

F FH 8410 08 00 100 - 125

F FH 8415 08 00 150

F FH 8420 08 00 200 - 250

F FH 8430 08 00 300

Set composto da: 2 divisori longitudinali fessurati 455 mm, 3 divisori trasversali 149 mm

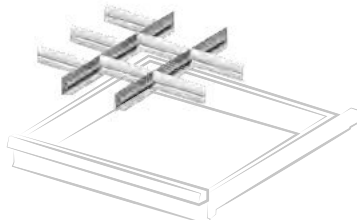

ART. per altezza frontale mm

F FH 8405 09 00 50

F FH 8407 09 00 75

F FH 8410 09 00 100 - 125

F FH 8415 09 00 150

F FH 8420 09 00 200 - 250

Set composto da: 2 divisori longitudinali fessurati 455 mm, 7 divisori trasversali 149 mm

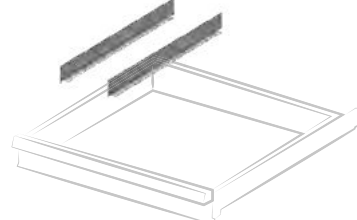

ART. per altezza frontale mm

F FH 8405 13 00 50

F FH 8407 13 00 75

F FH 8410 13 00 100 - 125

F FH 8415 13 00 150

F FH 8420 13 00 200 - 250

Set composto da: 2 divisori longitudinali non fessurati 455 mm

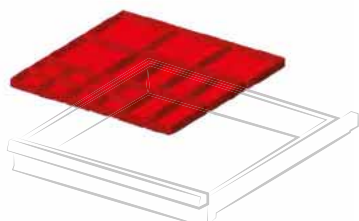

ART. per altezza frontale mm

F FH 8405 17 00 50

F FH 8407 17 00 75

Set composto da: 8 cassette divisorio 75x75 mm, 6 cassette divisorio 150x75 mm, 4 cassette divisorio 150x150 mm

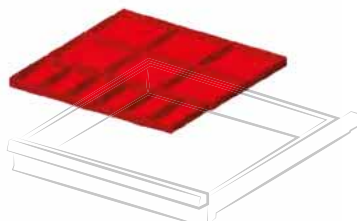

ART. per altezza frontale mm

F FH 8405 18 00 50

F FH 8407 18 00 75

F FH 8410 18 00 100 - 125

Set composto da: 6 cassette divisorio 150x75 mm, 6 cassette divisorio 150x150 mm

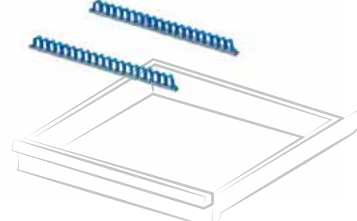

ART. per altezza frontale mm

F FH 8605 19 00 50 - 300

Set composto da: 2 supporti multiuso 440 mm

CONFIGURA IL CASSETTO FAMI CON UTENSILI BETA

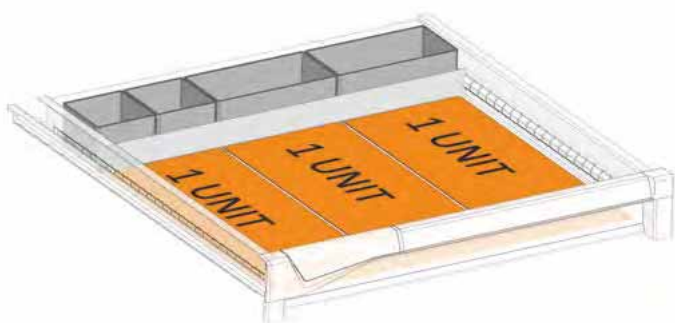

ART. F FH 0807 50 07

Set di predisposizione cassetto per termoformati Beta composto da:

n. 2 F HC 6071 00 07

n. 2 F HC 6471 00 07

n. 1 F HA 1121 00 99

1 unit = 1 termoformato Beta 367x147 mm



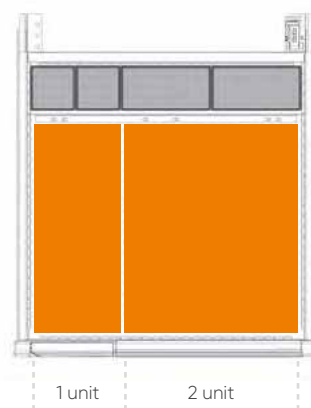
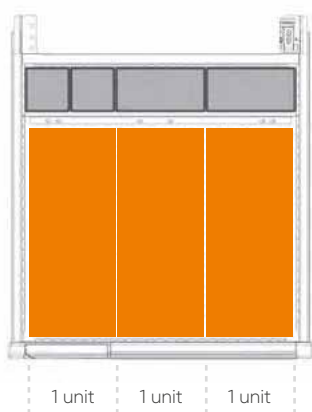

2 unit = 1 termoformato Beta 367x294 mm

ESEMPI DI UTILIZZO TERMOFORMATO











Gamma colori ACCIAIO

	
GRIGIO RAL 7000 .01	VERDE RAL 6011 .02
	
BLU RAL 5012 .04	GRIGIO RAL 7035 .08
	
BIANCO GRIGIASTRO RAL 9002 .1F	ROSSO RUBINO RAL 3003 .1G
	
BLU GENZIANA RAL 5010 .34	BIANCO PURO RAL 9010 .35
	
GRIGIO ANTRACITE RAL 7016 .39	BLU CAPRI RAL 5019 .48



- **ART. M 32 A100 C0 10 AW 04**
H = 1000 mm - 7 cassetti

Gamma colori PLASTICHE

			
DARK GREY .M0	MEDITERRANEAN BLUE .M1	SKY BLUE .M2	GLAMOUR RED .M3
			
RED CARPET .M4	JUICE ORANGE .M5	SUNNY YELLOW .M6	FOREST GREEN .M7

LEGENDA



PORTATA
CASSETTO/
PIANO



ESTRAZIONE
CASSETTO/
PIANO



CHIUSURA
ARMADIO



LE PORTATE SONO NETTE E SI RIFERISCONO A PESI UNIFORMEMENTE DISTRIBUITI.

H 400 mm



H 400 mm



ART.		kg			
M 32 A040 C0 10 04 04		50-75-100	100-96-92%	key	
M 32 A040 E2 10 04 04		50-75-100	100-96-92%	code	

ART.		kg			
M 32 A040 C0 10 01 04		50-75-100	100-96-92%	key	
M 32 A040 E2 10 01 04		50-75-100	100-96-92%	code	

H 600 mm



H 600 mm



ART.		kg			
M 32 A060 C0 10 20 04		50-75-100	100-96-92%	key	
M 32 A060 E2 10 20 04		50-75-100	100-96-92%	code	

ART.		kg			
M 32 A060 C0 10 17 04		50-75-100	100-96-92%	key	porta 425 mm profondità 598 mm
M 32 A060 T2 10 17 04		50-75-100	100-96-92%	code	

H 700 mm



H 700 mm



ART.		kg			
M 32 A070 C0 10 34 04		50-75-100	100-96-92%	key	
M 32 A070 E2 10 34 04		50-75-100	100-96-92%	code	

ART.		kg			
M 32 A070 C0 10 31 04		50-75-100	100-96-92%	key	
M 32 A070 E2 10 31 04		50-75-100	100-96-92%	code	

H 800 mm



ART.				
M 32 A080 C0 10 54 04		50-75-100	100-96-92%	key
M 32 A080 E2 10 54 04		50-75-100	100-96-92%	code

H 800 mm



porta 425 mm profondità 598 mm

ART.				
M 32 A080 C0 10 57 04		50-75-100	100-96-92%	key
M 32 A080 T2 10 57 04		50-75-100	100-96-92%	code

H 850 mm



ART.				
M 32 A085 C0 10 91 04		50-75-100	100-96-92%	key
M 32 A085 E2 10 91 04		50-75-100	100-96-92%	code

H 850 mm



porta 425 mm profondità 598 mm

ART.				
M 32 A085 C0 10 97 04		50-75-100	100-96-92%	key
M 32 A085 T2 10 97 04		50-75-100	100-96-92%	code



H 1000 mm



ART.		kg			
M 32 A100 C0 10 BE 04		50-75-100	100-96-92%	key	
M 32 A100 C0 10 BF 04		200	100%	key	
M 32 A100 E2 10 BE 04		50-75-100	100-96-92%	code	
M 32 A100 E2 10 BF 04		200	100%	code	

H 1000 mm



ART.		kg			
M 32 A100 C0 10 AW 04		50-75-100	100-96-92%	key	
M 32 A100 C0 10 BH 04		200	100%	key	
M 32 A100 E2 10 AW 04		50-75-100	100-96-92%	code	
M 32 A100 E2 10 BH 04		200	100%	code	

H 1000 mm



ART.		kg			
M 32 A100 C0 10 BL 04		50-75-100	100-96-92%	key	
M 32 A100 C0 10 BM 04		200	100%	key	
M 32 A100 E2 10 BL 04		50-75-100	100-96-92%	code	
M 32 A100 E2 10 BM 04		200	100%	code	

H 1000 mm



porta 625 mm profondità 598 mm

ART.		kg			
M 32 A100 C0 10 BD 04		50-75-100	100-96-92%	key	
M 32 A100 T2 10 BD 04		50-75-100	100-96-92%	code	

H 1023 mm



porta 900 mm

ART.		kg			
M 32 A100 C0 10 BU 04		50-75-100	100-96-92%	key	
M 32 A100 C0 10 BV 04		200	100%	key	
M 32 A100 P5 10 BU 04		50-75-100	100-96-92%	code	
M 32 A100 P5 10 BV 04		200	100%	code	

H 1023 mm



porta 775 mm

*estrazione flessibile

ART.		kg			
M 32 A100 C0 10 CL 04		50-75-100	100-96-92%	key	
M 32 A100 C0 10 CM 04		200	100%	key	
M 32 A100 T2 10 CL 04		50-75-100	100-96-92%	code	
M 32 A100 T2 10 CM 04		200	100%	code	

H 1500 mm



profondità 573 mm

ART.		kg			
M 32 A150 C0 10 FJ 04		50-75-100	100-96-92%	key	
M 32 A150 C0 10 FK 04		200	100%	key	
M 32 A150 E2 10 FJ 04		50-75-100	100-96-92%	code	
M 32 A150 E2 10 FK 04		200	100%	code	

H 1500 mm



porta 1400 mm

ART.		kg			
M 32 A150 C0 10 LC 04		50-75-100	100-96-92%	key	
M 32 A150 C0 10 LD 04		200	100%	key	
M 32 A150 P5 10 LC 04		50-75-100	100-96-92%	code	
M 32 A150 P5 10 LD 04		200	100%	code	



ART. M 32 A150 C0 15 NQ 34

ART. M 32 A100 C0 15 NP 34

H 2000 mm



H 2000 mm



ART.			
M 32 A200 C5 10 FU 04	50-75-100	100-96-92%	-
M 32 A200 C5 10 FV 04	200	100%	-

ART.			
M 32 A200 C0 10 FS 04	50-75-100	100-96-92%	key
M 32 A200 C0 10 FT 04	200	100%	key
M 32 A200 E2 10 FS 04	50-75-100	100-96-92%	code
M 32 A200 E2 10 FT 04	200	100%	code



H 2000 mm



porta 900 mm

ART.		kg		
M 32 A200 C0 10 FY 04		50-75-100	100-96-92%	key
M 32 A200 C0 10 FZ 04		200	100%	key
M 32 A200 T2 10 FY 04		50-75-100	100-96-92%	code
M 32 A200 T2 10 FZ 04		200	100%	code

H 2000 mm



porta 1900 mm

ART.		kg		
M 32 A200 C0 10 FW 04		50-75-100	100-96-92%	key
M 32 A200 C0 10 FX 04		200	100%	key
M 32 A200 P5 10 FW 04		50-75-100	100-96-92%	code
M 32 A200 P5 10 FX 04		200	100%	code



MASTER



H 873 mm



porta singola

profondità 598 mm

ART.					
M 32 D085 C0 10 GJ 04		50-75-100	100-96-92%	key	
M 32 D085 C0 10 GK 04		200	100%	key	

H 1023 mm



porta singola

profondità 598 mm

ART.					
M 32 D100 C0 10 GQ 04		50-75-100	100-96-92%	key	
M 32 D100 C0 10 GR 04		200	100%	key	

H 1023 mm



porta doppia

ART.					
M 32 D100 C0 10 GW 04		50-75-100	100-96-92%	key	
M 32 D100 C0 10 GX 04		200	100%	key	

H 1023 mm



porta doppia

ART.					
M 32 D100 C0 10 HC 04		50-75-100	100-96-92%	key	
M 32 D100 C0 10 HD 04		200	100%	key	

H 1023 mm



porta doppia

ART.					
M 32 D100 C0 10 JA 04		50-75-100	100-96-92%	key	
M 32 D100 C0 10 JB 04		200	100%	key	

H 1500 mm



porta doppia

ART.					
M 32 D150 C0 10 JC 04		50-75-100	100-96-92%	key	
M 32 D150 C0 10 JD 04		200	100%	key	

H 1500 mm



porta doppia

ART.					
M 32 D150 C0 10 JE 04		50-75-100	100-96-92%	key	
M 32 D150 C0 10 JF 04		200	100%	key	

H 2000 mm



porta doppia

ART.					
M 32 D200 C0 10 JJ 04		50-75-100	100-96-92%	key	
M 32 D200 C0 10 JK 04		200	100%	key	

H 2000 mm



porta doppia

ART.					
M 32 D200 C0 10 JL 04		50-75-100	100-96-92%	key	
M 32 D200 C0 10 JM 04		200	100%	key	



ART. M 32 D200 C0 10 NW CQ

H 1068 mm



ART.				
M 32 R085 S0 10 AE 04		50-75-100	100-96-92%	key
M 32 R085 P2 10 AE 04		50-75-100	100-96-92%	code

Portata armadio 180 kg - Altezza armadio senza ruote mm 913

H 1068 mm



ART.				
M 32 R085 S0 10 AG 04		50-75-100	100-96-92%	key
M 32 R085 P2 10 AG 04		50-75-100	100-96-92%	code

Portata armadio 180 kg - Altezza armadio senza ruote mm 913

H 1218 mm



ART.				
M 32 R100 S0 10 AY 04		50-75-100	100-96-92%	key
M 32 R100 P2 10 AY 04		50-75-100	100-96-92%	code

Portata armadio 180 kg - Altezza armadio senza ruote mm 1063

H 1218 mm



ART.				
M 32 R100 S0 10 AW 04		50-75-100	100-96-92%	key
M 32 R100 P2 10 AW 04		50-75-100	100-96-92%	code

Portata armadio 180 kg - Altezza armadio senza ruote mm 1063



2 ruote girevoli con freno in gomma standard Ø 125 mm
2 ruote fisse in gomma standard Ø 125 mm



ART. M 32 R080 P2 12 NR FD

CONFIGURA IL TUO ARMADIO

SCEGLI
l'altezza

SCEGLI
la chiusura

SCEGLI
il colore

M32	A040	C5	10 00	01
-----	------	----	-------	----

ARMADIO VUOTO



Portata corpo
armadio 3100 kg

M32	ALTEZZA		CHIUSURA		10 00	COLORE	
	Model	Height (mm) / Useful (mm)	Icon	Description		Color Code	RAL Code
	A040	400 mm (utile 300 mm)	X0	senza asta e senza serratura		01	RAL 7000
	A060	600 mm (utile 500 mm)	C5*	senza serratura		02	RAL 6011
	A070	700 mm (utile 600 mm)	C0*	KEY chiusura a cilindro		1G	RAL 3003
	A080	800 mm (utile 700 mm)	C1*	KEY chiusura a cilindro		1F	RAL 9002
	A085	850 mm (utile 750 mm)	C2*	KEY chiusura a cilindro		48	RAL 5019
	A100	1000 mm (utile 900 mm)	E2*	CODE codice numerico		39	RAL 7016
	A150	1500 mm (utile 1400 mm)	T2*	CODE codice numerico		04	RAL 5012
	A200	2000 mm (utile 1900 mm)				08	RAL 7035
						35	RAL 9010
						34	RAL 5010

*COMPLETA DI ASTA VERTEBRATA

ARMADIO VUOTO

predisposto
per ruote



M32	ALTEZZA		CHIUSURA		10 00	COLORE	
	Model	Height (mm) / Useful (mm)	Icon	Description		Color Code	RAL Code
	R060	663 mm (utile 500 mm)	S0	KEY chiusura a cilindro		01	RAL 7000
	R070	763 mm (utile 600 mm)	S1	KEY chiusura a cilindro		02	RAL 6011
	R080	863 mm (utile 700 mm)	S2	KEY chiusura a cilindro		1G	RAL 3003
	R085	913 mm (utile 750 mm)	P2	CODE codice numerico		1F	RAL 9002
	R100	1063 mm (utile 900 mm)	A1	CODE codice numerico		48	RAL 5019
						39	RAL 7016
						04	RAL 5012
						08	RAL 7035
						35	RAL 9010
						34	RAL 5010

COMPLETO DI ASTA VERTEBRATA, PIANO A 4 BORDI CON COPERTURA IN PVC, COPPIA MANIGLIE, COPPIA PIASTRE
Dim. ingombro mm 788x599



CASSETTI AD ESTRAZIONE FLESSIBILE

ART. CON kit plastiche Dark Grey	ART. SENZA kit plastiche*	Dim. utili mm	H frontale mm	kg	
M 32 C050 01 10 OF __	M 32 C050 01 00 OF __	600x447x31 H	50	50 - 75 - 100	100% - 96% - 92%
M 32 C075 01 10 OF __	M 32 C075 01 00 OF __	600x447x56 H	75	50 - 75 - 100	100% - 96% - 92%
M 32 C100 01 10 OF __	M 32 C100 01 00 OF __	600x447x81 H	100	50 - 75 - 100	100% - 96% - 92%
M 32 C125 01 10 OF __	M 32 C125 01 00 OF __	600x447x106 H	125	50 - 75 - 100	100% - 96% - 92%
M 32 C150 01 10 OF __	M 32 C150 01 00 OF __	600x447x131 H	150	50 - 75 - 100	100% - 96% - 92%
M 32 C200 01 10 OF __	M 32 C200 01 00 OF __	600x447x181 H	200	50 - 75 - 100	100% - 96% - 92%
M 32 C250 01 10 OF __	M 32 C250 01 00 OF __	600x447x231 H	250	50 - 75 - 100	100% - 96% - 92%
M 32 C300 01 10 OF __	M 32 C300 01 00 OF __	600x447x281 H	300	50 - 75 - 100	100% - 96% - 92%

* ABBINARE AL CODICE ARTICOLO UNO DEI KIT PLASTICHE DISPONIBILI NELLA TABELLA SOTTOSTANTE



CASSETTI AD ESTRAZIONE TELESCOPICA

ART. CON kit plastiche Dark Grey	ART. SENZA kit plastiche*	Dim. utili mm	H frontale mm	kg	
M 32 C075 01 10 OT __	M 32 C075 01 00 OT __	600x447x56 H	75	200	100%
M 32 C100 01 10 OT __	M 32 C100 01 00 OT __	600x447x81 H	100	200	100%
M 32 C125 01 10 OT __	M 32 C125 01 00 OT __	600x447x106 H	125	200	100%
M 32 C150 01 10 OT __	M 32 C150 01 00 OT __	600x447x131 H	150	200	100%
M 32 C200 01 10 OT __	M 32 C200 01 00 OT __	600x447x181 H	200	200	100%
M 32 C250 01 10 OT __	M 32 C250 01 00 OT __	600x447x231 H	250	200	100%
M 32 C300 01 10 OT __	M 32 C300 01 00 OT __	600x447x281 H	300	200	100%

* ABBINARE AL CODICE ARTICOLO UNO DEI KIT PLASTICHE DISPONIBILI NELLA TABELLA SOTTOSTANTE

KIT PLASTICHE PER CASSETTI E PIANI ESTRAIBILI



GAMMA COLORI PLASTICHE	ART.
MEDITERRANEAN BLUE	M 30 PLS1 00 00 00 M1
SKY BLUE	M 30 PLS1 00 00 00 M2
GLAMOUR RED	M 30 PLS1 00 00 00 M3
RED CARPET	M 30 PLS1 00 00 00 M4
JUICY ORANGE	M 30 PLS1 00 00 00 M5
SUNNY YELLOW	M 30 PLS1 00 00 00 M6
FOREST GREEN	M 30 PLS1 00 00 00 M7



PIANI ESTRAIBILI AD ESTRAZIONE FLESSIBILE

ART. CON kit plastiche Dark Grey	ART. SENZA kit plastiche*	Dim. utili mm	H frontale mm	kg	
M 32 C057 0110 0F __	M 32 C057 0100 0F __	600x447	70	50 - 75 - 100	100% - 96% - 92%

* ABBINARE AL CODICE ARTICOLO UNO DEI KIT PLASTICHE DISPONIBILI NELLA TABELLA SOTTOSTANTE



PIANI ESTRAIBILI AD ESTRAZIONE TELESCOPICA

ART. CON kit plastiche Dark Grey	ART. SENZA kit plastiche*	Dim. utili mm	H frontale mm	kg	
M 32 C057 0110 0T __	M 32 C057 0100 0T __	600x447	70	200	100%

* ABBINARE AL CODICE ARTICOLO UNO DEI KIT PLASTICHE DISPONIBILI NELLA TABELLA SOTTOSTANTE



PIANO REGOLABILE

ART.	Dim. utili mm	H totale mm	kg
M 32 PR25 00 00 01 __	657x478	60	150

INSERIBILE DAVANTI ALL'ASTA VERTEBRATA

KIT PLASTICHE PER CASSETTI E PIANI ESTRAIBILI



GAMMA COLORI PLASTICHE	ART.
MEDITERRANEAN BLUE	M 30 PLS1 00 00 00 M1
SKY BLUE	M 30 PLS1 00 00 00 M2
GLAMOUR RED	M 30 PLS1 00 00 00 M3
RED CARPET	M 30 PLS1 00 00 00 M4
JUICY ORANGE	M 30 PLS1 00 00 00 M5
SUNNY YELLOW	M 30 PLS1 00 00 00 M6
FOREST GREEN	M 30 PLS1 00 00 00 M7



ART. M 32 A150 C0 14 NU 01

🔑 PORTE A BATTENTE CON CILINDRO

PORTE A BATTENTE ALTEZZA TOTALE - REVERSIBILE















H ARMADIO mm	TIPO DI CHIUSURA	ART. CON kit plastiche Dark Grey 	ART. SENZA kit plastiche* 
600	 C0 KEY chiusura a cilindro	M 30 P050 C0 10 00 __	M 30 P050 C0 00 00 __
	 C1 KEY chiusura a cilindro	M 30 P050 C1 10 00 __	M 30 P050 C1 00 00 __
	 C2 KEY chiusura a cilindro	M 30 P050 C2 10 00 __	M 30 P050 C2 00 00 __
700	 C0 KEY chiusura a cilindro	M 30 P060 C0 10 00 __	M 30 P060 C0 00 00 __
	 C1 KEY chiusura a cilindro	M 30 P060 C1 10 00 __	M 30 P060 C1 00 00 __
	 C2 KEY chiusura a cilindro	M 30 P060 C2 10 00 __	M 30 P060 C2 00 00 __

* ABBINARE AL CODICE ARTICOLO UNO DEI KIT PLASTICHE DISPONIBILI NELLA TABELLA A DESTRA

COPPIA PORTE A BATTENTE ALTEZZA TOTALE













850	 C0 KEY chiusura a cilindro	M 30 P075 C0 10 10 __	M 30 P075 C0 00 10 __
	 C1 KEY chiusura a cilindro	M 30 P075 C1 10 10 __	M 30 P075 C1 00 10 __
	 C2 KEY chiusura a cilindro	M 30 P075 C2 10 10 __	M 30 P075 C2 00 10 __
1000	 C0 KEY chiusura a cilindro	M 30 P090 C0 10 10 __	M 30 P090 C0 00 10 __
	 C1 KEY chiusura a cilindro	M 30 P090 C1 10 10 __	M 30 P090 C1 00 10 __
	 C2 KEY chiusura a cilindro	M 30 P090 C2 10 10 __	M 30 P090 C2 00 10 __
1500	 C0 KEY chiusura a cilindro	M 30 P140 C0 10 10 __	M 30 P140 C0 00 10 __
	 C1 KEY chiusura a cilindro	M 30 P140 C1 10 10 __	M 30 P140 C1 00 10 __
	 C2 KEY chiusura a cilindro	M 30 P140 C2 10 10 __	M 30 P140 C2 00 10 __
2000	 C0 KEY chiusura a cilindro	M 30 P190 C0 10 10 __	M 30 P190 C0 00 10 __
	 C1 KEY chiusura a cilindro	M 30 P190 C1 10 10 __	M 30 P190 C1 00 10 __
	 C2 KEY chiusura a cilindro	M 30 P190 C2 10 10 __	M 30 P190 C2 00 10 __

* ABBINARE AL CODICE ARTICOLO UNO DEI KIT PLASTICHE DISPONIBILI NELLA TABELLA A DESTRA

LA PORTA E LA COPPIA PORTE DEVONO ESSERE ASSOCIATE OBBLIGATORIAMENTE AGLI ARMADI CON LA CHIUSURA: **C5** (SENZA SERRATURA) OPPURE **X0** (SENZA ASTA VERTEBRATA E SENZA SERRATURA)

PORTE A BATTENTE ALTEZZA PARZIALE - REVERSIBILE



H INGOMBRO PORTA mm	TIPO DI CHIUSURA	ART. CON kit plastiche Dark Grey 	ART. SENZA kit plastiche* 
425	 C0 KEY chiusura a cilindro	M 30 P042 C0 10 01 __	M 30 P042 C0 00 01 __
	 C1 KEY chiusura a cilindro	M 30 P042 C1 10 01 __	M 30 P042 C1 00 01 __
	 C2 KEY chiusura a cilindro	M 30 P042 C2 10 01 __	M 30 P042 C2 00 01 __
525	 C0 KEY chiusura a cilindro	M 30 P052 C0 10 01 __	M 30 P052 C0 00 01 __
	 C1 KEY chiusura a cilindro	M 30 P052 C1 10 01 __	M 30 P052 C1 00 01 __
	 C2 KEY chiusura a cilindro	M 30 P052 C2 10 01 __	M 30 P052 C2 00 01 __
625	 C0 KEY chiusura a cilindro	M 30 P062 C0 10 01 __	M 30 P062 C0 00 01 __
	 C1 KEY chiusura a cilindro	M 30 P062 C1 10 01 __	M 30 P062 C1 00 01 __
	 C2 KEY chiusura a cilindro	M 30 P062 C2 10 01 __	M 30 P062 C2 00 01 __

* ABBINARE AL CODICE ARTICOLO UNO DEI KIT PLASTICHE DISPONIBILI NELLA TABELLA SOTTOSTANTE

COPPIA PORTE A BATTENTE ALTEZZA PARZIALE





775	 C0 KEY chiusura a cilindro	M 30 P077 C0 10 11 __	M 30 P077 C0 00 11 __
	 C1 KEY chiusura a cilindro	M 30 P077 C1 10 11 __	M 30 P077 C1 00 11 __
	 C2 KEY chiusura a cilindro	M 30 P077 C2 10 11 __	M 30 P077 C2 00 11 __

* ABBINARE AL CODICE ARTICOLO UNO DEI KIT PLASTICHE DISPONIBILI NELLA TABELLA SOTTOSTANTE

KIT PLASTICHE PER PORTA SINGOLA E COPPIA PORTE



GAMMA COLORI PLASTICHE	ART. per porta singola	ART. per coppia porte
 MEDITERRANEAN BLUE	M 00 PLS0 00 00 20 M1	M 00 PLS0 00 00 30 M1
 SKY BLUE	M 00 PLS0 00 00 20 M2	M 00 PLS0 00 00 30 M2
 GLAMOUR RED	M 00 PLS0 00 00 20 M3	M 00 PLS0 00 00 30 M3
 RED CARPET	M 00 PLS0 00 00 20 M4	M 00 PLS0 00 00 30 M4
 JUICY ORANGE	M 00 PLS0 00 00 20 M5	M 00 PLS0 00 00 30 M5
 SUNNY YELLOW	M 00 PLS0 00 00 20 M6	M 00 PLS0 00 00 30 M6
 FOREST GREEN	M 00 PLS0 00 00 20 M7	M 00 PLS0 00 00 30 M7



PORTE A BATTENTE CON CODICE NUMERICO



PORTE A BATTENTE ALTEZZA TOTALE - APERTURA SOLO A DESTRA

H ARMADIO mm	TIPO DI CHIUSURA	ART. CON kit plastiche Dark Grey	ART. SENZA kit plastiche*
600	P5 CODE codice numerico	M 30 P050 P5 10 00 __	M 30 P050 P5 00 00 __
700	P5 CODE codice numerico	M 30 P060 P5 10 00 __	M 30 P060 P5 00 00 __

* ABBINARE AL CODICE ARTICOLO UNO DEI KIT PLASTICHE DISPONIBILI NELLA TABELLA SOTTOSTANTE



LA PORTA DEVE ESSERE ASSOCIATA OBBLIGATORIAMENTE AGLI ARMADI CON LA CHIUSURA:

C5 (SENZA SERRATURA) OPPURE **X0** (SENZA ASTA VERTEBRATA E SENZA SERRATURA)

PORTE A BATTENTE ALTEZZA PARZIALE - REVERSIBILE



H INGOMBRO PORTA mm	TIPO DI CHIUSURA	ART. CON kit plastiche Dark Grey	ART. SENZA kit plastiche*
425	A4 maniglia senza tastierino	M 30 P042 A4 10 01 __	M 30 P042 A4 00 01 __
525	A4 maniglia senza tastierino	M 30 P052 A4 10 01 __	M 30 P052 A4 00 01 __
625	A4 maniglia senza tastierino	M 30 P062 A4 10 01 __	M 30 P062 A4 00 01 __

* ABBINARE AL CODICE ARTICOLO UNO DEI KIT PLASTICHE DISPONIBILI NELLA TABELLA SOTTOSTANTE



LA PORTA DEVE ESSERE ASSOCIATA OBBLIGATORIAMENTE AGLI ARMADI CON LE CHIUSURE:

UTILIZZARE LA SERRATURA **T2** PER L'ARMADIO SENZA RUOTE

UTILIZZARE LA SERRATURA **A1** PER L'ARMADIO CON RUOTE

KIT PLASTICHE PER PORTA SINGOLA E COPPIA PORTE



GAMMA COLORI PLASTICHE	ART. per porta singola	ART. per coppia porte
MEDITERRANEAN BLUE	M 00 PLS0 00 00 21 M1	M 00 PLS0 00 00 31 M1
SKY BLUE	M 00 PLS0 00 00 21 M2	M 00 PLS0 00 00 31 M2
GLAMOUR RED	M 00 PLS0 00 00 21 M3	M 00 PLS0 00 00 31 M3
RED CARPET	M 00 PLS0 00 00 21 M4	M 00 PLS0 00 00 31 M4
JUICY ORANGE	M 00 PLS0 00 00 21 M5	M 00 PLS0 00 00 31 M5
SUNNY YELLOW	M 00 PLS0 00 00 21 M6	M 00 PLS0 00 00 31 M6
FOREST GREEN	M 00 PLS0 00 00 21 M7	M 00 PLS0 00 00 31 M7

COPPIA PORTE A BATTENTE ALTEZZA TOTALE



H ARMADIO mm	TIPO DI CHIUSURA	ART. CON kit plastiche Dark Grey	ART. SENZA kit plastiche*
850	P5 CODE codice numerico	M 30 P075 P5 10 10 _ _	M 30 P075 P5 00 10 _ _
1000	P5 CODE codice numerico	M 30 P090 P5 10 10 _ _	M 30 P090 P5 00 10 _ _
1500	P5 CODE codice numerico	M 30 P140 P5 10 10 _ _	M 30 P140 P5 00 10 _ _
2000	P5 CODE codice numerico	M 30 P190 P5 10 10 _ _	M 30 P190 P5 00 10 _ _

* ABBINARE AL CODICE ARTICOLO UNO DEI KIT PLASTICHE DISPONIBILI NELLA TABELLA A SINISTRA



LA COPPIA PORTE DEVE ESSERE ASSOCIATA OBBLIGATORIAMENTE AGLI ARMADI CON LA CHIUSURA:

C5 (SENZA SERRATURA) OPPURE **X0** (SENZA ASTA VERTEBRATA E SENZA SERRATURA)

COPPIA PORTE A BATTENTE ALTEZZA PARZIALE



H INGOMBRO PORTA mm	TIPO DI CHIUSURA	ART. CON kit plastiche Dark Grey	ART. SENZA kit plastiche*
775	A4 maniglia senza tastierino	M 30 P077 A4 10 11 _ _	M 30 P077 A4 00 11 _ _

* ABBINARE AL CODICE ARTICOLO UNO DEI KIT PLASTICHE DISPONIBILI NELLA TABELLA A SINISTRA



LA COPPIA PORTE DEVE ESSERE ASSOCIATA OBBLIGATORIAMENTE AGLI ARMADI CON LE CHIUSURE:

UTILIZZARE LA SERRATURA **T2** PER L'ARMADIO SENZA RUOTE

UTILIZZARE LA SERRATURA **A1** PER L'ARMADIO CON RUOTE

TELECOMANDO

















ART.	
M 00 VRC0 00 00 00 00	Modulo ricevitore con telecomando
M 00 VRC0 00 00 01 00	Telecomando aggiuntivo

ARMADIO VUOTO



CON 2 PORTE SCORREVOLI







ARMADIO CON DOPPIA PORTA SCORREVOLE SENZA ASTA VERTEBRATA

H ARMADIO mm	TIPO DI CHIUSURA	ART. CON kit plastiche Dark Grey 	ART. SENZA kit plastiche* 
850 (utile 750 mm)	 C0 KEY chiusura a cilindro	M 32 D085 C0 10 0D __	M 32 D085 C0 00 0D __
	 C1 KEY chiusura a cilindro	M 32 D085 C1 10 0D __	M 32 D085 C1 00 0D __
	 C2 KEY chiusura a cilindro	M 32 D085 C2 10 0D __	M 32 D085 C2 00 0D __
1000 (utile 900 mm)	 C0 KEY chiusura a cilindro	M 32 D100 C0 10 0D __	M 32 D100 C0 00 0D __
	 C1 KEY chiusura a cilindro	M 32 D100 C1 10 0D __	M 32 D100 C1 00 0D __
	 C2 KEY chiusura a cilindro	M 32 D100 C2 10 0D __	M 32 D100 C2 00 0D __
1500 (utile 1400 mm)	 C0 KEY chiusura a cilindro	M 32 D150 C0 10 0D __	M 32 D150 C0 00 0D __
	 C1 KEY chiusura a cilindro	M 32 D150 C1 10 0D __	M 32 D150 C1 00 0D __
	 C2 KEY chiusura a cilindro	M 32 D150 C2 10 0D __	M 32 D150 C2 00 0D __
2000 (utile 1900 mm)	 C0 KEY chiusura a cilindro	M 32 D200 C0 10 0D __	M 32 D200 C0 00 0D __
	 C1 KEY chiusura a cilindro	M 32 D200 C1 10 0D __	M 32 D200 C1 00 0D __
	 C2 KEY chiusura a cilindro	M 32 D200 C2 10 0D __	M 32 D200 C2 00 0D __

* ABBINARE AL CODICE ARTICOLO UNO DEI KIT PLASTICHE DISPONIBILI NELLA TABELLA SOTTOSTANTE

KIT PLASTICHE PER PORTE SCORREVOLI



GAMMA COLORI PLASTICHE	ART. 2 PORTE SCORREVOLI	ART. 1 PORTA SCORREVOLE
 MEDITERRANEAN BLUE	M 00 PLS0 00 00 50 M1	M 00 PLS0 00 00 40 M1
 SKY BLUE	M 00 PLS0 00 00 50 M2	M 00 PLS0 00 00 40 M2
 GLAMOUR RED	M 00 PLS0 00 00 50 M3	M 00 PLS0 00 00 40 M3
 RED CARPET	M 00 PLS0 00 00 50 M4	M 00 PLS0 00 00 40 M4
 JUICY ORANGE	M 00 PLS0 00 00 50 M5	M 00 PLS0 00 00 40 M5
 SUNNY YELLOW	M 00 PLS0 00 00 50 M6	M 00 PLS0 00 00 40 M6
 FOREST GREEN	M 00 PLS0 00 00 50 M7	M 00 PLS0 00 00 40 M7

ARMADIO VUOTO

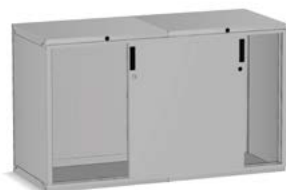

CON 1 PORTA SCORREVOLE

ARMADIO CON PORTA SCORREVOLE SINGOLA SENZA ASTA VERTEBRATA

H ARMADIO mm	TIPO DI CHIUSURA	ART. CON kit plastiche Dark Grey	ART. SENZA kit plastiche*
850 (utile 750 mm)	C0 KEY chiusura a cilindro	M 32 D085 C0 10 OS __	M 32 D085 C0 00 OS __
	C1 KEY chiusura a cilindro	M 32 D085 C1 10 OS __	M 32 D085 C1 00 OS __
	C2 KEY chiusura a cilindro	M 32 D085 C2 10 OS __	M 32 D085 C2 00 OS __
1000 (utile 900 mm)	C0 KEY chiusura a cilindro	M 32 D100 C0 10 OS __	M 32 D100 C0 00 OS __
	C1 KEY chiusura a cilindro	M 32 D100 C1 10 OS __	M 32 D100 C1 00 OS __
	C2 KEY chiusura a cilindro	M 32 D100 C2 10 OS __	M 32 D100 C2 00 OS __

* ABBINARE AL CODICE ARTICOLO UNO DEI KIT PLASTICHE DISPONIBILI NELLA TABELLA A SINISTRA



PORTA SINGOLA con chiusura SOLO a dx. Solo il vano di sinistra è predisposto per l'inserimento di cassette e piani estraibili. OBBLIGO di inserimento dell'asta vertebrata in presenza di PIÙ DI 2 CASSETTI/PIANI ESTRAIBILI per vano.



CHIUSURA A CILINDRO

TIPO DI CHIUSURA	ART.
C0 KEY chiusura a cilindro	M 32 V000 C0 00 00 00
C1 KEY chiusura a cilindro	M 32 V000 C1 00 00 00
C2 KEY chiusura a cilindro	M 32 V000 C2 00 00 00

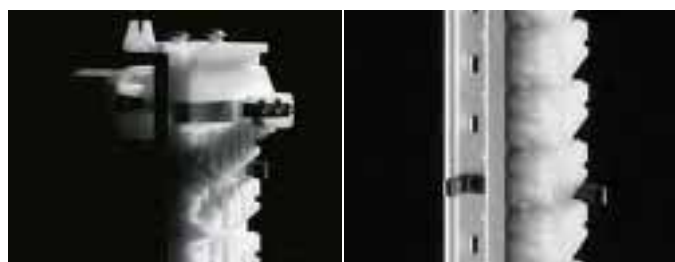

ASTA VERTEBRATA

H UTILE INSERIMENTO CASSETTI mm	ART.
750	M 00 V075 00 00 00 00
900	M 00 V090 00 00 00 00
1400	M 00 V140 00 00 00 00
1900	M 00 V190 00 00 00 00

PIANO SUPERIORE A 3 BORDI

ART.	dim. mm	
M 32 T023 AG 00 31 07	714x573x23 H	

Piano rivestito in pvc per ARMADIO SINGOLO. Colore nero

PIANO SUPERIORE A 3 BORDI

ART.	dim. mm	
M 32 T023 AG 00 32 07	1428x573x23 H	

Piano rivestito in pvc per ARMADIO DOPPIO. Colore nero

PIANO SUPERIORE A 4 BORDI

ART.	dim. mm	
M 32 T023 AG 00 41 07	714x573x23 H	

Piano rivestito in pvc per ARMADIO SINGOLO. Colore nero



ART. M 00 T023 AG 00 FO 00

FORATURA PIANO SUPERIORE DELL'ARMADIO PER IL FISSAGGIO DEL PIANO A 4 BORDI

PIANO SUPERIORE IN MULTIPLEX

ART.	dim. mm	
M 32 T040 MU 00 01 00	714x573x40 H	

Per ARMADIO SINGOLO

PIANO SUPERIORE IN MDF DIM. 714x573x32 mm H

ART.	rifiniture	per armadio	
M 32 T030 MD GM 21 07	1 profilo laterale	finale dx o sx	

Piano in MDF con copertura in gomma antiolio. Colore nero

PIANO SUPERIORE IN MDF DIM. 714x573x32 mm H

ART.	rifiniture	per armadio	
M 32 T030 MD GM 11 07	-	centrale	

Piano in MDF con copertura in gomma antiolio. Colore nero

PIANO SUPERIORE IN MDF DIM. 714x573x32 mm H

ART.	rifiniture	per armadio	
M 32 T030 MD GM 01 07	2 profili laterali	singolo	

Piano in MDF con copertura in gomma antiolio. Colore nero



ART. M 00 T030 MD 00 FO 00

FORATURA PIANO SUPERIORE DELL'ARMADIO PER IL FISSAGGIO DEL PIANO IN MDF E DEL PIANO IN MULTIPLEX COMPRESIVO DI VITI PER IL FISSAGGIO

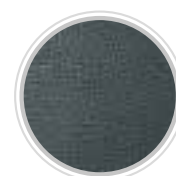

RIFINITURA
GOMMA
ANTIOILIO



APPLICAZIONE
PIANO IN MDF



**PIANO SUPERIORE IN MULTIPLEX PER
ARMADIO CON RUOTE**
DISPONIBILE SU RICHIESTA





PANNELLO FORATO

ART.		dim. mm	
M 30 PA71 00 00 00 04		708x65x718 H	

ESEMPI DI PANNELLO FORATO CON GANCI O VISUAL BOX



2 ART. FAXVBCH00600001
1 ART. F BL 9541 00 00 (10 pz.)
1 ART. C MV 10 019



2 ART. FAXVBCH00900001
2 ART. FAXVBCH00600001
2 ART. FAXVBCH00500001



2 ART. FAXVBCH00600001
3 ART. FAXVBCH00500001



3 ART. FAXVBCH00600001
1 ART. FAXVBCH00500001
1 ART. FAXVBCH00400001



ART. M 00 PA71 00 00 FO 00
FORATURA PIANO SUPERIORE IN MDF O
MULTIPLEX PER IL FISSAGGIO DEL PANNELLO
FORATO - COMPRESIVO DI VITI



ART. M 00 PA71 00 00 F1 00
FORATURA PIANO SUPERIORE A 3/4
BORDI PER IL FISSAGGIO DEL PANNELLO
FORATO - COMPRESIVO DI VITI



ART. M 00 PA71 00 00 F2 00
SET DI PREDISPOSIZIONE PER IL
FISSAGGIO DEI VISUAL BOX AL
PANNELLO FORATO

ZOCCOLO DI RIALZO ALTEZZA 50 mm



ART.		dim. mm	
M 32 Z050 00 00 00		712x572x50 H	

ZOCCOLO DI RIALZO ALTEZZA 100 mm



ART.		dim. mm	
M 32 Z100 00 00 00		712x572x100 H	

ZOCCOLI PER CARRELLO ELEVATORE - Colore nero RAL 9005



ART.		dim. mm	
M 02 Z060 20 00 00 07	coppia zoccoli	200x569x60 H	
M 30 Z060 21 00 00 07	chiusura per coppia zoccoli	708x46x55 H	

ZOCCOLI PER TRANSPALLET - Colore nero RAL 9005



ART.		dim. mm	
M 32 Z100 10 00 00 07	zoccolo	712x569x100 H	
M 30 Z100 11 00 00 07	chiusura per zoccolo	708x46x95 H	

RUOTA FISSA IN GOMMA STANDARD

ART.	Ø mm	portata armadio kg	C mm
C RG BAC11 100	100	105	128
C RG BAC12 125	125	180	155



RUOTA GIREVOLE CON FRENO IN GOMMA STANDARD

ART.	Ø mm	portata armadio kg	C mm
C RG DAC11 100	100	105	128
C RG DAC12 125	125	180	155



RUOTA FISSA IN NYLON

ART.	Ø mm	portata armadio kg	C mm
C RN BAD10 100	100	255	128
C RN BAD11 125	125	420	155



RUOTA GIREVOLE CON FRENO IN NYLON

ART.	Ø mm	portata armadio kg	C mm
C RN DAD10 100	100	255	128
C RN DAD11 125	125	420	155



RICAMBI - FISSAGGIO

SERRATURA DI RICAMBIO

ART. M 00 CSRO 8800 00 00
Serratura di ricambio con due chiavi



CHIAVE DI RICAMBIO

ART. M 00 CF00 0000 00 00

Specificare sempre il numero indicato nella serratura a cilindro dove si vuole sostituire la chiave



PASSEPARTOUT

ART. M 00 PF.. 0000 00 00

Disponibile in 23 serie, con numerazione da F 01 a F 23.

Passepartout serie F 01
Passepartout serie F 02
Passepartout serie F ..

ART. M 00 PF01 00 00 00 00
ART. M 00 PF02 00 00 00 00
ART. M 00 PF.. 00 00 00 00

SET FISSAGGIO TRA ARMADI

ART. M 00 FISO 00 00 00 99

Set di fissaggio armadio-armadio con 4 viti complete di dadi M8

ART. M 00 SVRO 00 00 00 99

Foratura e viteria per il fissaggio dei due armadi sovrapposti

SET DI FISSAGGIO A PAVIMENTO



ART. F AG 9200 00 99

Coppia staffe zincate per il fissaggio a pavimento dell'armadio

ART. F AG 9204 00 99

2 tasselli "HILTI" adatti per pavimenti in calcestruzzo non fessurato maggiore o uguale alla classe C20/25
Trazione consigliata del tassello: 2,9 kN
Diametro tassello: Ø 6 mm



MANIGLIA DI RICAMBIO

ART. M 00 PLSO 0000 22 MO

Maniglia di ricambio per porte disponibile in colore Dark Grey.



ALTRI COLORI A RICHIESTA



GLI ARMADI DEVONO ESSERE FISSATI A PAVIMENTO O A PARETE
SE SOVRAPPosti DEVONO ESSERE FISSATI OBBLIGATORIAMENTE A PARETE E LA LORO PORTATA DIVISA PER DUE



MASTER

714x573 mm

Born To Be Extreme

ARMADIO VUOTO senza asta vertebrata e senza chiusura



H 400 mm
H utile 300 mm



H 600 mm
H utile 500 mm



H 700 mm
H utile 600 mm



H 800 mm
H utile 700 mm



H 850 mm
H utile 750 mm



M 32 A040 X0 10 00 _ _

M 32 A060 X0 10 00 _ _

M 32 A070 X0 10 00 _ _

M 32 A080 X0 10 00 _ _

M 32 A085 X0 10 00 _ _

ASTA VERTEBRATA



L'asta vertebrata è composta da un profilo in alluminio estruso forato a passo 25 mm per l'inserimento della molla antiribaltamento. L'asta antiribaltamento viene fornita completa di accessori in plastica e struttura superiore predisposta per la chiusura a cilindro o elettronica.

ART.	H utile inserimento cassette mm
M 00 V030 00 00 00 00	300
M 00 V050 00 00 00 00	500
M 00 V060 00 00 00 00	600
M 00 V070 00 00 00 00	700
M 00 V075 00 00 00 00	750
M 00 V090 00 00 00 00	900

ART.	H utile inserimento cassette mm
M 00 V105 00 00 00 00	1050
M 00 V122 00 00 00 00	1225
M 00 V140 00 00 00 00	1400
M 00 V152 00 00 00 00	1525
M 00 V190 00 00 00 00	1900

CHIUSURA CON CILINDRO (KEY)



CHIUSURA A CILINDRO COMPLETA DI:

- 1 serratura a cilindro con 2 chiavi
- 1 filo in acciaio con guaina
- 1 gruppo percussore anteriore
- 1 gruppo cursore posteriore

ART.

M 32 V000 C0 00 00 00

C0

CHIUSURA A CILINDRO CON NUMERAZIONE DIVERSA

M 32 V000 C1 00 00 00

C1

CHIUSURA A CILINDRO PER GRUPPI DI 160 NUMERI

M 32 V000 C2 00 00 00

C2

CHIUSURA A CILINDRO CON NUMERAZIONE UGUALE

For Experts Only



H 1000 mm H utile 900 mm		H 1500 mm H utile 1400 mm		H 2000 mm H utile 1900 mm	
M 32 A100 X0 10 00 __		M 32 A150 X0 10 00 __		M 32 A200 X0 10 00 __	

CHIUSURA CON CODICE NUMERICO (CODE)



ART.	
M 32 V000 E2 00 00 00	E2 APERTURA/CHIUSURA ASTA (alimentazione a batteria)
M 32 V000 E5 00 00 00	E5 APERTURA/CHIUSURA ASTA (alimentazione da rete elettrica)
ART.	
M 32 V000 T2 00 00 00	T2 APERTURA/CHIUSURA ASTA + PORTA (alimentazione a batteria)
M 32 V000 T3 00 00 00	T3 APERTURA/CHIUSURA ASTA + PORTA (alimentazione da rete elettrica)

ART. TELECOMANDO	
M 00 VRC0 00 00 00 00	Modulo ricevitore con telecomando
M 00 VRC0 00 00 01 00	Telecomando aggiuntivo



PIANI PER SERRATURE E PIANI REGOLABILI

PIANO SUPERIORE PER SERRATURE



ART.		H frontale mm	kg
M 32 PS46 00 10 00 __		46	150

Dim. mm 663x571x46 h

PIANO INFERIORE PER SERRATURE



ART.		H frontale mm	kg
M 32 PS46 10 10 00 __		46	150

Dim. mm 663x571x46 h

PIANO REGOLABILE



ART.		H totale mm	kg
M 32 PR25 00 00 01 __		60	150

Dim. utili mm 657x478x60 h

PIANO REGOLABILE FESSURATO



ART.		H frontale mm	kg
M 32 PR35 10 00 01 __		35	300

Dim. mm 663x568x35 h

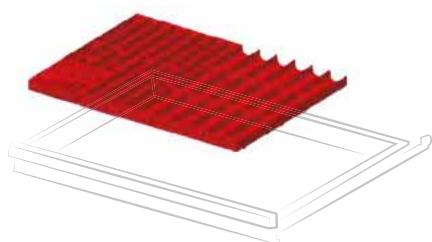

ART. per altezza frontale mm

F FH 1005 15 00 50 - 300

Set composto da: 5 divisori 4 canali, 6 divisori 3 canali, 20 divisori trasversali 36 mm, 20 divisori trasversali 47 mm, porta chiavi a brugola 150x150 mm

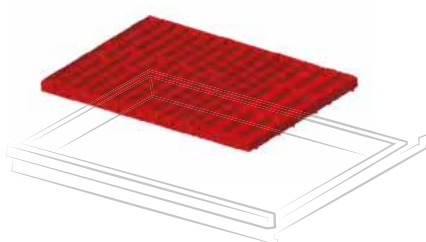

ART. per altezza frontale mm

F FH 1005 10 00 50 - 300

Set composto da: 9 divisori 4 canali, 3 divisori 3 canali, 36 divisori trasversali 36 mm, 12 divisori trasversali 47 mm

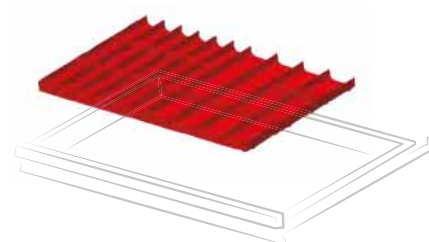

ART. per altezza frontale mm

F FH 1005 13 00 50 - 300

Set composto da: 6 divisori 3 canali, 6 divisori 2 canali, 18 divisori trasversali 47 mm, 12 divisori trasversali 73 mm

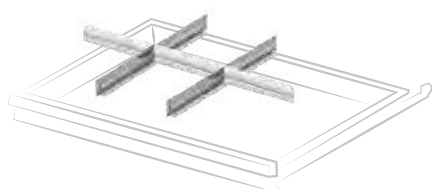

ART. per altezza frontale mm

F FH 1005 05 00 50

F FH 1007 05 00 75

F FH 1010 05 00 100 - 125

F FH 1015 05 00 150

F FH 1020 05 00 200 - 250

F FH 1030 05 00 300

Set composto da: 2 divisori longitudinali fessurati 455 mm, 3 divisori trasversali 200 mm

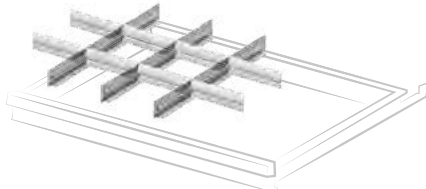

ART. per altezza frontale mm

F FH 1005 03 00 50

F FH 1007 03 00 75

F FH 1010 03 00 100 - 125

F FH 1015 03 00 150

F FH 1020 03 00 200 - 250

Set composto da: 3 divisori longitudinali fessurati 455 mm, 8 divisori trasversali 149 mm

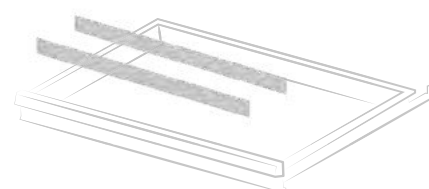

ART. per altezza frontale mm

F FH 1005 01 00 50

F FH 1007 01 00 75

F FH 1010 01 00 100 - 125

F FH 1015 01 00 150

F FH 1020 01 00 200 - 250

F FH 1030 01 00 300

Set composto da: 2 divisori longitudinali non fessurati 610 mm

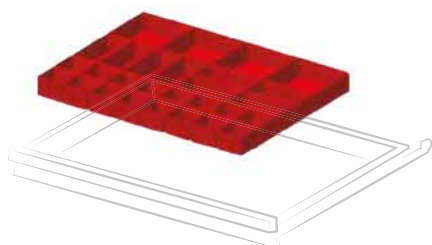

ART. per altezza frontale mm

F FH 1005 18 00 50

F FH 1007 18 00 75

Set composto da: 16 cassette divisorio 75x75 mm, 8 cassette divisorio 150x75 mm, 4 cassette divisorio 150x150 mm

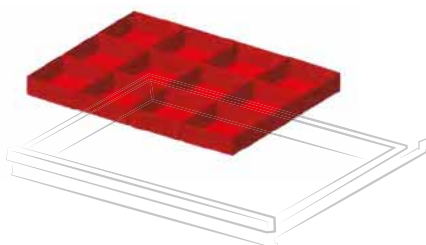

ART. per altezza frontale mm

F FH 1005 09 00 50

F FH 1007 09 00 75

F FH 1010 09 00 100 - 125

Set composto da: 12 cassette divisorio 150x150 mm

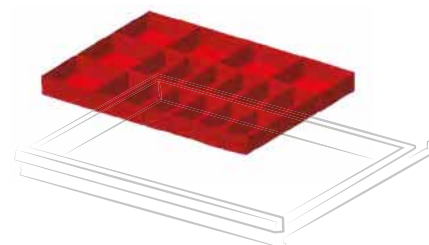

ART. per altezza frontale mm

F FH 1005 16 00 50

F FH 1007 16 00 75

F FH 1010 16 00 100 - 125

Set composto da: 12 cassette divisorio 150x75 mm, 6 cassette divisorio 150x150 mm

CONFIGURA IL CASSETTO FAMI CON UTENSILI BETA

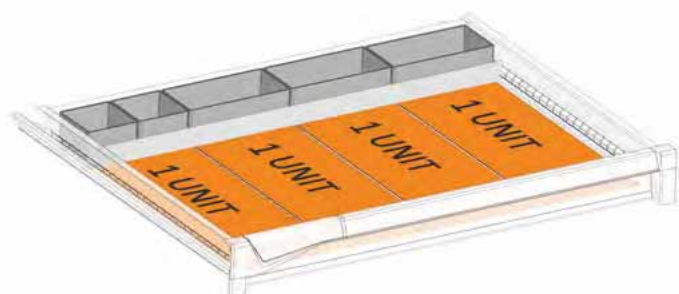

ART. F FH 1007 50 07

Set di predisposizione cassetto per termoformati Beta composto da:

n. 2 F HC 6071 00 07

n. 3 F HC 6471 00 07

n. 1 F HA 1141 00 99

1 unit = 1 termoformato Beta 367x147 mm

2 unit = 1 termoformato Beta 367x294 mm



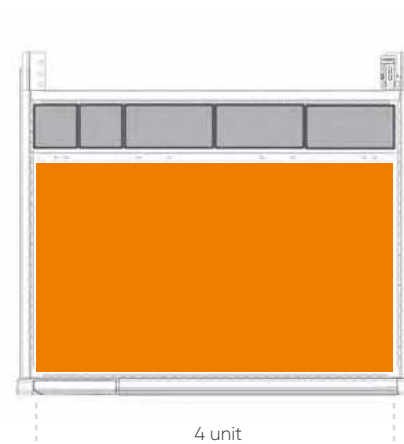
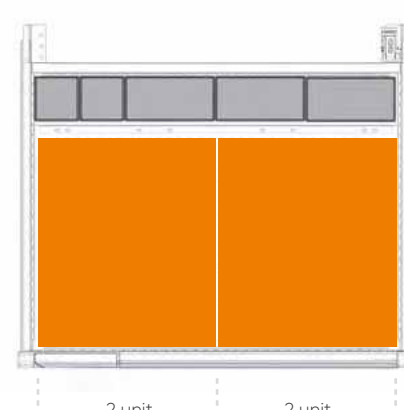
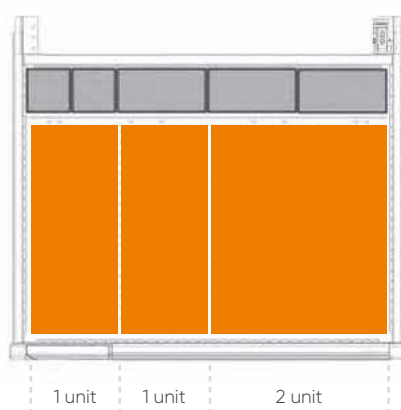
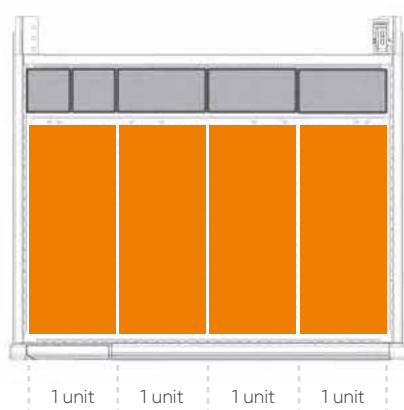

4 unit = 1 termoformato Beta 367x588 mm

ESEMPI DI UTILIZZO TERMOFORMATO











Gamma colori ACCIAIO

	
GRIGIO RAL 7000 .01	VERDE RAL 6011 .02
	
BLU RAL 5012 .04	GRIGIO RAL 7035 .08
	
BIANCO GRIGIASTRO RAL 9002 .1F	ROSSO RUBINO RAL 3003 .1G
	
BLU GENZIANA RAL 5010 .34	BIANCO PURO RAL 9010 .35
	
GRIGIO ANTRACITE RAL 7016 .39	BLU CAPRI RAL 5019 .48



● ART. M 52 A100 CO 10 BE 04
H = 1000 mm - 6 cassetti

Gamma colori PLASTICHE

			
DARK GREY .M0	MEDITERRANEAN BLUE .M1	SKY BLUE .M2	GLAMOUR RED .M3
			
RED CARPET .M4	JUICE ORANGE .M5	SUNNY YELLOW .M6	FOREST GREEN .M7

LEGENDA



PORTATA
CASSETTO/
PIANO



ESTRAZIONE
CASSETTO/
PIANO



CHIUSURA
ARMADIO



LE PORTATE SONO NETTE E SI RIFERISCONO A PESI UNIFORMEMENTE DISTRIBUITI.

H 400 mm



ART.					
M 52 A040 C0 10 04 04		50-75-100	100-96-92%	key	
M 52 A040 E2 10 04 04		50-75-100	100-96-92%	code	

H 400 mm



ART.					
M 52 A040 C0 10 02 04		50-75-100	100-96-92%	key	
M 52 A040 E2 10 02 04		50-75-100	100-96-92%	code	

H 700 mm



ART.					
M 52 A070 C0 10 49 04		50-75-100	100-96-92%	key	
M 52 A070 C0 10 50 04		200	100%	key	
M 52 A070 E2 10 49 04		50-75-100	100-96-92%	code	
M 52 A070 E2 10 50 04		200	100%	code	

H 700 mm



ART.					
M 52 A070 C0 10 31 04		50-75-100	100-96-92%	key	
M 52 A070 C0 10 51 04		200	100%	key	
M 52 A070 E2 10 31 04		50-75-100	100-96-92%	code	
M 52 A070 E2 10 51 04		200	100%	code	

H 800 mm



ART.					
M 52 A080 C0 10 55 04		50-75-100	100-96-92%	key	
M 52 A080 E2 10 55 04		50-75-100	100-96-92%	code	

H 800 mm



ART.					
M 52 A080 C0 10 54 04		50-75-100	100-96-92%	key	
M 52 A080 E2 10 54 04		50-75-100	100-96-92%	code	

H 850 mm



ART.					
M 52 A085 C0 10 88 04		50-75-100	100-96-92%	key	
M 52 A085 E2 10 88 04		50-75-100	100-96-92%	code	

H 850 mm



ART.					
M 52 A085 C0 10 AM 04		50-75-100	100-96-92%	key	
M 52 A085 C0 10 AN 04		200	100%	key	
M 52 A085 E2 10 AM 04		50-75-100	100-96-92%	code	
M 52 A085 E2 10 AN 04		200	100%	code	

H 1000 mm



ART.					
● M 52 A100 C0 10 BE 04		50-75-100	100-96-92%	key	
M 52 A100 C0 10 BF 04		200	100%	key	
M 52 A100 E2 10 BE 04		50-75-100	100-96-92%	code	
M 52 A100 E2 10 BF 04		200	100%	code	

H 1000 mm



ART.					
M 52 A100 C0 10 AW 04		50-75-100	100-96-92%	key	
M 52 A100 C0 10 BH 04		200	100%	key	
M 52 A100 E2 10 AW 04		50-75-100	100-96-92%	code	
M 52 A100 E2 10 BH 04		200	100%	code	

H 1000 mm



H 1000 mm



ART.				
M 52 A100 C0 10 CN 04		50-75-100	100-96-92%	key
M 52 A100 C0 10 CP 04		200	100%	key
M 52 A100 E2 10 CN 04		50-75-100	100-96-92%	code
M 52 A100 E2 10 CP 04		200	100%	code

ART.				
M 52 A100 C5 10 CW 04		50-75-100	100-96-92%	-
M 52 A100 C5 10 CX 04		200	100%	-

H 1023 mm



H 1023 mm



porta 900 mm profondità 598 mm

ART.				
M 52 A100 C0 10 BU 04		50-75-100	100-96-92%	key
M 52 A100 C0 10 BV 04		200	100%	key
M 52 A100 P5 10 BU 04		50-75-100	100-96-92%	code
M 52 A100 P5 10 BV 04		200	100%	code

porta 900 mm profondità 598 mm

ART.				
M 52 A100 C0 10 CA 04		50-75-100	100-96-92%	key
M 52 A100 C0 10 CB 04		200	100%	key
M 52 A100 P5 10 CA 04		50-75-100	100-96-92%	code
M 52 A100 P5 10 CB 04		200	100%	code

H 1500 mm



ART.					
M 52 A150 C0 10 FL 04		50-75-100	100-96-92%	key	
M 52 A150 C0 10 FM 04		200	100%	key	
M 52 A150 E2 10 FL 04		50-75-100	100-96-92%	code	
M 52 A150 E2 10 FM 04		200	100%	code	

H 1500 mm



ART.					
M 52 A150 C0 10 FQ 04		50-75-100	100-96-92%	key	
M 52 A150 C0 10 FR 04		200	100%	key	
M 52 A150 E2 10 FQ 04		50-75-100	100-96-92%	code	
M 52 A150 E2 10 FR 04		200	100%	code	

H 1500 mm



porta 1400 mm profondità 598 mm

ART.					
M 52 A150 C0 10 LA 04		50-75-100	100-96-92%	key	
M 52 A150 C0 10 LB 04		200	100%	key	
M 52 A150 P5 10 LA 04		50-75-100	100-96-92%	code	
M 52 A150 P5 10 LB 04		200	100%	code	

H 1500 mm



porta 1400 mm profondità 598 mm

ART.					
M 52 A150 C0 10 LC 04		50-75-100	100-96-92%	key	
M 52 A150 C0 10 LD 04		200	100%	key	
M 52 A150 P5 10 LC 04		50-75-100	100-96-92%	code	
M 52 A150 P5 10 LD 04		200	100%	code	

H 2000 mm



H 2000 mm



porta 900 mm

profondità 598 mm

ART.				
M 52 A200 C0 10 FS 04		50-75-100	100-96-92%	key
M 52 A200 C0 10 FT 04		200	100%	key
M 52 A200 E2 10 FS 04		50-75-100	100-96-92%	code
M 52 A200 E2 10 FT 04		200	100%	code

ART.				
M 52 A200 C0 10 FY 04		50-75-100	100-96-92%	key
M 52 A200 C0 10 FZ 04		200	100%	key
M 52 A200 T2 10 FY 04		50-75-100	100-96-92%	code
M 52 A200 T2 10 FZ 04		200	100%	code



H 2000 mm

porta 1900 mm

profondità 598 mm

ART.				
M 52 A200 C0 10 FW 04		50-75-100	100-96-92%	key
M 52 A200 C0 10 FX 04		200	100%	key
M 52 A200 P5 10 FW 04		50-75-100	100-96-92%	code
M 52 A200 P5 10 FX 04		200	100%	code

MASTER

2040x598 mm

H 873 mm



ART.				porta singola
M 52 D085 C0 10 GJ 04	50-75-100	100-96-92%	key	
M 52 D085 C0 10 GK 04	200	100%	key	

H 1023 mm



ART.				porta singola
M 52 D100 C0 10 GQ 04	50-75-100	100-96-92%	key	
M 52 D100 C0 10 GR 04	200	100%	key	



H 873 mm



ART.					porta doppia
M52D085C010GL04		50-75-100	100-96-92%	key	
M52D085C010GM04		200	100%	key	

H 1023 mm



ART.					porta doppia
M52D100C010GW04		50-75-100	100-96-92%	key	
M52D100C010GX04		200	100%	key	



H 1500 mm



porta doppia

ART.				
M 52 D150 C0 10 JE 04	50-75-100	100-96-92%	key	
M 52 D150 C0 10 JF 04	200	100%	key	

H 2000 mm



porta doppia

ART.				
M 52 D200 C0 10 JJ 04	50-75-100	100-96-92%	key	
M 52 D200 C0 10 JK 04	200	100%	key	



ART. M 52 D200 C0 10 PD FP

H 918 mm



ART.				
M 52 R070 SO 10 31 04		50-75-100	100-96-92%	key
M 52 R070 P2 10 31 04		50-75-100	100-96-92%	code

Portata armadio 370 kg - Altezza armadio senza ruote mm 763

H 918 mm



ART.				
M 52 R070 SO 10 44 04		50-75-100	100-96-92%	key
M 52 R070 P2 10 44 04		50-75-100	100-96-92%	code

Portata armadio 370 kg - Altezza armadio senza ruote mm 763

H 1068 mm



ART.				
M 52 R085 SO 10 AK 04		50-75-100	100-96-92%	key
M 52 R085 P2 10 AK 04		50-75-100	100-96-92%	code

Portata armadio 370 kg - Altezza armadio senza ruote mm 913

H 1068 mm



ART.				
M 52 R085 SO 10 AM 04		50-75-100	100-96-92%	key
M 52 R085 P2 10 AM 04		50-75-100	100-96-92%	code

Portata armadio 370 kg - Altezza armadio senza ruote mm 913



2 ruote girevoli con freno in gomma elastica Ø 125 mm
2 ruote fisse in gomma elastica Ø 125 mm

H 1218 mm



H 1218 mm



ART.		kg		
M 52 R100 S0 10 CQ 04		50-75-100	100-96-92%	key
M 52 R100 P2 10 CQ 04		50-75-100	100-96-92%	code

Portata armadio 370 kg - Altezza armadio senza ruote mm 1063

ART.		kg		
M 52 R100 S0 10 AW 04		50-75-100	100-96-92%	key
M 52 R100 P2 10 AW 04		50-75-100	100-96-92%	code

Portata armadio 370 kg - Altezza armadio senza ruote mm 1063



CONFIGURA IL TUO ARMADIO

SCEGLI
l'altezza

SCEGLI
la chiusura

SCEGLI
il colore

M52	A040	C5	10 00	01
-----	------	----	-------	----

ARMADIO VUOTO



Portata corpo
armadio 3100 kg

M52	ALTEZZA		CHIUSURA		10 00	COLORE	
	Model	Height (mm)	Icon	Description		Code	Color
	A040	400 mm (utile 300 mm)	X0	senza asta e senza serratura	10 00	01	RAL 7000
	A070	700 mm (utile 600 mm)	C5*	senza serratura		02	RAL 6011
	A080	800 mm (utile 700 mm)	C0*	KEY chiusura a cilindro		1G	RAL 3003
	A085	850 mm (utile 850 mm)	C1*	KEY chiusura a cilindro		1F	RAL 9002
	A100	1000 mm (utile 900 mm)	C2*	KEY chiusura a cilindro		48	RAL 5019
	A150	1500 mm (utile 1400 mm)	E2*	CODE codice numerico		39	RAL 7016
	A200	2000 mm (utile 1900 mm)	T2*	CODE codice numerico		04	RAL 5012
						08	RAL 7035
					35	RAL 9010	
					34	RAL 5010	

*COMPLETA DI ASTA VERTEBRATA

ARMADIO VUOTO predisposto per ruote



M52	ALTEZZA		CHIUSURA		10 00	COLORE	
	Model	Height (mm)	Icon	Description		Code	Color
	R070	763 mm (utile 600 mm)	S0	KEY chiusura a cilindro	10 00	01	RAL 7000
	R085	913 mm (utile 750 mm)	S1	KEY chiusura a cilindro		02	RAL 6011
	R100	1063 mm (utile 900 mm)	S2	KEY chiusura a cilindro		1G	RAL 3003
			P2	CODE codice numerico		1F	RAL 9002
			A1	CODE codice numerico		48	RAL 5019
						39	RAL 7016
						04	RAL 5012
						08	RAL 7035
					35	RAL 9010	
					34	RAL 5010	

COMPLETO DI ASTA VERTEBRATA, PIANO A 4 BORDI CON COPERTURA IN PVC, COPPIA MANIGLIE, COPPIA PIASTRE
Dim. ingombro mm 1094x599



CASSETTI AD ESTRAZIONE FLESSIBILE

ART. CON kit plastiche Dark Grey	ART. SENZA kit plastiche*	Dim. utili mm	H frontale mm	kg	
M 52 C050 0110 OF __	M 52 C050 01 00 OF __	906x447x31 H	50	50 - 75 - 100	100% - 96% - 92%
M 52 C075 0110 OF __	M 52 C075 01 00 OF __	906x447x56 H	75	50 - 75 - 100	100% - 96% - 92%
M 52 C100 0110 OF __	M 52 C100 01 00 OF __	906x447x81 H	100	50 - 75 - 100	100% - 96% - 92%
M 52 C125 0110 OF __	M 52 C125 01 00 OF __	906x447x106 H	125	50 - 75 - 100	100% - 96% - 92%
M 52 C150 0110 OF __	M 52 C150 01 00 OF __	906x447x131 H	150	50 - 75 - 100	100% - 96% - 92%
M 52 C200 0110 OF __	M 52 C200 01 00 OF __	906x447x181 H	200	50 - 75 - 100	100% - 96% - 92%
M 52 C250 0110 OF __	M 52 C250 01 00 OF __	906x447x231 H	250	50 - 75 - 100	100% - 96% - 92%
M 52 C300 0110 OF __	M 52 C300 01 00 OF __	906x447x281 H	300	50 - 75 - 100	100% - 96% - 92%

* ABBINARE AL CODICE ARTICOLO UNO DEI KIT PLASTICHE DISPONIBILI NELLA TABELLA SOTTOSTANTE



CASSETTI AD ESTRAZIONE TELESCOPICA

ART. CON kit plastiche Dark Grey	ART. SENZA kit plastiche*	Dim. utili mm	H frontale mm	kg	
M 52 C075 0110 OT __	M 52 C075 01 00 OT __	906x447x56 H	75	200	100%
M 52 C100 0110 OT __	M 52 C100 01 00 OT __	906x447x81 H	100	200	100%
M 52 C125 0110 OT __	M 52 C125 01 00 OT __	906x447x106 H	125	200	100%
M 52 C150 0110 OT __	M 52 C150 01 00 OT __	906x447x131 H	150	200	100%
M 52 C200 0110 OT __	M 52 C200 01 00 OT __	906x447x181 H	200	200	100%
M 52 C250 0110 OT __	M 52 C250 01 00 OT __	906x447x231 H	250	200	100%
M 52 C300 0110 OT __	M 52 C300 01 00 OT __	906x447x281 H	300	200	100%

* ABBINARE AL CODICE ARTICOLO UNO DEI KIT PLASTICHE DISPONIBILI NELLA TABELLA SOTTOSTANTE

KIT PLASTICHE PER CASSETTI E PIANI ESTRAIBILI



GAMMA COLORI PLASTICHE	ART.
MEDITERRANEAN BLUE	M 50 PLS1 00 00 00 M1
SKY BLUE	M 50 PLS1 00 00 00 M2
GLAMOUR RED	M 50 PLS1 00 00 00 M3
RED CARPET	M 50 PLS1 00 00 00 M4
JUICY ORANGE	M 50 PLS1 00 00 00 M5
SUNNY YELLOW	M 50 PLS1 00 00 00 M6
FOREST GREEN	M 50 PLS1 00 00 00 M7



PIANI ESTRAIBILI AD ESTRAZIONE FLESSIBILE

ART. CON kit plastiche Dark Grey	ART. SENZA kit plastiche*	Dim. utili mm	H frontale mm	kg	
M 52 C057 0110 0F __	M 52 C057 0100 0F __	906x447	70	50 - 75 - 100	100% - 96% - 92%

* ABBINARE AL CODICE ARTICOLO UNO DEI KIT PLASTICHE DISPONIBILI NELLA TABELLA SOTTOSTANTE



PIANI ESTRAIBILI AD ESTRAZIONE TELESCOPICA

ART. CON kit plastiche Dark Grey	ART. SENZA kit plastiche*	Dim. utili mm	H frontale mm	kg	
M 52 C057 0110 0T __	M 52 C057 0100 0T __	906x447	70	200	100%

* ABBINARE AL CODICE ARTICOLO UNO DEI KIT PLASTICHE DISPONIBILI NELLA TABELLA SOTTOSTANTE



PIANO REGOLABILE

ART.	Dim. utili mm	H totale mm	kg
M 52 PR25 00 00 01 __	963x478	60	100

INSERIBILE DAVANTI ALL'ASTA VERTEBRATA

KIT PLASTICHE PER CASSETTI E PIANI ESTRAIBILI

















GAMMA COLORI PLASTICHE	ART.
MEDITERRANEAN BLUE	M 50 PLS1 00 00 00 M1
SKY BLUE	M 50 PLS1 00 00 00 M2
GLAMOUR RED	M 50 PLS1 00 00 00 M3
RED CARPET	M 50 PLS1 00 00 00 M4
JUICY ORANGE	M 50 PLS1 00 00 00 M5
SUNNY YELLOW	M 50 PLS1 00 00 00 M6
FOREST GREEN	M 50 PLS1 00 00 00 M7



ART. M 52 A200 P5 11 PC GS

🔑 PORTE A BATTENTE CON CILINDRO





COPPIA PORTE A BATTENTE ALTEZZA TOTALE

H ARMADIO mm	TIPO DI CHIUSURA	ART. CON kit plastiche Dark Grey 	ART. SENZA kit plastiche* 
850	 C0 KEY chiusura a cilindro	M 50 P075 C0 10 10 __	M 50 P075 C0 00 10 __
	 C1 KEY chiusura a cilindro	M 50 P075 C1 10 10 __	M 50 P075 C1 00 10 __
	 C2 KEY chiusura a cilindro	M 50 P075 C2 10 10 __	M 50 P075 C2 00 10 __
1000	 C0 KEY chiusura a cilindro	M 50 P090 C0 10 10 __	M 50 P090 C0 00 10 __
	 C1 KEY chiusura a cilindro	M 50 P090 C1 10 10 __	M 50 P090 C1 00 10 __
	 C2 KEY chiusura a cilindro	M 50 P090 C2 10 10 __	M 50 P090 C2 00 10 __
1500	 C0 KEY chiusura a cilindro	M 50 P140 C0 10 10 __	M 50 P140 C0 00 10 __
	 C1 KEY chiusura a cilindro	M 50 P140 C1 10 10 __	M 50 P140 C1 00 10 __
	 C2 KEY chiusura a cilindro	M 50 P140 C2 10 10 __	M 50 P140 C2 00 10 __
2000	 C0 KEY chiusura a cilindro	M 50 P190 C0 10 10 __	M 50 P190 C0 00 10 __
	 C1 KEY chiusura a cilindro	M 50 P190 C1 10 10 __	M 50 P190 C1 00 10 __
	 C2 KEY chiusura a cilindro	M 50 P190 C2 10 10 __	M 50 P190 C2 00 10 __

* ABBINARE AL CODICE ARTICOLO UNO DEI KIT PLASTICHE DISPONIBILI NELLA TABELLA A DESTRA

LA COPPIA PORTE DEVE ESSERE ASSOCIATA OBBLIGATORIAMENTE AGLI ARMADI CON LA CHIUSURA: **C5** (SENZA SERRATURA) OPPURE **X0** (SENZA ASTA VERTEBRATA E SENZA SERRATURA)

COPPIA PORTE A BATTENTE ALTEZZA PARZIALE

H INGOMBRO PORTA mm	TIPO DI CHIUSURA	ART. CON kit plastiche Dark Grey 	ART. SENZA kit plastiche* 
775	 C0 KEY chiusura a cilindro	M 50 P077 C0 10 11 __	M 50 P077 C0 00 11 __
	 C1 KEY chiusura a cilindro	M 50 P077 C1 10 11 __	M 50 P077 C1 00 11 __
	 C2 KEY chiusura a cilindro	M 50 P077 C2 10 11 __	M 50 P077 C2 00 11 __

* ABBINARE AL CODICE ARTICOLO UNO DEI KIT PLASTICHE DISPONIBILI NELLA TABELLA A DESTRA





PORTE A BATTENTE CON CODICE NUMERICO

COPPIA PORTE A BATTENTE ALTEZZA TOTALE



H ARMADIO mm	TIPO DI CHIUSURA	ART. CON kit plastiche Dark Grey	ART. SENZA kit plastiche*
850	P5 CODE codice numerico	M 50 P075 P5 10 10 _ _	M 50 P075 P5 00 10 _ _
1000	P5 CODE codice numerico	M 50 P090 P5 10 10 _ _	M 50 P090 P5 00 10 _ _
1500	P5 CODE codice numerico	M 50 P140 P5 10 10 _ _	M 50 P140 P5 00 10 _ _
2000	P5 CODE codice numerico	M 50 P190 P5 10 10 _ _	M 50 P190 P5 00 10 _ _

* ABBINARE AL CODICE ARTICOLO UNO DEI KIT PLASTICHE DISPONIBILI NELLA TABELLA SOTTOSTANTE

LA COPPIA PORTE DEVE ESSERE ASSOCIATA OBBLIGATORIAMENTE AGLI ARMADI CON LA CHIUSURA: **C5** (SENZA SERRATURA) OPPURE **X0** (SENZA ASTA VERTEBRATA E SENZA SERRATURA)

COPPIA PORTE A BATTENTE ALTEZZA PARZIALE



H INGOMBRO PORTA mm	TIPO DI CHIUSURA	ART. CON kit plastiche Dark Grey	ART. SENZA kit plastiche*
775	A4 maniglia senza tastierino	M 50 P077 A4 10 11 _ _	M 50 P077 A4 00 11 _ _

* ABBINARE AL CODICE ARTICOLO UNO DEI KIT PLASTICHE DISPONIBILI NELLA TABELLA SOTTOSTANTE

LA COPPIA PORTE DEVE ESSERE ASSOCIATA OBBLIGATORIAMENTE AGLI ARMADI CON LE CHIUSURE:
UTILIZZARE LA SERRATURA **T2** PER L'ARMADIO SENZA RUOTE
UTILIZZARE LA SERRATURA **A1** PER L'ARMADIO CON RUOTE



TELECOMANDO

ART.	
M00VRC000000000	Modulo ricevitore con telecomando
M00VRC000000100	Telecomando aggiuntivo

KIT PLASTICHE PER COPPIA PORTE

















GAMMA COLORI PLASTICHE	ART. KEY	ART. CODE
MEDITERRANEAN BLUE	M 00 PLS0 00 00 30 M1	M 00 PLS0 00 00 31 M1
SKY BLUE	M 00 PLS0 00 00 30 M2	M 00 PLS0 00 00 31 M2
GLAMOUR RED	M 00 PLS0 00 00 30 M3	M 00 PLS0 00 00 31 M3
RED CARPET	M 00 PLS0 00 00 30 M4	M 00 PLS0 00 00 31 M4
JUICY ORANGE	M 00 PLS0 00 00 30 M5	M 00 PLS0 00 00 31 M5
SUNNY YELLOW	M 00 PLS0 00 00 30 M6	M 00 PLS0 00 00 31 M6
FOREST GREEN	M 00 PLS0 00 00 30 M7	M 00 PLS0 00 00 31 M7

ARMADIO VUOTO



CON 2 PORTE SCORREVOLI







ARMADIO CON DOPPIA PORTA SCORREVOLE SENZA ASTA VERTEBRATA

H ARMADIO mm	TIPO DI CHIUSURA	ART. con kit plastiche Dark Grey 	ART. senza kit plastiche* 
850 (utile 750 mm)	 C0 KEY chiusura a cilindro	M 52 D085 C0 10 0D __	M 52 D085 C0 00 0D __
	 C1 KEY chiusura a cilindro	M 52 D085 C1 10 0D __	M 52 D085 C1 00 0D __
	 C2 KEY chiusura a cilindro	M 52 D085 C2 10 0D __	M 52 D085 C2 00 0D __
1000 (utile 900 mm)	 C0 KEY chiusura a cilindro	M 52 D100 C0 10 0D __	M 52 D100 C0 00 0D __
	 C1 KEY chiusura a cilindro	M 52 D100 C1 10 0D __	M 52 D100 C1 00 0D __
	 C2 KEY chiusura a cilindro	M 52 D100 C2 10 0D __	M 52 D100 C2 00 0D __
1500 (utile 1400 mm)	 C0 KEY chiusura a cilindro	M 52 D150 C0 10 0D __	M 52 D150 C0 00 0D __
	 C1 KEY chiusura a cilindro	M 52 D150 C1 10 0D __	M 52 D150 C1 00 0D __
	 C2 KEY chiusura a cilindro	M 52 D150 C2 10 0D __	M 52 D150 C2 00 0D __
2000 (utile 1900 mm)	 C0 KEY chiusura a cilindro	M 52 D200 C0 10 0D __	M 52 D200 C0 00 0D __
	 C1 KEY chiusura a cilindro	M 52 D200 C1 10 0D __	M 52 D200 C1 00 0D __
	 C2 KEY chiusura a cilindro	M 52 D200 C2 10 0D __	M 52 D200 C2 00 0D __

* ABBINARE AL CODICE ARTICOLO UNO DEI KIT PLASTICHE DISPONIBILI NELLA TABELLA SOTTOSTANTE

KIT PLASTICHE PER PORTE SCORREVOLI



GAMMA COLORI PLASTICHE	ART. 2 PORTE SCORREVOLI	ART. 1 PORTA SCORREVOLE
 MEDITERRANEAN BLUE	M 00 PLS0 00 00 50 M1	M 00 PLS0 00 00 40 M1
 SKY BLUE	M 00 PLS0 00 00 50 M2	M 00 PLS0 00 00 40 M2
 GLAMOUR RED	M 00 PLS0 00 00 50 M3	M 00 PLS0 00 00 40 M3
 RED CARPET	M 00 PLS0 00 00 50 M4	M 00 PLS0 00 00 40 M4
 JUICY ORANGE	M 00 PLS0 00 00 50 M5	M 00 PLS0 00 00 40 M5
 SUNNY YELLOW	M 00 PLS0 00 00 50 M6	M 00 PLS0 00 00 40 M6
 FOREST GREEN	M 00 PLS0 00 00 50 M7	M 00 PLS0 00 00 40 M7

ARMADIO VUOTO



CON 1 PORTA SCORREVOLE

ARMADIO CON PORTA SCORREVOLE SINGOLA SENZA ASTA VERTEBRATA

H ARMADIO mm	TIPO DI CHIUSURA	ART. con kit plastiche Dark Grey	ART. senza kit plastiche*
850 (utile 750 mm)	C0 KEY chiusura a cilindro	M 52 D085 C0 10 OS __	M 52 D085 C0 00 OS __
	C1 KEY chiusura a cilindro	M 52 D085 C1 10 OS __	M 52 D085 C1 00 OS __
	C2 KEY chiusura a cilindro	M 52 D085 C2 10 OS __	M 52 D085 C2 00 OS __
1000 (utile 900 mm)	C0 KEY chiusura a cilindro	M 52 D100 C0 10 OS __	M 52 D100 C0 00 OS __
	C1 KEY chiusura a cilindro	M 52 D100 C1 10 OS __	M 52 D100 C1 00 OS __
	C2 KEY chiusura a cilindro	M 52 D100 C2 10 OS __	M 52 D100 C2 00 OS __

* ABBINARE AL CODICE ARTICOLO UNO DEI KIT PLASTICHE DISPONIBILI NELLA TABELLA A SINISTRA



PORTA SINGOLA con chiusura SOLO a dx. Solo il vano di sinistra è predisposto per l'inserimento di cassetti e piani estraibili. **OBBLIGO** di inserimento dell'asta vertebrata in presenza di PIÙ DI 2 CASSETTI/PIANI ESTRAIBILI per vano.



CHIUSURA A CILINDRO

TIPO DI CHIUSURA	ART.
C0 KEY chiusura a cilindro	M 52 V000 C0 00 00 00
C1 KEY chiusura a cilindro	M 52 V000 C1 00 00 00
C2 KEY chiusura a cilindro	M 52 V000 C2 00 00 00

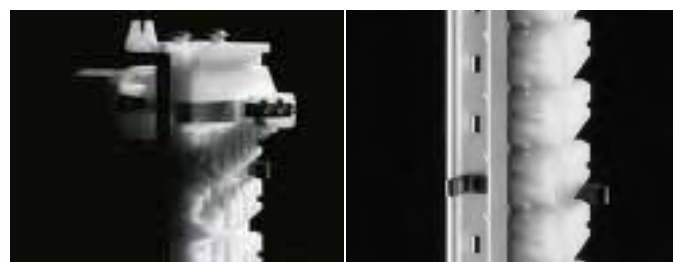

ASTA VERTEBRATA

H UTILE INSERIMENTO CASSETTI mm	ART.
750	M 00 V075 00 00 00 00
900	M 00 V090 00 00 00 00
1400	M 00 V140 00 00 00 00
1900	M 00 V190 00 00 00 00



PIANO SUPERIORE A 3 BORDI

ART.	dim. mm	
M 52 T023 AG 00 31 07	1020x573x23 H	

Piano rivestito in pvc per ARMADIO SINGOLO. Colore nero



PIANO SUPERIORE A 4 BORDI

ART.	dim. mm	
M 52 T023 AG 00 41 07	1020x573x23 H	

Piano rivestito in pvc per ARMADIO SINGOLO. Colore nero



ART. M 00 T023 AG 00 FO 00

FORATURA PIANO SUPERIORE DELL'ARMADIO PER IL FISSAGGIO DEL PIANO A 4 BORDI



PIANO SUPERIORE IN MULTIPLEX

ART.	dim. mm	
M 52 T040 MU 00 01 00	1020x573x40 H	

Per ARMADIO SINGOLO



PIANO SUPERIORE IN MDF DIM. 1020x573x32 mm h

ART.	rifiniture	per armadio	
M 52 T030 MD GM 2107	1 profilo laterale	finale dx o sx	

Piano in MDF con copertura in gomma antiolio. Colore nero



PIANO SUPERIORE IN MDF DIM. 1020x573x32 mm h

ART.	rifiniture	per armadio	
M 52 T030 MD GM 1107	-	centrale	

Piano in MDF con copertura in gomma antiolio. Colore nero



PIANO SUPERIORE IN MDF DIM. 1020x573x32 mm h

ART.	rifiniture	per armadio	
M 52 T030 MD GM 0107	2 profili laterali	singolo	

Piano in MDF con copertura in gomma antiolio. Colore nero



ART. M 00 T030 MD 00 FO 00

FORATURA PIANO SUPERIORE DELL'ARMADIO PER IL FISSAGGIO DEL PIANO IN MDF E DEL PIANO IN MULTIPLEX COMPRESIVO DI VITI PER IL FISSAGGIO

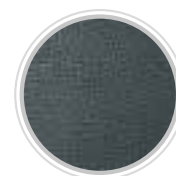

RIFINITURA
GOMMA
ANTIOLIO



APPLICAZIONE
PIANO IN MDF



**PIANO SUPERIORE IN MULTIPLEX PER
ARMADIO CON RUOTE**
DISPONIBILE SU RICHIESTA





ZOCCOLO DI RIALZO ALTEZZA 50 mm

ART.		dim. mm	
M 52 Z050 00 00 00		1018x572x50 H	



ZOCCOLO DI RIALZO ALTEZZA 100 mm

ART.		dim. mm	
M 52 Z100 00 00 00		1018x572x100 H	



ZOCCOLI PER CARRELLO ELEVATORE - Colore nero RAL 9005

ART.		dim. mm	
M 02 Z060 20 00 00 07		coppia zoccoli	200x569x60 H
M 50 Z060 21 00 00 07		chiusura per coppia zoccoli	1014x46x55 H



ART.		dim. mm	
M 02 Z100 20 00 00 07		coppia zoccoli	200x569x100 H
M 50 Z100 21 00 00 07		chiusura per coppia zoccoli	1014x46x95 H



RUOTA FISSA IN GOMMA ELASTICA

ART.	Ø mm	portata armadio kg	C mm
C RG BCE15 125	125	370	155
C RG BCE15 160	160	600	200



RUOTA GIREVOLE CON FRENO IN GOMMA ELASTICA

ART.	Ø mm	portata armadio kg	C mm
C RG DCE15 125	125	370	155
C RG DCE15 160	160	600	200



RUOTA FISSA IN NYLON

ART.	Ø mm	portata armadio kg	C mm
C RN BAD10 100	100	205	128
C RN BAD11 125	125	370	155



RUOTA GIREVOLE CON FRENO IN NYLON

ART.	Ø mm	portata armadio kg	C mm
C RN DAD10 100	100	205	128
C RN DAD11 125	125	370	155



RICAMBI - FISSAGGIO

SERRATURA DI RICAMBIO

ART. M 00 CSRO 8800 00 00
Serratura di ricambio con due chiavi



CHIAVE DI RICAMBIO

ART. M 00 CF00 0000 00 00

Specificare sempre il numero indicato nella serratura a cilindro dove si vuole sostituire la chiave



PASSEPARTOUT

ART. M 00 PF.. 0000 00 00

Disponibile in 23 serie, con numerazione da F 01 a F 23.

Passepartout serie F 01
Passepartout serie F 02
Passepartout serie F ..

ART. M 00 PF01 00 00 00 00
ART. M 00 PF02 00 00 00 00
ART. M 00 PF.. 00 00 00 00

SET FISSAGGIO TRA ARMADI

ART. M 00 FISO 00 00 00 99

Set di fissaggio armadio-armadio con 4 viti complete di dadi M8

ART. M 00 SVRO 00 00 00 99

Foratura e viteria per il fissaggio dei due armadi sovrapposti

SET DI FISSAGGIO A PAVIMENTO



ART. F AG 9200 00 99

Coppia staffe zincate per il fissaggio a pavimento dell'armadio

ART. F AG 9204 00 99

2 tasselli "HILTI" adatti per pavimenti in calcestruzzo non fessurato maggiore o uguale alla classe C20/25
Trazione consigliata del tassello: 2,9 kN
Diametro tassello: Ø 6 mm



MANIGLIA DI RICAMBIO

ART. M 00 PLSO 0000 22 MO

Maniglia di ricambio per porte disponibile in colore Dark Grey.



ALTRI COLORI A RICHIESTA



GLI ARMADI DEVONO ESSERE FISSATI A PAVIMENTO O A PARETE
SE SOVRAPPosti DEVONO ESSERE FISSATI OBBLIGATORIAMENTE A PARETE E LA LORO PORTATA DIVISA PER DUE



MASTER

1020x573 mm

Born To Be Extreme

ARMADIO VUOTO senza asta vertebrata e senza chiusura

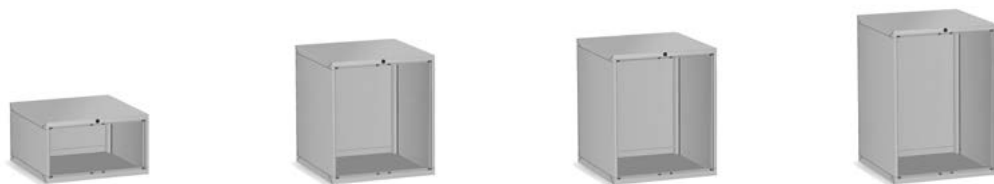

H 400 mm
H utile 300 mm



H 700 mm
H utile 600 mm



H 800 mm
H utile 700 mm



H 850 mm
H utile 750 mm



M 52 A040 X0 10 00 __ M 52 A070 X0 10 00 __ M 52 A080 X0 10 00 __ M 52 A085 X0 10 00 __

ASTA VERTEBRATA



L'asta vertebrata è composta da un profilo in alluminio estruso forato a passo 25 mm per l'inserimento della molla antiribaltamento. L'asta antiribaltamento viene fornita completa di accessori in plastica e struttura superiore predisposta per la chiusura a cilindro o elettronica.

ART.	H utile inserimento cassette mm
M 00 V030 00 00 00 00	300
M 00 V050 00 00 00 00	500
M 00 V060 00 00 00 00	600
M 00 V070 00 00 00 00	700
M 00 V075 00 00 00 00	750
M 00 V090 00 00 00 00	900

ART.	H utile inserimento cassette mm
M 00 V105 00 00 00 00	1050
M 00 V122 00 00 00 00	1225
M 00 V140 00 00 00 00	1400
M 00 V152 00 00 00 00	1525
M 00 V190 00 00 00 00	1900

CHIUSURA CON CILINDRO (KEY)



CHIUSURA A CILINDRO COMPLETA DI:

- 1 serratura a cilindro con 2 chiavi
- 1 filo in acciaio con guaina
- 1 gruppo percussore anteriore
- 1 gruppo cursore posteriore

ART.	
M 52 V000 C0 00 00 00	C0 CHIUSURA A CILINDRO CON NUMERAZIONE DIVERSA
M 52 V000 C1 00 00 00	C1 CHIUSURA A CILINDRO PER GRUPPI DI 160 NUMERI
M 52 V000 C2 00 00 00	C2 CHIUSURA A CILINDRO CON NUMERAZIONE UGUALE

For Experts Only



H 1000 mm
H utile 900 mm



H 1500 mm
H utile 1400 mm



H 2000 mm
H utile 1900 mm



M 52 A100 X0 10 00 __

M 52 A150 X0 10 00 __

M 52 A200 X0 10 00 __

CHIUSURA CON CODICE NUMERICO (CODE)



ART.

M 52 V000 E2 00 00 00

E2 APERTURA/CHIUSURA ASTA (alimentazione a batteria)

M 52 V000 E5 00 00 00

E5 APERTURA/CHIUSURA ASTA (alimentazione da rete elettrica)

M 52 V000 T2 00 00 00

T2 APERTURA/CHIUSURA ASTA + PORTA (alimentazione a batteria)

M 52 V000 T3 00 00 00

T3 APERTURA/CHIUSURA ASTA + PORTA (alimentazione da rete elettrica)

ART. TELECOMANDO

M 00 VRC0 00 00 00 00

Modulo ricevitore
con telecomando

M 00 VRC0 00 00 01 00

Telecomando aggiuntivo



PIANI PER SERRATURE E PIANI REGOLABILI

PIANO SUPERIORE PER SERRATURE



ART.



H frontale mm

kg

M 52 PS46 00 10 00 __

46

150

Dim. mm 969x571x46 h

PIANO INFERIORE PER SERRATURE



ART.



H frontale mm

kg

M 52 PS46 10 10 00 __

46

150

Dim. mm 969x571x46 h

PIANO REGOLABILE



ART.



H totale mm

kg

M 52 PR25 00 00 01 __

60

100

Dim. utili mm 963x478x60 h

PIANO REGOLABILE FESSURATO



ART.



H frontale mm

kg

M 52 PR35 10 00 01 __

35

300

Dim. mm 969x568x35 h

54x27 EH

MATERIALE DI SEPARAZIONE

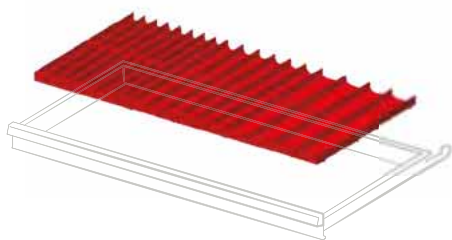

ART. per altezza frontale mm

F FH 4005 12 00 50 - 300

Set composto da: 6 divisori 4 canali, 6 divisori 3 canali, 6 divisori 2 canali, 15 divisori trasversali 36 mm, 10 divisori trasversali 47 mm, 6 divisori trasversali 73 mm

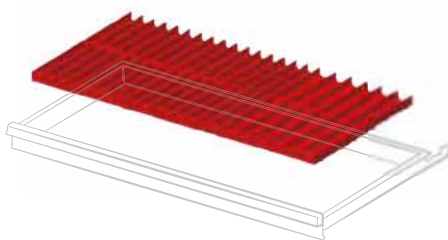

ART. per altezza frontale mm

F FH 4005 15 00 50 - 300

Set composto da: 12 divisori 4 canali, 6 divisori 3 canali, 30 divisori trasversali 36 mm, 10 divisori trasversali 47 mm

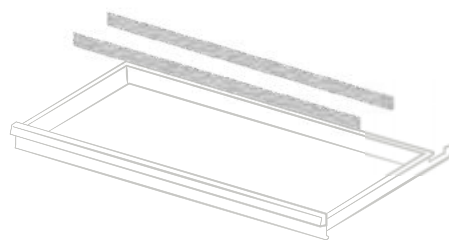

ART. per altezza frontale mm

F FH 4005 01 00 50

F FH 4007 01 00 75

F FH 4010 01 00 100 - 125

F FH 4015 01 00 150

F FH 4020 01 00 200 - 250

F FH 4030 01 00 300

Set composto da: 2 divisori longitudinali non fessurati 914 mm

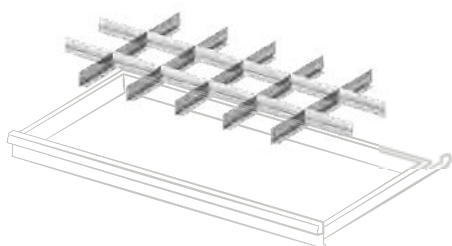

ART. per altezza frontale mm

F FH 4005 03 00 50

F FH 4007 03 00 75

F FH 4010 03 00 100 - 125

F FH 4015 03 00 150

F FH 4020 03 00 200 - 250

Set composto da: 5 divisori longitudinali fessurati 455 mm, 12 divisori trasversali 149 mm

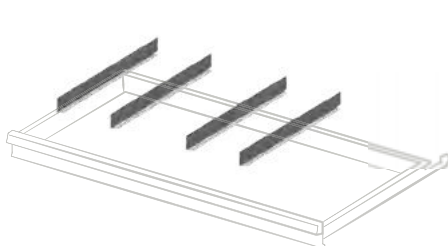

ART. per altezza frontale mm

F FH 4005 04 00 50

F FH 4007 04 00 75

F FH 4010 04 00 100 - 125

F FH 4015 04 00 150

F FH 4020 04 00 200 - 250

Set composto da: 4 divisori longitudinali non fessurati 455 mm

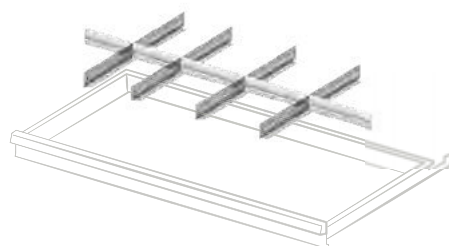

ART. per altezza frontale mm

F FH 4005 05 00 50

F FH 4007 05 00 75

F FH 4010 05 00 100 - 125

F FH 4015 05 00 150

F FH 4020 05 00 200 - 250

Set composto da: 4 divisori longitudinali fessurati 455 mm, 2 divisori trasversali 149 mm, 3 divisori trasversali 200 mm

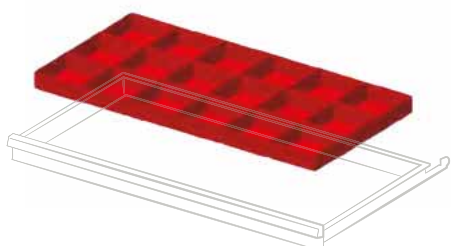

ART. per altezza frontale mm

F FH 4005 11 00 50

F FH 4007 11 00 75

F FH 4010 11 00 100 - 125

Set composto da: 18 cassette divisorio 150x150 mm

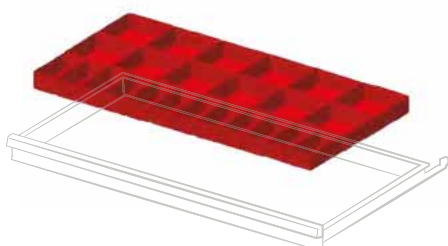

ART. per altezza frontale mm

F FH 4005 13 00 50

F FH 4007 13 00 75

F FH 4010 13 00 100 - 125

Set composto da: 12 cassette divisorio 150x75 mm, 12 cassette divisorio 150x150 mm

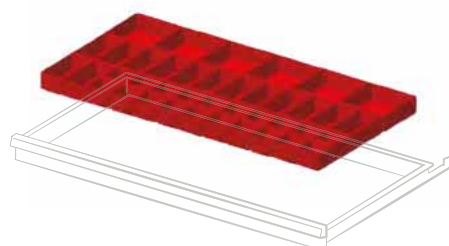

ART. per altezza frontale mm

F FH 4005 16 00 50

F FH 4007 16 00 75

Set composto da: 20 cassette divisorio 75x75 mm, 14 cassette divisorio 150x75 mm, 6 cassette divisorio 150x150 mm

CONFIGURA IL CASSETTO FAMI CON UTENSILI BETA



ART. F FH 4007 50 07

Set di predisposizione cassetto per termoformati Beta composto da:

n. 4 F HC 6071 00 07

n. 4 F HC 6471 00 07

n. 1 F HA 2150 00 99

1 unit = 1 termoformato Beta 367x147 mm

2 unit = 1 termoformato Beta 367x294 mm

4 unit = 1 termoformato Beta 367x588 mm





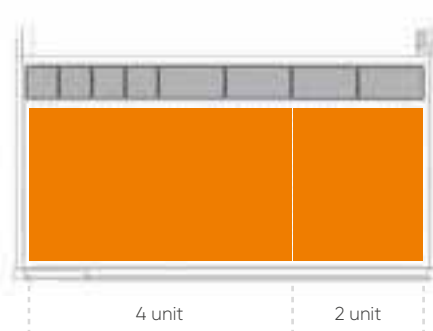
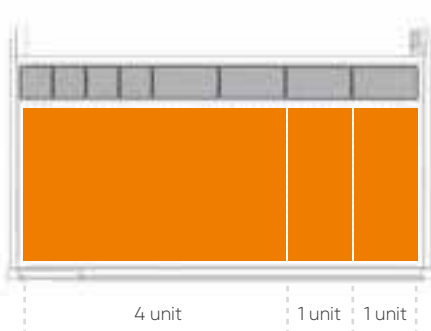
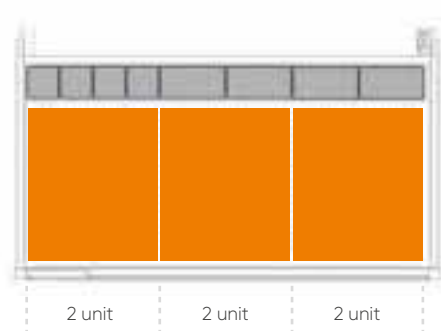
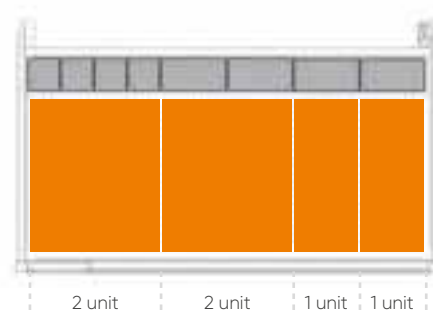
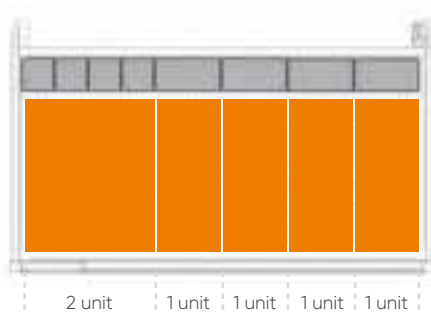
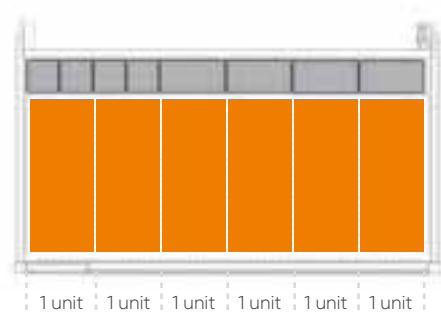

ESEMPI DI UTILIZZO TERMOFORMATO









Gamma colori ACCIAIO

	
GRIGIO RAL 7000 .01	VERDE RAL 6011 .02
	
BLU RAL 5012 .04	GRIGIO RAL 7035 .08
	
BIANCO GRIGIASTRO RAL 9002 .1F	ROSSO RUBINO RAL 3003 .1G
	
BLU GENZIANA RAL 5010 .34	BIANCO PURO RAL 9010 .35
	
GRIGIO ANTRACITE RAL 7016 .39	BLU CAPRI RAL 5019 .48



● ART. M 23 A100 C0 10 AZ 04
H = 1000 mm - 7 cassetti

Gamma colori PLASTICHE

			
DARK GREY .M0	MEDITERRANEAN BLUE .M1	SKY BLUE .M2	GLAMOUR RED .M3
			
RED CARPET .M4	JUICE ORANGE .M5	SUNNY YELLOW .M6	FOREST GREEN .M7

LEGENDA



PORTATA
CASSETTO/
PIANO



ESTRAZIONE
CASSETTO/
PIANO



CHIUSURA
ARMADIO



LE PORTATE SONO NETTE E SI RIFERISCONO A PESI UNIFORMEMENTE DISTRIBUITI

H 400 mm



ART.					
M 23 A040 C0 10 04 04		50-75-100	100-96-92%	key	
M 23 A040 E2 10 04 04		50-75-100	100-96-92%	code	

H 400 mm



ART.					
M 23 A040 C0 10 02 04		50-75-100	100-96-92%	key	
M 23 A040 E2 10 02 04		50-75-100	100-96-92%	code	

H 600 mm



ART.					
M 23 A060 C0 10 20 04		50-75-100	100-96-92%	key	
M 23 A060 E2 10 20 04		50-75-100	100-96-92%	code	

H 600 mm



ART.					
M 23 A060 C0 10 17 04		50-75-100	100-96-92%	key	porta 425 mm profondità 751 mm
M 23 A060 T2 10 17 04		50-75-100	100-96-92%	code	

H 700 mm



ART.					
M 23 A070 C0 10 49 04		50-75-100	100-96-92%	key	
M 23 A070 E2 10 49 04		50-75-100	100-96-92%	code	

H 700 mm



ART.					
M 23 A070 C0 10 35 04		50-75-100	100-96-92%	key	
M 23 A070 E2 10 35 04		50-75-100	100-96-92%	code	

H 700 mm



ART.				
M 23 A070 C0 10 32 04		50-75-100	100-96-92%	key
M 23 A070 E2 10 32 04		50-75-100	100-96-92%	code

H 700 mm



porta 425 mm profondità 751 mm

ART.				
M 23 A070 C0 10 30 04		50-75-100	100-96-92%	key
M 23 A070 T2 10 30 04		50-75-100	100-96-92%	code

H 800 mm



ART.				
M 23 A080 C0 10 54 04		50-75-100	100-96-92%	key
M 23 A080 E2 10 54 04		50-75-100	100-96-92%	code

H 800 mm



ART.				
M 23 A080 C0 10 56 04		50-75-100	100-96-92%	key
M 23 A080 E2 10 56 04		50-75-100	100-96-92%	code

H 800 mm



ART.				
M 23 A080 C0 10 66 04		50-75-100	100-96-92%	key
M 23 A080 E2 10 66 04		50-75-100	100-96-92%	code

H 800 mm



porta 425 mm profondità 751 mm

ART.				
M 23 A080 C0 10 57 04		50-75-100	100-96-92%	key
M 23 A080 T2 10 57 04		50-75-100	100-96-92%	code

H 850 mm



ART.				
M 23 A085 C0 10 93 04		50-75-100	100-96-92%	key
M 23 A085 E2 10 93 04		50-75-100	100-96-92%	code

H 850 mm



ART.				
M 23 A085 C0 10 91 04		50-75-100	100-96-92%	key
M 23 A085 E2 10 91 04		50-75-100	100-96-92%	code

H 850 mm



ART.				
M 23 A085 C0 10 95 04		50-75-100	100-96-92%	key
M 23 A085 E2 10 95 04		50-75-100	100-96-92%	code

H 850 mm



porta 625 mm profondità 751 mm

ART.				
M 23 A085 C0 10 99 04		50-75-100	100-96-92%	key
M 23 A085 T2 10 99 04		50-75-100	100-96-92%	code

H 1000 mm



ART.				
M 23 A100 C0 10 AZ 04		50-75-100	100-96-92%	key
M 23 A100 E2 10 AZ 04		50-75-100	100-96-92%	code

H 1000 mm



porta 625 mm profondità 751 mm

ART.				
M 23 A100 C0 10 BD 04		50-75-100	100-96-92%	key
M 23 A100 T2 10 BD 04		50-75-100	100-96-92%	code

H 818 mm



ART.				
M 23 R060 SO 10 20 04		50-75-100	100-96-92%	key
M 23 R060 P2 10 20 04		50-75-100	100-96-92%	code

Portata armadio 235 kg - Altezza armadio senza ruote mm 663

H 818 mm



ART.				
M 23 R060 SO 10 21 04		50-75-100	100-96-92%	key
M 23 R060 P2 10 21 04		50-75-100	100-96-92%	code

Portata armadio 235 kg - Altezza armadio senza ruote mm 663

H 918 mm



ART.				
M 23 R070 SO 10 34 04		50-75-100	100-96-92%	key
M 23 R070 P2 10 34 04		50-75-100	100-96-92%	code

Portata armadio 235 kg - Altezza armadio senza ruote mm 763

H 918 mm



ART.				
M 23 R070 SO 10 31 04		50-75-100	100-96-92%	key
M 23 R070 P2 10 31 04		50-75-100	100-96-92%	code

Portata armadio 235 kg - Altezza armadio senza ruote mm 763



2 ruote girevoli con freno in gomma standard Ø 125 mm
2 ruote fisse in gomma standard Ø 125 mm

H 1018 mm



H 1018 mm



ART.				
M 23 R080 S0 10 63 04		50-75-100	100-96-92%	key
M 23 R080 P2 10 63 04		50-75-100	100-96-92%	code

Portata armadio 235 kg - Altezza armadio senza ruote mm 863

ART.				
M 23 R080 S0 10 56 04		50-75-100	100-96-92%	key
M 23 R080 P2 10 56 04		50-75-100	100-96-92%	code

Portata armadio 235 kg - Altezza armadio senza ruote mm 863

H 1068 mm



H 1068 mm



ART.				
M 23 R085 S0 10 94 04		50-75-100	100-96-92%	key
M 23 R085 P2 10 94 04		50-75-100	100-96-92%	code

Portata armadio 235 kg - Altezza armadio senza ruote mm 913

ART.				
M 23 R085 S0 10 95 04		50-75-100	100-96-92%	key
M 23 R085 P2 10 95 04		50-75-100	100-96-92%	code

Portata armadio 235 kg - Altezza armadio senza ruote mm 913



2 ruote girevoli con freno in gomma standard Ø 125 mm
2 ruote fisse in gomma standard Ø 125 mm

H 1218 mm



ART.				
M 23 R100 S0 10 AY 04		50-75-100	100-96-92%	key
M 23 R100 P2 10 AY 04		50-75-100	100-96-92%	code

Portata armadio 235 kg - Altezza armadio senza ruote mm 1063

H 1218 mm



ART.				
M 23 R100 S0 10 AZ 04		50-75-100	100-96-92%	key
M 23 R100 P2 10 AZ 04		50-75-100	100-96-92%	code

Portata armadio 235 kg - Altezza armadio senza ruote mm 1063



2 ruote girevoli con freno in gomma standard Ø 125 mm
2 ruote fisse in gomma standard Ø 125 mm



ART. M 23 A100 C0 16 NG 04

ART. M 23 R070 P2 14 NL 08



ART. M 23 R080 P2 15 NM 39

CONFIGURA IL TUO ARMADIO

	SCEGLI l'altezza	SCEGLI la chiusura	SCEGLI il colore
M23	A040	C5	10 00

ARMADIO VUOTO



Portata corpo
armadio 3100 kg

M23	ALTEZZA	CHIUSURA	10 00	COLORE
	A040	400 mm (utile 300 mm)		X0 senza asta e senza serratura
A060	600 mm (utile 500 mm)	C5* senza serratura	02 RAL 6011	
A070	700 mm (utile 600 mm)	C0* KEY chiusura a cilindro	1G RAL 3003	
A080	800 mm (utile 700 mm)	C1* KEY chiusura a cilindro	1F RAL 9002	
A085	850 mm (utile 750 mm)	C2* KEY chiusura a cilindro	48 RAL 5019	
A100	1000 mm (utile 900 mm)	E2* CODE codice numerico	39 RAL 7016	
A150	1500 mm (utile 1400 mm)	T2* CODE codice numerico	04 RAL 5012	
A200	2000 mm (utile 1900 mm)		08 RAL 7035	
			35 RAL 9010	
			34 RAL 5010	

*COMPLETA DI ASTA VERTEBRATA

ARMADIO VUOTO predisposto per ruote



M23	ALTEZZA	CHIUSURA	10 00	COLORE
	R060	663 mm (utile 500 mm)		S0 KEY chiusura a cilindro
R070	763 mm (utile 600 mm)	S1 KEY chiusura a cilindro	02 RAL 6011	
R080	863 mm (utile 700 mm)	S2 KEY chiusura a cilindro	1G RAL 3003	
R085	913 mm (utile 750 mm)	P2 CODE codice numerico	1F RAL 9002	
R100	1063 mm (utile 900 mm)	A1 CODE codice numerico	48 RAL 5019	
			39 RAL 7016	
			04 RAL 5012	
			08 RAL 7035	
			35 RAL 9010	
			34 RAL 5010	

COMPLETO DI ASTA VERTEBRATA, PIANO A 4 BORDI CON COPERTURA IN PVC, COPPIA MANIGLIE, COPPIA PIASTRE
Dim. ingombro mm 587x800



CASSETTI AD ESTRAZIONE FLESSIBILE

ART. CON kit plastiche Dark Grey	ART. SENZA kit plastiche*	Dim. utili mm	H frontale mm	kg	
M 23 C050 0110 OF __	M 23 C050 01 00 OF __	447x600x31 H	50	50 - 75 - 100	100% - 96% - 92%
M 23 C075 0110 OF __	M 23 C075 01 00 OF __	447x600x56 H	75	50 - 75 - 100	100% - 96% - 92%
M 23 C100 0110 OF __	M 23 C100 01 00 OF __	447x600x81 H	100	50 - 75 - 100	100% - 96% - 92%
M 23 C125 0110 OF __	M 23 C125 01 00 OF __	447x600x106 H	125	50 - 75 - 100	100% - 96% - 92%
M 23 C150 0110 OF __	M 23 C150 01 00 OF __	447x600x131 H	150	50 - 75 - 100	100% - 96% - 92%
M 23 C200 0110 OF __	M 23 C200 01 00 OF __	447x600x181 H	200	50 - 75 - 100	100% - 96% - 92%
M 23 C250 0110 OF __	M 23 C250 01 00 OF __	447x600x231 H	250	50 - 75 - 100	100% - 96% - 92%
M 23 C300 0110 OF __	M 23 C300 01 00 OF __	447x600x281 H	300	50 - 75 - 100	100% - 96% - 92%

* ABBINARE AL CODICE ARTICOLO UNO DEI KIT PLASTICHE DISPONIBILI NELLA TABELLA SOTTOSTANTE



CASSETTI AD ESTRAZIONE TELESCOPICA

ART. CON kit plastiche Dark Grey	ART. SENZA kit plastiche*	Dim. utili mm	H frontale mm	kg	
M 23 C075 0110 OT __	M 23 C075 01 00 OT __	447x600x56 H	75	200	100%
M 23 C100 0110 OT __	M 23 C100 01 00 OT __	447x600x81 H	100	200	100%
M 23 C125 0110 OT __	M 23 C125 01 00 OT __	447x600x106 H	125	200	100%
M 23 C150 0110 OT __	M 23 C150 01 00 OT __	447x600x131 H	150	200	100%
M 23 C200 0110 OT __	M 23 C200 01 00 OT __	447x600x181 H	200	200	100%
M 23 C250 0110 OT __	M 23 C250 01 00 OT __	447x600x231 H	250	200	100%
M 23 C300 0110 OT __	M 23 C300 01 00 OT __	447x600x281 H	300	200	100%

* ABBINARE AL CODICE ARTICOLO UNO DEI KIT PLASTICHE DISPONIBILI NELLA TABELLA SOTTOSTANTE

KIT PLASTICHE PER CASSETTI E PIANI ESTRAIBILI



GAMMA COLORI PLASTICHE	ART.
MEDITERRANEAN BLUE	M 20 PLS1 00 00 00 M1
SKY BLUE	M 20 PLS1 00 00 00 M2
GLAMOUR RED	M 20 PLS1 00 00 00 M3
RED CARPET	M 20 PLS1 00 00 00 M4
JUICY ORANGE	M 20 PLS1 00 00 00 M5
SUNNY YELLOW	M 20 PLS1 00 00 00 M6
FOREST GREEN	M 20 PLS1 00 00 00 M7



PIANI ESTRAIBILI AD ESTRAZIONE FLESSIBILE

ART. CON kit plastiche Dark Grey	ART. SENZA kit plastiche*	Dim. utili mm	H frontale mm	kg	
M 23 C057 0110 OF _ _	M 23 C057 0100 OF _ _	447x600	70	50 - 75 - 100	100% - 96% - 92%

* ABBINARE AL CODICE ARTICOLO UNO DEI KIT PLASTICHE DISPONIBILI NELLA TABELLA SOTTOSTANTE



PIANI ESTRAIBILI AD ESTRAZIONE TELESCOPICA

ART. CON kit plastiche Dark Grey	ART. SENZA kit plastiche*	Dim. utili mm	H frontale mm	kg	
M 23 C057 0110 OT _ _	M 23 C057 0100 OT _ _	447x600	70	200	100%

* ABBINARE AL CODICE ARTICOLO UNO DEI KIT PLASTICHE DISPONIBILI NELLA TABELLA SOTTOSTANTE



PIANO REGOLABILE

ART.	Dim. utili mm	H totale mm	kg
M 23 PR25 00 00 01 _ _	504x631	60	70

INSERIBILE DAVANTI ALL'ASTA VERTEBRATA

KIT PLASTICHE PER CASSETTI E PIANI ESTRAIBILI



GAMMA COLORI PLASTICHE	ART.
MEDITERRANEAN BLUE	M 20 PLS1 00 00 00 M1
SKY BLUE	M 20 PLS1 00 00 00 M2
GLAMOUR RED	M 20 PLS1 00 00 00 M3
RED CARPET	M 20 PLS1 00 00 00 M4
JUICY ORANGE	M 20 PLS1 00 00 00 M5
SUNNY YELLOW	M 20 PLS1 00 00 00 M6
FOREST GREEN	M 20 PLS1 00 00 00 M7



ART. M 23 A150 XO 14 NH AE

🔑 PORTE A BATTENTE CON CILINDRO

PORTE A BATTENTE ALTEZZA TOTALE - REVERSIBILE



H ARMADIO mm	TIPO DI CHIUSURA	ART. CON kit plastiche Dark Grey 	ART. SENZA kit plastiche* 
600	 C0 KEY chiusura a cilindro	M 20 P050 C0 10 00 __	M 20 P050 C0 00 00 __
	 C1 KEY chiusura a cilindro	M 20 P050 C1 10 00 __	M 20 P050 C1 00 00 __
	 C2 KEY chiusura a cilindro	M 20 P050 C2 10 00 __	M 20 P050 C2 00 00 __
700	 C0 KEY chiusura a cilindro	M 20 P060 C0 10 00 __	M 20 P060 C0 00 00 __
	 C1 KEY chiusura a cilindro	M 20 P060 C1 10 00 __	M 20 P060 C1 00 00 __
	 C2 KEY chiusura a cilindro	M 20 P060 C2 10 00 __	M 20 P060 C2 00 00 __











* ABBINARE AL CODICE ARTICOLO UNO DEI KIT PLASTICHE DISPONIBILI NELLA TABELLA A DESTRA



LA PORTA DEVE ESSERE ASSOCIATA OBBLIGATORIAMENTE AGLI ARMADI CON LA CHIUSURA:
C5 (SENZA SERRATURA) OPPURE **X0** (SENZA ASTA VERTEBRATA E SENZA SERRATURA)

PORTE A BATTENTE ALTEZZA PARZIALE - REVERSIBILE



H INGOMBRO PORTA mm	TIPO DI CHIUSURA	ART. CON kit plastiche Dark Grey 	ART. SENZA kit plastiche* 
425	 C0 KEY chiusura a cilindro	M 20 P042 C0 10 01 __	M 20 P042 C0 00 01 __
	 C1 KEY chiusura a cilindro	M 20 P042 C1 10 01 __	M 20 P042 C1 00 01 __
	 C2 KEY chiusura a cilindro	M 20 P042 C2 10 01 __	M 20 P042 C2 00 01 __
525	 C0 KEY chiusura a cilindro	M 20 P052 C0 10 01 __	M 20 P052 C0 00 01 __
	 C1 KEY chiusura a cilindro	M 20 P052 C1 10 01 __	M 20 P052 C1 00 01 __
	 C2 KEY chiusura a cilindro	M 20 P052 C2 10 01 __	M 20 P052 C2 00 01 __
625	 C0 KEY chiusura a cilindro	M 20 P062 C0 10 01 __	M 20 P062 C0 00 01 __
	 C1 KEY chiusura a cilindro	M 20 P062 C1 10 01 __	M 20 P062 C1 00 01 __
	 C2 KEY chiusura a cilindro	M 20 P062 C2 10 01 __	M 20 P062 C2 00 01 __

* ABBINARE AL CODICE ARTICOLO UNO DEI KIT PLASTICHE DISPONIBILI NELLA TABELLA A DESTRA

1 2 3 4 5 C

PORTE A BATTENTE CON CODICE NUMERICO



PORTE A BATTENTE ALTEZZA TOTALE - APERTURA SOLO A DESTRA

H ARMADIO mm	TIPO DI CHIUSURA	ART. CON kit plastiche Dark Grey	ART. SENZA kit plastiche*
600	P5 CODE codice numerico	M 20 P050 P5 10 00 __	M 20 P050 P5 00 00 __
700	P5 CODE codice numerico	M 20 P060 P5 10 00 __	M 20 P060 P5 00 00 __

* ABBINARE AL CODICE ARTICOLO UNO DEI KIT PLASTICHE DISPONIBILI NELLA TABELLA SOTTOSTANTE

LA PORTA DEVE ESSERE ASSOCIATA OBBLIGATORIAMENTE AGLI ARMADI CON LA CHIUSURA: **C5** (SENZA SERRATURA) OPPURE **X0** (SENZA ASTA VERTEBRATA E SENZA SERRATURA)

PORTE A BATTENTE ALTEZZA PARZIALE - REVERSIBILE



H INGOMBRO PORTA mm	TIPO DI CHIUSURA	ART. CON kit plastiche Dark Grey	ART. SENZA kit plastiche*
425	A4 maniglia senza tastierino	M 20 P042 A4 10 01 __	M 20 P042 A4 00 01 __
525	A4 maniglia senza tastierino	M 20 P052 A4 10 01 __	M 20 P052 A4 00 01 __
625	A4 maniglia senza tastierino	M 20 P062 A4 10 01 __	M 20 P062 A4 00 01 __

* ABBINARE AL CODICE ARTICOLO UNO DEI KIT PLASTICHE DISPONIBILI NELLA TABELLA SOTTOSTANTE

LA PORTA DEVE ESSERE ASSOCIATA OBBLIGATORIAMENTE AGLI ARMADI CON LE CHIUSURE:
UTILIZZARE LA SERRATURA **T2** PER L'ARMADIO SENZA RUOTE
UTILIZZARE LA SERRATURA **A1** PER L'ARMADIO CON RUOTE

TELECOMANDO



ART.	
M 00 VRCO 00 00 00 00	Modulo ricevitore con telecomando
M 00 VRCO 00 00 01 00	Telecomando aggiuntivo

KIT PLASTICHE PER PORTE A BATTENTE



GAMMA COLORI PLASTICHE	ART. KEY	ART. CODE
MEDITERRANEAN BLUE	M 00 PLS0 00 00 20 M1	M 00 PLS0 00 00 21 M1
SKY BLUE	M 00 PLS0 00 00 20 M2	M 00 PLS0 00 00 21 M2
GLAMOUR RED	M 00 PLS0 00 00 20 M3	M 00 PLS0 00 00 21 M3
RED CARPET	M 00 PLS0 00 00 20 M4	M 00 PLS0 00 00 21 M4
JUICY ORANGE	M 00 PLS0 00 00 20 M5	M 00 PLS0 00 00 21 M5
SUNNY YELLOW	M 00 PLS0 00 00 20 M6	M 00 PLS0 00 00 21 M6
FOREST GREEN	M 00 PLS0 00 00 20 M7	M 00 PLS0 00 00 21 M7



PIANO SUPERIORE A 3 BORDI

ART.	dim. mm	
M 23 T023 AG 00 31 07	561x726x23 H	

Piano rivestito in pvc per ARMADIO SINGOLO. Colore nero



PIANO SUPERIORE A 4 BORDI

ART.	dim. mm	
M 23 T023 AG 00 41 07	561x726x23 H	

Piano rivestito in pvc per ARMADIO SINGOLO. Colore nero



ART. M 00 T023 AG 00 FO 00

FORATURA PIANO SUPERIORE DELL'ARMADIO
PER IL FISSAGGIO DEL PIANO A 4 BORDI



PIANO SUPERIORE IN MULTIPLEX

ART.	dim. mm	
M 23 T040 MU 00 01 00	561x726x40 H	

Per ARMADIO SINGOLO



PIANO SUPERIORE IN MDF DIM. 561x726x32 mm H

ART.	rifiniture	per armadio	
M 23 T030 MD GM 2107	1 profilo laterale	finale dx o sx	

Piano in MDF con copertura in gomma antiolio. Colore nero



PIANO SUPERIORE IN MDF DIM. 561x726x32 mm H

ART.	rifiniture	per armadio	
M 23 T030 MD GM 1107	-	centrale	

Piano in MDF con copertura in gomma antiolio. Colore nero



PIANO SUPERIORE IN MDF DIM. 561x726x32 mm H

ART.	rifiniture	per armadio	
M 23 T030 MD GM 0107	2 profili laterali	singolo	

Piano in MDF con copertura in gomma antiolio. Colore nero



ART. M 00 T030 MD 00 FO 00

FORATURA PIANO SUPERIORE DELL'ARMADIO PER IL FISSAGGIO DEL
PIANO IN MDF E DEL PIANO IN MULTIPLEX
COMPRESIVO DI VITI PER IL FISSAGGIO

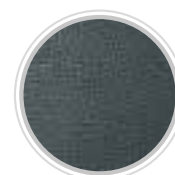

RIFINITURA
GOMMA
ANTIOLIO



APPLICAZIONE
PIANO IN MDF

ZOCCOLO DI RIALZO ALTEZZA 50 mm



ART.		dim. mm	
M 23 Z050 00 00 00 _ _		559x725x50 H	

ZOCCOLO DI RIALZO ALTEZZA 100 mm



ART.		dim. mm	
M 23 Z100 00 00 00 _ _		559x725x100 H	



RUOTA FISSA IN GOMMA STANDARD

ART.	Ø mm	portata armadio kg	C mm
C RG BAC11 100	100	160	128
C RG BAC12 125	125	235	155



RUOTA GIREVOLE CON FRENO IN GOMMA STANDARD

ART.	Ø mm	portata armadio kg	C mm
C RG DAC11 100	100	160	128
C RG DAC12 125	125	235	155



RUOTA FISSA IN NYLON

ART.	Ø mm	portata armadio kg	C mm
C RN BAD10 100	100	310	128
C RN BAD11 125	125	475	155



RUOTA GIREVOLE CON FRENO IN NYLON

ART.	Ø mm	portata armadio kg	C mm
C RN DAD10 100	100	310	128
C RN DAD11 125	125	475	155



RICAMBI - FISSAGGIO

SERRATURA DI RICAMBIO

ART. M 00 CSRO 8800 00 00

Serratura di ricambio con due chiavi



CHIAVE DI RICAMBIO

ART. M 00 CF00 0000 00 00

Specificare sempre il numero indicato nella serratura a cilindro dove si vuole sostituire la chiave



PASSEPARTOUT

ART. M 00 PF.. 0000 00 00

Disponibile in 23 serie, con numerazione da F 01 a F 23.

Passepartout serie F 01
Passepartout serie F 02
Passepartout serie F ..

ART. M 00 PF01 00 00 00 00
ART. M 00 PF02 00 00 00 00
ART. M 00 PF.. 00 00 00 00

SET FISSAGGIO TRA ARMADI

ART. M 00 FISO 00 00 00 99

Set di fissaggio armadio-armadio con 4 viti complete di dadi M8

ART. M 00 SVRO 00 00 00 99

Foratura e viteria per il fissaggio dei due armadi sovrapposti

SET DI FISSAGGIO A PAVIMENTO



ART. F AG 9200 00 99

Coppia staffe zincate per il fissaggio a pavimento dell'armadio

ART. F AG 9204 00 99

2 tasselli "HILTI" adatti per pavimenti in calcestruzzo non fessurato maggiore o uguale alla classe C20/25
Trazione consigliata del tassello: 2,9 kN
Diametro tassello: Ø 6 mm



MANIGLIA DI RICAMBIO

ART. M 00 PLSO 0000 22 MO

Maniglia di ricambio per porte disponibile in colore Dark Grey.



ALTRI COLORI A RICHIESTA



GLI ARMADI DEVONO ESSERE FISSATI A PAVIMENTO O A PARETE
SE SOVRAPPosti DEVONO ESSERE FISSATI OBBLIGATORIAMENTE A PARETE E LA LORO PORTATA DIVISA PER DUE



MASTER

561x726 mm

Born To Be Extreme

ARMADIO VUOTO senza asta vertebrata e senza chiusura



H 400 mm
H utile 300 mm



H 600 mm
H utile 500 mm



H 700 mm
H utile 600 mm



H 800 mm
H utile 700 mm



H 850 mm
H utile 750 mm



M 23 A040 X0 10 00 _ _

M 23 A060 X0 10 00 _ _

M 23 A070 X0 10 00 _ _

M 23 A080 X0 10 00 _ _

M 23 A085 X0 10 00 _ _

ASTA VERTEBRATA



L'asta vertebrata è composta da un profilo in alluminio estruso forato a passo 25 mm per l'inserimento della molla antiribaltamento. L'asta antiribaltamento viene fornita completa di accessori in plastica e struttura superiore predisposta per la chiusura a cilindro o elettronica.

ART.	H utile inserimento cassette mm
M 00 V030 00 00 00 00	300
M 00 V050 00 00 00 00	500
M 00 V060 00 00 00 00	600
M 00 V070 00 00 00 00	700
M 00 V075 00 00 00 00	750
M 00 V090 00 00 00 00	900

ART.	H utile inserimento cassette mm
M 00 V105 00 00 00 00	1050
M 00 V122 00 00 00 00	1225
M 00 V140 00 00 00 00	1400
M 00 V152 00 00 00 00	1525
M 00 V190 00 00 00 00	1900

CHIUSURA CON CILINDRO (KEY)



CHIUSURA A CILINDRO COMPLETA DI:

- 1 serratura a cilindro con 2 chiavi
- 1 filo in acciaio con guaina
- 1 gruppo percussore anteriore
- 1 gruppo cursore posteriore

ART.		
M 23 V000 C0 00 00 00	C0	CHIUSURA A CILINDRO CON NUMERAZIONE DIVERSA
M 23 V000 C1 00 00 00	C1	CHIUSURA A CILINDRO PER GRUPPI DI 160 NUMERI
M 23 V000 C2 00 00 00	C2	CHIUSURA A CILINDRO CON NUMERAZIONE UGUALE

For Experts Only



H 1000 mm
H utile 900 mm



H 1500 mm
H utile 1400 mm



H 2000 mm
H utile 1900 mm



M 23 A100 X0 10 00 __

M 23 A150 X0 10 00 __

M 23 A200 X0 10 00 __

CHIUSURA CON CODICE NUMERICO (CODE)



ART.

M 23 V000 E2 00 00 00

E2

APERTURA/CHIUSURA ASTA (alimentazione a batteria)

M 23 V000 E5 00 00 00

E5

APERTURA/CHIUSURA ASTA (alimentazione da rete elettrica)

M 23 V000 T2 00 00 00

T2

APERTURA/CHIUSURA ASTA + PORTA (alimentazione a batteria)

M 23 V000 T3 00 00 00

T3

APERTURA/CHIUSURA ASTA + PORTA (alimentazione da rete elettrica)

ART. TELECOMANDO

M 00 VRC0 00 00 00 00

Modulo ricevitore
con telecomando

M 00 VRC0 00 00 01 00

Telecomando aggiuntivo



PIANI PER SERRATURE E PIANI REGOLABILI

PIANO SUPERIORE PER SERRATURE



ART.



H frontale mm

kg

M 23 PS46 00 10 00 __

46

150

Dim. mm 510x724x46 H

PIANO INFERIORE PER SERRATURE



ART.



H frontale mm

kg

M 23 PS46 10 10 00 __

46

150

Dim. mm 510x724x46 H

PIANO REGOLABILE



ART.



H totale mm

kg

M 23 PR25 00 00 01 __

60

70

Dim. utili mm 504x631x60 H

PIANO REGOLABILE FESSURATO



ART.



H frontale mm

kg

M 23 PR35 10 00 01 __

35

100

Dim. mm 510x721x35 H

27x36 EH

MATERIALE DI SEPARAZIONE

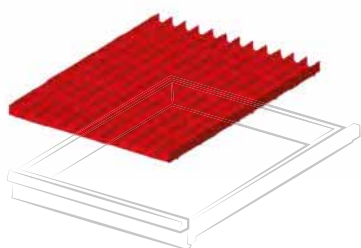

ART. per altezza frontale mm

F FH 8605 01 00 50 - 300

Set composto da: 12 divisori 4 canali, 50 divisori trasversali 36 mm

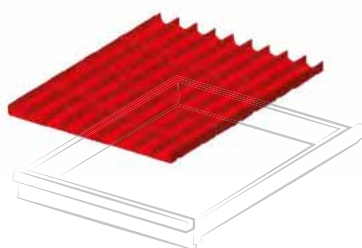

ART. per altezza frontale mm

F FH 8605 06 00 50 - 300

Set composto da: 12 divisori 3 canali, 27 divisori trasversali 47 mm

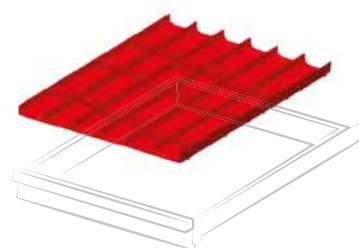

ART. per altezza frontale mm

F FH 8605 04 00 50 - 300

Set composto da: 12 divisori 2 canali, 18 divisori trasversali 73 mm

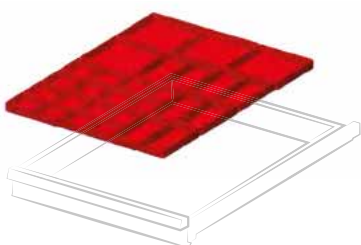

ART. per altezza frontale mm

F FH 8605 17 00 50

F FH 8607 17 00 75

Set composto da: 16 cassette divisorio 75x75 mm, 8 cassette divisorio 150x75 mm, 4 cassette divisorio 150x150 mm

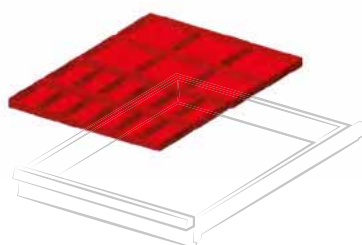

ART. per altezza frontale mm

F FH 8605 18 00 50

F FH 8607 18 00 75

F FH 8610 18 00 100 - 125

Set composto da: 12 cassette divisorio 150x75 mm, 6 cassette divisorio 150x150 mm

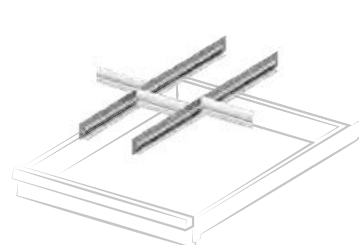

ART. per altezza frontale mm

F FH 8605 08 00 50

F FH 8607 08 00 75

F FH 8610 08 00 100 - 125

F FH 8615 08 00 150

F FH 8620 08 00 200 - 250

F FH 8630 08 00 300

Set composto da: 2 divisori longitudinali fessurati 610 mm, 3 divisori trasversali 149 mm

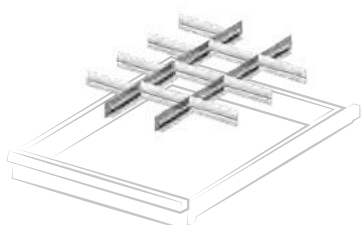

ART. per altezza frontale mm

F FH 8605 09 00 50

F FH 8607 09 00 75

F FH 8610 09 00 100 - 125

F FH 8615 09 00 150

F FH 8620 09 00 200 - 250

Set composto da: 2 divisori longitudinali fessurati 610 mm, 10 divisori trasversali 149 mm

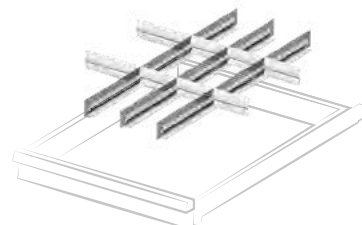

ART. per altezza frontale mm

F FH 8605 10 00 50

F FH 8607 10 00 75

F FH 8610 10 00 100 - 125

F FH 8615 10 00 150

Set composto da: 3 divisori longitudinali fessurati 610 mm, 6 divisori trasversali 98 mm, 2 divisori trasversali 149 mm

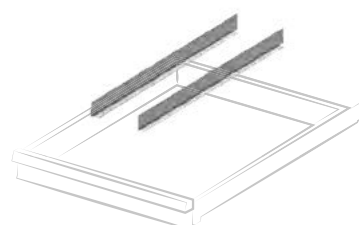

ART. per altezza frontale mm

F FH 8605 13 00 50

F FH 8607 13 00 75

F FH 8610 13 00 100 - 125

F FH 8615 13 00 150

F FH 8620 13 00 200 - 250

F FH 8630 13 00 300

Set composto da: 2 divisori longitudinali non fessurati 610 mm

CONFIGURA IL CASSETTO FAMI CON UTENSILI BETA

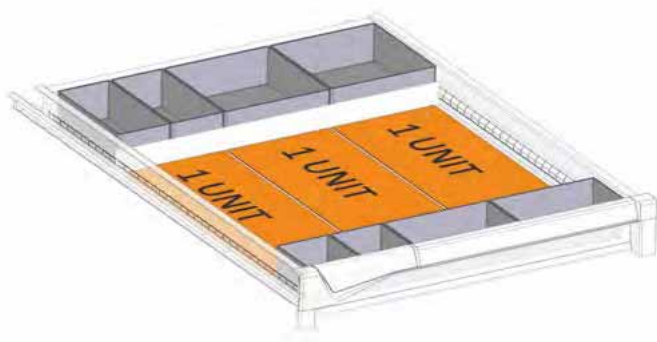

ART. F FH 0907 50 07

Set di predisposizione cassetto per termoformati Beta composto da:

- n. 2 F HC 6071 00 07
- n. 4 F HC 6471 00 07
- n. 2 F HC 6871 00 07
- n. 1 F HA 1120 00 99
- n. 1 F HA 2120 00 99

1 unit = 1 termoformato Beta 367x147 mm





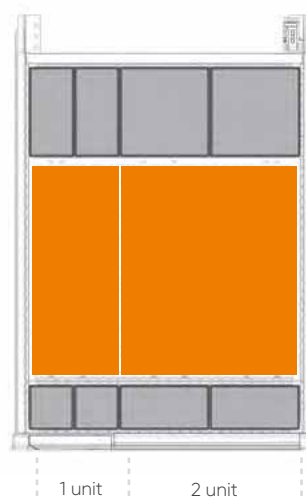
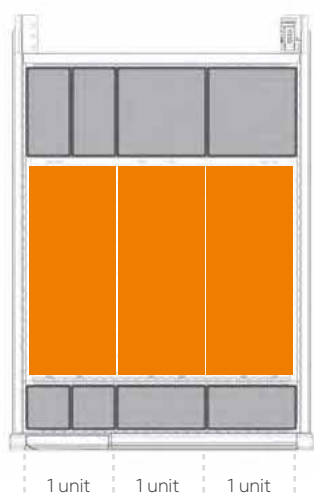

2 unit = 1 termoformato Beta 367x294 mm

ESEMPI DI UTILIZZO TERMOFORMATO











Gamma colori ACCIAIO

	
GRIGIO RAL 7000 .01	VERDE RAL 6011 .02
	
BLU RAL 5012 .04	GRIGIO RAL 7035 .08
	
BIANCO GRIGIASTRO RAL 9002 .1F	ROSSO RUBINO RAL 3003 .1G
	
BLU GENZIANA RAL 5010 .34	BIANCO PURO RAL 9010 .35
	
GRIGIO ANTRACITE RAL 7016 .39	BLU CAPRI RAL 5019 .48



● ART. M 33 A100 C0 10 AW 04
H = 1000 mm - 7 cassetti

Gamma colori PLASTICHE

			
DARK GREY .M0	MEDITERRANEAN BLUE .M1	SKY BLUE .M2	GLAMOUR RED .M3
			
RED CARPET .M4	JUICE ORANGE .M5	SUNNY YELLOW .M6	FOREST GREEN .M7

LEGENDA



PORTATA
CASSETTO/
PIANO



ESTRAZIONE
CASSETTO/
PIANO



CHIUSURA
ARMADIO



LE PORTATE SONO NETTE E SI RIFERISCONO A PESI UNIFORMEMENTE DISTRIBUITI

H 400 mm



ART.				
M 33 A040 C0 10 01 04	50-75-100	100-96-92%		key
M 33 A040 E2 10 01 04	50-75-100	100-96-92%		code

H 700 mm



ART.				
M 33 A070 C0 10 40 04	50-75-100	100-96-92%		key
M 33 A070 C0 10 41 04	200	100%		key
M 33 A070 E2 10 40 04	50-75-100	100-96-92%		code
M 33 A070 E2 10 41 04	200	100%		code

H 700 mm



ART.				
M 33 A070 C0 10 42 04	50-75-100	100-96-92%		key
M 33 A070 C0 10 43 04	200	100%		key
M 33 A070 E2 10 42 04	50-75-100	100-96-92%		code
M 33 A070 E2 10 43 04	200	100%		code

H 800 mm



ART.				
M 33 A080 C0 10 72 04	50-75-100	100-96-92%		key
M 33 A080 C0 10 73 04	200	100%		key
M 33 A080 E2 10 72 04	50-75-100	100-96-92%		code
M 33 A080 E2 10 73 04	200	100%		code

H 800 mm



ART.				
M 33 A080 C0 10 56 04	50-75-100	100-96-92%		key
M 33 A080 C0 10 59 04	200	100%		key
M 33 A080 E2 10 56 04	50-75-100	100-96-92%		code
M 33 A080 E2 10 59 04	200	100%		code

H 850 mm



ART.				
M 33 A085 C010 AC 04		50-75-100	100-96-92%	key
M 33 A085 C010 AD 04		200	100%	key
M 33 A085 E2 10 AC 04		50-75-100	100-96-92%	code
M 33 A085 E2 10 AD 04		200	100%	code

H 850 mm



ART.				
M 33 A085 C010 AG 04		50-75-100	100-96-92%	key
M 33 A085 C010 AH 04		200	100%	key
M 33 A085 E2 10 AG 04		50-75-100	100-96-92%	code
M 33 A085 E2 10 AH 04		200	100%	code

H 1000 mm



ART.				
M 33 A100 C0 10 BE 04		50-75-100	100-96-92%	key
M 33 A100 C0 10 BF 04		200	100%	key
M 33 A100 E2 10 BE 04		50-75-100	100-96-92%	code
M 33 A100 E2 10 BF 04		200	100%	code

H 1000 mm



ART.				
M 33 A100 C010 CQ 04		50-75-100	100-96-92%	key
M 33 A100 C010 CR 04		200	100%	key
M 33 A100 E2 10 CQ 04		50-75-100	100-96-92%	code
M 33 A100 E2 10 CR 04		200	100%	code

H 1000 mm



H 1000 mm



ART.		kg			
● M 33 A100 C0 10 AW 04		50-75-100	100-96-92%	key	
M 33 A100 C0 10 BH 04		200	100%	key	
M 33 A100 E2 10 AW 04		50-75-100	100-96-92%	code	
M 33 A100 E2 10 BH 04		200	100%	code	

ART.		kg			
M 33 A100 C0 10 CN 04		50-75-100	100-96-92%	key	
M 33 A100 C0 10 CP 04		200	100%	key	
M 33 A100 E2 10 CN 04		50-75-100	100-96-92%	code	
M 33 A100 E2 10 CP 04		200	100%	code	

H 1000 mm



H 1000 mm



ART.		kg			
M 33 A100 C0 10 BL 04		50-75-100	100-96-92%	key	
M 33 A100 C0 10 BM 04		200	100%	key	
M 33 A100 E2 10 BL 04		50-75-100	100-96-92%	code	
M 33 A100 E2 10 BM 04		200	100%	code	

ART.		kg			
M 33 A100 C0 10 DR 04		50-75-100	100-96-92%	key	
M 33 A100 C0 10 DS 04		200	100%	key	
M 33 A100 E2 10 DR 04		50-75-100	100-96-92%	code	
M 33 A100 E2 10 DS 04		200	100%	code	

MASTER





H 1023 mm



porta 900 mm

ART.				
M 33 A100 C0 10 LJ 04		50-75-100	100-96-92%	key
M 33 A100 C0 10 LK 04		200	100%	key
M 33 A100 P5 10 LJ 04		50-75-100	100-96-92%	code
M 33 A100 P5 10 LK 04		200	100%	code

H 1023 mm



porta 775 mm

ART.				
M 33 A100 C0 10 LR 04		50-75-100	100-96-92%	key
M 33 A100 C0 10 LS 04		200	100%	key
M 33 A100 T2 10 LR 04		50-75-100	100-96-92%	code
M 33 A100 T2 10 LS 04		200	100%	code



H 1500 mm



H 1500 mm



ART.		kg		
M 33 A150 C0 10 FJ 04		50-75-100	100-96-92%	key
M 33 A150 C0 10 FK 04		200	100%	key
M 33 A150 E2 10 FJ 04		50-75-100	100-96-92%	code
M 33 A150 E2 10 FK 04		200	100%	code

ART.		kg		
M 33 A150 C0 10 LC 04		50-75-100	100-96-92%	key
M 33 A150 C0 10 LD 04		200	100%	key
M 33 A150 P5 10 LC 04		50-75-100	100-96-92%	code
M 33 A150 P5 10 LD 04		200	100%	code

H 2000 mm



H 2000 mm



ART.		kg		
M 33 A200 C5 10 FU 04		50-75-100	100-96-92%	-
M 33 A200 C5 10 FV 04		200	100%	-

ART.		kg		
M 33 A200 C0 10 FS 04		50-75-100	100-96-92%	key
M 33 A200 C0 10 FT 04		200	100%	key
M 33 A200 E2 10 FS 04		50-75-100	100-96-92%	code
M 33 A200 E2 10 FT 04		200	100%	code

H 2000 mm



porta 900 mm

ART.				
M33A200C010 FY 04		50-75-100	100-96-92%	key
M 33 A200 C0 10 FZ 04		200	100%	key
M 33 A200 T2 10 FY 04		50-75-100	100-96-92%	code
M 33 A200 T2 10 FZ 04		200	100%	code

H 2000 mm



porta 1900 mm

ART.				
M33A200C010 FW 04		50-75-100	100-96-92%	key
M 33 A200 C0 10 FX 04		200	100%	key
M 33 A200 P5 10 FW 04		50-75-100	100-96-92%	code
M 33 A200 P5 10 FX 04		200	100%	code



ART. M 33 D100 C0 10 NN NQ

H 873 mm



porta singola - profondità 751 mm

ART.		kg			
M33D085C010 GJ04		50-75-100	100-96-92%	key	
M33D085C010 GK04		200	100%	key	

H 873 mm



porta doppia

ART.		kg			
M33D085C010 GL04		50-75-100	100-96-92%	key	
M33D085C010 GM04		200	100%	key	

H 1023 mm



porta singola - profondità 751 mm

ART.		kg			
M33D100C010 GQ04		50-75-100	100-96-92%	key	
M33D100C010 GR04		200	100%	key	

H 1023 mm



porta doppia

ART.		kg			
M33D100C010 GW04		50-75-100	100-96-92%	key	
M33D100C010 GX04		200	100%	key	

H 1023 mm



porta doppia

ART.		kg			
M33D100C010 HC04		50-75-100	100-96-92%	key	
M33D100C010 HD04		200	100%	key	

H 1023 mm



porta doppia

ART.		kg			
M33D100C010 HQ04		50-75-100	100-96-92%	key	
M33D100C010 HR04		200	100%	key	

H 1500 mm



porta doppia

ART.				
M 33 D150 C010 JE 04		50-75-100	100-96-92%	key
M 33 D150 C010 JF 04		200	100%	key

H 2000 mm



porta doppia

ART.				
M 33 D200 C010 JJ 04		50-75-100	100-96-92%	key
M 33 D200 C010 JK 04		200	100%	key



ART. M 33 A100 E2 12 NY FD



ART. M 33 R080 P2 10 NK 1G

H 918 mm



H 918 mm



ART.		kg		
M 33 R070 S0 10 40 04		50-75-100	100-96-92%	key
M 33 R070 P2 10 40 04		50-75-100	100-96-92%	code

Portata armadio 400 kg - Altezza armadio senza ruote mm 763

ART.		kg		
M 33 R070 S0 10 44 04		50-75-100	100-96-92%	key
M 33 R070 P2 10 44 04		50-75-100	100-96-92%	code

Portata armadio 400 kg - Altezza armadio senza ruote mm 763

H 1018 mm



H 1018 mm



ART.		kg		
M 33 R080 S0 10 72 04		50-75-100	100-96-92%	key
M 33 R080 P2 10 72 04		50-75-100	100-96-92%	code

Portata armadio 400 kg - Altezza armadio senza ruote mm 863

ART.		kg		
M 33 R080 S0 10 56 04		50-75-100	100-96-92%	key
M 33 R080 P2 10 56 04		50-75-100	100-96-92%	code

Portata armadio 400 kg - Altezza armadio senza ruote mm 863



2 ruote girevoli con freno in gomma elastica Ø 125 mm
2 ruote fisse in gomma elastica Ø 125 mm

H 1068 mm



ART.				
M 33 R085 S0 10 AE 04		50-75-100	100-96-92%	key
M 33 R085 P2 10 AE 04		50-75-100	100-96-92%	code

Portata armadio 400 kg - Altezza armadio senza ruote mm 913

H 1068 mm



ART.				
M 33 R085 S0 10 AC 04		50-75-100	100-96-92%	key
M 33 R085 P2 10 AC 04		50-75-100	100-96-92%	code

Portata armadio 400 kg - Altezza armadio senza ruote mm 913

H 1218 mm



ART.				
M 33 R100 S0 10 DB 04		50-75-100	100-96-92%	key
M 33 R100 P2 10 DB 04		50-75-100	100-96-92%	code

Portata armadio 400 kg - Altezza armadio senza ruote mm 1063

H 1218 mm



ART.				
M 33 R100 S0 10 AW 04		50-75-100	100-96-92%	key
M 33 R100 P2 10 AW 04		50-75-100	100-96-92%	code

Portata armadio 400 kg - Altezza armadio senza ruote mm 1063



2 ruote girevoli con freno in gomma elastica Ø 125 mm
2 ruote fisse in gomma elastica Ø 125 mm



ART. M 33 R080 P2 10 NK 1G

CONFIGURA IL TUO ARMADIO

	SCEGLI l'altezza	SCEGLI la chiusura		SCEGLI il colore
M33	A040	C5	10 00	01

ARMADIO VUOTO



Portata corpo
armadio 3100 kg

	ALTEZZA	CHIUSURA		COLORE
M33	A040 400 mm (utile 300 mm)	X0 senza asta e senza serratura	10 00	01 RAL 7000
	A070 700 mm (utile 600 mm)	C5* senza serratura		02 RAL 6011
	A080 800 mm (utile 700 mm)	C0* KEY chiusura a cilindro		1G RAL 3003
	A085 850 mm (utile 750 mm)	C1* KEY chiusura a cilindro		1F RAL 9002
	A100 1000 mm (utile 900 mm)	C2* KEY chiusura a cilindro		48 RAL 5019
	A115 1150 mm (utile 1050 mm)	E2* CODE codice numerico		39 RAL 7016
	A132 1325 mm (utile 1225 mm)	T2* CODE codice numerico		04 RAL 5012
	A150 1500 mm (utile 1400 mm)			08 RAL 7035
	A162 1625 mm (utile 1525 mm)			35 RAL 9010
	A200 2000 mm (utile 1900 mm)			34 RAL 5010

*COMPLETA DI ASTA VERTEBRATA

ARMADIO VUOTO predisposto per ruote



	ALTEZZA	CHIUSURA		COLORE
M33	R070 763 mm (utile 600 mm)	S0 KEY chiusura a cilindro	10 00	01 RAL 7000
	R080 863 mm (utile 700 mm)	S1 KEY chiusura a cilindro		02 RAL 6011
	R085 913 mm (utile 750 mm)	S2 KEY chiusura a cilindro		1G RAL 3003
	R100 1063 mm (utile 900 mm)	P2 CODE codice numerico		1F RAL 9002
		A1 CODE codice numerico		48 RAL 5019
				39 RAL 7016
		04 RAL 5012		
		08 RAL 7035		
		35 RAL 9010		
		34 RAL 5010		

COMPLETO DI ASTA VERTEBRATA, PIANO A 4 BORDI CON COPERTURA IN PVC, COPPIA MANIGLIE, COPPIA PIASTRE
Dim. ingombro mm 740x800



CASSETTI AD ESTRAZIONE FLESSIBILE

ART. CON kit plastiche Dark Grey	ART. SENZA kit plastiche*	Dim. utili mm	H frontale mm	kg	
M 33 C050 0110 OF __	M 33 C050 01 00 OF __	600x600x31 H	50	50 - 75 - 100	100% - 96% - 92%
M 33 C075 0110 OF __	M 33 C075 01 00 OF __	600x600x56 H	75	50 - 75 - 100	100% - 96% - 92%
M 33 C100 0110 OF __	M 33 C100 01 00 OF __	600x600x81 H	100	50 - 75 - 100	100% - 96% - 92%
M 33 C125 0110 OF __	M 33 C125 01 00 OF __	600x600x106 H	125	50 - 75 - 100	100% - 96% - 92%
M 33 C150 0110 OF __	M 33 C150 01 00 OF __	600x600x131 H	150	50 - 75 - 100	100% - 96% - 92%
M 33 C200 0110 OF __	M 33 C200 01 00 OF __	600x600x181 H	200	50 - 75 - 100	100% - 96% - 92%
M 33 C250 0110 OF __	M 33 C250 01 00 OF __	600x600x231 H	250	50 - 75 - 100	100% - 96% - 92%
M 33 C300 0110 OF __	M 33 C300 01 00 OF __	600x600x281 H	300	50 - 75 - 100	100% - 96% - 92%

* ABBINARE AL CODICE ARTICOLO UNO DEI KIT PLASTICHE DISPONIBILI NELLA TABELLA SOTTOSTANTE



CASSETTI AD ESTRAZIONE TELESCOPICA

ART. CON kit plastiche Dark Grey	ART. SENZA kit plastiche*	Dim. utili mm	H frontale mm	kg	
M 33 C075 0110 OT __	M 33 C075 01 00 OT __	600x600x56 H	75	200	100%
M 33 C100 0110 OT __	M 33 C100 01 00 OT __	600x600x81 H	100	200	100%
M 33 C125 0110 OT __	M 33 C125 01 00 OT __	600x600x106 H	125	200	100%
M 33 C150 0110 OT __	M 33 C150 01 00 OT __	600x600x131 H	150	200	100%
M 33 C200 0110 OT __	M 33 C200 01 00 OT __	600x600x181 H	200	200	100%
M 33 C250 0110 OT __	M 33 C250 01 00 OT __	600x600x231 H	250	200	100%
M 33 C300 0110 OT __	M 33 C300 01 00 OT __	600x600x281 H	300	200	100%

* ABBINARE AL CODICE ARTICOLO UNO DEI KIT PLASTICHE DISPONIBILI NELLA TABELLA SOTTOSTANTE

KIT PLASTICHE PER CASSETTI E PIANI ESTRAIBILI



GAMMA COLORI PLASTICHE	ART.
MEDITERRANEAN BLUE	M 30 PLS1 00 00 00 M1
SKY BLUE	M 30 PLS1 00 00 00 M2
GLAMOUR RED	M 30 PLS1 00 00 00 M3
RED CARPET	M 30 PLS1 00 00 00 M4
JUICY ORANGE	M 30 PLS1 00 00 00 M5
SUNNY YELLOW	M 30 PLS1 00 00 00 M6
FOREST GREEN	M 30 PLS1 00 00 00 M7



PIANI ESTRAIBILI AD ESTRAZIONE FLESSIBILE

ART. CON kit plastiche Dark Grey	ART. SENZA kit plastiche*	Dim. utili mm	H frontale mm	kg	
M 33 C057 0110 OF __	M 33 C057 0100 OF __	600x600	70	50 - 75 - 100	100% - 96% - 92%

* ABBINARE AL CODICE ARTICOLO UNO DEI KIT PLASTICHE DISPONIBILI NELLA TABELLA SOTTOSTANTE



PIANI ESTRAIBILI AD ESTRAZIONE TELESCOPICA

ART. CON kit plastiche Dark Grey	ART. SENZA kit plastiche*	Dim. utili mm	H frontale mm	kg	
M 33 C057 0110 OT __	M 33 C057 0100 OT __	600x600	70	200	100%

* ABBINARE AL CODICE ARTICOLO UNO DEI KIT PLASTICHE DISPONIBILI NELLA TABELLA SOTTOSTANTE



PIANO REGOLABILE

ART.	Dim. utili mm	H totale mm	kg
M 33 PR25 00 00 01 __	657x631	60	150

INSERIBILE DAVANTI ALL'ASTA VERTEBRATA

KIT PLASTICHE PER CASSETTI E PIANI ESTRAIBILI



GAMMA COLORI PLASTICHE	ART.
MEDITERRANEAN BLUE	M 30 PLS1 00 00 00 M1
SKY BLUE	M 30 PLS1 00 00 00 M2
GLAMOUR RED	M 30 PLS1 00 00 00 M3
RED CARPET	M 30 PLS1 00 00 00 M4
JUICY ORANGE	M 30 PLS1 00 00 00 M5
SUNNY YELLOW	M 30 PLS1 00 00 00 M6
FOREST GREEN	M 30 PLS1 00 00 00 M7



PORTE A BATTENTE CON CILINDRO

PORTE A BATTENTE ALTEZZA TOTALE - REVERSIBILE















H ARMADIO mm	TIPO DI CHIUSURA	ART. CON kit plastiche Dark Grey 	ART. SENZA kit plastiche* 
600	 C0 KEY chiusura a cilindro	M 30 P050 C0 10 00 __	M 30 P050 C0 00 00 __
	 C1 KEY chiusura a cilindro	M 30 P050 C1 10 00 __	M 30 P050 C1 00 00 __
	 C2 KEY chiusura a cilindro	M 30 P050 C2 10 00 __	M 30 P050 C2 00 00 __
700	 C0 KEY chiusura a cilindro	M 30 P060 C0 10 00 __	M 30 P060 C0 00 00 __
	 C1 KEY chiusura a cilindro	M 30 P060 C1 10 00 __	M 30 P060 C1 00 00 __
	 C2 KEY chiusura a cilindro	M 30 P060 C2 10 00 __	M 30 P060 C2 00 00 __

* ABBINARE AL CODICE ARTICOLO UNO DEI KIT PLASTICHE DISPONIBILI NELLA TABELLA A DESTRA

COPPIA PORTE A BATTENTE ALTEZZA TOTALE



850	 C0 KEY chiusura a cilindro	M 30 P075 C0 10 10 __	M 30 P075 C0 00 10 __
	 C1 KEY chiusura a cilindro	M 30 P075 C1 10 10 __	M 30 P075 C1 00 10 __
	 C2 KEY chiusura a cilindro	M 30 P075 C2 10 10 __	M 30 P075 C2 00 10 __
1000	 C0 KEY chiusura a cilindro	M 30 P090 C0 10 10 __	M 30 P090 C0 00 10 __
	 C1 KEY chiusura a cilindro	M 30 P090 C1 10 10 __	M 30 P090 C1 00 10 __
	 C2 KEY chiusura a cilindro	M 30 P090 C2 10 10 __	M 30 P090 C2 00 10 __
1500	 C0 KEY chiusura a cilindro	M 30 P140 C0 10 10 __	M 30 P140 C0 00 10 __
	 C1 KEY chiusura a cilindro	M 30 P140 C1 10 10 __	M 30 P140 C1 00 10 __
	 C2 KEY chiusura a cilindro	M 30 P140 C2 10 10 __	M 30 P140 C2 00 10 __
2000	 C0 KEY chiusura a cilindro	M 30 P190 C0 10 10 __	M 30 P190 C0 00 10 __
	 C1 KEY chiusura a cilindro	M 30 P190 C1 10 10 __	M 30 P190 C1 00 10 __
	 C2 KEY chiusura a cilindro	M 30 P190 C2 10 10 __	M 30 P190 C2 00 10 __

* ABBINARE AL CODICE ARTICOLO UNO DEI KIT PLASTICHE DISPONIBILI NELLA TABELLA A DESTRA



LA PORTA E LA COPPIA PORTE DEVONO ESSERE ASSOCIATE OBBLIGATORIAMENTE AGLI ARMADI CON LA CHIUSURA: **C5** (SENZA SERRATURA) OPPURE **X0** (SENZA ASTA VERTEBRATA E SENZA SERRATURA)

PORTE A BATTENTE ALTEZZA PARZIALE - REVERSIBILE



H INGOMBRO PORTA mm	TIPO DI CHIUSURA	ART. CON kit plastiche Dark Grey	ART. SENZA kit plastiche*
425	C0 KEY chiusura a cilindro	M 30 P042 C0 10 01 __	M 30 P042 C0 00 01 __
	C1 KEY chiusura a cilindro	M 30 P042 C1 10 01 __	M 30 P042 C1 00 01 __
	C2 KEY chiusura a cilindro	M 30 P042 C2 10 01 __	M 30 P042 C2 00 01 __
525	C0 KEY chiusura a cilindro	M 30 P052 C0 10 01 __	M 30 P052 C0 00 01 __
	C1 KEY chiusura a cilindro	M 30 P052 C1 10 01 __	M 30 P052 C1 00 01 __
	C2 KEY chiusura a cilindro	M 30 P052 C2 10 01 __	M 30 P052 C2 00 01 __
625	C0 KEY chiusura a cilindro	M 30 P062 C0 10 01 __	M 30 P062 C0 00 01 __
	C1 KEY chiusura a cilindro	M 30 P062 C1 10 01 __	M 30 P062 C1 00 01 __
	C2 KEY chiusura a cilindro	M 30 P062 C2 10 01 __	M 30 P062 C2 00 01 __

* ABBINARE AL CODICE ARTICOLO UNO DEI KIT PLASTICHE DISPONIBILI NELLA TABELLA SOTTOSTANTE

COPPIA PORTE A BATTENTE ALTEZZA PARZIALE



775	C0 KEY chiusura a cilindro	M 30 P077 C0 10 11 __	M 30 P077 C0 00 11 __
	C1 KEY chiusura a cilindro	M 30 P077 C1 10 11 __	M 30 P077 C1 00 11 __
	C2 KEY chiusura a cilindro	M 30 P077 C2 10 11 __	M 30 P077 C2 00 11 __

* ABBINARE AL CODICE ARTICOLO UNO DEI KIT PLASTICHE DISPONIBILI NELLA TABELLA SOTTOSTANTE

KIT PLASTICHE PER PORTA SINGOLA E COPPIA PORTE



GAMMA COLORI PLASTICHE	ART. per porta singola	ART. per coppia porte
MEDITERRANEAN BLUE	M 00 PLS0 00 00 20 M1	M 00 PLS0 00 00 30 M1
SKY BLUE	M 00 PLS0 00 00 20 M2	M 00 PLS0 00 00 30 M2
GLAMOUR RED	M 00 PLS0 00 00 20 M3	M 00 PLS0 00 00 30 M3
RED CARPET	M 00 PLS0 00 00 20 M4	M 00 PLS0 00 00 30 M4
JUICY ORANGE	M 00 PLS0 00 00 20 M5	M 00 PLS0 00 00 30 M5
SUNNY YELLOW	M 00 PLS0 00 00 20 M6	M 00 PLS0 00 00 30 M6
FOREST GREEN	M 00 PLS0 00 00 20 M7	M 00 PLS0 00 00 30 M7



PORTE A BATTENTE CON CODICE NUMERICO



PORTE A BATTENTE ALTEZZA TOTALE - APERTURA SOLO A DESTRA

H ARMADIO mm	TIPO DI CHIUSURA	ART. CON kit plastiche Dark Grey	ART. SENZA kit plastiche*
600	P5 CODE codice numerico	M 30 P050 P5 10 00 _ _	M 30 P050 P5 00 00 _ _
700	P5 CODE codice numerico	M 30 P060 P5 10 00 _ _	M 30 P060 P5 00 00 _ _

* ABBINARE AL CODICE ARTICOLO UNO DEI KIT PLASTICHE DISPONIBILI NELLA TABELLA SOTTOSTANTE

COPPIA PORTE A BATTENTE ALTEZZA TOTALE



H ARMADIO mm	TIPO DI CHIUSURA	ART. CON kit plastiche Dark Grey	ART. SENZA kit plastiche*
850	P5 CODE codice numerico	M 30 P075 P5 10 10 _ _	M 30 P075 P5 00 10 _ _
1000	P5 CODE codice numerico	M 30 P090 P5 10 10 _ _	M 30 P090 P5 00 10 _ _
1500	P5 CODE codice numerico	M 30 P140 P5 10 10 _ _	M 30 P140 P5 00 10 _ _
2000	P5 CODE codice numerico	M 30 P190 P5 10 10 _ _	M 30 P190 P5 00 10 _ _

* ABBINARE AL CODICE ARTICOLO UNO DEI KIT PLASTICHE DISPONIBILI NELLA TABELLA SOTTOSTANTE



LA PORTA E LA COPPIA PORTE DEVONO ESSERE ASSOCIATE OBBLIGATORIAMENTE AGLI ARMADI CON LA CHIUSURA:

C5 (SENZA SERRATURA) OPPURE **X0** (SENZA ASTA VERTEBRATA E SENZA SERRATURA)

KIT PLASTICHE PER PORTA SINGOLA E COPPIA PORTE



GAMMA COLORI PLASTICHE	ART. per porta singola	ART. per coppia porte
MEDITERRANEAN BLUE	M 00 PLS0 00 00 21 M1	M 00 PLS0 00 00 31 M1
SKY BLUE	M 00 PLS0 00 00 21 M2	M 00 PLS0 00 00 31 M2
GLAMOUR RED	M 00 PLS0 00 00 21 M3	M 00 PLS0 00 00 31 M3
RED CARPET	M 00 PLS0 00 00 21 M4	M 00 PLS0 00 00 31 M4
JUICY ORANGE	M 00 PLS0 00 00 21 M5	M 00 PLS0 00 00 31 M5
SUNNY YELLOW	M 00 PLS0 00 00 21 M6	M 00 PLS0 00 00 31 M6
FOREST GREEN	M 00 PLS0 00 00 21 M7	M 00 PLS0 00 00 31 M7

PORTE A BATTENTE ALTEZZA PARZIALE - REVERSIBILE



H INGOMBRO PORTA mm	TIPO DI CHIUSURA	ART. CON kit plastiche Dark Grey	ART. SENZA kit plastiche*
425	A4 maniglia senza tastierino	M 30 P042 A4 10 01 _ _	M 30 P042 A4 00 01 _ _
525	A4 maniglia senza tastierino	M 30 P052 A4 10 01 _ _	M 30 P052 A4 00 01 _ _
625	A4 maniglia senza tastierino	M 30 P062 A4 10 01 _ _	M 30 P062 A4 00 01 _ _

* ABBINARE AL CODICE ARTICOLO UNO DEI KIT PLASTICHE DISPONIBILI NELLA TABELLA A SINISTRA

COPPIA PORTE A BATTENTE ALTEZZA PARZIALE



H INGOMBRO PORTA mm	TIPO DI CHIUSURA	ART. CON kit plastiche Dark Grey	ART. SENZA kit plastiche*
775	A4 maniglia senza tastierino	M 30 P077 A4 10 11 _ _	M 30 P077 A4 00 11 _ _

* ABBINARE AL CODICE ARTICOLO UNO DEI KIT PLASTICHE DISPONIBILI NELLA TABELLA A SINISTRA



LA PORTA E LA COPPIA PORTE DEVONO ESSERE ASSOCIATE OBBLIGATORIAMENTE AGLI ARMADIO CON LE CHIUSURE:

UTILIZZARE LA SERRATURA **T2** PER L'ARMADIO SENZA RUOTE

UTILIZZARE LA SERRATURA **A1** PER L'ARMADIO CON RUOTE

TELECOMANDO



ART.	
M 00 VRC0 00 00 00 00	Modulo ricevitore con telecomando
M 00 VRC0 00 00 01 00	Telecomando aggiuntivo

















ARMADIO VUOTO



CON 2 PORTE SCORREVOLI

ARMADIO CON DOPPIA PORTA SCORREVOLE SENZA ASTA VERTEBRATA

H ARMADIO mm	TIPO DI CHIUSURA	ART. CON kit plastiche Dark Grey 	ART. SENZA kit plastiche* 
850 (utile 750 mm)	 C0 KEY chiusura a cilindro	M 33 D085 C0 10 0D __	M 33 D085 C0 00 0D __
	 C1 KEY chiusura a cilindro	M 33 D085 C1 10 0D __	M 33 D085 C1 00 0D __
	 C2 KEY chiusura a cilindro	M 33 D085 C2 10 0D __	M 33 D085 C2 00 0D __
1000 (utile 900 mm)	 C0 KEY chiusura a cilindro	M 33 D100 C0 10 0D __	M 33 D100 C0 00 0D __
	 C1 KEY chiusura a cilindro	M 33 D100 C1 10 0D __	M 33 D100 C1 00 0D __
	 C2 KEY chiusura a cilindro	M 33 D100 C2 10 0D __	M 33 D100 C2 00 0D __
1500 (utile 1400 mm)	 C0 KEY chiusura a cilindro	M 33 D150 C0 10 0D __	M 33 D150 C0 00 0D __
	 C1 KEY chiusura a cilindro	M 33 D150 C1 10 0D __	M 33 D150 C1 00 0D __
	 C2 KEY chiusura a cilindro	M 33 D150 C2 10 0D __	M 33 D150 C2 00 0D __
2000 (utile 1900 mm)	 C0 KEY chiusura a cilindro	M 33 D200 C0 10 0D __	M 33 D200 C0 00 0D __
	 C1 KEY chiusura a cilindro	M 33 D200 C1 10 0D __	M 33 D200 C1 00 0D __
	 C2 KEY chiusura a cilindro	M 33 D200 C2 10 0D __	M 33 D200 C2 00 0D __

* ABBINARE AL CODICE ARTICOLO UNO DEI KIT PLASTICHE DISPONIBILI NELLA TABELLA SOTTOSTANTE

KIT PLASTICHE PER PORTE SCORREVOLI



GAMMA COLORI PLASTICHE	ART. 2 PORTE SCORREVOLI	ART. 1 PORTA SCORREVOLE
 MEDITERRANEAN BLUE	M 00 PLS0 00 00 50 M1	M 00 PLS0 00 00 40 M1
 SKY BLUE	M 00 PLS0 00 00 50 M2	M 00 PLS0 00 00 40 M2
 GLAMOUR RED	M 00 PLS0 00 00 50 M3	M 00 PLS0 00 00 40 M3
 RED CARPET	M 00 PLS0 00 00 50 M4	M 00 PLS0 00 00 40 M4
 JUICY ORANGE	M 00 PLS0 00 00 50 M5	M 00 PLS0 00 00 40 M5
 SUNNY YELLOW	M 00 PLS0 00 00 50 M6	M 00 PLS0 00 00 40 M6
 FOREST GREEN	M 00 PLS0 00 00 50 M7	M 00 PLS0 00 00 40 M7

ARMADIO VUOTO

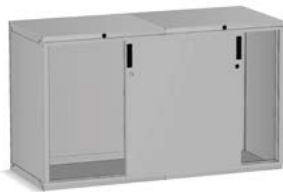

CON 1 PORTA SCORREVOLE

ARMADIO CON PORTA SCORREVOLE SINGOLA SENZA ASTA VERTEBRATA

H ARMADIO mm	TIPO DI CHIUSURA	ART. CON kit plastiche Dark Grey	ART. SENZA kit plastiche*
850 (utile 750 mm)	C0 KEY chiusura a cilindro	M 33 D085 C0 10 OS __	M 33 D085 C0 00 OS __
	C1 KEY chiusura a cilindro	M 33 D085 C1 10 OS __	M 33 D085 C1 00 OS __
	C2 KEY chiusura a cilindro	M 33 D085 C2 10 OS __	M 33 D085 C2 00 OS __
1000 (utile 900 mm)	C0 KEY chiusura a cilindro	M 33 D100 C0 10 OS __	M 33 D100 C0 00 OS __
	C1 KEY chiusura a cilindro	M 33 D100 C1 10 OS __	M 33 D100 C1 00 OS __
	C2 KEY chiusura a cilindro	M 33 D100 C2 10 OS __	M 33 D100 C2 00 OS __

* ABBINARE AL CODICE ARTICOLO UNO DEI KIT PLASTICHE DISPONIBILI NELLA TABELLA A SINISTRA



PORTA SINGOLA con chiusura SOLO a dx. Solo il vano di sinistra è predisposto per l'inserimento di cassetti e piani estraibili. OBBLIGO di inserimento dell'asta vertebrata in presenza di PIÙ DI 2 CASSETTI/PIANI ESTRAIBILI per vano.



CHIUSURA A CILINDRO

TIPO DI CHIUSURA	ART.
C0 KEY chiusura a cilindro	M 33 V000 C0 00 00 00
C1 KEY chiusura a cilindro	M 33 V000 C1 00 00 00
C2 KEY chiusura a cilindro	M 33 V000 C2 00 00 00

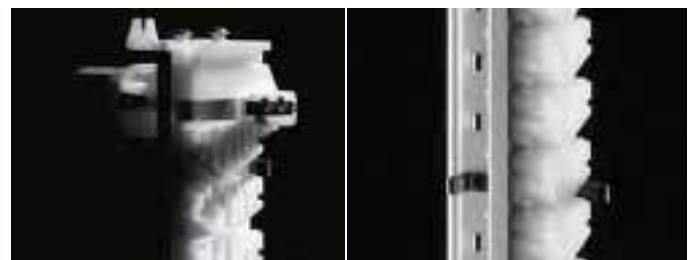

ASTA VERTEBRATA

H UTILE INSERIMENTO CASSETTI mm	ART.
750	M 00 V075 00 00 00 00
900	M 00 V090 00 00 00 00
1400	M 00 V140 00 00 00 00
1900	M 00 V190 00 00 00 00



PIANO SUPERIORE A 3 BORDI

ART.	dim. mm	
M 33 T023 AG 00 31 07	714x726x23 H	

Piano rivestito in pvc per ARMADIO SINGOLO. Colore nero

PIANO SUPERIORE A 3 BORDI

ART.	dim. mm	
M 33 T023 AG 00 32 07	1428x726x23 H	

Piano rivestito in pvc per ARMADIO DOPPIO. Colore nero



PIANO SUPERIORE A 4 BORDI

ART.	dim. mm	
M 33 T023 AG 00 41 07	714x726x23 H	

Piano rivestito in pvc per ARMADIO SINGOLO. Colore nero



ART. M 00 T023 AG 00 FO 00
FORATURA PIANO SUPERIORE DELL'ARMADIO
PER IL FISSAGGIO DEL PIANO A 4 BORDI



PIANO SUPERIORE IN MULTIPLEX

ART.	dim. mm	
M 33 T040 MU 00 01 00	714x726x40 H	

Per ARMADIO SINGOLO



PIANO SUPERIORE IN MDF DIM. 714x726x32 mm H

ART.	rifiniture	per armadio	
M 33 T030 MD GM 21 07	1 profilo laterale	finale dx o sx	

Piano in MDF con copertura in gomma antiolio. Colore nero



PIANO SUPERIORE IN MDF DIM. 714x726x32 mm H

ART.	rifiniture	per armadio	
M 33 T030 MD GM 11 07	-	centrale	

Piano in MDF con copertura in gomma antiolio. Colore nero



PIANO SUPERIORE IN MDF DIM. 714x726x32 mm H

ART.	rifiniture	per armadio	
M 33 T030 MD GM 01 07	2 profili laterali	singolo	

Piano in MDF con copertura in gomma antiolio. Colore nero



ART. M 00 T030 MD 00 FO 00
FORATURA PIANO SUPERIORE DELL'ARMADIO PER IL FISSAGGIO
DEL PIANO IN MDF E DEL PIANO IN MULTIPLEX
COMPRESIVO DI VITI PER IL FISSAGGIO

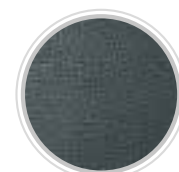

**RIFINITURA
GOMMA
ANTIOLIO**



**APPLICAZIONE
PIANO IN MDF**



PANNELLO FORATO

ART.		dim. mm	
M 30 PA71 00 00 00 04		708x65x718 H	

ESEMPI DI PANNELLO FORATO CON GANCI/VISUAL BOX



2 ART. FAXVBCH00600001
1 ART. F BL 9541 00 00 (10 pz.)
1 ART. C MV 10 019



2 ART. FAXVBCH00900001
2 ART. FAXVBCH00600001
2 ART. FAXVBCH00500001



2 ART. FAXVBCH00600001
3 ART. FAXVBCH00500001



3 ART. FAXVBCH00600001
1 ART. FAXVBCH00500001
1 ART. FAXVBCH00400001



ART. M 00 PA71 00 00 FO 00
FORATURA PIANO SUPERIORE IN MDF O
MULTIPLY PER IL FISSAGGIO DEL PANNELLO
FORATO - COMPRESIVO DI VITI



ART. M 00 PA71 00 00 F1 00
FORATURA PIANO SUPERIORE A 3 - 4
BORDI PER IL FISSAGGIO DEL PANNELLO
FORATO - COMPRESIVO DI VITI



ART. M 00 PA71 00 00 F2 00
SET DI PREDISPOSIZIONE PER IL
FISSAGGIO DEI VISUAL BOX AL
PANNELLO FORATO



ZOCCOLO DI RIALZO ALTEZZA 50 mm

ART.		dim. mm	
M 33 Z050 00 00 00 __		712x725x50 H	



ZOCCOLO DI RIALZO ALTEZZA 100 mm

ART.		dim. mm	
M 33 Z100 00 00 00 __		712x725x100 H	



ZOCCOLI PER CARRELLO ELEVATORE - Colore nero RAL 9005

ART.		dim. mm	
M 03 Z060 20 00 00 07	coppia zoccoli	200x722x60 H	
M 30 Z060 21 00 00 07	chiusura per coppia zoccoli	708x46x55 H	



ZOCCOLI PER TRANSPALLET - Colore nero RAL 9005

ART.		dim. mm	
M 33 Z100 10 00 00 07	zoccolo	712x722x100 H	
M 30 Z100 11 00 00 07	chiusura per zoccolo	708x46x95 H	

RUOTA FISSA IN GOMMA ELASTICA

ART.	Ø mm	portata armadio kg	C mm
C RG BCE15 125	125	400	155
C RG BCE15 160	160	600	200



RUOTA GIREVOLE CON FRENO IN GOMMA ELASTICA

ART.	Ø mm	portata armadio kg	C mm
C RG DCE15 125	125	400	155
C RG DCE15 160	160	600	200



RUOTA FISSA IN NYLON

ART.	Ø mm	portata armadio kg	C mm
C RN BAD11 125	125	400	155
C RN BAD04 160	160	600	200



RUOTA GIREVOLE CON FRENO IN NYLON

ART.	Ø mm	portata armadio kg	C mm
C RN DAD11 125	125	400	155
C RN DAD04 160	160	600	200



RICAMBI - FISSAGGIO

SERRATURA DI RICAMBIO

ART. M 00 CSRO 8800 00 00

Serratura di ricambio con due chiavi



CHIAVE DI RICAMBIO

ART. M 00 CFO0 0000 00 00

Specificare sempre il numero indicato nella serratura a cilindro dove si vuole sostituire la chiave



PASSEPARTOUT

ART. M 00 PF.. 0000 00 00

Disponibile in 23 serie, con numerazione da F 01 a F 23.

Passepartout serie F 01
Passepartout serie F 02
Passepartout serie F ..

ART. M 00 PF01 00 00 00 00
ART. M 00 PF02 00 00 00 00
ART. M 00 PF.. 00 00 00 00

SET FISSAGGIO TRA ARMADI

ART. M 00 FISO 00 00 00 99

Set di fissaggio armadio-armadio con 4 viti complete di dadi M8

ART. M 00 SVRO 00 00 00 99

Foratura e viteria per il fissaggio dei due armadi sovrapposti

SET DI FISSAGGIO A PAVIMENTO



ART. F AG 9200 00 99

Coppia staffe zincate per il fissaggio a pavimento dell'armadio

ART. F AG 9204 00 99

2 tasselli "HILTI" adatti per pavimenti in calcestruzzo non fessurato maggiore o uguale alla classe C20/25
Trazione consigliata del tassello: 2,9 kN
Diametro tassello: Ø 6 mm



MANIGLIA DI RICAMBIO

ART. M 00 PLS0 0000 22 M0

Maniglia di ricambio per porte disponibile in colore Dark Grey.



ALTRI COLORI A RICHIESTA



GLI ARMADI DEVONO ESSERE FISSATI A PAVIMENTO O A PARETE
SE SOVRAPPOSTI DEVONO ESSERE FISSATI OBBLIGATORIAMENTE A PARETE E LA LORO PORTATA DIVISA PER DUE



MASTER

714x726 mm

Born To Be Extreme

ARMADIO VUOTO senza asta vertebrata e senza chiusura



H 400 mm
H utile 300 mm



H 700 mm
H utile 600 mm



H 800 mm
H utile 700 mm



H 850 mm
H utile 750 mm



H 1000 mm
H utile 900 mm



M 33 A040 X0 10 00 __

M 33 A070 X0 10 00 __

M 33 A080 X0 10 00 __

M 33 A085 X0 10 00 __

M 33 A100 X0 10 00 __

ASTA VERTEBRATA



L'asta vertebrata è composta da un profilo in alluminio estruso forato a passo 25 mm per l'inserimento della molla antiribaltamento. L'asta antiribaltamento viene fornita completa di accessori in plastica e struttura superiore predisposta per la chiusura a cilindro o elettronica.

ART.	H utile inserimento cassette mm
M 00 V030 00 00 00 00	300
M 00 V050 00 00 00 00	500
M 00 V060 00 00 00 00	600
M 00 V070 00 00 00 00	700
M 00 V075 00 00 00 00	750
M 00 V090 00 00 00 00	900

ART.	H utile inserimento cassette mm
M 00 V105 00 00 00 00	1050
M 00 V122 00 00 00 00	1225
M 00 V140 00 00 00 00	1400
M 00 V152 00 00 00 00	1525
M 00 V190 00 00 00 00	1900

CHIUSURA CON CILINDRO (KEY)



CHIUSURA A CILINDRO COMPLETA DI:

- 1 serratura a cilindro con 2 chiavi
- 1 filo in acciaio con guaina
- 1 gruppo percussore anteriore
- 1 gruppo cursore posteriore

ART.		
M 33 V000 C0 00 00 00	C0	CHIUSURA A CILINDRO CON NUMERAZIONE DIVERSA
M 33 V000 C1 00 00 00	C1	CHIUSURA A CILINDRO PER GRUPPI DI 160 NUMERI
M 33 V000 C2 00 00 00	C2	CHIUSURA A CILINDRO CON NUMERAZIONE UGUALE

For Experts Only



H 1150 mm
H utile 1050 mm



H 1325 mm
H utile 1225 mm



H 1500 mm
H utile 1400 mm



H 1625 mm
H utile 1525 mm



H 2000 mm
H utile 1900 mm



M 33 A115 X0 10 00 __

M 33 A132 X0 10 00 __

M 33 A150 X0 10 00 __

M 33 A162 X0 10 00 __

M 33 A200 X0 10 00 __

CHIUSURA CON CODICE NUMERICO (CODE)



ART.

M 33 V000 E2 00 00 00

E2

M 33 V000 E5 00 00 00

E5

M 33 V000 T2 00 00 00

T2

M 33 V000 T3 00 00 00

T3

ART. TELECOMANDO

M 00 VRC0 00 00 00 00

Modulo ricevitore
con telecomando

M 00 VRC0 00 00 01 00

Telecomando aggiuntivo



PIANI PER SERRATURE E PIANI REGOLABILI

PIANO SUPERIORE PER SERRATURE



ART.



H frontale mm

kg

M 33 PS46 00 10 00 __

46

150

Dim. mm 663x724x46 H

PIANO INFERIORE PER SERRATURE



ART.



H frontale mm

kg

M 33 PS46 10 10 00 __

46

150

Dim. mm 663x724x46 H

PIANO REGOLABILE



ART.



H totale mm

kg

M 33 PR25 00 00 01 __

60

150

Dim. utili mm 657x631x60 H

PIANO REGOLABILE FESSURATO



ART.



H frontale mm

kg

M 33 PR35 10 00 01 __

35

300

Dim. mm 663x721x35 H

36x36 EH

MATERIALE DI SEPARAZIONE

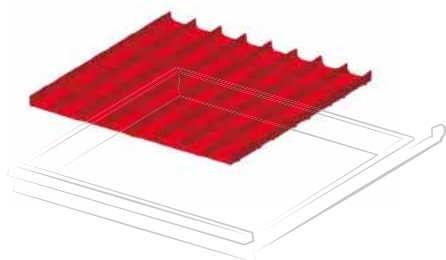

ART. per altezza frontale mm
F FH 2005 15 00 50 - 300

Set composto da: 16 divisori 2 canali, 35 divisori trasversali 73 mm

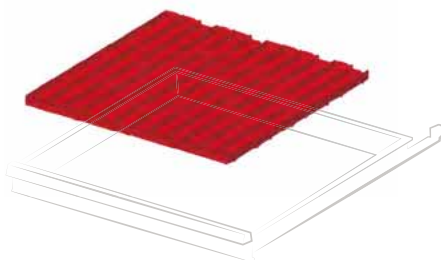

ART. per altezza frontale mm
F FH 2005 16 00 50 - 300

Set composto da: 16 divisori 3 canali, 50 divisori trasversali 47 mm

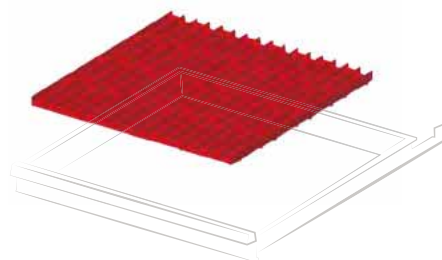

ART. per altezza frontale mm
F FH 2005 17 00 50 - 300

Set composto da: 16 divisori 4 canali, 65 divisori trasversali 36 mm

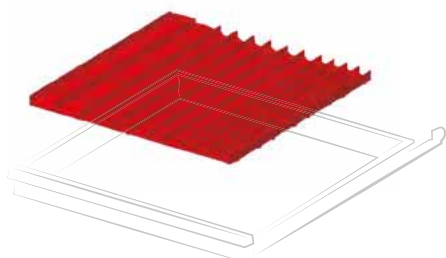

ART. per altezza frontale mm
F FH 2005 20 00 50 - 300

Set composto da: 4 divisori 4 canali, 8 divisori 3 canali, 4 divisori 2 canali, 30 divisori trasversali 36 mm, 20 divisori trasversali 47 mm, 10 divisori trasversali 73 mm

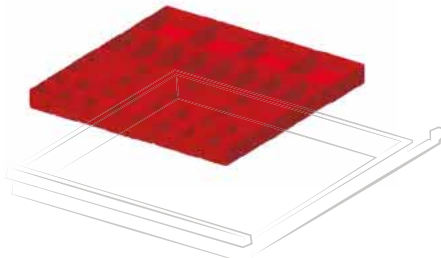

ART. per altezza frontale mm
F FH 2005 12 00 50

F FH 2007 12 00 75
 Set composto da: 16 cassette divisorio 75x75 mm, 16 cassette divisorio 150x75 mm, 4 cassette divisorio 150x150 mm

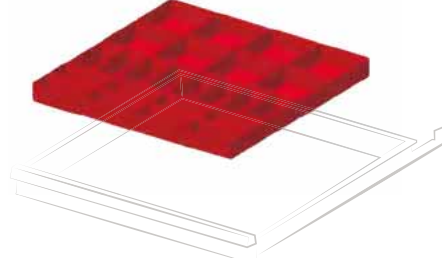

ART. per altezza frontale mm
F FH 2005 13 00 50

F FH 2007 13 00 75
F FH 2010 13 00 100 - 125
 Set composto da: 16 cassette divisorio 150x75 mm, 8 cassette divisorio 150x150 mm

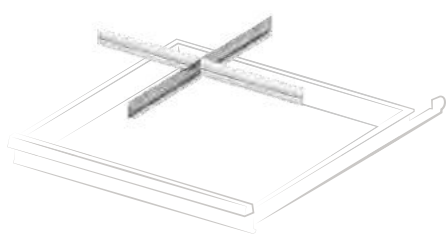

ART. per altezza frontale mm
F FH 2005 05 00 50

F FH 2007 05 00 75

F FH 2010 05 00 100 - 125

F FH 2015 05 00 150

F FH 2020 05 00 200 - 250

F FH 2030 05 00 300

Set composto da: 1 divisorio longitudinale fessurato 610 mm, 2 divisori trasversali 302 mm

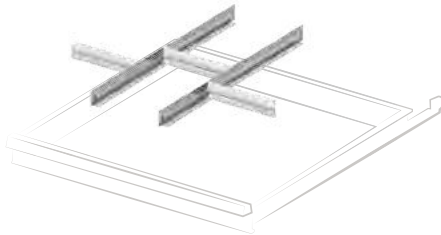

ART. per altezza frontale mm
F FH 2005 06 00 50

F FH 2007 06 00 75

F FH 2010 06 00 100 - 125

F FH 2015 06 00 150

F FH 2020 06 00 200 - 250

F FH 2030 06 00 300

Set composto da: 2 divisori longitudinali fessurati 610 mm, 3 divisori trasversali 200 mm

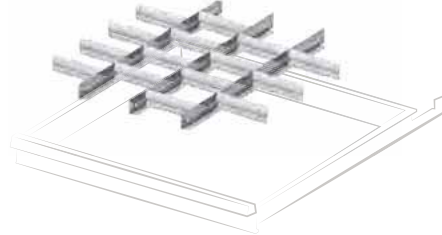

ART. per altezza frontale mm
F FH 2005 07 00 50

F FH 2007 07 00 75

F FH 2010 07 00 100 - 125

F FH 2015 07 00 150

F FH 2020 07 00 200 - 250

Set composto da: 3 divisori longitudinali fessurati 610 mm, 15 divisori trasversali 149 mm

CONFIGURA IL CASSETTO FAMI CON UTENSILI BETA

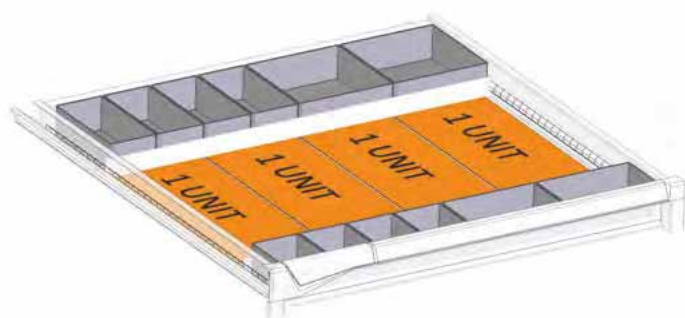

ART. F FH 2007 50 07

Set di predisposizione cassetto per termoformati Beta composto da:

- n. 4 F HC 6071 00 07
- n. 6 F HC 6471 00 07
- n. 2 F HC 6871 00 07
- n. 1 F HA 1140 00 99
- n. 1 F HA 2140 00 99

1 unit = 1 termoformato Beta 367x147 mm

2 unit = 1 termoformato Beta 367x294 mm





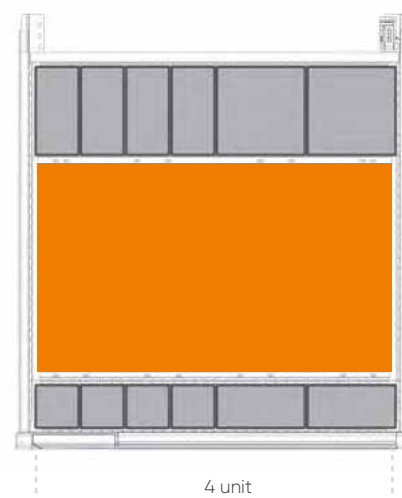
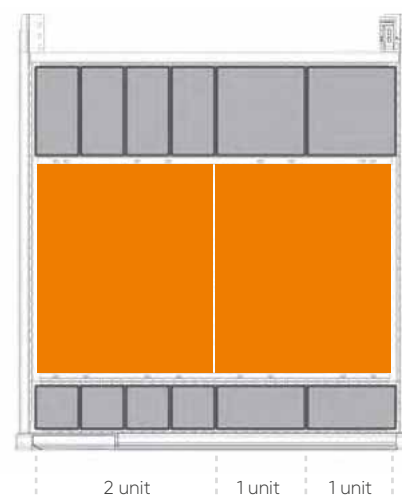
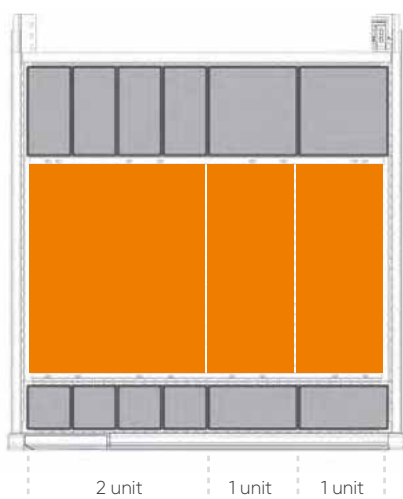
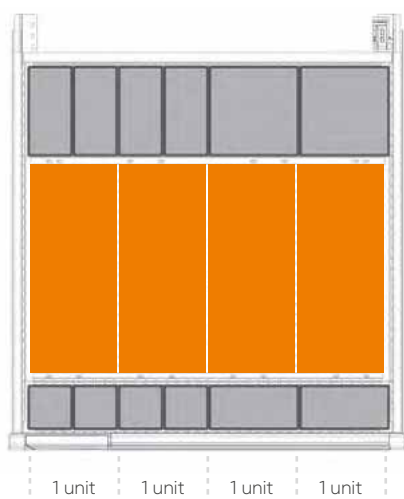

4 unit = 1 termoformato Beta 367x588 mm

ESEMPI DI UTILIZZO TERMOFORMATO













Gamma colori ACCIAIO

	
GRIGIO RAL 7000 .01	VERDE RAL 6011 .02
	
BLU RAL 5012 .04	GRIGIO RAL 7035 .08
	
BIANCO GRIGIASTRO RAL 9002 .1F	ROSSO RUBINO RAL 3003 .1G
	
BLU GENZIANA RAL 5010 .34	BIANCO PURO RAL 9010 .35
	
GRIGIO ANTRACITE RAL 7016 .39	BLU CAPRI RAL 5019 .48



● ART. M 43 A100 C0 10 AW 04
H = 1000 mm - 7 cassetti

Gamma colori PLASTICHE

			
DARK GREY .M0	MEDITERRANEAN BLUE .M1	SKY BLUE .M2	GLAMOUR RED .M3
			
RED CARPET .M4	JUICE ORANGE .M5	SUNNY YELLOW .M6	FOREST GREEN .M7

LEGENDA



PORTATA CASSETTO/
PIANO



ESTRAZIONE CASSETTO/
PIANO



CHIUSURA ARMADIO



LE PORTATE SONO NETTE E SI RIFERISCONO A PESI UNIFORMEMENTE DISTRIBUITI

H 700 mm



ART.		kg		
M 43 A070 C0 10 29 04		50-75-100	100-96-92%	key
M 43 A070 C0 10 48 04		200	100%	key
M 43 A070 E2 10 29 04		50-75-100	100-96-92%	code
M 43 A070 E2 10 48 04		200	100%	code

H 700 mm



ART.		kg		
M 43 A070 C0 10 42 04		50-75-100	100-96-92%	key
M 43 A070 C0 10 43 04		200	100%	key
M 43 A070 E2 10 42 04		50-75-100	100-96-92%	code
M 43 A070 E2 10 43 04		200	100%	code

H 850 mm



ART.		kg		
M 43 A085 C0 10 AC 04		50-75-100	100-96-92%	key
M 43 A085 C0 10 AD 04		200	100%	key
M 43 A085 E2 10 AC 04		50-75-100	100-96-92%	code
M 43 A085 E2 10 AD 04		200	100%	code

H 850 mm



ART.		kg		
M 43 A085 C0 10 AG 04		50-75-100	100-96-92%	key
M 43 A085 C0 10 AH 04		200	100%	key
M 43 A085 E2 10 AG 04		50-75-100	100-96-92%	code
M 43 A085 E2 10 AH 04		200	100%	code

H 1000 mm



ART.			
M 43 A100 C0 10 AW 04	50-75-100	100-96-92%	key
M 43 A100 C0 10 BH 04	200	100%	key
M 43 A100 E2 10 AW 04	50-75-100	100-96-92%	code
M 43 A100 E2 10 BH 04	200	100%	code

H 1000 mm



*estrazione flessibile

ART.			
M 43 A100 C0 10 CS 04	50-75-100	100-96-92%	key
M 43 A100 C0 10 CT 04	200	100%	key
M 43 A100 E2 10 CS 04	50-75-100	100-96-92%	code
M 43 A100 E2 10 CT 04	200	100%	code

H 1023 mm



porta 900 mm profondità 751 mm

ART.			
M 43 A100 C0 10 BU 04	50-75-100	100-96-92%	key
M 43 A100 C0 10 BV 04	200	100%	key
M 43 A100 P5 10 BU 04	50-75-100	100-96-92%	code
M 43 A100 P5 10 BV 04	200	100%	code

H 1023 mm



porta 900 mm profondità 751 mm

ART.			
M 43 A100 C0 10 CA 04	50-75-100	100-96-92%	key
M 43 A100 C0 10 CB 04	200	100%	key
M 43 A100 P5 10 CA 04	50-75-100	100-96-92%	code
M 43 A100 P5 10 CB 04	200	100%	code

H 1500 mm



H 1500 mm



ART.				
M 43 A150 C0 10 FJ 04		50-75-100	100-96-92%	key
M 43 A150 C0 10 FK 04		200	100%	key
M 43 A150 E2 10 FJ 04		50-75-100	100-96-92%	code
M 43 A150 E2 10 FK 04		200	100%	code

porta 1400 mm

profondità 751 mm

ART.				
M 43 A150 C0 10 LC 04		50-75-100	100-96-92%	key
M 43 A150 C0 10 LD 04		200	100%	key
M 43 A150 P5 10 LC 04		50-75-100	100-96-92%	code
M 43 A150 P5 10 LD 04		200	100%	code



ART. M 43 A085 E2 14 PA 48

H 2000 mm



H 2000 mm



ART.				
M 43 A200 C5 10 FU 04		50-75-100	100-96-92%	-
M 43 A200 C5 10 FV 04		200	100%	-

ART.				
M 43 A200 C0 10 FS 04		50-75-100	100-96-92%	key
M 43 A200 C0 10 FT 04		200	100%	key
M 43 A200 E2 10 FS 04		50-75-100	100-96-92%	code
M 43 A200 E2 10 FT 04		200	100%	code



H 2000 mm



porta 900 mm

ART.				
M 43 A200 C0 10 FY 04		50-75-100	100-96-92%	key
M 43 A200 C0 10 FZ 04		200	100%	key
M 43 A200 T2 10 FY 04		50-75-100	100-96-92%	code
M 43 A200 T2 10 FZ 04		200	100%	code

H 2000 mm



porta 1900 mm

ART.				
M 43 A200 C0 10 FW 04		50-75-100	100-96-92%	key
M 43 A200 C0 10 FX 04		200	100%	key
M 43 A200 P5 10 FW 04		50-75-100	100-96-92%	code
M 43 A200 P5 10 FX 04		200	100%	code



H 963 mm



ART.				
M 43 R070 S0 10 42 04		50-75-100	100-96-92%	key
M 43 R070 P2 10 42 04		50-75-100	100-96-92%	code

Portata armadio 600 kg - Altezza armadio senza ruote mm 763

H 963 mm



ART.				
M 43 R070 S0 10 44 04		50-75-100	100-96-92%	key
M 43 R070 P2 10 44 04		50-75-100	100-96-92%	code

Portata armadio 600 kg - Altezza armadio senza ruote mm 763

H 1113 mm



ART.				
M 43 R085 S0 10 AC 04		50-75-100	100-96-92%	key
M 43 R085 P2 10 AC 04		50-75-100	100-96-92%	code

Portata armadio 600 kg - Altezza armadio senza ruote mm 913

H 1113 mm



ART.				
M 43 R085 S0 10 AG 04		50-75-100	100-96-92%	key
M 43 R085 P2 10 AG 04		50-75-100	100-96-92%	code

Portata armadio 600 kg - Altezza armadio senza ruote mm 913



2 ruote girevoli con freno in gomma elastica Ø 160 mm
2 ruote fisse in gomma elastica Ø 160 mm

H 1263 mm



H 1263 mm



ART.		kg		
M 43 R100 SO 10 CQ 04		50-75-100	100-96-92%	key
M 43 R100 P2 10 CQ 04		50-75-100	100-96-92%	code

Portata armadio 600 kg - Altezza armadio senza ruote mm 1063

ART.		kg		
M 43 R100 SO 10 AW 04		50-75-100	100-96-92%	key
M 43 R100 P2 10 AW 04		50-75-100	100-96-92%	code

Portata armadio 600 kg - Altezza armadio senza ruote mm 1063



2 ruote girevoli con freno in gomma elastica Ø 160 mm
2 ruote fisse in gomma elastica Ø 160 mm

ART. M 43 R070 P2 10 RA EF



CONFIGURA IL TUO ARMADIO

	SCEGLI l'altezza	SCEGLI la chiusura		SCEGLI il colore
M43	A040	C5	10 00	01

ARMADIO VUOTO



Portata corpo
armadio 3100 kg

	ALTEZZA	CHIUSURA		COLORE
M43	A070 700 mm (utile 600 mm)	X0 senza asta e senza serratura	10 00	01 RAL 7000
	A085 850 mm (utile 750 mm)	C5* senza serratura		02 RAL 6011
	A100 1000 mm (utile 900 mm)	C0* KEY chiusura a cilindro		1G RAL 3003
	A150 1500 mm (utile 1400 mm)	C1* KEY chiusura a cilindro		1F RAL 9002
	A200 2000 mm (utile 1900 mm)	C2* KEY chiusura a cilindro		48 RAL 5019
		E2* CODE codice numerico		39 RAL 7016
		T2* CODE codice numerico		04 RAL 5012
				08 RAL 7035
		35 RAL 9010		
		34 RAL 5010		

*COMPLETA DI ASTA VERTEBRATA

ARMADIO VUOTO predisposto per ruote



	ALTEZZA	CHIUSURA		COLORE
M43	R070 763 mm (utile 600 mm)	S0 con asta e senza serratura	10 00	01 RAL 7000
	R085 913 mm (utile 750 mm)	S1 KEY chiusura a cilindro		02 RAL 6011
	R100 1063 mm (utile 900 mm)	S2 KEY chiusura a cilindro		1G RAL 3003
		P2 CODE codice numerico		1F RAL 9002
		A1 CODE codice numerico		48 RAL 5019
				39 RAL 7016
				04 RAL 5012
				08 RAL 7035
		35 RAL 9010		
		34 RAL 5010		

COMPLETO DI ASTA VERTEBRATA, PIANO A 4 BORDI CON COPERTURA IN PVC, COPPIA MANIGLIE, COPPIA PIASTRE
Dim. ingombro mm 941x752



CASSETTI AD ESTRAZIONE FLESSIBILE

ART. CON kit plastiche Dark Grey	ART. SENZA kit plastiche*	Dim. utili mm	H frontale mm	kg	
M 43 C050 0110 OF __	M 43 C050 01 00 OF __	753x600x31 H	50	50 - 75 - 100	100% - 96% - 92%
M 43 C075 0110 OF __	M 43 C075 01 00 OF __	753x600x56 H	75	50 - 75 - 100	100% - 96% - 92%
M 43 C100 0110 OF __	M 43 C100 01 00 OF __	753x600x81 H	100	50 - 75 - 100	100% - 96% - 92%
M 43 C125 0110 OF __	M 43 C125 01 00 OF __	753x600x106 H	125	50 - 75 - 100	100% - 96% - 92%
M 43 C150 0110 OF __	M 43 C150 01 00 OF __	753x600x131 H	150	50 - 75 - 100	100% - 96% - 92%
M 43 C200 0110 OF __	M 43 C200 01 00 OF __	753x600x181 H	200	50 - 75 - 100	100% - 96% - 92%
M 43 C250 0110 OF __	M 43 C250 01 00 OF __	753x600x231 H	250	50 - 75 - 100	100% - 96% - 92%
M 43 C300 0110 OF __	M 43 C300 01 00 OF __	753x600x281 H	300	50 - 75 - 100	100% - 96% - 92%

* ABBINARE AL CODICE ARTICOLO UNO DEI KIT PLASTICHE DISPONIBILI NELLA TABELLA SOTTOSTANTE



CASSETTI AD ESTRAZIONE TELESCOPICA

ART. CON kit plastiche Dark Grey	ART. SENZA kit plastiche*	Dim. utili mm	H frontale mm	kg	
M 43 C075 0110 OT __	M 43 C075 01 00 OT __	753x600x56 H	75	200	100%
M 43 C100 0110 OT __	M 43 C100 01 00 OT __	753x600x81 H	100	200	100%
M 43 C125 0110 OT __	M 43 C125 01 00 OT __	753x600x106 H	125	200	100%
M 43 C150 0110 OT __	M 43 C150 01 00 OT __	753x600x131 H	150	200	100%
M 43 C200 0110 OT __	M 43 C200 01 00 OT __	753x600x181 H	200	200	100%
M 43 C250 0110 OT __	M 43 C250 01 00 OT __	753x600x231 H	250	200	100%
M 43 C300 0110 OT __	M 43 C300 01 00 OT __	753x600x281 H	300	200	100%

* ABBINARE AL CODICE ARTICOLO UNO DEI KIT PLASTICHE DISPONIBILI NELLA TABELLA SOTTOSTANTE

KIT PLASTICHE PER CASSETTI E PIANI ESTRAIBILI



GAMMA COLORI PLASTICHE	ART.
MEDITERRANEAN BLUE	M 40 PLS1 00 00 00 M1
SKY BLUE	M 40 PLS1 00 00 00 M2
GLAMOUR RED	M 40 PLS1 00 00 00 M3
RED CARPET	M 40 PLS1 00 00 00 M4
JUICY ORANGE	M 40 PLS1 00 00 00 M5
SUNNY YELLOW	M 40 PLS1 00 00 00 M6
FOREST GREEN	M 40 PLS1 00 00 00 M7



PIANI ESTRAIBILI AD ESTRAZIONE FLESSIBILE

ART. CON kit plastiche Dark Grey	ART. SENZA kit plastiche*	Dim. utili mm	H frontale mm	kg	
M 43 C057 0110 OF __	M 43 C057 01 00 OF __	753x600	70	50 - 75 - 100	100% - 96% - 92%

* ABBINARE AL CODICE ARTICOLO UNO DEI KIT PLASTICHE DISPONIBILI NELLA TABELLA SOTTOSTANTE



PIANI ESTRAIBILI AD ESTRAZIONE TELESCOPICA

ART. CON kit plastiche Dark Grey	ART. SENZA kit plastiche*	Dim. utili mm	H frontale mm	kg	
M 43 C057 0110 OT __	M 43 C057 01 00 OT __	753x600	70	200	100%

* ABBINARE AL CODICE ARTICOLO UNO DEI KIT PLASTICHE DISPONIBILI NELLA TABELLA SOTTOSTANTE



PIANO REGOLABILE

ART.	Dim. utili mm	H totale mm	kg
M 43 PR25 00 00 01 __	810x631	60	100

INSERIBILE DAVANTI ALL'ASTA VERTEBRATA

KIT PLASTICHE PER CASSETTI E PIANI ESTRAIBILI



GAMMA COLORI PLASTICHE	ART.
MEDITERRANEAN BLUE	M 40 PLS1 00 00 00 M1
SKY BLUE	M 40 PLS1 00 00 00 M2
GLAMOUR RED	M 40 PLS1 00 00 00 M3
RED CARPET	M 40 PLS1 00 00 00 M4
JUICY ORANGE	M 40 PLS1 00 00 00 M5
SUNNY YELLOW	M 40 PLS1 00 00 00 M6
FOREST GREEN	M 40 PLS1 00 00 00 M7

ART. M 43 A085 E2 14 PA 48

















ART. M 43 R070 S0 11 PB EF

🔑 PORTE A BATTENTE CON CILINDRO

COPPIA PORTE A BATTENTE ALTEZZA TOTALE



H ARMADIO mm	TIPO DI CHIUSURA	ART. CON kit plastiche Dark Grey 	ART. SENZA kit plastiche* 
850	 C0 KEY chiusura a cilindro	M 40 P075 C0 10 10 __	M 40 P075 C0 00 10 __
	 C1 KEY chiusura a cilindro	M 40 P075 C1 10 10 __	M 40 P075 C1 00 10 __
	 C2 KEY chiusura a cilindro	M 40 P075 C2 10 10 __	M 40 P075 C2 00 10 __
1000	 C0 KEY chiusura a cilindro	M 40 P090 C0 10 10 __	M 40 P090 C0 00 10 __
	 C1 KEY chiusura a cilindro	M 40 P090 C1 10 10 __	M 40 P090 C1 00 10 __
	 C2 KEY chiusura a cilindro	M 40 P090 C2 10 10 __	M 40 P090 C2 00 10 __
1500	 C0 KEY chiusura a cilindro	M 40 P140 C0 10 10 __	M 40 P140 C0 00 10 __
	 C1 KEY chiusura a cilindro	M 40 P140 C1 10 10 __	M 40 P140 C1 00 10 __
	 C2 KEY chiusura a cilindro	M 40 P140 C2 10 10 __	M 40 P140 C2 00 10 __
2000	 C0 KEY chiusura a cilindro	M 40 P190 C0 10 10 __	M 40 P190 C0 00 10 __
	 C1 KEY chiusura a cilindro	M 40 P190 C1 10 10 __	M 40 P190 C1 00 10 __
	 C2 KEY chiusura a cilindro	M 40 P190 C2 10 10 __	M 40 P190 C2 00 10 __





* ABBINARE AL CODICE ARTICOLO UNO DEI KIT PLASTICHE DISPONIBILI NELLA TABELLA A DESTRA



LA COPPIA PORTE DEVE ESSERE ASSOCIATA OBBLIGATORIAMENTE AGLI ARMADI CON LA CHIUSURA:
C5 (SENZA SERRATURA) OPPURE **X0** (SENZA ASTA VERTEBRATA E SENZA SERRATURA)

COPPIA PORTE A BATTENTE ALTEZZA PARZIALE



H INGOMBRO PORTA mm	TIPO DI CHIUSURA	ART. CON kit plastiche Dark Grey 	ART. SENZA kit plastiche* 
775	 C0 KEY chiusura a cilindro	M 40 P077 C0 10 11 __	M 40 P077 C0 00 11 __
	 C1 KEY chiusura a cilindro	M 40 P077 C1 10 11 __	M 40 P077 C1 00 11 __
	 C2 KEY chiusura a cilindro	M 40 P077 C2 10 11 __	M 40 P077 C2 00 11 __

* ABBINARE AL CODICE ARTICOLO UNO DEI KIT PLASTICHE DISPONIBILI NELLA TABELLA A DESTRA

1 2 3 4 5 C PORTE A BATTENTE CON CODICE NUMERICO

COPPIA PORTE A BATTENTE ALTEZZA TOTALE



H ARMADIO mm	TIPO DI CHIUSURA	ART. CON kit plastiche Dark Grey	ART. SENZA kit plastiche*
850	P5 CODE codice numerico	M 40 P075 P5 10 10 _ _	M 40 P075 P5 00 10 _ _
1000	P5 CODE codice numerico	M 40 P090 P5 10 10 _ _	M 40 P090 P5 00 10 _ _
1500	P5 CODE codice numerico	M 40 P140 P5 10 10 _ _	M 40 P140 P5 00 10 _ _
2000	P5 CODE codice numerico	M 40 P190 P5 10 10 _ _	M 40 P190 P5 00 10 _ _

* ABBINARE AL CODICE ARTICOLO UNO DEI KIT PLASTICHE DISPONIBILI NELLA TABELLA SOTTOSTANTE

LA COPPIA PORTE DEVE ESSERE ASSOCIATA OBBLIGATORIAMENTE AGLI ARMADI CON LA CHIUSURA:
C5 (SENZA SERRATURA) OPPURE **X0** (SENZA ASTA VERTEBRATA E SENZA SERRATURA)



COPPIA PORTE A BATTENTE ALTEZZA PARZIALE

H INGOMBRO PORTA mm	TIPO DI CHIUSURA	ART. CON kit plastiche Dark Grey	ART. SENZA kit plastiche*
775	A4 maniglia senza tastierino	M 40 P077 A4 10 11 _ _	M 40 P077 A4 00 11 _ _

* ABBINARE AL CODICE ARTICOLO UNO DEI KIT PLASTICHE DISPONIBILI NELLA TABELLA SOTTOSTANTE

LA COPPIA PORTE DEVE ESSERE ASSOCIATA OBBLIGATORIAMENTE AGLI ARMADI CON LE CHIUSURE:
UTILIZZARE LA SERRATURA **T2** PER L'ARMADIO SENZA RUOTE
UTILIZZARE LA SERRATURA **A1** PER L'ARMADIO CON RUOTE



TELECOMANDO

ART.	
M 00 VRC0 00 00 00 00	Modulo ricevitore con telecomando
M 00 VRC0 00 00 01 00	Telecomando aggiuntivo

KIT PLASTICHE PER COPPIA PORTE



GAMMA COLORI PLASTICHE	ART. KEY	ART. CODE
MEDITERRANEAN BLUE	M 00 PLS0 00 00 30 M1	M 00 PLS0 00 00 31 M1
SKY BLUE	M 00 PLS0 00 00 30 M2	M 00 PLS0 00 00 31 M2
GLAMOUR RED	M 00 PLS0 00 00 30 M3	M 00 PLS0 00 00 31 M3
RED CARPET	M 00 PLS0 00 00 30 M4	M 00 PLS0 00 00 31 M4
JUICY ORANGE	M 00 PLS0 00 00 30 M5	M 00 PLS0 00 00 31 M5
SUNNY YELLOW	M 00 PLS0 00 00 30 M6	M 00 PLS0 00 00 31 M6
FOREST GREEN	M 00 PLS0 00 00 30 M7	M 00 PLS0 00 00 31 M7



PIANO SUPERIORE A 3 BORDI

ART.	dim. mm	
M 43 T023 AG 00 31 07	867x726x23 H	

Piano rivestito in pvc per ARMADIO SINGOLO. Colore nero



PIANO SUPERIORE A 4 BORDI

ART.	dim. mm	
M 43 T023 AG 00 41 07	867x726x23 H	

Piano rivestito in pvc per ARMADIO SINGOLO. Colore nero



ART. M 00 T023 AG 00 FO 00

FORATURA PIANO SUPERIORE DELL'ARMADIO PER IL FISSAGGIO DEL PIANO A 4 BORDI



PIANO SUPERIORE IN MULTIPLEX

ART.	dim. mm	
M 43 T040 MU 00 01 00	867x726x40 H	

Per ARMADIO SINGOLO



PIANO SUPERIORE IN MDF DIM. 867x726x32 mm H

ART.	rifiniture	per armadio	
M 43 T030 MD GM 21 07	1 profilo laterale	finale dx o sx	

Piano in MDF con copertura in gomma antiolio. Colore nero



PIANO SUPERIORE IN MDF DIM. 867x726x32 mm H

ART.	rifiniture	per armadio	
M 43 T030 MD GM 11 07	-	centrale	

Piano in MDF con copertura in gomma antiolio. Colore nero



PIANO SUPERIORE IN MDF DIM. 867x726x32 mm H

ART.	rifiniture	per armadio	
M 43 T030 MD GM 01 07	2 profili laterali	singolo	

Piano in MDF con copertura in gomma antiolio. Colore nero



ART. M 00 T030 MD 00 FO 00

FORATURA PIANO SUPERIORE DELL'ARMADIO PER IL FISSAGGIO DEL PIANO IN MDF E DEL PIANO IN MULTIPLEX COMPRESIVO DI VITI PER IL FISSAGGIO



RIFINITURA
GOMMA
ANTIOLIO



APPLICAZIONE
PIANO IN MDF



**PIANO SUPERIORE IN MULTIPLEX PER
ARMADIO CON RUOTE**
DISPONIBILE SU RICHIESTA



ZOCCOLO DI RIALZO ALTEZZA 50 mm

ART.		dim. mm	
M 43 Z050 00 00 00 _ _		865x725x50 H	



ZOCCOLO DI RIALZO ALTEZZA 100 mm

ART.		dim. mm	
M 43 Z100 00 00 00 _ _		865x725x100 H	



ZOCCOLI PER CARRELLO ELEVATORE - Colore nero RAL 9005

ART.		dim. mm	
M 03 Z060 20 00 00 07	coppia zoccoli	200x722x60 H	
M 40 Z060 21 00 00 07	chiusura per coppia zoccoli	861x46x55 H	



ZOCCOLI PER TRANSPALLET - Colore nero RAL 9005

ART.		dim. mm	
M 43 Z100 10 00 00 07	zoccolo	865x722x100 H	
M 40 Z100 11 00 00 07	chiusura per zoccolo	861x46x95 H	



RUOTA FISSA IN GOMMA ELASTICA

ART.	Ø mm	portata armadio kg	C mm
C RG BCE15 125	125	380	155
C RG BCE15 160	160	600	200



RUOTA GIREVOLE CON FRENO IN GOMMA ELASTICA

ART.	Ø mm	portata armadio kg	C mm
C RG DCE15 125	125	380	155
C RG DCE15 160	160	600	200



RUOTA FISSA IN NYLON

ART.	Ø mm	portata armadio kg	C mm
C RN BAD11 125	125	380	155
C RN BAD04 160	160	600	200



RUOTA GIREVOLE CON FRENO IN NYLON

ART.	Ø mm	portata armadio kg	C mm
C RN DAD11 125	125	380	155
CRNDAD04 160	160	600	200



RICAMBI - FISSAGGIO

SERRATURA DI RICAMBIO

ART. M 00 CSRO 8800 00 00

Serratura di ricambio con due chiavi



CHIAVE DI RICAMBIO

ART. M 00 CF00 0000 00 00

Specificare sempre il numero indicato nella serratura a cilindro dove si vuole sostituire la chiave



PASSEPARTOUT

ART. M 00 PF.. 0000 00 00

Disponibile in 23 serie, con numerazione da F 01 a F 23.

Passepartout serie F 01
Passepartout serie F 02
Passepartout serie F ..

ART. M 00 PF01 00 00 00 00
ART. M 00 PF02 00 00 00 00
ART. M 00 PF.. 00 00 00 00

SET FISSAGGIO TRA ARMADI

ART. M 00 FISO 00 00 00 99

Set di fissaggio armadio-armadio con 4 viti complete di dadi M8

ART. M 00 SVRO 00 00 00 99

Foratura e viteria per il fissaggio dei due armadi sovrapposti

SET DI FISSAGGIO A PAVIMENTO



ART. F AG 9200 00 99

Coppia staffe zincate per il fissaggio a pavimento dell'armadio

ART. F AG 9204 00 99

2 tasselli "HILTI" adatti per pavimenti in calcestruzzo non fessurato maggiore o uguale alla classe C20/25
Trazione consigliata del tassello: 2.9 kN
Diametro tassello: Ø 6 mm



MANIGLIA DI RICAMBIO

ART. M 00 PLSO 0000 22 M0

Maniglia di ricambio per porte disponibile in colore Dark Grey.



ALTRI COLORI A RICHIESTA



GLI ARMADI DEVONO ESSERE FISSATI A PAVIMENTO O A PARETE
SE SOVRAPPOSTI DEVONO ESSERE FISSATI OBBLIGATORIAMENTE A PARETE E LA LORO PORTATA DIVISA PER DUE



Born To Be Extreme

ARMADIO VUOTO

senza asta vertebrata e senza chiusura



H 700 mm
H utile 600 mm



H 850 mm
H utile 750 mm



H 1000 mm
H utile 900 mm



H 1500 mm
H utile 1400 mm



H 2000 mm
H utile 1900 mm



M 43 A070 X0 10 00 _ _

M 43 A085 X0 10 00 _ _

M 43 A100 X0 10 00 _ _

M 43 A150 X0 10 00 _ _

M 43 A200 X0 10 00 _ _

ASTA VERTEBRATA



L'asta vertebrata è composta da un profilo in alluminio estruso forato a passo 25 mm per l'inserimento della molla antiribaltamento. L'asta antiribaltamento viene fornita completa di accessori in plastica e struttura superiore predisposta per la chiusura a cilindro o elettronica.

ART.	H utile inserimento cassette mm
M 00 V030 00 00 00 00	300
M 00 V050 00 00 00 00	500
M 00 V060 00 00 00 00	600
M 00 V070 00 00 00 00	700
M 00 V075 00 00 00 00	750
M 00 V090 00 00 00 00	900

ART.	H utile inserimento cassette mm
M 00 V105 00 00 00 00	1050
M 00 V122 00 00 00 00	1225
M 00 V140 00 00 00 00	1400
M 00 V152 00 00 00 00	1525
M 00 V190 00 00 00 00	1900

CHIUSURA CON CILINDRO (KEY)



CHIUSURA A CILINDRO COMPLETA DI:

- 1 serratura a cilindro con 2 chiavi
- 1 filo in acciaio con guaina
- 1 gruppo percussore anteriore
- 1 gruppo cursore posteriore

ART.		
M 33 V000 C0 00 00 00	C0	CHIUSURA A CILINDRO CON NUMERAZIONE DIVERSA
M 33 V000 C1 00 00 00	C1	CHIUSURA A CILINDRO PER GRUPPI DI 160 NUMERI
M 33 V000 C2 00 00 00	C2	CHIUSURA A CILINDRO CON NUMERAZIONE UGUALE

For Experts Only

CHIUSURA CON CODICE NUMERICO (CODE)



ART.	
M 43 V000 E2 00 00 00	E2 APERTURA/CHIUSURA ASTA (alimentazione a batteria)
M 43 V000 E5 00 00 00	E5 APERTURA/CHIUSURA ASTA (alimentazione da rete elettrica)
M 43 V000 T2 00 00 00	T2 APERTURA/CHIUSURA ASTA + PORTA (alimentazione a batteria)
M 43 V000 T3 00 00 00	T3 APERTURA/CHIUSURA ASTA + PORTA (alimentazione da rete elettrica)

ART. TELECOMANDO

M 00 VRC0 00 00 00 00	Modulo ricevitore con telecomando
M 00 VRC0 00 00 01 00	Telecomando aggiuntivo



PIANI PER SERRATURE E PIANI REGOLABILI

PIANO SUPERIORE PER SERRATURE



ART.		H frontale mm	kg
M 43 PS46 00 10 00 __		46	150

Dim. mm 816x724x46 H

PIANO INFERIORE PER SERRATURE



ART.		H frontale mm	kg
M 43 PS46 10 10 00 __		46	150

Dim. mm 816x724x46 H

PIANO REGOLABILE



ART.		H totale mm	kg
M 43 PR25 00 00 01 __		60	100

Dim. utili mm 810x631x60 H

PIANO REGOLABILE FESSURATO



ART.		H frontale mm	kg
M 43 PR35 10 00 01 __		35	250

Dim. mm 816x721x35 H

45x36 EH

MATERIALE DI SEPARAZIONE

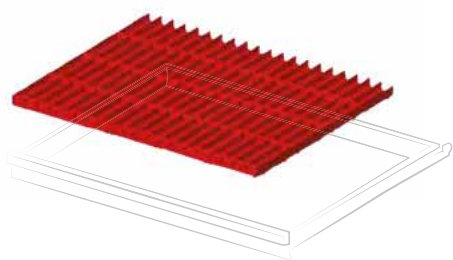

ART. per altezza frontale mm

F FH 3005 10 00 50 - 300

Set composto da: 20 divisori 4 canali,
130 divisori trasversali 36 mm

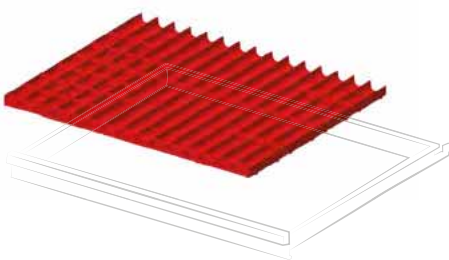

ART. per altezza frontale mm

F FH 3005 12 00 50 - 300

Set composto da: 20 divisori 3 canali,
100 divisori trasversali 47 mm

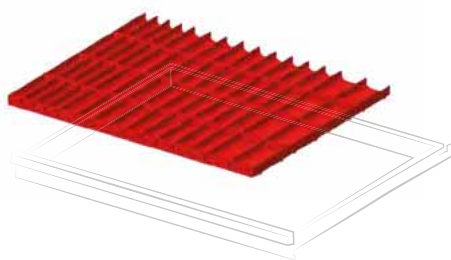

ART. per altezza frontale mm

F FH 3005 13 00 50 - 300

Set composto da: 4 divisori 4 canali, 12 divisori
3 canali, 4 divisori 2 canali, 16 divisori trasversali
36 mm, 36 divisori trasversali 47 mm, 8 divisori
trasversali 73 mm

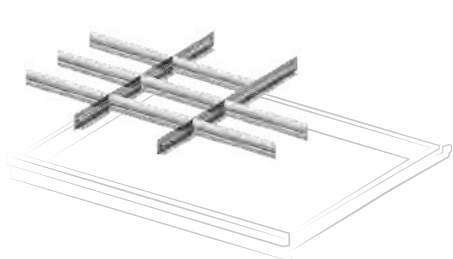

ART. per altezza frontale mm

F FH 3010 02 00 100 - 125

F FH 3015 02 00 150

F FH 3020 02 00 200 - 250

F FH 3030 02 00 300

Set composto da: 2 divisori longitudinali fessurati
610 mm, 8 divisori trasversali 251 mm

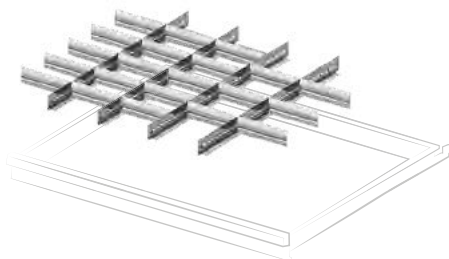

ART. per altezza frontale mm

F FH 3007 03 00 75

F FH 3010 03 00 100 - 125

F FH 3015 03 00 150

F FH 3020 03 00 200 - 250

F FH 3030 03 00 300

Set composto da: 4 divisori longitudinali fessurati
610 mm, 21 divisori trasversali 149 mm

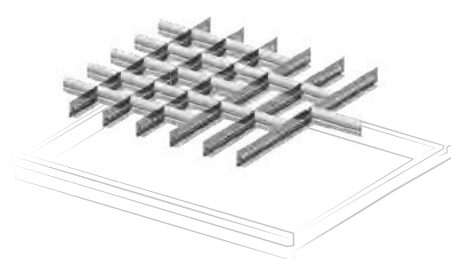

ART. per altezza frontale mm

F FH 3005 06 00 50

F FH 3007 06 00 75

F FH 3010 06 00 100 - 125

Set composto da: 6 divisori longitudinali fessurati
610 mm, 24 divisori trasversali 98 mm,
1 divisorio trasversale 149 mm

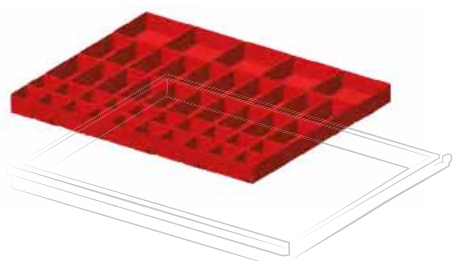

ART. per altezza frontale mm

F FH 3005 07 00 50

F FH 3007 07 00 75

Set composto da: 20 cassette divisorio 75x75 mm,
20 cassette divisorio 150x75 mm, 5 cassette
divisorio 150x150 mm

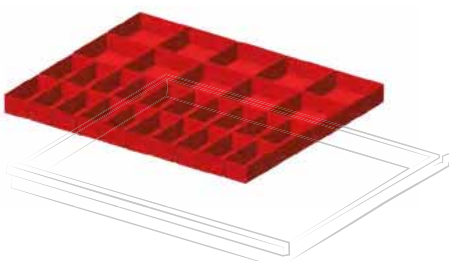

ART. per altezza frontale mm

F FH 3005 08 00 50

F FH 3007 08 00 75

F FH 3010 08 00 100 - 125

Set composto da: 20 cassette divisorio 150x75 mm,
10 cassette divisorio 150x150 mm

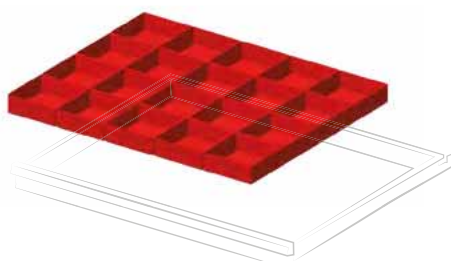

ART. per altezza frontale mm

F FH 3005 09 00 50

F FH 3007 09 00 75

F FH 3010 09 00 100 - 125

Set composto da: 20 cassette divisorio 150x150 mm

CONFIGURA IL CASSETTO FAMI CON UTENSILI BETA

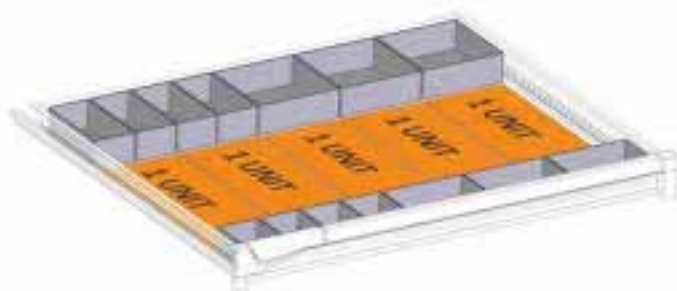

ART. F FH 3007 50 07

Set di predisposizione cassetto per termoformati Beta composto da:

n. 4 F HC 6071 00 07

n. 7 F HC 6471 00 07

n. 3 F HC 6871 00 07

1 unit = 1 termoformato Beta 367x147 mm

2 unit = 1 termoformato Beta 367x294 mm



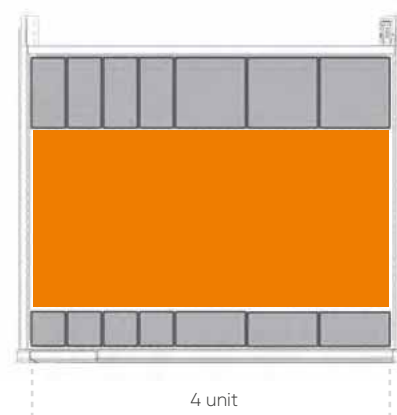
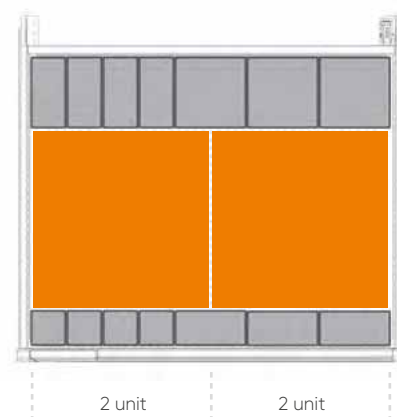
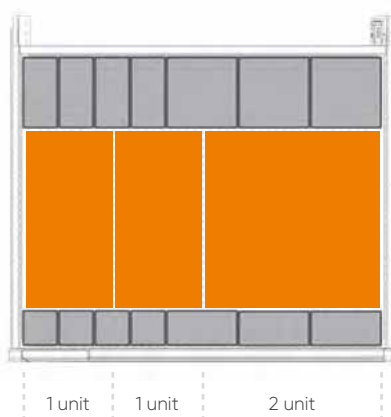
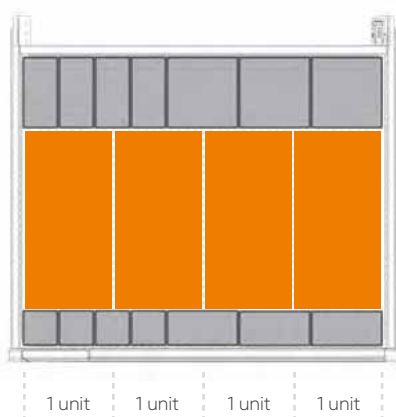

4 unit = 1 termoformato Beta 367x588 mm

ESEMPI DI UTILIZZO TERMOFORMATO













Gamma colori ACCIAIO

 GRIGIO RAL 7000 .01	 VERDE RAL 6011 .02
 BLU RAL 5012 .04	 GRIGIO RAL 7035 .08
 BIANCO GRIGIASTRO RAL 9002 .1F	 ROSSO RUBINO RAL 3003 .1G
 BLU GENZIANA RAL 5010 .34	 BIANCO PURO RAL 9010 .35
 GRIGIO ANTRACITE RAL 7016 .39	 BLU CAPRI RAL 5019 .48



● ART. M 53 A100 CO 10 BE 04
H = 1000 mm - 6 cassetti

Gamma colori PLASTICHE

 DARK GREY .M0	 MEDITERRANEAN BLUE .M1	 SKY BLUE .M2	 GLAMOUR RED .M3
 RED CARPET .M4	 JUICE ORANGE .M5	 SUNNY YELLOW .M6	 FOREST GREEN .M7

LEGENDA



PORTATA
CASSETTO/
PIANO



ESTRAZIONE
CASSETTO/
PIANO



CHIUSURA
ARMADIO



LE PORTATE SONO NETTE E SI RIFERISCONO A PESI UNIFORMEMENTE DISTRIBUITI

H 700 mm



ART.		kg			
M 53 A070 C0 10 49 04		50-75-100	100-96-92%	key	
M 53 A070 C0 10 50 04		200	100%	key	
M 53 A070 E2 10 49 04		50-75-100	100-96-92%	code	
M 53 A070 E2 10 50 04		200	100%	code	

H 700 mm



ART.		kg			
M 53 A070 C0 10 31 04		50-75-100	100-96-92%	key	
M 53 A070 C0 10 51 04		200	100%	key	
M 53 A070 E2 10 31 04		50-75-100	100-96-92%	code	
M 53 A070 E2 10 51 04		200	100%	code	

H 850 mm



ART.		kg			
M 53 A085 C0 10 88 04		50-75-100	100-96-92%	key	
M 53 A085 C0 10 AP 04		200	100%	key	
M 53 A085 E2 10 88 04		50-75-100	100-96-92%	code	
M 53 A085 E2 10 AP 04		200	100%	code	

H 850 mm



ART.		kg			
M 53 A085 C0 10 AA 04		50-75-100	100-96-92%	key	
M 53 A085 C0 10 AB 04		200	100%	key	
M 53 A085 E2 10 AA 04		50-75-100	100-96-92%	code	
M 53 A085 E2 10 AB 04		200	100%	code	

H 850 mm



ART.				
M 53 A085 C0 10 AM 04		50-75-100	100-96-92%	key
M 53 A085 C0 10 AN 04		200	100%	key
M 53 A085 E2 10 AM 04		50-75-100	100-96-92%	code
M 53 A085 E2 10 AN 04		200	100%	code

H 850 mm



*estrazione flessibile

ART.				
M 53 A085 C0 10 AE 04		50-75-100	100-96-92%	key
M 53 A085 C0 10 AF 04		200	100%	key
M 53 A085 E2 10 AE 04		50-75-100	100-96-92%	code
M 53 A085 E2 10 AF 04		200	100%	code

H 1000 mm



ART.				
M 53 A100 C0 10 BE 04		50-75-100	100-96-92%	key
M 53 A100 C0 10 BF 04		200	100%	key
M 53 A100 E2 10 BE 04		50-75-100	100-96-92%	code
M 53 A100 E2 10 BF 04		200	100%	code

H 1000 mm



ART.				
M 53 A100 C0 10 AW 04		50-75-100	100-96-92%	key
M 53 A100 C0 10 BH 04		200	100%	key
M 53 A100 E2 10 AW 04		50-75-100	100-96-92%	code
M 53 A100 E2 10 BH 04		200	100%	code

H 1000 mm



H 1000 mm



ART.				
M 53 A100 C0 10 DD 04		50-75-100	100-96-92%	key
M 53 A100 C0 10 DE 04		200	100%	key
M 53 A100 E2 10 DD 04		50-75-100	100-96-92%	code
M 53 A100 E2 10 DE 04		200	100%	code

ART.				
M 53 A100 C5 10 CW 04		50-75-100	100-96-92%	-
M 53 A100 C5 10 CX 04		200	100%	-

H 1023 mm



porta 900 mm profondità 751 mm

ART.				
M 53 A100 C0 10 CA 04		50-75-100	100-96-92%	key
M 53 A100 C0 10 CB 04		200	100%	key
M 53 A100 P5 10 CA 04		50-75-100	100-96-92%	code
M 53 A100 P5 10 CB 04		200	100%	code

H 1023 mm



porta 900 mm profondità 751 mm

ART.				
M 53 A100 C0 10 CE 04		50-75-100	100-96-92%	key
M 53 A100 C0 10 CF 04		200	100%	key
M 53 A100 P5 10 CE 04		50-75-100	100-96-92%	code
M 53 A100 P5 10 CF 04		200	100%	code

H 1500 mm



ART.				
M 53 A150 C0 10 FJ 04		50-75-100	100-96-92%	key
M 53 A150 C0 10 FK 04		200	100%	key
M 53 A150 E2 10 FJ 04		50-75-100	100-96-92%	code
M 53 A150 E2 10 FK 04		200	100%	code

H 1500 mm



porta 1400 mm profondità 751 mm

ART.				
M 53 A150 C0 10 LC 04		50-75-100	100-96-92%	key
M 53 A150 C0 10 LD 04		200	100%	key
M 53 A150 P5 10 LC 04		50-75-100	100-96-92%	code
M 53 A150 P5 10 LD 04		200	100%	code

H 2000 mm



ART.				
M 53 A200 C5 10 FU 04		50-75-100	100-96-92%	key
M 53 A200 C5 10 FV 04		200	100%	code

H 2000 mm



ART.				
M 53 A200 C0 10 FS 04		50-75-100	100-96-92%	key
M 53 A200 C0 10 FT 04		200	100%	key
M 53 A200 E2 10 FS 04		50-75-100	100-96-92%	code
M 53 A200 E2 10 FT 04		200	100%	code



H 2000 mm



piano regolabile

piano regolabile

piano regolabile

7 cassetti

75
75
100
150
150
150
200

porta 900 mm

ART.					
M 53 A200 C0 10 FY 04		50-75-100	100-96-92%	key	
M 53 A200 C0 10 FZ 04		200	100%	key	
M 53 A200 T2 10 FY 04		50-75-100	100-96-92%	code	
M 53 A200 T2 10 FZ 04		200	100%	code	

H 2000 mm



piano regolabile

piano regolabile

3 cassetti

100
100
150

piano estraibile

piano estraibile

porta 1900 mm

ART.					
M53A200 C010 FW 04		50-75-100	100-96-92%	key	
M 53 A200 C0 10 FX 04		200	100%	key	
M 53 A200 P5 10 FW 04		50-75-100	100-96-92%	code	
M 53 A200 P5 10 FX 04		200	100%	code	

MASTER

2040x751 mm

H 873 mm



H 1023 mm



ART.		kg			porta singola
M 53 D085 C0 10 GJ 04		50-75-100	100-96-92%	key	
M 53 D085 C0 10 GK 04		200	100%	key	

ART.		kg			porta singola
M 53 D100 C0 10 GQ 04		50-75-100	100-96-92%	key	
M 53 D100 C0 10 GR 04		200	100%	key	



ART. M 53 D150 C0 10 PF NR

H 873 mm

2 cassetti

75x2

piano
3 bordi



porta doppia

ART.		kg			
M 53 D085 C010 GL 04		50-75-100	100-96-92%	key	
M 53 D085 C010 GM 04		200	100%	key	

H 1023 mm

piano
3 bordi



porta doppia

ART.		kg			
M 53 D100 C010 HQ 04		50-75-100	100-96-92%	key	
M 53 D100 C010 HR 04		200	100%	key	

H 1500 mm

6 cassetti

75x2

75x2

100x2



porta doppia

ART.		kg			
M 53 D150 C010 JE 04		50-75-100	100-96-92%	key	
M 53 D150 C010 JF 04		200	100%	key	

H 2000 mm

6 cassetti

75x2

100x2

150x2



porta doppia

ART.		kg			
M 53 D200 C010 JJ 04		50-75-100	100-96-92%	key	
M 53 D200 C010 JK 04		200	100%	key	

H 963 mm



ART.				
M 53 R070 S0 10 31 04		50-75-100	100-96-92%	key
M 53 R070 P2 10 31 04		50-75-100	100-96-92%	code

Portata armadio 600 kg - Altezza armadio senza ruote mm 763

H 963 mm



ART.				
M 53 R070 S0 10 44 04		50-75-100	100-96-92%	key
M 53 R070 P2 10 44 04		50-75-100	100-96-92%	code

Portata armadio 600 kg - Altezza armadio senza ruote mm 763

H 1113 mm



ART.				
M 53 R085 S0 10 88 04		50-75-100	100-96-92%	key
M 53 R085 P2 10 88 04		50-75-100	100-96-92%	code

Portata armadio 600 kg - Altezza armadio senza ruote mm 913

H 1113 mm



ART.				
M 53 R085 S0 10 AA 04		50-75-100	100-96-92%	key
M 53 R085 P2 10 AA 04		50-75-100	100-96-92%	code

Portata armadio 600 kg - Altezza armadio senza ruote mm 913



2 ruote girevoli con freno in gomma elastica Ø 160 mm
2 ruote fisse in gomma elastica Ø 160 mm

H 1263 mm



H 1263 mm



ART.			
M 53 R100 S0 10 CQ 04	50-75-100	100-96-92%	key
M 53 R100 P2 10 CQ 04	50-75-100	100-96-92%	code

Portata armadio 600 kg - Altezza armadio senza ruote mm 1063

ART.			
M 53 R100 S0 10 AW 04	50-75-100	100-96-92%	key
M 53 R100 P2 10 AW 04	50-75-100	100-96-92%	code

Portata armadio 600 kg - Altezza armadio senza ruote mm 1063



2 ruote girevoli con freno in gomma elastica Ø 160 mm
2 ruote fisse in gomma elastica Ø 160 mm



ART. M 53 R070 P2 14 PG 35

CONFIGURA IL TUO ARMADIO

	SCEGLI l'altezza	SCEGLI la chiusura		SCEGLI il colore
M53	A040	C5	10 00	01

ARMADIO VUOTO



Portata corpo
armadio 3100 kg

M53	ALTEZZA		CHIUSURA		10 00	COLORE	
	A070	700 mm (utile 600 mm)	X0 senza asta e senza serratura			01 RAL 7000	
A085	850 mm (utile 750 mm)	C5* senza serratura		02 RAL 6011			
A100	1000 mm (utile 900 mm)	C0* KEY chiusura a cilindro		1G RAL 3003			
A132	1325 mm (utile 1225 mm)	C1* KEY chiusura a cilindro		1F RAL 9002			
A150	1500 mm (utile 1400 mm)	C2* KEY chiusura a cilindro		48 RAL 5019			
A200	2000 mm (utile 1900 mm)	E2* CODE codice numerico		39 RAL 7016			
		T2* CODE codice numerico		04 RAL 5012			
				08 RAL 7035			
				35 RAL 9010			
				34 RAL 5010			

*COMPLETA DI ASTA VERTEBRATA

ARMADIO VUOTO predisposto per ruote



M53	ALTEZZA		CHIUSURA		10 00	COLORE	
	R070	763 mm (utile 600 mm)	S0 KEY chiusura a cilindro			01 RAL 7000	
R085	913 mm (utile 750 mm)	S1 KEY chiusura a cilindro		02 RAL 6011			
R100	1063 mm (utile 900 mm)	S2 KEY chiusura a cilindro		1G RAL 3003			
		P2 CODE codice numerico		1F RAL 9002			
		A1 CODE codice numerico		48 RAL 5019			
				39 RAL 7016			
				04 RAL 5012			
				08 RAL 7035			
				35 RAL 9010			
				34 RAL 5010			

COMPLETO DI ASTA VERTEBRATA, PIANO A 4 BORDI CON COPERTURA IN PVC, COPPIA MANIGLIE, COPPIA PIASTRE
Dim. ingombro mm 1094x752



CASSETTI AD ESTRAZIONE FLESSIBILE

ART. CON kit plastiche Dark Grey	ART. SENZA kit plastiche*	Dim. utili mm	H frontale mm	kg	
M 53 C050 0110 OF __	M 53 C050 01 00 OF __	906x600x31 H	50	50 - 75 - 100	100% - 96% - 92%
M 53 C075 0110 OF __	M 53 C075 01 00 OF __	906x600x56 H	75	50 - 75 - 100	100% - 96% - 92%
M 53 C100 0110 OF __	M 53 C100 01 00 OF __	906x600x81 H	100	50 - 75 - 100	100% - 96% - 92%
M 53 C125 0110 OF __	M 53 C125 01 00 OF __	906x600x106 H	125	50 - 75 - 100	100% - 96% - 92%
M 53 C150 0110 OF __	M 53 C150 01 00 OF __	906x600x131 H	150	50 - 75 - 100	100% - 96% - 92%
M 53 C200 0110 OF __	M 53 C200 01 00 OF __	906x600x181 H	200	50 - 75 - 100	100% - 96% - 92%
M 53 C250 0110 OF __	M 53 C250 01 00 OF __	906x600x231 H	250	50 - 75 - 100	100% - 96% - 92%
M 53 C300 0110 OF __	M 53 C300 01 00 OF __	906x600x281 H	300	50 - 75 - 100	100% - 96% - 92%

* ABBINARE AL CODICE ARTICOLO UNO DEI KIT PLASTICHE DISPONIBILI NELLA TABELLA SOTTOSTANTE



CASSETTI AD ESTRAZIONE TELESCOPICA

ART. CON kit plastiche Dark Grey	ART. SENZA kit plastiche*	Dim. utili mm	H frontale mm	kg	
M 53 C075 0110 OT __	M 53 C075 01 00 OT __	906x600x56 H	75	200	100%
M 53 C100 0110 OT __	M 53 C100 01 00 OT __	906x600x81 H	100	200	100%
M 53 C125 0110 OT __	M 53 C125 01 00 OT __	906x600x106 H	125	200	100%
M 53 C150 0110 OT __	M 53 C150 01 00 OT __	906x600x131 H	150	200	100%
M 53 C200 0110 OT __	M 53 C200 01 00 OT __	906x600x181 H	200	200	100%
M 53 C250 0110 OT __	M 53 C250 01 00 OT __	906x600x231 H	250	200	100%
M 53 C300 0110 OT __	M 53 C300 01 00 OT __	906x600x281 H	300	200	100%

* ABBINARE AL CODICE ARTICOLO UNO DEI KIT PLASTICHE DISPONIBILI NELLA TABELLA SOTTOSTANTE

KIT PLASTICHE PER CASSETTI E PIANI ESTRAIBILI



GAMMA COLORI PLASTICHE	ART.
MEDITERRANEAN BLUE	M 50 PLS1 00 00 00 M1
SKY BLUE	M 50 PLS1 00 00 00 M2
GLAMOUR RED	M 50 PLS1 00 00 00 M3
RED CARPET	M 50 PLS1 00 00 00 M4
JUICY ORANGE	M 50 PLS1 00 00 00 M5
SUNNY YELLOW	M 50 PLS1 00 00 00 M6
FOREST GREEN	M 50 PLS1 00 00 00 M7



PIANI ESTRAIBILI AD ESTRAZIONE FLESSIBILE

ART. CON kit plastiche Dark Grey	ART. SENZA kit plastiche*	Dim. utili mm	H frontale mm	kg	
M 53 C057 0110 OF _ _	M 53 C057 0100 OF _ _	906x600	70	50 - 75 - 100	100% - 96% - 92%

* ABBINARE AL CODICE ARTICOLO UNO DEI KIT PLASTICHE DISPONIBILI NELLA TABELLA SOTTOSTANTE



PIANI ESTRAIBILI AD ESTRAZIONE TELESCOPICA

ART. CON kit plastiche Dark Grey	ART. SENZA kit plastiche*	Dim. utili mm	H frontale mm	kg	
M 53 C057 0110 OT _ _	M 53 C057 0100 OT _ _	906x600	70	200	100%

* ABBINARE AL CODICE ARTICOLO UNO DEI KIT PLASTICHE DISPONIBILI NELLA TABELLA SOTTOSTANTE



PIANO REGOLABILE

ART.	Dim. utili mm	H totale mm	kg
M 53 PR25 00 00 01 _ _	963x631	60	100

INSERIBILE DAVANTI ALL'ASTA VERTEBRATA

KIT PLASTICHE PER CASSETTI E PIANI ESTRAIBILI

















GAMMA COLORI PLASTICHE	ART.
MEDITERRANEAN BLUE	M 50 PLS1 00 00 00 M1
SKY BLUE	M 50 PLS1 00 00 00 M2
GLAMOUR RED	M 50 PLS1 00 00 00 M3
RED CARPET	M 50 PLS1 00 00 00 M4
JUICY ORANGE	M 50 PLS1 00 00 00 M5
SUNNY YELLOW	M 50 PLS1 00 00 00 M6
FOREST GREEN	M 50 PLS1 00 00 00 M7



ART. M ZA 0400 00 00 00 08

🔑 PORTE A BATTENTE CON CILINDRO

COPPIA PORTE A BATTENTE ALTEZZA TOTALE

H ARMADIO mm	TIPO DI CHIUSURA	ART. CON kit plastiche Dark Grey 	ART. SENZA kit plastiche* 
850	 C0 KEY chiusura a cilindro	M 50 P075 C0 10 10 _ _	M 50 P075 C0 00 10 _ _
	 C1 KEY chiusura a cilindro	M 50 P075 C1 10 10 _ _	M 50 P075 C1 00 10 _ _
	 C2 KEY chiusura a cilindro	M 50 P075 C2 10 10 _ _	M 50 P075 C2 00 10 _ _
1000	 C0 KEY chiusura a cilindro	M 50 P090 C0 10 10 _ _	M 50 P090 C0 00 10 _ _
	 C1 KEY chiusura a cilindro	M 50 P090 C1 10 10 _ _	M 50 P090 C1 00 10 _ _
	 C2 KEY chiusura a cilindro	M 50 P090 C2 10 10 _ _	M 50 P090 C2 00 10 _ _
1500	 C0 KEY chiusura a cilindro	M 50 P140 C0 10 10 _ _	M 50 P140 C0 00 10 _ _
	 C1 KEY chiusura a cilindro	M 50 P140 C1 10 10 _ _	M 50 P140 C1 00 10 _ _
	 C2 KEY chiusura a cilindro	M 50 P140 C2 10 10 _ _	M 50 P140 C2 00 10 _ _
2000	 C0 KEY chiusura a cilindro	M 50 P190 C0 10 10 _ _	M 50 P190 C0 00 10 _ _
	 C1 KEY chiusura a cilindro	M 50 P190 C1 10 10 _ _	M 50 P190 C1 00 10 _ _
	 C2 KEY chiusura a cilindro	M 50 P190 C2 10 10 _ _	M 50 P190 C2 00 10 _ _





* ABBINARE AL CODICE ARTICOLO UNO DEI KIT PLASTICHE DISPONIBILI NELLA TABELLA A DESTRA



LA COPPIA PORTE DEVE ESSERE ASSOCIATA OBBLIGATORIAMENTE AGLI ARMADI CON LA CHIUSURA:

C5 (SENZA SERRATURA) OPPURE **X0** (SENZA ASTA VERTEBRATA E SENZA SERRATURA)

COPPIA PORTE A BATTENTE ALTEZZA PARZIALE

H INGOMBRO PORTA mm	TIPO DI CHIUSURA	ART. CON kit plastiche Dark Grey 	ART. SENZA kit plastiche* 
775	 C0 KEY chiusura a cilindro	M 50 P077 C0 10 11 _ _	M 50 P077 C0 00 11 _ _
	 C1 KEY chiusura a cilindro	M 50 P077 C1 10 11 _ _	M 50 P077 C1 00 11 _ _
	 C2 KEY chiusura a cilindro	M 50 P077 C2 10 11 _ _	M 50 P077 C2 00 11 _ _

* ABBINARE AL CODICE ARTICOLO UNO DEI KIT PLASTICHE DISPONIBILI NELLA TABELLA A DESTRA



1 2 3 4 5 C

PORTE A BATTENTE CON CODICE NUMERICO

COPPIA PORTE A BATTENTE ALTEZZA TOTALE



H ARMADIO mm	TIPO DI CHIUSURA	ART. CON kit plastiche Dark Grey	ART. SENZA kit plastiche*
850	P5 CODE codice numerico	M 50 P075 P5 10 10 _ _	M 50 P075 P5 00 10 _ _
1000	P5 CODE codice numerico	M 50 P090 P5 10 10 _ _	M 50 P090 P5 00 10 _ _
1500	P5 CODE codice numerico	M 50 P140 P5 10 10 _ _	M 50 P140 P5 00 10 _ _
2000	P5 CODE codice numerico	M 50 P190 P5 10 10 _ _	M 50 P190 P5 00 10 _ _

* ABBINARE AL CODICE ARTICOLO UNO DEI KIT PLASTICHE DISPONIBILI NELLA TABELLA SOTTOSTANTE

LA COPPIA PORTE DEVE ESSERE ASSOCIATA OBBLIGATORIAMENTE AGLI ARMADI CON LA CHIUSURA: **C5** (SENZA SERRATURA) OPPURE **X0** (SENZA ASTA VERTEBRATA E SENZA SERRATURA)

COPPIA PORTE A BATTENTE ALTEZZA PARZIALE



H INGOMBRO PORTA mm	TIPO DI CHIUSURA	ART. CON kit plastiche Dark Grey	ART. SENZA kit plastiche*
775	A4 maniglia senza tastierino	M 50 P077 A4 10 11 _ _	M 50 P077 A4 00 11 _ _

* ABBINARE AL CODICE ARTICOLO UNO DEI KIT PLASTICHE DISPONIBILI NELLA TABELLA SOTTOSTANTE

LA COPPIA PORTE DEVE ESSERE ASSOCIATA OBBLIGATORIAMENTE AGLI ARMADI CON LE CHIUSURE:
UTILIZZARE LA SERRATURA **T2** PER L'ARMADIO SENZA RUOTE
UTILIZZARE LA SERRATURA **A1** PER L'ARMADIO CON RUOTE

TELECOMANDO



ART.	
M 00 VRC0 00 00 00 00	Modulo ricevitore con telecomando
M 00 VRC0 00 00 01 00	Telecomando aggiuntivo

KIT PLASTICHE PER COPPIA PORTE

















GAMMA COLORI PLASTICHE	ART. KEY	ART. CODE
MEDITERRANEAN BLUE	M 00 PLS0 00 00 30 M1	M 00 PLS0 00 00 31 M1
SKY BLUE	M 00 PLS0 00 00 30 M2	M 00 PLS0 00 00 31 M2
GLAMOUR RED	M 00 PLS0 00 00 30 M3	M 00 PLS0 00 00 31 M3
RED CARPET	M 00 PLS0 00 00 30 M4	M 00 PLS0 00 00 31 M4
JUICY ORANGE	M 00 PLS0 00 00 30 M5	M 00 PLS0 00 00 31 M5
SUNNY YELLOW	M 00 PLS0 00 00 30 M6	M 00 PLS0 00 00 31 M6
FOREST GREEN	M 00 PLS0 00 00 30 M7	M 00 PLS0 00 00 31 M7

ARMADIO VUOTO



CON 2 PORTE SCORREVOLI







ARMADIO CON DOPPIA PORTA SCORREVOLE SENZA ASTA VERTEBRATA

H ARMADIO mm	TIPO DI CHIUSURA	ART. CON kit plastiche Dark Grey 	ART. SENZA kit plastiche* 
850 (utile 750 mm)	 C0 KEY chiusura a cilindro	M 53 D085 C0 10 0D __	M 53 D085 C0 00 0D __
	 C1 KEY chiusura a cilindro	M 53 D085 C1 10 0D __	M 53 D085 C1 00 0D __
	 C2 KEY chiusura a cilindro	M 53 D085 C2 10 0D __	M 53 D085 C2 00 0D __
1000 (utile 900 mm)	 C0 KEY chiusura a cilindro	M 53 D100 C0 10 0D __	M 53 D100 C0 00 0D __
	 C1 KEY chiusura a cilindro	M 53 D100 C1 10 0D __	M 53 D100 C1 00 0D __
	 C2 KEY chiusura a cilindro	M 53 D100 C2 10 0D __	M 53 D100 C2 00 0D __
1500 (utile 1400 mm)	 C0 KEY chiusura a cilindro	M 53 D150 C0 10 0D __	M 53 D150 C0 00 0D __
	 C1 KEY chiusura a cilindro	M 53 D150 C1 10 0D __	M 53 D150 C1 00 0D __
	 C2 KEY chiusura a cilindro	M 53 D150 C2 10 0D __	M 53 D150 C2 00 0D __
2000 (utile 1900 mm)	 C0 KEY chiusura a cilindro	M 53 D200 C0 10 0D __	M 53 D200 C0 00 0D __
	 C1 KEY chiusura a cilindro	M 53 D200 C1 10 0D __	M 53 D200 C1 00 0D __
	 C2 KEY chiusura a cilindro	M 53 D200 C2 10 0D __	M 53 D200 C2 00 0D __

* ABBINARE AL CODICE ARTICOLO UNO DEI KIT PLASTICHE DISPONIBILI NELLA TABELLA SOTTOSTANTE

KIT PLASTICHE PER PORTE SCORREVOLI



GAMMA COLORI PLASTICHE	ART. 2 PORTE SCORREVOLI	ART. 1 PORTA SCORREVOLE
 MEDITERRANEAN BLUE	M 00 PLS0 00 00 50 M1	M 00 PLS0 00 00 40 M1
 SKY BLUE	M 00 PLS0 00 00 50 M2	M 00 PLS0 00 00 40 M2
 GLAMOUR RED	M 00 PLS0 00 00 50 M3	M 00 PLS0 00 00 40 M3
 RED CARPET	M 00 PLS0 00 00 50 M4	M 00 PLS0 00 00 40 M4
 JUICY ORANGE	M 00 PLS0 00 00 50 M5	M 00 PLS0 00 00 40 M5
 SUNNY YELLOW	M 00 PLS0 00 00 50 M6	M 00 PLS0 00 00 40 M6
 FOREST GREEN	M 00 PLS0 00 00 50 M7	M 00 PLS0 00 00 40 M7

ARMADIO VUOTO

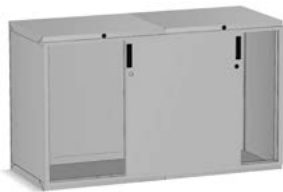

CON 1 PORTA SCORREVOLE

ARMADIO CON PORTA SCORREVOLE SINGOLA SENZA ASTA VERTEBRATA

H ARMADIO mm	TIPO DI CHIUSURA	ART. CON kit plastiche Dark Grey	ART. SENZA kit plastiche*
850 (utile 750 mm)	C0 KEY chiusura a cilindro	M 53 D085 C0 10 OS __	M 53 D085 C0 00 OS __
	C1 KEY chiusura a cilindro	M 53 D085 C1 10 OS __	M 53 D085 C1 00 OS __
	C2 KEY chiusura a cilindro	M 53 D085 C2 10 OS __	M 53 D085 C2 00 OS __
1000 (utile 900 mm)	C0 KEY chiusura a cilindro	M 53 D100 C0 10 OS __	M 53 D100 C0 00 OS __
	C1 KEY chiusura a cilindro	M 53 D100 C1 10 OS __	M 53 D100 C1 00 OS __
	C2 KEY chiusura a cilindro	M 53 D100 C2 10 OS __	M 53 D100 C2 00 OS __

* ABBINARE AL CODICE ARTICOLO UNO DEI KIT PLASTICHE DISPONIBILI NELLA TABELLA A SINISTRA



PORTA SINGOLA con chiusura SOLO a dx. Solo il vano di sinistra è predisposto per l'inserimento di cassette e piani estraibili. **OBBLIGO** di inserimento dell'asta vertebrata in presenza di PIÙ DI 2 CASSETTI/PIANI ESTRAIBILI per vano.



CHIUSURA A CILINDRO

TIPO DI CHIUSURA	ART.
C0 KEY chiusura a cilindro	M 53 V000 C0 00 00 00
C1 KEY chiusura a cilindro	M 53 V000 C1 00 00 00
C2 KEY chiusura a cilindro	M 53 V000 C2 00 00 00

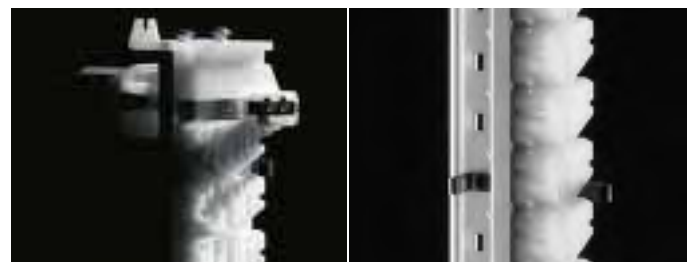

ASTA VERTEBRATA

H UTILE INSERIMENTO CASSETTI mm	ART.
750	M 00 V075 00 00 00 00
900	M 00 V090 00 00 00 00
1400	M 00 V140 00 00 00 00
1900	M 00 V190 00 00 00 00



PIANO SUPERIORE A 3 BORDI

ART.	dim. mm	
M 53 T023 AG 00 31 07	1020x726x23 H	

Piano rivestito in pvc per ARMADIO SINGOLO. Colore nero



PIANO SUPERIORE A 4 BORDI

ART.	dim. mm	
M 53 T023 AG 00 41 07	1020x726x23 H	

Piano rivestito in pvc per ARMADIO SINGOLO. Colore nero



ART. M 00 T023 AG 00 FO 00

FORATURA PIANO SUPERIORE DELL'ARMADIO PER IL FISSAGGIO DEL PIANO A 4 BORDI



PIANO SUPERIORE IN MULTIPLEX

ART.	dim. mm	
M 53 T040 MU 00 01 00	1020x726x40 H	

Per ARMADIO SINGOLO



PIANO SUPERIORE IN MDF DIM. 1020x726x32 mm H

ART.	rifiniture	per armadio	
M 53 T030 MD GM 21 07	1 profilo laterale	finale dx o sx	

Piano in MDF con copertura in gomma antiolio. Colore nero



PIANO SUPERIORE IN MDF DIM. 1020x726x32 mm H

ART.	rifiniture	per armadio	
M 53 T030 MD GM 11 07	-	centrale	

Piano in MDF con copertura in gomma antiolio. Colore nero



PIANO SUPERIORE IN MDF DIM. 1020x726x32 mm H

ART.	rifiniture	per armadio	
M 53 T030 MD GM 01 07	2 profili laterali	singolo	

Piano in MDF con copertura in gomma antiolio. Colore nero



ART. M 00 T030 MD 00 FO 00

FORATURA PIANO SUPERIORE DELL'ARMADIO PER IL FISSAGGIO DEL PIANO IN MDF E DEL PIANO IN MULTIPLEX COMPRESIVO DI VITI PER IL FISSAGGIO

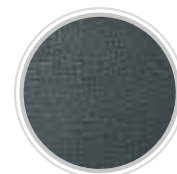

RIFINITURA
GOMMA
ANTIOLIO



APPLICAZIONE
PIANO IN MDF



**PIANO SUPERIORE IN MULTIPLEX PER
ARMADIO CON RUOTE**
DISPONIBILE SU RICHIESTA



ZOCCOLO DI RIALZO ALTEZZA 50 mm

ART.		dim. mm	
M 53 Z050 00 00 00 _ _		1018x725x50 H	



ZOCCOLO DI RIALZO ALTEZZA 100 mm

ART.		dim. mm	
M 53 Z100 00 00 00 _ _		1018x725x100 H	



ZOCCOLI PER CARRELLO ELEVATORE - Colore nero RAL 9005

ART.		dim. mm	
M 03 Z060 20 00 00 07	coppia zoccoli	200x722x60 H	
M 50 Z060 21 00 00 07	chiusura per coppia zoccoli	1014x46x55 H	



ART.		dim. mm	
M 03 Z100 20 00 00 07	coppia zoccoli	200x722x100 H	
M 50 Z100 21 00 00 07	chiusura per coppia zoccoli	1014x46x95 H	



RUOTA FISSA IN GOMMA ELASTICA

ART.	Ø mm	portata armadio kg	C mm
C RG BCE15 125	125	360	155
C RG BCE15 160	160	600	200



RUOTA GIREVOLE CON FRENO IN GOMMA ELASTICA

ART.	Ø mm	portata armadio kg	C mm
C RG DCE15 125	125	360	155
C RG DCE15 160	160	600	200



RUOTA FISSA IN NYLON

ART.	Ø mm	portata armadio kg	C mm
C RN BAD11 125	125	360	155
C RN BAD04 160	160	600	200



RUOTA GIREVOLE CON FRENO IN NYLON

ART.	Ø mm	portata armadio kg	C mm
C RN DAD11 125	125	360	155
CRNDAD04 160	160	600	200



RICAMBI - FISSAGGIO

SERRATURA DI RICAMBIO

ART. M 00 CSRO 8800 00 00

Serratura di ricambio con due chiavi



CHIAVE DI RICAMBIO

ART. M 00 CF00 0000 00 00

Specificare sempre il numero indicato nella serratura a cilindro dove si vuole sostituire la chiave



PASSEPARTOUT

ART. M 00 PF.. 0000 00 00

Disponibile in 23 serie, con numerazione da F 01 a F 23.

Passepartout serie F 01
Passepartout serie F 02
Passepartout serie F ..

ART. M 00 PF01 00 00 00 00
ART. M 00 PF02 00 00 00 00
ART. M 00 PF.. 00 00 00 00

SET FISSAGGIO TRA ARMADI

ART. M 00 FISO 00 00 00 99

Set di fissaggio armadio-armadio con 4 viti complete di dadi M8

ART. M 00 SVRO 00 00 00 99

Foratura e viteria per il fissaggio dei due armadi sovrapposti

SET DI FISSAGGIO A PAVIMENTO



ART. F AG 9200 00 99

Coppia staffe zincate per il fissaggio a pavimento dell'armadio

ART. F AG 9204 00 99

2 tasselli "HILTI" adatti per pavimenti in calcestruzzo non fessurato maggiore o uguale alla classe C20/25
Trazione consigliata del tassello: 2,9 kN
Diametro tassello: Ø 6 mm



MANIGLIA DI RICAMBIO

ART. M 00 PLS0 0000 22 M0

Maniglia di ricambio per porte disponibile in colore Dark Grey.



ALTRI COLORI A RICHIESTA



GLI ARMADI DEVONO ESSERE FISSATI A PAVIMENTO O A PARETE
SE SOVRAPPOSTI DEVONO ESSERE FISSATI OBBLIGATORIAMENTE A PARETE E LA LORO PORTATA DIVISA PER DUE



MASTER

1020x726 mm

Born To Be Extreme

ARMADIO VUOTO senza asta vertebrata e senza chiusura



H 700 mm
H utile 600 mm



H 850 mm
H utile 750 mm



H 1000 mm
H utile 900 mm



M 53 A070 X0 10 00 _ _ M 53 A085 X0 10 00 _ _ M 53 A100 X0 10 00 _ _

ASTA VERTEBRATA



L'asta vertebrata è composta da un profilo in alluminio estruso forato a passo 25 mm per l'inserimento della molla antiribaltamento. L'asta antiribaltamento viene fornita completa di accessori in plastica e struttura superiore predisposta per la chiusura a cilindro o elettronica.

ART.	H utile inserimento cassette mm
M 00 V030 00 00 00 00	300
M 00 V050 00 00 00 00	500
M 00 V060 00 00 00 00	600
M 00 V070 00 00 00 00	700
M 00 V075 00 00 00 00	750
M 00 V090 00 00 00 00	900

ART.	H utile inserimento cassette mm
M 00 V105 00 00 00 00	1050
M 00 V122 00 00 00 00	1225
M 00 V140 00 00 00 00	1400
M 00 V152 00 00 00 00	1525
M 00 V190 00 00 00 00	1900

CHIUSURA CON CILINDRO (KEY)



CHIUSURA A CILINDRO COMPLETA DI:

- 1 serratura a cilindro con 2 chiavi
- 1 filo in acciaio con guaina
- 1 gruppo percussore anteriore
- 1 gruppo cursore posteriore

ART.	
M 53 V000 C0 00 00 00	C0 CHIUSURA A CILINDRO CON NUMERAZIONE DIVERSA
M 53 V000 C1 00 00 00	C1 CHIUSURA A CILINDRO PER GRUPPI DI 160 NUMERI
M 53 V000 C2 00 00 00	C2 CHIUSURA A CILINDRO CON NUMERAZIONE UGUALE

For Experts Only



H 1325 mm
H utile 1225 mm



H 1500 mm
H utile 1400 mm



H 2000 mm
H utile 1900 mm



M 53 A132 X0 10 00 _ _ M 53 A150 X0 10 00 _ _ M 53 A200 X0 10 00 _ _

CHIUSURA CON CODICE NUMERICO (CODE)



ART.

M 53 V000 E2 00 00 00 E2 APERTURA/CHIUSURA ASTA (alimentazione a batteria)

M 53 V000 E5 00 00 00 E5 APERTURA/CHIUSURA ASTA (alimentazione da rete elettrica)

M 53 V000 T2 00 00 00 T2 APERTURA/CHIUSURA ASTA + PORTA (alimentazione a batteria)

M 53 V000 T3 00 00 00 T3 APERTURA/CHIUSURA ASTA + PORTA (alimentazione da rete elettrica)

ART. TELECOMANDO

M 00 VRC0 00 00 00 00 Modulo ricevitore con telecomando

M 00 VRC0 00 00 01 00 Telecomando aggiuntivo



PIANI PER SERRATURE E PIANI REGOLABILI

PIANO SUPERIORE PER SERRATURE



ART.



H frontale mm



M 53 PS46 00 10 00 _ _

46

150

Dim. mm 969x724x46 H

PIANO INFERIORE PER SERRATURE



ART.



H frontale mm



M 53 PS46 10 10 00 _ _

46

150

Dim. mm 969x724x46 H

PIANO REGOLABILE



ART.



H totale mm



M 53 PR25 00 00 01 _ _

60

100

Dim. utili mm 963x631x60 H

PIANO REGOLABILE FESSURATO



ART.



H frontale mm



M 53 PR35 10 00 01 _ _

35

250

Dim. mm 969x721x35 H

54x36 EH

MATERIALE DI SEPARAZIONE

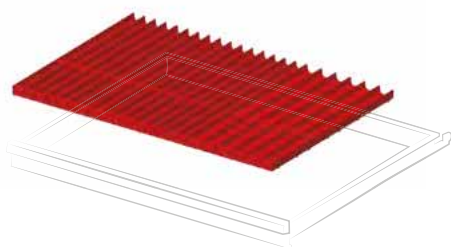

ART. per altezza frontale mm

F FH 5005 19 00 50 - 300

Set composto da: 16 divisori 4 canali, 8 divisori 3 canali, 30 divisori trasversali 36 mm, 10 divisori trasversali 47 mm

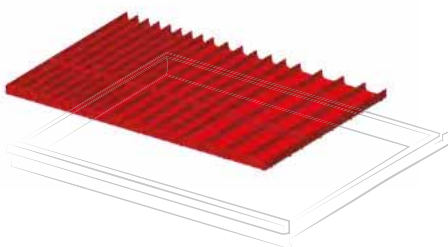

ART. per altezza frontale mm

F FH 5005 09 00 50 - 300

Set composto da: 8 divisori 4 canali, 8 divisori 3 canali, 8 divisori 2 canali, 15 divisori trasversali 36 mm, 10 divisori trasversali 47 mm, 6 divisori trasversali 73 mm

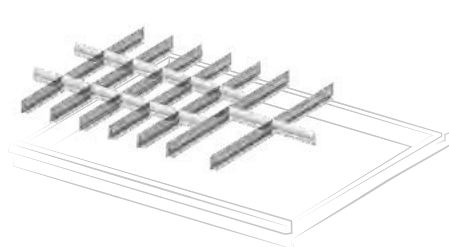

ART. per altezza frontale mm

F FH 5005 15 00 50

F FH 5007 15 00 75

F FH 5010 15 00 100 - 125

Set composto da: 7 divisori longitudinali fessurati 610 mm, 12 divisori trasversali 98 mm, 2 divisori trasversali 149 mm

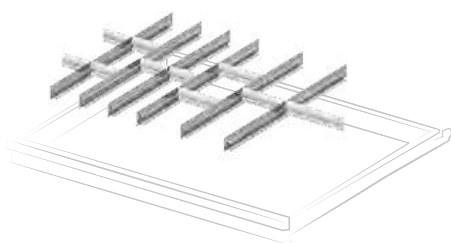

ART. per altezza frontale mm

F FH 5005 14 00 50

F FH 5007 14 00 75

F FH 5010 14 00 100 - 125

Set composto da: 6 divisori longitudinali fessurati 610 mm, 6 divisori trasversali 98 mm, 3 divisori trasversali 149 mm, 1 divisorio trasversale 200 mm

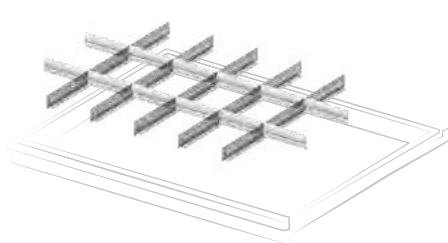

ART. per altezza frontale mm

F FH 5005 13 00 50

F FH 5007 13 00 75

F FH 5010 13 00 100 - 125

F FH 5015 13 00 150

F FH 5020 13 00 200 - 250

F FH 5030 13 00 300

Set composto da: 5 divisori longitudinali fessurati 610 mm, 12 divisori trasversali 149 mm

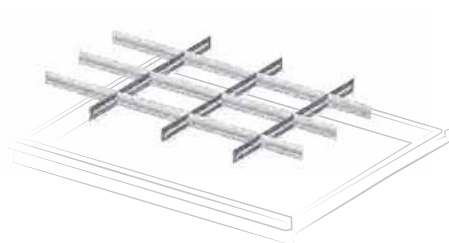

ART. per altezza frontale mm

F FH 5005 01 00 50

F FH 5007 01 00 75

F FH 5010 01 00 100 - 125

F FH 5015 01 00 150

F FH 5020 01 00 200 - 250

F FH 5030 01 00 300

Set composto da: 3 divisori longitudinali fessurati 610 mm, 3 divisori trasversali 149 mm, 9 divisori trasversali 251 mm

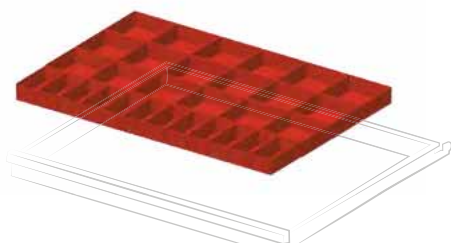

ART. per altezza frontale mm

F FH 5005 08 00 50

F FH 5007 08 00 75

F FH 5010 08 00 100 - 125

Set composto da: 12 cassette divisorio 150x75 mm, 18 cassette divisorio 150x150 mm

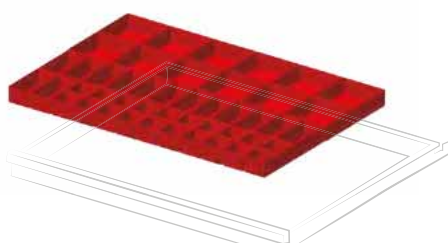

ART. per altezza frontale mm

F FH 5005 17 00 50

F FH 5007 17 00 75

Set composto da: 20 cassette divisorio 75x75 mm, 14 cassette divisorio 150x75 mm, 12 cassette divisorio 150x150 mm

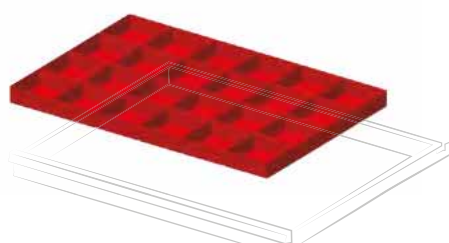

ART. per altezza frontale mm

F FH 5005 18 00 50

F FH 5007 18 00 75

F FH 5010 18 00 100 - 125

Set composto da: 24 cassette divisorio 150x150 mm

CONFIGURA IL CASSETTO FAMI CON UTENSILI BETA

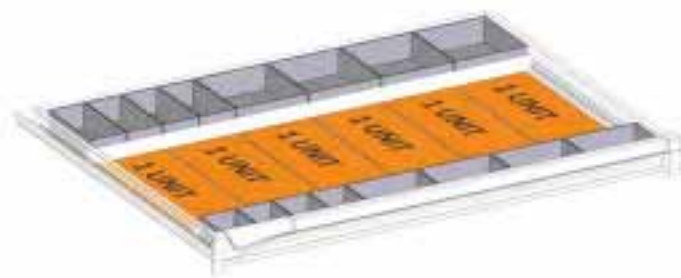

ART. F FH 5007 50 07

Set di predisposizione cassetto per termoformati Beta composto da:

- n. 4 F HC 6071 00 07
- n. 8 F HC 6471 00 07
- n. 4 F HC 6871 00 07
- n. 1 F HA 1150 00 99
- n. 1 F HA 2150 00 99







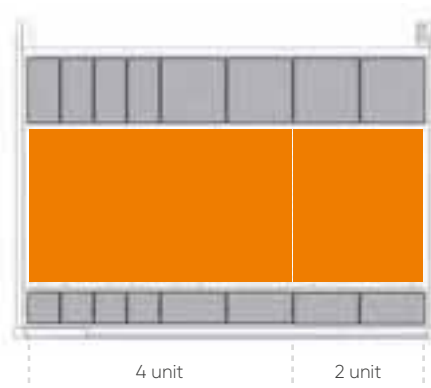
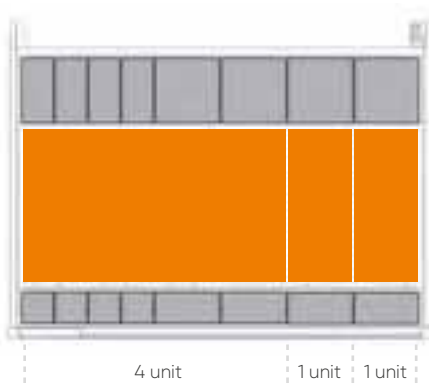
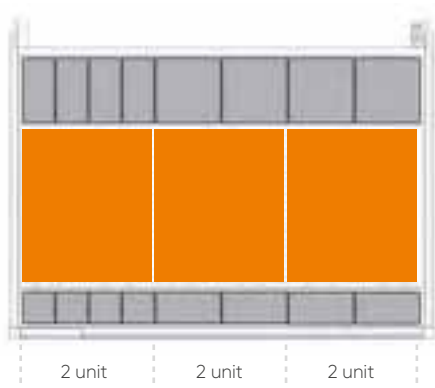
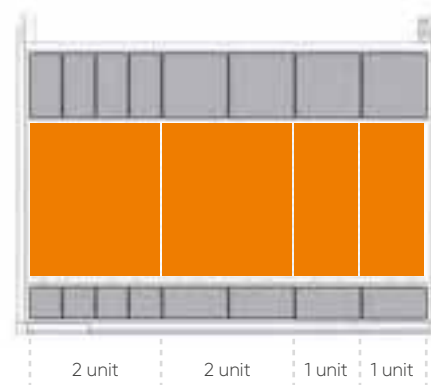
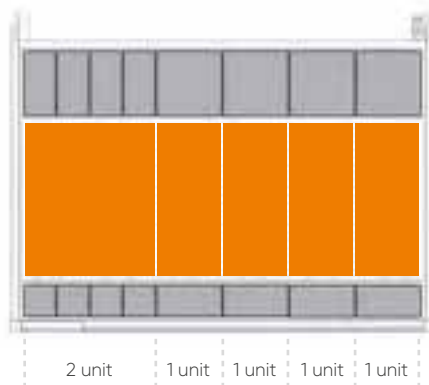
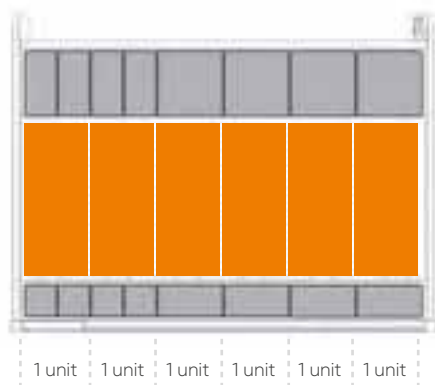

- 1 unit = 1 termoformato Beta 367x147 mm
- 2 unit = 1 termoformato Beta 367x294 mm
- 4 unit = 1 termoformato Beta 367x588 mm

ESEMPI DI UTILIZZO TERMOFORMATO











Gamma colori ACCIAIO

 GRIGIO RAL 7000 .01	 VERDE RAL 6011 .02
 BLU RAL 5012 .04	 GRIGIO RAL 7035 .08
 BIANCO GRIGIASTRO RAL 9002 .1F	 ROSSO RUBINO RAL 3003 .1G
 BLU GENZIANA RAL 5010 .34	 BIANCO PURO RAL 9010 .35
 GRIGIO ANTRACITE RAL 7016 .39	 BLU CAPRI RAL 5019 .48



● ART. M 63 A100 C0 10 CN 04
H = 1000 mm - 8 cassetti

Gamma colori PLASTICHE

 DARK GREY .M0	 MEDITERRANEAN BLUE .M1	 SKY BLUE .M2	 GLAMOUR RED .M3
 RED CARPET .M4	 JUICE ORANGE .M5	 SUNNY YELLOW .M6	 FOREST GREEN .M7

LEGENDA



PORTATA
CASSETTO/
PIANO



ESTRAZIONE
CASSETTO/
PIANO



CHIUSURA
ARMADIO



LE PORTATE SONO NETTE E SI RIFERISCONO A PESI UNIFORMEMENTE DISTRIBUITI

H 700 mm



ART.					
M 63 A070 C0 10 49 04		50-75-100	100-96-92%	key	
M 63 A070 C0 10 50 04		200	100%	key	
M 63 A070 E2 10 49 04		50-75-100	100-96-92%	code	
M 63 A070 E2 10 50 04		200	100%	code	

H 700 mm



ART.					
M 63 A070 C0 10 31 04		50-75-100	100-96-92%	key	
M 63 A070 C0 10 51 04		200	100%	key	
M 63 A070 E2 10 31 04		50-75-100	100-96-92%	code	
M 63 A070 E2 10 51 04		200	100%	code	

H 850 mm



ART.					
M 63 A085 C0 10 AA 04		50-75-100	100-96-92%	key	
M 63 A085 C0 10 AB 04		200	100%	key	
M 63 A085 E2 10 AA 04		50-75-100	100-96-92%	code	
M 63 A085 E2 10 AB 04		200	100%	code	

H 850 mm



ART.					
M 63 A085 C0 10 95 04		50-75-100	100-96-92%	key	
M 63 A085 C0 10 AU 04		200	100%	key	
M 63 A085 E2 10 95 04		50-75-100	100-96-92%	code	
M 63 A085 E2 10 AU 04		200	100%	code	

H 1000 mm



ART.					
M 63 A100 C0 10 CN 04		50-75-100	100-96-92%	key	
M 63 A100 C0 10 CP 04		200	100%	key	
M 63 A100 E2 10 CN 04		50-75-100	100-96-92%	code	
M 63 A100 E2 10 CP 04		200	100%	code	

H 1000 mm



ART.					
M 63 A100 C5 10 EC 04		50-75-100	100-96-92%	-	
M 63 A100 C5 10 ED 04		200	100%	-	

H 1023 mm



porta 900 mm profondità 751 mm

ART.					
M 63 A100 C0 10 BU 04		50-75-100	100-96-92%	key	
M 63 A100 C0 10 BV 04		200	100%	key	
M 63 A100 P5 10 BU 04		50-75-100	100-96-92%	code	
M 63 A100 P5 10 BV 04		200	100%	code	

H 1023 mm



porta 900 mm profondità 751 mm

ART.					
M 63 A100 C0 10 CA 04		50-75-100	100-96-92%	key	
M 63 A100 C0 10 CB 04		200	100%	key	
M 63 A100 P5 10 CA 04		50-75-100	100-96-92%	code	
M 63 A100 P5 10 CB 04		200	100%	code	

H 1500 mm



H 1500 mm



porta 1400 mm

profondità 751 mm

ART.		kg			
M 63 A150 C0 10 MB 04		50-75-100	100-96-92%	key	
M 63 A150 C0 10 MC 04		200	100%	key	
M 63 A150 E2 10 MB 04		50-75-100	100-96-92%	code	
M 63 A150 E2 10 MC 04		200	100%	code	

ART.		kg			
M 63 A150 C0 10 LC 04		50-75-100	100-96-92%	key	
M 63 A150 C0 10 LD 04		200	100%	key	
M 63 A150 P5 10 LC 04		50-75-100	100-96-92%	code	
M 63 A150 P5 10 LD 04		200	100%	code	



H 2000 mm



H 2000 mm



ART.				
M 63 A200 C5 10 FU 04		50-75-100	100-96-92%	-
M 63 A200 C5 10 FV 04		200	100%	-

ART.				
M 63 A200 C0 10 FS 04		50-75-100	100-96-92%	key
M 63 A200 C0 10 FT 04		200	100%	key
M 63 A200 E2 10 FS 04		50-75-100	100-96-92%	code
M 63 A200 E2 10 FT 04		200	100%	code



H 2000 mm



piano regolabile
piano regolabile
piano regolabile
7 cassetti
75
75
100
150
150
150
200

porta 900 mm

ART.				
M 63 A200 C0 10 FY 04		50-75-100	100-96-92%	key
M 63 A200 C0 10 FZ 04		200	100%	key
M 63 A200 T2 10 FY 04		50-75-100	100-96-92%	code
M 63 A200 T2 10 FZ 04		200	100%	code

H 2000 mm



piano regolabile
piano regolabile
3 cassetti
100
100
150
piano estraibile
piano estraibile

porta 1900 mm

ART.				
M 63 A200 C0 10 FW 04		50-75-100	100-96-92%	key
M 63 A200 C0 10 FX 04		200	100%	key
M 63 A200 P5 10 FW 04		50-75-100	100-96-92%	code
M 63 A200 P5 10 FX 04		200	100%	code



H 1113 mm



ART.				
M 63 R085 S0 10 88 04		50-75-100	100-96-92%	key
M 63 R085 P2 10 88 04		50-75-100	100-96-92%	code

Portata armadio 600 kg - Altezza armadio senza ruote mm 913

H 1113 mm



ART.				
M 63 R085 S0 10 95 04		50-75-100	100-96-92%	key
M 63 R085 P2 10 95 04		50-75-100	100-96-92%	code

Portata armadio 600 kg - Altezza armadio senza ruote mm 913

H 1263 mm



ART.				
M 63 R100 S0 10 DY 04		50-75-100	100-96-92%	key
M 63 R100 P2 10 DY 04		50-75-100	100-96-92%	code

Portata armadio 600 kg - Altezza armadio senza ruote mm 1063

H 1263 mm



ART.				
M 63 R100 S0 10 CN 04		50-75-100	100-96-92%	key
M 63 R100 P2 10 CN 04		50-75-100	100-96-92%	code

Portata armadio 600 kg - Altezza armadio senza ruote mm 1063



2 ruote girevoli con freno in gomma elastica Ø 160 mm
2 ruote fisse in gomma elastica Ø 160 mm



ART. M 63 R085 P2 16 PM 1G

CONFIGURA IL TUO ARMADIO

	SCEGLI l'altezza	SCEGLI la chiusura		SCEGLI il colore
M63	A040	C5	10 00	01

ARMADIO VUOTO



Portata corpo
armadio 3100 kg

M63	ALTEZZA		CHIUSURA		10 00	COLORE	
	Model	Height (mm) (useful mm)	Key/Code	Description		Color Code	Color Name
	A070	700 mm (utile 600 mm)	X0	senza asta e senza serratura		01	RAL 7000
	A085	850 mm (utile 750 mm)	C5*	senza serratura		02	RAL 6011
	A100	1000 mm (utile 900 mm)	C0*	KEY chiusura a cilindro		1G	RAL 3003
	A132	1325 mm (utile 1225 mm)	C1*	KEY chiusura a cilindro		1F	RAL 9002
	A150	1500 mm (utile 1400 mm)	C2*	KEY chiusura a cilindro		48	RAL 5019
	A200	2000 mm (utile 1900 mm)	E2*	CODE codice numerico		39	RAL 7016
			T2*	CODE codice numerico		04	RAL 5012
						08	RAL 7035
						35	RAL 9010
						34	RAL 5010

*COMPLETA DI ASTA VERTEBRATA

ARMADIO VUOTO predisposto per ruote



M63	ALTEZZA		CHIUSURA		10 00	COLORE	
	Model	Height (mm) (useful mm)	Key/Code	Description		Color Code	Color Name
	R085	913 mm (utile 750 mm)	S0	KEY chiusura a cilindro		01	RAL 7000
	R100	1063 mm (utile 900 mm)	S1	KEY chiusura a cilindro		02	RAL 6011
			S2	KEY chiusura a cilindro		1G	RAL 3003
			P2	CODE codice numerico		1F	RAL 9002
			A1	CODE codice numerico		48	RAL 5019
						39	RAL 7016
						04	RAL 5012
						08	RAL 7035
						35	RAL 9010
						34	RAL 5010

COMPLETO DI ASTA VERTEBRATA, PIANO A 4 BORDI CON COPERTURA IN PVC, COPPIA MANIGLIE, COPPIA PIASTRE
Dim. ingombro mm 1264x752



CASSETTI AD ESTRAZIONE FLESSIBILE

ART. CON kit plastiche Dark Grey	ART. SENZA kit plastiche*	Dim. utili mm	H frontale mm	kg	
M 63 C075 0110 OF __	M 63 C075 01 00 OF __	1076x600x56 H	75	50 - 75 - 100	100% - 96% - 92%
M 63 C100 0110 OF __	M 63 C100 01 00 OF __	1076x600x81 H	100	50 - 75 - 100	100% - 96% - 92%
M 63 C125 0110 OF __	M 63 C125 01 00 OF __	1076x600x106 H	125	50 - 75 - 100	100% - 96% - 92%
M 63 C150 0110 OF __	M 63 C150 01 00 OF __	1076x600x131 H	150	50 - 75 - 100	100% - 96% - 92%
M 63 C200 0110 OF __	M 63 C200 01 00 OF __	1076x600x181 H	200	50 - 75 - 100	100% - 96% - 92%
M 63 C250 0110 OF __	M 63 C250 01 00 OF __	1076x600x231 H	250	50 - 75 - 100	100% - 96% - 92%
M 63 C300 0110 OF __	M 63 C300 01 00 OF __	1076x600x281 H	300	50 - 75 - 100	100% - 96% - 92%

* ABBINARE AL CODICE ARTICOLO UNO DEI KIT PLASTICHE DISPONIBILI NELLA TABELLA SOTTOSTANTE



CASSETTI AD ESTRAZIONE TELESCOPICA

ART. CON kit plastiche Dark Grey	ART. SENZA kit plastiche*	Dim. utili mm	H frontale mm	kg	
M 63 C075 0110 OT __	M 63 C075 01 00 OT __	1076x600x56 H	75	200	100%
M 63 C100 0110 OT __	M 63 C100 01 00 OT __	1076x600x81 H	100	200	100%
M 63 C125 0110 OT __	M 63 C125 01 00 OT __	1076x600x106 H	125	200	100%
M 63 C150 0110 OT __	M 63 C150 01 00 OT __	1076x600x131 H	150	200	100%
M 63 C200 0110 OT __	M 63 C200 01 00 OT __	1076x600x181 H	200	200	100%
M 63 C250 0110 OT __	M 63 C250 01 00 OT __	1076x600x231 H	250	200	100%
M 63 C300 0110 OT __	M 63 C300 01 00 OT __	1076x600x281 H	300	200	100%

* ABBINARE AL CODICE ARTICOLO UNO DEI KIT PLASTICHE DISPONIBILI NELLA TABELLA SOTTOSTANTE

KIT PLASTICHE PER CASSETTI E PIANI ESTRAIBILI



GAMMA COLORI PLASTICHE	ART.
MEDITERRANEAN BLUE	M 60 PLS1 00 00 00 M1
SKY BLUE	M 60 PLS1 00 00 00 M2
GLAMOUR RED	M 60 PLS1 00 00 00 M3
RED CARPET	M 60 PLS1 00 00 00 M4
JUICY ORANGE	M 60 PLS1 00 00 00 M5
SUNNY YELLOW	M 60 PLS1 00 00 00 M6
FOREST GREEN	M 60 PLS1 00 00 00 M7



PIANI ESTRAIBILI AD ESTRAZIONE FLESSIBILE

ART. CON kit plastiche Dark Grey	ART. SENZA kit plastiche*	Dim. utili mm	H frontale mm	kg	
M 63 C057 0110 OF _ _	M 63 C057 0100 OF _ _	1076x600	70	50 - 75 - 100	100% - 96% - 92%

*ABBINARE AL CODICE ARTICOLO UNO DEI KIT PLASTICHE DISPONIBILI NELLA TABELLA SOTTOSTANTE



PIANI ESTRAIBILI AD ESTRAZIONE TELESCOPICA

ART. CON kit plastiche Dark Grey	ART. SENZA kit plastiche*	Dim. utili mm	H frontale mm	kg	
M 63 C057 0110 OT _ _	M 63 C057 0100 OT _ _	1076x600	70	200	100%

*ABBINARE AL CODICE ARTICOLO UNO DEI KIT PLASTICHE DISPONIBILI NELLA TABELLA SOTTOSTANTE



PIANO REGOLABILE

ART.	Dim. utili mm	H totale mm	kg
M 63 PR25 00 00 01 _ _	1133x631	60	150

INSERIBILE DAVANTI ALL'ASTA VERTEBRATA

KIT PLASTICHE PER CASSETTI E PIANI ESTRAIBILI



GAMMA COLORI PLASTICHE	ART.
MEDITERRANEAN BLUE	M 60 PLS1 00 00 00 M1
SKY BLUE	M 60 PLS1 00 00 00 M2
GLAMOUR RED	M 60 PLS1 00 00 00 M3
RED CARPET	M 60 PLS1 00 00 00 M4
JUICY ORANGE	M 60 PLS1 00 00 00 M5
SUNNY YELLOW	M 60 PLS1 00 00 00 M6
FOREST GREEN	M 60 PLS1 00 00 00 M7

















ART. M 63 A085 E2 10 PK 1G

🔑 PORTE A BATTENTE CON CILINDRO

COPPIA PORTE A BATTENTE ALTEZZA TOTALE



H ARMADIO mm	TIPO DI CHIUSURA	ART. CON kit plastiche Dark Grey 	ART. SENZA kit plastiche* 
850	 C0 KEY chiusura a cilindro	M 60 P075 C0 10 10 _ _	M 60 P075 C0 00 10 _ _
	 C1 KEY chiusura a cilindro	M 60 P075 C1 10 10 _ _	M 60 P075 C1 00 10 _ _
	 C2 KEY chiusura a cilindro	M 60 P075 C2 10 10 _ _	M 60 P075 C2 00 10 _ _
1000	 C0 KEY chiusura a cilindro	M 60 P090 C0 10 10 _ _	M 60 P090 C0 00 10 _ _
	 C1 KEY chiusura a cilindro	M 60 P090 C1 10 10 _ _	M 60 P090 C1 00 10 _ _
	 C2 KEY chiusura a cilindro	M 60 P090 C2 10 10 _ _	M 60 P090 C2 00 10 _ _
1500	 C0 KEY chiusura a cilindro	M 60 P140 C0 10 10 _ _	M 60 P140 C0 00 10 _ _
	 C1 KEY chiusura a cilindro	M 60 P140 C1 10 10 _ _	M 60 P140 C1 00 10 _ _
	 C2 KEY chiusura a cilindro	M 60 P140 C2 10 10 _ _	M 60 P140 C2 00 10 _ _
2000	 C0 KEY chiusura a cilindro	M 60 P190 C0 10 10 _ _	M 60 P190 C0 00 10 _ _
	 C1 KEY chiusura a cilindro	M 60 P190 C1 10 10 _ _	M 60 P190 C1 00 10 _ _
	 C2 KEY chiusura a cilindro	M 60 P190 C2 10 10 _ _	M 60 P190 C2 00 10 _ _

*ABBINARE AL CODICE ARTICOLO UNO DEI KIT PLASTICHE DISPONIBILI NELLA TABELLA A DESTRA



LA COPPIA PORTE DEVE ESSERE ASSOCIATA OBBLIGATORIAMENTE AGLI ARMADI CON LA CHIUSURA:
C5 (SENZA SERRATURA) OPPURE **X0** (SENZA ASTA VERTEBRATA E SENZA SERRATURA)

COPPIA PORTE A BATTENTE ALTEZZA PARZIALE



H INGOMBRO PORTA mm	TIPO DI CHIUSURA	ART. CON kit plastiche Dark Grey 	ART. SENZA kit plastiche* 
775	 C0 KEY chiusura a cilindro	M 60 P077 C0 10 11 _ _	M 60 P077 C0 00 11 _ _
	 C1 KEY chiusura a cilindro	M 60 P077 C1 10 11 _ _	M 60 P077 C1 00 11 _ _
	 C2 KEY chiusura a cilindro	M 60 P077 C2 10 11 _ _	M 60 P077 C2 00 11 _ _

*ABBINARE AL CODICE ARTICOLO UNO DEI KIT PLASTICHE DISPONIBILI NELLA TABELLA A DESTRA



PORTE A BATTENTE CON CODICE NUMERICO

COPPIA PORTE A BATTENTE ALTEZZA TOTALE



H ARMADIO mm	TIPO DI CHIUSURA	ART. CON kit plastiche Dark Grey	ART. SENZA kit plastiche*
850	P5 CODE codice numerico	M 60 P075 P5 10 10 _ _	M 60 P075 P5 00 10 _ _
1000	P5 CODE codice numerico	M 60 P090 P5 10 10 _ _	M 60 P090 P5 00 10 _ _
1500	P5 CODE codice numerico	M 60 P140 P5 10 10 _ _	M 60 P140 P5 00 10 _ _
2000	P5 CODE codice numerico	M 60 P190 P5 10 10 _ _	M 60 P190 P5 00 10 _ _

*ABBINARE AL CODICE ARTICOLO UNO DEI KIT PLASTICHE DISPONIBILI NELLA TABELLA SOTTOSTANTE



LA COPPIA PORTE DEVE ESSERE ASSOCIATA OBBLIGATORIAMENTE AGLI ARMADI CON LA CHIUSURA:
C5 (SENZA SERRATURA) OPPURE **X0** (SENZA ASTA VERTEBRATA E SENZA SERRATURA)

COPPIA PORTE A BATTENTE ALTEZZA PARZIALE



H INGOMBRO PORTA mm	TIPO DI CHIUSURA	ART. CON kit plastiche Dark Grey	ART. SENZA kit plastiche*
775	A4 maniglia senza tastierino	M 60 P077 A4 10 11 _ _	M 60 P077 A4 00 11 _ _

*ABBINARE AL CODICE ARTICOLO UNO DEI KIT PLASTICHE DISPONIBILI NELLA TABELLA SOTTOSTANTE



LA COPPIA PORTE DEVE ESSERE ASSOCIATA OBBLIGATORIAMENTE AGLI ARMADI CON LE CHIUSURE:
UTILIZZARE LA SERRATURA **T2** PER L'ARMADIO SENZA RUOTE
UTILIZZARE LA SERRATURA **A1** PER L'ARMADIO CON RUOTE



TELECOMANDO

ART.	
M 00 VR00 00 00 00 00	Modulo ricevitore con telecomando
M 00 VR00 00 00 01 00	Telecomando aggiuntivo

KIT PLASTICHE PER COPPIA PORTE



GAMMA COLORI PLASTICHE	ART. KEY	ART. CODE
MEDITERRANEAN BLUE	M 00 PLS0 00 00 30 M1	M 00 PLS0 00 00 31 M1
SKY BLUE	M 00 PLS0 00 00 30 M2	M 00 PLS0 00 00 31 M2
GLAMOUR RED	M 00 PLS0 00 00 30 M3	M 00 PLS0 00 00 31 M3
RED CARPET	M 00 PLS0 00 00 30 M4	M 00 PLS0 00 00 31 M4
JUICY ORANGE	M 00 PLS0 00 00 30 M5	M 00 PLS0 00 00 31 M5
SUNNY YELLOW	M 00 PLS0 00 00 30 M6	M 00 PLS0 00 00 31 M6
FOREST GREEN	M 00 PLS0 00 00 30 M7	M 00 PLS0 00 00 31 M7



PIANO SUPERIORE A 3 BORDI

ART.	dim. mm	
M 63 T023 AG 00 31 07	1190x726x23 H	

Piano rivestito in pvc per ARMADIO SINGOLO. Colore nero



PIANO SUPERIORE A 4 BORDI

ART.	dim. mm	
M 63 T023 AG 00 41 07	1190x726x23 H	

Piano rivestito in pvc per ARMADIO SINGOLO. Colore nero



ART. M 00 T023 AG 00 FO 00

FORATURA PIANO SUPERIORE DELL'ARMADIO
PER IL FISSAGGIO DEL PIANO A 4 BORDI



PIANO SUPERIORE IN MULTIPLEX

ART.	dim. mm	
M 63 T040 MU 00 01 00	1190x726x40 H	

Per ARMADIO SINGOLO



PIANO SUPERIORE IN MDF DIM. 1190x726x32 mm H

ART.	rifiniture	per armadio	
M 63 T030 MD GM 21 07	1 profilo laterale	finale dx o sx	

Piano in MDF con copertura in gomma antiolio. Colore nero



PIANO SUPERIORE IN MDF DIM. 1190x726x32 mm H

ART.	rifiniture	per armadio	
M 63 T030 MD GM 11 07	-	centrale	

Piano in MDF con copertura in gomma antiolio. Colore nero



PIANO SUPERIORE IN MDF DIM. 1190x726x32 mm H

ART.	rifiniture	per armadio	
M 63 T030 MD GM 01 07	2 profili laterali	singolo	

Piano in MDF con copertura in gomma antiolio. Colore nero



ART. M 00 T030 MD 00 FO 00

FORATURA PIANO SUPERIORE DELL'ARMADIO PER IL FISSAGGIO DEL
PIANO IN MDF E DEL PIANO IN MULTIPLEX
COMPRESIVO DI VITI PER IL FISSAGGIO



RIFINITURA
GOMMA
ANTIOLIO



APPLICAZIONE
PIANO IN MDF



**PIANO SUPERIORE IN MULTIPLEX PER
ARMADIO CON RUOTE**
DISPONIBILE SU RICHIESTA





ZOCCOLO DI RIALZO ALTEZZA 50 mm

ART.		dim. mm	
M 63 Z050 00 00 00 _ _		1188x725x50 H	



ZOCCOLO DI RIALZO ALTEZZA 100 mm

ART.		dim. mm	
M 63 Z100 00 00 00 _ _		1188x725x100 H	



ZOCCOLI PER CARRELLO ELEVATORE - Colore nero RAL 9005

ART.		dim. mm	
M 03 Z060 20 00 00 07	coppia zoccoli	200x722x60 H	
M 60 Z060 21 00 00 07	chiusura per coppia zoccoli	1184x46x55 H	

ART.		dim. mm	
M 03 Z100 20 00 00 07	coppia zoccoli	200x722x100 H	
M 60 Z100 21 00 00 07	chiusura per coppia zoccoli	1184x46x95 H	



RUOTA FISSA IN GOMMA ELASTICA

ART.	Ø mm	portata armadio kg	C mm
C RG BCE15 125	125	340	155
C RG BCE15 160	160	600	200



RUOTA GIREVOLE CON FRENO IN GOMMA ELASTICA

ART.	Ø mm	portata armadio kg	C mm
C RG DCE15 125	125	340	155
C RG DCE15 160	160	600	200



RUOTA FISSA IN NYLON

ART.	Ø mm	portata armadio kg	C mm
C RN BAD11 125	125	340	155
C RN BAD04 160	160	600	200



RUOTA GIREVOLE CON FRENO IN NYLON

ART.	Ø mm	portata armadio kg	C mm
C RN DAD11 125	125	360	155
C RN DAD04 160	160	600	200



RICAMBI - FISSAGGIO

SERRATURA DI RICAMBIO

ART. M 00 CSRO 8800 00 00

Serratura di ricambio con due chiavi



CHIAVE DI RICAMBIO

ART. M 00 CF00 0000 00 00

Specificare sempre il numero indicato nella serratura a cilindro dove si vuole sostituire la chiave



PASSEPARTOUT

ART. M 00 PF.. 0000 00 00

Disponibile in 23 serie, con numerazione da F 01 a F 23.

Passepartout serie F 01

Passepartout serie F 02

Passepartout serie F ..

ART. M 00 PF01 00 00 00 00

ART. M 00 PF02 00 00 00 00

ART. M 00 PF.. 00 00 00 00

SET FISSAGGIO TRA ARMADI

ART. M 00 FISO 00 00 00 99

Set di fissaggio armadio-armadio con 4 viti complete di dadi M8

ART. M 00 SVRO 00 00 00 99

Foratura e viteria per il fissaggio dei due armadi sovrapposti

SET DI FISSAGGIO A PAVIMENTO



ART. F AG 9200 00 99

Coppia staffe zincate per il fissaggio a pavimento dell'armadio

ART. F AG 9204 00 99

2 tasselli "HILTI" adatti per pavimenti in calcestruzzo non fessurato maggiore o uguale alla classe C20/25
Trazione consigliata del tassello: 2.9 kN
Diametro tassello: Ø 6 mm



MANIGLIA DI RICAMBIO

ART. M 00 PLSO 0000 22 MO

Maniglia di ricambio per porte disponibile in colore Dark Grey.



ALTRI COLORI A RICHIESTA



GLI ARMADI DEVONO ESSERE FISSATI A PAVIMENTO O A PARETE
SE SOVRAPPOSTI DEVONO ESSERE FISSATI OBBLIGATORIAMENTE A PARETE E LA LORO PORTATA DIVISA PER DUE



MASTER

1190x726 mm

Born To Be Extreme

ARMADIO VUOTO senza asta vertebrata e senza chiusura



H 700 mm
H utile 600 mm



H 850 mm
H utile 750 mm



H 1000 mm
H utile 900 mm



M 63 A070 X0 10 00 _ _ M 63 A085 X0 10 00 _ _ M 63 A100 X0 10 00 _ _

ASTA VERTEBRATA



L'asta vertebrata è composta da un profilo in alluminio estruso forato a passo 25 mm per l'inserimento della molla antiribaltamento. L'asta antiribaltamento viene fornita completa di accessori in plastica e struttura superiore predisposta per la chiusura a cilindro o elettronica.

ART.	H utile inserimento cassette mm
M 00 V030 00 00 00 00	300
M 00 V050 00 00 00 00	500
M 00 V060 00 00 00 00	600
M 00 V070 00 00 00 00	700
M 00 V075 00 00 00 00	750
M 00 V090 00 00 00 00	900

ART.	H utile inserimento cassette mm
M 00 V105 00 00 00 00	1050
M 00 V122 00 00 00 00	1225
M 00 V140 00 00 00 00	1400
M 00 V152 00 00 00 00	1525
M 00 V190 00 00 00 00	1900

CHIUSURA CON CILINDRO (KEY)



CHIUSURA A CILINDRO COMPLETA DI:

- 1 serratura a cilindro con 2 chiavi
- 1 filo in acciaio con guaina
- 1 gruppo percussore anteriore
- 1 gruppo cursore posteriore

ART.	
M 63 V000 C0 00 00 00	C0 CHIUSURA A CILINDRO CON NUMERAZIONE DIVERSA
M 63 V000 C1 00 00 00	C1 CHIUSURA A CILINDRO PER GRUPPI DI 160 NUMERI
M 63 V000 C2 00 00 00	C2 CHIUSURA A CILINDRO CON NUMERAZIONE UGUALE

For Experts Only



H 1325 mm
H utile 1225 mm



H 1500 mm
H utile 1400 mm



H 2000 mm
H utile 1900 mm



M 63 A132 X0 10 00 _ _

M 63 A150 X0 10 00 _ _

M 63 A200 X0 10 00 _ _

CHIUSURA CON CODICE NUMERICO (CODE)



ART.

M 63 V000 E2 00 00 00

E2

APERTURA/CHIUSURA ASTA (alimentazione a batteria)

M 63 V000 E5 00 00 00

E5

APERTURA/CHIUSURA ASTA (alimentazione da rete elettrica)

M 63 V000 T2 00 00 00

T2

APERTURA/CHIUSURA ASTA + PORTA (alimentazione a batteria)

M 63 V000 T3 00 00 00

T3

APERTURA/CHIUSURA ASTA + PORTA (alimentazione da rete elettrica)

ART. TELECOMANDO

M 00 VRC0 00 00 00 00

Modulo ricevitore
con telecomando

M 00 VRC0 00 00 01 00

Telecomando aggiuntivo



PIANI PER SERRATURE E PIANI REGOLABILI

PIANO SUPERIORE PER SERRATURE



ART.



H frontale mm

kg

M 63 PS46 00 10 00 _ _

46

150

Dim. mm 1139x724x46 H

PIANO INFERIORE PER SERRATURE



ART.



H frontale mm

kg

M 63 PS46 10 10 00 _ _

46

150

Dim. mm 1139x724x46 H

PIANO REGOLABILE



ART.



H totale mm

kg

M 63 PR25 00 00 01 _ _

60

150

Dim. utili mm 1133x631x25 H

PIANO REGOLABILE FESSURATO



ART.



H frontale mm

kg

M 63 PR35 10 00 01 _ _

35

300

Dim. mm 1139x721x35 H

64x36 EH

MATERIALE DI SEPARAZIONE

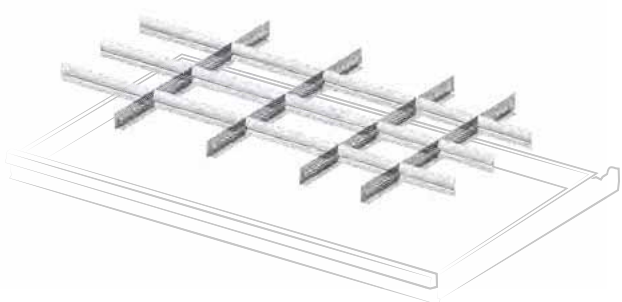

ART.	per altezza frontale mm
F FH 6007 02 00	75
F FH 6010 02 00	100 - 125
F FH 6015 02 00	150
F FH 6020 02 00	200 - 250

Set composto da: 4 divisori longitudinali fessurati 610 mm, 3 divisori trasversali 149 mm, 3 divisori trasversali 166 mm, 9 divisori trasversali 251 mm

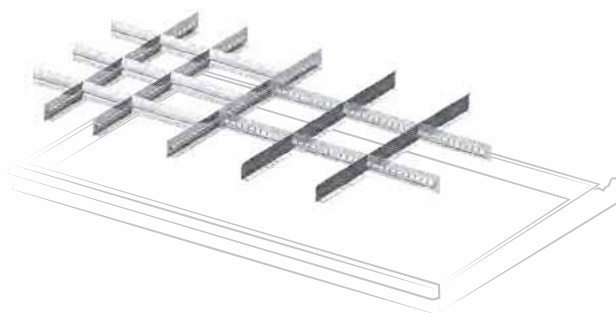

ART.	per altezza frontale mm
F FH 6007 05 00	75
F FH 6010 05 00	100 - 125
F FH 6015 05 00	150

Set composto da: 5 divisori longitudinali fessurati 610 mm, 6 divisori trasversali 132 mm, 9 divisori trasversali 200 mm

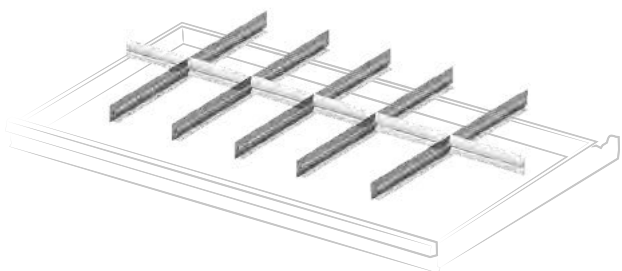

ART.	per altezza frontale mm
F FH 6007 08 00	75
F FH 6010 08 00	100 - 125
F FH 6015 08 00	150
F FH 6020 08 00	200 - 250
F FH 6030 08 00	300

Set composto da: 5 divisori longitudinali fessurati 610 mm, 2 divisori trasversali 149 mm, 1 divisorio trasversale 166 mm, 3 divisori trasversali 200 mm

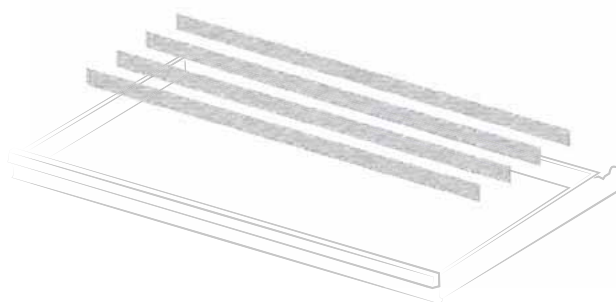

ART.	per altezza frontale mm
F FH 6007 09 00	75
F FH 6010 09 00	100 - 125
F FH 6015 09 00	150
F FH 6020 09 00	200 - 250
F FH 6030 09 00	300

Set composto da: 4 divisori longitudinali non fessurati 1085 mm

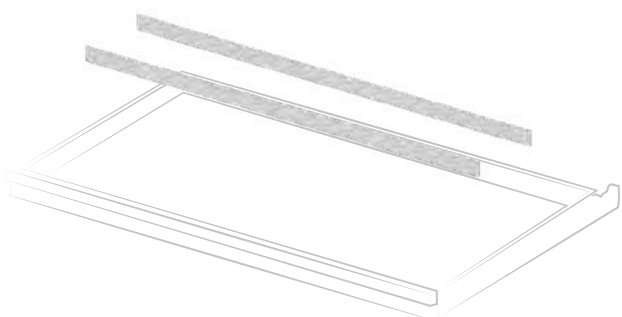

ART.	per altezza frontale mm
F FH 6007 10 00	75
F FH 6010 10 00	100 - 125
F FH 6015 10 00	150
F FH 6020 10 00	200 - 250
F FH 6030 10 00	300

Set composto da: 2 divisori longitudinali non fessurati 1085 mm

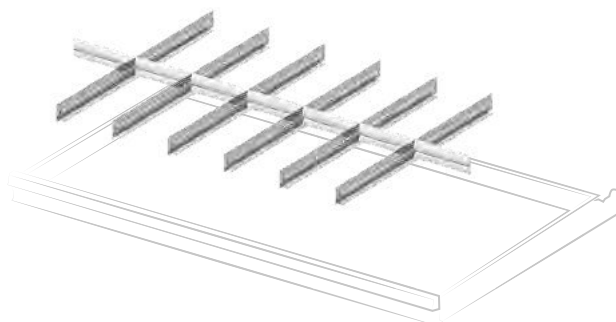

ART.	per altezza frontale mm
F FH 6007 11 00	75
F FH 6010 11 00	100 - 125
F FH 6015 11 00	150
F FH 6020 11 00	200 - 250
F FH 6030 11 00	300

Set composto da: 6 divisori longitudinali fessurati 610 mm, 6 divisori trasversali 149 mm, 1 divisorio trasversale 166 mm



Palazzoli





Palazzoli

LYROLIT

Atlas Copco PRO G2403









Gamma colori ACCIAIO

	
GRIGIO RAL 7000 .01	VERDE RAL 6011 .02
	
BLU RAL 5012 .04	GRIGIO RAL 7035 .08
	
BIANCO GRIGIASTRO RAL 9002 .1F	ROSSO RUBINO RAL 3003 .1G
	
BLU GENZIANA RAL 5010 .34	BIANCO PURO RAL 9010 .35
	
GRIGIO ANTRACITE RAL 7016 .39	BLU CAPRI RAL 5019 .48



● **ART. M 73 A100 C0 10 CN 04**
H = 1000 mm - 8 cassetti

Gamma colori PLASTICHE

			
DARK GREY .M0	MEDITERRANEAN BLUE .M1	SKY BLUE .M2	GLAMOUR RED .M3
			
RED CARPET .M4	JUICE ORANGE .M5	SUNNY YELLOW .M6	FOREST GREEN .M7

LEGENDA



PORTATA
CASSETTO/
PIANO



ESTRAZIONE
CASSETTO/
PIANO



CHIUSURA
ARMADIO



LE PORTATE SONO NETTE E SI RIFERISCONO A PESI UNIFORMEMENTE DISTRIBUITI

H 700 mm



ART.				
M 73 A070 C0 10 49 04		50-75-100	100-96-92%	key
M 73 A070 C0 10 50 04		200	100%	key
M 73 A070 E2 10 49 04		50-75-100	100-96-92%	code
M 73 A070 E2 10 50 04		200	100%	code

H 700 mm



ART.				
M 73 A070 C0 10 31 04		50-75-100	100-96-92%	key
M 73 A070 C0 10 51 04		200	100%	key
M 73 A070 E2 10 31 04		50-75-100	100-96-92%	code
M 73 A070 E2 10 51 04		200	100%	code

H 850 mm



ART.				
M 73 A085 C0 10 AA 04		50-75-100	100-96-92%	key
M 73 A085 C0 10 AB 04		200	100%	key
M 73 A085 E2 10 AA 04		50-75-100	100-96-92%	code
M 73 A085 E2 10 AB 04		200	100%	code

H 850 mm

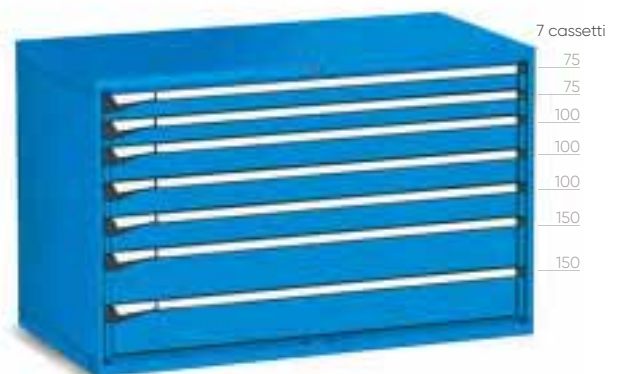

ART.				
M 73 A085 C0 10 95 04		50-75-100	100-96-92%	key
M 73 A085 C0 10 AU 04		200	100%	key
M 73 A085 E2 10 95 04		50-75-100	100-96-92%	code
M 73 A085 E2 10 AU 04		200	100%	code

H 1000 mm



ART.		kg		
M 73 A100 C0 10 CN 04		50-75-100	100-96-92%	key
M 73 A100 C0 10 CP 04		200	100%	key
M 73 A100 E2 10 CN 04		50-75-100	100-96-92%	code
M 73 A100 E2 10 CP 04		200	100%	code

H 1000 mm



ART.		kg		
M 73 A100 C5 10 EC 04		50-75-100	100-96-92%	-
M 73 A100 C5 10 ED 04		200	100%	-

H 1023 mm



porta 900 mm profondità 751 mm

ART.		kg		
M 73 A100 C0 10 BU 04		50-75-100	100-96-92%	key
M 73 A100 C0 10 BV 04		200	100%	key
M 73 A100 P5 10 BU 04		50-75-100	100-96-92%	code
M 73 A100 P5 10 BV 04		200	100%	code

H 1023 mm



porta 900 mm profondità 751 mm

ART.		kg		
M 73 A100 C0 10 CA 04		50-75-100	100-96-92%	key
M 73 A100 C0 10 CB 04		200	100%	key
M 73 A100 P5 10 CA 04		50-75-100	100-96-92%	code
M 73 A100 P5 10 CB 04		200	100%	code

H 1500 mm



H 1500 mm



porta 1400 mm

profondità 751 mm

ART.		kg		
M 73 A150 C0 10 MF 04		50-75-100	100-96-92%	key
M 73 A150 C0 10 MG 04		200	100%	key
M 73 A150 E2 10 MF 04		50-75-100	100-96-92%	code
M 73 A150 E2 10 MG 04		200	100%	code

ART.		kg		
M 73 A150 C0 10 LC 04		50-75-100	100-96-92%	key
M 73 A150 C0 10 LD 04		200	100%	key
M 73 A150 P5 10 LC 04		50-75-100	100-96-92%	code
M 73 A150 P5 10 LD 04		200	100%	code



MASTER

1428x726 mm

H 2000 mm



H 2000 mm



ART.				
M 73 A200 C5 10 FU 04		50-75-100	100-96-92%	-
M 73 A200 C5 10 FV 04		200	100%	-

ART.				
M 73 A200 C0 10 FS 04		50-75-100	100-96-92%	key
M 73 A200 C0 10 FT 04		200	100%	key
M 73 A200 E2 10 FS 04		50-75-100	100-96-92%	code
M 73 A200 E2 10 FT 04		200	100%	code



H 2000 mm



porta 900 mm

ART.		kg			
M 73 A200 C0 10 FY 04		50-75-100	100-96-92%	key	
M 73 A200 C0 10 FZ 04		200	100%	key	
M 73 A200 T2 10 FY 04		50-75-100	100-96-92%	code	
M 73 A200 T2 10 FZ 04		200	100%	code	

H 2000 mm



porta 1900 mm

ART.		kg			
M 73 A200 C0 10 FW 04		50-75-100	100-96-92%	key	
M 73 A200 C0 10 FX 04		200	100%	key	
M 73 A200 P5 10 FW 04		50-75-100	100-96-92%	code	
M 73 A200 P5 10 FX 04		200	100%	code	



H 1113 mm



ART.				
M 73 R085 S0 10 AA 04		50-75-100	100-96-92%	key
M 73 R085 P2 10 AA 04		50-75-100	100-96-92%	code

Portata armadio 600 kg - Altezza armadio senza ruote mm 913

H 1113 mm



ART.				
M 73 R085 S0 10 95 04		50-75-100	100-96-92%	key
M 73 R085 P2 10 95 04		50-75-100	100-96-92%	code

Portata armadio 600 kg - Altezza armadio senza ruote mm 913

H 1263 mm



ART.				
M 73 R100 S0 10 DY 04		50-75-100	100-96-92%	key
M 73 R100 P2 10 DY 04		50-75-100	100-96-92%	code

Portata armadio 600 kg - Altezza armadio senza ruote mm 1063

H 1263 mm



ART.				
M 73 R100 S0 10 CN 04		50-75-100	100-96-92%	key
M 73 R100 P2 10 CN 04		50-75-100	100-96-92%	code

Portata armadio 600 kg - Altezza armadio senza ruote mm 1063



2 ruote girevoli con freno in gomma elastica Ø 160 mm
2 ruote fisse in gomma elastica Ø 160 mm



ART. M 73 R085 P2 12 PR 35

CONFIGURA IL TUO ARMADIO

	SCEGLI l'altezza	SCEGLI la chiusura		SCEGLI il colore
M73	A040	C5	10 00	01

ARMADIO VUOTO



Portata corpo
armadio 3100 kg

M73	ALTEZZA		CHIUSURA		10 00	COLORE	
	Model	Height (mm) (useful mm)	Icon	Description		Code	Color Name
	A070	700 mm (utile 600 mm)	X0	senza asta e senza serratura		01	RAL 7000
	A085	850 mm (utile 750 mm)	C5*	senza serratura		02	RAL 6011
	A100	1000 mm (utile 900 mm)	C0*	KEY chiusura a cilindro		1G	RAL 3003
	A132	1325 mm (utile 1225 mm)	C1*	KEY chiusura a cilindro		1F	RAL 9002
	A150	1500 mm (utile 1400 mm)	C2*	KEY chiusura a cilindro		48	RAL 5019
	A200	2000 mm (utile 1900 mm)	E2*	CODE codice numerico		39	RAL 7016
			T2*	CODE codice numerico		04	RAL 5012
					08	RAL 7035	
					35	RAL 9010	
					34	RAL 5010	

*COMPLETA DI ASTA VERTEBRATA

ARMADIO VUOTO predisposto per ruote



M73	ALTEZZA		CHIUSURA		10 00	COLORE	
	Model	Height (mm) (useful mm)	Icon	Description		Code	Color Name
	R085	913 mm (utile 750 mm)	S0	KEY chiusura a cilindro		01	RAL 7000
	R100	1063 mm (utile 900 mm)	S1	KEY chiusura a cilindro		02	RAL 6011
			S2	KEY chiusura a cilindro		1G	RAL 3003
			P2	CODE codice numerico		1F	RAL 9002
			A1	CODE codice numerico		48	RAL 5019
						39	RAL 7016
						04	RAL 5012
					08	RAL 7035	
					35	RAL 9010	
					34	RAL 5010	

COMPLETO DI ASTA VERTEBRATA, PIANO A 4 BORDI CON COPERTURA IN PVC, COPPIA MANIGLIE, COPPIA PIASTRE
Dim. ingombro mm 1502x752



CASSETTI AD ESTRAZIONE FLESSIBILE

ART. CON kit plastiche Dark Grey	ART. SENZA kit plastiche*	Dim. utili mm	H frontale mm	kg	
M 73 C075 01 10 OF __	M 73 C075 01 00 OF __	1314x600x56 H	75	50 - 75 - 100	100% - 96% - 92%
M 73 C100 01 10 OF __	M 73 C100 01 00 OF __	1314x600x81 H	100	50 - 75 - 100	100% - 96% - 92%
M 73 C125 01 10 OF __	M 73 C125 01 00 OF __	1314x600x106 H	125	50 - 75 - 100	100% - 96% - 92%
M 73 C150 01 10 OF __	M 73 C150 01 00 OF __	1314x600x131 H	150	50 - 75 - 100	100% - 96% - 92%
M 73 C200 01 10 OF __	M 73 C200 01 00 OF __	1314x600x181 H	200	50 - 75 - 100	100% - 96% - 92%
M 73 C250 01 10 OF __	M 73 C250 01 00 OF __	1314x600x231 H	250	50 - 75 - 100	100% - 96% - 92%
M 73 C300 01 10 OF __	M 73 C300 01 00 OF __	1314x600x281 H	300	50 - 75 - 100	100% - 96% - 92%

* ABBINARE AL CODICE ARTICOLO UNO DEI KIT PLASTICHE DISPONIBILI NELLA TABELLA SOTTOSTANTE



CASSETTI AD ESTRAZIONE TELESCOPICA

ART. CON kit plastiche Dark Grey	ART. SENZA kit plastiche*	Dim. utili mm	H frontale mm	kg	
M 73 C075 01 10 OT __	M 73 C075 01 00 OT __	1314x600x56 H	75	200	100%
M 73 C100 01 10 OT __	M 73 C100 01 00 OT __	1314x600x81 H	100	200	100%
M 73 C125 01 10 OT __	M 73 C125 01 00 OT __	1314x600x106 H	125	200	100%
M 73 C150 01 10 OT __	M 73 C150 01 00 OT __	1314x600x131 H	150	200	100%
M 73 C200 01 10 OT __	M 73 C200 01 00 OT __	1314x600x181 H	200	200	100%
M 73 C250 01 10 OT __	M 73 C250 01 00 OT __	1314x600x231 H	250	200	100%
M 73 C300 01 10 OT __	M 73 C300 01 00 OT __	1314x600x281 H	300	200	100%

* ABBINARE AL CODICE ARTICOLO UNO DEI KIT PLASTICHE DISPONIBILI NELLA TABELLA SOTTOSTANTE

KIT PLASTICHE PER CASSETTI E PIANI ESTRAIBILI



GAMMA COLORI PLASTICHE	ART.
MEDITERRANEAN BLUE	M 70 PLS1 00 00 00 M1
SKY BLUE	M 70 PLS1 00 00 00 M2
GLAMOUR RED	M 70 PLS1 00 00 00 M3
RED CARPET	M 70 PLS1 00 00 00 M4
JUICY ORANGE	M 70 PLS1 00 00 00 M5
SUNNY YELLOW	M 70 PLS1 00 00 00 M6
FOREST GREEN	M 70 PLS1 00 00 00 M7



PIANI ESTRAIBILI AD ESTRAZIONE FLESSIBILE

ART. CON kit plastiche Dark Grey	ART. SENZA kit plastiche*	Dim. utili mm	H frontale mm	kg	
M 73 C057 0110 OF __	M 73 C057 0100 OF __	1314x600	70	50 - 75 - 100	100% - 96% - 92%

* ABBINARE AL CODICE ARTICOLO UNO DEI KIT PLASTICHE DISPONIBILI NELLA TABELLA SOTTOSTANTE



PIANI ESTRAIBILI AD ESTRAZIONE TELESCOPICA

ART. CON kit plastiche Dark Grey	ART. SENZA kit plastiche*	Dim. utili mm	H frontale mm	kg	
M 73 C057 0110 OT __	M 73 C057 0100 OT __	1314x600	70	200	100%

* ABBINARE AL CODICE ARTICOLO UNO DEI KIT PLASTICHE DISPONIBILI NELLA TABELLA SOTTOSTANTE



PIANO REGOLABILE

ART.	Dim. utili mm	H totale mm	kg
M 73 PR25 00 00 01 __	1371x631	60	150

INSERIBILE DAVANTI ALL'ASTA VERTEBRATA

KIT PLASTICHE PER CASSETTI E PIANI ESTRAIBILI



GAMMA COLORI PLASTICHE	ART.
MEDITERRANEAN BLUE	M 70 PLS1 00 00 00 M1
SKY BLUE	M 70 PLS1 00 00 00 M2
GLAMOUR RED	M 70 PLS1 00 00 00 M3
RED CARPET	M 70 PLS1 00 00 00 M4
JUICY ORANGE	M 70 PLS1 00 00 00 M5
SUNNY YELLOW	M 70 PLS1 00 00 00 M6
FOREST GREEN	M 70 PLS1 00 00 00 M7

















ART. M 73 A100 E2 17 PN 39

🔑 PORTE A BATTENTE CON CILINDRO

COPPIA PORTE A BATTENTE ALTEZZA TOTALE



H ARMADIO mm	TIPO DI CHIUSURA	ART. CON kit plastiche Dark Grey 	ART. SENZA kit plastiche* 
850	 C0 KEY chiusura a cilindro	M 70 P075 C0 10 10 _ _	M 70 P075 C0 00 10 _ _
	 C1 KEY chiusura a cilindro	M 70 P075 C1 10 10 _ _	M 70 P075 C1 00 10 _ _
	 C2 KEY chiusura a cilindro	M 70 P075 C2 10 10 _ _	M 70 P075 C2 00 10 _ _
1000	 C0 KEY chiusura a cilindro	M 70 P090 C0 10 10 _ _	M 70 P090 C0 00 10 _ _
	 C1 KEY chiusura a cilindro	M 70 P090 C1 10 10 _ _	M 70 P090 C1 00 10 _ _
	 C2 KEY chiusura a cilindro	M 70 P090 C2 10 10 _ _	M 70 P090 C2 00 10 _ _
1500	 C0 KEY chiusura a cilindro	M 70 P140 C0 10 10 _ _	M 70 P140 C0 00 10 _ _
	 C1 KEY chiusura a cilindro	M 70 P140 C1 10 10 _ _	M 70 P140 C1 00 10 _ _
	 C2 KEY chiusura a cilindro	M 70 P140 C2 10 10 _ _	M 70 P140 C2 00 10 _ _
2000	 C0 KEY chiusura a cilindro	M 70 P190 C0 10 10 _ _	M 70 P190 C0 00 10 _ _
	 C1 KEY chiusura a cilindro	M 70 P190 C1 10 10 _ _	M 70 P190 C1 00 10 _ _
	 C2 KEY chiusura a cilindro	M 70 P190 C2 10 10 _ _	M 70 P190 C2 00 10 _ _



* ABBINARE AL CODICE ARTICOLO UNO DEI KIT PLASTICHE DISPONIBILI NELLA TABELLA A DESTRA



LA COPPIA PORTE DEVE ESSERE ASSOCIATA OBBLIGATORIAMENTE AGLI ARMADI CON LA CHIUSURA:
C5 (SENZA SERRATURA) OPPURE **X0** (SENZA ASTA VERTEBRATA E SENZA SERRATURA)

COPPIA PORTE A BATTENTE ALTEZZA PARZIALE



H INGOMBRO PORTA mm	TIPO DI CHIUSURA	ART. CON kit plastiche Dark Grey 	ART. SENZA kit plastiche* 
775	 C0 KEY chiusura a cilindro	M 70 P077 C0 10 11 _ _	M 70 P077 C0 00 11 _ _
	 C1 KEY chiusura a cilindro	M 70 P077 C1 10 11 _ _	M 70 P077 C1 00 11 _ _
	 C2 KEY chiusura a cilindro	M 70 P077 C2 10 11 _ _	M 70 P077 C2 00 11 _ _

* ABBINARE AL CODICE ARTICOLO UNO DEI KIT PLASTICHE DISPONIBILI NELLA TABELLA A DESTRA



PORTE A BATTENTE CON CODICE NUMERICO

COPPIA PORTE A BATTENTE ALTEZZA TOTALE



H ARMADIO mm	TIPO DI CHIUSURA	ART. CON kit plastiche Dark Grey	ART. SENZA kit plastiche*
850	P5 CODE codice numerico	M 70 P075 P5 10 10 _ _	M 70 P075 P5 00 10 _ _
1000	P5 CODE codice numerico	M 70 P090 P5 10 10 _ _	M 70 P090 P5 00 10 _ _
1500	P5 CODE codice numerico	M 70 P140 P5 10 10 _ _	M 70 P140 P5 00 10 _ _
2000	P5 CODE codice numerico	M 70 P190 P5 10 10 _ _	M 70 P190 P5 00 10 _ _

* ABBINARE AL CODICE ARTICOLO UNO DEI KIT PLASTICHE DISPONIBILI NELLA TABELLA SOTTOSTANTE



LA COPPIA PORTE DEVE ESSERE ASSOCIATA OBBLIGATORIAMENTE AGLI ARMADI CON LA CHIUSURA: **C5** (SENZA SERRATURA) OPPURE **X0** (SENZA ASTA VERTEBRATA E SENZA SERRATURA)

COPPIA PORTE A BATTENTE ALTEZZA PARZIALE



H INGOMBRO PORTA mm	TIPO DI CHIUSURA	ART. CON kit plastiche Dark Grey	ART. SENZA kit plastiche*
775	A4 maniglia senza tastierino	M 70 P077 A4 10 11 _ _	M 70 P077 A4 00 11 _ _

* ABBINARE AL CODICE ARTICOLO UNO DEI KIT PLASTICHE DISPONIBILI NELLA TABELLA SOTTOSTANTE



LA COPPIA PORTE DEVE ESSERE ASSOCIATA OBBLIGATORIAMENTE AGLI ARMADI CON LE CHIUSURE:
UTILIZZARE LA SERRATURA **T2** PER L'ARMADIO SENZA RUOTE
UTILIZZARE LA SERRATURA **A1** PER L'ARMADIO CON RUOTE

TELECOMANDO



ART.	
M 00 VR00 00 00 00 00	Modulo ricevitore con telecomando
M 00 VR00 00 00 01 00	Telecomando aggiuntivo

KIT PLASTICHE PER COPPIA PORTE



GAMMA COLORI PLASTICHE	ART. KEY	ART. CODE
MEDITERRANEAN BLUE	M 00 PLS0 00 00 30 M1	M 00 PLS0 00 00 31 M1
SKY BLUE	M 00 PLS0 00 00 30 M2	M 00 PLS0 00 00 31 M2
GLAMOUR RED	M 00 PLS0 00 00 30 M3	M 00 PLS0 00 00 31 M3
RED CARPET	M 00 PLS0 00 00 30 M4	M 00 PLS0 00 00 31 M4
JUICY ORANGE	M 00 PLS0 00 00 30 M5	M 00 PLS0 00 00 31 M5
SUNNY YELLOW	M 00 PLS0 00 00 30 M6	M 00 PLS0 00 00 31 M6
FOREST GREEN	M 00 PLS0 00 00 30 M7	M 00 PLS0 00 00 31 M7



PIANO SUPERIORE A 3 BORDI

ART.	dim. mm	
M 73 T023 AG 00 31 07	1428x726x23 H	

Piano rivestito in pvc per ARMADIO SINGOLO. Colore nero



PIANO SUPERIORE A 4 BORDI

ART.	dim. mm	
M 73 T023 AG 00 41 07	1428x726x23 H	

Piano rivestito in pvc per ARMADIO SINGOLO. Colore nero



ART. M 00 T023 AG 00 FO 00

FORATURA PIANO SUPERIORE DELL'ARMADIO PER IL FISSAGGIO DEL PIANO A 4 BORDI



PIANO SUPERIORE IN MULTIPLEX

ART.	dim. mm	
M 73 T040 MU 00 01 00	1428x726x40 H	

Per ARMADIO SINGOLO



PIANO SUPERIORE IN MDF DIM. 1428x726x32 mm H

ART.	rifiniture	per armadio	
M 73 T030 MD GM 21 07	1 profilo laterale	finale dx o sx	

Piano in MDF con copertura in gomma antiolio. Colore nero



PIANO SUPERIORE IN MDF DIM. 1428x726x32 mm H

ART.	rifiniture	per armadio	
M 73 T030 MD GM 11 07	-	centrale	

Piano in MDF con copertura in gomma antiolio. Colore nero



PIANO SUPERIORE IN MDF DIM. 1428x726x32 mm H

ART.	rifiniture	per armadio	
M 73 T030 MD GM 01 07	2 profili laterali	singolo	

Piano in MDF con copertura in gomma antiolio. Colore nero



ART. M 00 T030 MD 00 FO 00

FORATURA PIANO SUPERIORE DELL'ARMADIO PER IL FISSAGGIO DEL PIANO IN MDF E DEL PIANO IN MULTIPLEX COMPRESIVO DI VITI PER IL FISSAGGIO



RIFINITURA
GOMMA
ANTIOILIO



APPLICAZIONE
PIANO IN MDF



PIANO SUPERIORE IN MULTIPLEX PER
ARMADIO CON RUOTE
DISPONIBILE SU RICHIESTA





ZOCCOLO DI RIALZO ALTEZZA 50 mm

ART.		dim. mm	
M 73 Z050 00 00 00 _ _		1426x725x50 H	



ZOCCOLO DI RIALZO ALTEZZA 100 mm

ART.		dim. mm	
M 73 Z100 00 00 00 _ _		1426x725x100 H	



ZOCCOLI PER CARRELLO ELEVATORE - Colore nero RAL 9005

ART.		dim. mm	
M 03 Z060 20 00 00 07	coppia zoccoli	200x722x60 H	
M 70 Z060 21 00 00 07	chiusura per coppia zoccoli	1422x46x55 H	
M 03 Z100 20 00 00 07	coppia zoccoli	200x722x100 H	
M 70 Z100 21 00 00 07	chiusura per coppia zoccoli	1422x46x95 H	



RUOTA FISSA IN GOMMA ELASTICA

ART.	Ø mm	portata armadio kg	C mm
C RG BCE15 125	125	320	155
C RG BCE15 160	160	600	200



RUOTA GIREVOLE CON FRENO IN GOMMA ELASTICA

ART.	Ø mm	portata armadio kg	C mm
C RG DCE15 125	125	320	155
C RG DCE15 160	160	600	200



RUOTA FISSA IN NYLON

ART.	Ø mm	portata armadio kg	C mm
C RN BAD11 125	125	320	155
C RN BAD04 160	160	600	200



RUOTA GIREVOLE CON FRENO IN NYLON

ART.	Ø mm	portata armadio kg	C mm
C RN DAD11 125	125	320	155
C RN DAD04 160	160	600	200



RICAMBI - FISSAGGIO

SERRATURA DI RICAMBIO

ART. M 00 CSRO 8800 00 00

Serratura di ricambio con due chiavi



CHIAVE DI RICAMBIO

ART. M 00 CF00 0000 00 00

Specificare sempre il numero indicato nella serratura a cilindro dove si vuole sostituire la chiave



PASSEPARTOUT

ART. M 00 PF.. 0000 00 00

Disponibile in 23 serie, con numerazione da F 01 a F 23.

Passepartout serie F 01

Passepartout serie F 02

Passepartout serie F ..

ART. M 00 PF01 00 00 00 00

ART. M 00 PF02 00 00 00 00

ART. M 00 PF.. 00 00 00 00

SET FISSAGGIO TRA ARMADI

ART. M 00 FISO 00 00 00 99

Set di fissaggio armadio-armadio con 4 viti complete di dadi M8

ART. M 00 SVRO 00 00 00 99

Foratura e viteria per il fissaggio dei due armadi sovrapposti

SET DI FISSAGGIO A PAVIMENTO



ART. F AG 9200 00 99

Coppia staffe zincate per il fissaggio a pavimento dell'armadio

ART. F AG 9204 00 99

2 tasselli "HILTI" adatti per pavimenti in calcestruzzo non fessurato maggiore o uguale alla classe C20/25
Trazione consigliata del tassello: 2,9 kN
Diametro tassello: Ø 6 mm



MANIGLIA DI RICAMBIO

ART. M 00 PLSO 0000 22 M0

Maniglia di ricambio per porte disponibile in colore Dark Grey.



ALTRI COLORI A RICHIESTA



GLI ARMADI DEVONO ESSERE FISSATI A PAVIMENTO O A PARETE
SE SOVRAPPosti DEVONO ESSERE FISSATI OBBLIGATORIAMENTE A PARETE E LA LORO PORTATA DIVISA PER DUE



MASTER

1428x726 mm

Born To Be Extreme

ARMADIO VUOTO senza asta vertebrata e senza chiusura



H 700 mm
H utile 600 mm



H 850 mm
H utile 750 mm



H 1000 mm
H utile 900 mm



M 73 A070 X0 10 00 _ _

M 73 A085 X0 10 00 _ _

M 73 A100 X0 10 00 _ _

ASTA VERTEBRATA



L'asta vertebrata è composta da un profilo in alluminio estruso forato a passo 25 mm per l'inserimento della molla antiribaltamento. L'asta antiribaltamento viene fornita completa di accessori in plastica e struttura superiore predisposta per la chiusura a cilindro o elettronica.

ART.	H utile inserimento cassette mm
M 00 V030 00 00 00 00	300
M 00 V050 00 00 00 00	500
M 00 V060 00 00 00 00	600
M 00 V070 00 00 00 00	700
M 00 V075 00 00 00 00	750
M 00 V090 00 00 00 00	900

ART.	H utile inserimento cassette mm
M 00 V105 00 00 00 00	1050
M 00 V122 00 00 00 00	1225
M 00 V140 00 00 00 00	1400
M 00 V152 00 00 00 00	1525
M 00 V190 00 00 00 00	1900

CHIUSURA CON CILINDRO (KEY)



CHIUSURA A CILINDRO COMPLETA DI:

- 1 serratura a cilindro con 2 chiavi
- 1 filo in acciaio con guaina
- 1 gruppo percussore anteriore
- 1 gruppo cursore posteriore

ART.

M 73 V000 C0 00 00 00

C0

CHIUSURA A CILINDRO CON NUMERAZIONE DIVERSA

M 73 V000 C1 00 00 00

C1

CHIUSURA A CILINDRO PER GRUPPI DI 160 NUMERI

M 73 V000 C2 00 00 00

C2

CHIUSURA A CILINDRO CON NUMERAZIONE UGUALE

For Experts Only



H 1325 mm H utile 1225 mm		H 1500 mm H utile 1400 mm		H 2000 mm H utile 1900 mm	
M 73 A132 X0 10 00 _ _		M 73 A150 X0 10 00 _ _		M 73 A200 X0 10 00 _ _	

CHIUSURA CON CODICE NUMERICO (CODE)



ART.	
M 73 V000 E2 00 00 00	E2 APERTURA/CHIUSURA ASTA (alimentazione a batteria)
M 73 V000 E5 00 00 00	E5 APERTURA/CHIUSURA ASTA (alimentazione da rete elettrica)
M 73 V000 T2 00 00 00	T2 APERTURA/CHIUSURA ASTA + PORTA (alimentazione a batteria)
M 73 V000 T3 00 00 00	T3 APERTURA/CHIUSURA ASTA + PORTA (alimentazione da rete elettrica)

ART. TELECOMANDO	
M 00 VRC0 00 00 00 00	Modulo ricevitore con telecomando
M 00 VRC0 00 00 01 00	Telecomando aggiuntivo



PIANI PER SERRATURE E PIANI REGOLABILI

PIANO SUPERIORE PER SERRATURE



ART.		H frontale mm	kg
M 73 PS46 00 10 00 _ _		46	150

Dim. mm 1377x724x46 H

PIANO INFERIORE PER SERRATURE



ART.		H frontale mm	kg
M 73 PS46 10 10 00 _ _		46	150

Dim. mm 1377x724x46 H

PIANO REGOLABILE



ART.		H totale mm	kg
M 73 PR25 00 00 01 _ _		60	150

Dim. utili mm 1371x631x25 H

PIANO REGOLABILE FESSURATO



ART.		H frontale mm	kg
M 73 PR35 10 00 01 _ _		35	300

Dim. mm 1377x721x35 H

78x36 EH

MATERIALE DI SEPARAZIONE

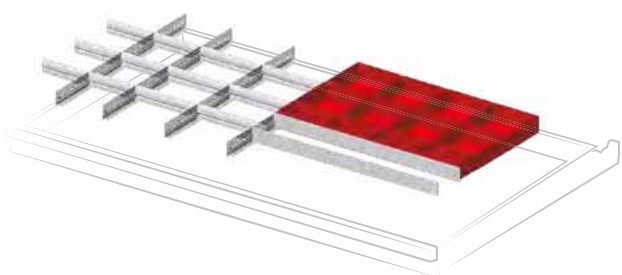

ART. per altezza frontale mm

F FH 7007 01 00 75

F FH 7010 01 00 100 - 125

Set composto da: 4 divisori longitudinali fessurati 610 mm, 2 divisori longitudinali non fessurati 610 mm, 6 divisori trasversali 149 mm, 6 divisori trasversali 200 mm, 4 cassette divisorio 150x75 mm, 8 cassette divisorio 150x150 mm

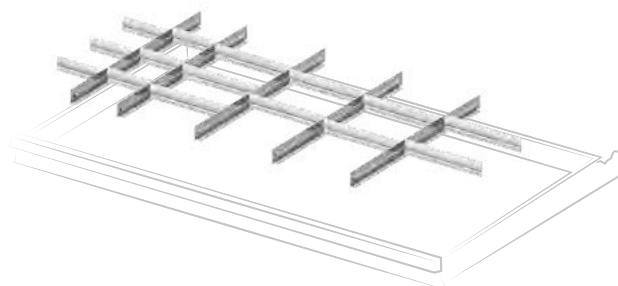

ART. per altezza frontale mm

F FH 7007 02 00 75

F FH 7010 02 00 100 - 125

F FH 7015 02 00 150

F FH 7020 02 00 200 - 250

Set composto da: 5 divisori longitudinali fessurati 610 mm, 6 divisori trasversali 149 mm, 9 divisori trasversali 251 mm

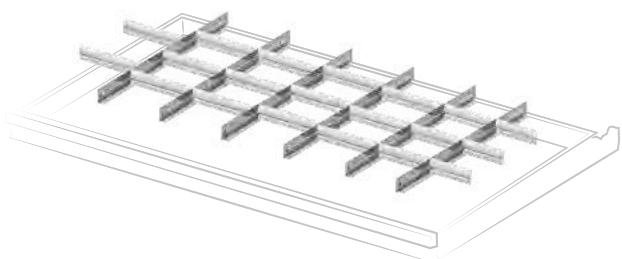

ART. per altezza frontale mm

F FH 7007 03 00 75

F FH 7010 03 00 100 - 125

F FH 7015 03 00 150

Set composto da: 6 divisori longitudinali fessurati 610 mm, 3 divisori trasversali 132 mm, 3 divisori trasversali 166 mm, 14 divisori trasversali 200 mm

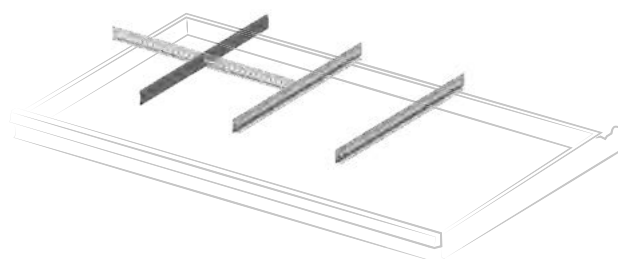

ART. per altezza frontale mm

F FH 7007 04 00 75

F FH 7010 04 00 100 - 125

F FH 7015 04 00 150

F FH 7020 04 00 200 - 250

F FH 7030 04 00 300

Set composto da: 3 divisori longitudinali fessurati 610 mm, 2 divisori trasversali 302 mm

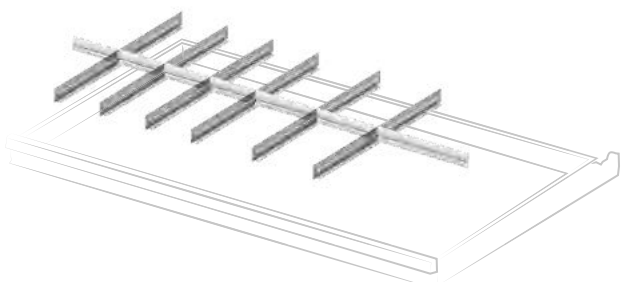

ART. per altezza frontale mm

F FH 7007 07 00 75

F FH 7010 07 00 100 - 125

F FH 7015 07 00 150

F FH 7020 07 00 200 - 250

F FH 7030 07 00 300

Set composto da: 6 divisori longitudinali fessurati 610 mm, 4 divisori trasversali 149 mm, 2 divisori trasversali 200 mm, 1 divisorio trasversale 302 mm

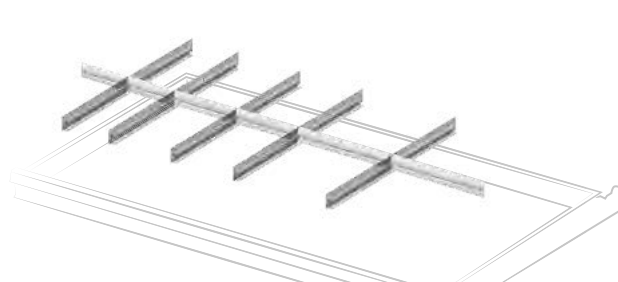

ART. per altezza frontale mm

F FH 7007 08 00 75

F FH 7010 08 00 100 - 125

F FH 7015 08 00 150

F FH 7020 08 00 200 - 250

F FH 7030 08 00 300

Set composto da: 5 divisori longitudinali fessurati 610 mm, 2 divisori trasversali 149 mm, 2 divisori trasversali 200 mm, 2 divisori trasversali 302 mm





VISTA POSTERIORE

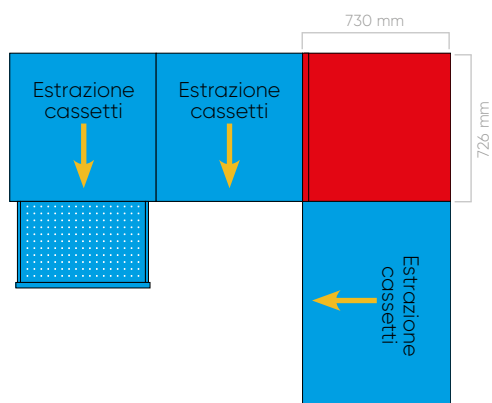

QUESTI ANGOLI POSSONO ESSERE ACCOPPIATI SOLAMENTE CON ARMADI PROFONDITÀ 726 mm (36 EH) SERIE MASTER



ART.



M 33 A100 X0 10 R1 04

ANGOLO ESTERNO DESTRO



ART.



M 33 A100 X0 10 R2 04

ANGOLO ESTERNO DESTRO COMPLETO DI PIANO
IN MDF - COPERTURA IN GOMMA ANTIOGLIO

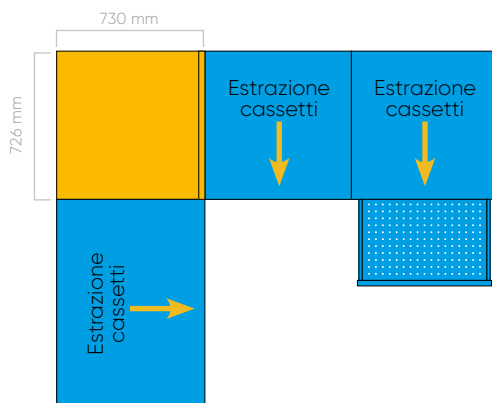

QUESTI ANGOLI POSSONO ESSERE ACCOPPIATI
SOLAMENTE CON ARMADI PROFONDITÀ 726 mm
(36 EH) SERIE MASTER



ART.



M 33 A100 XO 10 L1 04

ANGOLO ESTERNO SINISTRO



ART.



M 33 A100 XO 10 L2 04

ANGOLO ESTERNO SINISTRO COMPLETO DI PIANO
IN MDF - COPERTURA IN GOMMA ANTIOLIO



VISTA POSTERIORE

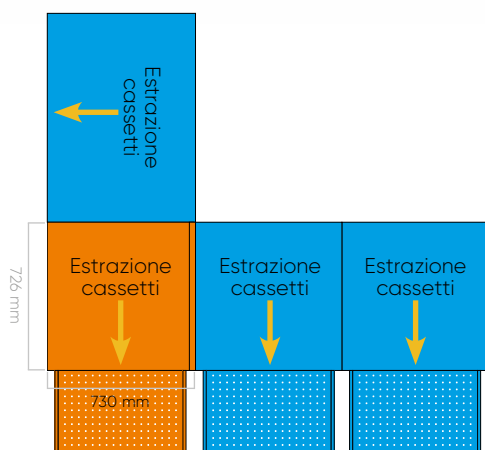

QUESTI ANGOLI POSSONO ESSERE ACCOPIATI SOLAMENTE CON ARMADI PROFONDITÀ 726 mm (36 EH) SERIE MASTER



ART.



M 33 A100 C5 10 L3 04

ANGOLO INTERNO SINISTRO



ART.



M 33 A100 C5 10 L4 04

ANGOLO INTERNO SINISTRO COMPLETO DI PIANO
IN MDF - COPERTURA IN GOMMA ANTIOLIO

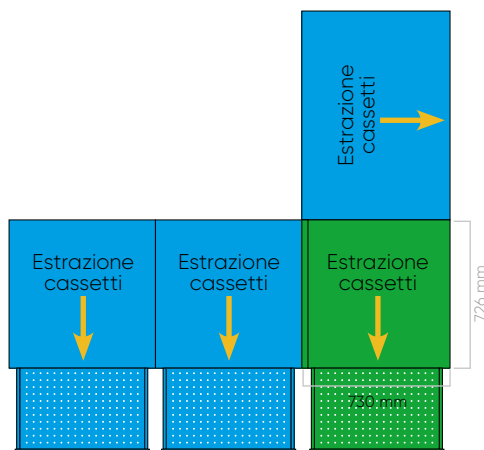

QUESTI ANGOLI POSSONO ESSERE ACCOPPIATI
SOLAMENTE CON ARMADI PROFONDITÀ 726 mm
(36 EH) SERIE MASTER



ART.



M 33 A100 C5 10 R3 04

ANGOLO INTERNO DESTRO



ART.



M 33 A100 C5 10 R4 04

ANGOLO INTERNO DESTRO COMPLETO DI PIANO
IN MDF - COPERTURA IN GOMMA ANTIOLIO

18x27 EH

**ART. M 12 A080 E2 14 NB 01**

Armadio con 4 cassetti ad estrazione flessibile
(H frontale 2x100 - 1x200 - 1x300)
Chiusura codice numerico
Top in mdf rivestito in gomma
Dim. mm 408x573x832 H
Colore acciaio grigio RAL 7000
Colore plastiche red carpet

**ART. M 12 R070 S0 11 35 35**

Armadio con ruote con 5 cassetti ad estrazione flessibile
(H frontale 2x75 - 3x150)
Chiusura a cilindro - Top a 4 bordi rivestito in pvc
Ruote in gomma standard Ø 125 mm
Dim. mm 434x647x918 H
Colore acciaio bianco puro RAL 9010
Colore plastiche mediterranean blue

ESCLUSI UTENSILI**ART. M 12 A100 T2 16 NC 35**

Armadio con 3 cassetti ad estrazione flessibile
(H frontale 1x50 - 1x100 - 1x125), 1 piano estraibile,
1 piano regolabile e 1 porta
Chiusura codice numerico - Top a 3 bordi rivestito in pvc
Dim. mm 408x598x1023 H
Colore acciaio bianco puro RAL 9010
Colore plastiche sunny yellow

27x27 EH

**ART. M ZA 0600 00 00 00 PA**

Armadi con 6 cassetti ad estrazione flessibile
(H frontale 2x50 - 2x100 - 2x125), 2 piani regolabili, 2 piani
estraibili, 2 porte
Chiusura a cilindro
Top in mdf rivestito in gomma
Dim. mm 1122x598x1032 H
Colore acciaio bianco puro RAL 9010 +
grigio antracite RAL 7016
Colore plastiche juicy orange

**ART. M 22 A100 T2 16 BC 48**

Armadio con 5 cassetti ad estrazione flessibile
(H frontale 3x75 - 1x100 - 1x150), 1 piano estraibile
Chiusura codice numerico
Dim. mm 561x598x1000 H
Colore acciaio blu capri RAL 5019
Colore plastiche sunny yellow

ART. M 22 R070 P2 10 NE 1F

Armadio con ruote con 6 cassetti ad estrazione flessibile
(H frontale 1x50 - 2x75 - 2x100 - 1x200)
Chiusura codice numerico
Top a 4 bordi rivestito in pvc
Ruote in gomma antitraccia sintetica Ø 125 mm
Dim. mm 587x647x918 H
Colore acciaio bianco grigiastro RAL 9002
Colore plastiche dark grey

**ART. M 22 A150 CO 11 NA 50**

Armadio con 5 cassetti ad estrazione flessibile
(H frontale 2x100 - 2x150 - 1x200), 2 piani regolabili,
1 porta
Chiusura a cilindro
Dim. mm 561x598x1500 H
Colore acciaio grigio RAL 7035 + blu RAL 5012
Colore plastiche mediterranean blue

36x27 EH

**ART. M 32 A100 CO 15 NP 34**

Armadio con 1 cassetto ad estrazione flessibile
(H frontale 1x100), 2 piani estraibili
Chiusura a cilindro
Top a 4 bordi rivestito in pvc
Dim. mm 714x598x1023 H
Colore acciaio blu genziana RAL 5010
Colore plastiche juicy orange

ART. M 32 A150 CO 15 NQ 34

Armadio a porte battenti, 2 piani regolabili,
1 piano estraibile
Chiusura a cilindro
Top a 4 bordi rivestito in pvc
Dim. mm 714x598x1523 H
Colore acciaio blu genziana RAL 5010
Colore plastiche juicy orange

36x27 EH

**ART. M 32 D200 C0 10 NW CQ**

Armadio doppio con 6 cassetti ad estrazione flessibile, (H frontale 6x100), 4 piani regolabili, 4 piani estraibili
Chiusura a cilindro
Dim. mm 1428x623x2000 H
Colore acciaio grigio antracite RAL 7016 + bianco grigiastro RAL 9002
Colore plastiche dark grey

**ART. M 32 R080 P2 12 NR FD**

Armadio con ruote in gomma antitraccia sintetica Ø 125 mm con 6 cassetti ad estrazione flessibile (H frontale 2x75 - 2x100 - 1x150 - 1x200)
Chiusura codice numerico
Top in multiplex con maniglie integrate
Dim. mm 780x573x988 H
Colore acciaio grigio chiaro RAL 7035 + blu genziana RAL 5010
Colore plastiche sky blue

**ART. M 32 A150 C0 14 NU 01**

Armadio con 9 cassetti ad estrazione flessibile (H frontale 2x100 - 6x150 - 1x300)
Chiusura a cilindro
Top 3 bordi rivestito in pvc
Dim. mm 714x573x1523 H
Colore acciaio grigio scuro RAL 7000
Colore plastiche glamour red

54x27 EH

**ART. M 52 D200 C0 10 PD FP**

Armadio doppio con 8 cassetti ad estrazione flessibile, (H frontale 4x100 - 4x150), 4 piani regolabili, 2 piani estraibili
Chiusura a cilindro
Dim. mm 2040x623x2000 H
Colore acciaio grigio chiaro RAL 7035 + rosso rubino RAL 3003
Colore plastiche dark grey

**ART. M 52 A200 P5 11 PC GS**

Armadio porte a battente con 5 cassetti ad estrazione flessibile, (H frontale 2x75 - 2x100 - 1x150), 1 piano regolabile, 1 piano estraibile
Chiusura codice numerico
Dim. mm 1020x598x2000 H
Colore acciaio blu RAL 5012 + bianco puro RAL 9010
Colore plastiche mediterranean blue

SOLUZIONI SEZIONE MASTER

EH 36 27

**ART. M 23 R070 P2 14 NL 08**

Armadio con ruote con 5 cassetti ad estrazione flessibile (H frontale 2x75 - 1x100 - 1x150 - 1x200)
Chiusura codice numerico
Top a 4 bordi rivestito in pvc
Ruote in poliuretano Ø 160 mm
Dim. mm 587x800x963 H
Colore acciaio grigio chiaro RAL 7035
Colore plastiche red carpet

ART. M 23 A100 CO 16 NG 04

Armadio con 3 cassetti ad estrazione flessibile (H frontale 1x50 - 1x100 - 1x125), 1 piano estraibile, 1 piano regolabile e 1 porta
Chiusura a cilindro
Top a 3 bordi rivestito in pvc
Dim. mm 561x751x1023 H
Colore acciaio blu RAL 5012
Colore plastiche sunny yellow

**ART. M 23 R080 P2 15 NM 39**

Armadio con ruote con 5 cassetti ad estrazione flessibile (H frontale 1x50 - 2x100 - 1x150 - 1x300)
Chiusura codice numerico
Top a 4 bordi rivestito in pvc
Ruote in gomma antitraccia sintetica Ø 160 mm
Dim. mm 587x800x1063 H
Colore acciaio grigio antracite RAL 7016
Colore plastiche juicy orange

**ART. M 23 A150 XO 14 NH AE**

Armadio con 3 cassetti ad estrazione flessibile (H frontale 1x50 - 1x100 - 1x150), 1 piano regolabile, 1 piano estraibile
Chiusura a cilindro
Dim. mm 561x751x1500 H
Colore acciaio rosso rubino RAL 3003 + grigio scuro RAL 7000
Colore plastiche red carpet

**ART. M 33 D100 CO 10 NN NQ**

Armadio con 8 piani estraibili ad estrazione flessibile
Top in mdf rivestito in gomma
Chiusura a cilindro
Dim. mm 1428x776x1000 H
Colore acciaio rosso rubino RAL 3003 + bianco grigiastro RAL 9002
Colore plastiche dark grey

**ART. M 33 A100 E2 12 NY FD**

Armadio con 7 cassetti ad estrazione flessibile (H frontale 1x50 - 2x75 - 2x100 - 1x200 - 1x300)
Chiusura codice numerico
Top a 3 bordi rivestito in pvc
Dim. mm 714x726x1023 H
Colore acciaio grigio chiaro RAL 7035 + blu genziana RAL 5010
Colore plastiche sky blue

ART. M 33 R080 P2 10 NK 1G

Armadio con ruote con 6 cassetti ad estrazione flessibile (H frontale 2x75 - 2x100 - 1x150 - 1x200)
Chiusura codice numerico
Ruote in poliuretano Ø 160 mm
Top a 4 bordi rivestito in pvc
Dim. mm 740x800x1063 H
Colore acciaio rosso rubino RAL 3003
Colore plastiche dark grey

45x36 EH

**ART. M 43 R070 P2 10 RA EF**

Armadio con ruote con 6 cassetti ad estrazione flessibile (H frontale 2x75 - 3x100 - 1x150)
Chiusura codice numerico
Top 4 bordi rivestito in pvc
Ruote in gomma antiriscaldamento sintetica Ø 160 mm
Dim. mm 947x752x963 H
Colore acciaio grigio scuro RAL 7000 + grigio chiaro RAL 7035
Colore plastiche dark grey

**ART. M 43 R070 SO 11 PB EF**

Armadio con ruote con 6 cassetti ad estrazione flessibile (H frontale 2x75 - 3x100 - 1x150)
Chiusura a cilindro
Top in multiplex con maniglie integrate
Ruote in antiriscaldamento sintetica Ø 160 mm
Dim. mm 933x726x933 H
Colore acciaio grigio scuro RAL 7000 + grigio chiaro RAL 7035
Colore plastiche mediterranean blue

**ART. M 43 A085 E2 14 PA 48**

Armadio con 7 cassetti ad estrazione flessibile (H frontale 1x50 - 2x75 - 2x100 - 1x150 - 1x200), 1 coppia zoccoli per carrello elevatore H 100 mm,
Chiusura codice numerico - Top in multiplex
Dim. mm 867x726x990 H
Colore acciaio blu capri RAL 5019
Colore plastiche red carpet
Morsa esclusa

54x36 EH

**ART. M 53 D150 C0 10 PF NR**

Armadio doppio con 9 cassetti ad estrazione flessibile (H frontale 6x100 - 2x150 - 1x300)
2 top a 3 bordi rivestito in pvc
Chiusura codice numerico e a cilindro
Dim. mm 2040x776x1523 H
Colore acciaio bianco grigiastro RAL 9002 + blu genziana RAL 5010
Colore plastiche dark grey

**ART. M 53 R070 P2 14 PG 35**

Armadio con ruote con 6 cassetti ad estrazione flessibile (H frontale 2x75 - 3x100 - 1x150)
Chiusura codice numerico
Top in multiplex con maniglie integrate
Ruote in poliuretano Ø 160 mm
Dim. mm 1086x726x933 H
Colore acciaio bianco puro RAL 9010
Colore plastiche red carpet

**ART. M ZA 0400 00 00 00 08**

Armadi con 12 cassetti ad estrazione flessibile (H frontale 4x75 - 2x100 - 4x150 - 2x200),
2 armadi a tapparella H 812 mm
Chiusura a cilindro
Top in multiplex
Dim. mm 2040x726x1702 H
Colore acciaio grigio chiaro RAL 7035
Colore plastiche mediterranean blue

SOLUZIONI SEZIONE MASTER



64x36 EH



ART. M 63 R085 P2 16 PM 1G

Armadio con ruote con 5 cassetti ad estrazione flessibile
(H frontale 1x100 - 3x150 - 1x200)
Chiusura codice numerico
Top in multiplex con maniglie integrate
Ruote in poliuretano Ø 160 mm
Dim. mm 1256x726x1083 H
Colore rosso rubino RAL 3003
Colore plastiche sunny yellow



ART. M 63 A085 E2 10 PK 1G

Armadio con 5 cassetti ad estrazione flessibile
(H frontale 1x100 - 3x150 - 1x200)
Chiusura codice numerico
Coppia zoccoli H 100 mm
Top in mdf rivestito in gomma
Dim. mm 1190x726x982 H
Colore rosso rubino RAL 3003
Colore plastiche dark grey

78x36 EH



ART. M 73 R085 P2 12 PR 35

Armadio con ruote con 6 cassetti ad estrazione flessibile
(H frontale 2x75 - 1x100 - 2x150 - 1x200)
Chiusura codice numerico
Top in multiplex con maniglie integrate
Ruote in gomma antitraccia Ø 160 mm
Dim. mm 1494x726x1083 H
Colore acciaio bianco puro RAL 9010
Colore plastiche sky blue



ART. M 73 A100 E2 17 PN 39

Armadio con 7 cassetti ad estrazione flessibile
(H frontale 2x75 - 2x100 - 1x150 - 2x200)
Chiusura codice numerico
Top a 3 bordi rivestito in pvc
Dim. mm 1428x726x1023 H
Colore acciaio grigio antracite RAL 7016
Colore plastiche forest green

SOLUZIONI SEZIONE MASTER

EH
36

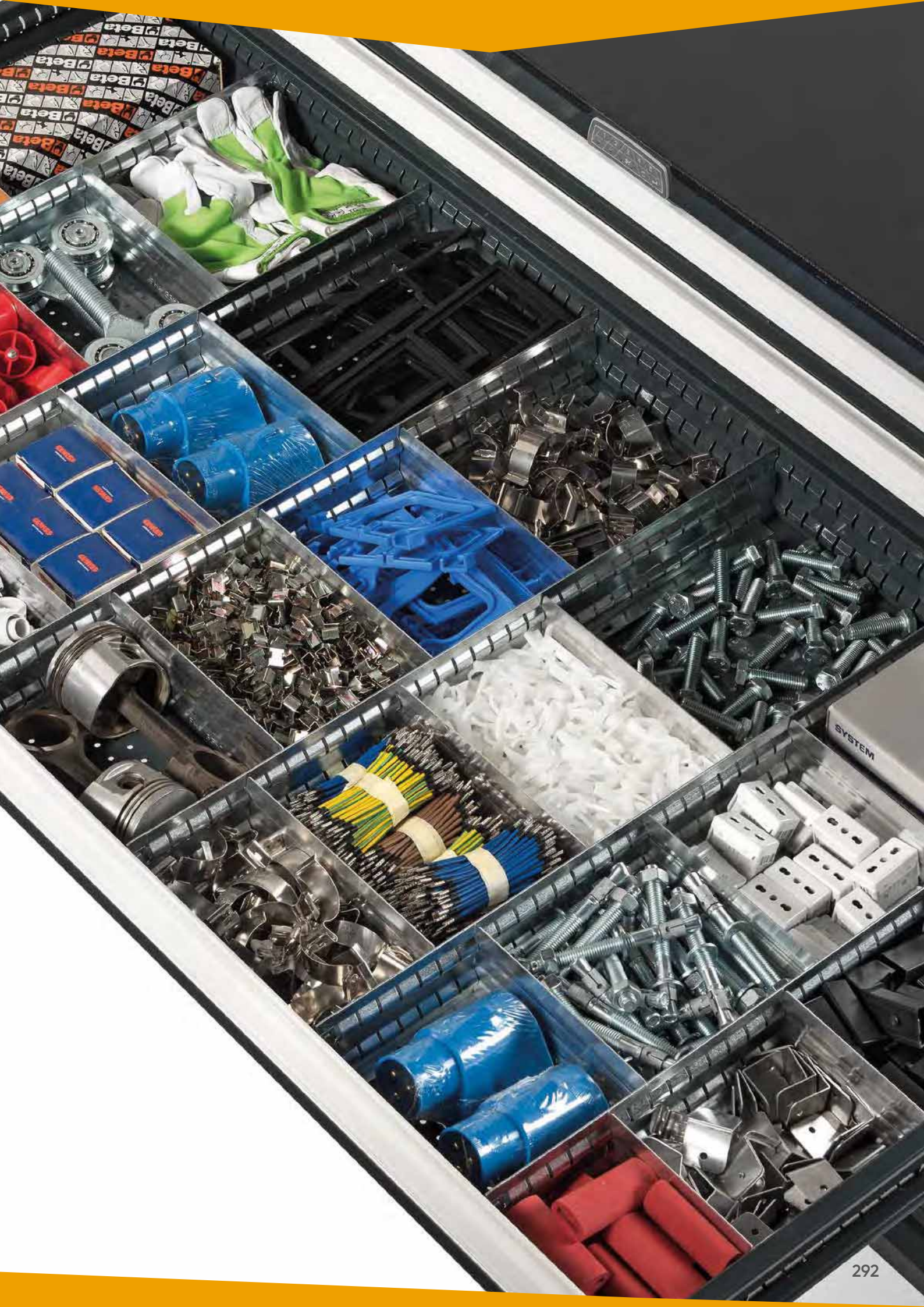

CONTATTACI PER
SOLUZIONI
PERSONALIZZATE



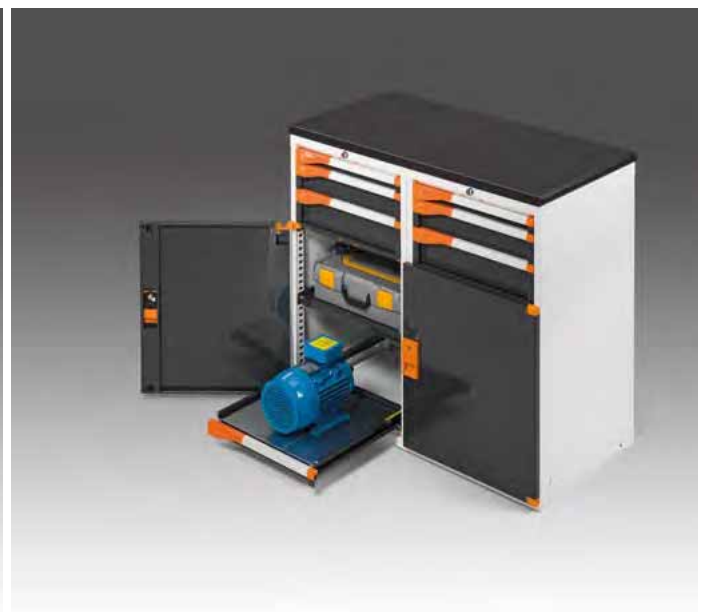

IL PIÙ VENDUTO DAL 1984

ROBUSTO PER ECCELLENZA

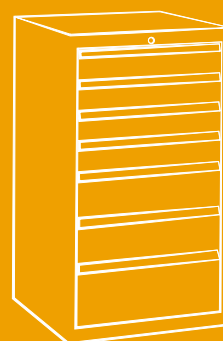



STANDARD

CARATTERISTICHE TECNICHE



1



PARTICOLARE DEL CUSCINETTO

I cassetti e i piani estraibili sono forniti in 2 versioni:
 - **estrazione semplice** pari a 87% con portate che variano da 60 a 100 Kg a seconda della versione. La scorrevolezza del cassetto è garantita da 4 cuscinetti ad alta resistenza.
 - **estrazione totale telescopica** pari a 100% con portate che variano da 150 a 200 Kg a seconda della versione. La scorrevolezza del cassetto è garantita da 8 cuscinetti ad alta resistenza.

2 Agli armadi tipo STANDARD può essere applicato un top superiore, composto da un piano in MDF accoppiato a una copertura in acciaio rivestita in gomma antiolio. Questa copertura viene fornita con le stesse dimensioni dell'armadio e possono essere unite facilmente tra di loro creando una superficie continua (vedi esempio).

APPLICAZIONE PIANO IN MDF

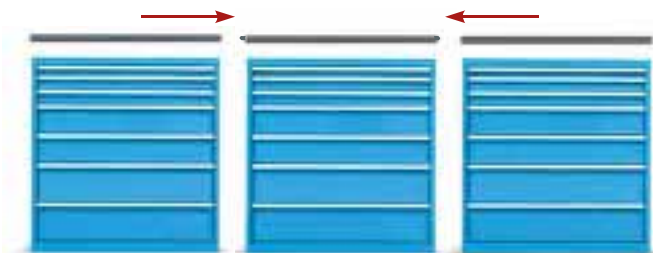

3

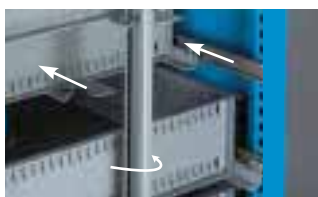
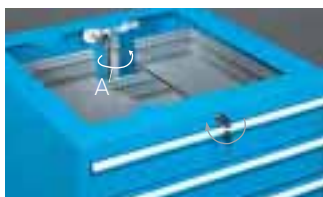

L'asta di chiusura funge anche da sistema antiribaltamento nel momento in cui il cassetto viene estratto. Infatti il gancio posteriore del cassetto fa ruotare in posizione di chiusura l'asta posteriore (A). In questo modo è impedita all'operatore l'estrazione simultanea di più cassetti evitando un pericoloso spostamento del peso verso l'esterno. Una volta chiuso il cassetto, l'asta ritorna in posizione di apertura consentendo l'estrazione di un altro cassetto.



CHIUSURA A CILINDRO

Chiusura a cilindro fornita di serie con 2 chiavi

4



STANDARD

564x726 mm



● ART. F DD 1070 52 04
H = 800 mm - 6 cassetti

 Gamma colori ACCIAIO



ESTRAZIONE SEMPLICE 87% = 60/100 kg



CHIUSURA CON CHIAVE (KEY)
Fornito di serie con chiusura a cilindro e 2 chiavi

LEGENDA



PORTATA CASSETTO/
PIANO



ESTRAZIONE CASSETTO/
PIANO



CHIUSURA ARMADIO



LE PORTATE SONO NETTE E SI RIFERISCONO A PESI UNIFORMEMENTE DISTRIBUITI.

H 700 mm



*portata massima 80 kg

ART.				
F DD 1060 51 04		100	87%	key

H 700 mm



porta 425 mm

*portata massima 70 kg

ART.				
F DD 1160 51 04		80	87%	key

H 800 mm



ART.				
F DD 1070 55 04		100	87%	key

H 800 mm



*portata massima 60 kg

ART.				
F DD 1070 51 04		100	87%	key

H 800 mm



*portata massima 80 kg

ART.				
F DD 1070 52 04		100	87%	key

H 800 mm



porta 425 mm



*portata massima 70 kg

ART.				
F DD 1170 51 04		100	87%	key

CONFIGURA IL TUO ARMADIO



ARMADIO VUOTO

ART.		dim. mm	H utile mm	
F DD 1060 00 04		564x726x700 H	600	3100
F DD 1070 00 04		564x726x800 H	700	3100



ARMADIO VUOTO CON PORTA - APERTURA VERSO DX

ART.		dim. mm	H porta mm	H utile mm	
F DD 1260 D0 04		564x726x700 H	600	600	3100

ARMADIO VUOTO CON PORTA - APERTURA VERSO SX

ART.		dim. mm	H porta mm	H utile mm	
F DD 1261 D0 04		564x726x700 H	600	600	3100



Non è possibile inserire i cassetti dietro alle porte

ARMADIO VUOTO PREDISPOSTO PER PORTE

ART.		dim. mm	H porta mm (A)	utile cassetti mm (B)	H utile mm (C)	
F DD 1160 00 04		564x726x700 H	400	175	600	3100
			425	150		
			500	75		
F DD 1170 00 04		564x726x800 H	400	275	700	3100
			425	250		
			500	175		
			575	100		
			600	75		

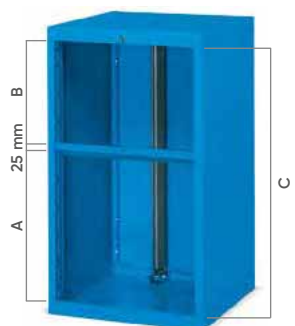

CASSETTI AD ESTRAZIONE SEMPLICE



ART.		dim. utili mm	H frontale mm		
F DD 8050 00 04		447x600x36 H	50	87%	60
F DD 8075 00 04		447x600x61 H	75	87%	80
F DD 8100 00 04		447x600x86 H	100	87%	100
F DD 8150 00 04		447x600x136 H	150	87%	100
F DD 8200 00 04		447x600x186 H	200	87%	100
F DD 8300 00 04		447x600x286 H	300	87%	100



Non è possibile inserire i cassetti dietro alle porte



É obbligatorio applicare a tutti i cassetti inseriti negli armadi con ruote il dispositivo di apertura singola dei cassetti ART. F DD 9400 00 07

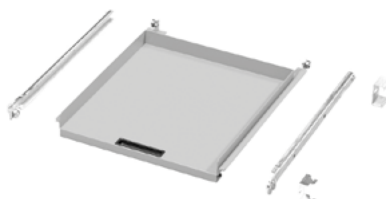

PIANO ESTRAIBILE

ART.		dim. utili mm	H laterale mm		
F DD 8000 00 04		435x630	-	87%	70

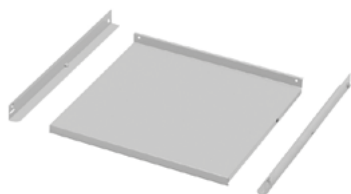

PIANO REGOLABILE

ART.		dim. utili mm	H laterale mm	
F DD 9100 01 04		500x618	60	70

PORTA REVERSIBILE



ART.		H (A) mm	
F DD 9640 01 04		400	
F DD 9642 01 04		425	
F DD 9645 01 04		500	
F DD 9649 01 04		575	
F DD 9650 01 04		600	

Queste porte si possono montare sia con apertura a destra che a sinistra



Non è possibile inserire i cassetti dietro alle porte

PIANO SUPERIORE A 3 BORDI



ART.	dim. mm	
F DD 9150 01 07	564x726x20 H	

Piano rivestito in pvc. Colore nero

PIANO SUPERIORE IN MDF DIM. 565x726x31,5 mm H



ART.	rifiniture	per armadio	
F UZ 3200 11 07	1 profilo laterale	finale dx o sx	

Piano in MDF con copertura in gomma antiolio. Colore nero

PIANO SUPERIORE IN MDF DIM. 565x726x31,5 mm H



ART.	rifiniture	per armadio	
F UZ 3200 12 07	-	centrale	

Piano in MDF con copertura in gomma antiolio. Colore nero

PIANO SUPERIORE IN MDF DIM. 565x726x31,5 mm H



ART.	rifiniture	per armadio	
F UZ 3200 13 07	2 profili laterali	singolo	

Piano in MDF con copertura in gomma antiolio. Colore nero



ART. F UZ 9999 00 00

FORATURA PIANO SUPERIORE DELL'ARMADIO PER IL FISSAGGIO DEL PIANO IN MDF
COMPRESIVO DI VITI PER IL FISSAGGIO



RIFINITURA
GOMMA
ANTIOILIO



APPLICAZIONE
PIANO IN MDF

ZOCCOLI



ART.	H mm	
F DD 9300 00 07	50	
F DD 9330 00 07	100	

Colore nero RAL 9005

RUOTA FISSA IN GOMMA STANDARD

ART.	Ø mm	portata armadio kg	C mm
C RG BAC11 100	100	160	128
C RG BAC12 125	125	235	155
C RG BAC13 150	150	280	180



RUOTA GIREVOLE CON FRENO IN GOMMA STANDARD

ART.	Ø mm	portata armadio kg	C mm
C RG DAC11 100	100	160	128
C RG DAC12 125	125	235	155
C RG DAC13 150	150	280	180



RUOTA FISSA IN NYLON

ART.	Ø mm	portata armadio kg	C mm
C RN BAD10 100	100	310	128
C RN BAD11 125	125	475	155



RUOTA GIREVOLE CON FRENO IN NYLON

ART.	Ø mm	portata armadio kg	C mm
C RN DAD10 100	100	310	128
C RN DAD11 125	125	475	155



FISSAGGIO

SET FISSAGGIO TRA ARMADI

ART. F AG 9202 00 99

Set di fissaggio armadio-armadio con 4 viti complete di dadi M8

ART. F AG 9203 00 99

Foratura e viteria per il fissaggio dei due armadi sovrapposti

SET DI FISSAGGIO A PAVIMENTO



ART. F AG 9200 00 99

Coppia staffe zincate per il fissaggio a pavimento dell'armadio

ART. F AG 9204 00 99

2 tasselli "HILTI" adatti per pavimenti in calcestruzzo non fessurato maggiore o uguale alla classe C20/25
Trazione consigliata del tassello: 2,9 kN
Diametro tassello: Ø 6 mm



GLI ARMADI DEVONO ESSERE FISSATI A PAVIMENTO O A PARETE. SE SOVRAPPOSTI DEVONO ESSERE FISSATI OBBLIGATORIAMENTE A PARETE E LA LORO PORTATA DIVISA PER DUE

27x36 EH

MATERIALE DI SEPARAZIONE

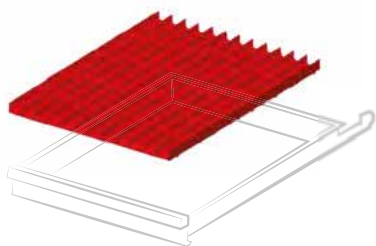

ART. per altezza frontale mm

F FH 8605 01 00 50 - 300

Set composto da: 12 divisori 4 canali, 50 divisori trasversali 36 mm

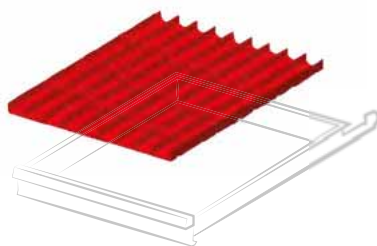

ART. per altezza frontale mm

F FH 8605 06 00 50 - 300

Set composto da: 12 divisori 3 canali, 27 divisori trasversali 47 mm

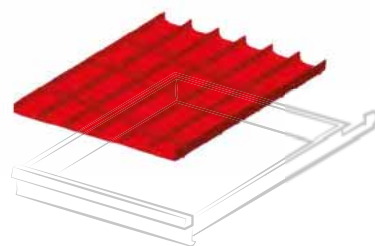

ART. per altezza frontale mm

F FH 8605 04 00 50 - 300

Set composto da: 12 divisori 2 canali, 18 divisori trasversali 73 mm

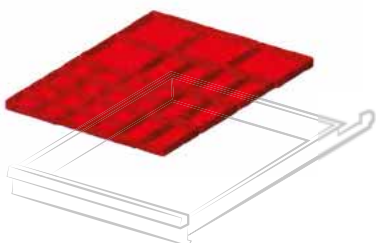

ART. per altezza frontale mm

F FH 8605 16 00 50

F FH 8607 16 00 75

Set composto da: 16 cassette divisorio a 2 comparti 75x75 mm, 16 cassette divisorio 75x75 mm, 4 cassette divisorio 150x75 mm, 2 cassette divisorio 150x150 mm

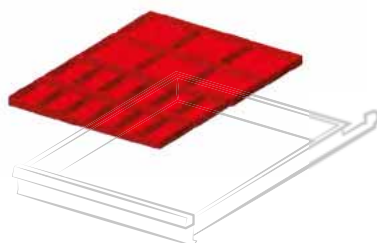

ART. per altezza frontale mm

F FH 8605 17 00 50

F FH 8607 17 00 75

Set composto da: 16 cassette divisorio 75x75 mm, 8 cassette divisorio 150x75 mm, 4 cassette divisorio 150x150 mm

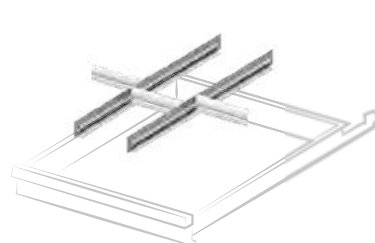

ART. per altezza frontale mm

F FH 8605 08 00 50

F FH 8607 08 00 75

F FH 8610 08 00 100 - 125

F FH 8615 08 00 150

F FH 8620 08 00 200 - 250

F FH 8630 08 00 300

Set composto da: 2 divisori longitudinali fessurati 610 mm, 3 divisori trasversali 149 mm

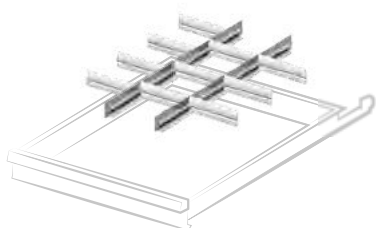

ART. per altezza frontale mm

F FH 8605 09 00 50

F FH 8607 09 00 75

F FH 8610 09 00 100 - 125

F FH 8615 09 00 150

F FH 8620 09 00 200 - 250

Set composto da: 2 divisori longitudinali fessurati 610 mm, 10 divisori trasversali 149 mm

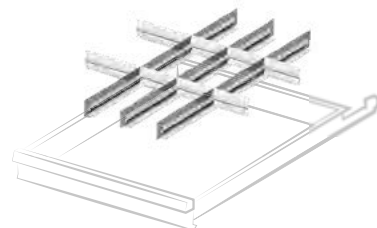

ART. per altezza frontale mm

F FH 8605 10 00 50

F FH 8607 10 00 75

F FH 8610 10 00 100 - 125

F FH 8615 10 00 150

Set composto da: 3 divisori longitudinali fessurati 610 mm, 6 divisori trasversali 98 mm, 2 divisori trasversali 149 mm

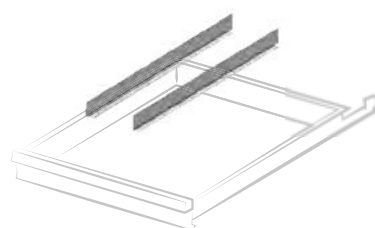

ART. per altezza frontale mm

F FH 8605 13 00 50

F FH 8607 13 00 75

F FH 8610 13 00 100 - 125

F FH 8615 13 00 150

F FH 8620 13 00 200 - 250

F FH 8630 13 00 300

Set composto da: 2 divisori longitudinali non fessurati 610 mm

CONFIGURA IL CASSETTO FAMI CON UTENSILI BETA

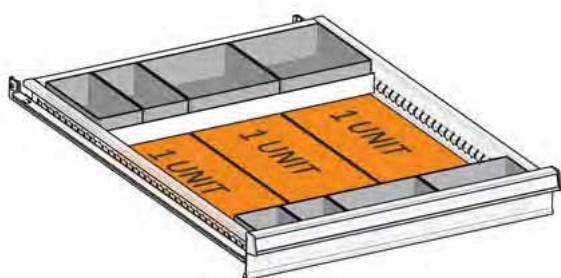

ART. F FH 0907 50 07

Set di predisposizione cassetto per termoformati Beta composto da:

- n. 2 F HC 6071 00 07
- n. 4 F HC 6471 00 07
- n. 2 F HC 6871 00 07
- n. 1 F HA 1120 00 99
- n. 1 F HA 2120 00 99

1 unit = 1 termoformato Beta 367x147 mm

2 unit = 1 termoformato Beta 367x294 mm

ESEMPI DI UTILIZZO TERMOFORMATO

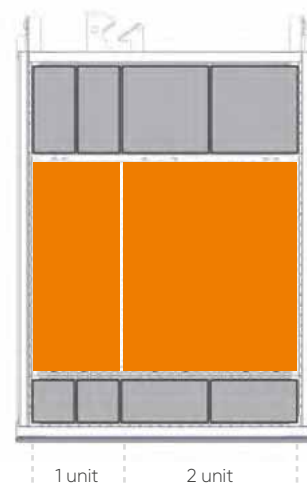
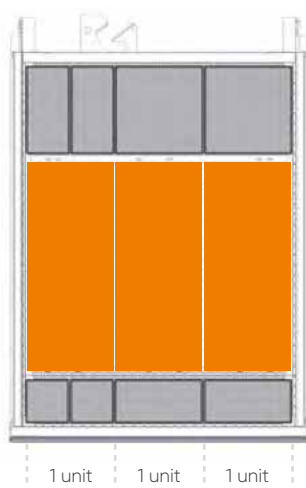

STANDARD

717x726 mm



● **ART. F AG 2040 18 04**
H = 1000 mm - 8 cassetti

 Gamma colori ACCIAIO



ESTRAZIONE SEMPLICE 87% = 60/100 kg



CHIUSURA CON CHIAVE (KEY)
Fornito di serie con chiusura a cilindro e 2 chiavi

LEGENDA



PORTATA CASSETTO/
PIANO



ESTRAZIONE CASSETTO/
PIANO



CHIUSURA ARMADIO



LE PORTATE SONO NETTE E SI RIFERISCONO A PESI UNIFORMEMENTE DISTRIBUITI.

H 1000 mm



H 1000 mm



ART.				
F AG 2040 01 04		100	87%	key
F AG 2040 51 04		200	100%	key

ART.				
F AG 2040 11 04		100	87%	key
F AG 2040 61 04		200	100%	key

*cassetto ad estrazione telescopica portata 200 kg

H 1000 mm



H 1000 mm



ART.				
F AG 2040 12 04		100	87%	key
F AG 2040 53 04		200	100%	key

ART.				
F AG 2040 18 04		100	87%	key
F AG 2040 68 04		200	100%	key

*portata massima 80 kg (87%)

*portata massima 80 kg (87%)

H 1000 mm



H 1000 mm





ART.				
F AG 2040 10 04		100	87%	key
F AG 2040 60 04		200	100%	key

ART.				
F AG 2040 21 04		80	87%	key
F AG 2040 71 04		200	100%	key

CONFIGURA IL TUO ARMADIO





ARMADIO VUOTO

ART.		dim. mm	H utile mm	
F AG 2040 00 04		717x726x1000 H	900	3100

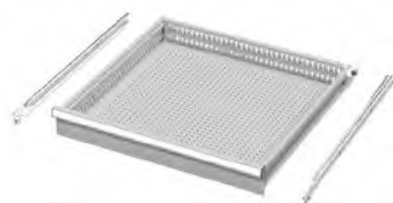

CASSETTI AD ESTRAZIONE SEMPLICE



ART.		dim. utili mm	H frontale mm		
F FG 2005 00 04		600x600x36 H	50	87%	60
F FG 2007 00 04		600x600x61 H	75	87%	80
F FG 2010 00 04		600x600x86 H	100	87%	100
F FG 2015 00 04		600x600x136 H	150	87%	100
F FG 2020 00 04		600x600x186 H	200	87%	100

CASSETTI AD ESTRAZIONE TELESCOPICA



ART.		dim. utili mm	H frontale mm		
F FG 2107 00 04		600x600x54 H	75	100%	200
F FG 2110 00 04		600x600x79 H	100	100%	200
F FG 2112 00 04		600x600x104 H	125	100%	200
F FG 2115 00 04		600x600x129 H	150	100%	200
F FG 2117 00 04		600x600x154 H	175	100%	200
F FG 2120 00 04		600x600x179 H	200	100%	200
F FG 2130 00 04		600x600x279 H	300	100%	200
F FG 2140 00 04		600x600x379 H	400	100%	200



É obbligatorio applicare a tutti i cassette inseriti negli armadi con ruote il dispositivo di apertura singola dei cassette ART. F DD 9400 00 07



PIANO REGOLABILE

ART.		dim. utili mm	H laterale mm	kg
F SR 1260 01 04		655x618	60	150



PIANO SUPERIORE A 3 BORDI

ART.	dim. mm
F AG 9003 01 07	717x726x20 H

Piano rivestito in pvc. Colore nero



PIANO SUPERIORE IN MDF DIM. 718x726x31,5 mm H

ART.	rifiniture	per armadio
F UZ 3220 11 07	1 profilo laterale	finale dx o sx

Piano in MDF con copertura in gomma antiolio. Colore nero



PIANO SUPERIORE IN MDF DIM. 718x726x31,5 mm H

ART.	rifiniture	per armadio
F UZ 3220 12 07	-	centrale

Piano in MDF con copertura in gomma antiolio. Colore nero



PIANO SUPERIORE IN MDF DIM. 718x726x31,5 mm H

ART.	rifiniture	per armadio
F UZ 3220 13 07	2 profili laterali	singolo

Piano in MDF con copertura in gomma antiolio. Colore nero



**RIFINITURA
GOMMA
ANTIOLIO**



**APPLICAZIONE
PIANO IN MDF**



ART. F UZ 9999 00 00

FORATURA PIANO SUPERIORE DELL'ARMADIO PER IL FISSAGGIO DEL PIANO IN MDF
COMPRESIVO DI VITI PER IL FISSAGGIO.



ZOCCOLI

ART.	H mm	
F RR 0070 00 07	50	

Colore nero RAL 9005



ZOCCOLI PER TRANSPALLET

ART.	H mm	
F RR 0310 00 07	100	
F RR 0405 00 07	chiusura per zoccolo	

Colore nero RAL 9005



ZOCCOLI PER CARRELLO ELEVATORE

ART.	H mm	
F RR 0230 00 07	60	
F RR 0400 00 07	chiusura per zoccoli	

Colore nero RAL 9005

RUOTA FISSA IN GOMMA ELASTICA

ART.	Ø mm	portata armadio kg	C mm	
C RG BCE15 125	125	400	155	



RUOTA GIREVOLE CON FRENO IN GOMMA ELASTICA

ART.	Ø mm	portata armadio kg	C mm	
C RG DCE15 125	125	400	155	



RUOTA FISSA IN NYLON

ART.	Ø mm	portata armadio kg	C mm	
C RN BAD10 100	100	235	128	
C RN BAD11 125	125	400	155	



RUOTA GIREVOLE CON FRENO IN NYLON

ART.	Ø mm	portata armadio kg	C mm	
C RN DAD10 100	100	235	128	
C RN DAD11 125	125	400	155	





PANNELLO FORATO

ART.		dim. mm
M 30 PA71 00 00 00 04		708x65x718 H

ESEMPI DI PANNELLO FORATO CON GANCI/VISUAL BOX



2 ART. FAXVBCH00600001
1 ART. F BL 9541 00 00 (10 pz.)
1 ART. C MV 10 019



2 ART. FAXVBCH00900001
2 ART. FAXVBCH00600001
2 ART. FAXVBCH00500001



2 ART. FAXVBCH00600001
3 ART. FAXVBCH00500001



3 ART. FAXVBCH00600001
1 ART. FAXVBCH00500001
1 ART. FAXVBCH00400001



ART. M 00 PA71 00 00 FO 00
FORATURA PIANO SUPERIORE IN MDF O
MULTIPLY PER IL FISSAGGIO DEL PANNELLO
FORATO - COMPRESIVO DI VITI



ART. M 00 PA71 00 00 F1 00
FORATURA PIANO SUPERIORE A 3 - 4
BORDI PER IL FISSAGGIO DEL PANNELLO
FORATO - COMPRESIVO DI VITI



ART. M 00 PA71 00 00 F2 00
SET DI PREDISPOSIZIONE PER IL FIS-
SAGGIO DEI VISUAL BOX AL PANNELLO
FORATO

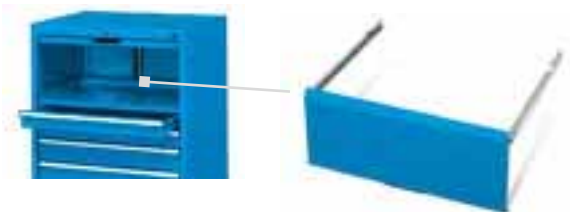

Con la porta basculante è necessario l'uso del piano regolabile ART. F SR 1260 01 04

PORTA BASCULANTE

ART.		H mm
F AG 9530 00 04		300

Porta basculante completa di coppia guide

ART. F AG L234 S2 50

Dim. mm 794x726x1812 H
Armadio con ruote completo di 4 cassetti,
1 porta basculante, 1 piano regolabile,
1 copertura in MDF rivestita in gomma,
1 pannello forato
Colore grigio RAL 7035 + blu RAL 5012
ESCLUSO UTENSILI, GANCI E VALIGETTE



FISSAGGIO

SET FISSAGGIO TRA ARMADI

ART. F AG 9202 00 99

Set di fissaggio armadio-armadio con 4 viti complete di dadi M8

ART. F AG 9203 00 99

Foratura e viteria per il fissaggio dei due armadi sovrapposti

SET DI FISSAGGIO A PAVIMENTO



ART. F AG 9200 00 99

Coppia staffe zincate per il fissaggio a pavimento dell'armadio

ART. F AG 9204 00 99

2 tasselli "HILTI" adatti per pavimenti in calcestruzzo non fessurato maggiore o uguale alla classe C20/25
Trazione consigliata del tassello: 2,9 kN
Diametro tassello: Ø 6 mm



GLI ARMADI DEVONO ESSERE FISSATI A PAVIMENTO O A PARETE. SE SOVRAPPOSTI DEVONO ESSERE FISSATI OBBLIGATORIAMENTE A PARETE E LA LORO PORTATA DIVISA PER DUE



Soluzione composta da 1 armadio ad angolo, 6 armadi completi di cassetti, piani estraibili, piani regolabili, coperture in MDF rivestite in gomma. Colore grigio RAL 7035 + grigio RAL 7000
ESCLUSO UTENSILI, CONTENITORI E MATERIALE DI SEPARAZIONE

ART. F AG ZA02 00 56



36x36 EH

MATERIALE DI SEPARAZIONE

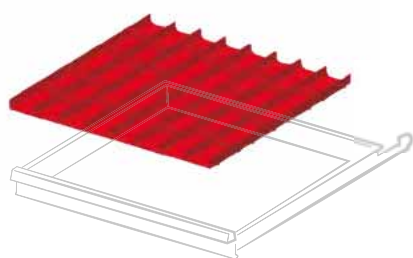

ART. per altezza frontale mm

F FH 2005 15 00 50 - 300

Set composto da: 16 divisori 2 canali, 35 divisori trasversali 73 mm

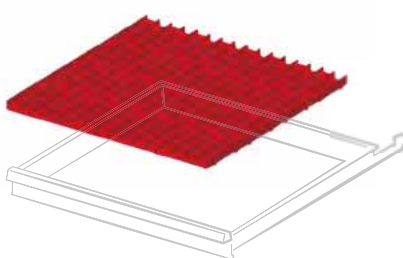

ART. per altezza frontale mm

F FH 2005 16 00 50 - 300

Set composto da: 16 divisori 3 canali, 50 divisori trasversali 47 mm

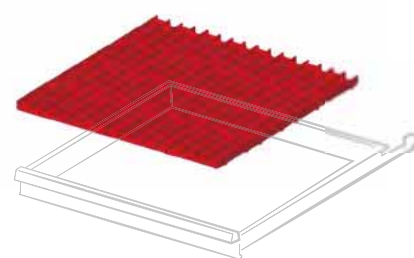

ART. per altezza frontale mm

F FH 2005 17 00 50 - 300

Set composto da: 16 divisori 4 canali, 65 divisori trasversali 36 mm

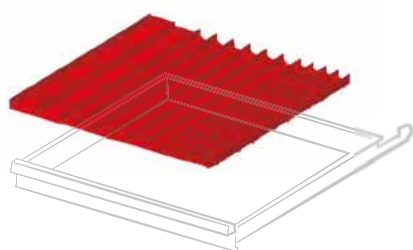

ART. per altezza frontale mm

F FH 2005 20 00 50 - 300

Set composto da: 4 divisori 4 canali, 8 divisori 3 canali, 4 divisori 2 canali, 30 divisori trasversali 36 mm, 20 divisori trasversali 47 mm, 10 divisori trasversali 73 mm

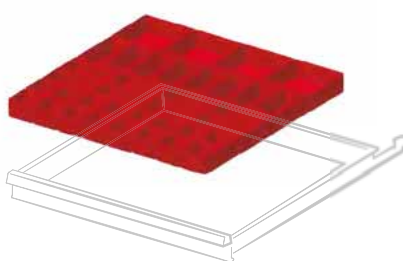

ART. per altezza frontale mm

F FH 2005 12 00 50

F FH 2007 12 00 75
Set composto da: 16 cassette divisorio 75x75 mm, 16 cassette divisorio 150x75 mm, 4 cassette divisorio 150x150 mm

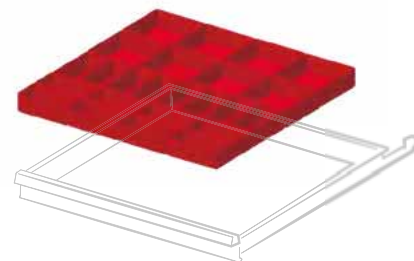

ART. per altezza frontale mm

F FH 2005 13 00 50

F FH 2007 13 00 75

F FH 2010 13 00 100 - 125

Set composto da: 16 cassette divisorio 150x75 mm, 8 cassette divisorio 150x150 mm

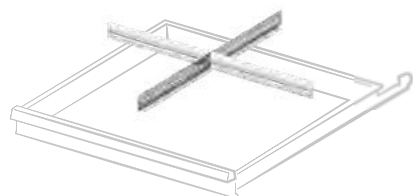

ART. per altezza frontale mm

F FH 2005 05 00 50

F FH 2007 05 00 75

F FH 2010 05 00 100 - 125

F FH 2015 05 00 150 - 175

F FH 2020 05 00 200 - 250

F FH 2030 05 00 300

Set composto da: 1 divisorio longitudinale fessurato 610 mm, 2 divisori trasversali 302 mm

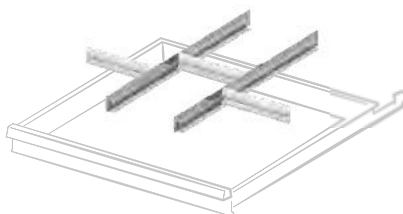

ART. per altezza frontale mm

F FH 2005 06 00 50

F FH 2007 06 00 75

F FH 2010 06 00 100 - 125

F FH 2015 06 00 150 - 175

F FH 2020 06 00 200 - 250

F FH 2030 06 00 300

Set composto da: 2 divisori longitudinali fessurati 610 mm, 3 divisori trasversali 200 mm

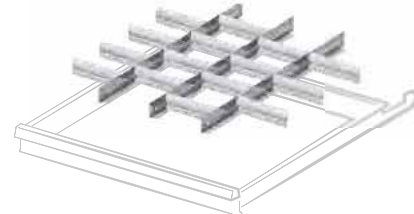

ART. per altezza frontale mm

F FH 2005 07 00 50

F FH 2007 07 00 75

F FH 2010 07 00 100 - 125

F FH 2015 07 00 150 - 175

F FH 2020 07 00 200 - 250

Set composto da: 3 divisori longitudinali fessurati 610 mm, 15 divisori trasversali 149 mm

CONFIGURA IL CASSETTO FAMI CON UTENSILI BETA

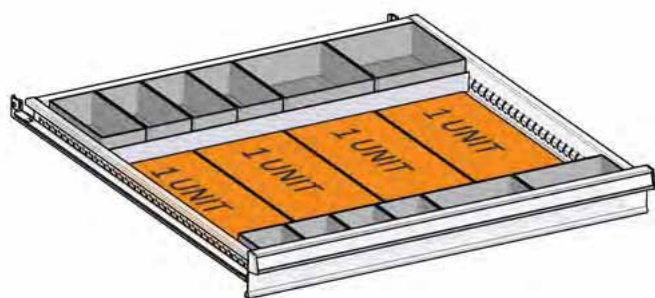

ART. F FH 2007 50 07

Set di predisposizione cassetto per termoformati Beta composto da:

- n. 4 F HC 6071 00 07
- n. 6 F HC 6471 00 07
- n. 2 F HC 6871 00 07
- n. 1 F HA 1140 00 99
- n. 1 F HA 2140 00 99

1 unit = 1 termoformato Beta 367x147 mm

2 unit = 1 termoformato Beta 367x294 mm

4 unit = 1 termoformato Beta 367x588 mm

ESEMPI DI UTILIZZO TERMOFORMATO

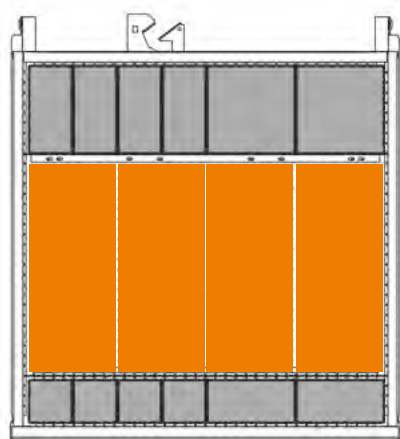

1 unit 1 unit 1 unit

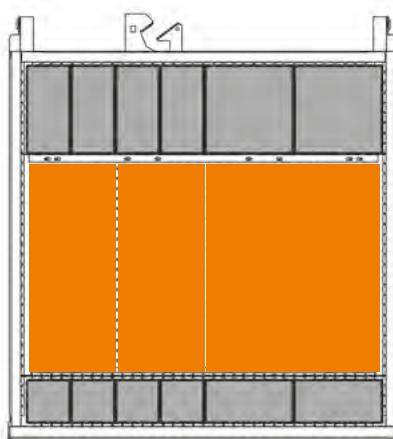

1 unit 1 unit 2 unit

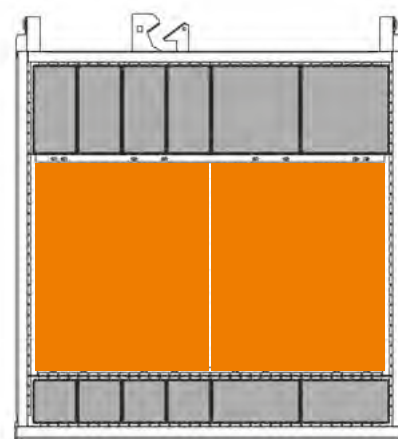

2 unit 2 unit

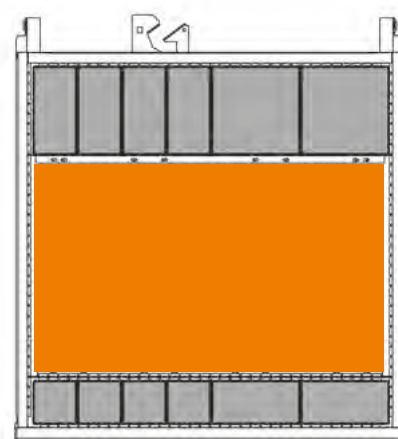

4 unit

LA RIVOLUZIONE DEL CASSETTO AD ESTRAZIONE TOTALE

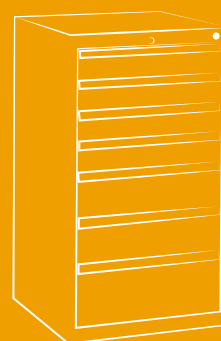



FLEXA

CARATTERISTICHE TECNICHE



1



I cassetti e i piani estraibili sono forniti di serie con estrazione totale (pari al 100%) su cuscinetti a sfera ad alta resistenza. Il fondo forato e le pareti fessurate con passo 17 mm permettono un facile inserimento e fissaggio (tramite viti) dei divisori in metallo.

2

Le porte sono già predisposte per essere montate sia con apertura a destra che a sinistra. Gli armadi vengono forniti con serratura a cilindro completa di due chiavi. Quando l'armadio è provvisto della porta, sia la serratura dell'armadio che quella della porta vengono fornite con chiavi uguali. In questo modo si può utilizzare una sola chiave per l'armadio.



3

SERRATURA A CILINDRO



La serratura a cilindro comanda l'apertura e la chiusura dell'asta antiribaltamento o della porta.

4

Agli armadi serie FLEXA può essere applicato un top superiore, composto da un piano in MDF accoppiato a una copertura in acciaio rivestita in gomma antiolio. Forniti con le stesse dimensioni dell'armadio, i top possono essere uniti facilmente tra di loro creando una superficie continua (vedi esempio).

APPLICAZIONE PIANO IN MDF

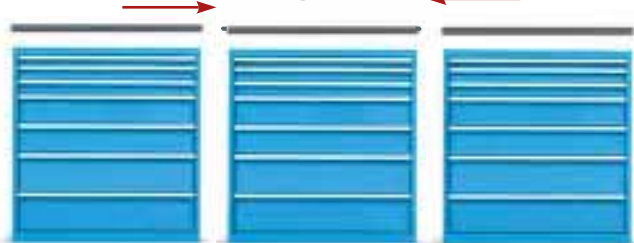

Agli armadi possono essere applicati una vasta gamma di impianti elettrici e pneumatici completi di arrotolatori elettrici, prese di vario tipo e voltaggio, magnetotermici differenziali, arrotolatori ed attacchi fissi per aria compressa. DISPONIBILI A RICHIESTA.

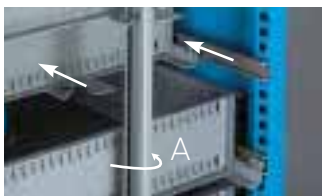

L'asta di chiusura funge anche da sistema antiribaltamento nel momento in cui il cassetto viene estratto. Infatti il gancio posteriore del cassetto fa ruotare in posizione di chiusura l'asta (A). In questo modo è impedita all'operatore l'estrazione simultanea di più cassetti, evitando un pericoloso spostamento del peso verso l'esterno.



A

B

Agli armadi serie FLEXA possono essere montate due tipi di maniglie.

La coppia maniglie viene applicata al piano 4 bordi, sia frontalmente che lateralmente, e può anche essere rivolta verso il basso diminuendo l'altezza del carrello di 38 mm (A). La maniglia singola viene applicata sul fianco dell'armadio. Questa soluzione, permette di applicare altri tipi di coperture sull'armadio, quali ad esempio piani in multiplex (B). DISPONIBILE SU RICHIESTA.





● **ART. F DB 1090 52 04**
H = 1000 mm - 7 cassetti

 Gamma colori ACCIAIO



ESTRAZIONE TOTALE 100% = 70 kg



CHIUSURA CON CHIAVE (KEY)
Forniti di serie con chiusura a cilindro e 2 chiavi

LEGENDA



PORTATA CASSETTO/
PIANO



ESTRAZIONE CASSETTO/
PIANO



CHIUSURA ARMADIO



LE PORTATE SONO NETTE E SI RIFERISCONO A PESI UNIFORMEMENTE DISTRIBUITI.

H 400 mm

2 cassetti
100
200



CHIUSURA LATERALE

ART.				
F DC 1030 51 04		70	100%	key

H 600 mm

4 cassetti
75
75
150
200



ART.				
F DB 1050 52 04		70	100%	key

H 700 mm

4 cassetti
75
100
125
300



ART.				
F DB 1060 51 04		70	100%	key

H 1000 mm

7 cassetti



ART.				
F DB 1090 52 04	70	100%	key	

H 1000 mm

3 cassetti

50*
100
150



porta 575 mm *portata massima 50 kg

ART.				
F DC 1090 56 04	70	100%	key	

CHIUSURA LATERALE

ART. F DB B560 02 EF

Dim. mm 564x675x920 H
Colore grigio RAL 7000 + grigio RAL 7035
ESCLUSO MATERIALE DI SEPARAZIONE



ART. F DB 1070 58 56

Dim. mm 564x600x930 H
Colore grigio RAL 7000 + grigio RAL 7035

H 820 mm



ART.				
F DB B550 02 04	70	100%	key	

Portata armadio 235 kg - Altezza armadio senza ruote mm 660

H 920 mm



ART.				
F DB B560 02 04	70	100%	key	

Portata armadio 235 kg - Altezza armadio senza ruote mm 760

H 1020 mm



*portata massima 50 kg

ART.				
F DB B570 01 04	70	100%	key	

Portata armadio 235 kg - Altezza armadio senza ruote mm 860

H 1220 mm



ART.				
F DB B590 01 04	70	100%	key	

Portata armadio 235 kg - Altezza armadio senza ruote mm 1060



2 ruote girevoli con freno in gomma standard Ø 125 mm
2 ruote fisse in gomma standard Ø 125 mm

CONFIGURA IL TUO ARMADIO

ARMADIO VUOTO



ART.	dim. mm	H utile mm	kg
F DC 1020 00 04	564x600x300 H	200	300
F DC 1030 00 04	564x600x400 H	300	400
Provisti di serratura e asta laterale			
F DB 1050 00 04	564x600x600 H	500	900
F DB 1060 00 04	564x600x700 H	600	900
F DB 1090 00 04	564x600x1000 H	900	900

Provisti di serratura centrale e asta antiribaltamento

ARMADIO VUOTO PREDISPOSTO PER RUOTE



ART.	dim. mm	H utile mm
F DB 0550 00 04	564x675x660 H	500
F DB 0560 00 04	564x675x760 H	600
F DB 0570 00 04	564x675x860 H	700
F DB 0575 00 04	564x675x910 H	750
F DB 0590 00 04	564x675x1060 H	900

Armadio predisposto per ruote completo di: piastra porta ruote, piano a 4 bordi con copertura in PVC, coppia maniglie in acciaio rivestite in gomma antiurto, serratura a cilindro con 2 chiavi, asta antiribaltamento.



Le maniglie possono essere montate verso il basso riducendo l'altezza totale di 38 mm.

CASSETTI



ART.	dim. utili mm	H frontale mm	kg
F DB 8050 00 04	447x447x36 H	50	50
F DB 8075 00 04	447x447x61 H	75	70
F DB 8100 00 04	447x447x86 H	100	70
F DB 8125 00 04	447x447x111 H	125	70
F DB 8150 00 04	447x447x136 H	150	70
F DB 8200 00 04	447x447x186 H	200	70

Estrazione totale 100%



É obbligatorio applicare a tutti i cassette inseriti negli armadi con ruote il dispositivo di apertura singola dei cassette ART. F DD 9400 00 07



PIANO ESTRAIBILE

ART.		dim. utili mm	H laterale mm	kg
F DB 8000 00 04		435x475	-	70

Estrazione totale 100%



PIANO REGOLABILE

ART.		dim. utili mm	H laterale mm	kg
F DB 9100 01 04		505x460	55	70

Senza estrazione



PORTA REVERSIBILE ALTEZZA PARZIALE

ART.		altezza (A) mm
F DB 9640 02 04		400+25
F DB 9642 02 04		425+25
F DB 9645 02 04		500+25
F DB 9649 02 04		575+25
F DB 9650 02 04		600+25

La porta può essere montata con apertura a sinistra o a destra



Non è possibile inserire i cassetti dietro alle porte

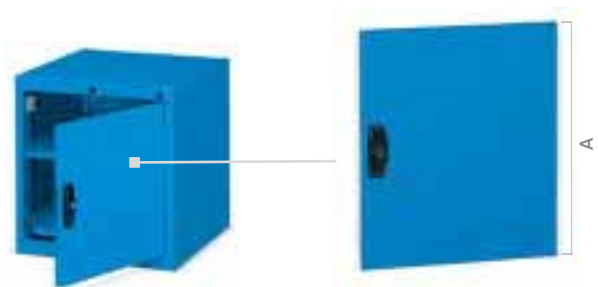

PORTA REVERSIBILE ALTEZZA TOTALE

ART.		altezza (A) mm
F DB 9645 01 04		500
F DB 9650 01 04		600

La porta può essere montata con apertura a sinistra o a destra



FERMO

ART. F DA 9698 00 99

Da ordinare solo con porta altezza totale

COPPIA ZOCCOLI

ART.	H mm
F RR 1608 00 07	130

Colore nero RAL 9005



Applicazione
COPPIA ZOCCOLI



PIANO SUPERIORE A 3 BORDI

ART.	dim. mm	
F DB 9150 01 07	564x600x20 H	

Piano rivestito in pvc. Colore nero



RIFINITURA
GOMMA
ANTIOLIO



PIANI SUPERIORI IN MDF DIM. 565x600x31,5 mm H

ART.	rifiniture	per armadio	
F UZ 3120 11 07	1 profilo laterale	finale dx o sx	
F UZ 3120 12 07	-	centrale	
F UZ 3120 13 07	2 profili laterali	singolo	

Piano in MDF con copertura in gomma antiolio. Colore nero



APPLICAZIONE
PIANO IN MDF



RUOTA FISSA IN GOMMA STANDARD

ART.	Ø mm	portata armadio kg	C mm
C RG BAC11 100	100	160	128
C RG BAC12 125	125	235	155
C RG BAC13 150	150	280	180



RUOTA GIREVOLE CON FRENO IN GOMMA STANDARD

ART.	Ø mm	portata armadio kg	C mm
C RG DAC11 100	100	160	128
C RG DAC12 125	125	235	155
C RG DAC13 150	150	280	180



RUOTA FISSA IN NYLON

ART.	Ø mm	portata armadio kg	C mm
C RN BAD10 100	100	310	128
C RN BAD11 125	125	400	155



RUOTA GIREVOLE CON FRENO IN NYLON

ART.	Ø mm	portata armadio kg	C mm
C RN DAD10 100	100	310	128
C RN DAD11 125	125	400	155



ALTRE RUOTE
SU RICHIESTA

FISSAGGIO

SET FISSAGGIO TRA ARMADI

ART. F AG 9202 00 99

Set di fissaggio armadio-armadio con 4 viti complete di dadi M8; foratura e viteria per il fissaggio dei due armadi sovrapposti.

SET DI FISSAGGIO A PAVIMENTO

ART. F AG 9204 00 99

2 tasselli "HILTI" adatti per pavimenti in calcestruzzo non fessurato maggiore o uguale alla classe C20/25
Trazione consigliata del tassello: 2,9 kN
Diametro tassello: Ø 6 mm



GLI ARMADI DEVONO ESSERE FISSATI A PAVIMENTO O A PARETE. SE SOVRAPPOSTI, DEVONO ESSERE FISSATI ESCLUSIVAMENTE A PARETE E LA LORO PORTATA DIVISA PER DUE.

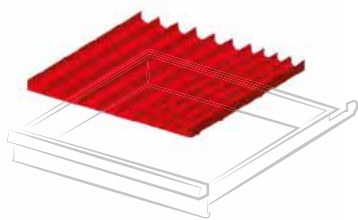

ART. per altezza frontale mm

F FH 8405 02 00 50 - 300

Set composto da: 3 divisori 4 canali, 6 divisori 3 canali, 16 divisori trasversali 36 mm, 7 divisori trasversali 47 mm

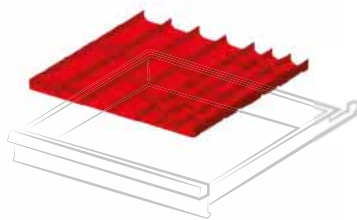

ART. per altezza frontale mm

F FH 8405 03 00 50 - 300

Set composto da: 3 divisori 3 canali, 6 divisori 2 canali, 15 divisori trasversali 47 mm, 8 divisori trasversali 73 mm

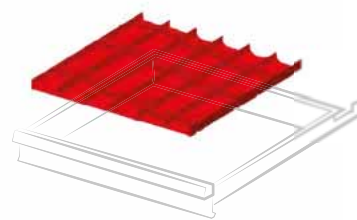

ART. per altezza frontale mm

F FH 8405 04 00 50 - 300

Set composto da: 9 divisori 2 canali, 18 divisori trasversali 73 mm

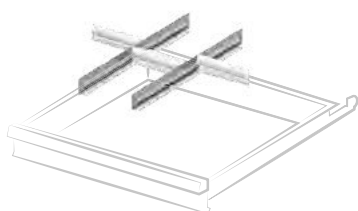

ART. per altezza frontale mm

F FH 8405 08 00 50

F FH 8407 08 00 75

F FH 8410 08 00 100 - 125

F FH 8415 08 00 150

F FH 8420 08 00 200 - 250

F FH 8430 08 00 300

Set composto da: 2 divisori longitudinali fessurati 455 mm, 3 divisori trasversali 149 mm

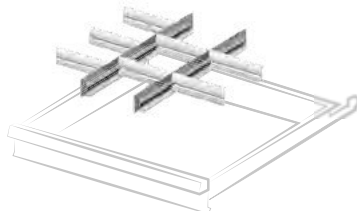

ART. per altezza frontale mm

F FH 8405 09 00 50

F FH 8407 09 00 75

F FH 8410 09 00 100 - 125

F FH 8415 09 00 150

F FH 8420 09 00 200 - 250

Set composto da: 2 divisori longitudinali fessurati 455 mm, 7 divisori trasversali 149 mm

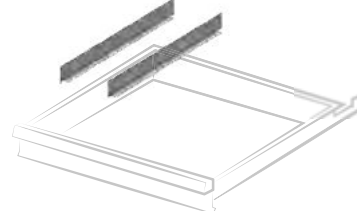

ART. per altezza frontale mm

F FH 8405 13 00 50

F FH 8407 13 00 75

F FH 8410 13 00 100 - 125

F FH 8415 13 00 150

F FH 8420 13 00 200 - 250

Set composto da: 2 divisori longitudinali non fessurati 455 mm

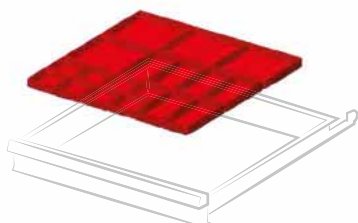

ART. per altezza frontale mm

F FH 8405 17 00 50

F FH 8407 17 00 75

Set composto da: 8 cassette divisorio 75x75 mm, 6 cassette divisorio 150x75 mm, 4 cassette divisorio 150x150 mm

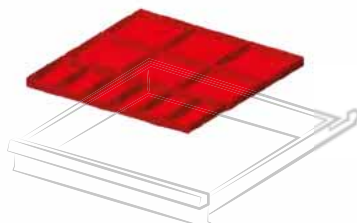

ART. per altezza frontale mm

F FH 8405 18 00 50

F FH 8407 18 00 75

F FH 8410 18 00 100 - 125

Set composto da: 6 cassette divisorio 150x75 mm, 6 cassette divisorio 150x150 mm

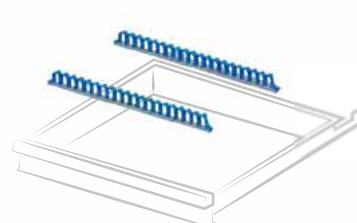

ART. per altezza frontale mm

F FH 8605 19 00 50 - 300

Set composto da: 2 supporti multiuso 440 mm

CONFIGURA IL CASSETTO FAMI CON UTENSILI BETA

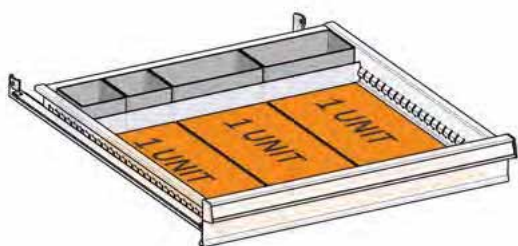

ART. F FH 0807 50 07

Set di predisposizione cassetto per termoformati Beta composto da:

n. 2 F HC 6071 00 07

n. 2 F HC 6471 00 07

n. 1 F HA 1121 00 99

1 unit = 1 termoformato Beta 367x147 mm

2 unit = 1 termoformato Beta 367x294 mm

ESEMPI DI UTILIZZO TERMOFORMATO

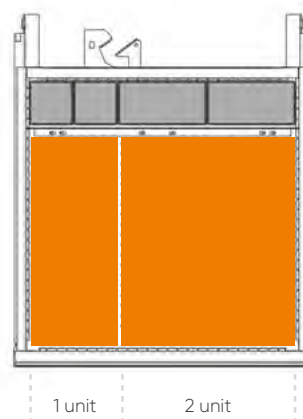
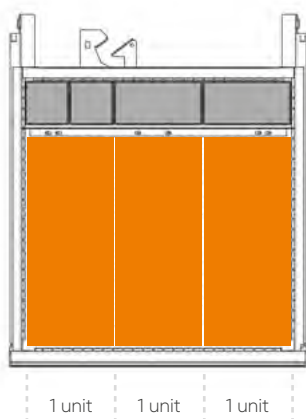



● **ART. F DF 1075 53 04**
H = 850 mm - 6 cassetti

 Gamma colori ACCIAIO



ESTRAZIONE TOTALE 100% = 70 kg



CHIUSURA CON CHIAVE (KEY)
Forniti di serie con chiusura a cilindro e 2 chiavi

LEGENDA



PORTATA CASSETTO/
PIANO



ESTRAZIONE CASSETTO/
PIANO



CHIUSURA ARMADIO



LE PORTATE SONO NETTE E SI RIFERISCONO A PESI UNIFORMEMENTE DISTRIBUITI.

H 400 mm



CHIUSURA LATERALE

ART.				
F DG 1030 52 04	70	100%	key	

H 600 mm



ART.				
F DF 1050 52 04	70	100%	key	

H 700 mm



ART.				
F DF 1060 51 04	70	100%	key	

H 700 mm



porta 600 mm h

ART.				
F DF 1060 57 04	70	100%	key	

H 1000 mm



ART.				
F DF 1090 52 04		70	100%	key

H 1000 mm



ART.				
F DF 1090 54 04		70	100%	key

H 820 mm



H 920 mm



ART.				
F DF B550 02 04	70	100%	key	

Portata armadio 225 kg - Altezza corpo armadio 660 mm

ART.				
F DF B560 02 04	70	100%	key	

Portata armadio 225 kg - Altezza corpo armadio 760 mm

H 1020 mm



H 1020 mm



ART.				
F DF B570 02 04	70	100%	key	

Portata armadio 225 kg - Altezza corpo armadio 860 mm

ART.				
F DF B570 04 04	70	100%	key	

Portata armadio 225 kg - Altezza corpo armadio 860 mm

1 porta basculante 300 mm



2 ruote girevoli con freno in gomma standard Ø 125 mm
2 ruote fisse in gomma standard Ø 125 mm

CONFIGURA IL TUO ARMADIO

ARMADIO VUOTO



ART.		dim. mm	H utile mm	kg
F DG 1030 00 04		717x600x400 H	300	400
Provvisti di serratura e asta laterale				
F DF 1050 00 04		717x600x600 H	500	900
F DF 1060 00 04		717x600x700 H	600	900
F DF 1090 00 04		717x600x1000 H	900	900

Provvisti di serratura centrale e asta antiribaltamento

ARMADIO VUOTO PREDISPOSTO PER RUOTE



ART.		dim. mm	H utile mm
F DF 0550 00 04		792x600x660 H	500
F DF 0560 00 04		792x600x760 H	600
F DF 0570 00 04		792x600x860 H	700

Armadio predisposto per ruote completo di: piastra porta ruote, piano a 4 bordi con gomma antiolio, coppia maniglie in acciaio rivestite in gomma antiurto, serratura a cilindro con 2 chiavi, asta antiribaltamento.



Le maniglie possono essere montate verso il basso riducendo l'altezza totale di 38 mm.

CASSETTI



ART.		dim. utili mm	H frontale mm	kg
F DF 8075 00 04		600x447x61 H	75	70
F DF 8100 00 04		600x447x86 H	100	70
F DF 8125 00 04		600x447x111 H	125	70
F DF 8150 00 04		600x447x136 H	150	70
F DF 8175 00 04		600x447x161 H	175	70
F DF 8200 00 04		600x447x186 H	200	70
F DF 8300 00 04		600x447x286 H	300	70

Estrazione totale 100%



É obbligatorio applicare a tutti i cassetti inseriti negli armadi con ruote il dispositivo di apertura singola dei cassetti ART. F DD 9400 00 07



PIANO ESTRAIBILE

ART.		dim. utili mm	H laterale mm	kg
F DF 8000 00 04		587x475	-	70

Estrazione totale 100%



PIANO REGOLABILE

ART.		dim. utili mm	H laterale mm	kg
F DF 9100 01 04		655x460	55	70

Senza estrazione



PORTA REVERSIBILE ALTEZZA PARZIALE

ART.		altezza (A) mm
F DF 9640 02 04		400+25
F DB 9645 02 04		500+25
F DB 9650 02 04		600+25

La porta può essere montata con apertura a sinistra o a destra



Non è possibile inserire i cassetti dietro alle porte

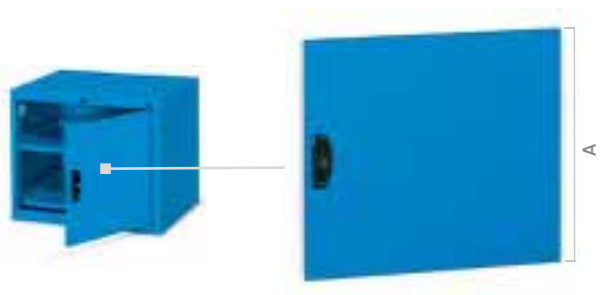

PORTA REVERSIBILE ALTEZZA TOTALE

ART.		altezza (A) mm
F DF 9645 01 04		500
F DF 9650 01 04		600

La porta può essere montata con apertura a sinistra o a destra



FERMO

ART. F DA 9698 00 99

Da ordinare solo con porta altezza totale

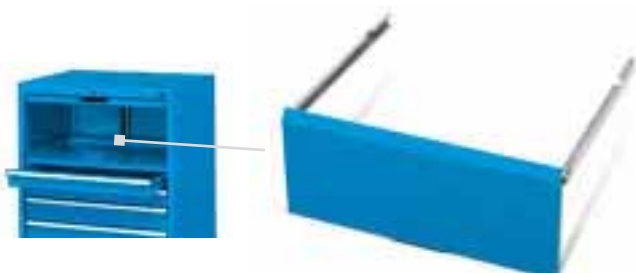

PORTA BASCULANTE

ART.		H mm
F DF 9615 00 04		300

Porta basculante completa di coppia guide



Con la porta basculante è necessario l'uso del piano regolabile ART. F DF 9100 01 04



PIANO SUPERIORE A 4 BORDI

ART.	dim. mm	
F DF 9940 01 07	717x600x22 H	

Piano rivestito in PVC. Colore nero



**RIFINITURA
GOMMA
ANTIOLIO**



PIANI SUPERIORI IN MDF DIM. 718x600x31,5 mm H

ART.	rifiniture	per armadio	
F UZ 3130 11 07	1 profilo laterale	finale dx o sx	
F UZ 3130 12 07	-	centrale	
F UZ 3130 13 07	2 profili laterali	singolo	

Piano in MDF con copertura in gomma antiolio. Colore nero



**APPLICAZIONE
PIANO IN MDF**



PANNELLO FORATO

ART.		dim. mm	
M 30 PA71 00 00 00 04		708x65x718 H	



ESEMPI DI PANNELLO FORATO CON GANCI/VISUAL BOX



2 ART. FAXVBCH00600001
1 ART. F BL 9541 00 00 (10 pz.)
1 ART. C MV 10 019



2 ART. FAXVBCH00900001
2 ART. FAXVBCH00600001
2 ART. FAXVBCH00500001



2 ART. FAXVBCH00600001
3 ART. FAXVBCH00500001



3 ART. FAXVBCH00600001
1 ART. FAXVBCH00500001
1 ART. FAXVBCH00400001



ART. M 00 PA71 00 00 FO 00
FORATURA PIANO SUPERIORE IN MDF O
MULTIPLY PER IL FISSAGGIO DEL PANNELLO
FORATO - COMPRESIVO DI VITI



ART. M 00 PA71 00 00 F1 00
FORATURA PIANO SUPERIORE A 3/4
BORDI PER IL FISSAGGIO DEL PANNELLO
FORATO - COMPRESIVO DI VITI



ART. M 00 PA71 00 00 F2 00
SET DI PREDISPOSIZIONE PER IL FIS-
SAGGIO DEI VISUAL BOX AL PANNELLO
FORATO

RUOTA FISSA IN GOMMA STANDARD

ART.	Ø mm	portata armadio kg	C mm
C RG BAC11 100	100	150	128
C RG BAC12 125	125	225	155
C RG BAC13 150	150	270	180



RUOTA GIREVOLE CON FRENO IN GOMMA STANDARD

ART.	Ø mm	portata armadio kg	C mm
C RG DAC11 100	100	150	128
C RG DAC12 125	125	225	155
C RG DAC13 150	150	270	180



RUOTA FISSA IN NYLON

ART.	Ø mm	portata armadio kg	C mm
C RN BAD10 100	100	270	128
C RN BAD11 125	125	270	155



RUOTA GIREVOLE CON FRENO IN NYLON

ART.	Ø mm	portata armadio kg	C mm
C RN DAD10 100	100	270	128
C RN DAD11 125	125	270	155



ALTRE RUOTE
SU RICHIESTA

COPPIA ZOCCOLI

ART.	H mm
F RR 1608 00 07	130

Colore nero RAL 9005



Applicazione
COPPIA ZOCCOLI

FISSAGGIO

SET FISSAGGIO TRA ARMADI

ART. F AG 9202 00 99

Set di fissaggio armadio-armadio con 4 viti complete di dadi M8; foratura e viteria per il fissaggio dei due armadi sovrapposti.

SET DI FISSAGGIO A PAVIMENTO

ART. F AG 9204 00 99

2 tasselli "HILTI" adatti per pavimenti in calcestruzzo non fessurato maggiore o uguale alla classe C20/25
Trazione consigliata del tassello: 2.9 kN
Diametro tassello: Ø 6 mm



GLI ARMADI DEVONO ESSERE FISSATI A PAVIMENTO O A PARETE. SE SOVRAPPOSTI, DEVONO ESSERE FISSATI ESCLUSIVAMENTE A PARETE E LA LORO PORTATA DIVISA PER DUE.





ART. F DF B570 S1 FN

Dim. mm 794x600x982 H
Colore rosso RAL 3020 + nero RAL 9005
ESCLUSO CONTENITORE, UTENSILI E
MATERIALE DI SEPARAZIONE

36x27 EH

MATERIALE DI SEPARAZIONE

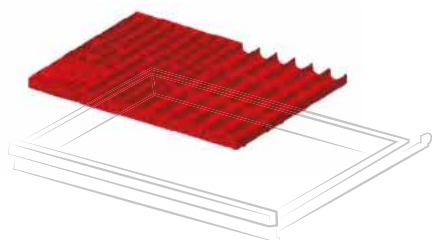

ART. per altezza frontale mm

F FH 1005 15 00 50 - 300

Set composto da: 5 divisori 4 canali, 6 divisori 3 canali, 20 divisori trasversali 36 mm, 20 divisori trasversali 47 mm, 1 porta chiavi a brugola

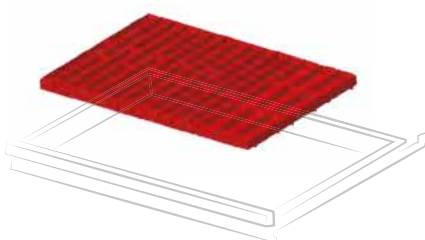

ART. per altezza frontale mm

F FH 1005 10 00 50 - 300

Set composto da: 9 divisori 4 canali, 3 divisori 3 canali, 36 divisori trasversali 36 mm, 12 divisori trasversali 47 mm

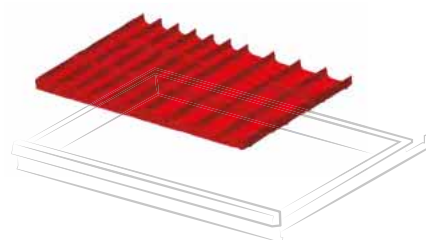

ART. per altezza frontale mm

F FH 1005 13 00 50 - 300

Set composto da: 6 divisori 3 canali, 6 divisori 2 canali, 18 divisori trasversali 47 mm, 12 divisori trasversali 73 mm

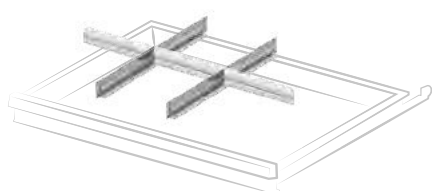

ART. per altezza frontale mm

F FH 1005 05 00 50

F FH 1007 05 00 75

F FH 1010 05 00 100 - 125

F FH 1015 05 00 150

F FH 1020 05 00 200 - 250

F FH 1030 05 00 300

Set composto da: 2 divisori longitudinali fessurati 455 mm, 3 divisori trasversali 200 mm

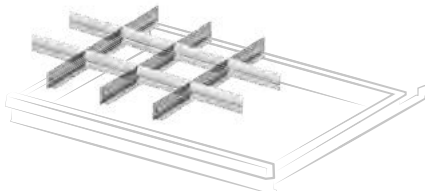

ART. per altezza frontale mm

F FH 1005 03 00 50

F FH 1007 03 00 75

F FH 1010 03 00 100 - 125

F FH 1015 03 00 150

F FH 1020 03 00 200 - 250

Set composto da: 3 divisori longitudinali fessurati 455 mm, 8 divisori trasversali 149 mm

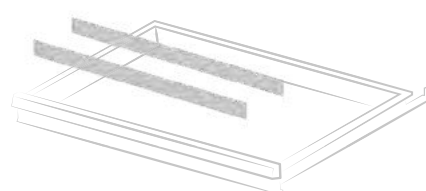

ART. per altezza frontale mm

F FH 1005 01 00 50

F FH 1007 01 00 75

F FH 1010 01 00 100 - 125

F FH 1015 01 00 150

F FH 1020 01 00 200 - 250

F FH 1030 01 00 300

Set composto da: 2 divisori longitudinali non fessurati 610 mm

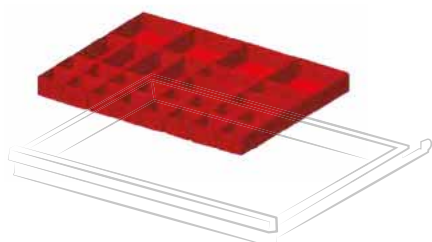

ART. per altezza frontale mm

F FH 1005 18 00 50

F FH 1007 18 00 75

Set composto da: 16 cassette divisorio 75x75 mm, 8 cassette divisorio 150x75 mm, 4 cassette divisorio 150x150 mm

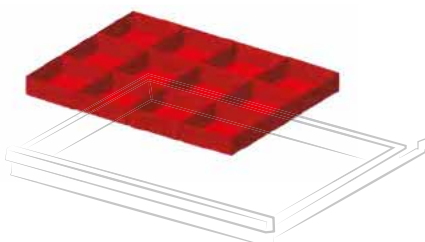

ART. per altezza frontale mm

F FH 1005 09 00 50

F FH 1007 09 00 75

F FH 1010 09 00 100 - 125

Set composto da: 12 cassette divisorio 150x150 mm

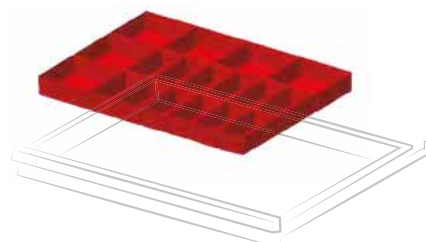

ART. per altezza frontale mm

F FH 1005 16 00 50

F FH 1007 16 00 75

F FH 1010 16 00 100 - 125

Set composto da: 12 cassette divisorio 150x75 mm, 6 cassette divisorio 150x150 mm

CONFIGURA IL CASSETTO FAMI CON UTENSILI BETA

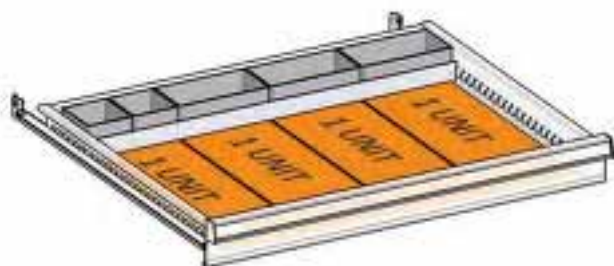

ART. F FH 1007 50 07

Set di predisposizione cassetto per termoformati Beta composto da:

n. 2 F HC 6071 00 07

n. 3 F HC 6471 00 07

n. 1 F HA 1141 00 99

1 unit = 1 termoformato Beta 367x147 mm

2 unit = 1 termoformato Beta 367x294 mm

ESEMPI DI UTILIZZO TERMOFORMATO

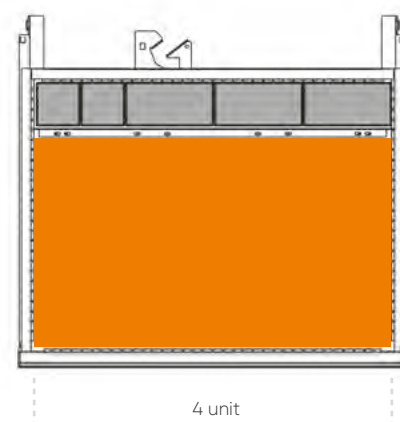
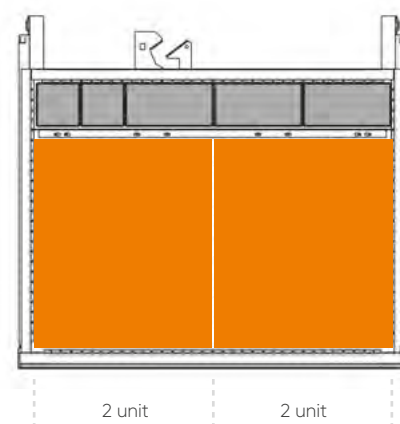
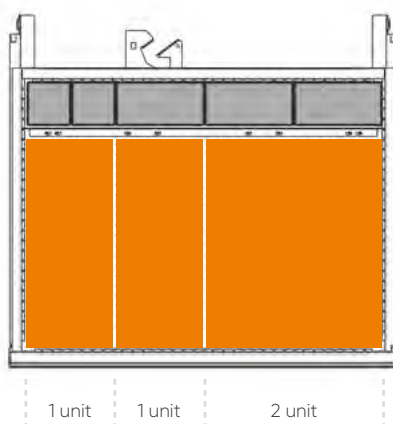
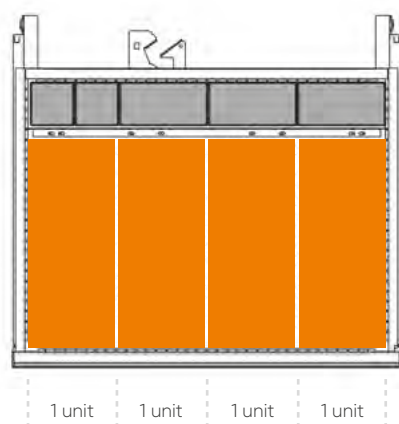



● **ART. F DL 1090 54 04**
H = 1000 mm - 7 cassetti

 Gamma colori ACCIAIO



GRIGIO
RAL 7000
.01



VERDE
RAL 6011
.02



BLU
RAL 5012
.04



GRIGIO
RAL 7035
.08



ESTRAZIONE TOTALE 100% = 50 kg



CHIUSURA CON CHIAVE (KEY)
Forniti di serie con chiusura
a cilindro e 2 chiavi

LEGENDA



PORTATA
CASSETTO/
PIANO



ESTRAZIONE
CASSETTO/
PIANO



CHIUSURA
ARMADIO



LE PORTATE SONO NETTE E SI RIFERISCONO A PESI UNIFORMEMENTE DISTRIBUITI.

H 1000 mm



7 cassetti

ART.				
F DL 1090 54 04		50	100%	key

H 1000 mm



8 cassetti

ART.				
F DL 1090 55 04		50	100%	key

CONFIGURA IL TUO ARMADIO



ARMADIO VUOTO

ART.		dim. mm	H utile mm	kg
F DL 1090 00 04		1023x600x1000 H	900	900

CASSETTI



ART.		dim. utili mm	H frontale mm	kg
F DL 8075 00 04		906x447x61 H	75	50
F DL 8100 00 04		906x447x86 H	100	50
F DL 8150 00 04		906x447x136 H	150	50
F DL 8175 00 04		906x447x161 H	175	50
F DL 8200 00 04		906x447x186 H	200	50

Estrazione totale 100%



PIANO REGOLABILE

ART.		dim. utili mm	H laterale mm	kg
F DL 9100 01 04		960x460	55	70

Senza estrazione





PIANO SUPERIORE A 3 BORDI

ART.	dim. mm	
F DL 9150 01 07	1023x600x20 H	

Piano rivestito in PVC. Colore nero



**RIFINITURA
GOMMA
ANTIOLIO**



PIANO SUPERIORE IN MDF DIM. 1024x600x31,5 mm H

ART.	rifiniture	per armadio	
F UZ 3140 11 07	1 profilo laterale	finale dx o sx	
F UZ 3140 12 07	-	centrale	
F UZ 3140 13 07	2 profili laterali	singolo	

Piano in MDF con copertura in gomma antiolio. Colore nero



**APPLICAZIONE
PIANO IN MDF**

COPPIA ZOCCOLI

ART.	H mm	
F RR 1608 00 07	130	

Colore nero RAL 9005



Applicazione
COPPIA ZOCCOLI

FISSAGGIO

SET FISSAGGIO TRA ARMADI

ART. F AG 9202 00 99

Set di fissaggio armadio-armadio con 4 viti complete di dadi M8; foratura e viteria per il fissaggio dei due armadi sovrapposti.

SET DI FISSAGGIO A PAVIMENTO

ART. F AG 9204 00 99

2 tasselli "HILTI" adatti per pavimenti in calcestruzzo non fessurato maggiore o uguale alla classe C20/25
Trazione consigliata del tassello: 2.9 kN
Diametro tassello: Ø 6 mm



GLI ARMADI DEVONO ESSERE FISSATI A PAVIMENTO O A PARETE. SE SOVRAPPOSTI, DEVONO ESSERE FISSATI ESCLUSIVAMENTE A PARETE E LA LORO PORTATA DIVISA PER DUE.





54x27 EH

MATERIALE DI SEPARAZIONE

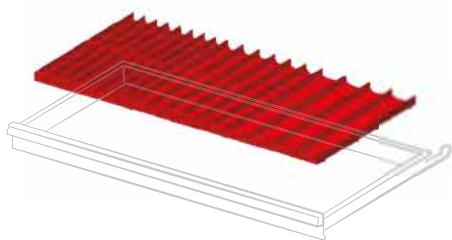

ART. per altezza frontale mm

F FH 4005 12 00 50 - 300

Set composto da: 6 divisori 4 canali, 6 divisori 3 canali, 6 divisori 2 canali, 15 divisori trasversali 36 mm, 10 divisori trasversali 47 mm, 6 divisori trasversali 73 mm

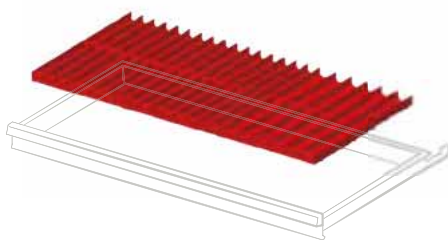

ART. per altezza frontale mm

F FH 4005 15 00 50 - 300

Set composto da: 12 divisori 4 canali, 6 divisori 3 canali, 30 divisori trasversali 36 mm, 10 divisori trasversali 47 mm

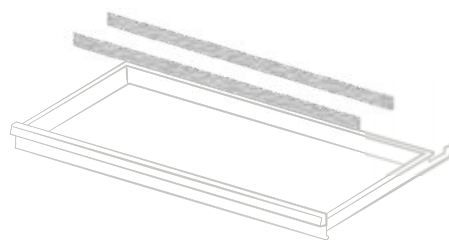

ART. per altezza frontale mm

F FH 4005 01 00 50

F FH 4007 01 00 75

F FH 4010 01 00 100 - 125

F FH 4015 01 00 150 - 175

F FH 4020 01 00 200 - 250

F FH 4030 01 00 300

Set composto da: 2 divisori longitudinali non fessurati 914 mm

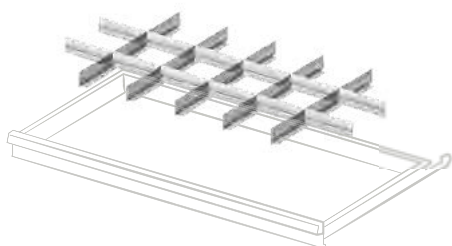

ART. per altezza frontale mm

F FH 4005 03 00 50

F FH 4007 03 00 75

F FH 4010 03 00 100 - 125

F FH 4015 03 00 150 - 175

F FH 4020 03 00 200 - 250

Set composto da: 5 divisori longitudinali fessurati 455 mm, 12 divisori trasversali 149 mm

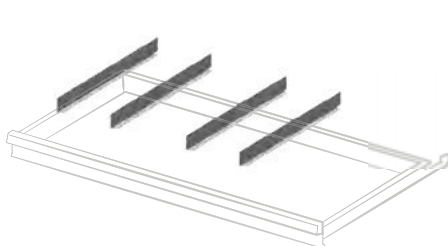

ART. per altezza frontale mm

F FH 4005 04 00 50

F FH 4007 04 00 75

F FH 4010 04 00 100 - 125

F FH 4015 04 00 150 - 175

F FH 4020 04 00 200 - 250

Set composto da: 4 divisori longitudinali non fessurati 455 mm

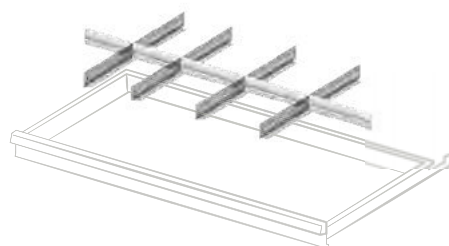

ART. per altezza frontale mm

F FH 4005 05 00 50

F FH 4007 05 00 75

F FH 4010 05 00 100 - 125

F FH 4015 05 00 150 - 175

F FH 4020 05 00 200 - 250

Set composto da: 4 divisori longitudinali fessurati 455 mm, 2 divisori trasversali 149 mm, 3 divisori trasversali 200 mm

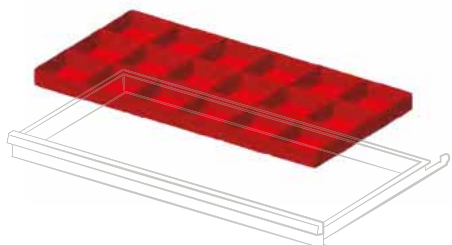

ART. per altezza frontale mm

F FH 4005 11 00 50

F FH 4007 11 00 75

F FH 4010 11 00 100 - 125

Set composto da: 18 cassette divisorio 150x150 mm

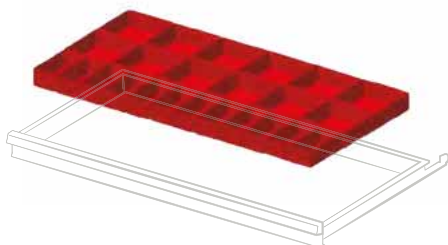

ART. per altezza frontale mm

F FH 4005 13 00 50

F FH 4007 13 00 75

F FH 4010 13 00 100 - 125

Set composto da: 12 cassette divisorio 150x75 mm, 12 cassette divisorio 150x150 mm

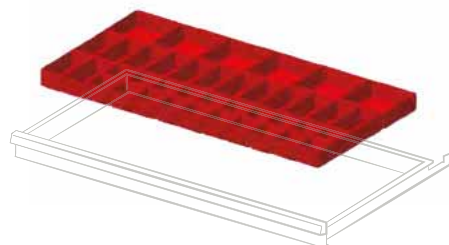

ART. per altezza frontale mm

F FH 4005 16 00 50

F FH 4007 16 00 75

Set composto da: 20 cassette divisorio 75x75 mm, 14 cassette divisorio 150x75 mm, 6 cassette divisorio 150x150 mm

CONFIGURA IL CASSETTO FAMI CON UTENSILI BETA

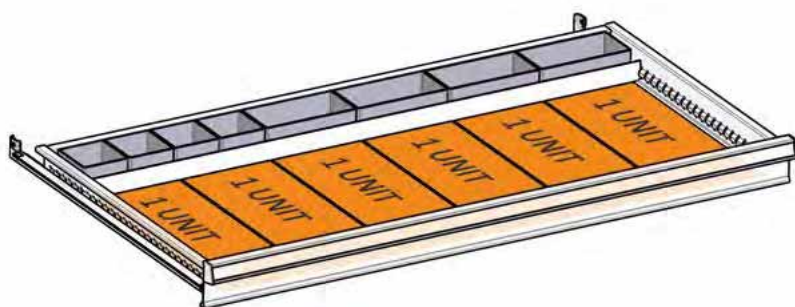

ART. F FH 4007 50 07

Set di predisposizione cassetto per termoformati Beta composto da:

n. 4 F HC 6071 00 07

n. 4 F HC 6471 00 07

n. 1 F HA 2150 00 99

1 unit = 1 termoformato Beta 367x147 mm

2 unit = 1 termoformato Beta 367x294 mm

4 unit = 1 termoformato Beta 367x588 mm

ESEMPI DI UTILIZZO TERMOFORMATO

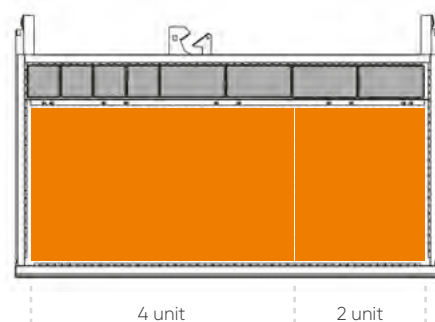
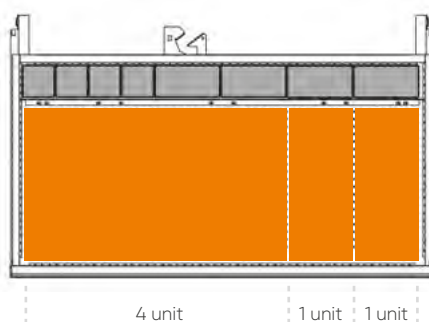
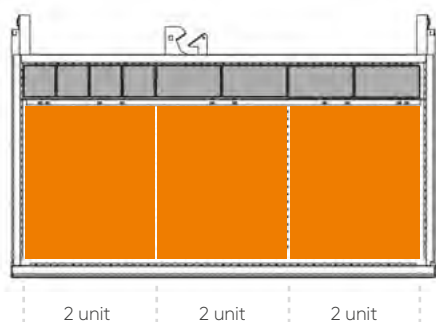
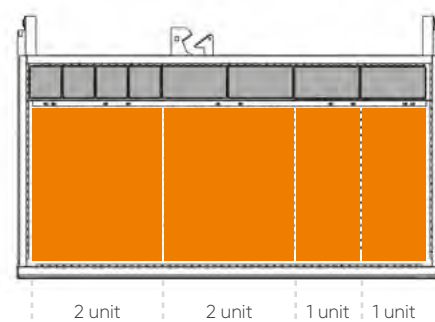
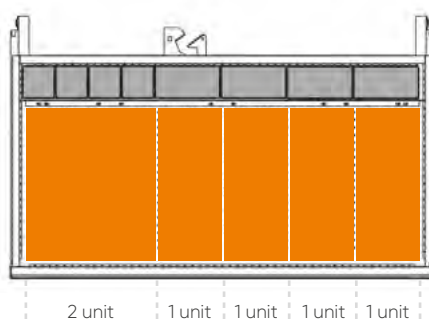
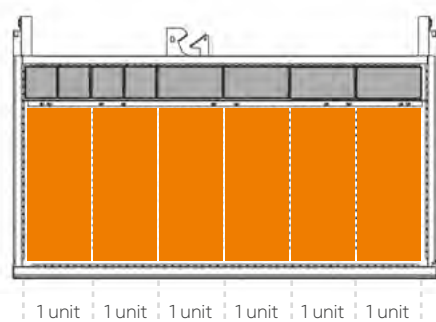

ANGOLI



VISTA POSTERIORE

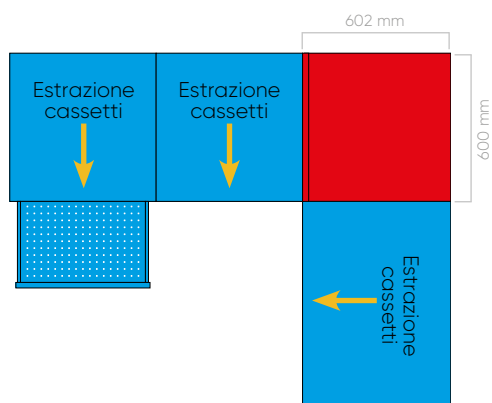

QUESTI ANGOLI POSSONO ESSERE ACCOPPIATI SOLAMENTE CON ARMADI PROFONDITÀ 600 mm (27 EH) SERIE FLEXA



ART.



F DB 1090 R1 04

ANGOLO ESTERNO DESTRO



ART.



F DB 1090 R2 04

ANGOLO ESTERNO DESTRO COMPLETO DI PIANO IN MDF - COPERTURA IN GOMMA ANTIOLIO

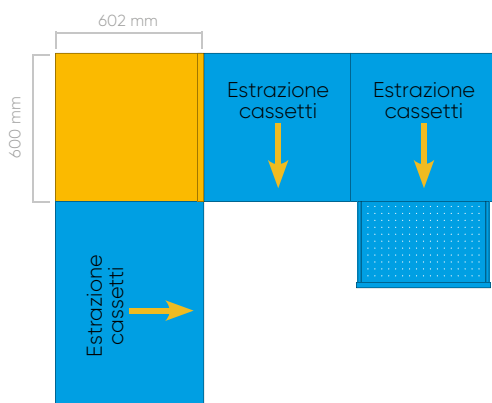

QUESTI ANGOLI POSSONO ESSERE ACCOPPIATI SOLAMENTE CON ARMADI PROFONDITÀ 600 mm (27 EH) SERIE FLEXA



ART.



F DB 1090 L1 04

ANGOLO ESTERNO SINISTRO



ART.



F DB 1090 L2 04

ANGOLO ESTERNO SINISTRO COMPLETO DI PIANO IN MDF - COPERTURA IN GOMMA ANTIOILIO

FLEXA

602x600 mm

ANGOLI

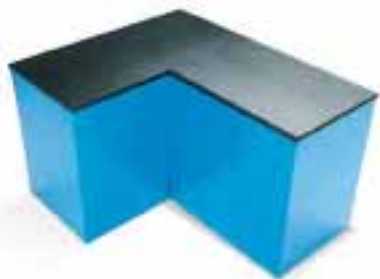

VISTA POSTERIORE

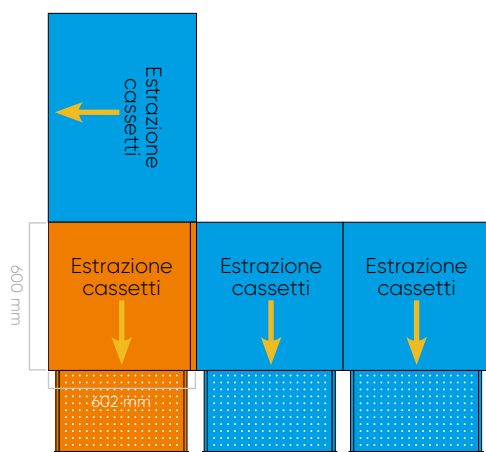

QUESTI ANGOLI POSSONO ESSERE ACCOPPIATI SOLAMENTE CON ARMADI PROFONDITÀ 600 mm (27 EH) SERIE FLEXA



ART.



F DB 1090 L3 04

ANGOLO INTERNO SINISTRO



ART.



F DB 1090 L4 04

ANGOLO INTERNO SINISTRO COMPLETO DI PIANO IN MDF - COPERTURA IN GOMMA ANTIOLIO

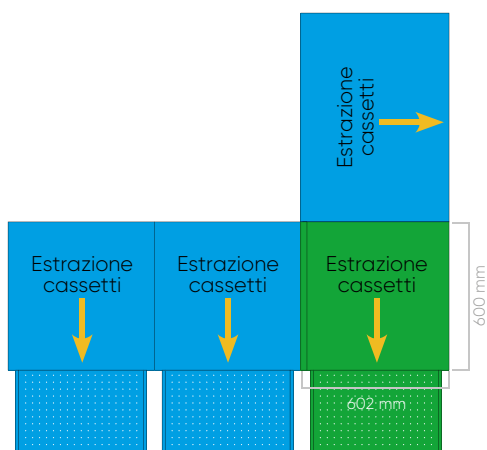

QUESTI ANGOLI POSSONO ESSERE ACCOPPIATI
SOLAMENTE CON ARMADI PROFONDITÀ 600 mm
(27 EH) SERIE FLEXA



ART.



F DB 1090 R3 04

ANGOLO INTERNO DESTRO



ART.



F DB 1090 R4 04

ANGOLO INTERNO DESTRO COMPLETO DI
PIANO IN MDF - COPERTURA IN GOMMA
ANTIOLIO

MATERIALE DI SEPARAZIONE



1 EH (17 mm)

corrisponde al passo delle fessurazioni e forature del cassetto

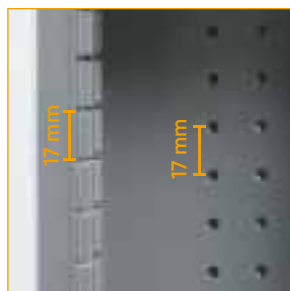

1 EH = 17 mm



DIVISORI LONGITUDINALI NON FESSURATI

Per altezze frontali	ART. lunghezza 24 EH (405 mm)	ART. lunghezza 27 EH (455 mm)	ART. lunghezza 30 EH (507 mm)
50	F HA 2110 00 99	F HA 2120 00 99	F HA 2130 00 99
75	F HA 2210 00 99	F HA 2220 00 99	F HA 2230 00 99
100-125	F HA 2310 00 99	F HA 2320 00 99	F HA 2330 00 99
150-175	F HA 2410 00 99	F HA 2420 00 99	F HA 2430 00 99
200-250	F HA 2510 00 99	F HA 2520 00 99	F HA 2530 00 99
300-400	-	-	-

ZINCATO

Per altezze frontali	ART. lunghezza 36 EH (610 mm)	ART. lunghezza 54 EH (914 mm)	ART. lunghezza 64 EH (1085 mm)	ART. lunghezza 78 EH (1323 mm)
50	F HA 2140 00 99	F HA 2150 00 99	-	-
75	F HA 2240 00 99	F HA 2250 00 99	F HA 2260 00 99	F HA 2270 00 99
100-125	F HA 2340 00 99	F HA 2350 00 99	F HA 2360 00 99	F HA 2370 00 99
150-175	F HA 2440 00 99	F HA 2450 00 99	F HA 2460 00 99	F HA 2470 00 99
200-250	F HA 2540 00 99	F HA 2550 00 99	F HA 2560 00 99	F HA 2570 00 99
300-400	F HA 2640 00 99	F HA 2650 00 99	F HA 2660 00 99	F HA 2670 00 99

ZINCATO

MATERIALE DI SEPARAZIONE



DIVISORI LONGITUDINALI FESSURATI

Per altezze frontali	ART. lunghezza 17 EH (286 mm)	ART. lunghezza 27 EH (455 mm)	ART. lunghezza 30 EH (507 mm)
50	F HA 1110 00 99	F HA 1120 00 99	F HA 1130 00 99
75	-	F HA 1220 00 99	F HA 1230 00 99
100-125	-	F HA 1320 00 99	F HA 1330 00 99
150-175	-	F HA 1420 00 99	F HA 1430 00 99
200-250	-	F HA 1520 00 99	-
300-400	-	F HA 1620 00 99	-

ZINCATO

Per altezze frontali	ART. lunghezza 36 EH (610 mm)	ART. lunghezza 54 EH (914 mm)	ART. lunghezza 64 EH (1085 mm)	ART. lunghezza 78 EH (1323 mm)
50	F HA 1140 00 99	F HA 1150 00 99	-	-
75	F HA 1240 00 99	F HA 1250 00 99	F HA 1260 00 99	F HA 1270 00 99
100-125	F HA 1340 00 99	F HA 1350 00 99	F HA 1360 00 99	F HA 1370 00 99
150-175	F HA 1440 00 99	F HA 1450 00 99	F HA 1460 00 99	F HA 1470 00 99
200-250	F HA 1540 00 99	F HA 1550 00 99	F HA 1560 00 99	F HA 1570 00 99
300-400	F HA 1640 00 99	F HA 1650 00 99	F HA 1660 00 99	F HA 1670 00 99

ZINCATO

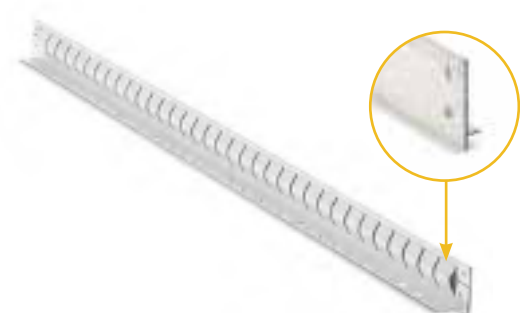

DIVISORI LONGITUDINALI FESSURATI SU UN LATO

Per altezze frontali	ART. lunghezza 27 EH (455 mm)	ART. lunghezza 36 EH (610 mm)
50	F HA 1121 00 99	F HA 1141 00 99

ZINCATO



1 EH = 17 mm



DIVISORI TRASVERSALI

Per altezze frontali	ART. lunghezza 2 EH (30 mm)	ART. lunghezza 3 EH (47 mm)	ART. lunghezza 4 EH (64 mm)	ART. lunghezza 5 EH (81 mm)
50	F HA 3105 00 00	F HA 3110 00 00	F HA 3115 00 00	F HA 3120 00 00
75	-	F HA 3210 00 00	F HA 3215 00 00	F HA 3220 00 00
100-125	-	F HA 3310 00 00	F HA 3315 00 00	F HA 3320 00 00
150-175	-	-	-	-
200-250	-	-	-	-
300-400	-	-	-	-

ALLUMINIO

Per altezze frontali	ART. lunghezza 6 EH (98 mm)	ART. lunghezza 7 EH (115 mm)	ART. lunghezza 8 EH (132 mm)	ART. lunghezza 9 EH (149 mm)
50	F HA 3125 00 00	F HA 3130 00 00	F HA 3135 00 00	F HA 3140 00 00
75	F HA 3225 00 00	F HA 3230 00 00	F HA 3235 00 00	F HA 3240 00 00
100-125	F HA 3325 00 00	F HA 3330 00 00	F HA 3335 00 00	F HA 3340 00 00
150-175	F HA 3425 00 00	F HA 3430 00 00	F HA 3435 00 00	F HA 3440 00 00
200-250	-	F HA 3530 00 00	F HA 3535 00 00	F HA 3540 00 00
300-400	-	-	-	F HA 3640 00 00

ALLUMINIO

Per altezze frontali	ART. lunghezza 10 EH (166 mm)	ART. lunghezza 12 EH (200 mm)	ART. lunghezza 15 EH (251 mm)	ART. lunghezza 18 EH (302 mm)
50	F HA 3145 00 00	F HA 3150 00 00	F HA 3155 00 00	F HA 3160 00 00
75	F HA 3245 00 00	F HA 3250 00 00	F HA 3255 00 00	F HA 3260 00 00
100-125	F HA 3345 00 00	F HA 3350 00 00	F HA 3355 00 00	F HA 3360 00 00
150-175	F HA 3445 00 00	F HA 3450 00 00	F HA 3455 00 00	F HA 3460 00 00
200-250	F HA 3545 00 00	F HA 3550 00 00	F HA 3555 00 00	F HA 3560 00 00
300-400	F HA 3645 00 00	F HA 3650 00 00	F HA 3655 00 00	F HA 3660 00 00

ALLUMINIO

MATERIALE DI SEPARAZIONE

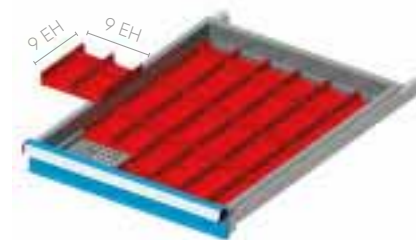
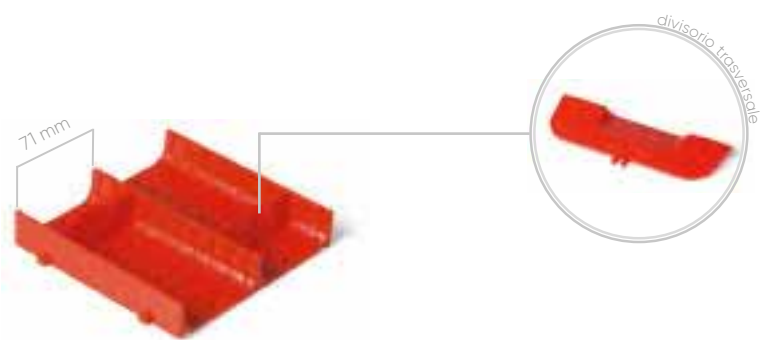

DIVISORIO A 2 CANALI 9x9 EH

ART.	Dim. mm	
F HC 3071 01 03	150x150x28 H	16

Per utensili Ø max. 70 mm

DIVISORIO TRASVERSALE 73 mm

ART.	
F HC 1871 01 03	35

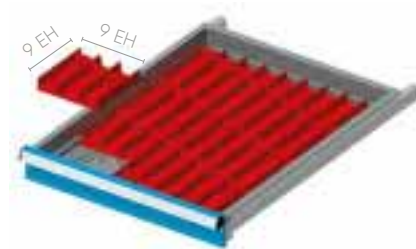
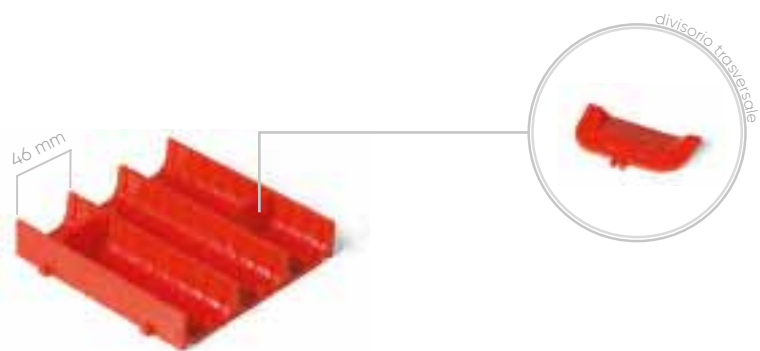

DIVISORIO A 3 CANALI 9x9 EH

ART.	Dim. mm	
F HC 3471 01 03	150x150x28 H	16

Per utensili Ø max. 45 mm

DIVISORIO TRASVERSALE 47 mm

ART.	
F HC 1471 01 03	50

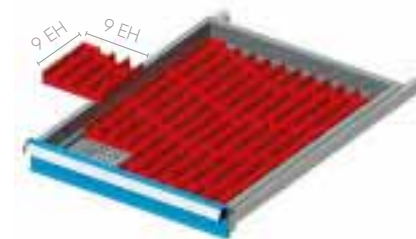
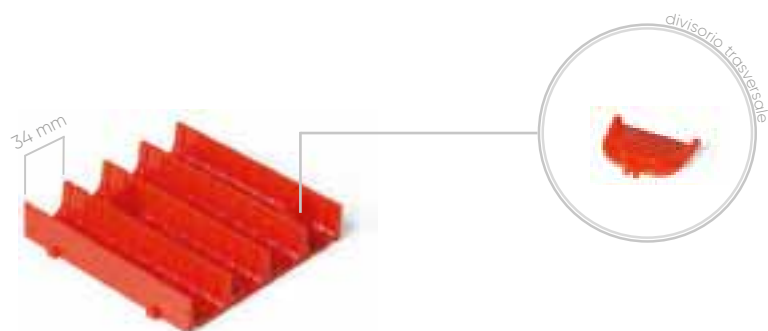

DIVISORIO A 4 CANALI 9x9 EH

ART.	Dim. mm	
F HC 3871 01 03	150x150x28 H	16

Per utensili Ø max. 33 mm

DIVISORIO TRASVERSALE 36 mm

ART.	
F HC 1071 01 03	65

1 EH = 17 mm

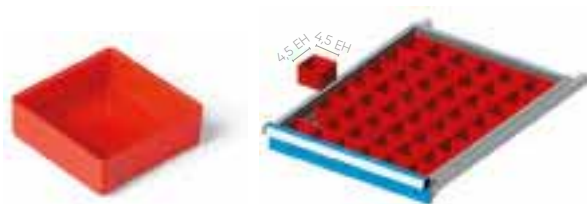

CASSETTA DIVISORIO 4,5x4,5 EH

Per altezze frontali	ART.	Dim. mm	
50	F HC 4471 01 03	75x75x26 H	64
75	F HC 6071 01 03	75x75x52 H	64



CASSETTA DIVISORIO 4,5x4,5 EH

Per altezze frontali	ART.	Dim. mm	
50	F HC 4071 01 03	75x75x26 H	64

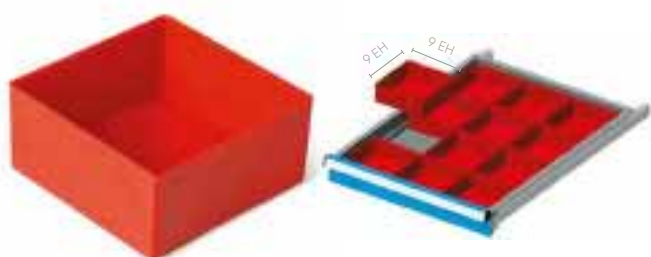

CASSETTA DIVISORIO 9x9 EH

Per altezze frontali	ART.	Dim. mm	
50	F HC 5271 01 03	150x150x26 H	16
75	F HC 6871 01 03	150x150x52 H	16
100-125	F HC 7671 01 03	150x150x71 H	16

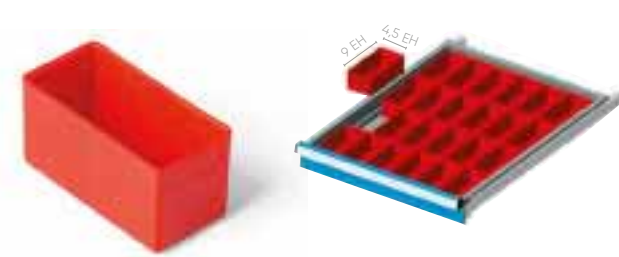

CASSETTA DIVISORIO 9x4,5 EH

Per altezze frontali	ART.	Dim. mm	
50	F HC 4871 01 03	150x75x26 H	32
75	F HC 6471 01 03	150x75x52 H	32
100-125	F HC 7271 01 03	150x75x71 H	32

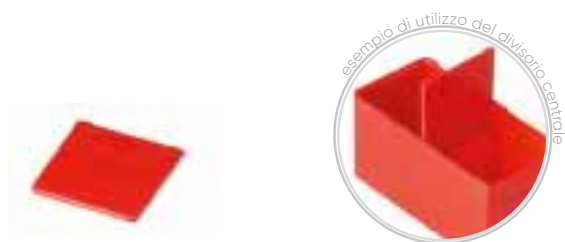

DIVISORIO PER CASSETTE SERIE F HC 5671

ART.	
F HC 8071 01 03	72



CASSETTA DIVISORIO 6x3 EH

Per altezze frontali	ART.	Dim. mm	
75	F HC 5671 01 03	100x50x52 H	72

PORTA ETICHETTE

Porta etichette completo di cellophane + etichette

ART. F HC 9071 01 03

Non adatto per articolo F HC 5671 00 03

Confezioni da: 50 pz

Etichette di ricambio complete di cellophane

ART. R FHD 0002 00

Confezioni da: 84 pz



MATERIALE DI SEPARAZIONE



PORTA FRESE

ART.	Porta frese Ø mm	Foro DIN utensile mm	Altezza mm	
F HD 2071 01 03	12,2	13	26	50
F HD 2371 01 03	15,5	16	26	50
F HD 2671 01 03	21,5	22	26	50
F HD 2971 01 03	26,5	27	26	25
F HD 3271 01 03	31,2	32	26	25
F HD 3571 01 03	39,5	40	26	25
F HD 3871 01 03	49,5	50	26	25
F HD 4171 01 03	1	-	26	25
F HD 4471 01 03	1 ^{1/2}	-	26	25



VASCHETTA PORTA MINUTERIE

ART.	Dim. mm	
F HD 8271 01 03	65x25x30 H	10



Questo divisorio deve essere accoppiato con i seguenti DIVISORI LONGITUDINALI FESSURATI:
 ART. F HA 1140 00 99 per cassette lunghezza 600 mm (36 EH)
 ART. F HA 1120 00 99 per cassette lunghezza 447 mm (27 EH)

1 EH = 17 mm



DIVISORIO A 6 CANALI

ART.	
F HD 1871 01 03	30

Per utensili max. Ø 20 mm

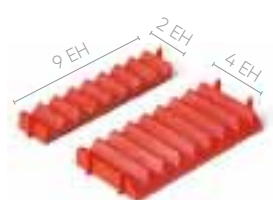

DIVISORIO A 8 CANALI

ART.	
F HD 1471 01 03	30

Per utensili max. Ø 14 mm

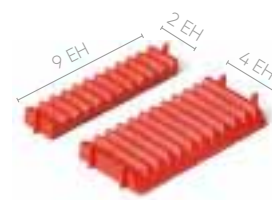

DIVISORIO A 11 CANALI

ART.	
F HD 1071 01 03	30

Per utensili max. Ø 8 mm



DIVISORIO TRASVERSALE LARGHEZZA 9 EH

ART.	Dim. mm	
F HA 3140 01 00	149x27 H	100



Questo divisorio deve essere accoppiato con i seguenti DIVISORI LONGITUDINALI FESSURATI:
 ART. F HA 1140 00 99 per cassette lunghezza 600 mm (36 EH)
 ART. F HA 1120 00 99 per cassette lunghezza 447 mm (27 EH)



LAMINE PORTACARTELLINO

ART.	H mm	Per altezze frontali
F HD 0105 00 00	25	50
F HD 0110 00 00	50	75-100

Porta cartellino + etichetta A RICHIESTA



MATERIALE DI SEPARAZIONE



PORTA CHIAVI A BRUGOLA

ART.	Dim. mm
F HD 9271 00 03	150x150x26 H

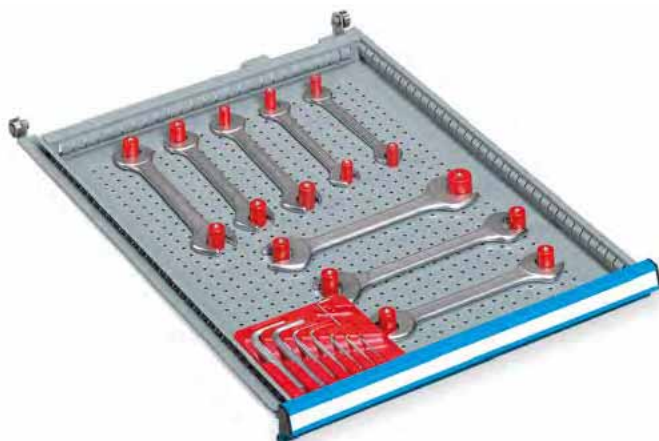

COPPIA SUPPORTI PRISMATICI

ART.	Q.tà per cartone
F HD 5071 01 03	10

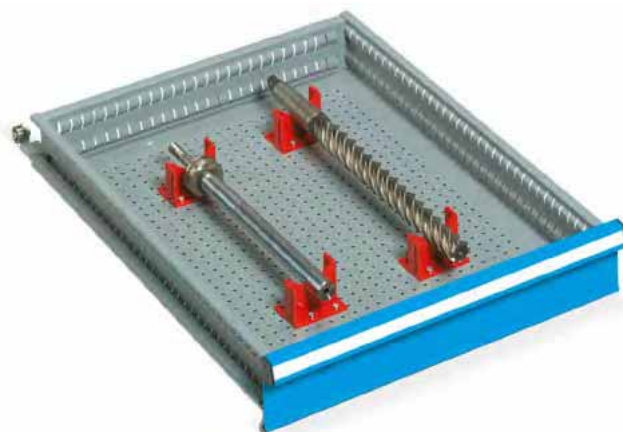

 Q.tà per cartone



SUPPORTO MULTIUSO

ART.	Dim. mm	
F HD 7271 00 04	440x30x35 H	

COLORE DISPONIBILE BLU



SUPPORTO MULTIUSO

ART.	Dim. mm	
F HD 7571 00 04	600x30x35 H	

COLORE DISPONIBILE BLU

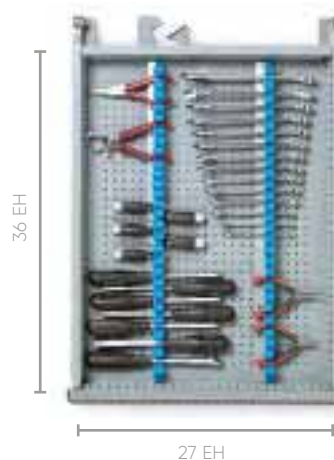

PERNO DI FISSAGGIO 26 mm H

ART.	Per altezze frontali	Ø mm	Q.tà
F HD 0250 01 99	50	3	50

ZINCATO

PERNO DI FISSAGGIO 27 mm H

ART.	Per altezze frontali	Ø mm	Q.tà
F HD 0210 01 99	50	6	50

ZINCATO

PERNO DI FISSAGGIO 52 mm H

ART.	Per altezze frontali	Ø mm	Q.tà
F HD 0215 01 99	75	6	50

ZINCATO

PERNO DI FISSAGGIO 77 mm H

ART.	Per altezze frontali	Ø mm	Q.tà
F HD 0220 01 99	100-125	6	50

ZINCATO



 Q.tà per cartone

MATERIALE DI SEPARAZIONE



CASSETTO

ART.	Dim. mm	
F HD 0310 00 99	470x200x30 H	

ZINCATO



SOLO PER LARGHEZZA 447 mm (27 EH)



COPPIA GUIDE PER CARTELLE SOPPESE 27 EH

ART.	Per altezze frontali	
F HD 0460 00 99	300	

ZINCATO

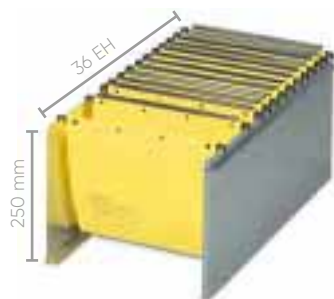

COPPIA GUIDE PER CARTELLE SOPPESE 36 EH

ART.	Per altezze frontali	
F HD 0465 00 99	300	

ZINCATO



1 EH = 17 mm



GOMMASCHIUMA

ART.	Per cassette	Dim. mm	
F HD 5471 00 00	27x27 EH	450x450x10 H	
F HD 5571 00 00	36x27 EH	605x450x10 H	
F HD 5871 00 00	36x36 EH	605x605x10 H	
F HD 6171 00 00	54x27 EH	905x450x10 H	
F HD 6471 00 00	54x36 EH	905x605x10 H	



GOMMA ANTISDRUCCIOLEVOLE

ART.	Per cassette	Dim. mm	
F HD 6505 00 07	19x27 EH	323x450x3 H	
F HD 6510 00 07	27x27 EH	450x450x3 H	
F HD 6515 00 07	36x27 EH	600x450x3 H	
F HD 6525 00 07	54x27 EH	905x450x3 H	
F HD 6560 00 07	27x36 EH	450x600x3 H	
F HD 6565 00 07	36x36 EH	600x600x3 H	
F HD 6570 00 07	45x36 EH	758x600x3 H	
F HD 6575 00 07	54x36 EH	905x600x3 H	
F HD 6580 00 07	64x36 EH	1081x600x3 H	
F HD 6585 00 07	78x36 EH	1319x600x3 H	

ROTOLO

ART.	Dim. mm	
C MV 99 201	10.000x450x3 H	
C MV 99 202	10.000x600x3 H	



**ARMADI CON PORTE
A BATTENTE O
SCORREVOLI,
REALIZZATI IN
ROBUSTA LAMIERA D'ACCIAIO**

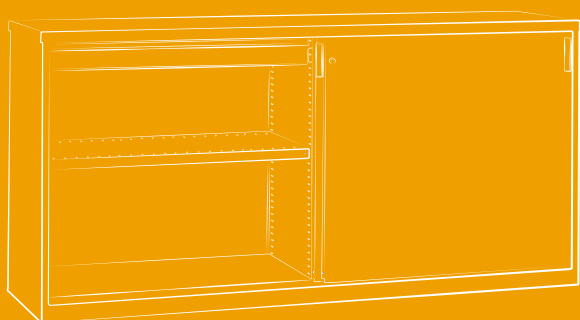



PERFOM

CARATTERISTICHE TECNICHE

Gli armadi con porte a battente, porte scorrevoli o tapparella sono costruiti in lamiera di acciaio debitamente sagomata e rinforzata per resistere ai carichi più gravosi. Sono stati studiati e realizzati in diverse misure per risolvere innumerevoli problemi di immagazzinaggio.

All'interno si possono inserire più cassette o piani regolabili. I cassette hanno un'altezza frontale di 100 mm e scorrono su guide semplici o telescopiche.



PORTE A BATTENTE

Le porte a battente sono disponibili in lamiera piena, con pannelli forati per l'applicazione di contenitori/ganci porta utensili o in policarbonato trasparente, per una maggiore visibilità e ordine degli oggetti contenuti. La chiusura a 3 punti garantisce un'elevata sicurezza allo scasso.



PORTE SCORREVOLI

Le porte scorrevoli sono disponibili in lamiera piena o in policarbonato trasparente, per una maggiore visibilità e ordine degli oggetti contenuti. Ottimali per immagazzinare materiali in spazi ristretti, dato che in apertura non sporgono nella zona di passaggio.



TAPPARELLA

Le tapparelle sono in materiale plastico grigio con maniglia in lamiera di acciaio e chiusura a cilindro integrata. Ideali per spazi ristretti dove non è possibile utilizzare le porte a battente.

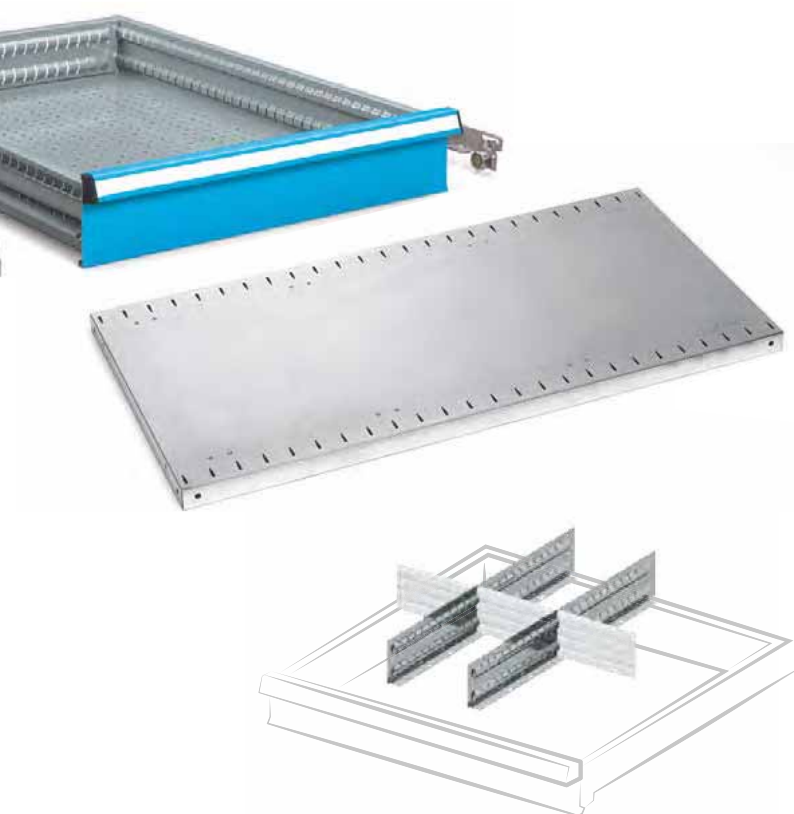

PIANI E CASSETTI

Piani in lamiera di acciaio zincata spessore 30 mm regolabili in altezza a passi di 25 mm, portata dai 100/ 180 kg.

Cassetti ad estrazione semplice o telescopica regolabili in altezza con portata dai 50 ai 100 kg.

ACCESSORI

Materiale di separazione per cassetti/piani e cassette/contenitori in plastica, consentono all'utilizzatore di ottimizzare lo spazio e mantenendo l'armadio in ordine.

H 1000 mm



● ART. F AA 1100 51 04

Gamma colori
ACCIAIO



GRIGIO
RAL 7000
.01



VERDE
RAL 6011
.02



BLU
RAL 5012
.04



GRIGIO
RAL 7035
.08



CHIUSURA CON CHIAVE (KEY)
Fornita di serie con chiusura a cilindro e 2 chiavi

- LA PORTATA DEL PIANO SUPERIORE È DI 80 kg
- LA PORTATA DELL'ARMADIO È DI 250 kg

LEGENDA



PORTATA
CASSETTO



ESTRAZIONE
CASSETTO



CHIUSURA
ARMADIO



LE PORTATE SONO NETTE E SI RIFERISCONO A PESI UNIFORMEMENTE DISTRIBUITI.

H 1000 mm



ART.



kg



● **F AA 1100 51 04**

-

key

2 piani regolabili ART. F AC 2100 01 99 - portata 100 kg

H 1000 mm



ART.



kg



F AA 1100 53 04

50

key

2 piani regolabili ART. F AC 2100 01 99 - portata 100 kg
1 cassetto (24x27 EH)

escluso 1 contenitore PICKING BOX mis. 4 art. FAX PB C004 B0 51 01

H 1000 mm



ART.



kg



F AA 1100 54 04

50

key

1 piano regolabile ART. F AC 2100 01 99- portata 100 kg
2 cassetti (24x27 EH)

H 1000 mm



ART.



kg



F AA 1100 56 04

50

key

1 piano regolabile ART. F AC 2100 01 99- portata 100 kg
3 cassetti (24x27 EH)

H 1270 mm



ART.



kg



F AA 0110 01 04

50

key

1 piano regolabile ART. F AC 2100 01 99- portata 100 kg
1 cassetto (24x27 EH)



ART. F AA D110 00 08

Dim. mm 512x555x1400 H

Armadio con leggìo con 2 piani regolabili, 2 ruote girevoli in gomma standard con freno e 2 ruote fisse in gomma standard Ø 100 mm

CONFIGURA IL TUO ARMADIO

Gamma colori
ACCIAIO

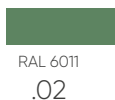
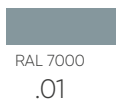

ART.		portata armadio	
F AA 1100 00 04		250 kg	key

Armadio vuoto con porta
Dimensioni interne mm 480x500x850 H



Il limite massimo di portata dei cassetti inseriti nell'armadio è di 200 kg indipendentemente dalla portata dell'armadio

PIANO REGOLABILE PROFONDITÀ 500 mm

ART	dim. mm	portata piano
F AC 2100 01 99	483x500x35 H	100 kg

Zincato
Completo di 4 ganci.
Adatto per contenitori PICKING BOX/STORAGE BOX:



mis. 4A2
mis. 4
mis. 4A5



mis. 272-4A2
mis. 272-4
mis. 272-4A5

CASSETTO AD ESTRAZIONE SEMPLICE 24x27 EH

ART	dim. utili mm	kg	
F AC 1100 00 04	396x447x85 H	50 kg	87%

CASSETTO AD ESTRAZIONE TELESCOPICA 24x27 EH

ART	dim. utili mm	kg	
F AC 1150 00 04	396x447x85 H	100 kg	100%



TUTTI GLI ARMADI SONO FORNITI DI SERIE CON 2 STAFFE PER IL FISSAGGIO A PAVIMENTO E 2 STAFFE PER IL FISSAGGIO A PARETE.



PIANO SUPERIORE A 3 BORDI CON GOMMA

ART.	dim. mm	
F AC 4100 01 07	512x555x20 H	

Piano rivestito in PVC. Colore nero

ADATTO PER ARMADIO F AA 1100



PIANO SUPERIORE IN MDF DIM. 513x555x31,5 mm H

ART.	rifiniture	per armadio	
F UZ 3050 11 07	1 profilo laterale	finale dx o sx	

Piano in MDF con copertura in gomma antiolio. Colore nero



PIANO SUPERIORE IN MDF DIM. 513x555x31,5 mm H

ART.	rifiniture	per armadio	
F UZ 3050 12 07	-	centrale	

Piano in MDF con copertura in gomma antiolio. Colore nero



**RIFINITURA
GOMMA
ANTIOLIO**



PIANO SUPERIORE IN MDF DIM. 513x555x31,5 mm H

ART.	rifiniture	per armadio	
F UZ 3050 13 07	2 profili laterali	singolo	

Piano in MDF con copertura in gomma antiolio. Colore nero



**APPLICAZIONE
PIANO IN MDF**



ART. F UZ 9999 00 00

FORATURA PIANO SUPERIORE DELL'ARMADIO
PER IL FISSAGGIO DEL PIANO IN MDF
COMPRESIVO DI VITI PER IL FISSAGGIO

FISSAGGIO

SET FISSAGGIO TRA ARMADI

ART. F AG 9202 00 99

Set di fissaggio armadio-armadio con 4 viti complete di dadi M8

ART. F UZ 9995 00 99

Foratura e viteria per il fissaggio dei due armadi sovrapposti

SET DI FISSAGGIO A PAVIMENTO



ART. F AG 9200 00 99

Coppia staffe zincate per armadio per fissaggio a pavimento

ART. F AG 9204 00 99

2 tasselli "HILTI" adatti per pavimenti in calcestruzzo non fessurato maggiore o uguale alla classe C20/25
Trazione consigliata del tassello: 2,9 kN
Diametro tassello: Ø 6 mm



Se negli armadi vengono inseriti uno o più cassetti, è obbligatorio fissare gli armadi al pavimento o alla parete.

ARMADI SOVRAPPosti:

-F AA 1100 + F AA 1100

OBBLIGO DI FISSAGGIO A PARETE E PORTATA DI OGNI ARMADIO DIVISA PER DUE.



H 1000 mm



● ART. F AA 1200 51 04

Gamma colori
ACCIAIO



GRIGIO
RAL 7000
.01



VERDE
RAL 6011
.02



BLU
RAL 5012
.04



GRIGIO
RAL 7035
.08



CHIUSURA CON CHIAVE (KEY)
Fornita di serie con chiusura a cilindro e 2 chiavi

- LA PORTATA DEL PIANO SUPERIORE È DI 80 kg
- LA PORTATA DELL'ARMADIO È DI 600 kg

LEGENDA



PORTATA
CASSETTO



ESTRAZIONE
CASSETTO



CHIUSURA
ARMADIO



LE PORTATE SONO NETTE E SI RIFERISCONO A PESI UNIFORMEMENTE DISTRIBUITI.



H 1000 mm

ART.				
F AA 1200 51 04	-	-	-	key

2 piani regolabili ART. F AC 2500 01 99 - portata 100 kg
esclusi 4 contenitori PICKING BOX **mis. 4** art. FAX PB C004 B0 51 01

H 1000 mm



ART.				
F AA 1200 52 04	-	50	87%	key

2 piani regolabili ART. F AC 2500 01 99 - portata 100 kg
1 coppia cassette (24x27 EH)
esclusi 3 contenitori PICKING BOX **mis. 4A2** art. FAX PB C4A2 B0 51 04

H 1000 mm



ART.				
F AA 1200 53 04	-	50	87%	key

1 piano regolabile ART. F AC 2500 01 99 - portata 100 kg
1 coppia cassette (24x27 EH)
1 cassetto (54x27 EH)
escluso 1 contenitore PICKING BOX **mis. 4** art. FAX PB C004 B0 51 01

H 1000 mm



ART.				
F AA 1200 54 04	-	50	87%	key

1 piano regolabile ART. F AC 2500 01 99 - portata 100 kg
2 coppie cassette (24x27 EH)
escluso 1 contenitore PICKING BOX **mis. 4** art. FAX PB C004 B0 51 01

H 1000 mm



ART.				
F AA 1200 55 04	-	50	87%	key

1 piano regolabile ART. F AC 2500 01 99 - portata 100 kg
2 cassette (54x27 EH)
esclusi 3 contenitori PICKING BOX **mis. 4** art. FAX PB C004 B0 51 01

CONFIGURA IL TUO ARMADIO

Gamma colori
ACCIAIO



RAL 7000
.01



RAL 6011
.02



RAL 5012
.04



RAL 7035
.08



ART.		portata armadio	
F AA 1200 00 04		600 kg	key

Armadio vuoto con coppia porte
Dimensioni interne mm 990x500x850 H



Il limite massimo di portata dei cassetti inseriti nell'armadio è di 350 kg indipendentemente dalla portata dell'armadio

PIANO REGOLABILE PROFONDITÀ 500 mm

ART.	dim. mm	portata piano	n. rinforzi
F AC 2500 01 99	995x500x35 H	100 kg	-
F AC 2500 03 99*	995x500x35 H	180 kg	1

Zincato

*Non si possono inserire i contenitori serie RK BOX sui piani con un rinforzo Completo di 4 ganci.

Adatto per contenitori PICKING BOX/STORAGE BOX:

	mis. 4A2	mis. 272-4A2
	mis. 4	mis. 272-4
	mis. 4A5	mis. 272-4A5

COPPIA CASSETTI AD ESTRAZIONE SEMPLICE E TELESCOPICA 24x27 EH

ART.		dim. utili mm	kg	
F AC 1600 00 04		396x447x85 H *	50 kg	87%
F AC 1650 00 04		396x447x85 H *	60 kg	100%

*Le dimensioni si riferiscono ad un cassetto

CASSETTI AD ESTRAZIONE SEMPLICE E TELESCOPICA 54x27 EH

ART.		dim. utili mm	kg	
F AC 1200 00 04		906x447x85 H	50 kg	87%
F AC 1250 00 04		906x447x85 H	100 kg	100%

TELAIO AD ESTRAZIONE TELESCOPICA PER CARTELLE SOSPENSE DIN A4

ART.	dim. mm	portata telaio	
F AC 7500 00 07	990x500	30 kg	100%

Colore nero RAL 9005



TUTTI GLI ARMADI SONO FORNITI DI SERIE CON 2 STAFFE PER IL FISSAGGIO A PAVIMENTO E 2 STAFFE PER IL FISSAGGIO A PARETE.





PANNELLO FORATO PER FISSAGGIO A MURO

ART.	dim. mm	portata pannello
F BL 1220 00 04	988x13x456 H	25 kg

Fornito senza tasselli di fissaggio



PIANO SUPERIORE A 3 BORDI CON GOMMA

ART.	dim. mm
F AC 4200 01 07	1023x555x20 H

Piano rivestito in PVC. Colore nero
ADATTO PER ARMADIO F AA 1200



PIANO SUPERIORE IN MDF DIM. 1024x555x31,5 mm H

ART.	rifiniture	per armadio
F UZ 3060 11 07	1 profilo laterale	finale dx o sx

Piano in MDF con copertura in gomma antiolio. Colore nero



PIANO SUPERIORE IN MDF DIM. 1024x555x31,5 mm H

ART.	rifiniture	per armadio
F UZ 3060 12 07	-	centrale

Piano in MDF con copertura in gomma antiolio. Colore nero



PIANO SUPERIORE IN MDF DIM. 1024x555x31,5 mm H

ART.	rifiniture	per armadio
F UZ 3060 13 07	2 profili laterali	singolo

Piano in MDF con copertura in gomma antiolio. Colore nero



**RIFINITURA
GOMMA
ANTIOLIO**



**APPLICAZIONE
PIANO IN MDF**



ART. F UZ 9999 00 00

FORATURA PIANO SUPERIORE DELL'ARMADIO
PER IL FISSAGGIO DEL PIANO IN MDF
COMPRESIVO DI VITI PER IL FISSAGGIO

FISSAGGIO

SET FISSAGGIO TRA ARMADI

ART. F AG 9202 00 99

Set di fissaggio armadio-armadio con 4 viti complete di dadi M8

ART. F UZ 9995 00 00

Foratura e viteria per il fissaggio dei due armadi sovrapposti

SET DI FISSAGGIO A PAVIMENTO



ART. F AG 9200 00 99

Coppia staffe zincate per armadio per fissaggio a pavimento

ART. F AG 9204 00 99

2 tasselli "HILTI" adatti per pavimenti in calcestruzzo non fessurato maggiore o uguale alla classe C20/25
Trazione consigliata del tassello: 2,9 kN
Diametro tassello: Ø 6 mm



Se negli armadi vengono inseriti uno o più cassetti, è obbligatorio fissare gli armadi al pavimento o alla parete.

ARMADI SOVRAPPosti:

-F AA 1200 + F AA 1200

OBBLIGO DI FISSAGGIO A PARETE E PORTATA DI OGNI ARMADIO DIVISA PER DUE.







H 1000 mm



● ART. F AA 1500 51 04

Gamma colori
ACCIAIO



GRIGIO
RAL 7000
.01



VERDE
RAL 6011
.02



BLU
RAL 5012
.04



GRIGIO
RAL 7035
.08



CHIUSURA CON CHIAVE (KEY)
Fornita di serie con chiusura a cilindro e 2 chiavi

- LA PORTATA DEL PIANO SUPERIORE È DI 80 kg
- LA PORTATA DELL'ARMADIO È DI 600 kg

LEGENDA



PORTATA
CASSETTO



ESTRAZIONE
CASSETTO



CHIUSURA
ARMADIO



LE PORTATE SONO NETTE E SI RIFERISCONO A PESI UNIFORMEMENTE DISTRIBUITI.

H 1000 mm



ART.				
F AA 1500 51 04	-	-	-	key

2 piani regolabili ART. F AC 2550 01 99 - portata 100 kg
esclusi 2 contenitori PICKING BOX **mis. 4A2** art. FAX PB C4A2 B0 51 04
escluso 1 contenitore PICKING BOX **mis. 4** art. FAX PB C004 B0 51 01

H 1000 mm



ART.				
F AA 1500 52 04	-	50	87%	key

1 piano regolabile ART. F AC 2550 01 99 - portata 100 kg
1 coppia cassette (27x27 EH)

H 1000 mm



ART.				
F AA 1500 55 04	-	50	87%	key

1 piano regolabile ART. F AC 2550 01 99 - portata 100 kg
1 coppia cassette (27x27 EH)
1 cassetto (64x27 EH)

H 1000 mm



ART.				
F AA 1500 56 04	-	50	87%	key

1 piano regolabile ART. F AC 2550 01 99 - portata 100 kg
2 coppie cassette (27x27 EH)
escluso 1 contenitore PICKING BOX **mis. 4** art. FAX PB C004 B0 51 01

H 1000 mm



ART.				
F AA 1500 57 04	-	50	87%	key

1 piano regolabile ART. F AC 2550 01 99 - portata 100 kg
2 cassette (64x27 EH)
escluso 1 contenitore PICKING BOX **mis. 4** art. FAX PB C004 B0 51 01

CONFIGURA IL TUO ARMADIO

Gamma colori
ACCIAIO



RAL 7000
.01



RAL 6011
.02



RAL 5012
.04



RAL 7035
.08



ART.	portata armadio	key
F AA 1500 00 04	600 kg	key

Armadio vuoto con coppia porte
Dimensioni interne mm 1160x500x850 H



Il limite massimo di portata dei cassetti inseriti nell'armadio è di 350 kg indipendentemente dalla portata dell'armadio

PIANO REGOLABILE PROFONDITÀ 500 mm

ART.	dim. mm	portata piano	n. rinforzi
F AC 2550 01 99	1165x500x35 H	100 kg	-
F AC 2550 03 99*	1165x500x35 H	180 kg	1

Zincato

*Non si possono inserire i contenitori serie RK BOX sui piani con un rinforzo Completo di 4 ganci.

Adatto per contenitori PICKING BOX/STORAGE BOX:



mis. 4A2
mis. 4
mis. 4A5



mis. 272-4A2
mis. 272-4
mis. 272-4A5



COPIA CASSETTI AD ESTRAZIONE SEMPLICE E TELESCOPICA 27x27 EH

ART.	dim. utili mm	kg	ESTRAZIONE
F AC 1700 00 04	447x447x85 H *	50 kg	87%
F AC 1750 00 04	447x447x85 H *	60 kg	100%

*Le dimensioni si riferiscono ad un cassetto

CASSETTI AD ESTRAZIONE SEMPLICE E TELESCOPICA 64x27 EH

ART.	dim. utili mm	kg	ESTRAZIONE
F AC 1300 00 04	1076x447x85 H	50 kg	87%
F AC 1350 00 04	1076x447x85 H	100 kg	100%



PANNELLO FORATO PER FISSAGGIO A MURO

ART.	dim. mm	portata pannello
F BL 1220 00 04	988x13x456 H	25 kg

Fornito senza tasselli di fissaggio



TUTTI GLI ARMADI SONO FORNITI DI SERIE CON 2 STAFFE PER IL FISSAGGIO A PAVIMENTO E 2 STAFFE PER IL FISSAGGIO A PARETE.





PIANO SUPERIORE A 3 BORDI CON GOMMA

ART.	dim. mm	
F AC 4300 01 07	1193x555x20 H	

Piano rivestito in PVC. Colore nero
ADATTO PER ARMADIO F AA 1500



PIANO SUPERIORE IN MDF DIM. 1193x555x31,5 mm H

ART.	rifiniture	per armadio	
F UZ 3070 11 07	1 profilo laterale	finale dx o sx	

Piano in MDF con copertura in gomma antiolio. Colore nero



PIANO SUPERIORE IN MDF DIM. 1193x555x31,5 mm H

ART.	rifiniture	per armadio	
F UZ 3070 12 07	-	centrale	

Piano in MDF con copertura in gomma antiolio. Colore nero



PIANO SUPERIORE IN MDF DIM. 1193x555x31,5 mm H

ART.	rifiniture	per armadio	
F UZ 3070 13 07	2 profili laterali	singolo	

Piano in MDF con copertura in gomma antiolio. Colore nero

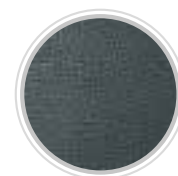

**RIFINITURA
GOMMA
ANTIOLIO**



**APPLICAZIONE
PIANO IN MDF**



ART. F UZ 9999 00 00

FORATURA PIANO SUPERIORE DELL'ARMADIO
PER IL FISSAGGIO DEL PIANO IN MDF
COMPRESIVO DI VITI PER IL FISSAGGIO

FISSAGGIO

SET FISSAGGIO TRA ARMADI

ART. F AG 9202 00 99

Set di fissaggio armadio-armadio con 4 viti complete di dadi M8

ART. F UZ 9995 00 00

Foratura e viteria per il fissaggio dei due armadi sovrapposti

SET DI FISSAGGIO A PAVIMENTO



ART. F AG 9200 00 99

Coppia staffe zincate per armadio per fissaggio a pavimento

ART. F AG 9204 00 99

2 tasselli "HILTI" adatti per pavimenti in calcestruzzo non fessurato maggiore o uguale alla classe C20/25
Trazione consigliata del tassello: 2,9 kN
Diametro tassello: Ø 6 mm



Se negli armadi vengono inseriti uno o più cassetti, è obbligatorio fissare gli armadi al pavimento o alla parete.

ARMADI SOVRAPPosti:

-F AA 1500 + F AA 1500

OBBLIGO DI FISSAGGIO A PARETE E PORTATA DI OGNI ARMADIO DIVISA PER DUE.



H 2000 mm



● ART. F AA 1300 52 04

Gamma colori

ACCIAIO 



GRIGIO
RAL 7000
.01



VERDE
RAL 6011
.02



BLU
RAL 5012
.04



GRIGIO
RAL 7035
.08



CHIUSURA CON CHIAVE (KEY)
Fornita di serie con chiusura a cilindro e 2 chiavi

- LA PORTATA DEL PIANO SUPERIORE È DI 80 kg
- LA PORTATA DELL'ARMADIO È DI 800 kg

LEGENDA



PORTATA
CASSETTO



ESTRAZIONE
CASSETTO



CHIUSURA
ARMADIO



LE PORTATE SONO NETTE E SI RIFERISCONO A PESI UNIFORMEMENTE DISTRIBUITI.

H 2000 mm



ART.				
F AA 1300 01 04	-	-	-	key

4 piani regolabili ART. F AC 2350 01 99 - portata 100 kg

H 2000 mm



porte in policarbonato spessore 3 mm

ART.				
F AA 1302 03 04	-	-	-	key

4 piani regolabili ART. F AC 2350 01 99 - portata 100 kg

H 2000 mm



ART.				
F AA 1303 52 04	-	-	-	key

1 piano regolabile ART. F AC 2330 06 99 - portata 25 kg
 4 pannelli forati - portata 40 kg (ogni singola porta a pannelli forati)
 1 set di 142 ganci ART. F BL 9525 00 99 (60 ART. CMV10037, 24 ART. CMV10014,
 1 ART. CMV10025, 2 ART. CMV10017, 8 ART. CMV 10001, 3 ART. CMV 10007,
 2 ART. CMV 10016, 19 ART. CMV 10022, 16 ART. CMV 10023, 7 ART. CMV 10021)
 1 set di 13 ganci ART. F BL 9539 00 99 (1 ART. CMV10024, 8 ART. CMV10032,
 2 ART. CMV10031, 2 ART. CMV10037)

UTENSILI ESCLUSI

ARMADIO SENZA GANCI ART. **F AA 1303 02 04**

H 2000 mm



ART.				
F AA 1300 52 04	-	-	-	key

6 piani regolabili ART. F AC 2350 01 99 - portata 100 kg
 28 contenitori grigi PICKING BOX **mis. 3** art. FAX PB C003 B0 51 01

ARMADIO SENZA CONTENITORI ART. **F AA 1300 02 04**

CONFIGURA IL TUO ARMADIO

Gamma colori
ACCIAIO

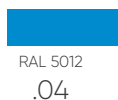
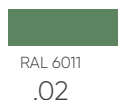
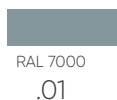

H 2000 mm



ART.		portata armadio	
F AA 1300 00 04		800 kg	key

Armadio vuoto con coppia porte
Dimensioni interne mm 995x345x1850 H

H 2000 mm



ART.		portata armadio	
F AA 1300 03 04		800 kg	key

Armadio vuoto con coppia porte a pannelli forati
Dimensioni interne mm 995x345x1850 H
Portata di ogni singola porta 40 kg
GLI ARMADI CON PORTE FORATE DEVONO ESSERE FISSATI A PARETE.

H 2000 mm



ART.		portata armadio	
F AA 1302 00 04		800 kg	key

Armadio vuoto con coppia porte in policarbonato spessore 3 mm
Dimensioni interne mm 995x345x1850 H
Portata di ogni singola porta 40 kg



PIANO REGOLABILE PROFONDITÀ 250 mm

ART.	dim. mm	portata piano
F AC 2330 06 99	995x250x35 H	25 kg

Zincato
Completo di 2 guide
Adatto per contenitori PICKING BOX/STORAGE BOX:



mis. 2



mis. 272-2



Questo tipo di piano può essere inserito anche quando viene applicata la parete posteriore forata.



TUTTI GLI ARMADI SONO FORNITI DI SERIE CON 2 STAFFE PER IL FISSAGGIO A PAVIMENTO E 2 STAFFE PER IL FISSAGGIO A PARETE.

PIANO REGOLABILE PROFONDITA' 345 mm



ART.	dim. mm	portata piano	
F AC 2350 01 99	995x345x35 H	100 kg	

Zincato

Completo di 4 ganci

Adatto per contenitori PICKING BOX/STORAGE BOX:



mis. 3

mis. 3A2



mis. 272-3A2



Questo tipo di piano può essere inserito solo se non viene applicata la parete posteriore forata.

BARRA AGGANCIAMENTO CONTENITORI



ART.	dim. mm	portata barra	
F BL 7438 00 99	445x86 H	10 kg	

Zincato

Adatta per contenitori PICKING BOX/STORAGE BOX:



mis. 1

mis. 2



mis. 272-2



Questo tipo di barra può essere applicata alle porte con pannelli forati oppure ai pannelli forati montati all'interno dell'armadio.

PANNELLO FORATO



ART.	dim. mm	portata pannello	
F AC 8100 01 04	988x13x456 H	25 kg	

Completo di 4 staffe, 4 viti, 4 rondelle

Non adatto per porte



Questo tipo di pannello viene applicato tramite 4 staffe complete di viti all'interno dell'armadio. Si possono montare massimo 4 pannelli in altezza.

FISSAGGIO

SET DI FISSAGGIO A PAVIMENTO



ART. F AG 9200 00 99

Coppia staffe zincate per armadio per fissaggio a pavimento

ART. F AG 9204 00 99

2 tasselli "HILTI" adatti per pavimenti in calcestruzzo non fessurato maggiore o uguale alla classe C20/25
Trazione consigliata del tassello: 2.9 kN
Diametro tassello: Ø 6 mm



GLI ARMADI DEVONO ESSERE SEMPRE FISSATI A PAVIMENTO O A PARETE.





H 2000 mm



● ART. F AA 1400 02 04

Gamma colori

ACCIAIO 



GRIGIO
RAL 7000
.01



VERDE
RAL 6011
.02



BLU
RAL 5012
.04



GRIGIO
RAL 7035
.08



CHIUSURA CON CHIAVE (KEY)
Fornita di serie con chiusura a cilindro e 2 chiavi

- LA PORTATA DEL PIANO SUPERIORE È DI 80 kg
- LA PORTATA DELL'ARMADIO È DI 800 kg

LEGENDA



PORTATA
CASSETTO



ESTRAZIONE
CASSETTO



CHIUSURA
ARMADIO



LE PORTATE SONO NETTE E SI RIFERISCONO A PESI UNIFORMEMENTE DISTRIBUITI.

H 2000 mm



ART.		kg		
F AA 1400 01 04		-	-	key

4 piani regolabili ART. F AC 2500 01 99 - portata 100 kg



Il limite massimo di portata dei cassetti inseriti nell'armadio è di 350 kg indipendentemente dalla portata dell'armadio

H 2000 mm



ART.		kg		
F AA 1400 02 04		50	87%	key

4 piani regolabili ART. F AC 2500 01 99 - portata 100 kg
3 cassetti (54x27 EH)

H 2000 mm



ART.		kg		
F AA 1400 07 04		50	87%	key

4 piani regolabili ART. F AC 2500 01 99 - portata 100 kg
1 cassetto (54x27 EH)

H 2000 mm



100
100
100
100
100
100
100
100
100
100

ART.				
F AA 1400 11 04		50	87%	key

2 piani regolabili ART. F AC 2500 01 99 - portata 100 kg
9 cassetti (54x27 EH)

H 2000 mm



ART.				
F AA 1400 63 04		-	-	key

7 piani regolabili ART. F AC 2500 01 99 - portata 100 kg
12 contenitori blu PICKING BOX **mis. 4A2** art. FAX PB C4A2 B0 51 04
12 contenitori grigi PICKING BOX **mis. 4** art. FAX PB C004 B0 51 01
ARMADIO SENZA CONTENITORI ART. **F AA 1400 13 04**

H 2000 mm



100
100
100

ART.				
F AA 1403 55 04		50	87%	key

4 piani regolabili ART. F AC 2330 07 99 - portata 25 kg
3 piani ART. F AC 2350 07 99 - portata 50 kg
1 piano ART. F AC 2500 01 99 - portata 100 kg
3 cassetti (54x27 EH), 16 barre aggancio contenitori
40 contenitori blu PICKING BOX **mis. 1** art. FAX PB C001 A0 51 04
44 contenitori grigio PICKING BOX **mis. 2** art. FAX PB C002 A0 51 01
16 contenitori blu PICKING BOX **mis. 3A2** art. FAX PB C3A2 B0 51 04
ARMADIO SENZA CONTENITORI ART. **F AA 1403 05 04**

H 2000 mm



ART.				
F AA 1403 51 04		-	-	key

5 piani regolabili ART. F AC 2350 07 99 - portata 50 kg
2 piani ART. F AC 2500 01 99 - portata 100 kg
12 barre aggancio contenitori
48 contenitori blu PICKING BOX **mis. 1** art. FAX PB C001 A0 51 04
5 contenitori grigio PICKING BOX **mis. 2** art. FAX PB C002 A0 51 01
20 contenitori blu PICKING BOX **mis. 3A2** art. FAX PB C3A2 B0 51 04
9 contenitori grigi PICKING BOX **mis. 4** art. FAX PB C004 B0 51 01
ARMADIO SENZA CONTENITORI ART. **F AA 1403 01 04**

H 2000 mm



Gli armadi completi di RK BOX sono forniti con i fermi per impedire la fuoriuscita del contenitore stesso e con le guide per uno scorrimento preciso.



ART.



F AA 1400 65 04

-

-

key

11 piani regolabili ART. F AC 2500 01 99 - portata 100 kg
 3 contenitori blu STORAGE BOX **mis. 272-4** art. FAX SB Z004 B0 51 04
 55 RK BOX blu art. **FAX RB 5016 00 51 04**
 11 RK BOX blu art. **FAX RB 5012 00 51 04**
 77 guide per RK BOX
 66 fermi per RK BOX

ARMADIO SENZA CONTENITORI ART. **F AA 1400 15 04**

H 2000 mm



ART.



F AA 1402 01 04

-

-

key

4 piani regolabili ART. F AC 2500 01 99 - portata 100 kg



H 2200 mm



ART.				
F AA 1800 01 04	-	-	-	key

4 piani regolabili ART. F AC 2500 01 99 - portata 100 kg

H 2200 mm



100
100
100

ART.				
F AA 1800 02 04	-	50	87%	key

4 piani regolabili ART. F AC 2500 01 99 - portata 100 kg
3 cassetti (54x27 EH)

H 2200 mm



100
100
100

ART.				
F AA 1800 05 04	-	50	87%	key

Armadio con 2 pannelli forati
1 piano regolabile ART. F AC 2480 07 99- portata 50 kg
1 piano regolabile ART. F AC 2500 01 99 - portata 100 kg
3 cassetti (54x27 EH)



CONFIGURA IL TUO ARMADIO

Gamma colori
ACCIAIO



RAL 7000
.01



RAL 6011
.02



RAL 5012
.04



RAL 7035
.08

H 2000 mm



ART.		portata armadio	
F AA 1400 00 04		800 kg	key

Armadio vuoto con coppia porte
Dimensioni interne mm 995x500x1850 H

H 2000 mm



ART.		portata armadio	
F AA 1403 00 04		800 kg	key

Armadio vuoto con coppia porte a pannelli forati
Dimensioni interne mm 995x500x1850 H
Portata di ogni singola porta 40 kg
GLI ARMADI CON PORTE FORATE DEVONO ESSERE FISSATI A PARETE

H 2000 mm



ART.		portata armadio	
F AA 1402 00 04		800 kg	key

Armadio vuoto con coppia porte in policarbonato spessore 3 mm
Dimensioni interne mm 995x500x1850 H

H 2200 mm



ART.		portata armadio	
F AA 1800 00 04		800 kg	key

Armadio vuoto con tapparella
Dimensioni interne mm 995x500x1820 H



TUTTI GLI ARMADI SONO FORNITI DI SERIE CON 2 STAFFE PER IL FISSAGGIO A PAVIMENTO E 2 STAFFE PER IL FISSAGGIO A PARETE.



COPPIA CASSETTI AD ESTRAZIONE SEMPLICE E TELESCOPICA 24X27 EH

ART.		dim. utili mm	kg	
F AC 1600 00 04		396x447x85 H*	50 kg	87%
F AC 1650 00 04		396x447x85 H*	60 kg	100%

*Le dimensioni si riferiscono ad un cassetto



CASSETTI AD ESTRAZIONE SEMPLICE E TELESCOPICA 54X27 EH

ART.		dim. utili mm	kg	
F AC 1200 00 04		906x447x85 H	50 kg	87%
F AC 1250 00 04		906x447x85 H	100 kg	100%

Il limite massimo di portata dei cassetti inseriti nell'armadio è di 350 kg indipendentemente dalla portata dell'armadio



TELAIO AD ESTRAZIONE TELESCOPICA PER CARTELLE SOPPESE DIN A4

ART.		dim. mm	portata telaio	
F AC 7500 00 07		900x500	30 kg	100%

Colore nero RAL 9005



Se negli armadi vengono inseriti cassetti ad un'altezza maggiore di 1000 mm da terra è obbligatorio scegliere esclusivamente il fissaggio a parete.

PIANO REGOLABILE PROFONDITA' 500 mm

ART.	dim. mm	portata piano	n. rinforzi
F AC 2500 01 99	995x500x35 H	100 kg	-
F AC 2500 03 99*	995x500x35 H	180 kg	1

Zincato

*Non si possono inserire i contenitori serie RK BOX sui piani con un rinforzo
Adatto per contenitori PICKING BOX/STORAGE BOX:



mis. 4A2
mis. 4
mis. 4A5



mis. 272-4A2
mis. 272-4
mis. 272-4A5



Questo tipo di piano può essere inserito solo se non viene applicata la parete posteriore forata. Non si possono inserire i contenitori serie RK BOX sui piani con 1 rinforzo.

PIANO REGOLABILE PROFONDITÀ 480 mm

ART.	dim. mm	portata piano
F AC 2480 07 99	995x480x35 H	50 kg

Zincato

Adatto per contenitori PICKING BOX/STORAGE BOX:



mis. 4A2
mis. 4
mis. 4A5



mis. 272-4A2
mis. 272-4
mis. 272-4A5



Questo tipo di piano può essere inserito anche quando viene applicata la parete posteriore forata.

PERFOM 1023x555 mm



PIANO REGOLABILE PROFONDITÀ 345 mm

ART.	dim. mm	portata piano	
F AC 2350 07 99	995x345x35 H	50 kg	

Zincato
Adatto per contenitori PICKING BOX/STORAGE BOX:



mis. 3
mis. 3A2



mis. 272-3A2



Questo tipo di piano può essere inserito quando viene applicata la parete posteriore forata oppure quando vengono agganciati i contenitori mis. 1 sulle porte con pannelli forati.



PIANO REGOLABILE PROFONDITÀ 250 mm

ART.	dim. mm	portata piano	
F AC 2330 07 99	995x250x35 H	25 kg	

Zincato
Completo di 2 guide
Adatto per contenitori PICKING BOX/STORAGE BOX:



mis. 2



mis. 272-2



Questo tipo di piano può essere inserito quando viene applicata la parete posteriore forata oppure quando vengono agganciati i contenitori mis. 2 sulle porte con pannelli forati.



BARRA AGGANCIAMENTO CONTENITORI

ART.	dim. mm	portata barra	
F BL 7438 00 99	445x86 H	10 kg	

Zincato
Adatta per contenitori PICKING BOX/STORAGE BOX:



mis. 1

mis. 2



mis. 272-2



Questo tipo di barra può essere applicata alle porte con pannelli forati oppure ai pannelli forati montati all'interno dell'armadio.



PANNELLO FORATO

ART.	dim. mm	portata pannello	
F AC 8100 01 04	988x13x456 H	25 kg	

Completo di 4 staffe, 4 viti, 4 rondelle
Non adatto per porte



Questo tipo di pannello viene applicato tramite 4 staffe complete di viti all'interno dell'armadio. Si possono montare massimo 4 pannelli in altezza.

FISSAGGIO

SET FISSAGGIO TRA ARMADI

ART. F UZ 9995 00 00

Foratura e viteria per il fissaggio dei due armadi sovrapposti

SET DI FISSAGGIO A PAVIMENTO



ART. F AG 9200 00 99

Coppia staffe zincate per armadio per fissaggio a pavimento

ART. F AG 9204 00 99

2 tasselli "HILTI" adatti per pavimenti in calcestruzzo non fessurato maggiore uguale alla classe C20/25
Trazione consigliata del tassello: 2.9 kN
Diametro tassello: Ø 6 mm



GLI ARMADI DEVONO ESSERE SEMPRE FISSATI A PAVIMENTO O A PARETE.

ARMADI SOVRAPPosti:

-F AA 1400 + F AA 1200

OBBLIGO DI FISSAGGIO A PARETE E PORTATA DI OGNI ARMADIO DIVISA PER DUE.





24x27 EH MATERIALE DI SEPARAZIONE

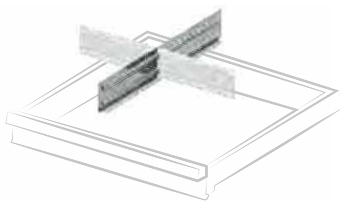

ART. Per altezze frontali mm

F FH 0050 01 00 100

set composto da: 1 divisorio longitudinale fessurato 455 mm, 2 divisori trasversali 200 mm



ART. Per altezze frontali mm

F FH 0050 02 00 100

set composto da: 2 divisorio longitudinale fessurato 455 mm, 3 divisori trasversali 132 mm

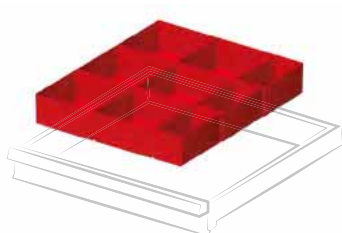

ART. Per altezze frontali mm

F FH 0050 08 00 100

set composto da: 3 cassette divisorio 150x75 mm, 6 cassette divisorio 150x150 mm

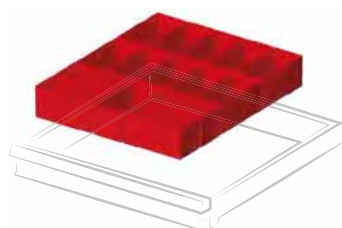

ART. Per altezze frontali mm

F FH 0050 09 00 100

set composto da: 15 cassette divisorio 150x75 mm

27x27 EH

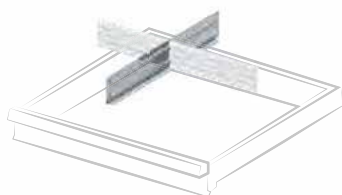

ART. Per altezze frontali mm

F FH 0100 02 00 100

set composto da: 1 divisorio longitudinale fessurato 455 mm, 1 divisorio trasversale 200 mm, 1 divisorio trasversale 251 mm

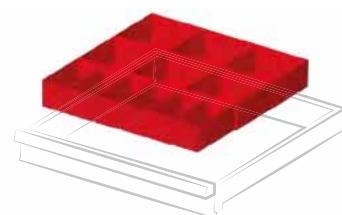

ART. Per altezze frontali mm

F FH 0100 08 00 100

set composto da: 6 cassette divisorio 150x75 mm, 6 cassette divisorio 150x150 mm

54x27 EH

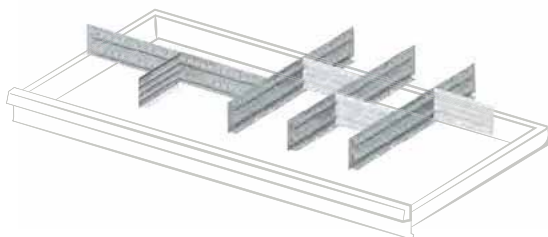

ART. Per altezze frontali mm

F FH 0200 01 00 100

set composto da: 4 divisori longitudinali fessurati 455 mm, 4 divisori trasversali 149 mm

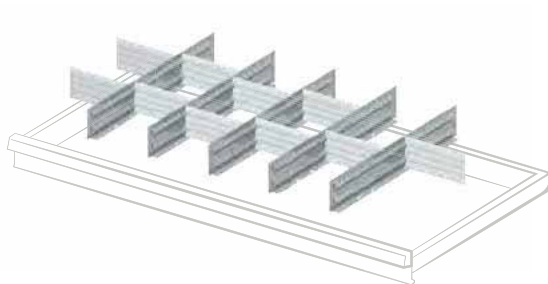

ART. Per altezze frontali mm

F FH 0200 02 00 100

set composto da: 5 divisori longitudinali fessurati 455 mm, 10 divisori trasversali 149 mm

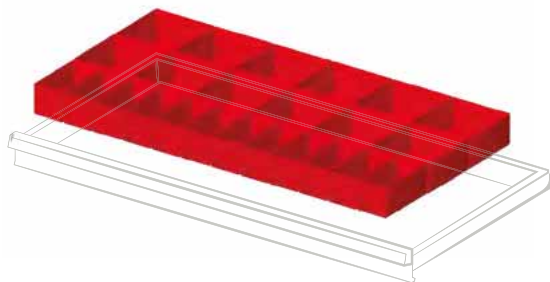

ART. Per altezze frontali mm

F FH 0200 06 00 100

set composto da: 12 cassette divisorio 150x75 mm, 12 cassette divisorio 150x150 mm

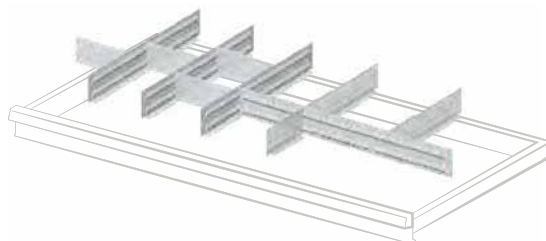

ART. Per altezze frontali mm

F FH 0250 03 00 100

set composto da: 3 divisori longitudinali fessurati 455 mm, 1 divisorio longitudinale fessurato 600 mm, 3 divisori trasversali 149 mm, 2 divisori trasversali 166 mm, 2 divisori trasversali 302 mm

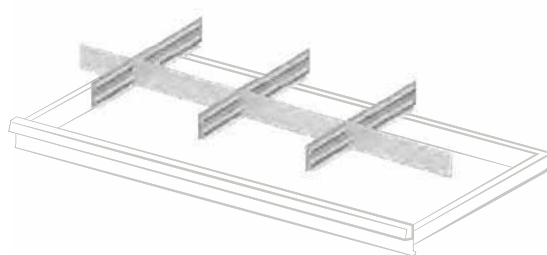

ART. Per altezze frontali mm

F FH 0250 04 00 100

set composto da: 3 divisori longitudinali fessurati 455 mm, 1 divisorio trasversale 166 mm, 3 divisori trasversali 302 mm

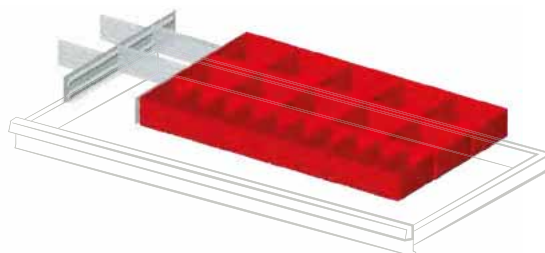

ART. Per altezze frontali mm

F FH 0250 06 00 100

set composto da: 2 divisori longitudinali fessurati 455 mm, 2 divisori trasversali 132 mm, 2 divisori trasversali 200 mm, 10 cassette divisorio 150x75 mm, 10 cassette divisorio 150x150 mm

64x27 EH





H 2000 mm



● ART. F AB 7300 01 04

H 1000 mm

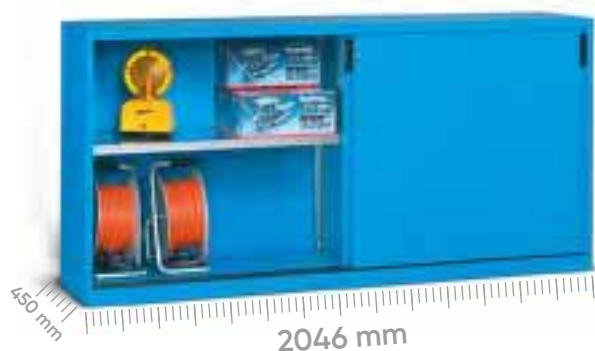

● ART. F AB 7100 02 04

Gamma colori
ACCIAIO



GRIGIO
RAL 7000
.01



VERDE
RAL 6011
.02



BLU
RAL 5012
.04



GRIGIO
RAL 7035
.08



CHIUSURA CON CHIAVE (KEY)
Fornita di serie con chiusura a cilindro e 2 chiavi

- LA PORTATA DEL PIANO SUPERIORE È DI 80 kg
- LA PORTATA DELL'ARMADIO È DI 300/400 kg PER VANO

LEGENDA



PORTATA
CASSETTO



ESTRAZIONE
CASSETTO



CHIUSURA
ARMADIO



LE PORTATE SONO NETTE E SI RIFERISCONO A PESI UNIFORMEMENTE DISTRIBUITI.

H 1000 mm



ART.



kg



● **F AB 7100 02 04**

-

-

key

2 piani regolabili ART. F AC 2450 01 99 - portata 100 kg
1 parete divisoria

H 1200 mm



ART.



kg



● **F AB 7200 53 04**

-

-

key

4 piani regolabili ART. F AC 2450 01 99 - portata 100 kg
1 parete divisoria

2 contenitori grigi PICKING BOX **mis. 2** art. FAX PB C002 A0 51 01
8 contenitori blu PICKING BOX **mis. 3** art. FAX PB C003 B0 51 04

ARMADIO SENZA CONTENITORI ART. **F AB 7200 03 04**

H 2000 mm



ART.



kg



● **F AB 7302 51 04**

-

-

key

8 piani regolabili ART. F AC 2450 01 99 - portata 100 kg
1 parete divisoria

2 contenitori grigi PICKING BOX **mis. 2** art. FAX PB C002 A0 51 01
4 contenitori blu PICKING BOX **mis. 3A2** art. FAX PB C3A2 B0 51 04
4 contenitori blu PICKING BOX **mis. 3** art. FAX PB C003 B0 51 04

ARMADIO SENZA CONTENITORI ART. **F AB 7302 01 04**

H 2000 mm



ART.



kg



● **F AB 7300 01 04**

-

-

key

8 piani regolabili ART. F AC 2450 01 99 - portata 100 kg
1 parete divisoria

CONFIGURA IL TUO ARMADIO

Gamma colori

ACCIAIO



RAL 7000

.01



RAL 6011

.02



RAL 5012

.04



RAL 7035

.08

H 1000 mm



ART.		portata per vano	
F AB 7100 01 04		300 300 kg	key

Armadio vuoto con porte e parete divisoria
Dimensioni interne di ogni vano mm 995x370x850 H

H 1200 mm



ART.		portata per vano	
F AB 7200 01 04		300 300 kg	key

Armadio vuoto con porte e parete divisoria
Dimensioni interne di ogni vano mm 995x370x1050 H

Gli armadi serie F AB 7100/7200 vengono forniti di serie con 2 staffe per il fissaggio a pavimento e 2 staffe per il fissaggio a parete.

H 2000 mm



ART.		portata per vano	
F AB 7300 00 04		400 400 kg	key

Armadio vuoto con porte e parete divisoria
Dimensioni interne di ogni vano mm 995x370x1850 H

H 2000 mm



ART.		portata per vano	
F AB 7302 00 04		400 400 kg	key

Armadio vuoto con porte in policarbonato e parete divisoria
Dimensioni interne di ogni vano mm 995x370x1850 H

Gli armadi serie F AB 7300/7302 vengono forniti di serie con 4 staffe per il fissaggio a pavimento e 4 staffe per il fissaggio a parete.





TELAIO AD ESTRAZIONE TELESCOPICA PER CARTELLE SOSPENSE DIN A4

ART.	dim. mm	portata telaio	
F AC 7400 00 07	990x370	30 kg	100%

Colore nero RAL 9005



PIANO 3 BORDI CON GOMMA

ART.	dim. mm
F AC 4450 01 07	2046x450x20 H

Piano rivestito in PVC. Colore nero
ADATTO PER ARMADIO F AB 7100 / 7200



PIANO SUPERIORE IN MDF DIM. 2046x450x31,5 mm H

ART.	rifiniture	per armadio
F UZ 3040 11 07	1 profilo laterale	finale dx o sx

Piano in MDF con copertura in gomma antiolio. Colore nero



**RIFINITURA
GOMMA
ANTIOLIO**



PIANO SUPERIORE IN MDF DIM. 2046x450x31,5 mm H

ART.	rifiniture	per armadio
F UZ 3040 12 07	-	centrale

Piano in MDF con copertura in gomma antiolio. Colore nero



**APPLICAZIONE
PIANO IN MDF**



PIANO SUPERIORE IN MDF DIM. 2046x450x31,5 mm H

ART.	rifiniture	per armadio
F UZ 3040 13 07	2 profili laterali	singolo

Piano in MDF con copertura in gomma antiolio. Colore nero



ART. F UZ 9997 00 00

FORATURA PIANO SUPERIORE DELL'ARMADIO
PER IL FISSAGGIO DEL PIANO IN MDF
COMPRESIVO DI VITI PER IL FISSAGGIO



PIANO REGOLABILE PROFONDITÀ 370 mm

ART.	dim. mm	portata piano	n. rinforzi
F AC 2450 01 99	995x370x35 H	100 kg	-
F AC 2450 03 99	995x370x35 H	150 kg	1

Zincato
Completo di 4 ganci
Adatto per contenitori PICKING BOX/STORAGE BOX:



Questo tipo di piano può essere inserito solo se non viene applicata la parete posteriore forata.



mis. 3

mis. 3A2



mis. 272-3A2



PANNELLO FORATO

ART.	dim. mm
F AC 8100 01 04	988x13x456 H

Completo di 4 staffe, 4 viti e 4 rondelle.



Questo tipo di pannello viene applicato tramite 4 staffe complete di viti all'interno dell'armadio. Si possono montare massimo 4 pannelli in altezza.

FISSAGGIO

SET FISSAGGIO TRA ARMADI

ART. F AG 9202 00 99

Set di fissaggio armadio-armadio con 4 viti complete di dadi M8

ART. F UZ 9995 00 00

Foratura e viteria per il fissaggio dei due armadi sovrapposti

SET DI FISSAGGIO A PAVIMENTO



ART. F AG 9200 00 99

Coppia staffe zincate per armadio per fissaggio a pavimento

ART. F AG 9204 00 99

2 tasselli "HILTI" adatti per pavimenti in calcestruzzo non fessurato maggiore o uguale alla classe C20/25
Trazione consigliata del tassello: 2.9 kN
Diametro tassello: Ø 6 mm



GLI ARMADI DEVONO ESSERE SEMPRE FISSATI A PAVIMENTO O A PARETE.

ARMADI SOVRAPPosti:

- F AB 7100 + F AB 7100
- F AB 7100 + F AB 7200
- F AB 7200 + F AB 7200
- F AB 7300 + F AB 7100
- F AB 7300 + F AB 7200

OBBLIGO DI FISSAGGIO A PARETE E PORTATA DI OGNI ARMADIO DIVISA PER DUE.





H 2000 mm



● ART. F AB 5300 02 04

H 1000 mm



● ART. F AB 5100 02 04

Gamma colori
ACCIAIO



GRIGIO
RAL 7000
.01



VERDE
RAL 6011
.02



BLU
RAL 5012
.04



GRIGIO
RAL 7035
.08



CHIUSURA CON CHIAVE (KEY)
Fornita di serie con chiusura a cilindro e 2 chiavi

- LA PORTATA DEL PIANO SUPERIORE È DI 80 kg
- LA PORTATA DELL'ARMADIO È DI 600/800 kg

LEGENDA



PORTATA
CASSETTO



ESTRAZIONE
CASSETTO



CHIUSURA
ARMADIO



LE PORTATE SONO NETTE E SI RIFERISCONO A PESI UNIFORMEMENTE DISTRIBUITI.

H 1000 mm



ART.		kg			
F AB 5100 02 04		-	-	key	

1 piano regolabile ART. F AC 2650 01 99 - portata 100 kg
Senza parete divisoria

H 1200 mm



ART.		kg			
F AB 5200 53 04		-	-	key	

2 piani regolabili ART. F AC 2650 01 99 - portata 100 kg
Senza parete divisoria
6 contenitori blu PICKING BOX **mis. 3** art. FAX PB C003 B0 51 04

ARMADIO SENZA CONTENITORI ART. **F AB 5200 03 04**

H 2000 mm



ART.		kg			
F AB 5302 52 04		-	-	key	

8 piani regolabili ART. F AC 2250 01 99 - portata 150 kg
1 parete divisoria
9 contenitori blu PICKING BOX **mis. 3** art. FAX PB C003 B0 51 04

ARMADIO SENZA CONTENITORI ART. **F AB 5302 02 04**

H 2000 mm



ART.		kg			
F AB 5300 02 04		-	-	key	

4 piani regolabili ART. F AC 2650 01 99 - portata 100 kg
Senza parete divisoria

CONFIGURA IL TUO ARMADIO

Gamma colori
ACCIAIO 



RAL 7000
.01



RAL 6011
.02





RAL 5012
.04



RAL 7035
.08

H 1000 mm





ART.		portata armadio	
F AB 5100 00 04		600 kg	key

Armadio vuoto con porte senza parete divisoria
Dimensioni interne di ogni vano mm 1470x370x850 H

H 1200 mm



ART.		portata armadio	
F AB 5200 00 04		600 kg	key

Armadio vuoto con porte senza parete divisoria
Dimensioni interne di ogni vano mm 1470x370x1050 H

H 2000 mm



ART.		portata armadio	
F AB 5300 00 04		800 kg	key

Armadio vuoto con porte senza parete divisoria
Dimensioni interne di ogni vano mm 1470x370x1850 H

H 2000 mm



ART.		portata armadio	
F AB 5302 00 04		800 kg	key

Armadio vuoto con porte in policarbonato senza parete divisoria
Dimensioni interne di ogni vano mm 1470x370x1850 H



TUTTI GLI ARMADI SONO FORNITI DI SERIE CON 2 STAFFE PER IL FISSAGGIO A PAVIMENTO E 2 STAFFE PER IL FISSAGGIO A PARETE.



PIANO 3 BORDI CON GOMMA

ART.	dim. mm	
F AC 4350 01 07	1500x450x20 H	

Piano rivestito in PVC. Colore nero
ADATTO PER ARMADIO F AB 5100 / 5200



PIANO SUPERIORE IN MDF DIM.1500x450x31,5 mm H

ART.	rifiniture	per armadio
F UZ 3030 11 07	1 profilo laterale	finale dx o sx

Piano in MDF con copertura in gomma antiolio. Colore nero



PIANO SUPERIORE IN MDF DIM. 1500x450x31,5 mm H

ART.	rifiniture	per armadio
F UZ 3030 12 07	-	centrale

Piano in MDF con copertura in gomma antiolio. Colore nero



**RIFINITURA
GOMMA
ANTIOLIO**



PIANO SUPERIORE IN MDF DIM. 1500x450x31,5 mm H

ART.	rifiniture	per armadio
F UZ 3030 13 07	2 profili laterali	singolo

Piano in MDF con copertura in gomma antiolio. Colore nero



**APPLICAZIONE
PIANO IN MDF**



ART. F UZ 9998 00 00

FORATURA PIANO SUPERIORE DELL'ARMADIO
PER IL FISSAGGIO DEL PIANO IN MDF
COMPRESIVO DI VITI PER IL FISSAGGIO

PIANO REGOLABILE PROFONDITÀ 370 mm

ART.	dim. mm	portata piano	
F AC 2650 01 99	1470x370x35 H	100 kg	

Zincato
Completo di 4 ganci
Adatto per contenitori PICKING BOX/STORAGE BOX:



Questo tipo di piano può essere inserito solo se non viene applicata la parete divisoria.

PIANO REGOLABILE PROFONDITÀ 370 mm

ART.	dim. mm	portata piano	
F AC 2250 01 99	722x370x35 H	150 kg	

Zincato
Completo di 4 ganci
Adatto per contenitori PICKING BOX/STORAGE BOX:



Questo tipo di piano può essere inserito solo quando viene applicata la parete divisoria.

PARETE DIVISORIA PER ARMADI

ART.		per armadio mm	
F AC 3100 00 99	A	450x1000 H	
F AC 3200 00 99	B	450x1200 H	
F AC 3300 00 99	C	450x2000 H	

La parete divisoria non può essere ordinata separatamente dall'armadio.
La portata di ogni vano sarà la metà della portata dell'armadio.

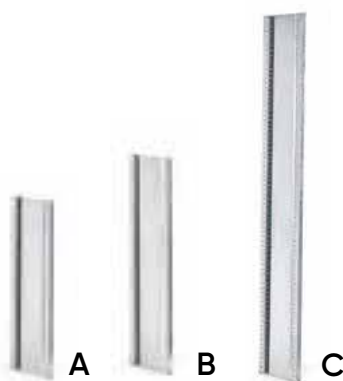

FISSAGGIO

SET FISSAGGIO TRA ARMADI

ART. F AG 9202 00 99

Set di fissaggio armadio-armadio con 4 viti complete di dadi M8

ART. F UZ 9995 00 00

Foratura e viteria per il fissaggio dei due armadi sovrapposti

SET DI FISSAGGIO A PAVIMENTO



ART. F AG 9200 00 99

Coppia staffe zincate per armadio per fissaggio a pavimento

ART. F AG 9204 00 99

2 tasselli "HILTI" adatti per pavimenti in calcestruzzo non fessurato maggiore o uguale alla classe C20/25
Trazione consigliata del tassello: 2,9 kN
Diametro tassello: Ø 6 mm



GLI ARMADI DEVONO ESSERE SEMPRE FISSATI A PAVIMENTO O A PARETE.

ARMADI SOVRAPPosti:

- F AB 5100 + F AB 5100
- F AB 5100 + F AB 5200
- F AB 5200 + F AB 5200
- F AB 5300 + F AB 5100
- F AB 5300 + F AB 5200

OBBLIGO DI FISSAGGIO A PARETE E PORTATA DI OGNI ARMADIO DIVISA PER DUE.

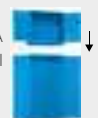



H 2000 mm



● ART. F AB 3300 04 04

H 1000 mm



● ART. F AB 3100 01 04

Gamma colori
ACCIAIO



GRIGIO
RAL 7000
.01



VERDE
RAL 6011
.02



BLU
RAL 5012
.04



GRIGIO
RAL 7035
.08



CHIUSURA CON CHIAVE (KEY)
Fornita di serie con chiusura a cilindro e 2 chiavi

- LA PORTATA DEL PIANO SUPERIORE È DI 80 kg
- LA PORTATA DELL'ARMADIO È DI 600/800 kg

LEGENDA



PORTATA
CASSETTO



ESTRAZIONE
CASSETTO



CHIUSURA
ARMADIO



LE PORTATE SONO NETTE E SI RIFERISCONO A PESI UNIFORMEMENTE DISTRIBUITI.

H 1000 mm



ART.		kg		
● F AB 3100 01 04		-	-	key

1 piano regolabile ART. F AC 2450 01 99 - portata 100 kg

H 1200 mm



ART.		kg		
F AB 3200 02 04		-	-	key

2 piani regolabili ART. F AC 2450 01 99 - portata 100 kg

H 2000 mm



ART.		kg		
F AB 3300 01 04		-	-	key

4 piani regolabili ART. F AC 2450 01 99 - portata 150 kg

H 2000 mm



ART.		kg		
F AB 3300 03 04		-	-	key

5 piani regolabili ART. F AC 2450 01 99 - portata 100 kg

H 2000 mm



ART.		kg		
● F AB 3300 04 04		-	-	key

6 piani regolabili ART. F AC 2450 01 99 - portata 100 kg

CONFIGURA IL TUO ARMADIO

Gamma colori
ACCIAIO 



RAL 7000
.01



RAL 6011
.02



RAL 5012
.04



RAL 7035
.08

H 1000 mm



ART.		portata armadio	
F AB 3100 00 04		600 kg	key

Armadio vuoto con porte
Dimensioni interne mm 995x370x850 H

H 1200 mm





ART.		portata armadio	
F AB 3200 00 04		600 kg	key

Armadio vuoto con porte
Dimensioni interne mm 995x370x1050 H

H 2000 mm



ART.		portata armadio	
F AB 3300 00 04		800 kg	key

Armadio vuoto con porte
Dimensioni interne mm 995x370x1850 H



TUTTI GLI ARMADI SONO FORNITI DI SERIE CON 2 STAFFE PER IL FISSAGGIO A PAVIMENTO E 2 STAFFE PER IL FISSAGGIO A PARETE.

PIANO 3 BORDI CON GOMMA



ART.	dim. mm	
F AC 4150 01 07	1023x450x20 H	

Piano rivestito in PVC. Colore nero

ADATTO PER ARMADIO F AB 3100 / 3200

PIANO SUPERIORE IN MDF DIM. 1023x450x31,5 mm H



ART.	rifiniture	per armadio	
F UZ 3010 11 07	1 profilo laterale	finale dx o sx	

Piano in MDF con copertura in gomma antiolio. Colore nero



**RIFINITURA
GOMMA
ANTIOLIO**

PIANO SUPERIORE IN MDF DIM. 1023x450x31,5 mm H



ART.	rifiniture	per armadio	
F UZ 3010 12 07	-	centrale	

Piano in MDF con copertura in gomma antiolio. Colore nero



**APPLICAZIONE
PIANO IN MDF**

PIANO SUPERIORE IN MDF DIM. 1023x450x31,5 mm H



ART.	rifiniture	per armadio	
F UZ 3010 13 07	2 profili laterali	singolo	

Piano in MDF con copertura in gomma antiolio. Colore nero



ART. F UZ 9999 00 00

FORATURA PIANO SUPERIORE DELL'ARMADIO
PER IL FISSAGGIO DEL PIANO IN MDF
COMPRESIVO DI VITI PER IL FISSAGGIO



PIANO REGOLABILE PROFONDITÀ 370 mm

ART.	dim. mm	portata piano	n. rinforzi
F AC 2450 01 99	995x370x35 H	100 kg	-
F AC 2450 03 99	995x370x35 H	150 kg	1

Zincato

Completo di 4 ganci.

Adatto per contenitori PICKING BOX/STORAGE BOX:



Questo tipo di piano può essere inserito solo se non viene applicata la parete posteriore forata.



mis. 3

mis. 3A2



mis. 272-3A2



PANNELLO FORATO

ART.	dim. mm	portata pannello
F AC 8100 01 04	988x13x456 H	25 kg

Completo di 4 staffe, 4 viti e 4 rondelle

Questo tipo di pannello viene applicato tramite 4 staffe complete di viti all'interno dell'armadio. si possono montare massimo 4 pannelli in altezza.

FISSAGGIO

SET FISSAGGIO TRA ARMADI

ART. F AG 9202 00 99

Set di fissaggio armadio-armadio con 4 viti complete di dadi M8

ART. F UZ 9995 00 00

Foratura e viteria per il fissaggio dei due armadi sovrapposti

SET DI FISSAGGIO A PAVIMENTO



ART. F AG 9200 00 99

Coppia staffe zincate per armadio per fissaggio a pavimento

ART. F AG 9204 00 99

2 tasselli "HILTI" adatti per pavimenti in calcestruzzo non fessurato maggiore o uguale alla classe C20/25
Trazione consigliata del tassello: 2.9 kN
Diametro tassello: Ø 6 mm



GLI ARMADI DEVONO ESSERE SEMPRE FISSATI A PAVIMENTO O A PARETE.

ARMADI SOVRAPPosti:

- F AB 3100 + F AB 3100
- F AB 3100 + F AB 3200
- F AB 3200 + F AB 3200
- F AB 3300 + F AB 3100
- F AB 3300 + F AB 3200

OBBLIGO DI FISSAGGIO A PARETE E PORTATA DI OGNI ARMADIO DIVISA PER DUE.





H 2000 mm



● ART. F AB 8300 02 04

H 1000 mm



● ART. F AB 8100 10 04

Gamma colori
ACCIAIO



GRIGIO
RAL 7000
.01



VERDE
RAL 6011
.02



BLU
RAL 5012
.04



GRIGIO
RAL 7035
.08



CHIUSURA CON CHIAVE (KEY)
Fornita di serie, negli armadi la chiusura con cilindro

- LA PORTATA DEL PIANO SUPERIORE È DI 80 kg
- LA PORTATA DELL'ARMADIO È DI 600/800 kg
PER VANO

LEGENDA



PORTATA
CASSETTO



ESTRAZIONE
CASSETTO



CHIUSURA
ARMADIO



LE PORTATE SONO NETTE E SI RIFERISCONO A PESI UNIFORMEMENTE DISTRIBUITI.

H 1000 mm



2x100

ART.				
F AB 8100 08 04		50	87%	key

2 piani regolabili ART. F AC 2500 01 99 - portata 100 kg
2 cassette (54x27 EH)
1 parete divisoria

H 1000 mm



ART.				
F AB 8100 10 04		-	87%	key

2 piani regolabili ART. F AC 2500 01 99 - portata 100 kg
1 parete divisoria



H 2000 mm



ART.				
F AB 8300 01 04	-	-	-	key

8 piani regolabili ART. F AC 2500 01 99 - portata 100 kg

H 2000 mm



ART.				
F AB 8300 02 04	50	87%	key	

4 piani regolabili ART. F AC 2500 01 99 - portata 100 kg
4 cassetti (54x27 EH)
1 parete divisoria

H 2000 mm



ART.				
F AB 8300 09 04	50	87%	key	

8 piani regolabili ART. F AC 2500 01 99- portata 100 kg
6 cassetti (54x27 EH)
1 parete divisoria

H 2000 mm



ART.				
F AB 8302 01 04	-	-	key	

8 piani regolabili ART. F AC 2500 01 99 - portata 100 kg
1 parete divisoria



CONFIGURA IL TUO ARMADIO

Gamma colori
ACCIAIO

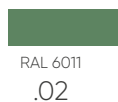
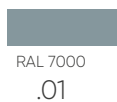

H 1000 mm



ART.		portata per vano	
F AB 8100 01 04		600 600 kg	key

Armadio vuoto con porte e parete divisoria
Dimensioni interne mm 995x500x850 H



Gli armadi serie F AB 8100 vengono forniti di serie con 2 staffe per il fissaggio a pavimento e 2 staffe per il fissaggio a parete.

H 2000 mm



ART.		portata per vano	
F AB 8300 00 04		800 800 kg	key

Armadio vuoto con porte e parete divisoria
Dimensioni interne mm 995x500x1850 H

H 2000 mm



ART.		portata per vano	
F AB 8302 00 04		800 800 kg	key



Armadio vuoto con porte in policarbonato e parete divisoria
Dimensioni interne mm 995x500x1850 H



Gli armadi serie F AB 8300/ 8302 vengono forniti di serie con 4 staffe per il fissaggio a pavimento e 4 staffe per il fissaggio a parete.





COPPIA CASSETTI AD ESTRAZIONE SEMPLICE E TELESCOPICA 24X27 EH

ART.		dim. utili mm		
F AC 1600 00 04*		396x447x85 H	50 kg	87%
F AC 1650 00 04*		396x447x85 H	60 kg	100%

*Le dimensioni si riferiscono ad un cassetto



CASSETTI AD ESTRAZIONE SEMPLICE E TELESCOPICA 54X27 EH

ART.		dim. utili mm		
F AC 1200 00 04		906x447x85 H	50 kg	87%
F AC 1250 00 04		906x447x85 H	100 kg	100%

 Il limite massimo di portata dei cassetti inseriti nell'armadio è di 350 kg indipendentemente dalla portata dell'armadio



Se negli armadi vengono inseriti uno o più cassetti è obbligatorio fissare l'armadio al pavimento o alla parete (se i cassetti vengono inseriti a un'altezza maggiore di 1000 mm da terra l'utilizzatore è obbligato a scegliere solamente il fissaggio a parete)



TELAIO AD ESTRAZIONE TELESCOPICA PER CARTELLE SOSPESSE DIN A4

ART.	dim. mm	portata telaio	
F AC 7500 00 07	990x500	30 kg	100%

Colore nero RAL 9005



PIANO 3 BORDI CON GOMMA

ART.	dim. mm	
F AC 4500 01 07	2046x600x20 H	

Piano rivestito in PVC. Colore nero

ADATTO PER ARMADIO F AB 8100



PIANO SUPERIORE IN MDF DIM. 2046x600x31,5 mm H

ART.	rifiniture	per armadio	
F UZ 3170 11 07	1 profilo laterale	finale dx o sx	

Piano in MDF con copertura in gomma antiolio. Colore nero



**RIFINITURA
GOMMA
ANTIOLIO**



PIANO SUPERIORE IN MDF DIM. 2046x600x31,5 mm H

ART.	rifiniture	per armadio	
F UZ 3170 12 07	-	centrale	

Piano in MDF con copertura in gomma antiolio. Colore nero



**APPLICAZIONE
PIANO IN MDF**



PIANO SUPERIORE IN MDF DIM. 2046x600x31,5 mm H

ART.	rifiniture	per armadio	
F UZ 3170 13 07	2 profili laterali	singolo	

Piano in MDF con copertura in gomma antiolio. Colore nero



ART. F UZ 9997 00 00

FORATURA PIANO SUPERIORE DELL'ARMADIO
PER IL FISSAGGIO DEL PIANO IN MDF
COMPRESIVO DI VITI PER IL FISSAGGIO



PIANO REGOLABILE PROFONDITÀ 500 mm

ART.	dim. mm	portata piano	n. rinforzi
F AC 2500 01 99	995x500x35 H	100 kg	-
F AC 2500 03 99*	995x500x35 H	180 kg	1

Zincato

*Non si possono inserire i contenitori serie RK BOX sui piani con un rinforzo
Completo di 4 ganci.

Adatto per contenitori PICKING BOX/STORAGE BOX:



Questo tipo di piano può essere inserito solo se non viene applicata la parete posteriore forata.



PIANO REGOLABILE PROFONDITÀ 480 mm

ART.	dim. mm	portata piano
F AC 2480 07 99	995x480x35 H	50 kg

Zincato

Adatto per contenitori PICKING BOX/STORAGE BOX:



Questo tipo di piano può essere inserito anche quando viene applicata la parete posteriore forata.



PANNELLO FORATO

ART.	dim. mm	portata piano
F AC 8100 01 04	988x13x456 H	25 kg

Completo di 4 staffe, 4 viti, 4 rondelle



Questo tipo di pannello viene applicato tramite 4 staffe complete di viti all'interno dell'armadio. Si possono montare massimo 4 pannelli in altezza.

FISSAGGIO

SET FISSAGGIO TRA ARMADI

ART. F AG 9202 00 99

Set di fissaggio armadio-armadio con 4 viti complete di dadi M8

ART. F UZ 9995 00 00

Foratura e viteria per il fissaggio dei due armadi sovrapposti

SET DI FISSAGGIO A PAVIMENTO



ART. F AG 9200 00 99

Coppia staffe zincate per armadio per fissaggio a pavimento

ART. F AG 9204 00 99

2 tasselli "HILT!" adatti per pavimenti in calcestruzzo non fessurato maggiore o uguale alla classe C20/25
Trazione consigliata del tassello: 2,9 kN
Diametro tassello: Ø 6 mm



GLI ARMADI DEVONO ESSERE SEMPRE FISSATI A PAVIMENTO O A PARETE.

ARMADI SOVRAPPosti:

-F AB 8100 + F AB 8100
-F AB 8300 + F AB 8100

OBBLIGO DI FISSAGGIO A PARETE E PORTATA DI OGNI ARMADIO DIVISA PER DUE.



H 2000 mm



● ART. F AB 6300 02 04

H 1000 mm



● ART. F AB 6100 02 04

Gamma colori
ACCIAIO



GRIGIO
RAL 7000
.01



VERDE
RAL 6011
.02



BLU
RAL 5012
.04



GRIGIO
RAL 7035
.08



CHIUSURA CON CHIAVE (KEY)
Fornita di serie con chiusura a cilindro e 2 chiavi

- LA PORTATA DEL PIANO SUPERIORE È DI 80 kg
- LA PORTATA DELL'ARMADIO È DI 600/800 kg

LEGENDA



PORTATA
CASSETTO



ESTRAZIONE
CASSETTO



CHIUSURA
ARMADIO



LE PORTATE SONO NETTE E SI RIFERISCONO A PESI UNIFORMEMENTE DISTRIBUITI.

H 1000 mm



ART.				
F AB 6100 02 04	-	-	-	key

1 piano regolabile ART. F AC 2700 01 99 - portata 100 kg
senza parete divisoria

H 1000 mm



ART.				
F AB 6100 05 04	-	-	-	key

2 piani regolabili ART. F AC 2300 01 99 - portata 150 kg
1 parete divisoria

H 2000 mm



ART.				
F AB 6300 02 04	-	-	-	key

4 piani regolabili ART. F AC 2700 01 99 - portata 100 kg
senza parete divisoria

H 2000 mm



ART.				
F AB 6302 52 04	-	-	-	key

8 piani regolabili ART. F AC 2300 01 99 - portata 150 kg
1 parete divisoria
5 contenitori grigi PICKING BOX **mis.4** art. FAX PB C004 B0 51 01

ARMADIO SENZA CONTENITORI ART. **F AB 6302 02 04**

CONFIGURA IL TUO ARMADIO

Gamma colori
ACCIAIO



RAL 7000
.01



RAL 6011
.02



RAL 5012
.04



RAL 7035
.08

H 1000 mm





ART.		portata armadio	
F AB 6100 00 04		600 kg	key

Armadio vuoto con porte senza parete divisoria
Dimensioni interne mm 1470x500x850 H

H 2000 mm





ART.		portata armadio	
F AB 6300 00 04		800 kg	key

Armadio vuoto con porte senza parete divisoria
Dimensioni interne mm 1470x500x1850 H

H 2000 mm



ART.		portata armadio	
F AB 6302 00 04		800 kg	key

Armadio vuoto con porte in policarbonato senza parete divisoria
Dimensioni interne mm 1470x500x1850 H



TUTTI GLI ARMADI SONO FORNITI DI SERIE CON 2 STAFFE PER IL FISSAGGIO A PAVIMENTO E 2 STAFFE PER IL FISSAGGIO A PARETE.



PIANO 3 BORDI CON GOMMA

ART.	dim. mm	
F AC 4400 01 07	1500x600x20 H	

Piano rivestito in PVC. Colore nero

ADATTO PER ARMADIO F AB 6100



PIANO SUPERIORE IN MDF DIM. 1500x600x31,5 mm H

ART.	rifiniture	per armadio	
F UZ 3160 11 07	1 profilo laterale	finale dx o sx	

Piano in MDF con copertura in gomma antiolio. Colore nero



PIANO SUPERIORE IN MDF DIM. 1500x600x31,5 mm H

ART.	rifiniture	per armadio	
F UZ 3160 12 07	-	centrale	

Piano in MDF con copertura in gomma antiolio. Colore nero



**RIFINITURA
GOMMA
ANTIOLIO**



PIANO SUPERIORE IN MDF DIM. 1500x600x31,5 mm H

ART.	rifiniture	per armadio	
F UZ 3160 13 07	2 profili laterali	singolo	

Piano in MDF con copertura in gomma antiolio. Colore nero



**APPLICAZIONE
PIANO IN MDF**



ART. F UZ 9998 00 00

FORATURA PIANO SUPERIORE DELL'ARMADIO
PER IL FISSAGGIO DEL PIANO IN MDF
COMPRESIVO DI VITI PER IL FISSAGGIO



PARETE DIVISORIA PER ARMADI

ART.		per armadio mm	
F AC 3500 00 99	A	600x1000 H	
F AC 3600 00 99	B	600x2000 H	

Zincato

La parete divisoria non può essere ordinata separatamente dall'armadio.
La portata di ogni vano sarà la metà della portata dell'armadio.



PIANO REGOLABILE PROFONDITÀ 500 mm

ART.	dim. mm	portata piano
F AC 2700 01 99	1470x500x35 H	100 kg

Zincato

Completo di 4 ganci.

Adatto per contenitori PICKING BOX/STORAGE BOX:



mis. 4A2

mis. 4

mis. 4A5



mis. 272-4A2

mis. 272-4

mis. 272-4A5

Questo tipo di piano può essere inserito solo se non viene applicata la parete divisoria.



PIANO REGOLABILE PROFONDITA' 500 mm

ART.	dim. mm	portata piano
F AC 2300 01 99	722x500x35 H	150 kg

Zincato

Completo di 4 ganci.

Adatto per contenitori PICKING BOX/STORAGE BOX:



mis. 4A2

mis. 4

mis. 4A5



mis. 272-4A2

mis. 272-4

mis. 272-4A5

Questo tipo di piano può essere inserito solo quando viene applicata la parete divisoria.

FISSAGGIO

SET FISSAGGIO TRA ARMADI

ART. F AG 9202 00 99

Set di fissaggio armadio-armadio con 4 viti complete di dadi M8

ART. F UZ 9995 00 00

Foratura e viteria per il fissaggio dei due armadi sovrapposti

SET DI FISSAGGIO A PAVIMENTO



ART. F AG 9200 00 99

Coppia staffe zincate per armadio per fissaggio a pavimento

ART. F AG 9204 00 99

2 tasselli "HILTI" adatti per pavimenti in calcestruzzo non fessurato maggiore o uguale alla classe C20/25

Trazione consigliata del tassello: 2,9 kN

Diametro tassello: Ø 6 mm



GLI ARMADI DEVONO ESSERE SEMPRE FISSATI A PAVIMENTO O A PARETE.

ARMADI SOVRAPPosti:

-F AB 6100 + F AB 6100
-F AB 6300 + F AB 6100

OBBLIGO DI FISSAGGIO A PARETE E PORTATA DI OGNI ARMADIO DIVISA PER DUE.





H 2000 mm



● ART. F AB 4300 11 04

H 1000 mm



● ART. F AB 4100 02 04

Gamma colori
ACCIAIO



GRIGIO
RAL 7000
.01



VERDE
RAL 6011
.02



BLU
RAL 5012
.04



GRIGIO
RAL 7035
.08



CHIUSURA CON CHIAVE (KEY)
Fornita di serie con chiusura a cilindro e 2 chiavi

- LA PORTATA DEL PIANO SUPERIORE È DI 80 kg
- LA PORTATA DELL'ARMADIO È DI 600/800 kg

LEGENDA



PORTATA
CASSETTO



ESTRAZIONE
CASSETTO



CHIUSURA
ARMADIO



LE PORTATE SONO NETTE E SI RIFERISCONO A PESI UNIFORMEMENTE DISTRIBUITI.

H 1000 mm



ART.				
F AB 4100 02 04		50	87%	key

1 piano regolabile ART. F AC 2100 01 99 - portata 100 kg
2 cassetti (24x27 EH)
1 parete divisoria

H 1000 mm



ART.				
F AB 4100 07 04		-	-	key

1 piano regolabile ART. F AC 2500 01 99 - portata 100 kg
senza parete divisoria

H 2000 mm



ART.				
F AB 4300 09 04		50	-	key

8 piani regolabili ART. F AC 2100 01 99 - portata 100 kg
4 cassetti (24x27 EH)
1 parete divisoria

H 2000 mm



ART.				
F AB 4300 11 04		-	-	key

4 piani regolabili ART. F AC 2500 01 99 - portata 100 kg
senza parete divisoria

CONFIGURA IL TUO ARMADIO

Gamma colori
ACCIAIO 

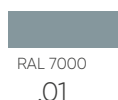

H 1000 mm



ART.		portata armadio	
F AB 4100 00 04		600 kg	key

Armadio vuoto con coppia porte senza parete divisoria
Dimensioni interne mm 995x500x850 H

H 2000 mm



ART.		portata armadio	
F AB 4300 00 04		800 kg	key

Armadio vuoto con coppia porte senza parete divisoria
Dimensioni interne mm 995x500x1850 H



TUTTI GLI ARMADI SONO FORNITI DI SERIE CON 2 STAFFE PER IL FISSAGGIO A PAVIMENTO E 2 STAFFE PER IL FISSAGGIO A PARETE.



PARETE DIVISORIA PER ARMADI

ART.		per armadio mm
F AC 3150 00 99	A	600x1000 H
F AC 3350 00 99	B	600x2000 H

Zincato

La parete divisoria non può essere ordinata separatamente dall'armadio.
La portata di ogni vano sarà la metà della portata dell'armadio.

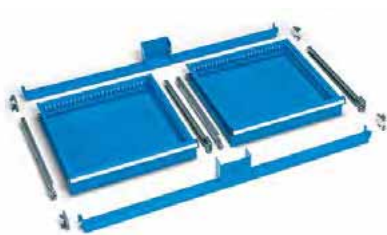

COPPIA CASSETTI AD ESTRAZIONE SEMPLICE E TELESCOPICA 24X27 EH

ART.		dim. utili mm	kg	
F AC 1600 00 04		396x447x85 H *	50 kg	87%
F AC 1650 00 04		396x447x85 H *	60 kg	100%

*Le dimensioni si riferiscono ad un cassetto



CASSETTI AD ESTRAZIONE SEMPLICE E TELESCOPICA 24X27 EH

ART.		dim. utili mm	kg	
F AC 1100 00 04		396x447x85 H	50 kg	87%
F AC 1150 00 04		396x447x85 H	100 kg	100%



Il limite massimo di portata dei cassetti inseriti nell'armadio è di 200 kg indipendentemente dalla portata dell'armadio



Se negli armadi vengono inseriti uno o più cassetti è obbligatorio fissare l'armadio al pavimento o alla parete (se i cassetti vengono inseriti a un'altezza maggiore di 1000 mm da terra l'utilizzatore è obbligato a scegliere solamente il fissaggio a parete)



PIANO 3 BORDI CON GOMMA

ART.	dim. mm
F AC 4250 01 07	1023x600x20 H

Piano rivestito in PVC. Colore nero

ADATTO PER ARMADIO F AB 4100



PIANO SUPERIORE IN MDF DIM. 1023x600x31,5 mm H

ART.	rifiniture	per armadio	
F UZ 3140 11 07	1 profilo laterale	finale dx o sx	

Piano in MDF con copertura in gomma antiolio. Colore nero



PIANO SUPERIORE IN MDF DIM. 1023x600x31,5 mm H

ART.	rifiniture	per armadio	
F UZ 3140 12 07	-	centrale	

Piano in MDF con copertura in gomma antiolio. Colore nero



**RIFINITURA
GOMMA
ANTIOLIO**



PIANO SUPERIORE IN MDF DIM. 1023x600x31,5 mm H

ART.	rifiniture	per armadio	
F UZ 3140 13 07	2 profili laterali	singolo	

Piano in MDF con copertura in gomma antiolio. Colore nero



**APPLICAZIONE
PIANO IN MDF**



ART. F UZ 9999 00 00

FORATURA PIANO SUPERIORE DELL'ARMADIO
PER IL FISSAGGIO DEL PIANO IN MDF
COMPRESIVO DI VITI PER IL FISSAGGIO



PIANO REGOLABILE PROFONDITA' 500 mm

ART.	dim. mm	portata piano	
F AC 2100 01 99	483x500x35 H	100 kg	

Zincato

Completo di 4 ganci

Adatto per contenitori PICKING BOX/STORAGE BOX:



mis. 4A2

mis. 4

mis. 4A5



mis. 272-4A2

mis. 272-4

mis. 272-4A5

Questo tipo di piano può essere inserito solo quando viene applicata la parete divisorio.



PIANO REGOLABILE PROFONDITÀ 500 mm

ART.	dim. mm	n. rinforzi	portata piano
F AC 2500 01 99	995x500x35 H	-	100 kg
F AC 2500 03 99*	995x500x35 H	1	180 kg

Zincato

Completo di 4 ganci

*Non si possono inserire i contenitori serie RK BOX sui piani con un rinforzo

Adatto per contenitori PICKING BOX/STORAGE BOX:



mis. 4A2

mis. 4

mis. 4A5



mis. 272-4A2

mis. 272-4

mis. 272-4A5

Questo tipo di piano può essere inserito quando non viene applicata la parete posteriore forata e non viene applicata la parete divisoria.



PIANO REGOLABILE PROFONDITÀ 480 mm

ART.	dim. mm	portata piano
F AC 2480 07 99	995x480x35 H	50 kg

Zincato

Adatto per contenitori PICKING BOX/STORAGE BOX:



mis. 4A2

mis. 4

mis. 4A5



mis. 272-4A2

mis. 272-4

mis. 272-4A5

Questo tipo di piano può essere inserito quando viene applicata la parete posteriore forata senza la parete divisoria.



PANNELLO FORATO

ART.	dim. mm	portata pannello
F AC 8100 01 04	988x13x456 H	25 kg

Completo di 4 staffe, 4 viti, 4 rondelle

Non adatto per le porte.

Questo tipo di pannello viene applicato tramite 4 staffe complete di viti all'interno dell'armadio. Si possono montare massimo 4 pannelli in altezza.

FISSAGGIO

SET FISSAGGIO TRA ARMADI

ART. F AG 9202 00 99

Set di fissaggio armadio-armadio con 4 viti complete di dadi M8

ART. F UZ 9995 00 00

Foratura e viteria per il fissaggio dei due armadi sovrapposti

SET DI FISSAGGIO A PAVIMENTO



ART. F AG 9200 00 99

Coppia staffe zincate per armadio per fissaggio a pavimento

ART. F AG 9204 00 99

2 tasselli "HILTI" adatti per pavimenti in calcestruzzo non fessurato maggiore o uguale alla classe C20/25
Trazione consigliata del tassello: 2,9 kN
Diametro tassello: Ø 6 mm



GLI ARMADI DEVONO ESSERE SEMPRE FISSATI A PAVIMENTO O A PARETE.

ARMADI SOVRAPPosti:

-F AB 4100 + F AB 4100
-F AB 4300 + F AB 4100

OBBLIGO DI FISSAGGIO A PARETE E PORTATA DI OGNI ARMADIO DIVISA PER DUE.







**LA ROBUSTA LAMIERA
D'ACCIAIO
SI FA DESIGN
NELL'AMBIENTE DI LAVORO**

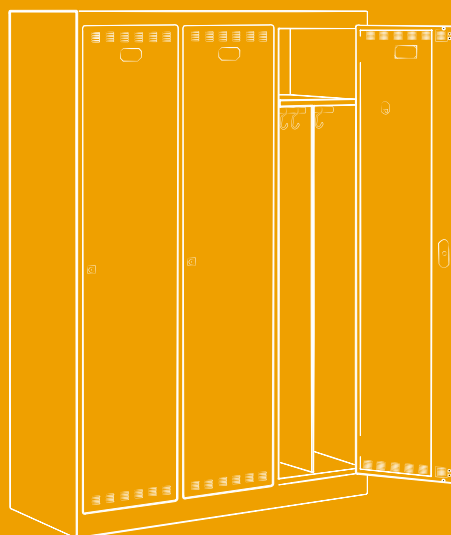



Per gentile concessione di Stilo Optical Technology Italy SRL

PERFOM GS/FS

CARATTERISTICHE TECNICHE

Gamma colori
ACCIAIO



RAL 7035
.08



ARMADI SPOGLIATOIO

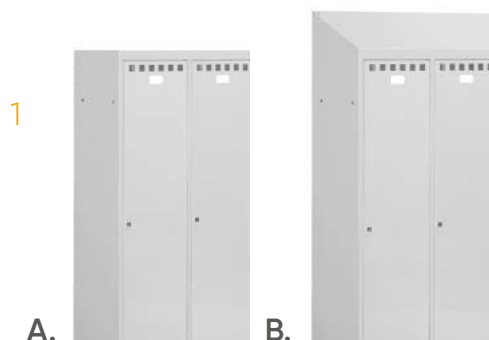

Gli armadi spogliatoio FAMI possono essere forniti con tetto orizzontale (A) oppure con tetto a spiovente (B). Il tetto a spiovente facilita la pulizia dello stesso ed è consigliato in ambienti con obblighi di igiene molto accurata.

- 2 Le porte vengono fornite con un comodo appendino adesivo



- 3 I vani degli armadi possono essere di tre differenti larghezze (300 mm, 400 mm, 585 mm) mentre la profondità è di 500 mm. I vani sono sempre corredati di un piano d'appoggio zincato il quale, in alcune configurazioni, può essere regolato in altezza per ospitare il casco. La parte sottostante al piano può essere fornita con parete intermedia, adatto a dividere le zone sporco/pulito.



- 4 Le porte possono essere fornite con chiusura a cilindro con due chiavi oppure con pomolo lucchettabile (lucchetto escluso).



CHIUSURA A CILINDRO

5



Le porte vengono fornite con un vano porta etichetta per l'identificazione personale. Sia le porte che la parete posteriore presentano una serie di fessure che favoriscono la circolazione dell'aria.

6



Tra gli accessori, per evitare il contatto con il pavimento, è possibile scegliere tra: piedini in polipropilene (molto resistenti al contatto con l'acqua), zoccoli in acciaio zincato, panche monofronti e bifronti, appoggia scarpe.

PERFOM GS130

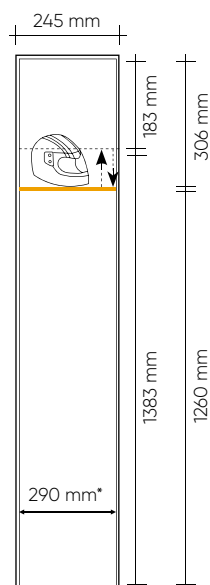



*Spazio utile interno



Esempio a 4 scomparti

▶ Armadio con piano regolabile in altezza per casco.



ARMADIO CON SERRATURA A CILINDRO

ART.		dim. mm	n. scomparti		piedini
F AN 1301 01 08		316x500x1750 H	1	key	NO
F AN 1302 01 08		610x500x1750 H	2	key	NO
F AN 1303 01 08		900x500x1750 H	3	key	NO
F AN 1304 01 08		1195x500x1750 H	4	key	NO
F AN 1301 07 08		316x500x1950 H	1	key	SI
F AN 1302 07 08		610x500x1950 H	2	key	SI
F AN 1303 07 08		900x500x1950 H	3	key	SI
F AN 1304 07 08		1195x500x1950 H	4	key	SI



**ARMADIO
PORTA CASCO**

ARMADIO CON SERRATURA LUCCHETTABILE

ART.		dim. mm	n. scomparti		piedini
F AN 1301 11 08		316x500x1750 H	1	-	NO
F AN 1302 11 08		610x500x1750 H	2	-	NO
F AN 1303 11 08		900x500x1750 H	3	-	NO
F AN 1304 11 08		1195x500x1750 H	4	-	NO
F AN 1301 17 08		316x500x1950 H	1	-	SI
F AN 1302 17 08		610x500x1950 H	2	-	SI
F AN 1303 17 08		900x500x1950 H	3	-	SI
F AN 1304 17 08		1195x500x1950 H	4	-	SI



Esempio di piedino applicato all'armadio.



Esempio a 4 scomparti

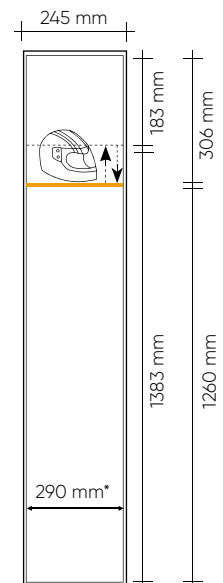

▶ Armadio con piano regolabile in altezza per casco.

TETTO INCLINATO



*Spazio utile interno



ARMADIO CON SERRATURA A CILINDRO

ART.		dim. mm	n. scomparti		pedini
F AN 2302 01 08		610x500x1940 H	2	key	NO
F AN 2303 01 08		900x500x1940 H	3	key	NO
F AN 2304 01 08		1195x500x1940 H	4	key	NO
F AN 2302 07 08		610x500x2140 H	2	key	SI
F AN 2303 07 08		900x500x2140 H	3	key	SI
F AN 2304 07 08		1195x500x2140 H	4	key	SI



ARMADIO PORTA CASCO

ARMADIO CON SERRATURA LUCCHETTABILE

ART.		dim. mm	n. scomparti		pedini
F AN 2302 11 08		610x500x1940 H	2	-	NO
F AN 2303 11 08		900x500x1940 H	3	-	NO
F AN 2304 11 08		1195x500x1940 H	4	-	NO
F AN 2302 17 08		610x500x2140 H	2	-	SI
F AN 2303 17 08		900x500x2140 H	3	-	SI
F AN 2304 17 08		1195x500x2140 H	4	-	SI



Esempio di piedino applicato all'armadio.

PERFOM GS140

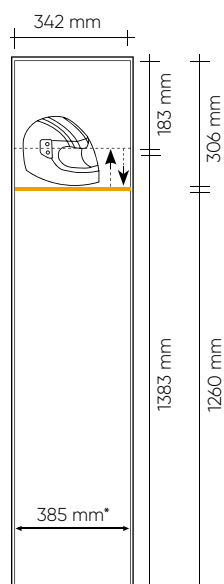

*Spazio utile interno



Esempio a 3 scomparti

▶ Armadio con piano regolabile in altezza per casco.



ARMADIO CON SERRATURA A CILINDRO

ART.		dim. mm	n. scomparti		piedini
F AN 1402 01 08		805x500x1750 H	2	key	NO
F AN 1403 01 08		1195x500x1750 H	3	key	NO
F AN 1402 07 08		805x500x1950 H	2	key	SI
F AN 1403 07 08		1195x500x1950 H	3	key	SI



**ARMADIO
PORTA CASCO**

ARMADIO CON SERRATURA LUCCHETTABILE

ART.		dim. mm	n. scomparti		piedini
F AN 1402 11 08		805x500x1750 H	2	-	NO
F AN 1403 11 08		1195x500x1750 H	3	-	NO
F AN 1402 17 08		805x500x1950 H	2	-	SI
F AN 1403 17 08		1195x500x1950 H	3	-	SI



Esempio di piedino applicato all'armadio.



Esempio a 3 scomparti

▶ Armadio con piano regolabile in altezza per casco.

TETTO INCLINATO

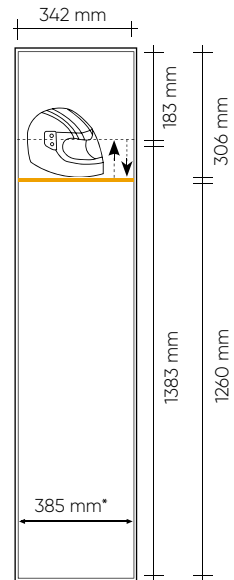

*Spazio utile interno

SERRATURA A CILINDRO

ART.		dim. mm	n. scomparti		piedini
F AN 2402 01 08		805x500x1940 H	2	key	NO
F AN 2403 01 08		1195x500x1940 H	3	key	NO
F AN 2402 07 08		805x500x2140 H	2	key	SI
F AN 2403 07 08		1195x500x2140 H	3	key	SI



ARMADIO PORTA CASCO

ARMADIO CON SERRATURA LUCCHETTABILE

ART.		dim. mm	n. scomparti		piedini
F AN 2402 11 08		805x500x1940 H	2	-	NO
F AN 2403 11 08		1195x500x1940 H	3	-	NO
F AN 2402 17 08		805x500x2140 H	2	-	SI
F AN 2403 17 08		1195x500x2140 H	3	-	SI



Esempio di piedino applicato all'armadio.





PERFOM GS150

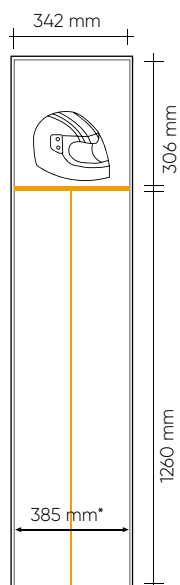

*Spazio utile interno



Esempio a 3 scomparti

▶ Armadio con piano fisso per casco e parete divisoria spostabile.

SERRATURA A CILINDRO

ART.		dim. mm	n. scomparti		piedini
F AN 1501 31 08		413x500x1750 H	1	key	NO
F AN 1502 31 08		805x500x1750 H	2	key	NO
F AN 1503 31 08		1195x500x1750 H	3	key	NO
F AN 1501 37 08		413x500x1950 H	1	key	SI
F AN 1502 37 08		805x500x1950 H	2	key	SI
F AN 1503 37 08		1195x500x1950 H	3	key	SI

ARMADIO PORTA CASCO

ARMADIO CON SERRATURA LUCCHETTABILE

ART.		dim. mm	n. scomparti		piedini
F AN 1501 41 08		413x500x1750 H	1	-	NO
F AN 1502 41 08		805x500x1750 H	2	-	NO
F AN 1503 41 08		1195x500x1750 H	3	-	NO
F AN 1501 47 08		413x500x1950 H	1	-	SI
F AN 1502 47 08		805x500x1950 H	2	-	SI
F AN 1503 47 08		1195x500x1950 H	3	-	SI

▶ Esempio di piedino applicato all'armadio.



Esempio a 3 scomparti

▶ Armadio con piano fisso per casco e parete divisoria spostabile.

TETTO INCLINATO

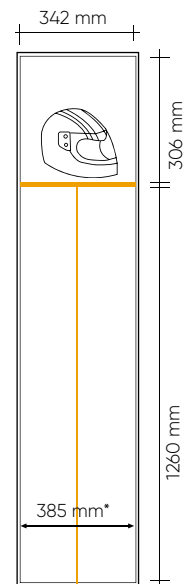

*Spazio utile interno

ARMADIO CON SERRATURA A CILINDRO

ART.		dim. mm	n. scomparti		piedini
F AN 2502 31 08		805x500x1940 H	2	key	NO
F AN 2503 31 08		1195x500x1940 H	3	key	NO

F AN 2502 37 08		805x500x2140 H	2	key	SI
F AN 2503 37 08		1195x500x2140 H	3	key	SI



ARMADIO PORTA CASCO

ARMADIO CON SERRATURA LUCCHETTABILE

ART.		dim. mm	n. scomparti		piedini
F AN 2502 41 08		805x500x1940 H	2	-	NO
F AN 2503 41 08		1195x500x1940 H	3	-	NO

F AN 2502 47 08		805x500x2140 H	2	-	SI
F AN 2503 47 08		1195x500x2140 H	3	-	SI



Esempio di piedino applicato all'armadio.

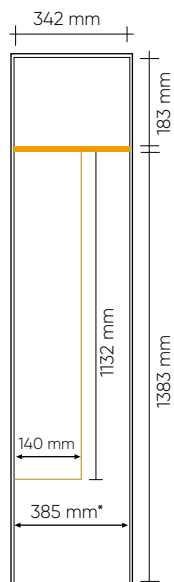



*Spazio utile interno





Esempio a 3 scomparti

▶ Armadio con piano fisso e parete divisoria fissa.

ARMADIO CON SERRATURA A CILINDRO

ART.		dim. mm	n. scomparti		pedini
F AN 1602 01 08		805x500x1750 H	2	key	NO
F AN 1603 01 08		1195x500x1750 H	3	key	NO
F AN 1602 07 08		805x500x1950 H	2	key	SI
F AN 1603 07 08		1195x500x1950 H	3	key	SI

ARMADIO CON SERRATURA LUCCHETTABILE

ART.		dim. mm	n. scomparti		pedini
F AN 1602 11 08		805x500x1750 H	2	-	NO
F AN 1603 11 08		1195x500x1750 H	3	-	NO
F AN 1602 17 08		805x500x1950 H	2	-	SI
F AN 1603 17 08		1195x500x1950 H	3	-	SI



▶ Esempio di piedino applicato all'armadio.



Esempio a 3 scomparti

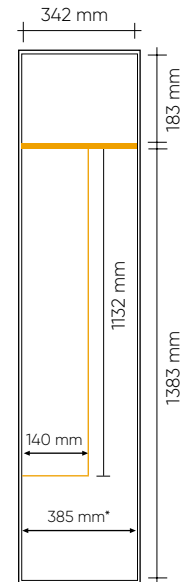

▶ Armadio con piano fisso e parete divisoria fissa.

TETTO INCLINATO





*Spazio utile interno

SERRATURA A CILINDRO

ART.		dim. mm	n. scomparti		piedini
F AN 2602 01 08		805x500x1940 H	2	key	NO
F AN 2603 01 08		1195x500x1940 H	3	key	NO
F AN 2602 07 08		805x500x2140 H	2	key	SI
F AN 2603 07 08		1195x500x2140 H	3	key	SI

ARMADIO CON SERRATURA LUCCHETTABILE

ART.		dim. mm	n. scomparti		piedini
F AN 2602 11 08		805x500x1940 H	2	-	NO
F AN 2603 11 08		1195x500x1940 H	3	-	NO
F AN 2602 17 08		805x500x2140 H	2	-	SI
F AN 2603 17 08		1195x500x2140 H	3	-	SI



Esempio di piedino applicato all'armadio.

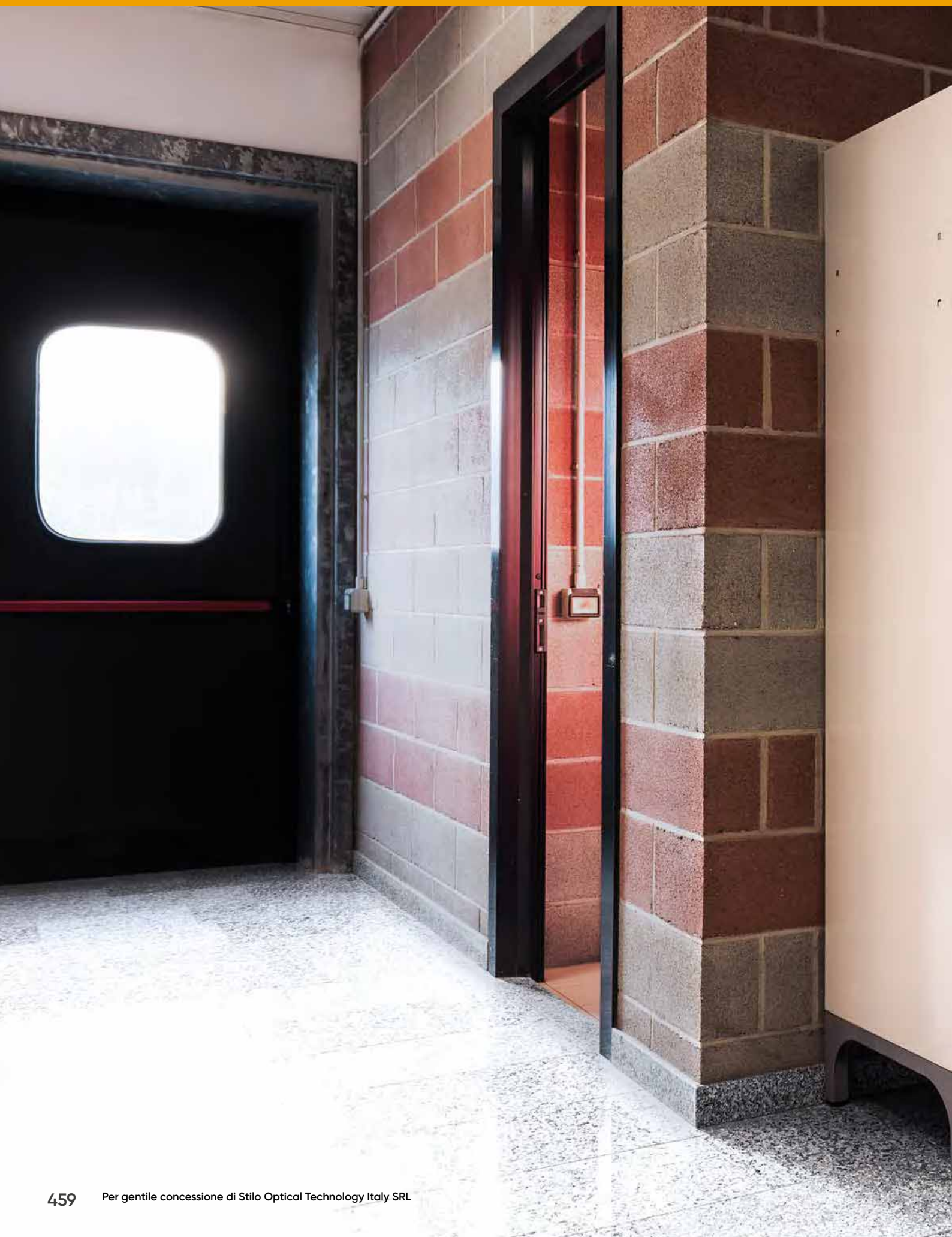



PERFOM GS170

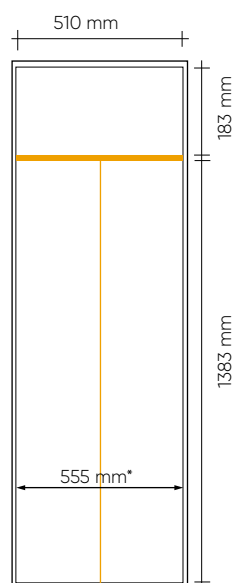



*Spazio utile interno



Esempio a 2 scomparti

▶ Armadio con piano fisso e parete divisoria fissa.

ARMADIO CON SERRATURA A CILINDRO

ART.		dim. mm	n. scomparti		pedini
F AN 1701 01 08		585x500x1750 H	1	key	NO
F AN 1702 01 08		1145x500x1750 H	2	key	NO
F AN 1701 07 08		585x500x1950 H	1	key	SI
F AN 1702 07 08		1145x500x1950 H	2	key	SI



Esempio di pedino applicato all'armadio.



Esempio a 2 scomparti

▶ Armadio con piano fisso e parete divisoria fissa.

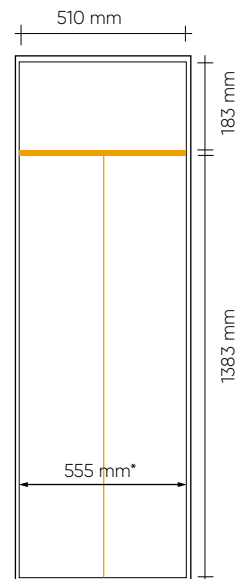



*Spazio utile interno

SERRATURA A CILINDRO

ART.		dim. mm	n. scomparti		piedini
F AN 1801 01 08		585x500x1750 H	1	key	NO
F AN 1802 01 08		1145x500x1750 H	2	key	NO
F AN 1801 07 08		585x500x1950 H	1	key	SI
F AN 1802 07 08		1145x500x1950 H	2	key	SI

ARMADIO CON SERRATURA LUCCHETTABILE

ART.		dim. mm	n. scomparti		piedini
F AN 1801 11 08		585x500x1750 H	1	-	NO
F AN 1802 11 08		1145x500x1750 H	2	-	NO
F AN 1801 17 08		585x500x1950 H	1	-	SI
F AN 1802 17 08		1145x500x1950 H	2	-	SI



Esempio di piedino applicato all'armadio.

PERFOM





ARMADI A SCOMPARTI

Gli armadi a scomparti, adatti alla custodia sia di indumenti che di oggetti personali, possono essere utilizzati nei più svariati settori, dall'industria al terziario, dallo sport alle attività ludiche. Le porte vengono fornite con un vano porta etichetta per l'identificazione personale e chiudono a filo con il corpo dell'armadio. Sia le porte che la parete posteriore presentano una serie di fessure che favoriscono la circolazione dell'aria.



Tra gli accessori, per evitare il contatto con il pavimento, è possibile scegliere tra: piedini in polipropilene (molto resistenti al contatto con l'acqua), zoccoli in acciaio zincato, panche monofronti e bifronti, appoggia scarpe.



Le porte possono essere fornite con chiusura a cilindro con due chiavi oppure con pomolo lucchettabile (lucchetto escluso).

CHIUSURA A CILINDRO



Fornita di serie, negli armadi, la chiusura a cilindro

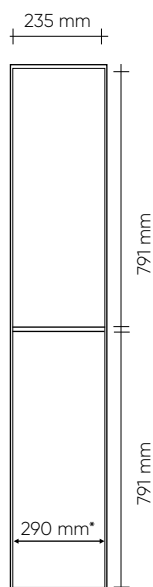



*Spazio utile interno



Esempio a 8 scomparti



ARMADIO CON SERRATURA A CILINDRO

ART.		dim. mm	n. scomparti		piedini
F AN 1904 01 08		610x500x1750 H	2x2	key	NO
F AN 1906 01 08		900x500x1750 H	2x3	key	NO
F AN 1908 01 08		1195x500x1750 H	2x4	key	NO
F AN 1904 07 08		610x500x1950 H	2x2	key	SI
F AN 1906 07 08		900x500x1950 H	2x3	key	SI
F AN 1908 07 08		1195x500x1950 H	2x4	key	SI



**ARMADIO
PORTA CASCO**

ARMADIO CON SERRATURA LUCCHETTABILE

ART.		dim. mm	n. scomparti		piedini
F AN 1904 11 08		610x500x1750 H	2x2	-	NO
F AN 1906 11 08		900x500x1750 H	2x3	-	NO
F AN 1908 11 08		1195x500x1750 H	2x4	-	NO
F AN 1904 17 08		610x500x1950 H	2x2	-	SI
F AN 1906 17 08		900x500x1950 H	2x3	-	SI
F AN 1908 17 08		1195x500x1750 H	2x4	-	SI



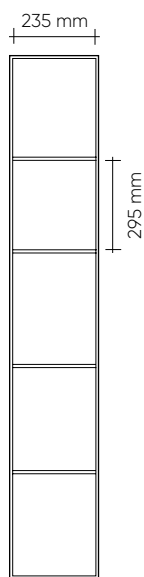

Esempio di piedino applicato all'armadio.

PERFOM FS1000



Esempio a 20 scomparti



ARMADIO CON SERRATURA A CILINDRO

ART.		dim. mm	n. scomparti		piedini
F AM 1025 01 08		610x500x1750 H	2x5	key	NO
F AM 1035 01 08		900x500x1750 H	3x5	key	NO
F AM 1045 01 08		1195x500x1750 H	4x5	key	NO
F AM 1025 07 08		610x500x1950 H	2x5	key	SI
F AM 1035 07 08		900x500x1950 H	3x5	key	SI
F AM 1045 07 08		1195x500x1950 H	4x5	key	SI



**ARMADIO
PORTA CASCO**

ARMADIO CON SERRATURA LUCCHETTABILE

ART.		dim. mm	n. scomparti		piedini
F AM 1025 11 08		610x500x1750 H	2x5	-	NO
F AM 1035 11 08		900x500x1750 H	3x5	-	NO
F AM 1045 11 08		1195x500x1750 H	4x5	-	NO
F AM 1025 17 08		610x500x1950 H	2x5	-	SI
F AM 1035 17 08		900x500x1950 H	3x5	-	SI
F AM 1045 17 08		1195x500x1950 H	4x5	-	SI



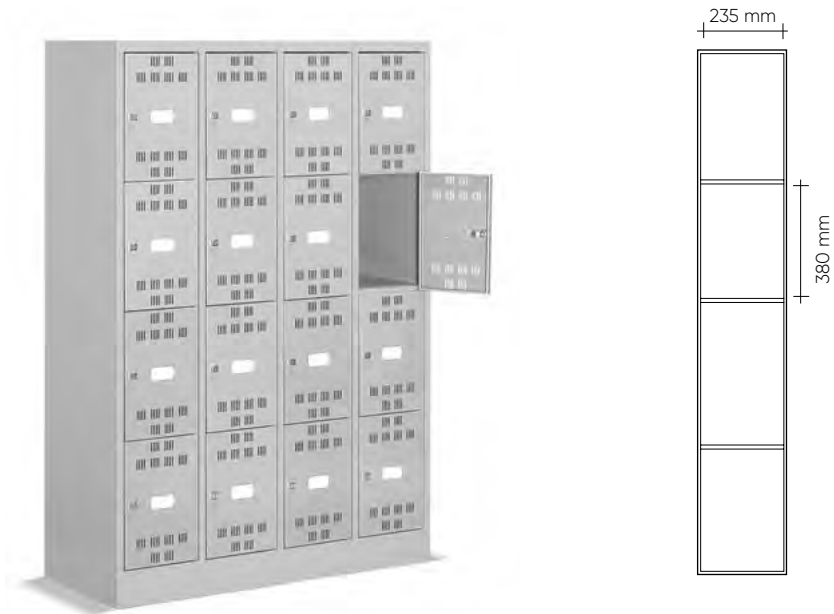

Esempio di piedino applicato all'armadio.





Esempio a 16 scomparti

ARMADIO CON SERRATURA A CILINDRO

ART.		dim. mm	n. scomparti		pedini
F AM 1124 01 08		610x500x1750 H	2x4	key	NO
F AM 1134 01 08		900x500x1750 H	3x4	key	NO
F AM 1144 01 08		1195x500x1750 H	4x4	key	NO
F AM 1124 07 08		610x500x1950 H	2x4	key	SI
F AM 1134 07 08		900x500x1950 H	3x4	key	SI
F AM 1144 07 08		1195x500x1950 H	4x4	key	SI



ARMADIO CON SERRATURA LUCCHETTABILE

ART.		dim. mm	n. scomparti		pedini
F AM 1124 11 08		610x500x1750 H	2x4	-	NO
F AM 1134 11 08		900x500x1750 H	3x4	-	NO
F AM 1144 11 08		1195x500x1750 H	4x4	-	NO
F AM 1124 17 08		610x500x1950 H	2x4	-	SI
F AM 1134 17 08		900x500x1950 H	3x4	-	SI
F AM 1144 17 08		1195x500x1950 H	4x4	-	SI



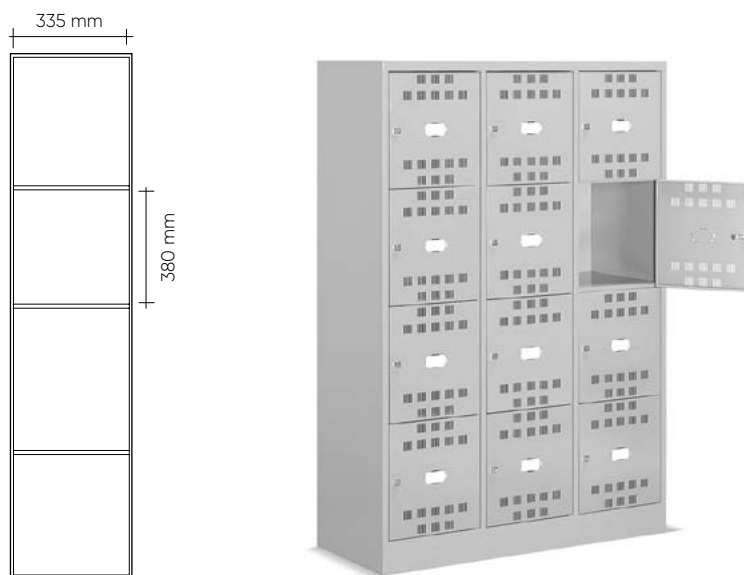

Esempio di piedino applicato all'armadio.

PERFOM FS1200



Esempio a 12 scomparti



ARMADIO CON SERRATURA A CILINDRO

ART.		dim. mm	n. scomparti		piedini
F AM 1214 01 08		415x500x1750 H	1x4	key	NO
F AM 1224 01 08		805x500x1750 H	2x4	key	NO
F AM 1234 01 08		1195x500x1750 H	3x4	key	NO
F AM 1214 07 08		415x500x1950 H	1x4	key	SI
F AM 1224 07 08		805x500x1950 H	2x4	key	SI
F AM 1234 07 08		1195x500x1950 H	3x4	key	SI



ARMADIO
PORTA CASCO

ARMADIO CON SERRATURA LUCCHETTABILE

ART.		dim. mm	n. scomparti		piedini
F AM 1214 11 08		415x500x1750 H	1x4	-	NO
F AM 1224 11 08		805x500x1750 H	2x4	-	NO
F AM 1234 11 08		1195x500x1750 H	3x4	-	NO
F AM 1214 17 08		415x500x1950 H	1x4	-	SI
F AM 1224 17 08		805x500x1950 H	2x4	-	SI
F AM 1234 17 08		1195x500x1950 H	3x4	-	SI



Esempio di piedino applicato all'armadio.

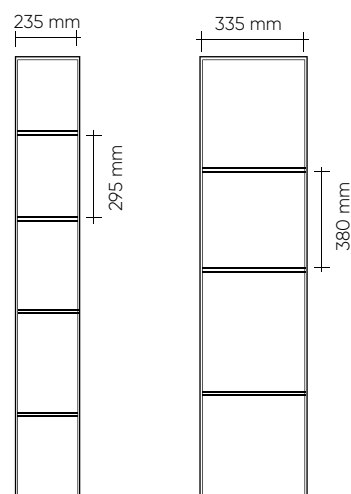

Esempio a 14 scomparti

ARMADIO CON SERRATURA A CILINDRO

ART.	dim. mm	n. scomparti		piedini
F AM 7010 01 08	2025x500x1750* H	14	key	NO
F AM 7310 01 08	2325x500x1750** H	14	key	NO
F AM 7012 01 08	2025x500x1950* H	14	key	SI
F AM 7312 01 08	2325x500x1950** H	14	key	SI

* Con piani lunghezza 1000 mm

** Con piani lunghezza 1300 mm



**ARMADIO
PORTA CASCO**

ARMADIO CON SERRATURA LUCCHETTABILE

ART.	dim. mm	n. scomparti		piedini
F AM 7020 01 08	2025x500x1750* H	14	-	NO
F AM 7320 01 08	2325x500x1750** H	14	-	NO
F AM 7022 01 08	2025x500x1950* H	14	-	SI
F AM 7322 01 08	2325x500x1950** H	14	-	SI

* Con piani lunghezza 1000 mm

** Con piani lunghezza 1300 mm



Esempio di piedino applicato all'armadio.

GS110

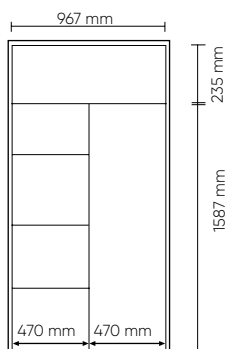

ARMADIO CON SERRATURA A CILINDRO

ART.		dim.mm	
F AN 1101 01 08		1023x555x2000 H	key

Armadio con piano superiore fisso, 3 piani laterali regolabili in altezza e parete divisorio fissa

GS120

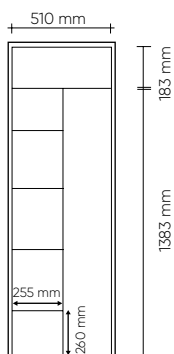

ARMADIO CON SERRATURA A CILINDRO

ART.		dim.mm	
F AN 1201 01 08		585x500x1750 H	key

ARMADIO CON POMOLO LUCCHETTABILE

ART.		dim.mm	
F AN 1201 11 08		585x500x1750 H	key

Armadio con piani fissi e parete divisorio fissa

GS501



ARMADIO CON 3 VANI

ART.		dim.mm	
F AN 5010 01 08		585x402x1750 H	key

Serratura con 3 punti di chiusura

COPPIA ZOCCOLI



ART.	dim.mm
F AM 9000 00 99	50x498x100 H

ADATTA PER ARMADI SERIE:

F AN 1200 - F AN 1300 - F AN 1400 - F AN 1500
 F AN 1600 - F AN 1700 - F AN 1800 - F AN 1900
 F AN 2300 - F AN 2400 - F AN 2500 - F AN 2600
 F AM 1000 - F AM 1100 - F AM 1200 - F AM 7000 - F AM 7300



Esempio di zoccolo applicato all'armadio.

COPPIA PIEDINI



ART.	dim.mm
F RR 2310 00 01	135x500x180/200 H
F RR 2310 00 07	135x500x180/200 H

01 07
 GRIGIO NERO

ADATTA PER ARMADI SERIE:

F AN 1200 - F AN 1300 - F AN 1400 - F AN 1500
 F AN 1600 - F AN 1700 - F AN 1800 - F AN 1900
 F AN 2300 - F AN 2400 - F AN 2500 - F AN 2600
 F AM 1000 - F AM 1100 - F AM 1200 - F AM 7000 - F AM 7300



Esempio di piedino applicato all'armadio.

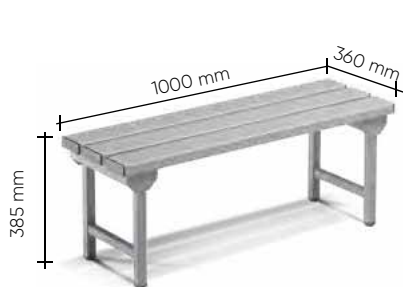

PANCA 1000 mm

ART.	dim.mm
F AN 9540 00 01	1000x360x385 H

GRIGIO RAL 7000

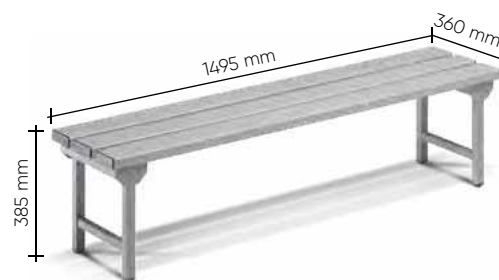

PANCA 1500 mm

ART.	dim.mm
F AN 9550 00 01	1495x360x385 H

GRIGIO RAL 7000

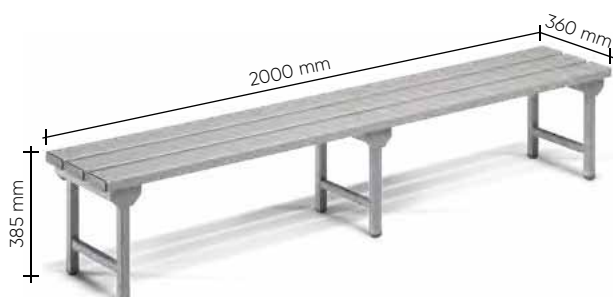

PANCA 2000 mm

ART.	dim.mm
F AN 9560 00 01	2000x360x385 H

GRIGIO RAL 7000

Solida panchina costruita con tubi d'acciaio saldati, con piedini regolabili. La panchina con profondità 360 mm è rivestita con profilati in plastica.

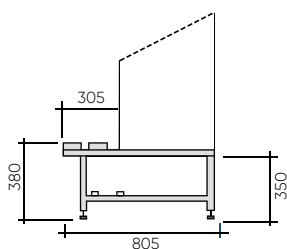

PANCHE MONOFRONTI

ART.	larghezza armadio mm	
F AM 9010 00 01	585	
F AM 9020 00 01	610	
F AM 9030 00 01	805	
F AM 9040 00 01	900	
F AM 9050 00 01	1145	
F AM 9060 00 01	1195	

GRIGIO RAL 7000

▶ Solida panchina costruita con tubi d'acciaio saldati, con piedini regolabili. La panchina con profondità 300 mm è rivestita con profilati in plastica

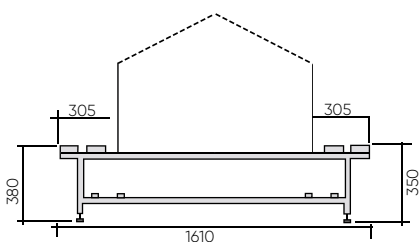

PANCHE BIFRONTI

ART.	larghezza armadio mm	
F AM 9110 00 01	585	
F AM 9120 00 01	610	
F AM 9130 00 01	805	
F AM 9140 00 01	900	
F AM 9150 00 01	1145	
F AM 9160 00 01	1195	

GRIGIO RAL 7000



RIPIANO APPOGGIA SCARPE

ART.	larghezza armadio mm
F AM 9210 00 01	585
F AM 9220 00 01	610
F AM 9230 00 01	805
F AM 9240 00 01	900
F AM 9250 00 01	1145
F AM 9260 00 01	1195

GRIGIO RAL 7000

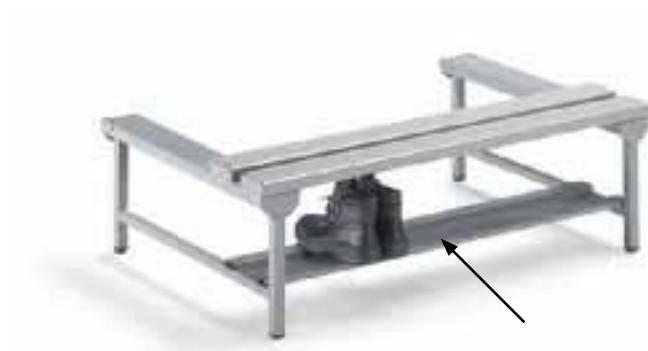

**PROTEZIONE DEL PC
IMPIANTO ELETTRICO
A NORMA CE
ALLESTIMENTO
PERSONALIZZABILE**





STANDARD CS

ARMADI PER PC

Porta con serratura di sicurezza e vetro in polycarbonato. Dimensioni utili: 660x525 mm H.

Possibilità di inserimento video fino a 21". Dimensioni interne del vano superiore: 690x600x580 mm H.

Piano porta tastiera. Dimensioni utili: 620x510 mm H.

Vano inferiore con possibilità di inserimento di piani estraibili e piani regolabili in altezza, per l'alloggiamento di sistemi hardware e stampanti. Dimensioni interne: 690x600x720 mm H.

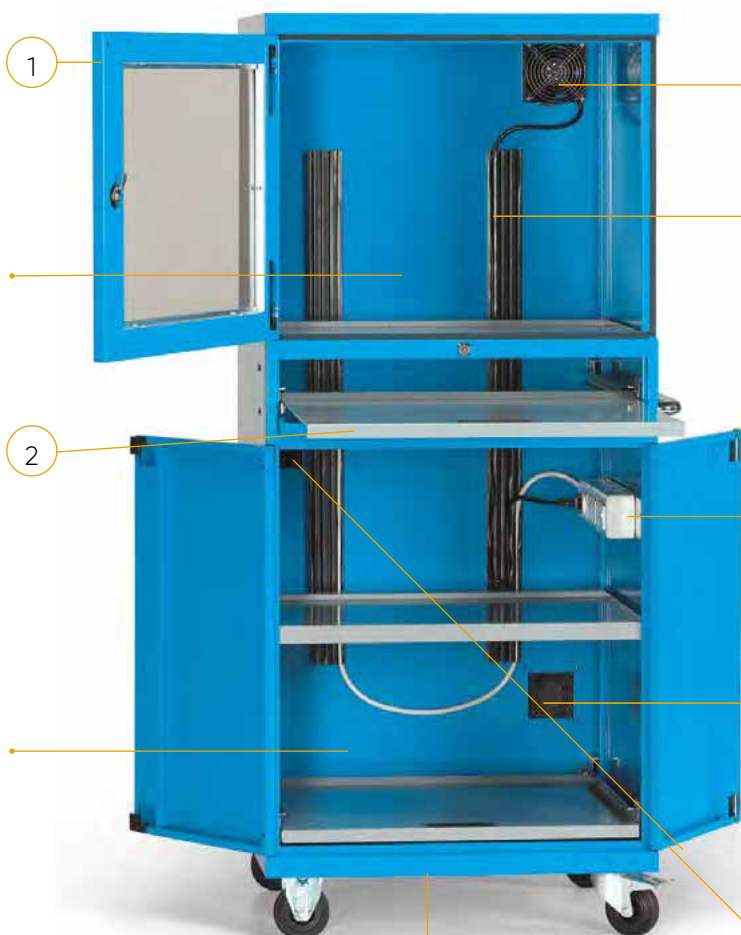

Ventola di raffreddamento con filtro antipolvere.

Canalette porta cavi a 4 corsie.

Impianto elettrico a 5 prese con interruttore magnetotermico.

Foro di entrata dell'aria con filtro antipolvere.

Foro per cavi di rete e foro di uscita del cavo per l'impianto elettrico.

-Temperatura di utilizzo tra -5/+40 °C con umidità fino al 50%

-Temperatura di utilizzo tra -5/+20 °C con umidità fino al 90%

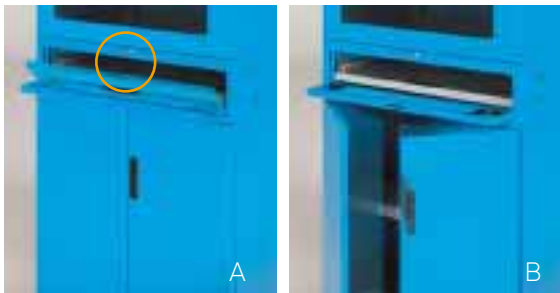

- 1 La serratura della porta a ribalta (fig. A) chiude o apre contemporaneamente la coppia porte (fig. B)



- 2 Il piano porta tastiera si può bloccare in due posizioni di apertura e grazie alle sue notevoli dimensioni, tutti gli oggetti trovano uno spazio adeguato. Con l'armadio sono forniti di serie 1 tappetino per mouse, 2 staffe per il fissaggio a terra e 2 livellatori



- 3 L'impianto elettrico di ogni armadio, con grado di protezione IP 30, viene fornito di serie con un interruttore magnetotermico 230V 10A e testato secondo la norma CEI EN 60204-1:
- continuità circuito protezione equipotenziale
 - tensione applicata
 - resistenza all'isolamento



- 4 Svitando l'apposito pressacavo si può regolare la lunghezza esterna del cavo di alimentazione elettrica. Il cavo elettrico è a doppia protezione e ha una lunghezza di 3 metri



ARMADIO CON O SENZA ZOCCOLI

Portata armadio : 400 kg
 Portata piano regolabile: 100 kg
 Portata piano estraibile: 50 kg

ARMADIO CON RUOTE IN NYLON Ø100 mm

Portata armadio : 290 kg
 Portata piano regolabile: 100 kg
 Portata piano estraibile: 25 kg*

* Attenzione: la portata può essere aumentata del 100% se nell'armadio è già presente un carico pari a 50 kg.

STANDARD CS



● ART. F AS 1601 12 04

H = 1560 mm

Gamma colori
ACCIAIO 



GRIGIO
RAL 7000
.01



VERDE
RAL 6011
.02



BLU
RAL 5012
.04



GRIGIO
RAL 7035
.08



CHIUSURA A CILINDRO (KEY)
FORNITA DI SERIE CON CHIUSURA A CILINDRO E 2
CHIAVI

LEGENDA



PORTATA



CHIUSURA
ARMADIO



LE PORTATE SONO NETTE E SI RIFERISCONO A PESI UNIFORMEMENTE DISTRIBUITI.



H 1560 mm

Completo di:
2 piani regolabili in altezza
1 piano porta tastiera

CON 1 VENTOLA		TIPO E NUMERO PRESE CABLATE					
ART.		D	F	GB	I	CH	IL
F AS 1601 11 04		5	-	-	-	-	-
F AS 1601 21 04		2	3	-	-	-	-
F AS 1601 31 04		2	-	2	-	-	-
F AS 1601 41 04		2	-	-	3	-	-
F AS 1601 51 04		2	-	-	-	3	-
F AS 1601 71 04		2	-	-	-	-	3

CON 2 VENTOLE		TIPO E NUMERO PRESE CABLATE					
ART.		D	F	GB	I	CH	IL
F AS 1602 11 04		5	-	-	-	-	-
F AS 1602 21 04		2	3	-	-	-	-
F AS 1602 31 04		2	-	2	-	-	-
F AS 1602 41 04		2	-	-	3	-	-
F AS 1602 51 04		2	-	-	-	3	-
F AS 1602 71 04		2	-	-	-	-	3



H 1560 mm

Completo di:
2 piani regolabili in altezza
1 piano porta tastiera
1 piano estraibile

CON 1 VENTOLA		TIPO E NUMERO PRESE CABLATE					
ART.		D	F	GB	I	CH	IL
F AS 1601 12 04		5	-	-	-	-	-
F AS 1601 22 04		2	3	-	-	-	-
F AS 1601 32 04		2	-	2	-	-	-
F AS 1601 42 04		2	-	-	3	-	-
F AS 1601 52 04		2	-	-	-	3	-
F AS 1601 72 04		2	-	-	-	-	3

CON 2 VENTOLE		TIPO E NUMERO PRESE CABLATE					
ART.		D	F	GB	I	CH	IL
F AS 1602 12 04		5	-	-	-	-	-
F AS 1602 22 04		2	3	-	-	-	-
F AS 1602 32 04		2	-	2	-	-	-
F AS 1602 42 04		2	-	-	3	-	-
F AS 1602 52 04		2	-	-	-	3	-
F AS 1602 72 04		2	-	-	-	-	3

STANDARD CS





H 1660 mm

Completo di:
2 piani regolabili in altezza
1 piano porta tastiera
1 piano estraibile
1 coppia zoccoli 100 mm H
senza chiusura



Chiusura zoccolo 100 mm H

CON 1 VENTOLA		TIPO E NUMERO PRESE CABLATE						
ART.		D	F	GB	I	CH	IL	
F AS 1601 14 04		5	-	-	-	-	-	
F AS 1601 24 04		2	3	-	-	-	-	
F AS 1601 34 04		2	-	2	-	-	-	
F AS 1601 44 04		2	-	-	3	-	-	
F AS 1601 54 04		2	-	-	-	3	-	
F AS 1601 74 04		2	-	-	-	-	3	

CON 2 VENTOLE		TIPO E NUMERO PRESE CABLATE						
ART.		D	F	GB	I	CH	IL	
F AS 1602 14 04		5	-	-	-	-	-	
F AS 1602 24 04		2	3	-	-	-	-	
F AS 1602 34 04		2	-	2	-	-	-	
F AS 1602 44 04		2	-	-	3	-	-	
F AS 1602 54 04		2	-	-	-	3	-	
F AS 1602 74 04		2	-	-	-	-	3	



H 1760 mm

Completo di:
2 piani regolabili in altezza
1 piano porta tastiera
1 piano estraibile
1 coppia zoccoli 200 mm H
senza chiusura



Chiusura zoccolo 200 mm H

CON 1 VENTOLA		TIPO E NUMERO PRESE CABLATE						
ART.		D	F	GB	I	CH	IL	
F AS 1601 15 04		5	-	-	-	-	-	
F AS 1601 25 04		2	3	-	-	-	-	
F AS 1601 35 04		2	-	2	-	-	-	
F AS 1601 45 04		2	-	-	3	-	-	
F AS 1601 55 04		2	-	-	-	3	-	
F AS 1601 75 04		2	-	-	-	-	3	

CON 2 VENTOLE		TIPO E NUMERO PRESE CABLATE						
ART.		D	F	GB	I	CH	IL	
F AS 1602 15 04		5	-	-	-	-	-	
F AS 1602 25 04		2	3	-	-	-	-	
F AS 1602 35 04		2	-	2	-	-	-	
F AS 1602 45 04		2	-	-	3	-	-	
F AS 1602 55 04		2	-	-	-	3	-	
F AS 1602 75 04		2	-	-	-	-	3	

STANDARD CS

717x635 mm



movimentazione su ruote



H 1690 mm

Completo di:
 2 piani regolabili in altezza
 1 piano porta tastiera
 1 piano estraibile
 2 ruote girevoli con freno e
 2 ruote fisse in nylon Ø 100 mm

CON 1 VENTOLA		TIPO E NUMERO PRESE CABLATE						
ART.		D	F	GB	I	CH	IL	
F AS 1601 13 04		5	-	-	-	-	-	
F AS 1601 23 04		2	3	-	-	-	-	
F AS 1601 33 04		2	-	2	-	-	-	
F AS 1601 43 04		2	-	-	3	-	-	
F AS 1601 53 04		2	-	-	-	3	-	
F AS 1601 73 04		2	-	-	-	-	3	

CON 2 VENTOLE		TIPO E NUMERO PRESE CABLATE						
ART.		D	F	GB	I	CH	IL	
F AS 1602 13 04		5	-	-	-	-	-	
F AS 1602 23 04		2	3	-	-	-	-	
F AS 1602 33 04		2	-	2	-	-	-	
F AS 1602 43 04		2	-	-	3	-	-	
F AS 1602 53 04		2	-	-	-	3	-	
F AS 1602 73 04		2	-	-	-	-	3	





STANDARD CS





STANDARD CS

CONFIGURA IL TUO ARMADIO



Gamma colori
ACCIAIO

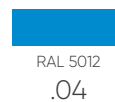
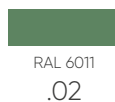
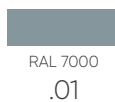

ARMADIO VUOTO

ART.	kg	🔒
F AS 1600 01 04	400	key

Armadio vuoto

Dimensioni interne del vano SUPERIORE mm 690x600x580 H

Dimensioni interne del vano INFERIORE mm 690x600x720 H

Dimensioni ingombro mm 717x635x1560 H



All'armadio per computer possono essere applicate solo ruote Ø 100/125/150 mm.

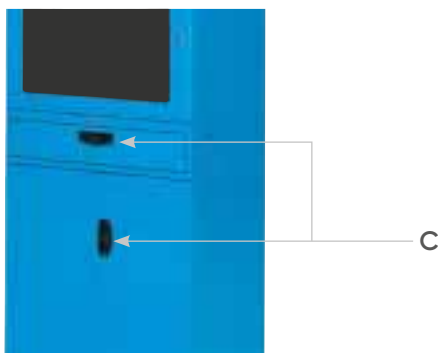

RICAMBI

ART.		
R XAS 0002 99		asta di ricambio per coppia porte
R XDA 0002 07	C	maniglia di ricambio per porte



ARMADIO CON O SENZA ZOCCOLI

Portata armadio: 400 kg
Portata piano regolabile: 100 kg
Portata piano estraibile: 50 kg

ARMADIO CON RUOTE IN NYLON Ø100 mm

Portata armadio: 290 kg
Portata piano regolabile: 100 kg
Portata piano estraibile: 25 kg*

* Attenzione: la portata può essere aumentata del 100% se nell'armadio è già presente un carico pari a 50 kg.



PIANO REGOLABILE

ART.	dim. utili	kg
F AS 2040 01 01	685x510	100

Colore grigio RAL 7000.

Dimensioni ingombro mm 690x595x35 H



PIANO PORTA TASTIERA

ART.	dim. utili	kg	
F AS 2350 00 01	620x510	50	

Colore grigio RAL 7000.
Dimensioni ingombro mm 650x585x25 H



PIANO ESTRAIBILE

ART.	dim. utili	kg	
F AS 2360 00 01	620x510	50	

Colore grigio RAL 7000.
Dimensioni ingombro mm 650x585x25 H



COPPIA ZOCCOLI PER TRANSPALLET 100 mm H

ART.		
F RR 1625 00 07	coppia zoccoli	
F RR 0645 00 07	chiusura per coppia zoccoli	

Colore nero RAL 9005.



COPPIA ZOCCOLI 200 mm H

ART.		
F RR 1635 00 07	coppia zoccoli	
F RR 0645 01 07	chiusura per coppia zoccoli	

Colore nero RAL 9005.

IMPIANTO ELETTRICO

ART.	TIPO E NUMERO PRESE CABLATE						
	D	F	GB	I	CH	IL	
F AS 4100 10 00	5	-	-	-	-	-	
F AS 4100 20 00	2	3	-	-	-	-	
F AS 4100 30 00	2	-	2	-	-	-	
F AS 4100 40 00	2	-	-	3	-	-	
F AS 4100 50 00	2	-	-	-	3	-	
F AS 4100 70 00	2	-	-	-	-	3	

L'impianto elettrico (con grado di protezione IP 30) viene fornito di serie con un interruttore magnetotermico 230V 10A, 5 prese 220-250V 10A 2P+T e 1 spina industriale 220-250V 16A 2P+T.



Lunghezza cavo 3,5 m

STANDARD CS



PROFILO

ART.

C ME 99 018

Profilo passacavo in plastica a 4 canali lunghezza 1000 mm

GRIGLIA

ART.

F AS 3210 00 00

Griglia esterna completa di filtro antipolvere



VENTOLA

ART.

F AS 3220 00 00

Ventola 220V cablata completa di griglia e spina Schuko



MANIGLIA

ART.

F AG 9300 00 07

Colore nero RAL 9005.



RUOTA GIREVOLE CON FRENO IN GOMMA STANDARD

ART.	Ø mm	C mm	Portata kg
C RG DAC12 125	125	155	100
C RG DAC13 150	150	180	115



RUOTA GIREVOLE CON FRENO IN GOMMA ELASTICA

ART.	Ø mm	C mm	Portata kg
C RG DCE15 125	125	155	180



RUOTA GIREVOLE SENZA FRENO IN GOMMA STANDARD

ART.	Ø mm	C mm	Portata kg
C RG CAC12 125	125	155	100
C RG CAC13 150	150	180	115



RUOTA FISSA IN GOMMA ELASTICA

ART.	Ø mm	C mm	Portata kg
C RG BCE15 125	125	155	180



RUOTA FISSA IN GOMMA STANDARD

ART.	Ø mm	C mm	Portata kg
C RG BAC12 125	125	155	100
C RG BAC13 150	150	180	115



RUOTA GIREVOLE CON FRENO IN POLIURETANO

ART.	Ø mm	C mm	Portata kg
C RN DDD31 125	125	155	180



RUOTA FISSA IN POLIURETANO

ART.	Ø mm	C mm	Portata kg
C RN BDD31 125	125	155	180



RUOTA GIREVOLE CON FRENO ANTITRACCIA

ART.	Ø mm	C mm	Portata kg
C RG DPH22 125	125	155	100



RUOTA FISSA ANTITRACCIA

ART.	Ø mm	C mm	Portata kg
C RG BPH22 125	125	155	100



RUOTA GIREVOLE CON FRENO IN NYLON

ART.	Ø mm	C mm	Portata kg
C RN DAD10 100	100	128	125
C RN DAD11 125	125	155	180



RUOTA FISSA IN NYLON

ART.	Ø mm	C mm	Portata kg
C RN BAD10 100	100	128	125
C RN BAD11 125	125	155	180



Per calcolare la portata dell'armadio seguire la formula: $(A \times 3) - 85 \text{ kg}$

A = PORTATA DELLE RUOTE

FISSAGGIO

SUPPORTO MULTIUSO

ART. F AS 2250 00 07



SET DI FISSAGGIO A PAVIMENTO

ART. F AG 9204 00 99

2 tasselli "HILTI" adatti per pavimenti in calcestruzzo non fessurato alla classe maggiore o uguale C20/25
Trazione consigliata del tassello: 2.9 KN
Diametro tassello: Ø 6 mm



**POSTAZIONI MOBILI
PER PC
4 TIPOLOGIE
10 COLORI**



MASTER CS

CARATTERISTICHE TECNICHE

MODULO BASE

Serrature di sicurezza per il cassetto e per la coppia di porte a battente. Dimensioni mm: 791x598x1081 H.

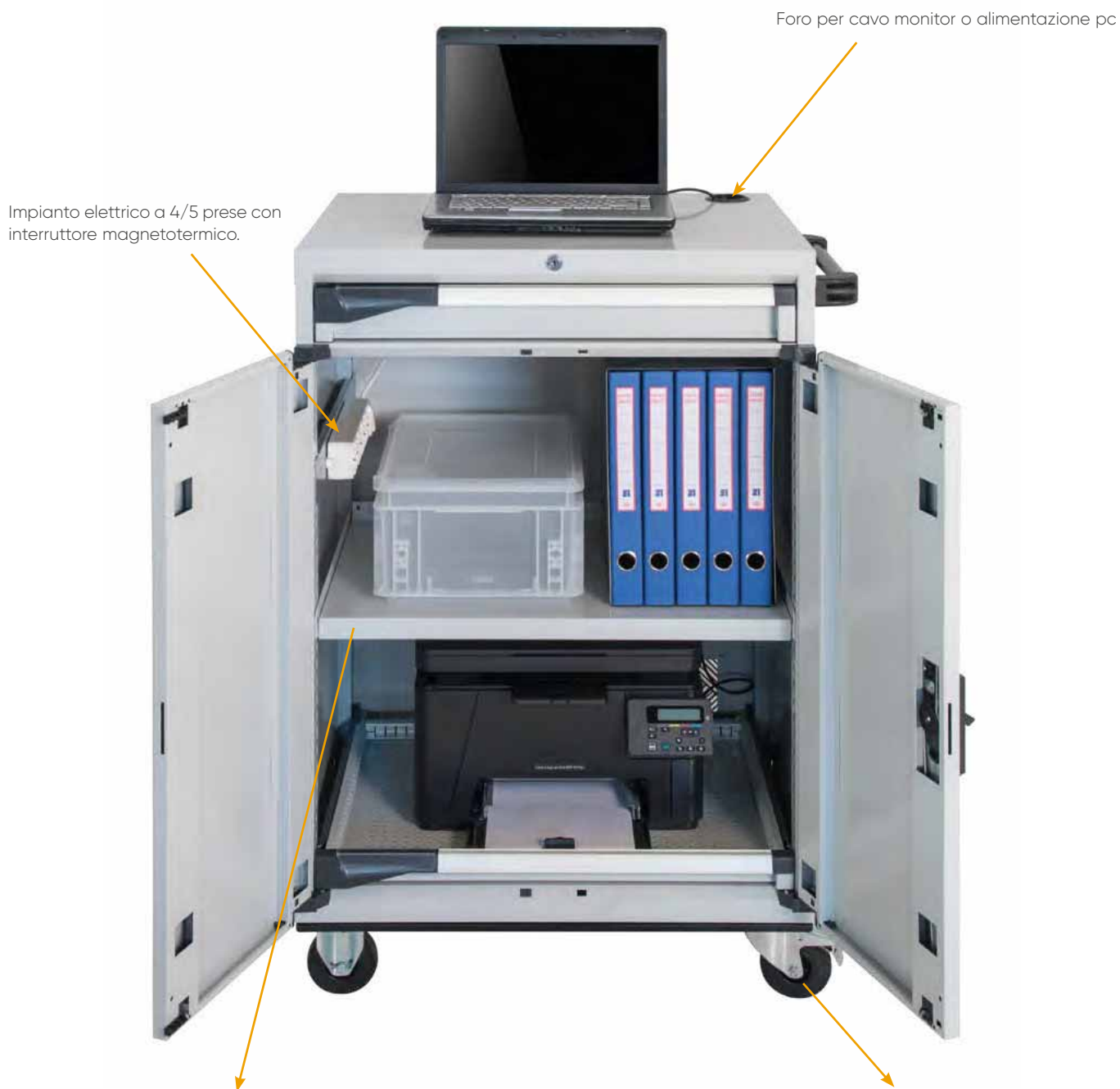

Foro per cavo monitor o alimentazione pc

Impianto elettrico a 4/5 prese con interruttore magnetotermico.

Vano con possibilità di inserimento di piani estraibili e piani regolabili in altezza, per l'alloggiamento di sistemi hardware e stampanti.
Larghezza inserimento utile: 663 mm
Altezza utile: 754 mm.

2 ruote fisse e 2 ruote girevoli con freno Ø 100 mm in nylon

VISTA POSTERIORE

Fori di entrata dell'aria con filtro antipolvere o ventola di raffreddamento.

Fori per cavi di rete e foro di uscita del cavo per l'impianto elettrico.



MODULO PORTA

Serratura di sicurezza e vetro in policarbonato.
Dimensioni utili: 655x215x465 mm H.



Possibilità di inserimento video fino a 27".
Dimensioni interne del vano superiore: 710x215x530 mm H.

MODULO TAPPARELLA

Ideale per schermi touch screen.
Dimensioni utili: 710x215x530 mm H.

Serratura di sicurezza e tapparella in plastica con maniglia ergonomica

Cassetto estraibile con piano porta tastiera
2 posizioni di bloccaggio, in apertura spazio posteriore per contenimento oggetti
Dimensioni utili: 655x465 mm H.

I MODULI CON **PORTA** E **TAPPARELLA** SONO PROGETTATI PER IL PASSAGGIO DEL CAVO DI ALIMENTAZIONE DEL MONITOR TRAMITE UNO SPAZIO TRA IL PIANO DI APPOGGIO E LA PARETE POSTERIORE.



MODULO PANNELLO FORATO CON PIANO A 3 BORDI RIVESTITO IN PVC

Costruito in lamiera di acciaio con fori per ganci porta utensili e porta practibox



MASTER CS



Gamma colori
ACCIAIO 



GRIGIO
RAL 7000
.01



VERDE
RAL 6011
.02



BLU
RAL 5012
.04



GRIGIO
RAL 7035
.08



BIANCO GRIGIASTRO
RAL 9002
.1F



ROSSO RUBINO
RAL 3003
.1G



BLU GENZIANA
RAL 5010
.34



BIANCO PURO
RAL 9010
.35



GRIGIO ANTRACITE
RAL 7016
.39



BLU CAPRI
RAL 5019
.48

Gamma colori PLASTICHE



DARK GREY
.M0

PORTATA DELL'ARMADIO 100 kg



SERRATURA A CHIAVE (KEY)
Fornita di serie, negli armadi la
chiusura a cilindro "C0".
A richiesta la versione "C1" o "C2".

LEGENDA



PORTATA
CASSETTO



ESTRAZIONE
CASSETTO



CHIUSURA
ARMADIO



LE PORTATE SONO NETTE E SI RIFERISCONO A PESI UNIFORMEMENTE DISTRIBUITI.

H 1731 mm







Modulo porta con vetro in policarbonato

Cassetto con piano porta tastiera

Piano regolabile

Piano estraibile

porta 775 mm H

ART.    

F AS 1500 10 08 50-75-100 100-96-92% key

Armadio base con ruote completo di MODULO PORTA con vetro in policarbonato, 1 cassetto con piano porta tastiera, 1 piano intermedio regolabile, 1 piano estraibile
Dimensioni ingombro mm 791x598x1731 H

H 1731 mm







Modulo tapparella

Cassetto con piano porta tastiera

Piano regolabile

Piano estraibile

porta 775 mm H

ART.    

F AS 1500 20 08 50-75-100 100-96-92% key

Armadio base con ruote completo di MODULO TAPPARELLA 1 cassetto con piano porta tastiera, 1 piano intermedio regolabile, 1 piano estraibile
Dimensioni ingombro mm 791x598x1731 H

H 1104 mm



Modulo base





Piano superiore a 3 bordi rivestito in PVC

Cassetto con piano porta tastiera

Piano regolabile

Piano estraibile

porta 775 mm H

ART.    

F AS 1400 02 08 50-75-100 100-96-92% key

MODULO BASE con ruote, 1 cassetto con piano porta tastiera, 1 piano superiore a 3 bordi rivestito in PVC, 1 piano intermedio regolabile, 1 piano estraibile
Dimensioni ingombro mm 791x598x1104 H

H 1800 mm



Modulo pannello forato





Piano superiore a 3 bordi rivestito in PVC

Cassetto con piano porta tastiera

Piano regolabile

Piano estraibile

porta 775 mm H

ART.    

F AS 1400 03 08 50-75-100 100-96-92% key

Armadio base con ruote completo di MODULO PANNELLO FORATO, 1 piano superiore a 3 bordi rivestito in PVC, 1 cassetto con piano porta tastiera, 1 piano intermedio regolabile, 1 piano estraibile
Dimensioni ingombro mm 791x598x1800 H



2 ruote fisse in nylon Ø 100 mm
2 ruote girevoli con freno in nylon Ø 100 mm



ESCLUSO IMPIANTO ELETTRICO E VENTOLA



I MODULI CON PORTE IN VETRO POLICARBONATO, CON TAPPARELLA E PANNELLO FORATO NON VENGONO MONTATI AL MODULO BASE.
FORNITI DI SERIE CON IL MATERIALE PER FISSAGGIO

CONFIGURA IL TUO ARMADIO



Cassetto completo di piano verniciato grigio RAL7035 per tastiera

MODULO BASE CON RUOTE

ART.				
F AS 1400 01 _ _		50-75-100	100-96-92%	key

ARMADIO CON PORTE A BATTENTE

Completo di 2 griglie esterne con filtro antipolvere, piastra con fori di uscita per cavi di rete e impianto elettrico, maniglia laterale, cassetto con piano per tastiera, foro superiore con passacavo in plastica nera, coppia piastre con 2 ruote fisse e 2 ruote girevoli con freno Ø 100 mm in nylon
 Dimensioni ingombro mm 791x598x1081 H
 Dimensioni utili: 663x754 mm H



PIANI ESTRAIBILI AD ESTRAZIONE FLESSIBILE

ART.		Dim. utili mm	H frontale mm		
M 32 C057 0110 OF _ _		600x447	70	50 - 75 - 100	100% - 96% - 92%



PIANO REGOLABILE

ART.		Dim. utili mm	H totale mm	
M 32 PR25 00 0001 _ _		657x478	60	150



I MODULI CON PORTE IN VETRO POLICARBONATO, CON TAPPARELLA E PANNELLO FORATO NON VENGONO MONTATI AL MODULO BASE. FORNITI DI SERIE CON IL MATERIALE PER FISSAGGIO



MODULO TAPPARELLA

ART.



F AS 1450 20 _ _

key

Dimensioni: 710x215x530 mm H

Dimensioni utili: 655x215x465 mm H

Completo di viti per il fissaggio al modulo base



MODULO PORTA CON VETRO IN POLICARBONATO

ART.



F AS 1450 10 _ _

key

Dimensioni: 710x215x530 mm H

Dimensioni utili: 655x215x465 mm H

Completo di viti per il fissaggio al modulo base

I MODULI CON PORTA E TAPPARELLA POSSONO ESSERE UTILIZZATI IN MODO INDIPENDENTE SU BANCHI O POSTAZIONI DI LAVORO.



PANNELLO FORATO

ART.



dim. mm

M 30 PA71 00 00 00 _ _

708x65x718 H



ART. M 00 PA71 00 00 F1 00

FORATURA PIANO SUPERIORE A 3/4 BORDI PER IL FISSAGGIO DEL PANNELLO FORATO - COMPRESIVO DI VITI



ART. M 00 T023 AG 00 F1 00
FORATURA PER TOP A 3 BORDI PER PASSAGGIO CAVO



PIANO SUPERIORE A 3 BORDI

ART.

dim. mm

M 32 T023 AG 00 31 07

714x573x23 H

Piano rivestito in pvc. Colore nero



Lunghezza cavo 2 m
Completa di supporto zincato

PRESA MOBILE MULTIPLA, 4 PRESE UNIVERSALI, POTENZA MAX 3680 W

ART.

F AS 4000 01 00

PRESA MOBILE MULTIPLA 2P+T 16 A 250 V ~

-4 prese universali potenza max 3680 W per :

eurospine 2P 2,5 A

spine standard italiano 2P e 2P+T 10 A e 16 A

spine standard tedesco 2P+T 16 A

spine 2P standard americano spinotti piatti 15 A 125 V~ non polarizzato

-2 m di cavo 3G 1 mm² e spina 2P+T 16 A 250 V ~ standard tedesco (Schuko)

Grado di protezione IP 20

nota: non realizza il collegamento di terra 2P+T 16 A 250 V ~ standard francese

CONFORMITÀ NORMATIVA

Norma CEI 23-124



Lunghezza cavo 3,5 m
Completa di supporto zincato

PRESA MOBILE MULTIPLA 5 PRESE

TIPO E NUMERO PRESE CABLATE

ART.	TIPO E NUMERO PRESE CABLATE					
	D	F	GB	I	CH	IL
F AS 4100 11 00	5	-	-	-	-	-
F AS 4100 21 00	2	3	-	-	-	-
F AS 4100 31 00	2	-	2	-	-	-
F AS 4100 41 00	2	-	-	3	-	-
F AS 4100 51 00	2	-	-	-	3	-
F AS 4100 71 00	2	-	-	-	-	3

PRESA MOBILE MULTIPLA 220-250V~ 10A 2P+T:

-interruttore magnetotermico 230V~ 10A

-5 prese 220-250V~ 10A 2P+T (vedi tabella)

-1 spina industriale 220-250V~ 16A 2P+T

Grado di protezione IP 30

CONFORMITÀ NORMATIVA

Norma CEI EN 60204-1:

-continuità circuito protezione equipotenziale

-tensione applicata

-resistenza all'isolamento



SUPPORTO PRESA ZINCATO

ART.	dim. mm
F AS 3021 00 99	550x10x67 H



VENTOLA

ART.
F AS 3220 01 00

Ventola 220V cablata senza griglia con spina Schuko



PROFILO

ART.
F AS 4000 PC 07

Profilo passacavo in plastica a 4 canali lunghezza 1000 mm



**AIUTA LA TUA AZIENDA
SALVAGUARDANDO
L'AMBIENTE**





ECOLOGIA

ECOLOGIA

ARMADI DI SICUREZZA PER VERNICI, SOLVENTI E FITOSANITARI

- Dotati di ampie feritoie per il ricambio d'aria e di rete rompifiamma interna
- Vasca di raccolta sul fondo per la pulizia periodica
- Ripiani forati per l'eventuale sgocciolamento di liquidi
- Continuità elettrica e segnaletica adesiva esterna secondo le norme vigenti

H 2008 mm



H 1008 mm



- **ART. F AA 1620 01 30**
ARMADIO DI SICUREZZA
PER VERNICI E SOLVENTI

- **ART. F AA 1612 01 02**
ARMADIO DI SICUREZZA
PER FITOSANITARI

Gamma colori
ACCIAIO



GIALLO
RAL 1004
.30



VERDE
RAL 6011
.02



CHIUSURA A CILINDRO (KEY)
FORNITA DI SERIE CON CHIUSURA A CILINDRO
E 2 CHIAVI

LEGENDA



PORTATA
PIANO



CAPACITÀ
LITRI



CHIUSURA
ARMADIO



LE PORTATE SONO NETTE E SI RIFERISCONO A PESI UNIFORMEMENTE DISTRIBUITI

H 2008 mm



ART.	kg	L	lock
F AA 1620 01 30	100	47	key

D.LGS 81/2008 TESTO UNICO SICUREZZA SUL LAVORO
4 piani regolabili forati ART. F AC 2530 01 99
vasca sul fondo

H 1008 mm



ART.	kg	L	lock
F AA 1610 01 30	100	47	key

D.LGS 81/2008 TESTO UNICO SICUREZZA SUL LAVORO
2 piani regolabili forati ART. F AC 2530 01 99
vasca sul fondo

H 2008 mm



ART.	kg	L	lock
F AA 1622 01 02	100	47	key

CONFORMI AL DPR 290/01
4 piani regolabili forati ART. F AC 2530 01 99
vasca sul fondo

H 1008 mm



ART.	kg	L	lock
F AA 1612 01 02	100	47	key

CONFORMI AL DPR 290/01
2 piani regolabili forati ART. F AC 2530 01 99
vasca sul fondo



PIANO REGOLABILE FORATO

ART. F AC 2530 01 99 - dim. mm 995x500x35 H
completo di 1 set con 4 ganci

VASCA RACCOLTA OLIO

ART. F AC 7900 00 99 - dim. mm 958x527x99 H
capacità vasca 47 litri

SUPPORTI ECOLOGICI PER FUSTI E CISTERNE

Contenitori ecologici conformi alle leggi vigenti relative alla tutela ambientale, quali messa in sicurezza in situazioni di rischio e salvaguardia del suolo, sottosuolo e falde acquifere. Per evitare che si manifestino accidentali dispersioni di fluidi in caso di perdita o rottura, la griglia asportabile su cui poggiano i fusti permette che il contenuto defluisca nel sottostante bacino di sicurezza. La modellatura del fondo risulta studiata per permettere la movimentazione mediante carrello elevatore o transpallet. Si raccomanda di posizionare questi contenitori su superfici piane e protette in caso di situazioni atmosferiche che possano alterarne il regolare esercizio.

VASCHE SENZA PARETI



ART.	dim. mm	quantità fusti	L	
F ML 0810 00 54	960x960x332 H	1	200	
F ML 0820 00 54	1355x875x332 H	2	250	
F ML 0830 00 54	1355x1255x290 H	4	300	
F ML 0820 01 54	1355x1355x875x332 H	4	500	
F ML 0830 01 54	1355x1355x1255x290 H	8	600	

Contenitori ecologici porta fusti dotati di grigliato superiore zincato e di staffe per trasporto con carrello elevatore

VASCHE D.LGS. 152/2006 TESTO UNICO AMBIENTALE

 54
ZINCATO + RAL5012

LEGENDA



CAPACITÀ
LITRI



Ø RUOTE



LE PORTATE SONO NETTE E SI RIFERISCONO A PESI UNIFORMEMENTE DISTRIBUITI

CARRELLI PORTA FUSTI



ART.	dim. mm	quantità fusti	L	125
F ML 0840 00 54	1425x875x1155 H	2	320	125 mm

Completi di 2 ruote fisse e 2 ruote girevoli con freno ø 125 mm in gomma standard

 54
ZINCATO + RAL5012



ART.	dim. mm	quantità fusti	L	125
F ML 0840 01 54	1425x880x1155 H	1	320	125 mm

Completi di 2 ruote fisse e 2 ruote girevoli con freno ø 125 mm in gomma standard
Con supporto

 54
ZINCATO + RAL5012



ART.	dim. mm	quantità fusti	L	125
F AX 407000 2000 54	940x1010x1160 H	1	320	125 mm

Completi di 2 ruote fisse e 2 ruote girevoli con freno ø 125 mm in gomma standard

 54
ZINCATO + RAL5012

BASE CIRCOLARE PER FUSTI

ART.	dim. mm
F AX 407001 0000 04	620x620

 04
RAL 5012



Base circolare per fusti 200 Litri

ECOLOGIA



ART.	dim. mm
F ML 0850 12 04	1420x670x760 H

Capacità fusti litri 2x200 impilabile,
per vasca F ML 0830 00 54

 04
RAL 5012



ART.	dim. mm
F ML 0850 13 04	1420x670x760 H

Capacità fusti litri 3x60 impilabile,
per vasca F ML 0830 00 54

 04
RAL 5012



ART.	dim. mm
F ML 0860 02 04	1360x600x400 H

Capacità fusti litri 2x200 non impilabile,
per vasca F ML 0830 00 54

 04
RAL 5012



ART.	dim. mm
F ML 0860 03 04	1360x600x400 H

Capacità fusti litri 3x60 non impilabile,
per vasca F ML 0830 00 54

 04
RAL 5012



ART.	dim. mm
F ML 0860 01 04	880x600x400 H

Capacità fusti litri 1x200 non impilabile,
per vasca F ML 0820 00 54

 04
RAL 5012



Composto da:
1 ART. F ML 0830 00 54 RAL5012 + ZINCATO
1 ART. F ML 0850 12 04 RAL5012
1 ART. F ML 0850 13 04 RAL5012

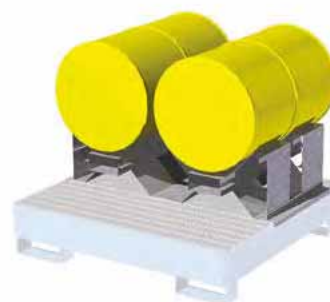

SUPPORTO SOVRAPPONIBILE PER FUSTI

ART.	dim. mm
F AX 409000 4000 99	1258x1050x340 H

Colore zincato
Adatto per vasca F ML 0830 00 54,
impilabile, inforcabile e palettizzabile

PORTA CISTERNA IN ACCIAIO

Vasca di stoccaggio per contenitori lt. 1000. Altezza dal suolo di 100 mm, dotati di supporti forconabili per il trasporto tramite carrello elevatore o transpallet.



ART.	dim. mm	quantità cisterne	L	trespolo
F AX VDRHV0 0000 54	1350x1500x640 H	1	1000	-

 54
ZINCATO + RAL5012



ART.	dim. mm	quantità cisterne	L	trespolo
F AX VDRG10 00V0 54	1350x1500x1100 H	1	1000	SI

 54
ZINCATO + RAL5012



ART.	dim. mm	quantità cisterne	L	trespolo
F AX 402085 0000 54	2680x1350x400 H	2	1000	-

 54
ZINCATO + RAL5012

TRESPOLO



ART.	dim. mm
F AX VDRT10 00TO 04	1350x1256x485 H

TRESPOLO PORTA CISTERNA SENZA GRIGLIA per:
F AX 402085 0000 54, F AX 402085 0A00 54,
F AX 402085 0ATA 54, F AX VDRHV0 0000 54

 04
RAL 5012

CISTERNA



ART.	dim. mm
F AX PACK13 UN00 00	1200x1000x1147 H

Tanica in plastica dotata di gabbia in metallo capacità 1000 Litri

L'ARMADIO
PRATICO E
SICURO PER OLI



MASTER FO

CARATTERISTICHE TECNICHE

Progettati per il prelievo e lo stoccaggio di taniche gli armadi porta oli, completi di porte a battente, rappresentano una pratica soluzione per organizzare tutti i liquidi

Le vasche di recupero liquidi sono realizzate per essere a tenuta stagna e resistono alla corrosione sia nella versione zincata che verniciata. Disponibili in diverse configurazioni con piani ad estrazione telescopica portata di 200 kg o piani fissi regolabili in altezza.



PORTE A BATTENTE

Le porte a battente sono realizzate in robusta lamiera di acciaio debitamente sagomata, con un ingombro in profondità di 25 mm. La chiusura a 3 punti garantisce un'elevata sicurezza allo scasso. Disponibili con chiusura a cilindro e due chiavi.



VASCA DI RECUPERO OLIO

La vasca di recupero è costruita in lamiera d'acciaio zincata con spessore 10/10 ed è a tenuta stagna, serve per raccogliere eventuali gocce che potrebbero cadere a fine prelievo o in caso di rottura delle taniche. Scorre su guide a "L" fissate sui montanti laterali dell'armadio.



VASCA ESTERNA PER OLIO

La vasca esterna di sicurezza per olio ha una capacità di 77 lt. ed è a tenuta stagna. Solleva l'armadio da terra di 150 mm ed è la soluzione più completa e sicura in caso di rottura e perdita d'olio di più taniche.

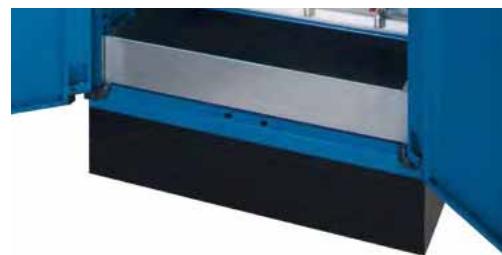

PIANI

-Piani in lamiera di acciaio altezza totale 60 mm regolabili in altezza con passo di 25 mm, portata 150 kg.



-Piani ad estrazione telescopica, con portata di 200 kg, con all'interno un piano in lamiera di acciaio con scolo per la protezione del fondo verniciato.



MASTER FO

H 1650 mm



Gamma colori
ACCIAIO



GRIGIO
RAL 7000
.01



VERDE
RAL 6011
.02



BLU
RAL 5012
.04



GRIGIO
RAL 7035
.08



BIANCO GRIGIASTRO
RAL 9002
.1F



ROSSO RUBINO
RAL 3003
.1G



BLU GENZIANA
RAL 5010
.34



BIANCO PURO
RAL 9010
.35



GRIGIO ANTRACITE
RAL 7016
.39



BLU CAPRI
RAL 5019
.48



● ART. M 33 A150 CO 30 SN 04

Gamma colori

PLASTICHE TAPPI



DARK GREY
.M0



SERRATURA A CHIAVE (KEY)
Fornita di serie, negli armadi la chiusura a cilindro "C0".
A richiesta la versione "C1" o "C2".



ART. F AG 9200 00 99

Coppia staffe zincate per il fissaggio dell'armadio a parete o dove possibile a pavimento

ART. F AG 9204 00 99

2 tasselli "HILTI" adatti per pavimenti in calcestruzzo non fessurato maggiore o uguale alla classe C20/25
Trazione consigliata del tassello: 2,9 kN
Diametro tassello: Ø 6 mm



GLI ARMADI CON VASCA ESTERNA **77 LITRI** SONO FORNITI DI SERIE CON STAFFE PER IL FISSAGGIO A TERRA (ESCLUSI TASSELLI)

LEGENDA



PORTATA
PIANO
ESTRAIBILE



CAPACITÀ
LITRI



CHIUSURA
ARMADIO



LE PORTATE SONO NETTE E SI RIFERISCONO A PESI UNIFORMEMENTE DISTRIBUITI

H 1500 mm



ART.				
M 33 A150 C0 30 RG 04		200	120	key

Armadio completo di:
 2 piani ad estrazione telescopica 100%,
 4 taniche in plastica capacità 25 lt., 5 taniche in plastica capacità 10 lt.,
 1 vasca estraibile di sicurezza per olio capacità 40 lt.
 - Totale capacità di contenimento dell'armadio: 150 lt
 - Capacità della vasca di sicurezza per olio: 40 lt

H 1650 mm



ART.				
M 33 A150 C0 30 RH 04		200	150	key

Armadio completo di:
 2 piani ad estrazione telescopica 100%,
 4 taniche in plastica capacità 25 lt., 5 taniche in plastica capacità 10 lt.,
 1 vasca estraibile di sicurezza per olio capacità 40 lt., 1 vasca esterna di sicurezza per olio capacità 77 lt., 2 tappi per vasca
 - Totale capacità di contenimento dell'armadio: 150 lt
 - Capacità delle vasche di sicurezza per olio: 117 lt

H 1500 mm



ART.				
M 33 A150 C0 30 RK 04		200	120	key

Armadio completo di:
 2 piani ad estrazione telescopica 100%,
 8 taniche in plastica capacità 25 lt.,
 1 vasca estraibile di sicurezza per olio capacità 40 lt.
 - Totale capacità di contenimento dell'armadio: 120 lt
 - Capacità della vasca di sicurezza per olio: 40 lt

H 1650 mm



ART.				
M 33 A150 C0 30 RL 04		200	200	key

Armadio completo di:
 2 piani ad estrazione telescopica 100%,
 8 taniche in plastica capacità 25 lt.,
 1 vasca estraibile di sicurezza per olio capacità 40 lt., 1 vasca esterna di sicurezza per olio capacità 77 lt. 2 tappi per vasca
 - Totale capacità di contenimento dell'armadio: 200 lt
 - Capacità delle vasche di sicurezza per olio: 117 lt

H 1500 mm



ART.				
M 33 A150 C0 30 RM 04		200	120	key

Armadio completo di:
 3 piani ad estrazione telescopica 100%,
 4 taniche in plastica capacità 25 lt., 10 taniche in plastica capacità 10 lt.,
 1 vasca estraibile di sicurezza per olio capacità 40 lt.
 - Totale capacità di contenimento dell'armadio: 120 lt
 - Capacità della vasca di sicurezza per olio: 40 lt

H 1650 mm



ART.				
M 33 A150 C0 30 SN 04		200	200	key

Armadio completo di:
 3 piani ad estrazione telescopica 100%,
 4 taniche in plastica capacità 25 lt., 10 taniche in plastica capacità 10 lt.,
 1 vasca estraibile di sicurezza per olio capacità 40 lt., 1 vasca esterna di sicurezza per olio capacità 77 lt., 2 tappi per vasca
 - Totale capacità di contenimento dell'armadio: 200 lt
 - Capacità delle vasche di sicurezza per olio: 117 lt

H 1500 mm



ART.				
M 33 A150 C0 30 SP 04		200	120	key

Armadio completo di:
 2 piani ad estrazione telescopica 100%,
 4 taniche in plastica capacità 25 lt., 5 taniche in plastica capacità 10 lt.,
 1 piano regolabile in altezza portata 150 kg - profondità 618 mm
 1 vasca estraibile di sicurezza per olio capacità 40 lt.
 - Totale capacità di contenimento dell'armadio: 120 lt
 - Capacità della vasca di sicurezza per olio: 40 lt

H 1650 mm



ART.				
M 33 A150 C0 30 SQ 04		200	150	key

Armadio completo di:
 2 piani ad estrazione telescopica 100%,
 4 taniche in plastica capacità 25 lt., 5 taniche in plastica capacità 10 lt.,
 1 piano regolabile in altezza portata 150 kg - profondità 618 mm
 1 vasca estraibile di sicurezza per olio capacità 40 lt., 1 vasca esterna di sicurezza per olio capacità 77 lt., 2 tappi per vasca
 - Totale capacità di contenimento dell'armadio: 150 lt
 - Capacità delle vasche di sicurezza per olio: 117 lt



OTTIMIZZAZIONE DEGLI SPAZI
TRASPORTO SICURO
SICUREZZA
PULIZIA
VISIBILITÀ

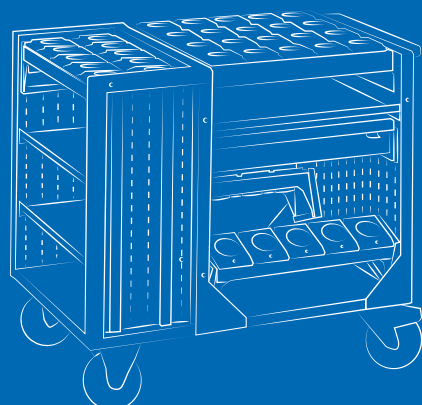
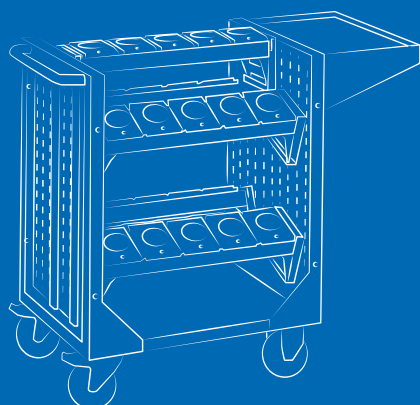

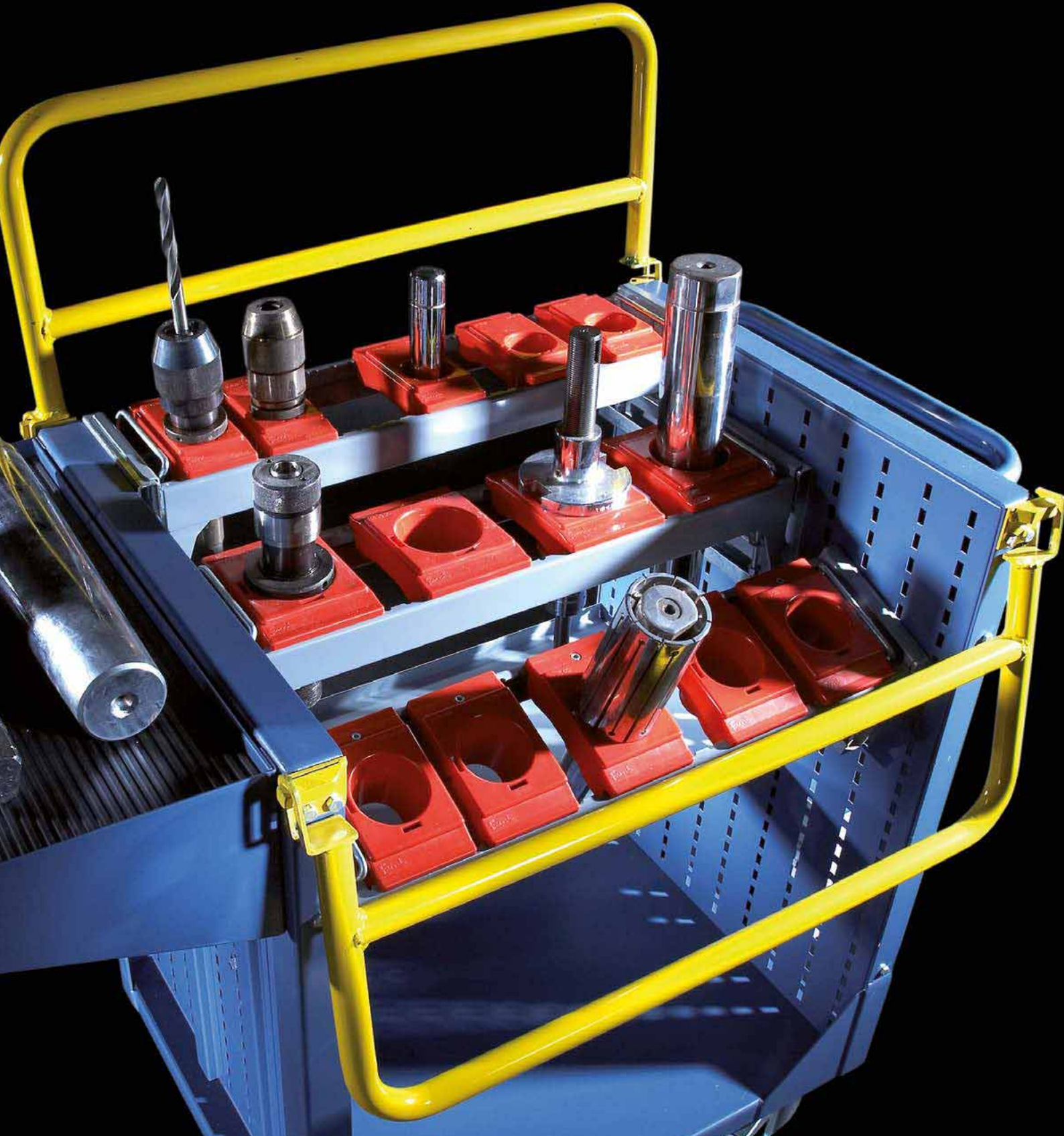

NC COMBI – PERFOM

CARATTERISTICHE TECNICHE

Organizzazione, protezione, sicurezza e trasporto per utensili NC: i carrelli NC Combi e gli armadi NC Perform, disponibili in diverse soluzioni, rispondono in modo adeguato alla logistica dei centri a controllo numerico.

COLORI

4 colori per la parte metallica

RAL 7000

RAL 6011

RAL 5012

RAL 7035



BOCCOLE

Costruite in ABS, resistenti agli urti e agli oli minerali, si fissano al telaio con vite per dare maggiore sicurezza durante la movimentazione dei mandrini. Disponibili in diverse versioni per ospitare una vasta gamma di utensili presenti nel mercato.



TELAI

I telai porta boccole sono interamente saldati e possono essere alloggiati all'interno dei cassetti, con supporti che ne regolano l'altezza, o sospesi all'interno dell'armadio o del carrello. I sostegni laterali e centrali che compongono le file sono lisci e danno la libertà di posizionare le boccole in qualsiasi punto del telaio.

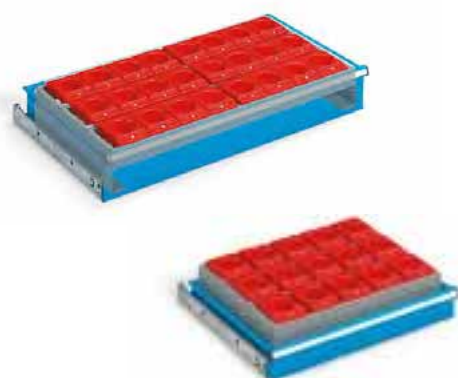

CASSETTI

I cassetti sono forniti con estrazione semplice (pari al 87%) e con estrazione telescopica (100%) su cuscinetti a sfera ad alta resistenza. Si prestano ad alloggiare i telai porta boccole tramite una coppia supporti da fissare sul fondo forato.



I telai sono regolabili in altezza e possono essere montati orizzontali o inclinati.



RUOTE



RUOTE IN GOMMA STANDARD



RUOTE IN GOMMA ANTISTRACCIATA



RUOTE IN GOMMA ELASTICA



RUOTE IN POLIURETANO



RUOTE IN NYLON

PRESERVIAMO I TUOI UTENSILI NEL TEMPO



PORTA A BATTENTE



PORTA SCORREVOLE



TAPPARELLA



LE PORTATE NELLE SEZIONI SONO NETTE E SI RIFERISCONO A PESI UNIFORMEMENTE DISTRIBUITI

TELAIO DA BANCO



ART. F NC 2010 00 04

Dim. mm 565x450x350 H
SENZA BOCCOLE

Gamma colori
ACCIAIO



RAL 7000
.01



RAL 6011
.02



RAL 5012
.04



RAL 7035
.08

ART.	Tipo di boccola	Qtà boccole per telaio
F NC 9510 00 03	ISO 30	24
F NC 9530 00 03	ISO 40	24
F NC 9540 00 03	ISO 45	18
F NC 9550 00 03	ISO 50	15
F NC 9560 00 03	VDI 30	24
F NC 9570 00 03	VDI 40	18
F NC 9580 00 03	VDI 50	18
F NC 9590 00 03	VDI 60	15
F NC 9720 00 03	CONO MORSE 2	24
F NC 9730 00 03	CONO MORSE 3	24
F NC 9740 00 03	CONO MORSE 4	24
F NC 9750 00 03	CONO MORSE 5	18
F NC 9270 00 03	CAPTO C3	24
F NC 9275 00 03	CAPTO C4	18
F NC 9280 00 03	CAPTO C5	18

ART.	Tipo di boccola	Qtà boccole per telaio
F NC 9285 00 03	CAPTO C6	18
F NC 9290 00 03	CAPTO C8	15
F NC 9210 00 03	HSK A32-B40	24
F NC 9220 00 03	HSK A40-B50	24
F NC 9230 00 03	HSK A50-B63	18
F NC 9240 00 03	HSK A63-B80	18
F NC 9250 00 03	HSK A80-B100	15
F NC 9260 00 03	HSK A100-B125	15
F NC 9640 00 03	2"	18
F NC 9650 00 03	2" 1/4	15
F NC 9010 00 03	58 mm	27
F NC 9020 00 03	65 mm	24
F NC 9030 00 03	75 mm	21
F NC 9040 00 03	87 mm	18
F NC 9050 00 03	105 mm	15

BOCCOLE

BOCCOLA ISO 30

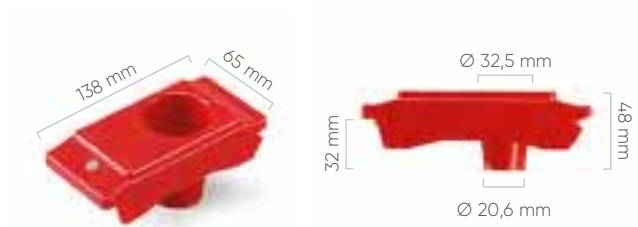

ART.	Confezione	Dim. mm	
F NC 9510 00 03	1 pz	65x138x48 H	
F NC 9510 01 03	10 pz	65x138x48 H	

BOCCOLA ISO 40

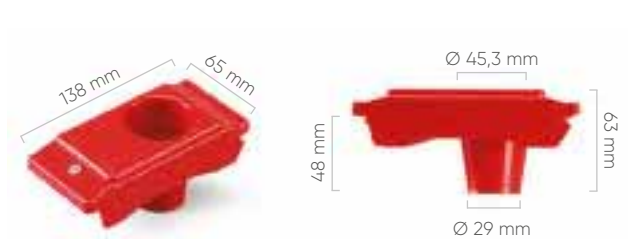

ART.	Confezione	Dim. mm	
F NC 9530 00 03	1 pz	65x138x63 H	
F NC 9530 01 03	10 pz	65x138x63 H	

BOCCOLA ISO 45

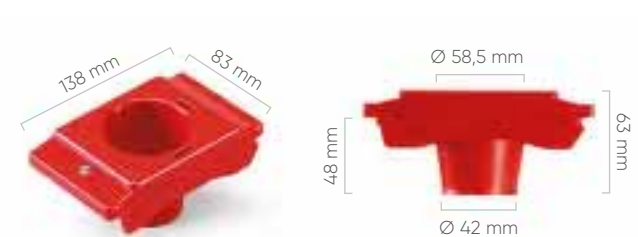

ART.	Confezione	Dim. mm	
F NC 9540 00 03	1 pz	83x138x63 H	
F NC 9540 01 03	10 pz	83x138x63 H	

BOCCOLA ISO 50

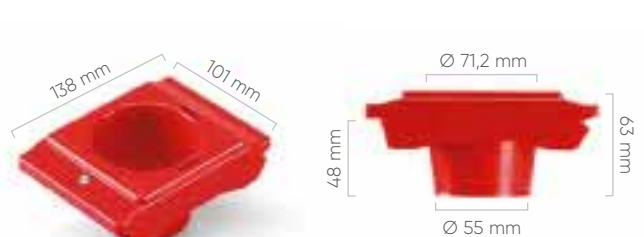

ART.	Confezione	Dim. mm	
F NC 9550 00 03	1 pz	101x138x63 H	
F NC 9550 01 03	10 pz	101x138x63 H	

BOCCOLA VDI 30

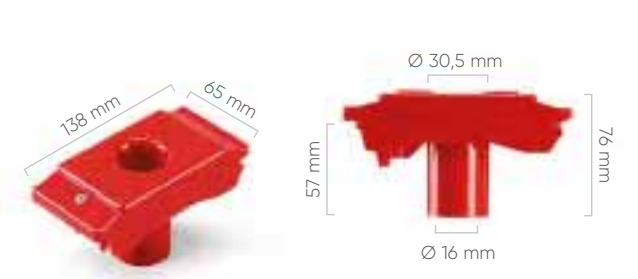

ART.	Confezione	Dim. mm	
F NC 9560 00 03	1 pz	65x138x76 H	
F NC 9560 01 03	24 pz	65x138x76 H	

BOCCOLA VDI 40

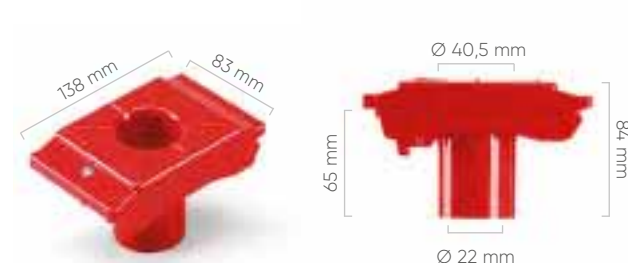

ART.	Confezione	Dim. mm	
F NC 9570 00 03	1 pz	83x138x84 H	
F NC 9570 01 03	24 pz	83x138x84 H	

BOCCOLE

BOCCOLA VDI 50



ART.	Confezione	Dim. mm
F NC 9580 00 03	1 pz	83x138x99 H
F NC 9580 01 03	16 pz	83x138x99 H

BOCCOLA VDI 60

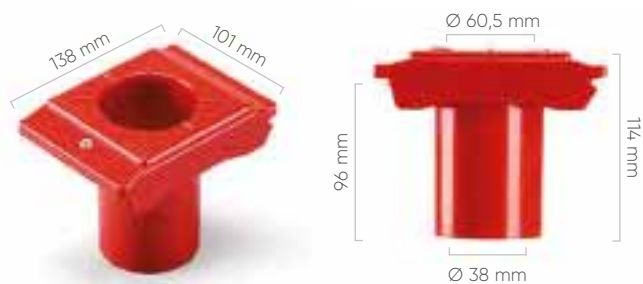

ART.	Confezione	Dim. mm
F NC 9590 00 03	1 pz	101x138x114 H
F NC 9590 01 03	16 pz	101x138x114 H

BOCCOLA 2"

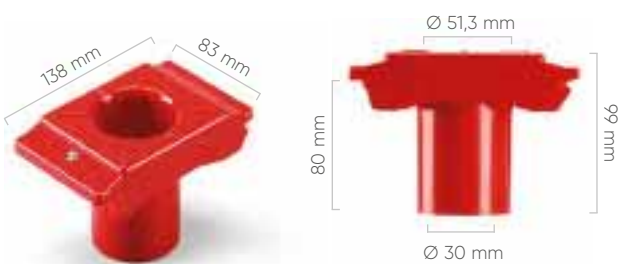

ART.	Confezione	Dim. mm
F NC 9640 00 03	1 pz	83x138x99 H
F NC 9640 01 03	24 pz	83x138x99 H

BOCCOLA 2" 1/4

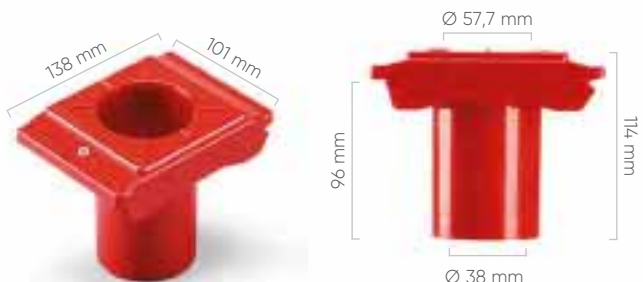

ART.	Confezione	Dim. mm
F NC 9650 00 03	1 pz	101x138x114 H
F NC 9650 01 03	16 pz	101x138x114 H



BOCCOLA CONO MORSE 2

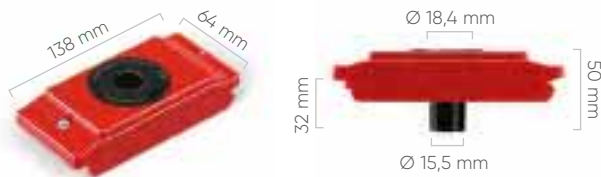

ART.	Confezione	Dim. mm	
F NC 9720 00 03	1 pz	64x138x50 H	
F NC 9720 01 03	4 pz	64x138x50 H	

BOCCOLA CONO MORSE 3

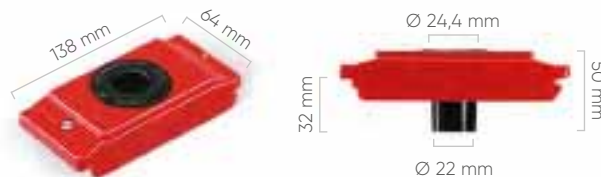

ART.	Confezione	Dim. mm	
F NC 9730 00 03	1 pz	64x138x50 H	
F NC 9730 01 03	4 pz	64x138x50 H	

BOCCOLA CONO MORSE 4

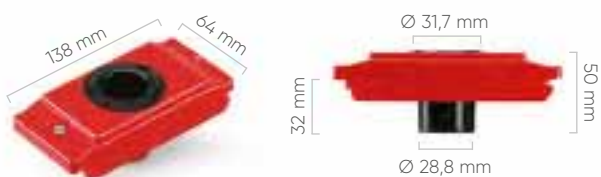

ART.	Confezione	Dim. mm	
F NC 9740 00 03	1 pz	64x138x50 H	
F NC 9740 01 03	4 pz	64x138x50 H	

BOCCOLA CONO MORSE 5

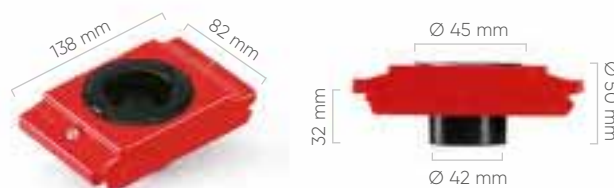

ART.	Confezione	Dim. mm	
F NC 9750 00 03	1 pz	82x138x50 H	
F NC 9750 01 03	4 pz	82x138x50 H	

BOCCOLA CAPTO C3

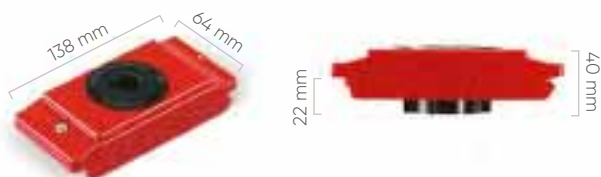

ART.	Confezione	Dim. mm	
F NC 9270 00 03	1 pz	64x138x40 H	
F NC 9270 01 03	10 pz	64x138x40 H	

BOCCOLA CAPTO C4

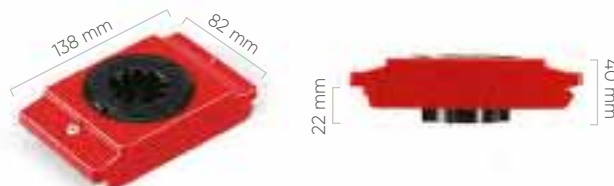

ART.	Confezione	Dim. mm	
F NC 9275 00 03	1 pz	82x138x40 H	
F NC 9275 01 03	10 pz	82x138x40 H	

BOCCOLA CAPTO C5

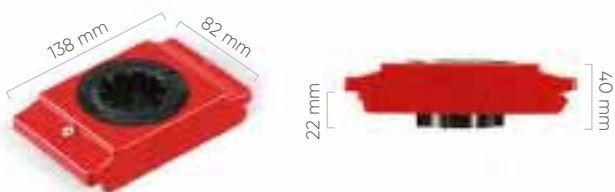

ART.	Confezione	Dim. mm	
F NC 9280 00 03	1 pz	82x138x40 H	
F NC 9280 01 03	10 pz	82x138x40 H	

BOCCOLA CAPTO C6

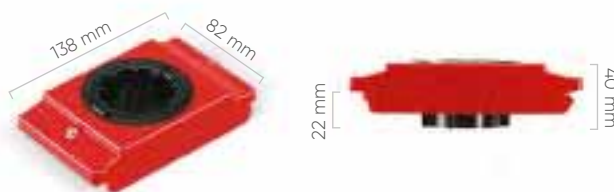

ART.	Confezione	Dim. mm	
F NC 9285 00 03	1 pz	82x138x40 H	
F NC 9285 01 03	10 pz	82x138x40 H	

BOCCOLA CAPTO C8

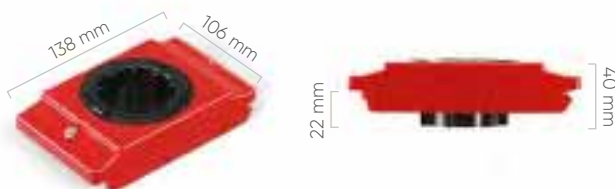

ART.	Confezione	Dim. mm	
F NC 9290 00 03	1 pz	106x138x40 H	
F NC 9290 01 03	10 pz	106x138x40 H	

BOCCOLE

BOCCOLA HSK A32-B40



ART.	Confezione	Dim. mm
F NC 9210 00 03	1 pz	64x138x30 H
F NC 9210 01 03	10 pz	64x138x30 H

BOCCOLA HSK A40-B50

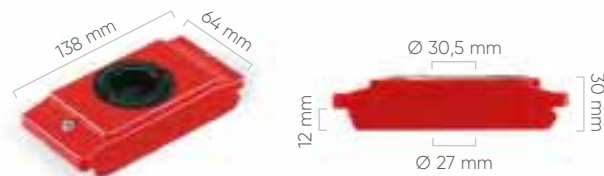

ART.	Confezione	Dim. mm
F NC 9220 00 03	1 pz	64x138x30 H
F NC 9220 01 03	10 pz	64x138x30 H

BOCCOLA HSK A50-B63

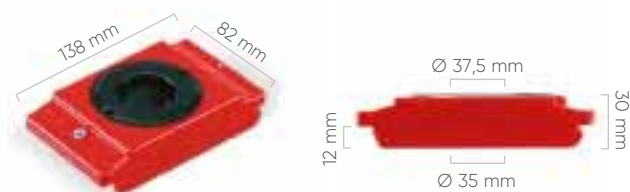

ART.	Confezione	Dim. mm
F NC 9230 00 03	1 pz	82x138x30 H
F NC 9230 01 03	10 pz	82x138x30 H

BOCCOLA HSK A63-B80

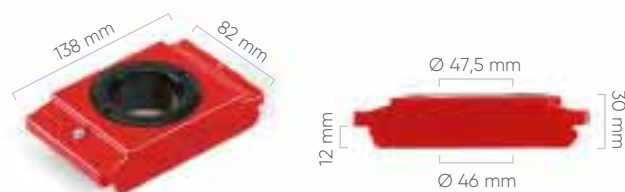

ART.	Confezione	Dim. mm
F NC 9240 00 03	1 pz	82x138x30 H
F NC 9240 01 03	10 pz	82x138x30 H

BOCCOLA HSK A80-B100

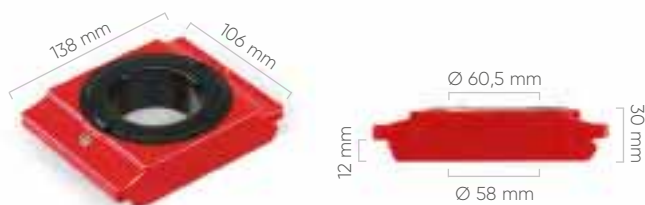

ART.	Confezione	Dim. mm
F NC 9250 00 03	1 pz	106x138x30 H
F NC 9250 01 03	10 pz	106x138x30 H

BOCCOLA HSK A100-B125

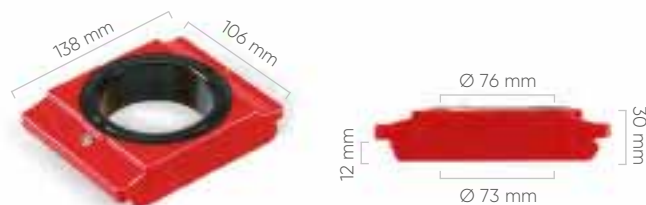

ART.	Confezione	Dim. mm
F NC 9260 00 03	1 pz	106x138x30 H
F NC 9260 01 03	10 pz	106x138x30 H

BOCCOLA 58 mm

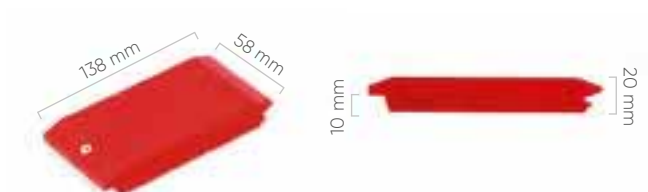

ART.	Confezione	Dim. mm	
F NC 9010 00 03	1 pz	58x138x20 H	
F NC 9010 01 03	10 pz	58x138x20 H	

BOCCOLA 65 mm

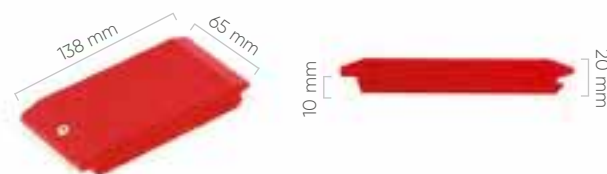

ART.	Confezione	Dim. mm	
F NC 9020 00 03	1 pz	65x138x20 H	
F NC 9020 01 03	10 pz	65x138x20 H	

BOCCOLA 75 mm

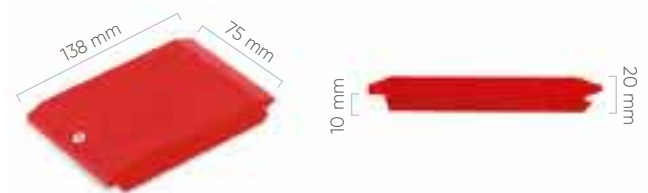

ART.	Confezione	Dim. mm	
F NC 9030 00 03	1 pz	75x138x20 H	
F NC 9030 01 03	10 pz	75x138x20 H	

BOCCOLA 87 mm

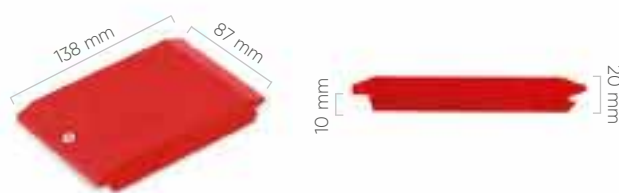

ART.	Confezione	Dim. mm	
F NC 9040 00 03	1 pz	87x138x20 H	
F NC 9040 01 03	10 pz	87x138x20 H	

BOCCOLA 105 mm

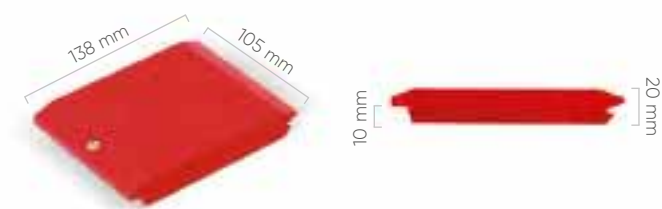

ART.	Confezione	Dim. mm	
F NC 9050 00 03	1 pz	105x138x20 H	
F NC 9050 01 03	10 pz	105x138x20 H	



● ART. F CN F100 10 51

H = 890 mm

Coppia protezioni laterali e boccole non incluse

Gamma colori

ACCIAIO 



GRIGIO
RAL 7000
.01



VERDE
RAL 6011
.02



BLU RAL 5012 +
GRIGIO RAL 7000
.51



GRIGIO RAL 7035 +
GRIGIO RAL 7000
.56

LEGENDA



PORTATA
CARRELLO



LE PORTATE SONO NETTE E SI RIFERISCONO A PESI UNIFORMEMENTE DISTRIBUITI.



COPPIA PROTEZIONI LATERALI

ART.	Dim. mm
F CN 5710 00 30	690x270 H

PER CARRELLI F CN F100
COLORE DISPONIBILE GIALLO RAL 1004

H 890 mm



ART.		kg
F CN F100 01 51		500

1 telaio a 3 file ART. F NC 5120 00 01
1 coppia supporti ART. F NC 5620 00 01
4 telai a 1 fila ART. F NC 5020 00 01
4 coppie supporti inclinati ART. F NC 5711 00 99
1 mensola ART. F CN 5510 00 04
1 tappeto in gomma ART. F CN 5210 00 07

H 890 mm



ART.		kg
F CN F100 10 51		500

1 telaio a 3 file ART. F NC 5120 00 01
1 coppia supporti ART. F NC 5620 00 01
2 telai a 1 fila ART. F NC 5020 00 01
2 coppie supporti inclinati ART. F NC 5711 00 99
1 mensola ART. F CN 5510 00 04
1 tappeto in gomma ART. F CN 5210 00 07

H 890 mm



ART.		kg
F CN F100 07 51		500

4 telai a 1 fila ART. F NC 5020 00 01
4 coppie supporti inclinati ART. F NC 5711 00 99
1 mensola ART. F CN 5510 00 04
1 tappeto in gomma ART. F CN 5210 00 07

H 890 mm



ART.		kg
F CN F100 11 51		500

5 telai a 1 fila ART. F NC 5020 00 01
4 coppie supporti inclinati ART. F NC 5711 00 99
1 coppia supporti orizzontali ART. F NC 5710 00 99
1 mensola ART. F CN 5510 00 04
1 tappeto in gomma ART. F CN 5210 00 07



2 ruote girevoli con freno in nylon Ø 125 mm
2 ruote fisse in nylon Ø 125 mm



BOCCOLE ESCLUSE

H 935 mm



ART.		kg
F CN K600 10 51		840

- 1 telaio a 4 file ART. F NC 5220 00 01
- 1 coppia supporti ART. F NC 5640 00 01
- 6 telai a 1 fila ART. F NC 5020 00 01
- 4 coppie supporti inclinati ART. F NC 5711 00 99
- 2 coppie supporti orizzontali ART. F NC 5710 00 99

H 935 mm



ART.		kg
F CN K600 09 51		840

- 1 telaio a 4 file ART. F NC 5220 00 01
- 1 coppia supporti ART. F NC 5640 00 01
- 5 telai a 1 fila ART. F NC 5020 00 01
- 5 coppie supporti inclinati ART. F NC 5711 00 99
- 1 piano regolabile ART. F CN 5100 00 01
- 1 tappeto in gomma ART. F CN 5220 00 07

H 935 mm



ART.		kg
F CN K600 06 51		840





- 1 telaio a 4 file ART. F NC 5220 00 01
- 1 coppia supporti ART. F NC 5640 00 01
- 4 telai a 1 fila ART. F NC 5020 00 01
- 2 coppie supporti inclinati ART. F NC 5711 00 99
- 2 coppie supporti orizzontali ART. F NC 5710 00 99
- 1 piano regolabile ART. F CN 5120 00 01
- 1 piano in gomma ART. F CN 5240 00 07
- 2 piani regolabili ART. F CN 5100 00 01
- 2 tappeti in gomma ART. F CN 5220 00 07
- 1 cassetto vuoto ART. F NC 8610 00 01



2 ruote girevoli con freno in nylon Ø 160 mm
2 ruote fisse in nylon Ø 160 mm



BOCCOLE ESCLUSE

ART.	TIPO BOCCOLA	   		
		Q.TÀ PER TELAIO F NC 5020	Q.TÀ PER TELAIO F NC 5120	Q.TÀ PER TELAIO F NC 5220
F NC 9510 00 03	ISO 30	8	24	32
F NC 9530 00 03	ISO 40	8	24	32
F NC 9540 00 03	ISO 45	6	18	24
F NC 9550 00 03	ISO 50	5	15	20
F NC 9560 00 03	VDI 30	8	24	32
F NC 9570 00 03	VDI 40	6	18	24
F NC 9580 00 03	VDI 50	6	18	24
F NC 9590 00 03	VDI 60	5	15	20
F NC 9720 00 03	CONO MORSE 2	8	24	32
F NC 9730 00 03	CONO MORSE 3	8	24	32
F NC 9740 00 03	CONO MORSE 4	8	24	32
F NC 9750 00 03	CONO MORSE 5	6	18	24
F NC 9270 00 03	CAPTO C3	8	24	32
F NC 9275 00 03	CAPTO C4	6	18	24
F NC 9280 00 03	CAPTO C5	6	18	24
F NC 9285 00 03	CAPTO C6	6	18	24
F NC 9290 00 03	CAPTO C8	5	15	20
F NC 9210 00 03	HSK A32-B40	8	24	32
F NC 9220 00 03	HSK A40-B50	8	24	32
F NC 9230 00 03	HSK A50-B63	6	18	24
F NC 9240 00 03	HSK A63-B80	6	18	24
F NC 9250 00 03	HSK A80-B100	5	15	20
F NC 9260 00 03	HSK A100-B125	5	15	20
F NC 9640 00 03	2"	6	18	24
F NC 9650 00 03	2" 1/4	5	15	20
F NC 9010 00 03	58 mm	9	27	36
F NC 9020 00 03	65 mm	8	24	32
F NC 9030 00 03	75 mm	7	21	28
F NC 9040 00 03	87 mm	6	18	24
F NC 9050 00 03	105 mm	5	15	20



CONFIGURA IL TUO CARRELLO

Gamma colori ACCIAIO



CARRELLO COMPLETO DI RUOTE

ART.		Dim. mm
F CN F100 00 04	500	758x512x890 H



CARRELLO SENZA RUOTE

ART.		Dim. mm
F CN 0100 00 04	-	758x512x730 H

1
TAPPETO IN GOMMA PER MENSOLA

ART.	Dim. mm
F CN 5210 00 07	485x300

2
MENSOLA

ART.	Dim. mm
F CN 5510 00 04	490x300x170 H

3
TAPPETO IN GOMMA PER MENSOLA

ART.	Dim. mm
F CN 5220 00 07	595x295

4
PIANO REGOLABILE IN ALTEZZA

ART.		Dim. mm
F CN 5100 00 01	30	600x300x42 H

DISPONIBILE IN GRIGIO RAL 7000

5
TAPPETO IN GOMMA PER PIANO REGOLABILE

ART.	Dim. mm
F CN 5230 00 07	595x455

6
PIANO REGOLABILE IN ALTEZZA

ART.		Dim. mm
F CN 5110 00 01	30	600x460x42 H

DISPONIBILE IN GRIGIO RAL 7000



7
TAPPETO IN GOMMA PER PIANO INFERIORE

ART.	Dim. mm
F CN 5250 00 07	595x495

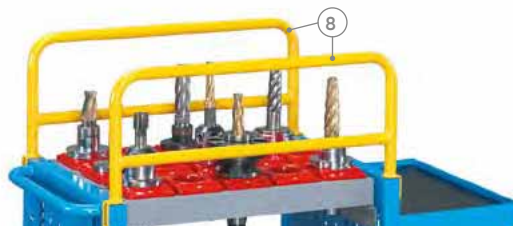

8
COPPIA PROTEZIONI LATERALI

ART.	Dim. mm
F CN 5710 00 30	690x270 H

DISPONIBILE IN GIALLO RAL 1004



TELAIO PORTA BOCCOLE

ART.	kg	Dim. mm
F NC 5020 00 01	50	584x140x146 H

DISPONIBILE IN GRIGIO RAL 7000



COPPIA MANIGLIE ZINCATE

ART.
F NC 5005 00 99

PER TELAIO ART. F NC 5020 00 01



COPPIA SUPPORTI ORIZZONTALI ZINCATI

ART.	Dim. mm
F NC 5710 00 99	140x150 H

PER TELAIO ART. F NC 5020 00 01



COPPIA SUPPORTI INCLINATI ZINCATI

ART.	Dim. mm
F NC 5711 00 99	140x150 H

PER TELAIO ART. F NC 5020 00 01



TELAIO PORTA BOCCOLE A 3 FILE

ART.	kg	Dim. mm
F NC 5120 00 01	150	584x444x69 H

DISPONIBILE IN GRIGIO RAL 7000

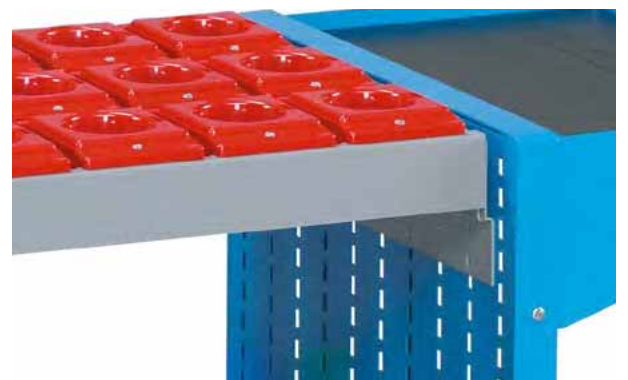

COPPIA SUPPORTI ORIZZONTALI

ART.	Dim. mm
F NC 5620 00 01	430x112 H

PER TELAIO ART. F NC 5120 00 01
DISPONIBILE IN GRIGIO RAL 7000



COPPIA SUPPORTI INCLINATI

ART.	Dim. mm
F NC 5721 00 01	430x114 H

PER TELAIO ART. F NC 5120 00 01
DISPONIBILE IN GRIGIO RAL 7000

CONFIGURA IL TUO CARRELLO

Gamma colori ACCIAIO

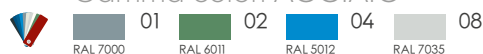

CARRELLO COMPLETO DI RUOTE

ART.		Dim. mm
F CN K600 00 04	840	1073x685x935 H



CARRELLO SENZA RUOTE

ART.		Dim. mm
F CN 0600 00 04	-	1073x685x731 H

1 TAPPETO IN GOMMA PER PIANO REGOLABILE

ART.	Dim. mm
F CN 5220 00 07	595x295

2 PIANO REGOLABILE IN ALTEZZA

ART.		Dim. mm
F CN 5100 00 04	30	600x300x42 H

3 TAPPETO IN GOMMA PER PIANO REGOLABILE IN ALTEZZA

ART.	Dim. mm
F CN 5230 00 07	595x455

4 PIANO REGOLABILE IN ALTEZZA

ART.		Dim. mm
F CN 5110 00 01	30	600x460x42 H

DISPONIBILE IN GRIGIO RAL 7000

5 TAPPETO IN GOMMA PER PIANO REGOLABILE

ART.	Dim. mm
F CN 5240 00 07	595x655

6 PIANO REGOLABILE IN ALTEZZA

ART.		Dim. mm
F CN 5120 00 01	30	600x660x42 H

DISPONIBILE IN GRIGIO RAL 7000



7 TAPPETO IN GOMMA PER PIANO INFERIORE

ART.	Dim. mm
F CN 5260 00 07	675x595



8 COPPIA PROTEZIONI LATERALI

ART.	Dim. mm
F CN 5720 00 30	988x270 H

DISPONIBILE IN GIALLO RAL 1004



TELAIO PORTA BOCCOLE

ART.	kg	Dim. mm
F NC 5020 00 01	50	584x140x146 H

DISPONIBILE IN GRIGIO RAL 7000



COPPIA SUPPORTI ORIZZONTALI ZINCATI

ART.	Dim. mm
F NC 5710 00 99	140x150 H

PER TELAIO ART. F NC 5020 00 01



TELAIO PORTA BOCCOLE A 4 FILE

ART.	kg	Dim. mm
F NC 5220 00 01	150	584x592x69 H

DISPONIBILE IN GRIGIO RAL 7000

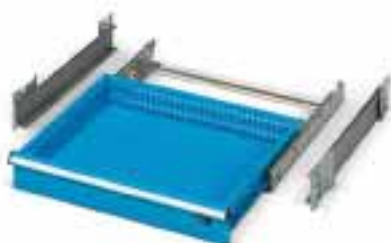

Non si possono inserire i telai porta boccole

CASSETTO AD ESTRAZIONE TOTALE TELESCOPICA

ART.	kg	H frontale	Dim. Utili mm
F NC 8607 00 04	30	75	523x447x54 H
F NC 8610 00 04	30	100	523x447x79 H
F NC 8615 00 04	30	150	523x447x129 H

Con dispositivo di apertura singola dei cassetti - estrazione 100%



COPPIA MANIGLIE ZINCATI

ART.
F NC 5005 00 99

PER TELAIO ART. F NC 5020 00 01



COPPIA SUPPORTI INCLINATI ZINCATI

ART.	Dim. mm
F NC 5711 00 99	140x150 H

PER TELAIO ART. F NC 5020 00 01



COPPIA SUPPORTI INCLINATI

ART.	Dim. mm
F NC 5741 00 01	577x114 H

PER TELAIO ART. F NC 5220 00 01 - DISPONIBILE IN GRIGIO RAL 7000

COPPIA SUPPORTI ORIZZONTALI

ART.	Dim. mm
F NC 5640 00 01	577x112 H

PER TELAIO ART. F NC 5220 00 01 - DISPONIBILE IN GRIGIO RAL 7000



PORTA DISEGNI PER FORMATI DIN A4

ART.	Dim. mm
F CN 5560 00 04	312x35x190 H



RUOTA GIREVOLE CON FRENO IN GOMMA STANDARD

ART.	Ø mm	C mm	Portata kg
C RG DAC11 100	100	128	75
C RG DAC12 125	125	155	100
C RG DAC13 150	150	180	115



RUOTA GIREVOLE CON FRENO IN NYLON

ART.	Ø mm	C mm	Portata kg
C RN DAD10 100	100	128	125
C RN DAD11 125	125	155	180



RUOTA GIREVOLE CON FRENO IN GOMMA ANTISTRACCIATA SINTETICA

ART.	Ø mm	C mm	Portata kg
C RG DPH22 125	125	155	100
C RG DPH25 160	160	200	200



RUOTA GIREVOLE CON FRENO IN GOMMA ELASTICA

ART.	Ø mm	C mm	Portata kg
C RG DCE15 125	125	155	180



RUOTA GIREVOLE CON FRENO IN POLIURETANO

ART.	Ø mm	C mm	Portata kg
C RN DDD31 125	125	155	180



RUOTA FISSA IN GOMMA STANDARD

ART.	Ø mm	C mm	Portata kg
C RG BAC11 100	100	128	75
C RG BAC12 125	125	155	100
C RG BAC13 150	150	180	115



RUOTA FISSA IN NYLON

ART.	Ø mm	C mm	Portata kg
C RN BAD10 100	100	128	125
C RN BAD11 125	125	155	180



RUOTA FISSA IN GOMMA ANTISTRACCIATA SINTETICA

ART.	Ø mm	C mm	Portata kg
C RG BPH22 125	125	155	100
C RG BPH25 160	160	200	200



RUOTA FISSA IN GOMMA ELASTICA

ART.	Ø mm	C mm	Portata kg
C RG BCE15 125	125	155	180



RUOTA FISSA IN POLIURETANO

ART.	Ø mm	C mm	Portata kg
C RN BDD31 125	125	155	180

Per calcolare la portata del carrello seguire la formula:

$(A \times 3) - 40 \text{ kg}$

A = PORTATA DELLE RUOTE



RUOTA GIREVOLE CON FRENO IN GOMMA STANDARD

ART.	Ø mm	C mm	Portata kg
C RG DAC15 200	200	240	205



RUOTA FISSA IN GOMMA STANDARD

ART.	Ø mm	C mm	Portata kg
C RG BAC15 200	200	240	205



RUOTA GIREVOLE CON FRENO IN NYLON

ART.	Ø mm	C mm	Portata kg
C RN DAD04 160	160	200	300



RUOTA FISSA IN NYLON

ART.	Ø mm	C mm	Portata kg
C RN BAD04 160	160	200	300



RUOTA GIREVOLE CON FRENO IN GOMMA ANTISTRACCA SINTETICA

ART.	Ø mm	C mm	Portata kg
C RG DPH25 160	160	200	200



RUOTA FISSA IN GOMMA ANTISTRACCA SINTETICA

ART.	Ø mm	C mm	Portata kg
C RG BPH25 160	160	200	200



RUOTA GIREVOLE CON FRENO IN GOMMA ELASTICA

ART.	Ø mm	C mm	Portata kg
C RG DCE15 160	160	200	300



RUOTA FISSA IN GOMMA ELASTICA

ART.	Ø mm	C mm	Portata kg
C RG BCE15 160	160	200	300



RUOTA GIREVOLE CON FRENO IN POLIURETANO

ART.	Ø mm	C mm	Portata kg
C RN DDD44 160	160	200	300



RUOTA FISSA IN POLIURETANO

ART.	Ø mm	C mm	Portata kg
C RN BDD44 160	160	200	300

Per calcolare la portata del carrello seguire la formula:

$(A \times 3) - 60 \text{ kg}$

A = PORTATA DELLE RUOTE



● ART. F AA 1401 01 04

H = 2000 mm

Gamma colori
ACCIAIO



GRIGIO
RAL 7000
.01

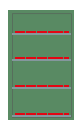

VERDE
RAL 6011
.02



BLU
RAL 5012
.04



GRIGIO
RAL 7035
.08



SERRATURA A CHIAVE (KEY)
Fornita di serie con 2 chiavi

LEGENDA



PORTATA
CASSETTO



ESTRAZIONE
CASSETTO



CHIUSURA
ARMADIO



LE PORTATE SONO NETTE E SI RIFERISCONO A PESI UNIFORMEMENTE DISTRIBUITI.

H 2000 mm



ART.		kg		
F AA 1401 01 04		100	100%	-

Con 4 telai* - Escluse boccole

H 2000 mm



ART.		kg		
F AA 1401 02 04		-	-	-

Con 4 telai - Escluse boccole

H 2000 mm



ART.		kg		
F AA 1400 17 04		100	100%	key

Con 4 telai* - Escluse boccole

H 2000 mm



ART.		kg		
F AA 1400 18 04		-	-	key

Con 4 telai - Escluse boccole

*I TELAI NEI CASSETTI HANNO INCLUSA LA COPPIA SUPPORTI ART. F NC 5630 00 01

H 2000 mm



ART.				
F AA 1402 07 04		100	100%	key

Con 4 telai* - Escluse boccole - Spessore policarbonato 3 mm

H 2000 mm



ART.				
F AA 1402 08 04		-	-	key

Con 4 telai - Escluse boccole - Spessore policarbonato 3 mm



ART. F AA 1400 19 08

ARMADIO CON PORTE A BATTENTE completo di:

2 cassetti (100 kg)

2 telai porta boccole per cassetti

1 telaio porta boccole regolabile in altezza

2 piani zincati (100 kg) regolabili in altezza

Dim. mm 1023x555x2000 H

Escluso utensili, boccole porta utensili, contenitori e valigette

H 2200 mm



H 2200 mm



ART.				
F AA 1800 07 04		100	100%	key

Con 4 telai* - Escluse boccole

ART.				
F AA 1800 08 04		100	100%	key

Con 4 telai - Escluse boccole



ART. F AA 1800 09 08

ARMADIO CON TAPPARELLA completo di:
 2 telai porta boccole regolabili in altezza
 2 piani zincati (100 kg) regolabili in altezza
 Dim. mm 1023x555x2200 H
 Escluso utensili, boccole porta utensili, contenitori
 e valigette

*I TELAI NEI CASSETTI HANNO INCLUSA LA COPPIA SUPPORTI ART. F NC 5630 00 01

H 2000 mm



ART.		kg		
F AB 8302 05 04		100	100%	-

Con 8 telai* - Escluse boccole - Spessore policarbonato 4 mm

H 2000 mm



ART.		kg		
F AB 8300 12 04		100	100%	-

Con 8 telai* - Escluse boccole

*I TELAI NEI CASSETTI HANNO INCLUSA LA COPPIA SUPPORTI ART. F NC 5630 00 01



CONFIGURA IL TUO ARMADIO

H 2000 mm



ARMADIO VUOTO SENZA PORTE

ART.		kg		
F AA 1401 00 04		800	-	-

Dimensioni esterne mm 1023x555x2000 H

Dimensioni interne mm 995x500x1850 H

H 2200 mm



ARMADIO VUOTO CON TAPPARELLA

ART.		kg		
F AA 1800 00 04		800	-	-

Dimensioni esterne mm 1023x555x2200 H

Dimensioni interne mm 995x500x1820 H

H 2000 mm



ARMADIO VUOTO CON 2 PORTE SCORREVOLI

ART.		kg		
F AB 8300 00 04		800 800	-	-

Dimensioni esterne mm 2046x600x2000 H

Dimensioni interne di ogni vano mm 995x500x1850 H

H 2000 mm



ARMADIO VUOTO CON 2 PORTE SCORREVOLI IN POLICARBONATO

ART.		kg		
F AB 8302 00 04		800 800	-	-

Dimensioni esterne 2046x600x2000 H

Dimensioni interne di ogni vano mm 995x500x1850 H

Porte in policarbonato con spessore 4 mm

Tutti gli armadi sono forniti di serie con 2 staffe per il fissaggio a pavimento / parete

H 2000 mm



ARMADIO VUOTO CON 2 PORTE

ART.		kg		
F AA 1400 00 04		800	-	-

Dimensioni esterne mm 1023x555x2000 H
Dimensioni interne mm 995x500x1850 H

H 2000 mm



ARMADIO VUOTO CON 2 PORTE A PANNELLI FORATI

ART.		kg		
F AA 1403 00 04		800	-	-

Dimensioni esterne mm 1023x555x2000 H
Dimensioni interne mm 995x500x1850 H
Portata di ogni singola porta 40 kg

H 2000 mm



ARMADIO VUOTO CON 2 PORTE IN POLICARBONATO

ART.		kg		
F AA 1402 00 04		800	-	-

Dimensioni esterne mm 1023x555x2000 H
Dimensioni interne mm 995x500x1850 H
Porta in policarbonato con spessore 3 mm



GLI ARMADI DEVONO ESSERE FISSATI A PAVIMENTO O A PARETE.
GLI ARMADI CON PORTE FORATE DEVONO ESSERE FISSATI A PARETE.

GLI ARMADI CON CASSETTI DEVONO ESSERE FISSATI A PAVIMENTO O A PARETE. SE I CASSETTI SONO INSERITI AD UNA ALTEZZA SUPERIORE AI 1000 mm DA TERRA, GLI ARMADI DEVONO ESSERE FISSATI A PARETE.

IL LIMITE MASSIMO DI PORTATA TOTALE DEI CASSETTI INSERITI NELL'ARMADIO È DI 350 kg INDIPENDENTEMENTE DALLA PORTATA DELL'ARMADIO

Tutti gli armadi sono forniti di serie con 2 staffe per il fissaggio a pavimento / parete



COMPLETO DI
4 SUPPORTI

TELAIO INCLINABILE PORTA BOCCOLE A 3 FILE

ART.			Dim. mm
F NC 5160 00 01	01	150	965x444x69 H

DISPONIBILE IN GRIGIO RAL 7000

01 RAL 7000 02 RAL 6011 04 RAL 5012



I TELAI SONO REGOLABILI IN ALTEZZA E POSSONO ESSERE MONTATI ORIZZONTALI / INCLINATI



CASSETTO AD ESTRAZIONE SEMPLICE O TELESCOPICA 54x27 EH

ART.				Dim. utili mm
F AC 1200 00 04	01	SEMPLICE	50	906x447x85 H
F AC 1250 00 04	01	TELESCOPICA	100	906x447x85 H

01 RAL 7000 02 RAL 6011 04 RAL 5012



COPPIA CASSETTI AD ESTRAZIONE SEMPLICE O TELESCOPICA 24x27 EH

ART.				Dim. utili mm
F AC 1600 00 04	01	SEMPLICE	50*	396x447x85 H
F AC 1650 00 04	01	TELESCOPICA	60*	396x447x85 H

*PORTATA DI OGNI CASSETTO

01 RAL 7000 02 RAL 6011 04 RAL 5012



PIANO REGOLABILE ZINCATO PROFONDITÀ 500 mm

ART.		Dim. mm
F AC 2500 01 99	100	995x500x35 H
F AC 2500 03 99*	180*	995x500x35 H

COMPLETO DI 4 GANCI - *con 1 rinforzo



TELAIO PORTA BOCCOLE A 3 FILE PER CASSETTI

ART.	kg	Dim. mm
F NC 5140 00 01	-	890x444x69 H

DISPONIBILE IN GRIGIO RAL 7000



COPPIA SUPPORTI

ART.	H max cono utensile mm	Dim. mm
F NC 5630 00 01	A = 93/118/143	446x86 H
F NC 5830 00 01	A = 143/168/193	446x136 H

DISPONIBILE IN GRIGIO RAL 7000



ART.	TIPO BOCCOLA	Q.TÀ PER TELAIO F NC 5160	Q.TÀ PER TELAIO F NC 5140
F NC 9510 00 03	ISO 30	42	39
F NC 9530 00 03	ISO 40	42	39
F NC 9540 00 03	ISO 45	33	30
F NC 9550 00 03	ISO 50	27	24
F NC 9560 00 03	VDI 30	42	39
F NC 9570 00 03	VDI 40	33	30
F NC 9580 00 03	VDI 50	33	30
F NC 9590 00 03	VDI 60	27	24
F NC 9720 00 03	CONO MORSE 2	42	39
F NC 9730 00 03	CONO MORSE 3	42	39
F NC 9740 00 03	CONO MORSE 4	42	39
F NC 9750 00 03	CONO MORSE 5	33	30
F NC 9270 00 03	CAPTO C3	42	39
F NC 9275 00 03	CAPTO C4	33	30
F NC 9280 00 03	CAPTO C5	33	30

ART.	TIPO BOCCOLA	Q.TÀ PER TELAIO F NC 5160	Q.TÀ PER TELAIO F NC 5140
F NC 9285 00 03	CAPTO C6	33	30
F NC 9290 00 03	CAPTO C8	24	24
F NC 9210 00 03	HSK A32-B40	42	39
F NC 9220 00 03	HSK A40-B50	42	39
F NC 9230 00 03	HSK A50-B63	33	30
F NC 9240 00 03	HSK A63-B80	33	30
F NC 9250 00 03	HSK A80-B100	24	24
F NC 9260 00 03	HSK A100-B125	24	24
F NC 9640 00 03	2"	33	30
F NC 9650 00 03	2" 1/4	27	24
F NC 9010 00 03	58 mm	48	42
F NC 9020 00 03	65 mm	42	39
F NC 9030 00 03	75 mm	36	33
F NC 9040 00 03	87 mm	30	27
F NC 9050 00 03	105 mm	24	24

24x27 EH

MATERIALE DI SEPARAZIONE

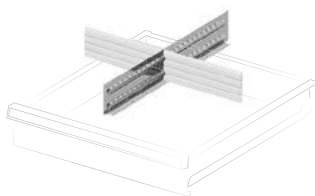

ART. per altezza frontale

F FH 0050 01 00 100

Set composto da: 1 divisorio longitudinale fessurato 455 mm, 2 divisori trasversali 200 mm

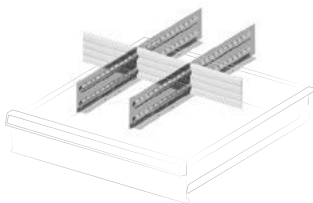

ART. per altezza frontale

F FH 0050 02 00 100

Set composto da: 2 divisori longitudinali fessurati 455 mm, 3 divisori trasversali 132 mm

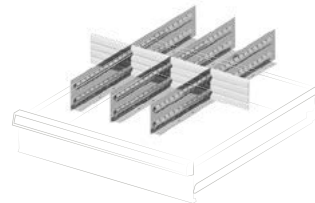

ART. per altezza frontale

F FH 0050 03 00 100

Set composto da: 3 divisori longitudinali fessurati 455 mm, 4 divisori trasversali 98 mm

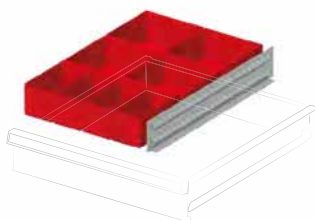

ART. per altezza frontale

F FH 0050 07 00 100

Set composto da: 1 divisorio longitudinale fessurato 455 mm, 4 cassette divisorio 150x75 mm, 4 cassette divisorio 150x150 mm

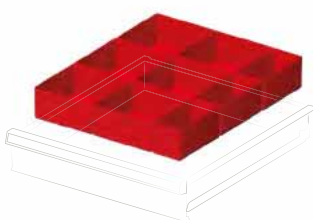

ART. per altezza frontale

F FH 0050 08 00 100

Set composto da: 3 cassette divisorio 150x75 mm, 6 cassette divisorio 150x150 mm

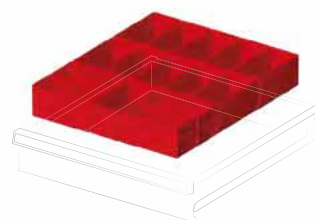

ART. per altezza frontale

F FH 0050 09 00 100

Set composto da: 15 cassette divisorio 150x75 mm

54x27 EH

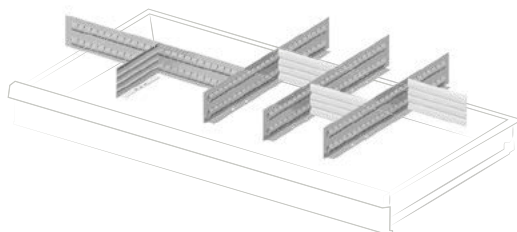

ART. per altezza frontale

F FH 0200 01 00 100

Set composto da: 4 divisori longitudinali fessurati 455 mm, 4 divisori trasversali 149 mm

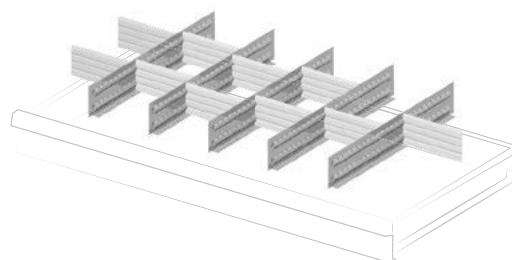

ART. per altezza frontale

F FH 0200 02 00 100

Set composto da: 5 divisori longitudinali fessurati 455 mm, 10 divisori trasversali 149 mm

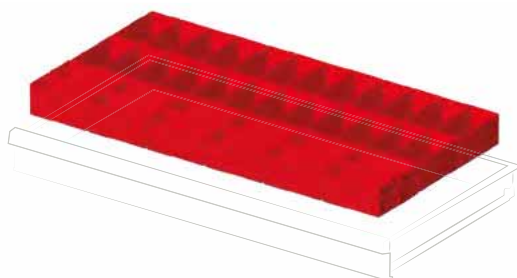

ART. per altezza frontale

F FH 0200 05 00 100

Set composto da: 36 cassette divisorio 150x75 mm

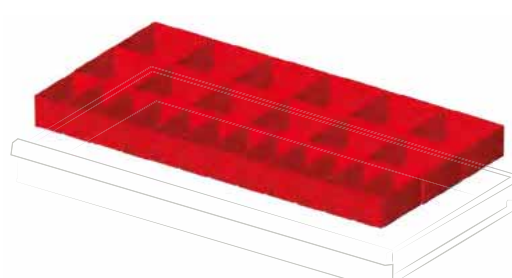

ART. per altezza frontale

F FH 0200 06 00 100

Set composto da: 12 cassette divisorio 150x75 mm, 12 cassette divisorio 150x150 mm

CONFIGURA IL CASSETTO FAMI CON UTENSILI BETA

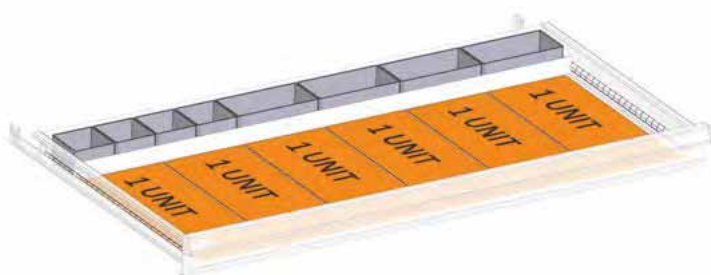

ART. F FH 4007 50 07

Set di predisposizione cassetto per termoformati Beta composto da:

n. 4 F HC 6071 00 07

n. 4 F HC 6471 00 07

n. 1 F HA 2150 00 99

1 unit = 1 termoformato Beta 367x147 mm



ESEMPI DI UTILIZZO TERMOFORMATO

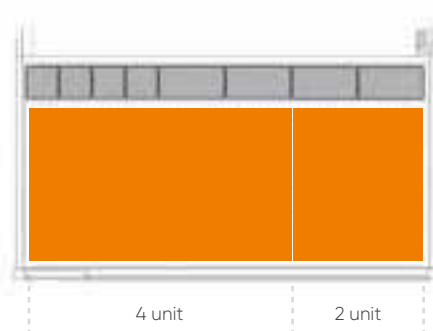
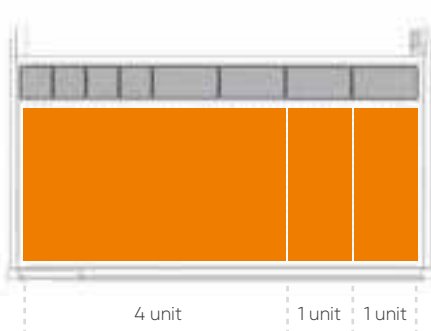
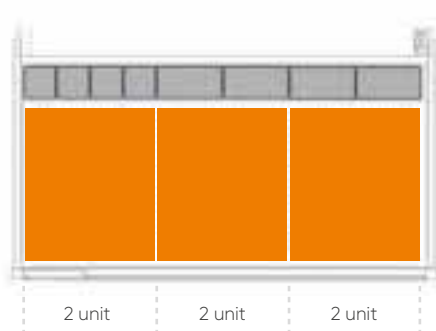
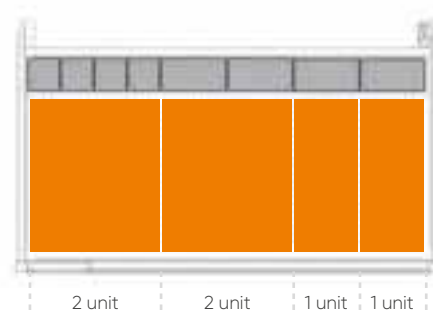
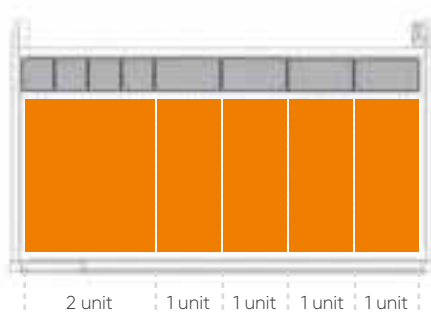
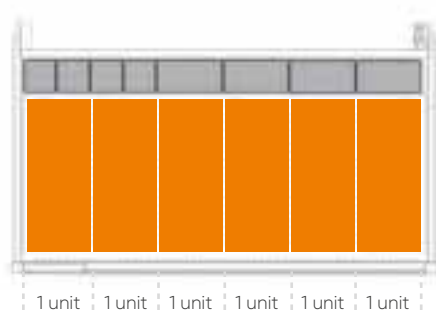

**UTENSILI ORDINATI IN SICUREZZA
SEMPRE A PORTATA DI MANO**

FLESSIBILITÀ

ORGANIZZAZIONE SEMPLICE

SOLUZIONI PER OGNI ESIGENZA

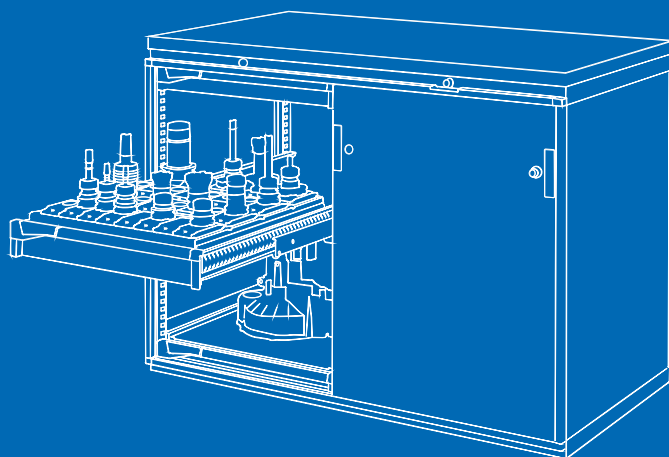



NC MASTER

CARATTERISTICHE TECNICHE

Organizzazione, protezione e sicurezza per utensili NC: gli armadi Master si prestano, con la vasta gamma di accessori, a diventare la logistica moderna per i centri a controllo numerico. Disponibili in 4 diverse serie per larghezza e profondità, gli armadi NC Master si dimostrano versatili in qualsiasi ambiente di lavoro, rispondendo in modo adeguato alle richieste di aziende in progressiva evoluzione.

COLORI

ARMADIO

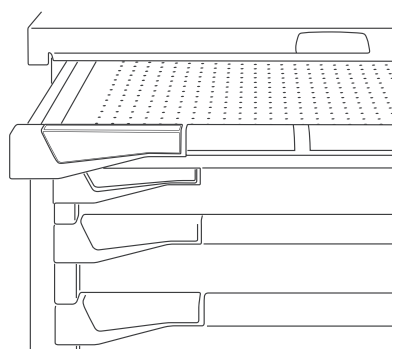

10 colori per la gamma acciaio

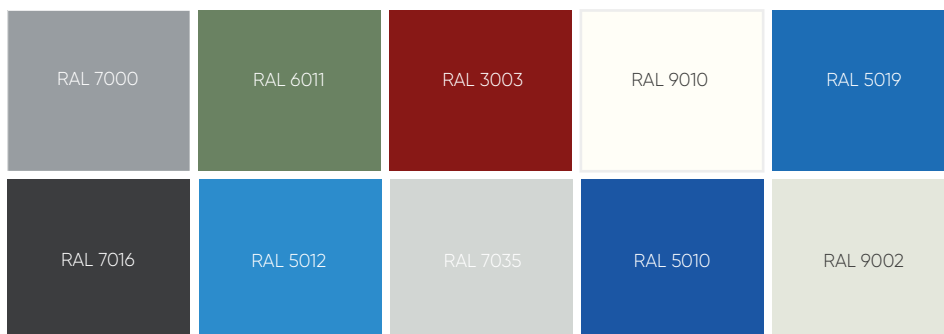

8 colori per gli accessori plastici

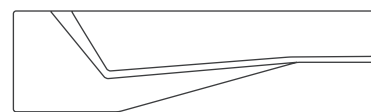

MANIGLIA FRONTALE

BOCCOLE

Costruite in ABS, resistenti agli urti e agli oli minerali, si fissano al telaio con vite per dare maggiore sicurezza durante la movimentazione dei mandrini. Disponibili in diverse versioni per ospitare una vasta gamma di utensili presenti nel mercato.



TELAI

I telai porta boccole sono interamente saldati e possono essere alloggiati all'interno dei cassetti, con supporti che ne regolano l'altezza, o sospesi all'interno dell'armadio. I sostegni laterali e centrali che compongono le file sono lisci e danno la libertà di posizionare le boccole in qualsiasi punto del telaio.



CASSETTI E PIANI ESTRAIBILI



ESTRAZIONE FLESSIBILE

Nuova guida ad estrazione flessibile con regolazione meccanica del fermo posteriore del cassetto/piano estraibile, in 3 diverse posizioni. Permette di ottenere 3 portate differenti: 50, 75, 100 kg.



Sistema di apertura brevettato che permette di configurare l'estrazione e la portata direttamente dall'utilizzatore.

ESTRAZIONE TELESCOPICA

Nuova guida ad estrazione telescopica (estraibilità 100%) che garantisce una portata di 200 kg nelle 4 diverse serie NC Master.



I cassetti/piani estraibili della serie NC Master possono montare indipendentemente sia le guide ad estrazione flessibile che telescopica.



92% = 100 kg

96% = 75 kg

100% = 50 kg

ASTA VERTEBRATA

L'asta è in profilato d'alluminio e rimane sempre fissa, senza ruotare. Il movimento di chiusura è ottenuto da tasselli che si spostano verticalmente sfruttando una delle forze elementari della fisica: la gravità. Più il movimento è semplice, meno probabilità di rotture ci sono. La chiusura dell'asta è affidata a un sistema a catenaccio posto sulla testa dell'asta.

CHIUSURA CON CILINDRO

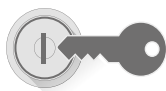

Sistema di trasmissione dal cilindro della chiusura alla testa dell'asta vertebrata a filo di acciaio con guaina elastica e movimento lineare.

La chiusura a cilindro è suddivisa in 23 diverse serie: ogni serie ha una numerazione delle chiavi compresa tra 1 e 160, per un totale di 3.680 diverse combinazioni.

FORNITA DI SERIE CON 2 CHIAVI

CHIUSURA CON CODICE NUMERICO



Oltre alla normale chiusura a cilindro, Fami ha deciso di aggiungere alle proprie chiusure la chiusura CODE. La serratura a codice numerico comanda l'apertura e la chiusura dell'asta vertebrata. Gestisce fino a 10 utenti con codice numerico da 3 a 8 cifre. Il download storico degli eventi è possibile tramite cavo collegando il tastierino al pc. Disponibili su richiesta fino a 10 telecomandi.

PRESERVIAMO I TUOI UTENSILI NEL TEMPO

PORTA A BATTENTE



PORTA SCORREVOLE



TAPPARELLA



LE PORTATE NELLE SEZIONI SONO NETTE E SI RIFERISCONO A PESI UNIFORMEMENTE DISTRIBUITI



Gamma colori ACCIAIO



GRIGIO RAL 7000
.01

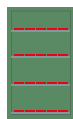

VERDE RAL 6011
.02

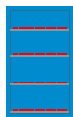

BLU RAL 5012
.04



GRIGIO RAL 7035
.08

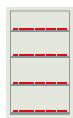

BIANCO GRIGIASTRO RAL 9002
.1F



ROSSO RUBINO RAL 3003
.1G



BLU GENZIANA RAL 5010
.34



BIANCO PURO RAL 9010
.35



GRIGIO ANTRACITE RAL 7016
.39



BLU CAPRI RAL 5019
.48

PORTATA ARMADIO 3100 kg

Gamma colori PLASTICHE



DARK GREY
.M0



MEDITERRANEAN BLUE
.M1



SKY BLUE
.M2



GLAMOUR RED
.M3



RED CARPET
.M4



JUICY ORANGE
.M5



SUNNY YELLOW
.M6



FOREST GREEN
.M7

ART. M 32 A100 C0 15 RV PC

ARMADIO CON PORTE A BATTENTE completo di:
2 cassetti ad estrazione telescopica (200 kg)
1 piano ad estrazione telescopica (200 kg)
1 telaio porta boccole per cassetti
1 piano superiore a 4 bordi
Dim. mm 714x598x1023 H
Escluso utensili e boccole
COLORE ACCIAIO BLU GENZIANA RAL 5010 +
BIANCO PURO RAL 9010
COLORE PLASTICHE JUICY ORANGE



ART. M 32 A200 C0 13 SM 56

ARMADIO CON TAPPARELLA completo di:
1 cassetto ad estrazione telescopica (200 kg), 1 telaio porta boccole per cassetti,
3 telai porta boccole. Dim. mm 714x612x2250 H. Escluso utensili e boccole
COLORE GRIGIO CHIARO RAL 7035 + GRIGIO SCURO RAL 7000
COLORE PLASTICHE ROSSO GLAMOUR RED

LEGENDA



PORTATA CASSETTO



ESTRAZIONE CASSETTO



CHIUSURA ARMADIO



LE PORTATE SONO NETTE E SI RIFERISCONO A PESI UNIFORMEMENTE DISTRIBUITI.

H 1000 mm



porta 775 mm H

ART.					
M 32 A100 C0 10 QT 04		50-75-100	100-96-92%	key	
M 32 A100 T2 10 QT 04		50-75-100	100-96-92%	code	

Con 2 telai* - Escluse boccole

H 1000 mm



porta 775 mm H

ART.					
M 32 A100 C0 10 QU 04		50-75-100	100-96-92%	key	
M 32 A100 T2 10 QU 04		50-75-100	100-96-92%	code	

Con 1 telaio* - Escluse boccole

H 1000 mm



porta 900 mm H

ART.					
M 32 A100 C0 10 QV 04		50-75-100	100-96-92%	key	
M 32 A100 P5 10 QV 04		50-75-100	100-96-92%	code	

Con 2 telai* - Escluse boccole

H 1000 mm

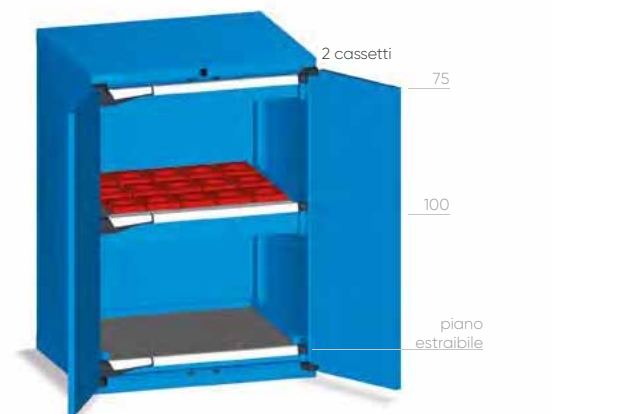

porta 900 mm H

ART.					
M 32 A100 C0 10 QW 04		50-75-100	100-96-92%	key	
M 32 A100 P5 10 QW 04		50-75-100	100-96-92%	code	

Con 1 telaio* - Escluse boccole

*I TELAI HANNO INCLUSA LA COPPIA SUPPORTI ART. F NC 5630 00 01

H 1000 mm

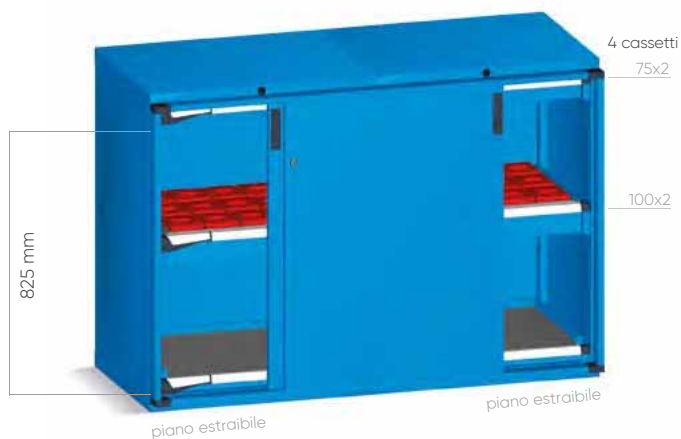

porta doppia

ART.				
M 32 D100 C0 10 QX 04		50-75-100	100-96-92%	key

Con 2 telai* - Escluse boccole

H 1000 mm



porta doppia

ART.				
M 32 D100 C0 10 QY 04		50-75-100	100-96-92%	key

Con 4 telai* - Escluse boccole

H 1000 mm



porta singola

profondità 598 mm

ART.				
M 32 D100 C0 10 QZ 04		50-75-100	100-96-92%	key

Con 2 telai* - Escluse boccole

*I TELAI HANNO INCLUSA LA COPPIA SUPPORTI ART. F NC 5630 00 01

H 1500 mm



H 1500 mm



porta 1400 mm

profondità 598 mm

ART.				
M 32 A150 C5 10 RB 04		50-75-100	100-96-92%	-

Con 3 telai* - Escluse boccole

ART.				
M 32 A150 C0 10 RC 04		50-75-100	100-96-92%	key
M 32 A150 P5 10 RC 04		50-75-100	100-96-92%	code

Con 3 telai* - Escluse boccole

ART. M 32 A150 C0 13 RU 01

ARMADIO CON PORTE A BATTENTE completo di:
 3 cassetti ad estrazione flessibile (100 kg)
 3 telai porta boccole per cassetti
 1 piano superiore a 3 bordi
 Dim. mm 714x598x1523 H
 Escluso utensili, boccole e valigetta
 COLORE ACCIAIO GRIGIO SCURO RAL 7000
 COLORE PLASTICHE ROSSO GLAMOUR RED



H 2000 mm



ART.				
M 32 A200 X010 RD 04		50-75-100	100-96-92%	-

Con 4 telai* - Escluse boccole

H 2000 mm



ART.				
M 32 A200 C510 RE 04		50-75-100	100-96-92%	-

Con 2 telai* - Escluse boccole

H 2000 mm



ART.				
M 32 A200 C510 RF 04		50-75-100	100-96-92%	-

Con 3 telai* - Escluse boccole

H 2000 mm



ART.				
M 32 A200 C510 PS 04		50-75-100	100-96-92%	-

Con 4 telai* - Escluse boccole

*I TELAI NEI CASSETTI HANNO INCLUSA LA COPPIA SUPPORTI ART. F NC 5630 00 01



ART. M 32 A200 C5 14 PS CQ

ARMADIO completo di:

3 cassetti ad estrazione flessibile (100 kg)

3 telai porta boccole per cassetti

1 telaio porta boccole

Dim. mm 714x573x2000 H

Escluso utensili e boccole porta utensili

COLORE ACCIAIO GRIGIO ANTRACITE RAL 7016 +

BIANCO GRIGIASTRO RAL 9002

COLORE PLASTICHE ROSSO RED CARPET

H 2000 mm



porta 1900 mm

ART.				
M 32 A200 C0 10 PT 04		50-75-100	100-96-92%	key
M 32 A200 P5 10 PT 04		50-75-100	100-96-92%	code

Con 4 telai* - Escluse boccole

H 2000 mm



porta 1900 mm

ART.				
M 32 A200 C0 10 PU 04		50-75-100	100-96-92%	key
M 32 A200 P5 10 PU 04		50-75-100	100-96-92%	code

Con 2 telai* - Escluse boccole

H 2000 mm



porta 1900 mm

ART.				
M 32 A200 C0 10 PV 04		50-75-100	100-96-92%	key
M 32 A200 P5 10 PV 04		50-75-100	100-96-92%	code

Con 3 telai* - Escluse boccole

H 2000 mm



porta 1900 mm

ART.				
M 32 A200 C0 10 PW 04		50-75-100	100-96-92%	key
M 32 A200 P5 10 PW 04		50-75-100	100-96-92%	code



Con 4 telai* - Escluse boccole

*1 TELAI NEI CASSETTI HANNO INCLUSA LA COPPIA SUPPORTI ART. F NC 5630 00 01

H 2250 mm



armadio a tapparella

ART.    
M 32 A200 C0 10 PX 04 50-75-100 100-96-92% key

Con 4 telai* - Escluse boccole

H 2250 mm



armadio a tapparella



ART.    
M 32 A200 C0 10 PY 04 50-75-100 100-96-92% key

Con 2 telai* - Escluse boccole

H 2250 mm



armadio a tapparella





ART.    
M 32 A200 C0 10 PZ 04 50-75-100 100-96-92% key

Con 3 telai* - Escluse boccole

H 2250 mm



armadio a tapparella

ART.    
M 32 A200 C0 10 QA 04 50-75-100 100-96-92% key

Con 4 telai* - Escluse boccole

H 2000 mm

H 2000 mm



porta doppia

ART.				
M32D200C010QB04	50-75-100	100-96-92%	key	

Con 8 telai* - Escluse boccole

porta doppia

ART.				
M32D200C010QC04	50-75-100	100-96-92%	key	

Con 8 telai* - Escluse boccole

*I TELAI NEI CASSETTI HANNO INCLUSA LA COPPIA SUPPORTI ART. F NC 5630 00 01





ART. M 32 D200 C0 17 QC CQ

ARMADIO CON PORTE SCORREVOLI completo di:
6 cassetti ad estrazione flessibile (100 kg)
6 telai porta boccole per cassetti
2 telai porta boccole
Dim. mm 1428x623x2000 H
Escluso utensili e boccole porta utensili
COLORE ACCIAIO GRIGIO ANTRACITE RAL 7016 +
BIANCO GRIGIASTRO RAL 9002
COLORE PLASTICHE VERDE FOREST GREEN

CONFIGURA IL TUO ARMADIO

H 1000 mm

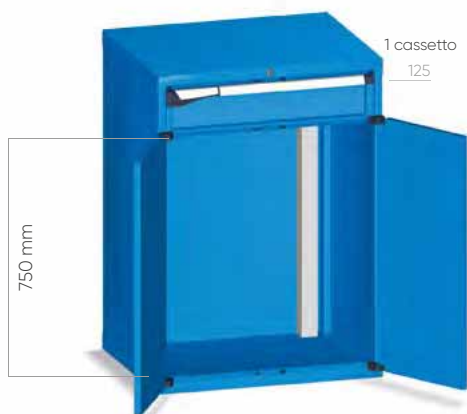

porta 775 mm

Dim. mm 714x598

ART.				
M 32 A100 C0 10 QL 04	50-75-100	100-96-92%	key	
M 32 A100 T2 10 QL 04	50-75-100	100-96-92%	code	

Armadio vuoto con asta vertebata

H 1000 mm



porta 900 mm

Dim. mm 714x598

ART.				
M 32 A100 C0 10 QM 04	-	-	key	
M 32 A100 P5 10 QM 04	-	-	code	

Armadio vuoto con asta vertebata

H 1000 mm



armadio con 2 porte scorrevoli

Dim. mm 1428x623

ART.				
M 32 D100 C0 10 QN 04	-	-	key	

Armadio vuoto con 2 aste vertebate

H 1000 mm



armadio con 1 porta scorrevole

Dim. mm 1428x598

ART.				
M 32 D100 C0 10 QP 04	-	-	key	

Armadio vuoto con 2 aste vertebate, serratura a sinistra

H 1500 mm

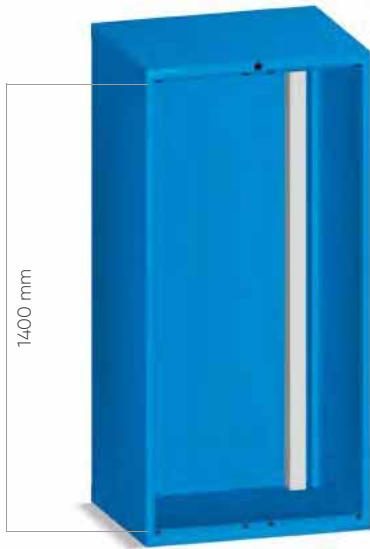

Dim. mm 714x573

ART.				
M 32 A150 C5 10 00 04	-	-	-	-

Armadio vuoto con asta vertebrata

H 1500 mm



porta 1400 mm

Dim. mm 714x598

ART.				
M32A150C010QM04	-	-	-	key
M 32 A150 P5 10 QM 04	-	-	-	code

Armadio vuoto con asta vertebrata

H 2000 mm



Dim. mm 714x573

ART.				
M 32 A200 X0 10 00 04	-	-	-	-

Armadio vuoto

H 2000 mm



Dim. mm 714x573

ART.				
M32A200C5100004	-	-	-	-

Armadio vuoto con asta vertebrata



IN PRESENZA DI 2 O PIÙ CASSETTI / PIANI ESTRAIBILI,
È OBBLIGATORIO L'USO DELL'ASTA VERTEBRATA

H 2000 mm

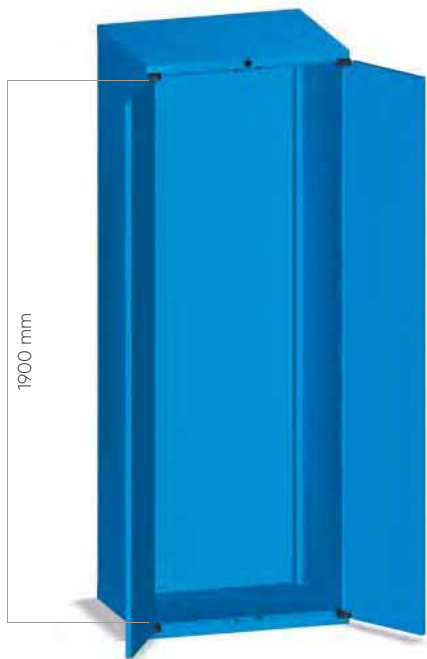

porta 1900 mm

Dim. mm 714x598

ART.				
M 32 A200 C010 QQ 04	-	-	-	key
M 32 A200 P510 QQ 04	-	-	-	code

Armadio vuoto

H 2000 mm



porta 1900 mm

Dim. mm 714x598

ART.				
M 32 A200 C010 QM 04	-	-	-	key
M 32 A200 P510 QM 04	-	-	-	code

Armadio vuoto con asta vertebrata

H 2250 mm

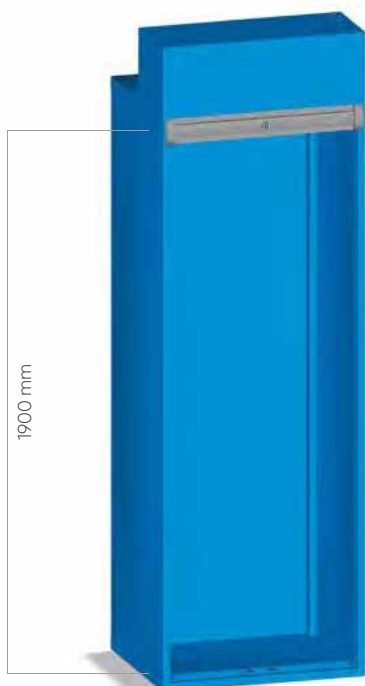

armadio a tapparella

Dim. mm 714x612

ART.				
M 32 A200 C010 QR 04	-	-	-	key

Armadio vuoto

H 2250 mm



armadio a tapparella

Dim. mm 714x612

ART.				
M 32 A200 C010 QS 04	-	-	-	key

Armadio vuoto con asta vertebrata

H 2000 mm

H 2000 mm



armadio con 2 porte scorrevoli

Dim. mm 1428x623

ART.					
M32D200C0100D04	-	-	-	key	

Armadio vuoto

armadio con 2 porte scorrevoli

Dim. mm 1428x623

ART.					
M32D200C010QN04	-	-	-	key	

Armadio vuoto con 2 aste vertebate



IN PRESENZA DI 2 O PIÙ CASSETTI / PIANI ESTRAIBILI,
È OBBLIGATORIO L'USO DELL'ASTA VERTEBRATA





COMPLETO DI
4 SUPPORTI

TELAIO INCLINABILE PORTA BOCCOLE A 3 FILE

ART.	kg	Dim. mm	
M 32 TE70 00 00 01 01	150	659x444x66 H	

DISPONIBILE IN GRIGIO RAL 7000

I TELAI SONO REGOLABILI IN ALTEZZA E POSSONO
ESSERE MONTATI ORIZZONTALI / INCLINATI



TELAIO PORTA BOCCOLE A 3 FILE PER CASSETTI

ART.		Dim. mm
F NC 5120 00 01	-	584x444x69 H

DISPONIBILE IN GRIGIO RAL 7000



COPPIA SUPPORTI

ART.	H max cono utensile mm	Dim. mm
F NC 5630 00 01	A = 93/118/143	446x86 H
F NC 5830 00 01	A = 143/168/193	446x136 H

DISPONIBILE IN GRIGIO RAL 7000



La portata del telaio è data dalla portata del cassetto

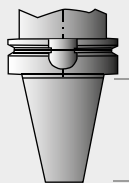

(rif. A)
Altezza cono dell'utensile

H max del cono dell'utensile mm (rif. A)	H telaio con cassetto mm (rif. B)
93	115
118	140
143	165
168	190
193	215



(rif. B)
Altezza del cassetto con telaio e boccole

Il passo della regolazione in altezza del cassetto è di 25 mm

ART.	TIPO BOCCOLA	QTÀ PER TELAIO M 32 TE70	QTÀ PER TELAIO F NC 5120
F NC 9510 00 03	ISO 30	27	24
F NC 9530 00 03	ISO 40	27	24
F NC 9540 00 03	ISO 45	21	18
F NC 9550 00 03	ISO 50	18	15
F NC 9560 00 03	VDI 30	27	24
F NC 9570 00 03	VDI 40	21	18
F NC 9580 00 03	VDI 50	21	18
F NC 9590 00 03	VDI 60	18	15
F NC 9720 00 03	CONO MORSE 2	27	24
F NC 9730 00 03	CONO MORSE 3	27	24
F NC 9740 00 03	CONO MORSE 4	27	24
F NC 9750 00 03	CONO MORSE 5	21	18
F NC 9270 00 03	CAPTO C3	27	24
F NC 9275 00 03	CAPTO C4	21	18
F NC 9280 00 03	CAPTO C5	21	18

ART.	TIPO BOCCOLA	QTÀ PER TELAIO M 32 TE70	QTÀ PER TELAIO F NC 5120
F NC 9285 00 03	CAPTO C6	21	18
F NC 9290 00 03	CAPTO C8	15	15
F NC 9210 00 03	HSK A32-B40	27	24
F NC 9220 00 03	HSK A40-B50	27	24
F NC 9230 00 03	HSK A50-B63	21	18
F NC 9240 00 03	HSK A63-B80	21	18
F NC 9250 00 03	HSK A80-B100	15	15
F NC 9260 00 03	HSK A100-B125	15	15
F NC 9640 00 03	2"	21	18
F NC 9650 00 03	2" 1/4	18	15
F NC 9010 00 03	58 mm	30	27
F NC 9020 00 03	65 mm	27	24
F NC 9030 00 03	75 mm	24	21
F NC 9040 00 03	87 mm	21	18
F NC 9050 00 03	105 mm	15	15



CASSETTI AD ESTRAZIONE FLESSIBILE

ART. CON kit plastiche Dark Grey	ART. SENZA kit plastiche*	Dim. utili mm	H frontale mm	kg	
M 32 C050 0110 OF __	M 32 C050 0100 OF __	600x447x31 H	50	50 - 75 - 100	100% - 96% - 92%
M 32 C075 0110 OF __	M 32 C075 0100 OF __	600x447x56 H	75	50 - 75 - 100	100% - 96% - 92%
M 32 C100 0110 OF __	M 32 C100 0100 OF __	600x447x81 H	100	50 - 75 - 100	100% - 96% - 92%
M 32 C125 0110 OF __	M 32 C125 0100 OF __	600x447x106 H	125	50 - 75 - 100	100% - 96% - 92%
M 32 C150 0110 OF __	M 32 C150 0100 OF __	600x447x131 H	150	50 - 75 - 100	100% - 96% - 92%
M 32 C200 0110 OF __	M 32 C200 0100 OF __	600x447x181 H	200	50 - 75 - 100	100% - 96% - 92%
M 32 C250 0110 OF __	M 32 C250 0100 OF __	600x447x231 H	250	50 - 75 - 100	100% - 96% - 92%
M 32 C300 0110 OF __	M 32 C300 0100 OF __	600x447x281 H	300	50 - 75 - 100	100% - 96% - 92%

* ABBINARE AL CODICE ARTICOLO UNO DEI KIT PLASTICHE DISPONIBILI NELLA TABELLA SOTTOSTANTE



CASSETTI AD ESTRAZIONE TELESCOPICA

ART. CON kit plastiche Dark Grey	ART. SENZA kit plastiche*	Dim. utili mm	H frontale mm	kg	
M 32 C075 0110 OT __	M 32 C075 0100 OT __	600x447x56 H	75	200	100%
M 32 C100 0110 OT __	M 32 C100 0100 OT __	600x447x81 H	100	200	100%
M 32 C125 0110 OT __	M 32 C125 0100 OT __	600x447x106 H	125	200	100%
M 32 C150 0110 OT __	M 32 C150 0100 OT __	600x447x131 H	150	200	100%
M 32 C200 0110 OT __	M 32 C200 0100 OT __	600x447x181 H	200	200	100%
M 32 C250 0110 OT __	M 32 C250 0100 OT __	600x447x231 H	250	200	100%
M 32 C300 0110 OT __	M 32 C300 0100 OT __	600x447x281 H	300	200	100%

* ABBINARE AL CODICE ARTICOLO UNO DEI KIT PLASTICHE DISPONIBILI NELLA TABELLA SOTTOSTANTE

KIT PLASTICHE PER CASSETTI E PIANI ESTRAIBILI



GAMMA COLORI PLASTICHE	ART.
MEDITERRANEAN BLUE	M 30 PLS1 00 00 00 M1
SKY BLUE	M 30 PLS1 00 00 00 M2
GLAMOUR RED	M 30 PLS1 00 00 00 M3
RED CARPET	M 30 PLS1 00 00 00 M4
JUICY ORANGE	M 30 PLS1 00 00 00 M5
SUNNY YELLOW	M 30 PLS1 00 00 00 M6
FOREST GREEN	M 30 PLS1 00 00 00 M7



PIANO ESTRAIBILE AD ESTRAZIONE FLESSIBILE

ART. CON kit plastiche Dark Grey	ART. SENZA kit plastiche*	Dim. utili mm	H frontale mm	kg	
M 32 C057 0110 0F _ _	M 32 C057 01 00 0F _ _	600x447	70	50 - 75 - 100	100% - 96% - 92%

* ABBINARE AL CODICE ARTICOLO UNO DEI KIT PLASTICHE DISPONIBILI NELLA TABELLA A SINISTRA



PIANO ESTRAIBILE AD ESTRAZIONE TELESCOPICA

ART. CON kit plastiche Dark Grey	ART. SENZA kit plastiche*	Dim. utili mm	H frontale mm	kg	
M 32 C057 0110 0T _ _	M 32 C057 01 00 0T _ _	600x447	70	200	100%

* ABBINARE AL CODICE ARTICOLO UNO DEI KIT PLASTICHE DISPONIBILI NELLA TABELLA A SINISTRA



PIANO REGOLABILE

ART.	Dim. utili mm	H totale mm	kg
M 32 PR25 00 00 01 _ _	657x478	60	150

INSERIBILE DAVANTI ALL'ASTA VERTEBRATA

RICAMBI - FISSAGGIO

SERRATURA DI RICAMBIO

ART. M 00 CSR0 8800 00 00

Serratura di ricambio con due chiavi



CHIAVE DI RICAMBIO

ART. M 00 CF00 0000 00 00

Specificare sempre il numero indicato nella serratura a cilindro dove si vuole sostituire la chiave



PASSEPARTOUT

ART. M 00 PF.. 0000 00 00

Disponibile in 23 serie, con numerazione da F 01 a F 23.

Passepartout serie F 01
Passepartout serie F 02
Passepartout serie F ..

ART. M 00 PF01 00 00 00 00
ART. M 00 PF02 00 00 00 00
ART. M 00 PF.. 00 00 00 00

SET FISSAGGIO TRA ARMADI

ART. M 00 FISO 00 00 00 99

Set di fissaggio armadio-armadio con 4 viti complete di dadi M8

ART. M 00 SVRO 00 00 00 99

Foratura e viteria per il fissaggio dei due armadi sovrapposti

SET DI FISSAGGIO A PAVIMENTO



ART. F AG 9200 00 99

Coppia staffe zincate per il fissaggio a pavimento dell'armadio

ART. F AG 9204 00 99

2 tasselli "HILTI" adatti per pavimenti in calcestruzzo non fessurato maggiore o uguale alla classe: C20/25
Trazione consigliata del tassello: 2,9 kN
Diametro tassello: Ø 6 mm



MANIGLIA DI RICAMBIO

ART. M 00 PLS0 0000 22 M0

Maniglia di ricambio per porte disponibile in colore Dark Grey.



ALTRI COLORI A RICHIESTA



GLI ARMADI DEVONO ESSERE FISSATI A PAVIMENTO O A PARETE
SE SOVRAPPosti DEVONO ESSERE FISSATI OBBLIGATORIAMENTE A PARETE E LA LORO PORTATA DIVISA PER DUE



PIANO SUPERIORE A 3 BORDI

ART.	dim. mm	
M 32 T023 AG 00 31 07	714x573x23 H	

Piano rivestito in pvc per ARMADIO SINGOLO. Colore nero



PIANO SUPERIORE A 3 BORDI

ART.	dim. mm	
M 32 T023 AG 00 32 07	714x573x23 H	

Piano rivestito in pvc per ARMADIO SINGOLO. Colore nero



PIANO SUPERIORE A 4 BORDI

ART.	dim. mm	
M 32 T023 AG 00 41 07	714x573x23 H	

Piano rivestito in pvc per ARMADIO SINGOLO. Colore nero



ART. M 00 T023 AG 00 FO 00

FORATURA PIANO SUPERIORE DELL'ARMADIO PER IL FISSAGGIO DEL PIANO A 4 BORDI



PIANO SUPERIORE IN MDF DIM. 714x573x32 mm H

ART.	rifiniture	per armadio	
M 32 T030 MD GM 21 07	1 profilo laterale	finale dx o sx	

Piano in MDF con copertura in gomma antiolio. Colore nero



PIANO SUPERIORE IN MDF DIM. 714x573x32 mm H

ART.	rifiniture	per armadio	
M 32 T030 MD GM 11 07	-	centrale	

Piano in MDF con copertura in gomma antiolio. Colore nero

PIANO SUPERIORE IN MDF DIM. 714x573x32 mm H

ART.	rifiniture	per armadio	
M 32 T030 MD GM 01 07	2 profili laterali	singolo	

Piano in MDF con copertura in gomma antiolio. Colore nero



ART. M 00 T030 MD 00 FO 00

FORATURA PIANO SUPERIORE DELL'ARMADIO PER IL FISSAGGIO DEL PIANO IN MDF COMPRESIVO DI VITI PER IL FISSAGGIO



RIFINITURA
GOMMA
ANTIOLIO



APPLICAZIONE
PIANO IN MDF



ZOCCOLO DI RIALZO ALTEZZA 50 mm

ART.		dim. mm	
M 32 Z050 00 00 00		712x572x50 H	



ZOCCOLO DI RIALZO ALTEZZA 100 mm

ART.		dim. mm	
M 32 Z100 00 00 00		712x572x100 H	



ZOCCOLI PER CARRELLO ELEVATORE - Colore nero RAL 9005

ART.		dim. mm	
M 02 Z060 20 00 00 07		coppia zoccoli 200x569x60 H	
M 30 Z060 21 00 00 07		chiusura per coppia zoccoli 708x46x55 H	



ZOCCOLI PER TRANSPALLET - Colore nero RAL 9005

ART.		dim. mm	
M 32 Z100 10 00 00 07		zoccolo 712x569x100 H	
M 30 Z100 11 00 00 07		chiusura per zoccolo 708x46x95 H	



36x27 EH

MATERIALE DI SEPARAZIONE

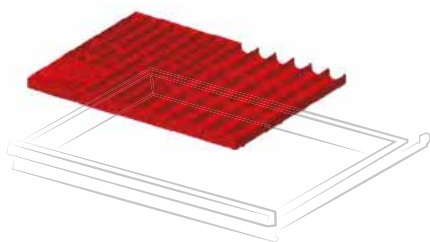

ART. per altezza frontale mm

F FH 1005 15 00 50 - 300

Set composto da: 5 divisori 4 canali, 6 divisori 3 canali, 20 divisori trasversali 36 mm, 20 divisori trasversali 47 mm, porta chiavi a brugola 150x150 mm

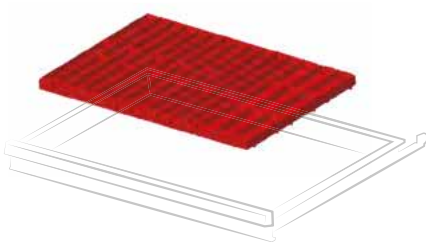

ART. per altezza frontale mm

F FH 1005 10 00 50 - 300

Set composto da: 9 divisori 4 canali, 3 divisori 3 canali, 36 divisori trasversali 36 mm, 12 divisori trasversali 47 mm

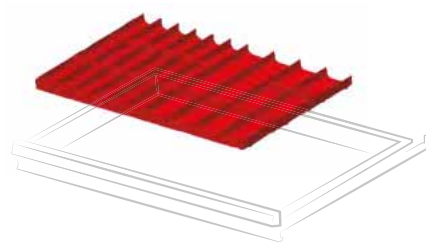

ART. per altezza frontale mm

F FH 1005 13 00 50 - 300

Set composto da: 6 divisori 3 canali, 6 divisori 2 canali, 18 divisori trasversali 47 mm, 12 divisori trasversali 73 mm

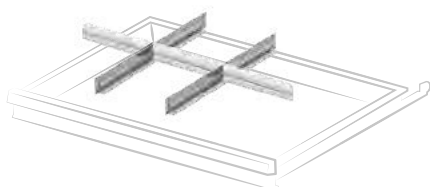

ART. per altezza frontale mm

F FH 1005 05 00 50

F FH 1007 05 00 75

F FH 1010 05 00 100 - 125

F FH 1015 05 00 150

F FH 1020 05 00 200 - 250

F FH 1030 05 00 300

Set composto da: 2 divisori longitudinali fessurati 455 mm, 3 divisori trasversali 200 mm

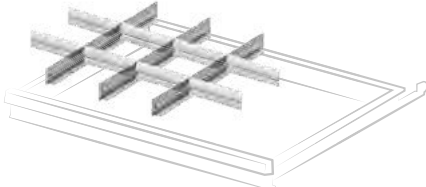

ART. per altezza frontale mm

F FH 1005 03 00 50

F FH 1007 03 00 75

F FH 1010 03 00 100 - 125

F FH 1015 03 00 150

F FH 1020 03 00 200 - 250

Set composto da: 3 divisori longitudinali fessurati 455 mm, 8 divisori trasversali 149 mm

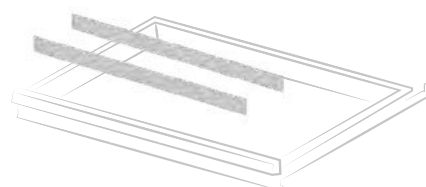

ART. per altezza frontale mm

F FH 1005 01 00 50

F FH 1007 01 00 75

F FH 1010 01 00 100 - 125

F FH 1015 01 00 150

F FH 1020 01 00 200 - 250

F FH 1030 01 00 300

Set composto da: 2 divisori longitudinali non fessurati 610 mm

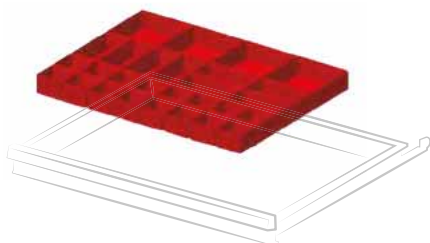

ART. per altezza frontale mm

F FH 1005 18 00 50

F FH 1007 18 00 75

Set composto da: 16 cassette divisorio 75x75 mm, 8 cassette divisorio 150x75 mm, 4 cassette divisorio 150x150 mm

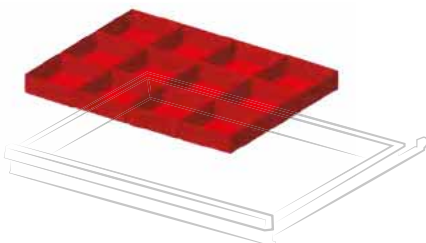

ART. per altezza frontale mm

F FH 1005 09 00 50

F FH 1007 09 00 75

F FH 1010 09 00 100 - 125

Set composto da: 12 cassette divisorio 150x150 mm

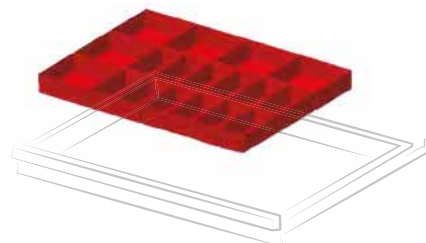

ART. per altezza frontale mm

F FH 1005 16 00 50

F FH 1007 16 00 75

F FH 1010 16 00 100 - 125

Set composto da: 12 cassette divisorio 150x75 mm, 6 cassette divisorio 150x150 mm

CONFIGURA IL CASSETTO FAMI CON UTENSILI BETA

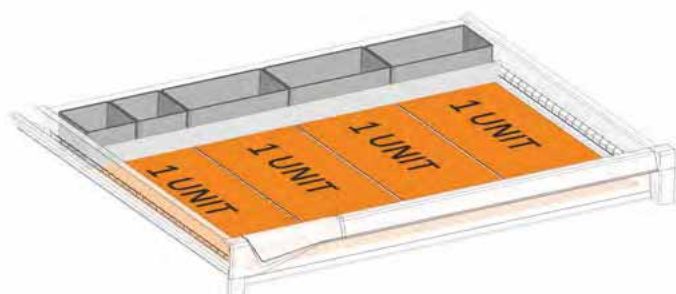

ART. F FH 1007 50 07

Set di predisposizione cassetto per termoformati Beta composto da:

n. 2 F HC 6071 00 07

n. 3 F HC 6471 00 07

n. 1 F HA 1141 00 99

1 unit = 1 termoformato Beta 367x147 mm

2 unit = 1 termoformato Beta 367x294 mm

4 unit = 1 termoformato Beta 367x588 mm

ESEMPI DI UTILIZZO TERMOFORMATO

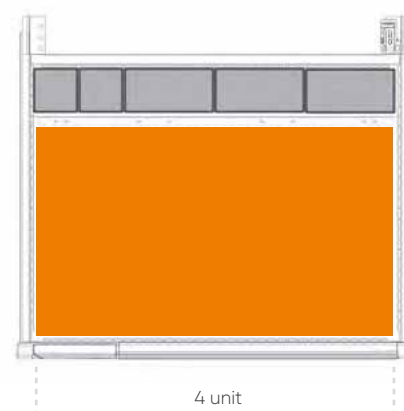
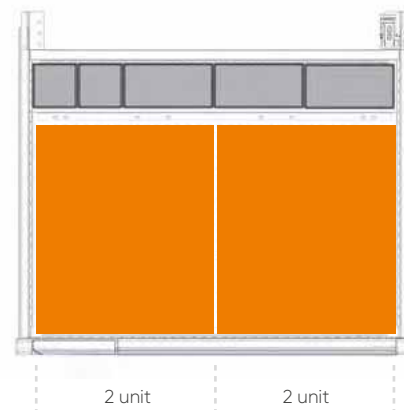
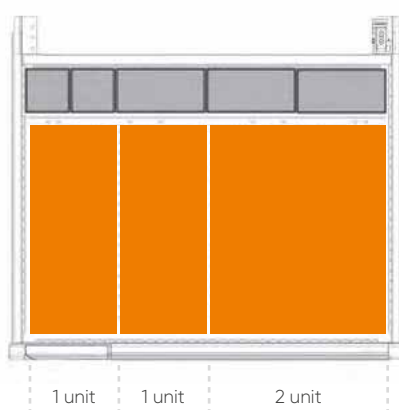
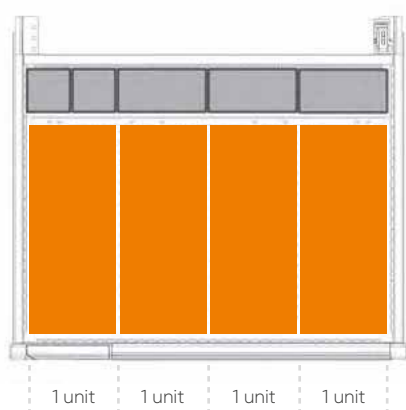



Gamma colori ACCIAIO

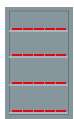

GRIGIO
RAL 7000
.01

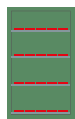

VERDE
RAL 6011
.02

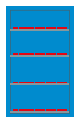

BLU
RAL 5012
.04

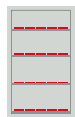

GRIGIO
RAL 7035
.08

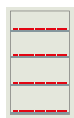

BIANCO GRIGIASTRO
RAL 9002
.1F

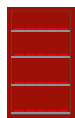

ROSSO RUBINO
RAL 3003
.1G

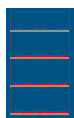

BLU GENZIANA
RAL 5010
.34



BIANCO PURO
RAL 9010
.35

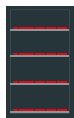

GRIGIO ANTRACITE
RAL 7016
.39

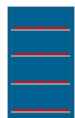

BLU CAPRI
RAL 5019
.48



ART. M 52 A100 C0 13 RS 1F

ARMADIO CON PORTE A BATTENTE completo di:
2 cassetti ad estrazione telescopica (200 kg)
1 cassetto ad estrazione flessibile (100 kg)
1 telaio porta boccole per cassetti
1 piano ad estrazione telescopica (200 kg)
1 piano superiore a 3 bordi
Dim. mm 1020x598x1023 H
Escluso utensili e boccole
COLORE ACCIAIO BIANCO GRIGIASTRO RAL 9002
COLORE PLASTICHE ROSSO GLAMOUR RED



ART. M 52 A200 C0 10 RT PW

ARMADIO CON TAPPARELLA completo di:
1 telaio porta boccole
2 cassetti ad estrazione telescopica (200 kg)
2 telai porta boccole per cassetti
1 piano ad estrazione telescopica (200 kg)
Dim. mm 1020x612x2250 H
Escluso utensili e boccole
COLORE ACCIAIO GRIGIO ANTRACITE RAL 7016 +
ROSSO RUBINO RAL 3003
COLORE PLASTICHE GRIGIO DARK GREY

PORTATA ARMADIO 3100 kg

Gamma colori PLASTICHE



DARK GREY
.M0



MEDITERRANEAN
BLUE .M1



SKY BLUE
.M2



GLAMOUR RED
.M3



RED CARPET
.M4



JUICY ORANGE
.M5



SUNNY YELLOW
.M6



FOREST GREEN
.M7

LEGENDA



PORTATA
CASSETTO



ESTRAZIONE
CASSETTO



CHIUSURA
ARMADIO



LE PORTATE SONO NETTE E SI RIFERISCONO A PESI UNIFORMEMENTE DISTRIBUITI.

H 1000 mm



porta 775 mm H

ART.					
M 52 A100 C0 10 QT 04		50-75-100	100-96-92%	key	
M 52 A100 T2 10 QT 04		50-75-100	100-96-92%	code	

Con 2 telai* - Escluse boccole

H 1000 mm



porta 775 mm H

ART.					
M 52 A100 C0 10 QU 04		50-75-100	100-96-92%	key	
M 52 A100 T2 10 QU 04		50-75-100	100-96-92%	code	

Con 1 telaio* - Escluse boccole

H 1000 mm



porta 900 mm H

ART.					
M 52 A100 C0 10 QV 04		50-75-100	100-96-92%	key	
M 52 A100 P5 10 QV 04		50-75-100	100-96-92%	code	

Con 2 telai* - Escluse boccole

H 1000 mm



porta 900 mm H

ART.					
M 52 A100 C0 10 QW 04		50-75-100	100-96-92%	key	
M 52 A100 P5 10 QW 04		50-75-100	100-96-92%	code	

Con 1 telaio* - Escluse boccole

*I TELAI HANNO INCLUSA LA COPPIA SUPPORTI ART. F NC 5630 00 01

H 1000 mm



4 cassetti

porta doppia

ART.



M 52 D100 C0 10 QX 04

50-75-100

100-96-92%

key

Con 2 telai* - Escluse boccole

H 1000 mm

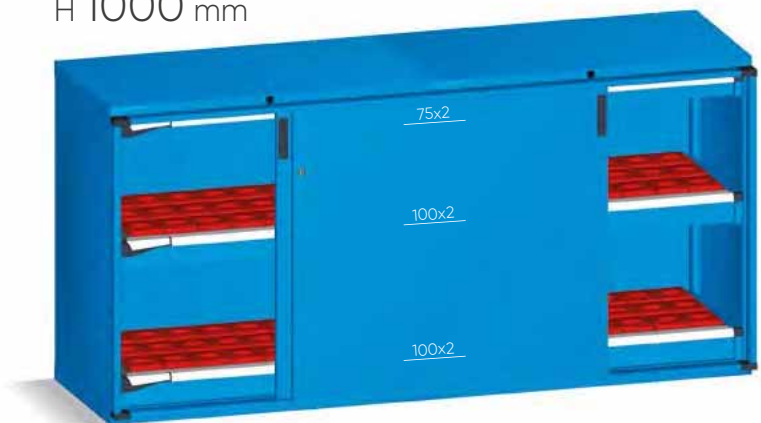

6 cassetti

porta doppia

ART.



M 52 D100 C0 10 QY 04

50-75-100

100-96-92%

key

Con 4 telai* - Escluse boccole

H 1000 mm

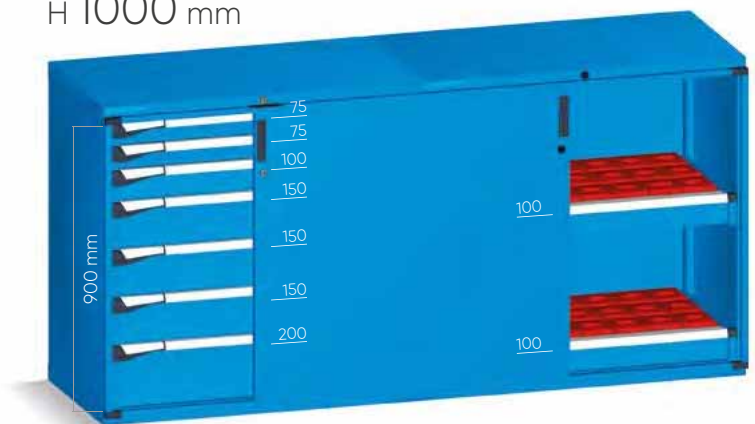

9 cassetti

porta singola

profondità 598 mm

ART.



M 52 D100 C0 10 QZ 04

50-75-100

100-96-92%

key

Con 2 telai* - Escluse boccole

*I TELAI HANNO INCLUSA LA COPPIA SUPPORTI ART. F NC 5630 00 01

H 1500 mm



H 1500 mm



porta 1400 mm

profondità 598 mm

ART.				
M 52 A150 C5 10 RB 04	50-75-100	100-96-92%	-	-

Con 3 telai* - Escluse boccole

ART.				
M 52 A150 C0 10 RC 04	50-75-100	100-96-92%	key	
M 52 A150 P5 10 RC 04	50-75-100	100-96-92%	code	

Con 3 telai* - Escluse boccole



H 2000 mm



ART.				
M52A200X010RD04	50-75-100	100-96-92%	-	

Con 4 telai* - Escluse boccole

H 2000 mm



ART.				
M52A200C510RE04	50-75-100	100-96-92%	-	

Con 2 telai* - Escluse boccole

H 2000 mm



ART.				
M52A200C510RF04	50-75-100	100-96-92%	-	

Con 3 telai* - Escluse boccole

H 2000 mm



ART.				
M52A200C510PS04	50-75-100	100-96-92%	-	

Con 4 telai* - Escluse boccole



ARMADIO CON PORTE A BATTENTE completo di:
 1 piano regolabile
 1 telaio porta boccole
 2 cassette ad estrazione flessibile (100 kg)
 2 telai porta boccole per cassette
 1 piano ad estrazione flessibile (100 kg)
 Dim. mm 1020x598x2000 H
 Escluso utensili, boccole e valigette
 COLORE ACCIAIO BLU RAL 5012 + BIANCO PURO RAL 9010
 COLORE PLASTICHE MEDITERRANEAN BLUE

ART. M 52 A200 C0 11 RR GS

*I TELAI NEI CASSETTI HANNO INCLUSA LA COPPIA SUPPORTI ART. F NC 5630 00 01

H 2000 mm

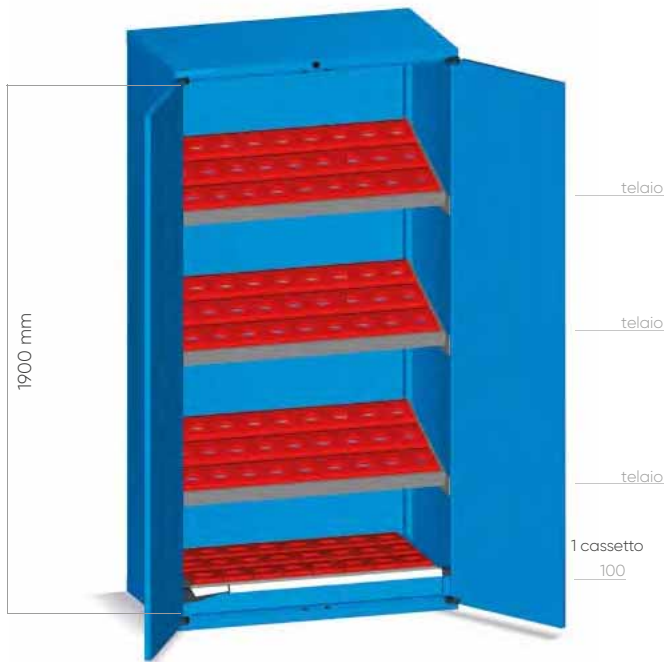

porta 1900 mm

ART.				
M 52 A200 C0 10 PT 04	50-75-100	100-96-92%	key	
M 52 A200 P5 10 PT 04	50-75-100	100-96-92%	code	

Con 4 telai* - Escluse boccole

H 2000 mm



porta 1900 mm

ART.				
M 52 A200 C0 10 PU 04	50-75-100	100-96-92%	key	
M 52 A200 P5 10 PU 04	50-75-100	100-96-92%	code	

Con 2 telai* - Escluse boccole

H 2000 mm



porta 1900 mm

ART.				
M 52 A200 C0 10 PV 04	50-75-100	100-96-92%	key	
M 52 A200 P5 10 PV 04	50-75-100	100-96-92%	code	

Con 3 telai* - Escluse boccole

H 2000 mm



porta 1900 mm

ART.				
M52A200C010PW04	50-75-100	100-96-92%	key	
M 52 A200 P5 10 PW 04	50-75-100	100-96-92%	code	

Con 4 telai* - Escluse boccole

H 2250 mm



armadio a tapparella

ART.				
M 52 A200 C0 10 PX 04	50-75-100	100-96-92%	key	

Con 4 telai* - Escluse boccole

H 2250 mm



armadio a tapparella

ART.				
M 52 A200 C0 10 PY 04	50-75-100	100-96-92%	key	

Con 2 telai* - Escluse boccole

H 2250 mm



armadio a tapparella

ART.				
M 52 A200 C0 10 PZ 04	50-75-100	100-96-92%	key	

Con 3 telai* - Escluse boccole

H 2250 mm



armadio a tapparella

ART.				
M 52 A200 C0 10 QA 04	50-75-100	100-96-92%	key	

Con 4 telai* - Escluse boccole

*I TELAI NEI CASSETTI HANNO INCLUSA LA COPPIA SUPPORTI ART. F NC 5630 00 01

H 2000 mm



telaio x 2

telaio x 2

telaio x 2

porta doppia

2 cassetti

ART.



M 52 D200 C010 QB 04

50-75-100

100-96-92%

key

Con 8 telai* - Escluse boccole

H 2000 mm



telaio x 2

100x2

100x2

100x2

porta doppia

6 cassetti

ART.



M 52 D200 C010 QC 04

50-75-100

100-96-92%

key

Con 8 telai* - Escluse boccole

*I TELAI NEI CASSETTI HANNO INCLUSA LA COPPIA SUPPORTI ART. F NC 5630 00 01



ART. M 52 D200 C0 10 RQ NM

ARMADIO CON PORTE SCORREVOLI completo di:

4 cassetti ad estrazione telescopica (200 kg)

4 telai porta boccole per cassetti

4 telai porta boccole

Dim. mm 2040x623x2000 H

Escluso utensili e boccole

COLORE ACCIAIO BIANCO GRIGIASTRO RAL 9002 +

ROSSO RUBINO RAL 3003

COLORE PLASTICHE DARK GREY

CONFIGURA IL TUO ARMADIO

H 1000 mm



porta 775 mm

Dim. mm 1020x598

ART.				
M 52 A100 C0 10 QL 04		50-75-100	100-96-92%	key
M 52 A100 T2 10 QL 04		50-75-100	100-96-92%	code

Armadio vuoto con asta vertebrata

H 1000 mm



porta 900 mm

Dim. mm 1020x598

ART.				
M 52 A100 C0 10 QM 04		-	-	key
M 52 A100 P5 10 QM 04		-	-	code

Armadio vuoto con asta vertebrata

H 1000 mm



armadio con 2 porte scorrevoli

Dim. mm 2040x623

ART.				
M 52 D100 C0 10 QN 04		-	-	key

Armadio vuoto con 2 aste vertebrate

H 1000 mm



armadio con 1 porta scorrevole

Dim. mm 2040x598

ART.				
M 52 D100 C0 10 QP 04		-	-	key

Armadio vuoto con 2 aste vertebrate, serratura a sinistra

H 1500 mm



1400 mm

Dim. mm 1020x573

ART.				
M 52 A150 C5 10 00 04	-	-	-	-

Armadio vuoto con asta vertebrata

H 1500 mm



porta 1400 mm

Dim. mm 1020x598

ART.				
M 52 A150 C0 10 QM 04	-	-	-	key
M 52 A150 P5 10 QM 04	-	-	-	code

Armadio vuoto con asta vertebrata

H 2000 mm

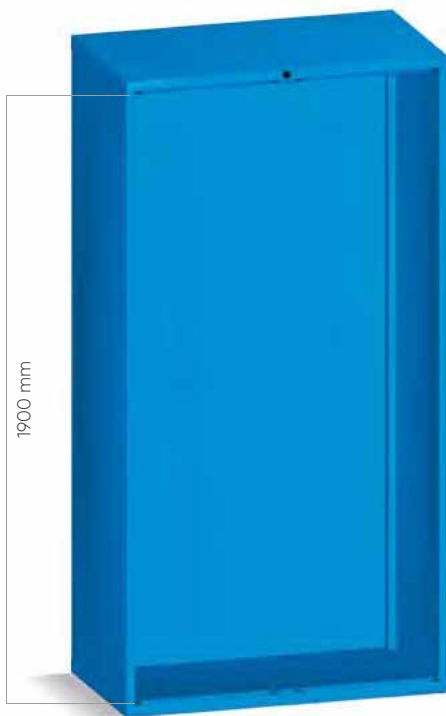

1900 mm

Dim. mm 1020x573

ART.				
M 52 A200 X0 10 00 04	-	-	-	-

Armadio vuoto

H 2000 mm



Dim. mm 1020x573

ART.				
M 52 A200 C5 10 00 04	-	-	-	-

Armadio vuoto con asta vertebrata



IN PRESENZA DI 2 O PIÙ CASSETTI / PIANI ESTRAIBILI,
È OBBLIGATORIO L'USO DELL'ASTA VERTEBRATA

H 2000 mm

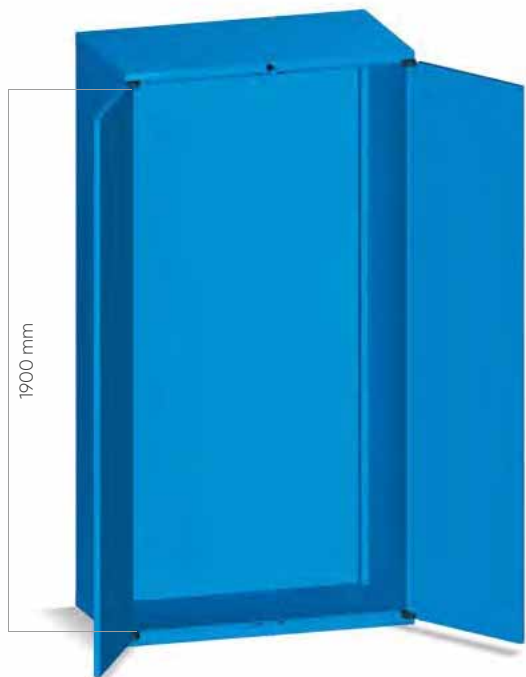

porta 1900 mm

Dim. mm 1020x598

ART.				
M52A200C010QQ04	-	-	-	key
M52A200P510QQ04	-	-	-	code

Armadio vuoto

H 2000 mm



porta 1900 mm

Dim. mm 1020x598

ART.				
M52A200C010QM04	-	-	-	key
M52A200P510QM04	-	-	-	code

Armadio vuoto con asta vertebrata

H 2250 mm



armadio con tapparella

Dim. mm 1020x612

ART.				
M52A200C010QR04	-	-	-	key

Armadio vuoto

H 2250 mm



armadio con tapparella

Dim. mm 1020x612

ART.				
M52A200C010QS04	-	-	-	key

Armadio vuoto con asta vertebrata

H 2000 mm



armadio con 2 porte scorrevoli

Dim. mm 2040x623

ART.				
M52D200 C010 0D 04		-	-	key

Armadio vuoto

H 2000 mm



armadio con 2 porte scorrevoli

Dim. mm 2040x623

ART.				
M52D200 C010 QN 04		-	-	key

Armadio vuoto con 2 aste vertebrate



IN PRESENZA DI 2 O PIÙ CASSETTI / PIANI ESTRAIBILI,
È OBBLIGATORIO L'USO DELL'ASTA VERTEBRATA





COMPLETO DI
4 SUPPORTI

TELAIO INCLINABILE PORTA BOCCOLE A 3 FILE

ART.	kg	Dim. mm
M 52 TE70 00 00 01 01	150	965x444x66 H

DISPONIBILE IN GRIGIO RAL 7000



I TELAI SONO REGOLABILI IN ALTEZZA E POSSONO ESSERE MONTATI ORIZZONTALI / INCLINATI



TELAIO PORTA BOCCOLE A 3 FILE PER CASSETTI

ART.	kg	Dim. mm
F NC 5140 00 01	-	890x444x69 H

DISPONIBILE IN GRIGIO RAL 7000



La portata del telaio è data dalla portata del cassetto



COPPIA SUPPORTI

ART.	Max. Schafthöhe mm	Dim. mm
F NC 5630 00 01	A = 93/118/143	446x86 H
F NC 5830 00 01	A = 143/168/193	446x136 H

DISPONIBILE IN GRIGIO RAL 7000

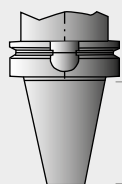



(rif. A)
Altezza cono
dell'utensile



H max del cono dell'utensile mm (rif. A)	H telaio con cassetto mm (rif. B)
93	115
118	140
143	165
168	190
193	215



(rif. B)
Altezza del cassetto
con telaio e boccole

Il passo della regolazione in altezza del cassetto è di 25 mm

ART.	TIPO BOCCOLA	  	
		Q.TÀ PER TELAIO M 52 TE70	Q.TÀ PER TELAIO F NC 5140
F NC 9510 00 03	ISO 30	42	39
F NC 9530 00 03	ISO 40	42	39
F NC 9540 00 03	ISO 45	33	30
F NC 9550 00 03	ISO 50	27	24
F NC 9560 00 03	VDI 30	42	39
F NC 9570 00 03	VDI 40	33	30
F NC 9580 00 03	VDI 50	33	30
F NC 9590 00 03	VDI 60	27	24
F NC 9720 00 03	CONO MORSE 2	42	39
F NC 9730 00 03	CONO MORSE 3	42	39
F NC 9740 00 03	CONO MORSE 4	42	39
F NC 9750 00 03	CONO MORSE 5	33	30
F NC 9270 00 03	CAPTO C3	42	39
F NC 9275 00 03	CAPTO C4	33	30
F NC 9280 00 03	CAPTO C5	33	30

ART.	TIPO BOCCOLA	  	
		Q.TÀ PER TELAIO M 52 TE70	Q.TÀ PER TELAIO F NC 5140
F NC 9285 00 03	CAPTO C6	33	30
F NC 9290 00 03	CAPTO C8	24	24
F NC 9210 00 03	HSK A32-B40	42	39
F NC 9220 00 03	HSK A40-B50	42	39
F NC 9230 00 03	HSK A50-B63	33	30
F NC 9240 00 03	HSK A63-B80	33	30
F NC 9250 00 03	HSK A80-B100	24	24
F NC 9260 00 03	HSK A100-B125	24	24
F NC 9640 00 03	2"	33	30
F NC 9650 00 03	2" 1/4	27	24
F NC 9010 00 03	58 mm	45	42
F NC 9020 00 03	65 mm	42	39
F NC 9030 00 03	75 mm	36	33
F NC 9040 00 03	87 mm	30	27
F NC 9050 00 03	105 mm	24	24





CASSETTI AD ESTRAZIONE FLESSIBILE

ART. CON kit plastiche Dark Grey	ART. SENZA kit plastiche*	Dim. utili mm	H frontale mm	kg	
M 52 C050 0110 OF __	M 52 C050 0100 OF __	906x447x31 H	50	50 - 75 - 100	100% - 96% - 92%
M 52 C075 0110 OF __	M 52 C075 0100 OF __	906x447x56 H	75	50 - 75 - 100	100% - 96% - 92%
M 52 C100 0110 OF __	M 52 C100 0100 OF __	906x447x81 H	100	50 - 75 - 100	100% - 96% - 92%
M 52 C125 0110 OF __	M 52 C125 0100 OF __	906x447x106 H	125	50 - 75 - 100	100% - 96% - 92%
M 52 C150 0110 OF __	M 52 C150 0100 OF __	906x447x131 H	150	50 - 75 - 100	100% - 96% - 92%
M 52 C200 0110 OF __	M 52 C200 0100 OF __	906x447x181 H	200	50 - 75 - 100	100% - 96% - 92%
M 52 C250 0110 OF __	M 52 C250 0100 OF __	906x447x231 H	250	50 - 75 - 100	100% - 96% - 92%
M 52 C300 0110 OF __	M 52 C300 0100 OF __	906x447x281 H	300	50 - 75 - 100	100% - 96% - 92%

* ABBINARE AL CODICE ARTICOLO UNO DEI KIT PLASTICHE DISPONIBILI NELLA TABELLA SOTTOSTANTE



CASSETTI AD ESTRAZIONE TELESCOPICA

ART. CON kit plastiche Dark Grey	ART. SENZA kit plastiche*	Dim. utili mm	H frontale mm	kg	
M 52 C075 0110 OT __	M 52 C075 0100 OT __	906x447x56 H	75	200	100%
M 52 C100 0110 OT __	M 52 C100 0100 OT __	906x447x81 H	100	200	100%
M 52 C125 0110 OT __	M 52 C125 0100 OT __	906x447x106 H	125	200	100%
M 52 C150 0110 OT __	M 52 C150 0100 OT __	906x447x131 H	150	200	100%
M 52 C200 0110 OT __	M 52 C200 0100 OT __	906x447x181 H	200	200	100%
M 52 C250 0110 OT __	M 52 C250 0100 OT __	906x447x231 H	250	200	100%
M 52 C300 0110 OT __	M 52 C300 0100 OT __	906x447x281 H	300	200	100%

* ABBINARE AL CODICE ARTICOLO UNO DEI KIT PLASTICHE DISPONIBILI NELLA TABELLA SOTTOSTANTE

KIT PLASTICHE PER CASSETTI E PIANI ESTRAIBILI



GAMMA COLORI PLASTICHE	ART.
MEDITERRANEAN BLUE	M 50 PLS1 00 00 00 M1
SKY BLUE	M 50 PLS1 00 00 00 M2
GLAMOUR RED	M 50 PLS1 00 00 00 M3
RED CARPET	M 50 PLS1 00 00 00 M4
JUICY ORANGE	M 50 PLS1 00 00 00 M5
SUNNY YELLOW	M 50 PLS1 00 00 00 M6
FOREST GREEN	M 50 PLS1 00 00 00 M7



PIANO ESTRAIBILE AD ESTRAZIONE FLESSIBILE

ART. CON kit plastiche Dark Grey	ART. SENZA kit plastiche*	Dim. utili mm	H frontale mm	kg	
M 52 C057 0110 0F __	M 52 C057 01 00 0F __	906x447	70	50 - 75 - 100	100% - 96% - 92%

* ABBINARE AL CODICE ARTICOLO UNO DEI KIT PLASTICHE DISPONIBILI NELLA TABELLA A SINISTRA



PIANO ESTRAIBILE AD ESTRAZIONE TELESCOPICA

ART. CON kit plastiche Dark Grey	ART. SENZA kit plastiche*	Dim. utili mm	H frontale mm	kg	
M 52 C057 0110 0T __	M 52 C057 01 00 0T __	906x447	70	200	100%

* ABBINARE AL CODICE ARTICOLO UNO DEI KIT PLASTICHE DISPONIBILI NELLA TABELLA A SINISTRA



PIANO REGOLABILE

ART.	Dim. utili mm	H totale mm	kg
M 52 PR25 00 00 01 __	963x478	60	100

INSERIBILE DAVANTI ALL'ASTA VERTEBRATA

RICAMBI - FISSAGGIO

SERRATURA DI RICAMBIO

ART. M 00 CSR0 8800 00 00

Serratura di ricambio con due chiavi



CHIAVE DI RICAMBIO

ART. M 00 CF00 0000 00 00

Specificare sempre il numero indicato nella serratura a cilindro dove si vuole sostituire la chiave



PASSEPARTOUT

ART. M 00 PF.. 0000 00 00

Disponibile in 23 serie, con numerazione da F 01 a F 23.

Passepartout serie F 01
Passepartout serie F 02
Passepartout serie F ..

ART. M 00 PF01 00 00 00 00
ART. M 00 PF02 00 00 00 00
ART. M 00 PF.. 00 00 00 00

SET FISSAGGIO TRA ARMADI

ART. M 00 FISO 00 00 00 99

Set di fissaggio armadio-armadio con 4 viti complete di dadi M8

ART. M 00 SVRO 00 00 00 99

Foratura e viteria per il fissaggio dei due armadi sovrapposti

SET DI FISSAGGIO A PAVIMENTO



ART. F AG 9200 00 99

Coppia staffe zincate per il fissaggio a pavimento dell'armadio

ART. F AG 9204 00 99

2 tasselli "HILTI" adatti per pavimenti in calcestruzzo non fessurato maggiore o uguale alla classe: C20/25
Trazione consigliata del tassello: 2,9 kN
Diametro tassello: Ø 6 mm



MANIGLIA DI RICAMBIO

ART. M 00 PLS0 0000 22 M0

Maniglia di ricambio per porte disponibile in colore Dark Grey.



ALTRI COLORI A RICHIESTA



GLI ARMADI DEVONO ESSERE FISSATI A PAVIMENTO O A PARETE
SE SOVRAPPosti DEVONO ESSERE FISSATI OBBLIGATORIAMENTE A PARETE E LA LORO PORTATA DIVISA PER DUE



PIANO SUPERIORE A 3 BORDI

ART.	dim. mm	
M 52 T023 AG 00 31 07	1020x573x23 H	

Piano rivestito in pvc per ARMADIO SINGOLO. Colore nero



PIANO SUPERIORE A 4 BORDI

ART.	dim. mm	
M 52 T023 AG 00 41 07	1020x573x23 H	

Piano rivestito in pvc per ARMADIO SINGOLO. Colore nero



ART. M 00 T023 AG 00 FO 00

FORATURA PIANO SUPERIORE DELL'ARMADIO
PER IL FISSAGGIO DEL PIANO A 4 BORDI



PIANO SUPERIORE IN MDF DIM. 1020x573x32 mm H

ART.	rifiniture	per armadio	
M 52 T030 MD GM 21 07	1 profilo laterale	finale dx o sx	

Piano in MDF con copertura in gomma antiolio. Colore nero



PIANO SUPERIORE IN MDF DIM. 1020x573x32 mm H

ART.	rifiniture	per armadio	
M 52 T030 MD GM 11 07	-	centrale	

Piano in MDF con copertura in gomma antiolio. Colore nero



PIANO SUPERIORE IN MDF DIM. 1020x573x32 mm H

ART.	rifiniture	per armadio	
M 52 T030 MD GM 01 07	2 profili laterali	singolo	

Piano in MDF con copertura in gomma antiolio. Colore nero

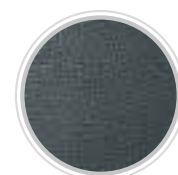

RIFINITURA
GOMMA
ANTIOLIO



APPLICAZIONE
PIANO IN MDF



ART. M 00 T030 MD 00 FO 00

FORATURA PIANO SUPERIORE DELL'ARMADIO
PER IL FISSAGGIO DEL PIANO IN MDF
COMPRESIVO DI VITI



ZOCCOLO DI RIALZO ALTEZZA 50 mm

ART.		dim. mm	
M 52 Z050 00 00 00 _ _		1018x572x50 H	



ZOCCOLO DI RIALZO ALTEZZA 100 mm

ART.		dim. mm	
M 52 Z100 00 00 00 _ _		1018x572x100 H	



ZOCCOLI PER CARRELLO ELEVATORE - Colore nero RAL 9005

ART.		dim. mm	
M 02 Z060 20 00 00 07	coppia zoccoli	200x569x60 H	
M 50 Z060 21 00 00 07	chiusura per coppia zoccoli	1014x46x55 H	



ART.		dim. mm	
M 02 Z100 20 00 00 07	coppia zoccoli	200x569x100 H	
M 50 Z100 21 00 00 07	chiusura per coppia zoccoli	1014x46x95 H	



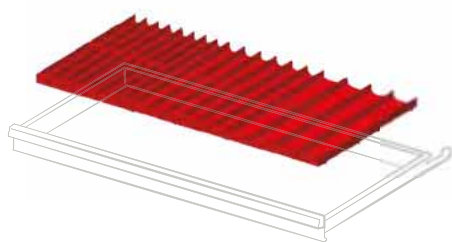

ART. per altezza frontale mm

F FH 4005 12 00 50 - 300

Set composto da: 6 divisori 4 canali, 6 divisori 3 canali, 6 divisori 2 canali, 15 divisori trasversali 36 mm, 10 divisori trasversali 47 mm, 6 divisori trasversali 73 mm

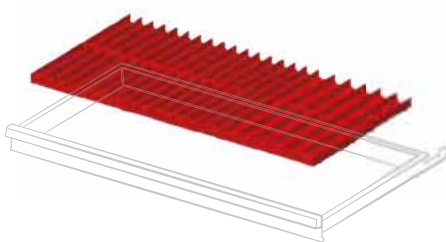

ART. per altezza frontale mm

F FH 4005 15 00 50 - 300

Set composto da: 12 divisori 4 canali, 6 divisori 3 canali, 30 divisori trasversali 36 mm, 10 divisori trasversali 47 mm

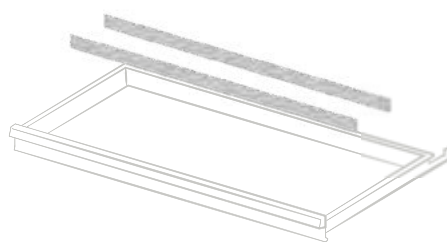

ART. per altezza frontale mm

F FH 4005 01 00 50

F FH 4007 01 00 75

F FH 4010 01 00 100 - 125

F FH 4015 01 00 150

F FH 4020 01 00 200 - 250

F FH 4030 01 00 300

Set composto da: 2 divisori longitudinali non fessurati 914 mm

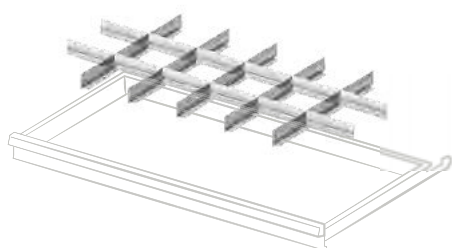

ART. per altezza frontale mm

F FH 4005 03 00 50

F FH 4007 03 00 75

F FH 4010 03 00 100 - 125

F FH 4015 03 00 150

F FH 4020 03 00 200 - 250

Set composto da: 5 divisori longitudinali fessurati 455 mm, 12 divisori trasversali 149 mm

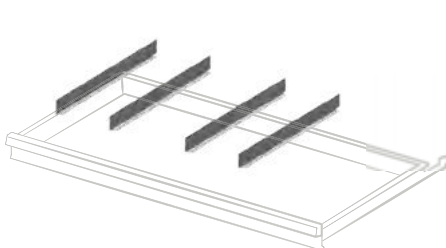

ART. per altezza frontale mm

F FH 4005 04 00 50

F FH 4007 04 00 75

F FH 4010 04 00 100 - 125

F FH 4015 04 00 150

F FH 4020 04 00 200 - 250

Set composto da: 4 divisori longitudinali non fessurati 455 mm

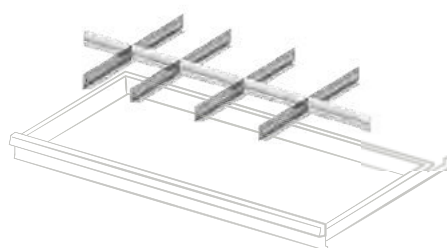

ART. per altezza frontale mm

F FH 4005 05 00 50

F FH 4007 05 00 75

F FH 4010 05 00 100 - 125

F FH 4015 05 00 150

F FH 4020 05 00 200 - 250

Set composto da: 4 divisori longitudinali fessurati 455 mm, 2 divisori trasversali 149 mm, 3 divisori trasversali 200 mm

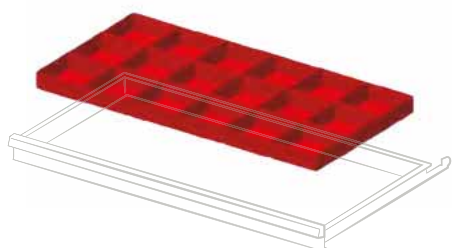

ART. per altezza frontale mm

F FH 4005 11 00 50

F FH 4007 11 00 75

F FH 4010 11 00 100 - 125

Set composto da: 18 cassette divisorio 150x150 mm

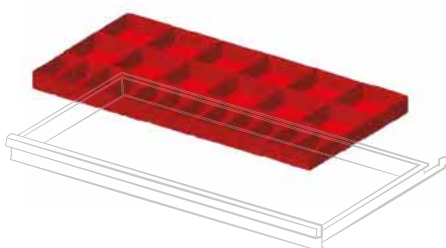

ART. per altezza frontale mm

F FH 4005 13 00 50

F FH 4007 13 00 75

F FH 4010 13 00 100 - 125

Set composto da: 12 cassette divisorio 150x75 mm, 12 cassette divisorio 150x150 mm

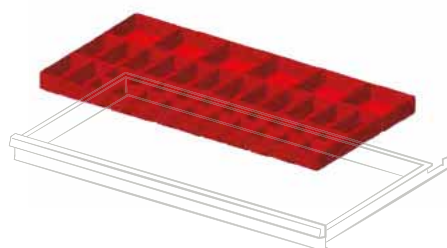

ART. per altezza frontale mm

F FH 4005 16 00 50

F FH 4007 16 00 75

Set composto da: 20 cassette divisorio 75x75 mm, 14 cassette divisorio 150x75 mm, 6 cassette divisorio 150x150 mm

CONFIGURA IL CASSETTO FAMI CON UTENSILI BETA



ART. F FH 4007 50 07

Set di predisposizione cassetto per termoformati Beta composto da:

n. 4 F HC 6071 00 07

n. 4 F HC 6471 00 07

n. 1 F HA 2150 00 99



1 unit = 1 termoformato Beta 367x147 mm

2 unit = 1 termoformato Beta 367x294 mm





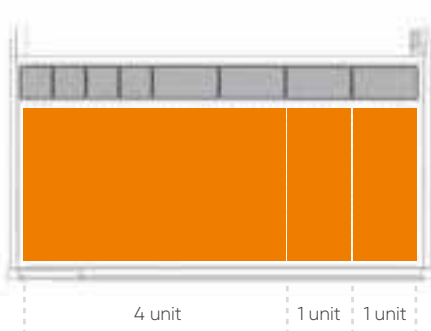
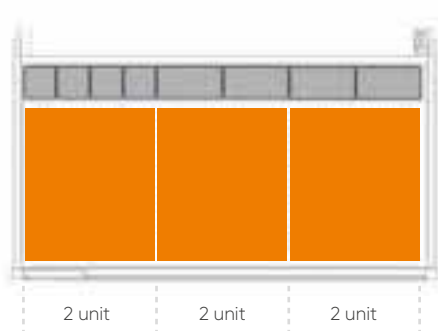
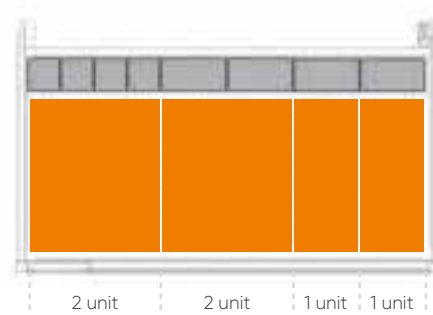
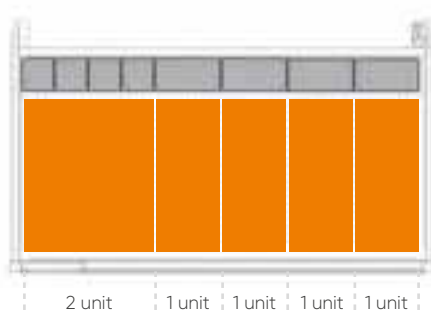
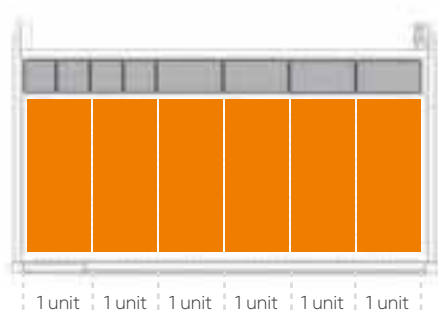

4 unit = 1 termoformato Beta 367x588 mm

ESEMPI DI UTILIZZO TERMOFORMATO

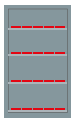
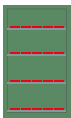

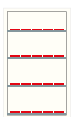
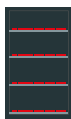
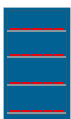

Gamma colori ACCIAIO

	
GRIGIO RAL 7000 .01	VERDE RAL 6011 .02
	
BLU RAL 5012 .04	GRIGIO RAL 7035 .08
	
BIANCO GRIGIASTRO RAL 9002 .1F	ROSSO RUBINO RAL 3003 .1G
	
BLU GENZIANA RAL 5010 .34	BIANCO PURO RAL 9010 .35
	
GRIGIO ANTRACITE RAL 7016 .39	BLU CAPRI RAL 5019 .48











ART. M 33 A100 C0 12 RP FD

ARMADIO CON PORTE A BATTENTE completo di:
 3 cassetti ad estrazione telescopica (200 kg)
 2 telai porta boccole
 1 piano superiore a 3 bordi
 Dim. mm 714x751x1023 H
 Escluso utensili e boccole
 COLORE ACCIAIO GRIGIO CHIARO RAL 7035 +
 BLU GENZIANA RAL 5010
 COLORE PLASTICHE SKY BLUE

PORTATA ARMADIO 3100 kg

Gamma colori PLASTICHE

			
DARK GREY .M0	MEDITERRANEAN BLUE .M1	SKY BLUE .M2	GLAMOUR RED .M3
			
RED CARPET .M4	JUICE ORANGE .M5	SUNNY YELLOW .M6	FOREST GREEN .M7

LEGENDA



PORTATA CASSETTO/
PIANO



ESTRAZIONE CASSETTO/
PIANO



CHIUSURA ARMADIO



LE PORTATE SONO NETTE E SI RIFERISCONO A PESI UNIFORMEMENTE DISTRIBUITI.

H 1000 mm



porta 775 mm H

H 1000 mm

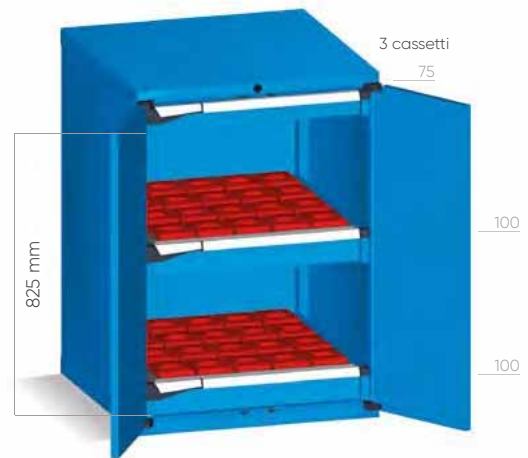

porta 900 mm H

ART.				
M 33 A100 C0 10 QT 04		50-75-100	100-96-92%	key
M 33 A100 T2 10 QT 04		50-75-100	100-96-92%	code

Con 2 telai* - Escluse boccole

ART.				
M 33 A100 C0 10 QV 04		50-75-100	100-96-92%	key
M 33 A100 P5 10 QV 04		50-75-100	100-96-92%	code

Con 2 telai* - Escluse boccole

*I TELAI HANNO INCLUSA LA COPPIA SUPPORTI ART. F NC 5650 00 01



H 1000 mm

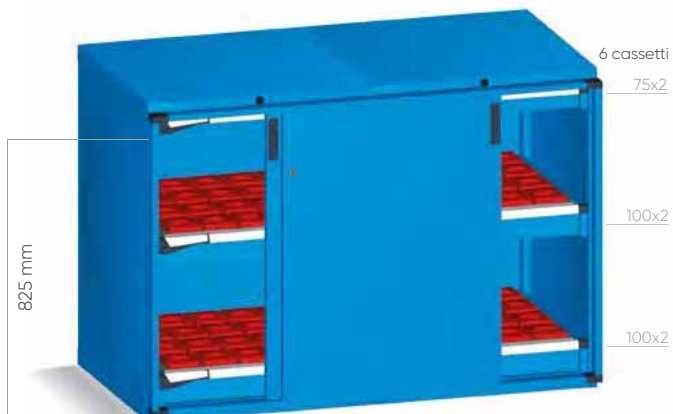

porta doppia

ART.				
M33D100C010QY04	50-75-100	100-96-92%	key	

Con 4 telai* - Escluse boccole

H 1000 mm



porta singola

profondità 751 mm

ART.				
M33D100C010QZ04	50-75-100	100-96-92%	key	

Con 2 telai* - Escluse boccole



H 1500 mm



H 1500 mm



porta 1400 mm

profondità 751 mm

ART.



kg



M 33 A150 C5 10 RB 04

50-75-100

100-96-92%

-

Con 3 telai* - Escluse boccole

ART.



kg



M 33 A150 C0 10 RC 04

50-75-100

100-96-92%

key

M 33 A150 P5 10 RC 04

50-75-100

100-96-92%

code

Con 3 telai* - Escluse boccole

H 2000 mm

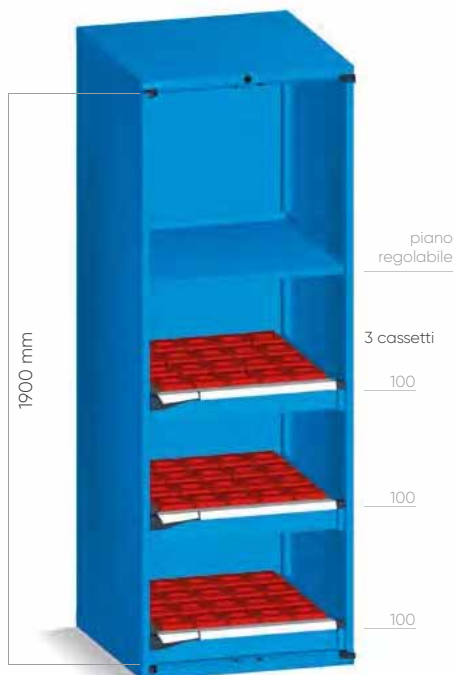

H 2000 mm



porta 1900 mm

profondità 751 mm

ART.



kg



M 33 A200 C5 10 QD 04

50-75-100

100-96-92%

-

Con 3 telai* - Escluse boccole

ART.



kg



M 33 A200 C0 10 QE 04

50-75-100

100-96-92%

key

M 33 A200 P5 10 QE 04

50-75-100

100-96-92%

code

Con 3 telai* - Escluse boccole

*I TELAI HANNO INCLUSA LA COPPIA SUPPORTI ART. F NC 5650 00 01

H 2250 mm

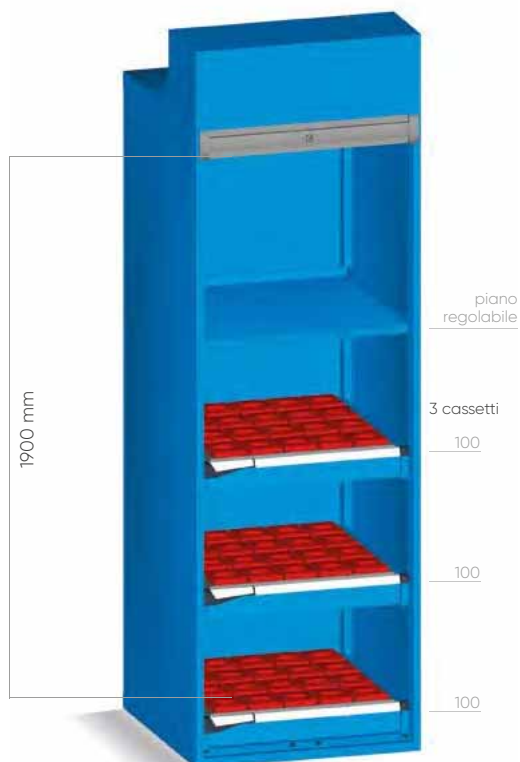

piano regolabile

3 cassetti

100

100

100

armadio con tapparella

ART.				
M33A200C010QF04	50-75-100	100-96-92%	key	

Con 3 telai* - Escluse boccole

H 2250 mm



piano regolabile

2 cassetti

100

100

piano estraibile

armadio con tapparella

ART.				
M33A200C010QG04	50-75-100	100-96-92%	key	

Con 2 telai* - Escluse boccole



H 2000 mm

H 2000 mm

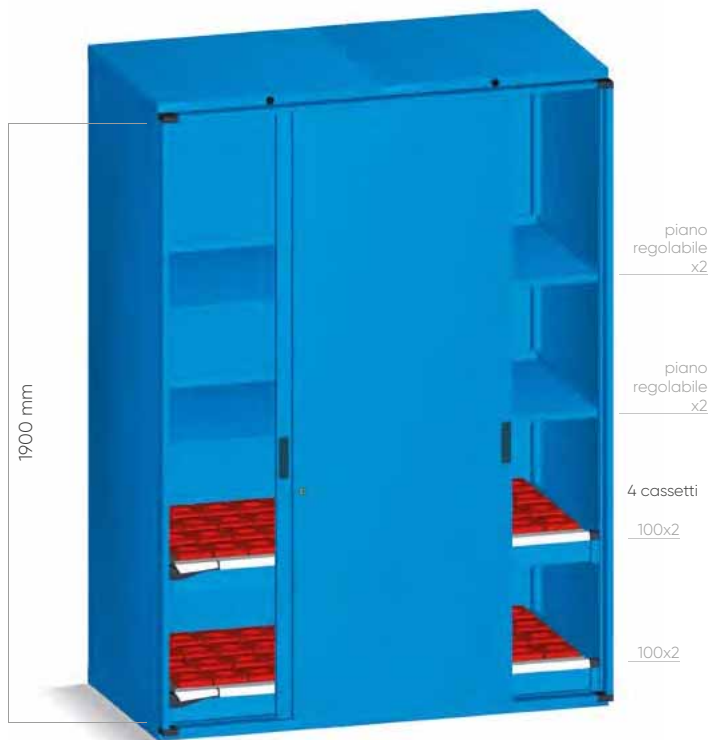

porta doppia

ART.				
M33D200C010QH04	50-75-100	100-96-92%	key	

Con 4 telai* - Escluse boccole

porta doppia

ART.				
M33D200C010QK04	50-75-100	100-96-92%	key	

Con 6 telai* - Escluse boccole

*I TELAI HANNO INCLUSA LA COPPIA SUPPORTI ART. F NC 5650 00 01



CONFIGURA IL TUO ARMADIO

H 1000 mm



porta 775 mm

Dim. mm 714x751

ART.				
M 33 A100 C010 QL 04		50-75-100	100-96-92%	key
M 33 A100 T2 10 QL 04		50-75-100	100-96-92%	code

Armadio vuoto con asta vertebata

H 1000 mm



porta 900 mm

Dim. mm 714x751

ART.				
M 33 A100 C010 QM 04		-	-	key
M 33 A100 P5 10 QM 04		-	-	code

Armadio vuoto con asta vertebata

H 1000 mm



armadio con 2 porte scorrevoli

Dim. mm 1428x776

ART.				
M 33 D100 C010 QN 04		-	-	key

Armadio vuoto con 2 aste vertebate

H 1000 mm



armadio con 1 porta scorrevole

Dim. mm 1428x751

ART.				
M 33 D100 C010 QP 04		-	-	key

Armadio vuoto con 2 aste vertebate, serratura a sinistra

H 1500 mm

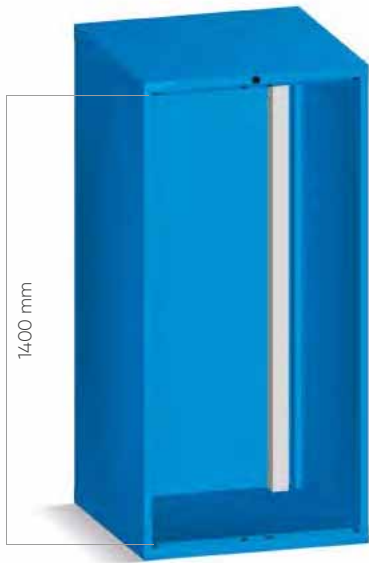

Dim. mm 714x726

ART.				
M 33 A150 C5 10 00 04	-	-	-	-

Armadio vuoto con asta vertebrata

H 1500 mm



porta 1400 mm

Dim. mm 714x751

ART.				
M33A150C010QM04	-	-	-	key
M33A150P510QM04	-	-	-	code

Armadio vuoto con asta vertebrata

H 2000 mm



Dim. mm 714x726

ART.				
M 33 A200 X010 00 04	-	-	-	-

Armadio vuoto

H 2000 mm



Dim. mm 714x726

ART.				
M33A200C5100004	-	-	-	-

Armadio vuoto con asta vertebrata



IN PRESENZA DI 2 O PIÙ CASSETTI / PIANI ESTRAIBILI,
È OBBLIGATORIO L'USO DELL'ASTA VERTEBRATA

H 2000 mm

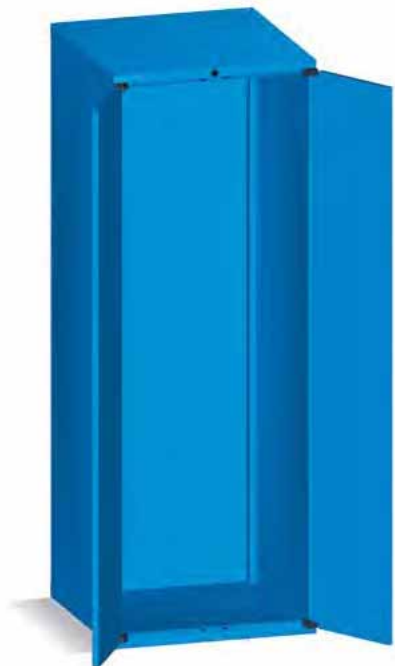

porta 1900 mm

Dim. mm 714x751

ART.				
M 33 A200 C010 QQ 04	-	-	-	key
M 33 A200 P510 QQ 04	-	-	-	code

Armadio vuoto

H 2000 mm

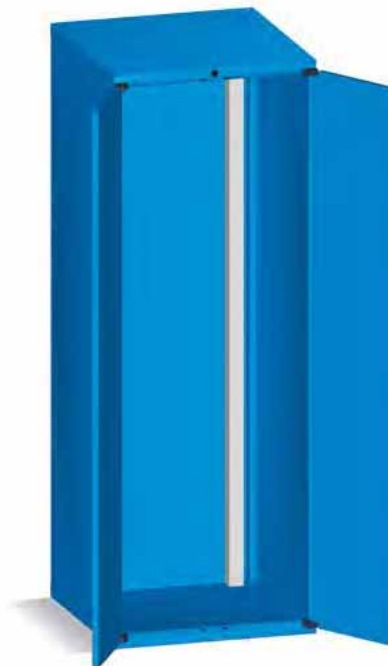

porta 1900 mm

Dim. mm 714x751

ART.				
M 33 A200 C010 QM 04	-	-	-	key
M 33 A200 P510 QM 04	-	-	-	code

Armadio vuoto con asta vertebraata

H 2250 mm



armadio con tapparella

Dim. mm 714x765

ART.				
M 33 A200 C010 QR 04	-	-	-	key

Armadio vuoto

H 2250 mm



armadio con tapparella

Dim. mm 714x765

ART.				
M 33 A200 C010 QS 04	-	-	-	key

Armadio vuoto con asta vertebraata

H 2000 mm



armadio con 2 porte scorrevoli

Dim. mm 1428x776

ART.				
M33D200C0100D04	-	-	-	key

Armadio vuoto

H 2000 mm



armadio con 2 porte scorrevoli

Dim. mm 1428x776

ART.				
M33D200C010QN04	-	-	-	key

Armadio vuoto con 2 aste vertebrate



IN PRESENZA DI 2 O PIÙ CASSETTI / PIANI ESTRAIBILI,
È OBBLIGATORIO L'USO DELL'ASTA VERTEBRATA





COMPLETO DI
4 SUPPORTI

TELAIO INCLINABILE PORTA BOCCOLE A 4 FILE

ART.	kg	Dim. mm
M 33 TE70 00 00 01 01	150	659x592x66 H

DISPONIBILE IN GRIGIO RAL 7000



TELAIO PORTA BOCCOLE A 4 FILE PER CASSETTI

ART.		Dim. mm
F NC 5220 00 01	-	584x592x69 H

DISPONIBILE IN GRIGIO RAL 7000

COPPIA SUPPORTI

ART.	H max cono utensile mm	Dim. mm
F NC 5650 00 01	A = 93/118/143	594x86 H
F NC 5840 00 01	A = 143/168/193	594x136 H

DISPONIBILE IN GRIGIO RAL 7000



La portata del telaio è data dalla portata del cassetto

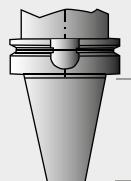

(rif. A)
Altezza cono dell'utensile

H max del cono dell'utensile mm (rif. A)	H telaio con cassetto mm (rif. B)
93	115
118	140
143	165
168	190
193	215



(rif. B)
Altezza del cassetto con telaio e boccole

Il passo della regolazione in altezza del cassetto è di 25 mm

ART.	TIPO BOCCOLA	QTÀ PER TELAIO M 33 TE70	QTÀ PER TELAIO F NC 5220
F NC 9510 00 03	ISO 30	36	32
F NC 9530 00 03	ISO 40	36	32
F NC 9540 00 03	ISO 45	28	24
F NC 9550 00 03	ISO 50	24	20
F NC 9560 00 03	VDI 30	36	32
F NC 9570 00 03	VDI 40	28	24
F NC 9580 00 03	VDI 50	28	24
F NC 9590 00 03	VDI 60	24	20
F NC 9720 00 03	CONO MORSE 2	36	32
F NC 9730 00 03	CONO MORSE 3	36	32
F NC 9740 00 03	CONO MORSE 4	36	32
F NC 9750 00 03	CONO MORSE 5	28	24
F NC 9270 00 03	CAPTO C3	36	32
F NC 9275 00 03	CAPTO C4	28	24
F NC 9280 00 03	CAPTO C5	28	24

ART.	TIPO BOCCOLA	QTÀ PER TELAIO M 33 TE70	QTÀ PER TELAIO F NC 5220
F NC 9285 00 03	CAPTO C6	28	24
F NC 9290 00 03	CAPTO C8	20	20
F NC 9210 00 03	HSK A32-B40	36	32
F NC 9220 00 03	HSK A40-B50	36	32
F NC 9230 00 03	HSK A50-B63	28	24
F NC 9240 00 03	HSK A63-B80	28	24
F NC 9250 00 03	HSK A80-B100	20	20
F NC 9260 00 03	HSK A100-B125	20	20
F NC 9640 00 03	2"	28	24
F NC 9650 00 03	2" 1/4	24	20
F NC 9010 00 03	58 mm	30	36
F NC 9020 00 03	65 mm	40	32
F NC 9030 00 03	75 mm	36	28
F NC 9040 00 03	87 mm	28	24
F NC 9050 00 03	105 mm	20	20



CASSETTI AD ESTRAZIONE FLESSIBILE

ART. CON kit plastiche Dark Grey	ART. SENZA kit plastiche*	Dim. utili mm	H frontale mm	kg	
M 33 C050 0110 OF __	M 33 C050 0100 OF __	600x600x31 H	50	50 - 75 - 100	100% - 96% - 92%
M 33 C075 0110 OF __	M 33 C075 0100 OF __	600x600x56 H	75	50 - 75 - 100	100% - 96% - 92%
M 33 C100 0110 OF __	M 33 C100 0100 OF __	600x600x81 H	100	50 - 75 - 100	100% - 96% - 92%
M 33 C125 0110 OF __	M 33 C125 0100 OF __	600x600x106 H	125	50 - 75 - 100	100% - 96% - 92%
M 33 C150 0110 OF __	M 33 C150 0100 OF __	600x600x131 H	150	50 - 75 - 100	100% - 96% - 92%
M 33 C200 0110 OF __	M 33 C200 0100 OF __	600x600x181 H	200	50 - 75 - 100	100% - 96% - 92%
M 33 C250 0110 OF __	M 33 C250 0100 OF __	600x600x231 H	250	50 - 75 - 100	100% - 96% - 92%
M 33 C300 0110 OF __	M 33 C300 0100 OF __	600x600x281 H	300	50 - 75 - 100	100% - 96% - 92%

* ABBINARE AL CODICE ARTICOLO UNO DEI KIT PLASTICHE DISPONIBILI NELLA TABELLA SOTTOSTANTE



CASSETTI AD ESTRAZIONE TELESCOPICA

ART. CON kit plastiche Dark Grey	ART. SENZA kit plastiche*	Dim. utili mm	H frontale mm	kg	
M 33 C075 0110 OT __	M 33 C075 0100 OT __	600x600x56 H	75	200	100%
M 33 C100 0110 OT __	M 33 C100 0100 OT __	600x600x81 H	100	200	100%
M 33 C125 0110 OT __	M 33 C125 0100 OT __	600x600x106 H	125	200	100%
M 33 C150 0110 OT __	M 33 C150 0100 OT __	600x600x131 H	150	200	100%
M 33 C200 0110 OT __	M 33 C200 0100 OT __	600x600x181 H	200	200	100%
M 33 C250 0110 OT __	M 33 C250 0100 OT __	600x600x231 H	250	200	100%
M 33 C300 0110 OT __	M 33 C300 0100 OT __	600x600x281 H	300	200	100%

* ABBINARE AL CODICE ARTICOLO UNO DEI KIT PLASTICHE DISPONIBILI NELLA TABELLA SOTTOSTANTE

KIT PLASTICHE PER CASSETTI E PIANI ESTRAIBILI



GAMMA COLORI PLASTICHE	ART.
MEDITERRANEAN BLUE	M 30 PLS1 00 00 00 M1
SKY BLUE	M 30 PLS1 00 00 00 M2
GLAMOUR RED	M 30 PLS1 00 00 00 M3
RED CARPET	M 30 PLS1 00 00 00 M4
JUICY ORANGE	M 30 PLS1 00 00 00 M5
SUNNY YELLOW	M 30 PLS1 00 00 00 M6
FOREST GREEN	M 30 PLS1 00 00 00 M7



PIANO ESTRAIBILE AD ESTRAZIONE FLESSIBILE

ART. CON kit plastiche Dark Grey	ART. SENZA kit plastiche*	Dim. utili mm	H frontale mm	kg	
M 33 C057 01 10 OF __	M 33 C057 01 00 OF __	600x600	70	50 - 75 - 100	100% - 96% - 92%

* ABBINARE AL CODICE ARTICOLO UNO DEI KIT PLASTICHE DISPONIBILI NELLA TABELLA A SINISTRA



PIANO ESTRAIBILE AD ESTRAZIONE TELESCOPICA

ART. CON kit plastiche Dark Grey	ART. SENZA kit plastiche*	Dim. utili mm	H frontale mm	kg	
M 33 C057 01 10 OT __	M 33 C057 01 00 OT __	600x600	70	200	100%

* ABBINARE AL CODICE ARTICOLO UNO DEI KIT PLASTICHE DISPONIBILI NELLA TABELLA A SINISTRA



PIANO REGOLABILE

ART.	Dim. utili mm	H totale mm	kg
M 33 PR25 00 00 01 __	657x631	60	150

INSERIBILE DAVANTI ALL'ASTA VERTEBRATA

RICAMBI - FISSAGGIO

SERRATURA DI RICAMBIO

ART. M 00 CSR0 8800 00 00

Serratura di ricambio con due chiavi



CHIAVE DI RICAMBIO

ART. M 00 CF00 0000 00 00

Specificare sempre il numero indicato nella serratura a cilindro dove si vuole sostituire la chiave



PASSEPARTOUT

ART. M 00 PF.. 0000 00 00

Disponibile in 23 serie, con numerazione da F 01 a F 23.

Passepartout serie F 01
Passepartout serie F 02
Passepartout serie F ..

ART. M 00 PF01 00 00 00 00
ART. M 00 PF02 00 00 00 00
ART. M 00 PF.. 00 00 00 00

SET FISSAGGIO TRA ARMADI

ART. M 00 FISO 00 00 00 99

Set di fissaggio armadio-armadio con 4 viti complete di dadi M8

ART. M 00 SVRO 00 00 00 99

Foratura e viteria per il fissaggio dei due armadi sovrapposti

SET DI FISSAGGIO A PAVIMENTO



ART. F AG 9200 00 99

Coppia staffe zincate per il fissaggio a pavimento dell'armadio

ART. F AG 9204 00 99

2 tasselli "HILTI" adatti per pavimenti in calcestruzzo non fessurato maggiore o uguale alla classe: C20/25
Trazione consigliata del tassello: 2,9 kN
Diametro tassello: Ø 6 mm



MANIGLIA DI RICAMBIO

ART. M 00 PLS0 0000 22 M0

Maniglia di ricambio per porte disponibile in colore Dark Grey.



ALTRI COLORI A RICHIESTA



GLI ARMADI DEVONO ESSERE FISSATI A PAVIMENTO O A PARETE
SE SOVRAPPosti DEVONO ESSERE FISSATI OBBLIGATORIAMENTE A PARETE E LA LORO PORTATA DIVISA PER DUE



PIANO SUPERIORE A 3 BORDI

ART.	dim. mm	
M 33 T023 AG 00 31 07	714x726x23 H	

Piano rivestito in pvc per ARMADIO SINGOLO. Colore nero

PIANO SUPERIORE A 3 BORDI

ART.	dim. mm	
M 33 T023 AG 00 32 07	1428x726x23 H	

Piano rivestito in pvc per ARMADIO DOPPIO. Colore nero



PIANO SUPERIORE A 4 BORDI

ART.	dim. mm	
M 33 T023 AG 00 41 07	714x726x23 H	

Piano rivestito in pvc per armadio singolo. Colore nero



ART. M 00 T023 AG 00 FO 00
FORATURA PIANO SUPERIORE DELL'ARMADIO
PER IL FISSAGGIO DEL PIANO A 4 BORDI



PIANO SUPERIORE IN MDF DIM. 714x726x32 mm H

ART.	rifiniture	per armadio	
M 33 T030 MD GM 21 07	1 profilo laterale	finale dx o sx	

Piano in MDF con copertura in gomma antiolio. Colore nero

PIANO SUPERIORE IN MDF DIM. 714x726x32 mm H

ART.	rifiniture	per armadio	
M 33 T030 MD GM 11 07	-	centrale	

Piano in MDF con copertura in gomma antiolio. Colore nero

PIANO SUPERIORE IN MDF DIM. 714x726x32 mm H

ART.	rifiniture	per armadio	
M 33 T030 MD GM 01 07	2 profili laterali	singolo	

Piano in MDF con copertura in gomma antiolio. Colore nero

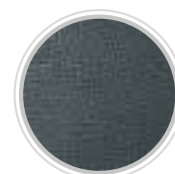

RIFINITURA
GOMMA
ANTIOLIO



APPLICAZIONE
PIANO IN MDF



ART. M 00 T030 MD 00 FO 00
FORATURA PIANO SUPERIORE DELL'ARMADIO
PER IL FISSAGGIO DEL PIANO IN MDF
COMPRESIVO DI VITI



ZOCCOLO DI RIALZO ALTEZZA 50 mm

ART.		dim. mm	
M 33 Z050 00 00 00		712x725x50 H	



ZOCCOLO DI RIALZO ALTEZZA 100 mm

ART.		dim. mm	
M 33 Z100 00 00 00		712x725x100 H	



ZOCCOLI PER CARRELLO ELEVATORE - Colore nero RAL 9005

ART.		dim. mm	
M 03 Z060 20 00 00 07		coppia zoccoli 200x722x60 H	
M 30 Z060 21 00 00 07		chiusura per coppia zoccoli 708x46x55 H	



ZOCCOLO PER TRANSPALLET - Colore nero RAL 9005

ART.		dim. mm	
M 33 Z100 10 00 00 07		zoccolo 712x722x100 H	
M 30 Z100 11 00 00 07		chiusura per zoccolo 708x46x95 H	



36x36 EH

MATERIALE DI SEPARAZIONE

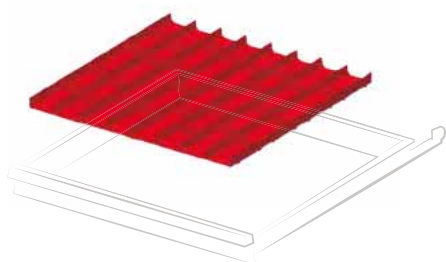

ART. per altezza frontale mm
F FH 2005 15 00 50 - 300

Set composto da: 16 divisori 2 canali, 35 divisori trasversali 73 mm

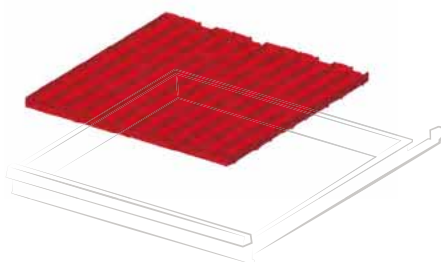

ART. per altezza frontale mm
F FH 2005 16 00 50 - 300

Set composto da: 16 divisori 3 canali, 50 divisori trasversali 47 mm

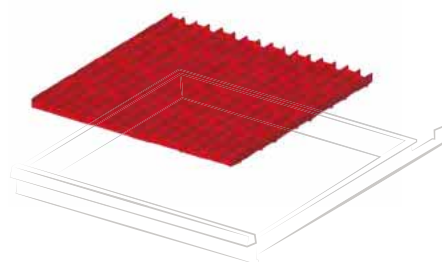

ART. per altezza frontale mm
F FH 2005 17 00 50 - 300

Set composto da: 16 divisori 4 canali, 65 divisori trasversali 36 mm

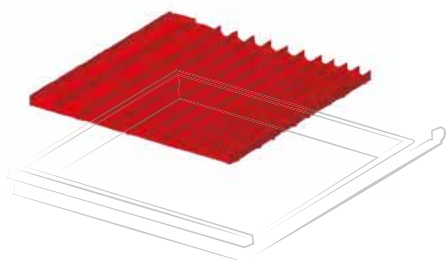

ART. per altezza frontale mm
F FH 2005 20 00 50 - 300

Set composto da: 4 divisori 4 canali, 8 divisori 3 canali, 4 divisori 2 canali, 30 divisori trasversali 36 mm, 20 divisori trasversali 47 mm, 10 divisori trasversali 73 mm

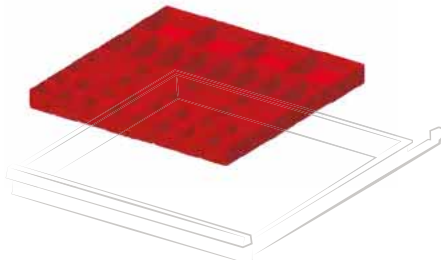

ART. per altezza frontale mm
F FH 2005 12 00 50
F FH 2007 12 00 75

Set composto da: 16 cassette divisorio 75x75 mm, 16 cassette divisorio 150x75 mm, 4 cassette divisorio 150x150 mm

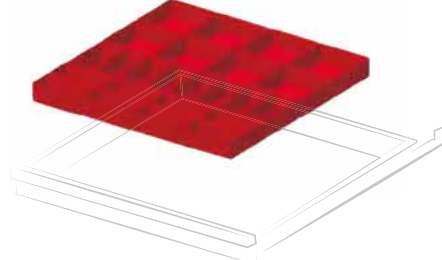

ART. per altezza frontale mm
F FH 2005 13 00 50
F FH 2007 13 00 75
F FH 2010 13 00 100 - 125

Set composto da: 16 cassette divisorio 150x75 mm, 8 cassette divisorio 150x150 mm

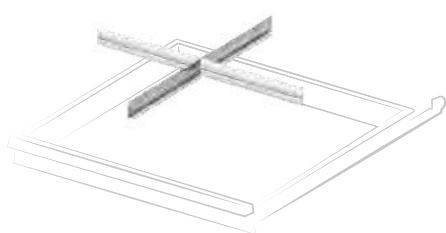

ART. per altezza frontale mm
F FH 2005 05 00 50
F FH 2007 05 00 75
F FH 2010 05 00 100 - 125
F FH 2015 05 00 150
F FH 2020 05 00 200 - 250
F FH 2030 05 00 300

Set composto da: 1 divisorio longitudinale fessurato 610 mm, 2 divisori trasversali 302 mm

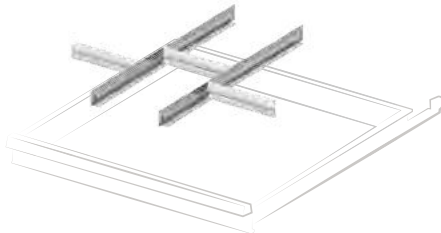

ART. per altezza frontale mm
F FH 2005 06 00 50
F FH 2007 06 00 75
F FH 2010 06 00 100 - 125
F FH 2015 06 00 150
F FH 2020 06 00 200 - 250
F FH 2030 06 00 300

Set composto da: 2 divisori longitudinali fessurati 610 mm, 3 divisori trasversali 200 mm

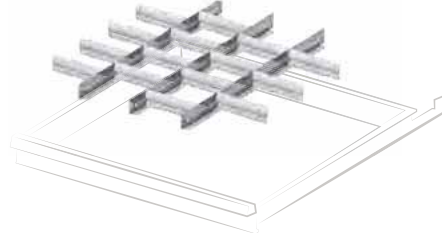

ART. per altezza frontale mm
F FH 2005 07 00 50
F FH 2007 07 00 75
F FH 2010 07 00 100 - 125
F FH 2015 07 00 150
F FH 2020 07 00 200 - 250

Set composto da: 3 divisori longitudinali fessurati 610 mm, 15 divisori trasversali 149 mm

CONFIGURA IL CASSETTO FAMI CON UTENSILI BETA

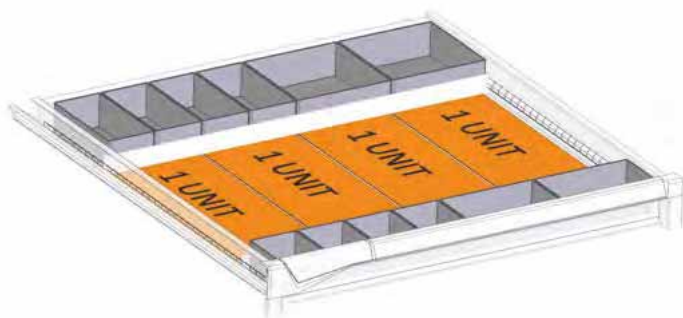

ART. F FH 2007 50 07

Set di predisposizione cassetto per termoformati Beta composto da:

- n. 4 F HC 6071 00 07
- n. 6 F HC 6471 00 07
- n. 2 F HC 6871 00 07
- n. 1 F HA 1140 00 99
- n. 1 F HA 2140 00 99

1 unit = 1 termoformato Beta 367x147 mm

2 unit = 1 termoformato Beta 367x294 mm



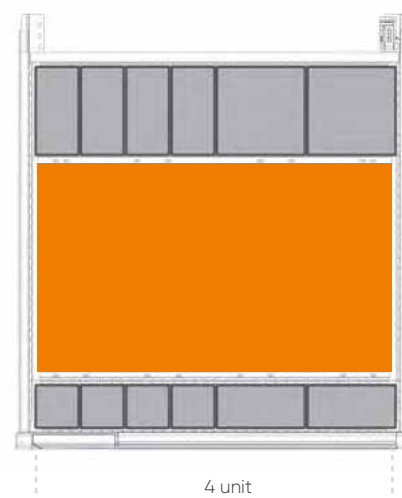
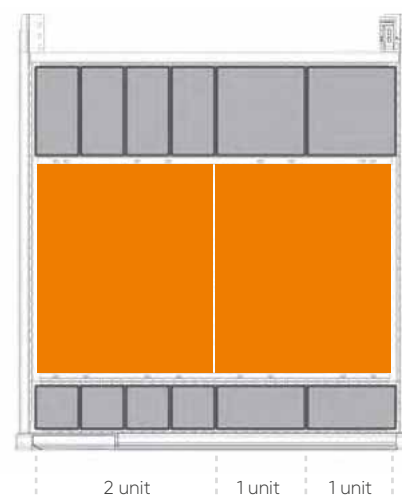
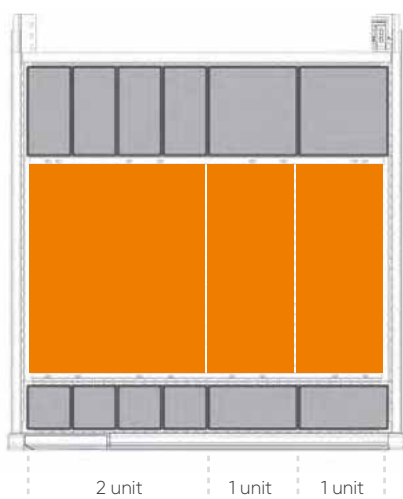
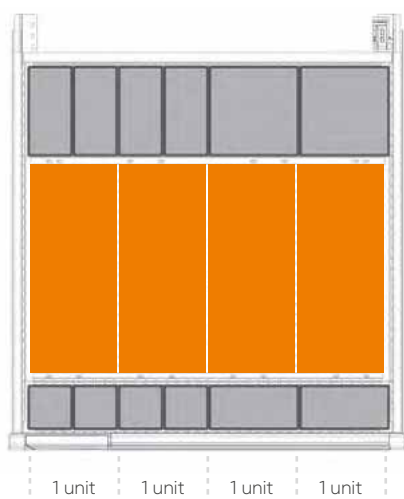

4 unit = 1 termoformato Beta 367x588 mm

ESEMPI DI UTILIZZO TERMOFORMATO



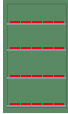
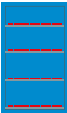

Gamma colori ACCIAIO

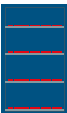
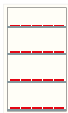
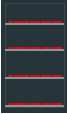
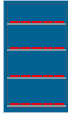
	
GRIGIO RAL 7000 .01	VERDE RAL 6011 .02
	
BLU RAL 5012 .04	GRIGIO RAL 7035 .08
	
BIANCO GRIGIASTRO RAL 9002 .1F	ROSSO RUBINO RAL 3003 .1G
	
BLU GENZIANA RAL 5010 .34	BIANCO PURO RAL 9010 .35
	
GRIGIO ANTRACITE RAL 7016 .39	BLU CAPRI RAL 5019 .48



ART. M 53 A150 C5 10 SA NR









ARMADIO completo di:
 3 cassetti ad estrazione telescopica (200 kg)
 3 telai porta boccole per cassetti
 Dim. mm 1020x726x1500 H
 Escluso utensili e boccole
 COLORE ACCIAIO BIANCO GRIGIASTRO RAL 9002 +
 BLU GENZIANA RAL 5010
 COLORE PLASTICHE DARK GREY

ART. M 53 A200 C0 10 SD PV

ARMADIO CON PORTE A BATTENTE completo di:
 1 piano regolabile in altezza
 3 cassetti ad estrazione telescopica (200 kg)
 3 telai porta boccole per cassetti
 Dim. mm 1020x751x2000 H
 Escluso utensili, boccole e valigette
 COLORE ACCIAIO GRIGIO ANTRACITE RAL 7016 +
 BIANCO PURO RAL 9010
 COLORE PLASTICHE DARK GREY

PORTATA ARMADIO 3100 kg

Gamma colori PLASTICHE

			
DARK GREY .M0	MEDITERRANEAN BLUE .M1	SKY BLUE .M2	GLAMOUR RED .M3
			
RED CARPET .M4	JUICY ORANGE .M5	SUNNY YELLOW .M6	FOREST GREEN .M7

LEGENDA



PORTATA CASSETTO/
PIANO



ESTRAZIONE CASSETTO/
PIANO



CHIUSURA ARMADIO



LE PORTATE SONO NETTE E SI RIFERISCONO A PESI UNIFORMEMENTE DISTRIBUITI.

H 1000 mm

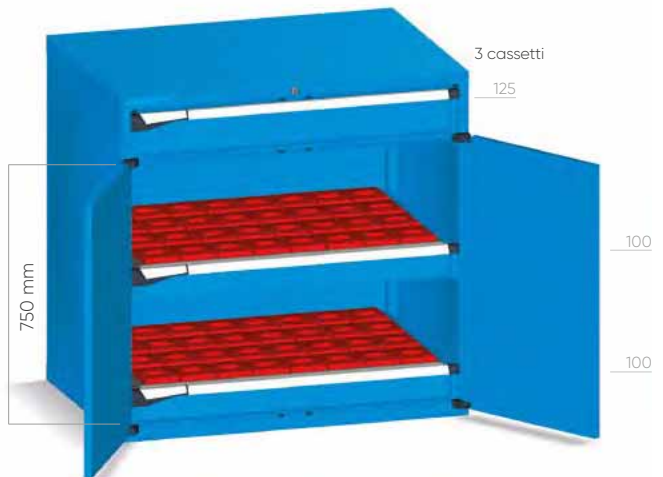

porta 775 mm H

ART.		kg		
M53A100C010RW04		200	100%	key
M53A100T210RW04		200	100%	code

Con 2 telai* - Escluse boccole

H 1000 mm



porta 900 mm H

ART.		kg		
M53A100C010RX04		200	100%	key
M53A100P510RX04		200	100%	code

Con 2 telai* - Escluse boccole

*I TELAI HANNO INCLUSA LA COPPIA SUPPORTI ART. F NC 5650 00 01



H 1000 mm

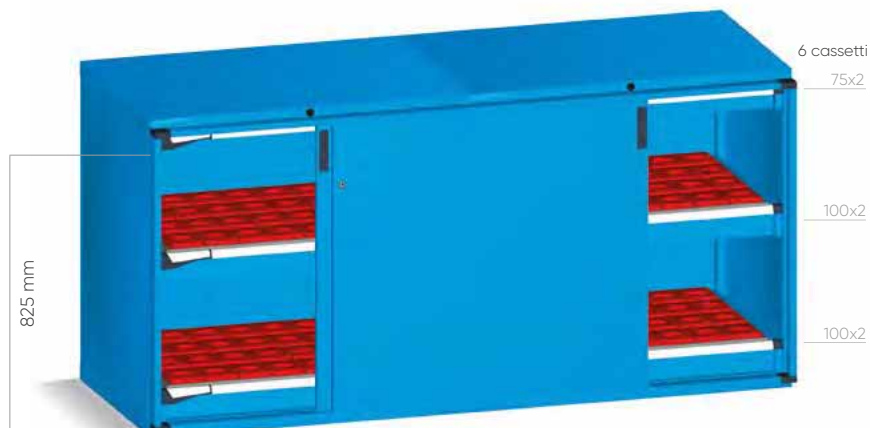

porta doppia

ART.			
M53D100 C0 10 RY 04	200	100%	key

Con 4 telai* - Escluse boccole

H 1000 mm



porta singola

profondità 751 mm

ART.			
M53D100 C0 10 RZ 04	200	100%	key

Con 2 telai* - Escluse boccole

*I TELAI HANNO INCLUSA LA COPPIA SUPPORTI ART. F NC 5650 00 01

H 1500 mm



H 1500 mm



ART.				
M 53 A150 C5 10 SA 04		200	100%	-

Con 3 telai* - Escluse boccole

porta 1400 mm profondità 751 mm

ART.				
M 53 A150 C0 10 SB 04		200	100%	key
M 53 A150 P5 10 SB 04		200	100%	code

Con 3 telai* - Escluse boccole

H 2000 mm



H 2000 mm



ART.				
M 53 A200 C5 10 SC 04		200	100%	-

Con 3 telai* - Escluse boccole

porta 1900 mm profondità 751 mm

ART.				
M 53 A200 C0 10 SD 04		200	100%	key
M 53 A200 P5 10 SD 04		200	100%	code

Con 3 telai* - Escluse boccole

H 2000 mm

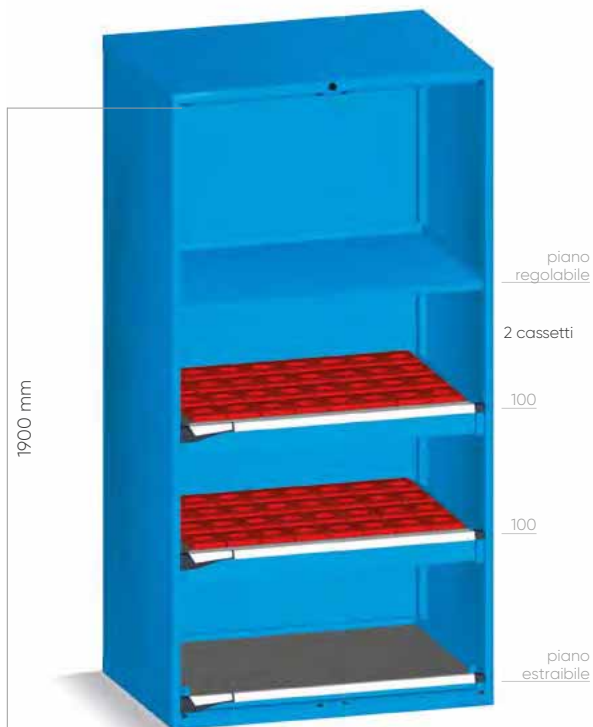

H 2000 mm



ART.		kg		
M 53 A200 C5 10 SE 04		200	100%	-

Con 2 telai* - Escluse boccole

ART.		kg		
M 53 A200 C0 10 SF 04		200	100%	key
M 53 A200 P5 10 SF 04		200	100%	code

Con 2 telai* - Escluse boccole

*I TELAI HANNO INCLUSA LA COPPIA SUPPORTI ART. F NC 5650 00 01



H 2250 mm

H 2250 mm



armadio con tapparella

armadio con tapparella

ART.				
M53A200C010SG04		200	100%	key

Con 3 telai* - Escluse boccole

ART.				
M53A200C010SH04		200	100%	key

Con 2 telai* - Escluse boccole



H 2000 mm



porta doppia

ART.				
M53D200C010SJ04		200	100%	key

Con 4 telai* - Escluse boccole



H 2000 mm



porta doppia

ART.



kg



M53D200C010SK04

200

100%

key

Con 6 telai* - Escluse boccole

*I TELAI HANNO INCLUSA LA COPPIA SUPPORTI ART. F NC 5650 00 01

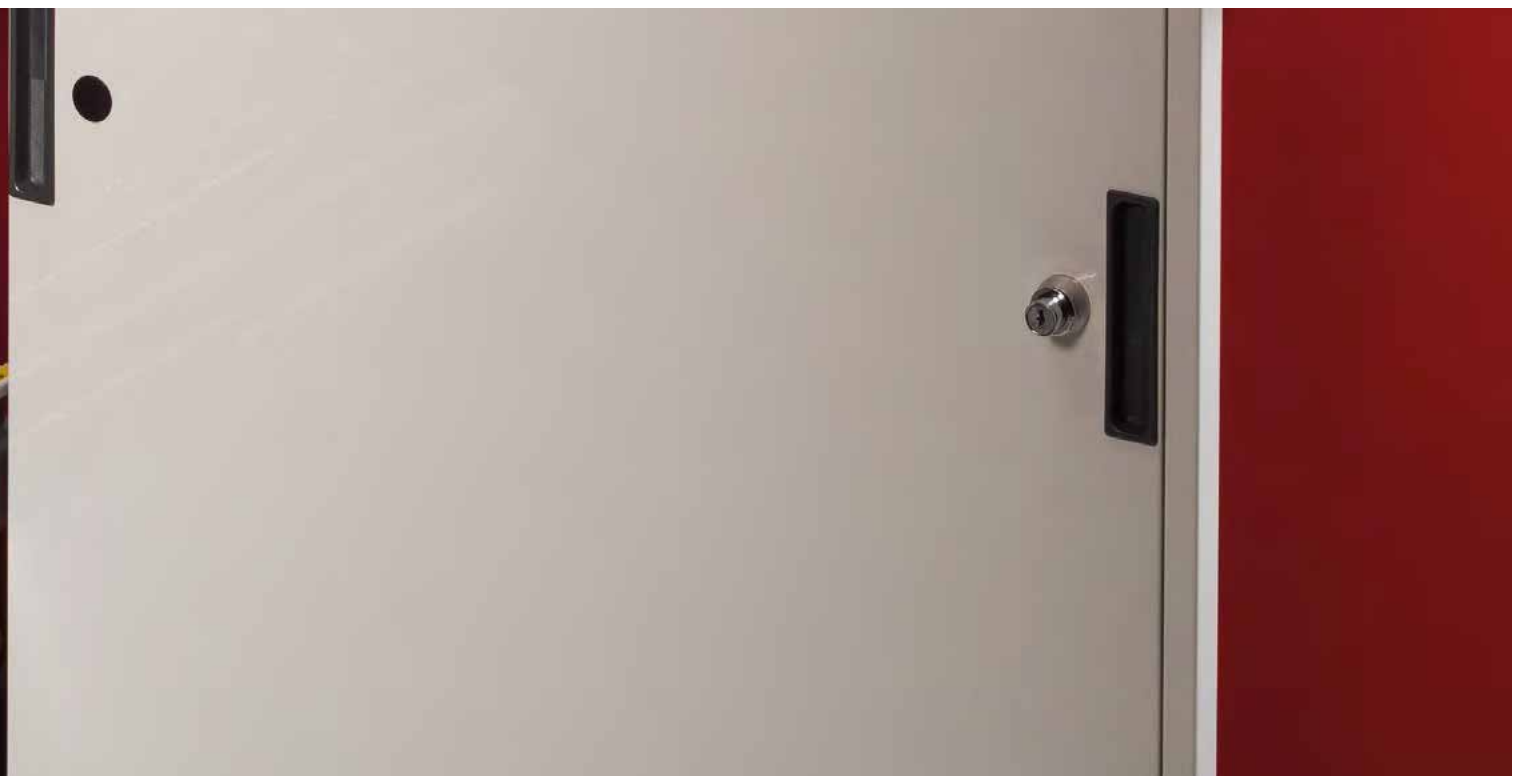





CONFIGURA IL TUO ARMADIO

H 1000 mm



armadio con 2 porte scorrevoli

Dim. mm 2040x776

ART.				
M53D100C010QN04	-	-	-	key





Armadio vuoto con 2 aste vertebrate

H 1000 mm



armadio con 1 porta scorrevole

Dim. mm 2040x751

ART.				
M53D100C010QP04	-	-	-	key

Armadio vuoto con 2 aste vertebrate, serratura a sinistra

H 1000 mm



porta 775 mm H

Dim. mm 1020x751

ART.				
M 53 A100 C0 10 SL 04		200	100%	key
M 53 A100 T2 10 SL 04		200	100%	code

Armadio vuoto con asta vertebrata

H 1000 mm



porta 900 mm H

Dim. mm 1020x751

ART.				
M53A100C010QM04		-	-	key
M53A100P510QM04		-	-	code

Armadio vuoto con asta vertebrata

H 1500 mm



Dim. mm 1020x726

ART.				
M 53 A150 C5 10 00 04		-	-	-

Armadio vuoto con asta vertebrata

H 1500 mm



porta 1400 mm H

Dim. mm 1020x751

ART.				
M53A150C010QM04		-	-	key
M53A150P510QM04		-	-	code

Armadio vuoto con asta vertebrata



IN PRESENZA DI 2 O PIÙ CASSETTI / PIANI ESTRAIBILI,
È OBBLIGATORIO L'USO DELL'ASTA VERTEBRATA

H 2000 mm



Dim. mm 1020x726

ART.				
M 53 A200 X0 10 00 04	-	-	-	-

Armadio vuoto

H 2000 mm



Dim. mm 1020x726

ART.				
M 53 A200 C5 10 00 04	-	-	-	-

Armadio vuoto con asta vertebata

H 2000 mm



Dim. mm 1020x751

ART.				
M 53 A200 C0 10 QQ 04	-	-	-	key
M 53 A200 P5 10 QQ 04	-	-	-	code

Armadio vuoto

H 2000 mm



Dim. mm 1020x751

ART.				
M 53 A200 C0 10 QM 04	-	-	-	key
M 53 A200 P5 10 QM 04	-	-	-	code

Armadio vuoto con asta vertebata

H 2250 mm



H 2250 mm



armadio con tapparella

Dim. mm 1020x765

ART.			
M53A200 C010 QR 04	-	-	key

Armadio vuoto

armadio con tapparella

Dim. mm 1020x765

ART.			
M53A200 C010 QS 04	-	-	key

Armadio vuoto con asta vertebrata



IN PRESENZA DI 2 O PIÙ CASSETTI / PIANI ESTRAIBILI,
È OBBLIGATORIO L'USO DELL'ASTA VERTEBRATA

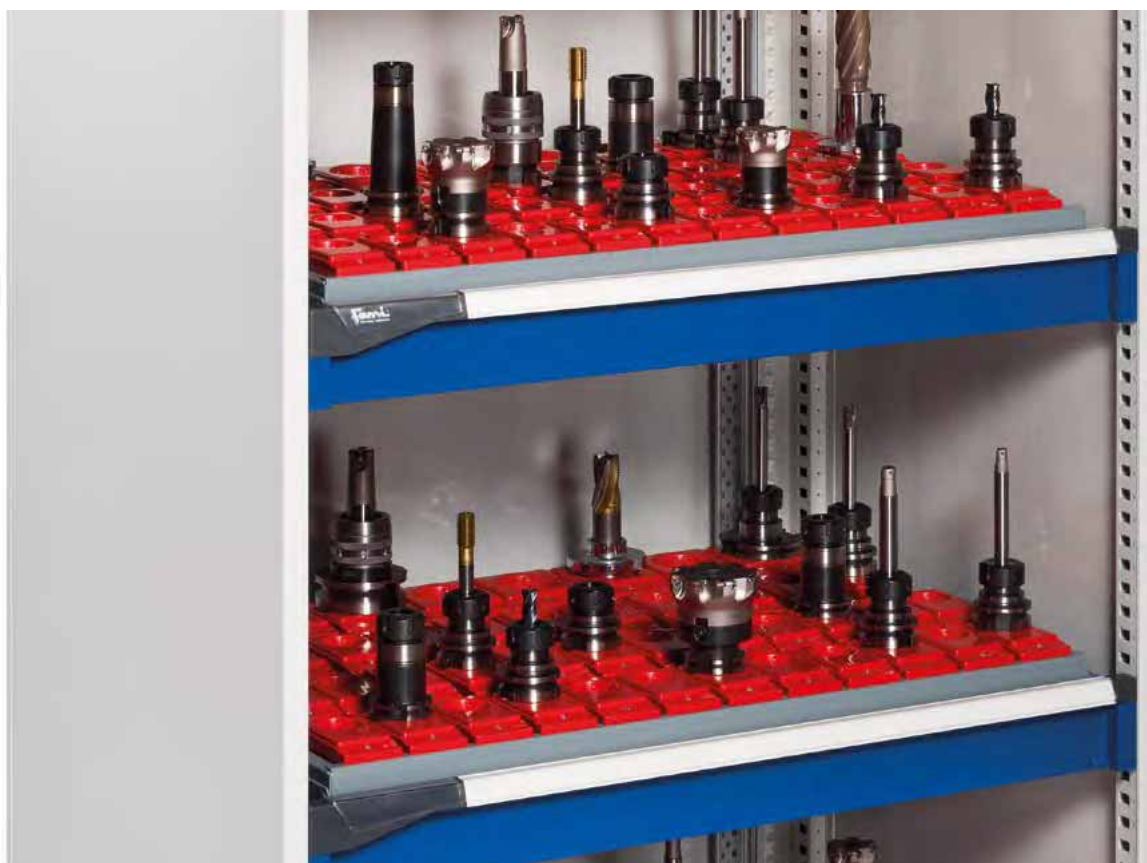





TELAIO PORTA BOCCOLE A 4 FILE PER CASSETTO

ART.	Dim. mm
F NC 5240 00 01	- 890x592x69 H

DISPONIBILE IN GRIGIO RAL 7000

COPPIA SUPPORTI

ART.	H max cono utensile mm	Dim. mm
F NC 5650 00 01	A = 93/118/143	594x86 H
F NC 5840 00 01	A = 143/168/193	594x136 H

DISPONIBILE IN GRIGIO RAL 7000



La portata del telaio è data dalla portata del cassetto

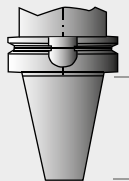

(rif. A)
Altezza cono dell'utensile

H max del cono dell'utensile mm (rif. A)	H telaio con cassetto mm (rif. B)
93	115
118	140
143	165
168	190
193	215



(rif. B)
Altezza del cassetto con telaio e boccole

Il passo della regolazione in altezza del cassetto è di 25 mm

ART.	TIPO BOCCOLA	QTÀ PER TELAIO F NC 5240
F NC 9510 00 03	ISO 30	52
F NC 9530 00 03	ISO 40	52
F NC 9540 00 03	ISO 45	40
F NC 9550 00 03	ISO 50	32
F NC 9560 00 03	VDI 30	52
F NC 9570 00 03	VDI 40	40
F NC 9580 00 03	VDI 50	40
F NC 9590 00 03	VDI 60	32
F NC 9720 00 03	CONO MORSE 2	52
F NC 9730 00 03	CONO MORSE 3	52
F NC 9740 00 03	CONO MORSE 4	52
F NC 9750 00 03	CONO MORSE 5	40
F NC 9270 00 03	CAPTO C3	52
F NC 9275 00 03	CAPTO C4	40
F NC 9280 00 03	CAPTO C5	40

ART.	TIPO BOCCOLA	QTÀ PER TELAIO F NC 5240
F NC 9285 00 03	CAPTO C6	40
F NC 9290 00 03	CAPTO C8	32
F NC 9210 00 03	HSK A32-B40	52
F NC 9220 00 03	HSK A40-B50	52
F NC 9230 00 03	HSK A50-B63	40
F NC 9240 00 03	HSK A63-B80	40
F NC 9250 00 03	HSK A80-B100	32
F NC 9260 00 03	HSK A100-B125	32
F NC 9640 00 03	2"	40
F NC 9650 00 03	2" 1/4	32
F NC 9010 00 03	58 mm	56
F NC 9020 00 03	65 mm	52
F NC 9030 00 03	75 mm	44
F NC 9040 00 03	87 mm	38
F NC 9050 00 03	105 mm	32



CASSETTI AD ESTRAZIONE FLESSIBILE

ART. CON kit plastiche Dark Grey	ART. SENZA kit plastiche*	Dim. utili mm	H frontale mm	kg	
M 53 C050 0110 OF __	M 53 C050 0100 OF __	906x600x31 H	50	50 - 75 - 100	100% - 96% - 92%
M 53 C075 0110 OF __	M 53 C075 0100 OF __	906x600x56 H	75	50 - 75 - 100	100% - 96% - 92%
M 53 C100 0110 OF __	M 53 C100 0100 OF __	906x600x81 H	100	50 - 75 - 100	100% - 96% - 92%
M 53 C125 0110 OF __	M 53 C125 0100 OF __	906x600x106 H	125	50 - 75 - 100	100% - 96% - 92%
M 53 C150 0110 OF __	M 53 C150 0100 OF __	906x600x131 H	150	50 - 75 - 100	100% - 96% - 92%
M 53 C200 0110 OF __	M 53 C200 0100 OF __	906x600x181 H	200	50 - 75 - 100	100% - 96% - 92%
M 53 C250 0110 OF __	M 53 C250 0100 OF __	906x600x231 H	250	50 - 75 - 100	100% - 96% - 92%
M 53 C300 0110 OF __	M 53 C300 0100 OF __	906x600x281 H	300	50 - 75 - 100	100% - 96% - 92%

* ABBINARE AL CODICE ARTICOLO UNO DEI KIT PLASTICHE DISPONIBILI NELLA TABELLA SOTTOSTANTE



CASSETTI AD ESTRAZIONE TELESCOPICA

ART. CON kit plastiche Dark Grey	ART. SENZA kit plastiche*	Dim. utili mm	H frontale mm	kg	
M 53 C075 0110 OT __	M 53 C075 0100 OT __	906x600x56 H	75	200	100%
M 53 C100 0110 OT __	M 53 C100 0100 OT __	906x600x81 H	100	200	100%
M 53 C125 0110 OT __	M 53 C125 0100 OT __	906x600x106 H	125	200	100%
M 53 C150 0110 OT __	M 53 C150 0100 OT __	906x600x131 H	150	200	100%
M 53 C200 0110 OT __	M 53 C200 0100 OT __	906x600x181 H	200	200	100%
M 53 C250 0110 OT __	M 53 C250 0100 OT __	906x600x231 H	250	200	100%
M 53 C300 0110 OT __	M 53 C300 0100 OT __	906x600x281 H	300	200	100%

* ABBINARE AL CODICE ARTICOLO UNO DEI KIT PLASTICHE DISPONIBILI NELLA TABELLA SOTTOSTANTE

KIT PLASTICHE PER CASSETTI E PIANI ESTRAIBILI



GAMMA COLORI PLASTICHE	ART.
MEDITERRANEAN BLUE	M 50 PLS1 00 00 00 M1
SKY BLUE	M 50 PLS1 00 00 00 M2
GLAMOUR RED	M 50 PLS1 00 00 00 M3
RED CARPET	M 50 PLS1 00 00 00 M4
JUICY ORANGE	M 50 PLS1 00 00 00 M5
SUNNY YELLOW	M 50 PLS1 00 00 00 M6
FOREST GREEN	M 50 PLS1 00 00 00 M7



PIANO ESTRAIBILE AD ESTRAZIONE FLESSIBILE

ART. CON kit plastiche Dark Grey	ART. SENZA kit plastiche*	Dim. utili mm	H laterale mm	kg	
M 53 C057 0110 0F __	M 53 C057 01 00 0F __	906x600	70	50 - 75 - 100	100% - 96% - 92%

* ABBINARE AL CODICE ARTICOLO UNO DEI KIT PLASTICHE DISPONIBILI NELLA TABELLA A SINISTRA



PIANO ESTRAIBILE AD ESTRAZIONE TELESCOPICA

ART. CON kit plastiche Dark Grey	ART. SENZA kit plastiche*	Dim. utili mm	H laterale mm	kg	
M 53 C057 0110 0T __	M 53 C057 01 00 0T __	906x600	70	200	100%

* ABBINARE AL CODICE ARTICOLO UNO DEI KIT PLASTICHE DISPONIBILI NELLA TABELLA A SINISTRA



PIANO REGOLABILE

ART.	Dim. utili mm	H totale mm	kg
M 53 PR25 00 00 01 __	963x631	60	100

INSERIBILE DAVANTI ALL'ASTA VERTEBRATA

RICAMBI - FISSAGGIO

SERRATURA DI RICAMBIO

ART. M 00 CSR0 8800 00 00

Serratura di ricambio con due chiavi



CHIAVE DI RICAMBIO

ART. M 00 CF00 0000 00 00

Specificare sempre il numero indicato nella serratura a cilindro dove si vuole sostituire la chiave



PASSEPARTOUT

ART. M 00 PF.. 0000 00 00

Disponibile in 23 serie, con numerazione da F 01 a F 23.

Passepartout serie F 01
Passepartout serie F 02
Passepartout serie F ..

ART. M 00 PF01 00 00 00 00
ART. M 00 PF02 00 00 00 00
ART. M 00 PF.. 00 00 00 00

SET FISSAGGIO TRA ARMADI

ART. M 00 FISO 00 00 00 99

Set di fissaggio armadio-armadio con 4 viti complete di dadi M8

ART. M 00 SVRO 00 00 00 99

Foratura e viteria per il fissaggio dei due armadi sovrapposti

SET DI FISSAGGIO A PAVIMENTO



ART. F AG 9200 00 99

Coppia staffe zincate per il fissaggio a pavimento dell'armadio

ART. F AG 9204 00 99

2 tasselli "HILTI" adatti per pavimenti in calcestruzzo non fessurato maggiore o uguale alla classe: C20/25
Trazione consigliata del tassello: 2.9 kN
Diametro tassello: Ø 6 mm



MANIGLIA DI RICAMBIO

ART. M 00 PLS0 0000 22 M0

Maniglia di ricambio per porte disponibile in colore Dark Grey.



ALTRI COLORI A RICHIESTA



GLI ARMADI DEVONO ESSERE FISSATI A PAVIMENTO O A PARETE
SE SOVRAPPosti DEVONO ESSERE FISSATI OBBLIGATORIAMENTE A PARETE E LA LORO PORTATA DIVISA PER DUE



PIANO SUPERIORE A 3 BORDI

ART.	dim. mm	
M 53 T023 AG 00 31 07	1020x726x23 H	

Piano rivestito in pvc per ARMADIO SINGOLO. Colore nero



PIANO SUPERIORE A 4 BORDI

ART.	dim. mm	
M 53 T023 AG 00 41 07	1020x726x23 H	

Piano rivestito in pvc per ARMADIO SINGOLO. Colore nero



ART. M 00 T023 AG 00 F0 00

FORATURA PIANO SUPERIORE DELL'ARMADIO PER IL FISSAGGIO DEL PIANO A 4 BORDI



PIANO SUPERIORE IN MDF DIM. 1020x726x32 mm H

ART.	rifiniture	per armadio	
M 53 T030 MD GM 21 07	1 profilo laterale	finale dx o sx	

Piano in MDF con copertura in gomma antiolio. Colore nero



PIANO SUPERIORE IN MDF DIM. 1020x726x32 mm H

ART.	rifiniture	per armadio	
M 53 T030 MD GM 11 07	-	centrale	

Piano in MDF con copertura in gomma antiolio. Colore nero



PIANO SUPERIORE IN MDF DIM. 1020x726x32 mm H

ART.	rifiniture	per armadio	
M 53 T030 MD GM 01 07	2 profili laterali	singolo	

Piano in MDF con copertura in gomma antiolio. Colore nero

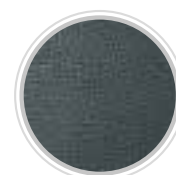

RIFINITURA
GOMMA
ANTIOLIO



APPLICAZIONE
PIANO IN MDF



ART. M 00 T030 MD 00 F0 00

FORATURA PIANO SUPERIORE DELL'ARMADIO PER IL FISSAGGIO DEL PIANO IN MDF COMPENSIVO DI VITI PER IL FISSAGGIO



ZOCCOLO DI RIALZO ALTEZZA 50 mm

ART.		dim. mm	
M 53 Z050 00 00 00		1018x725x50 H	



ZOCCOLO DI RIALZO ALTEZZA 100 mm

ART.		dim. mm	
M 53 Z100 00 00 00		1018x725x100 H	

ZOCCOLI PER CARRELLO ELEVATORE - Colore nero RAL 9005



ART.		dim. mm	
M 03 Z060 20 00 00 07		coppia zoccoli 200x722x60 H	
M 50 Z060 21 00 00 07		chiusura per coppia zoccoli 1014x46x55 H	



ART.		dim. mm	
M 03 Z100 20 00 00 07		coppia zoccoli 200x722x100 H	
M 50 Z100 21 00 00 07		chiusura per coppia zoccoli 1014x46x95 H	



54x36 EH

MATERIALE DI SEPARAZIONE

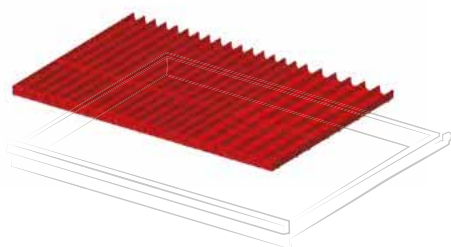

ART. per altezza frontale mm

F FH 5005 19 00 50 - 300

Set composto da: 16 divisori 4 canali, 8 divisori 3 canali, 30 divisori trasversali 36 mm, 10 divisori trasversali 47 mm

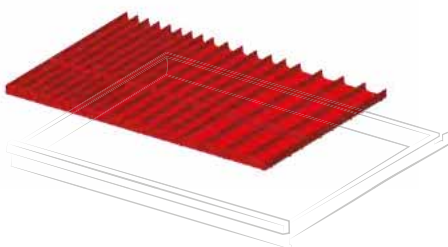

ART. per altezza frontale mm

F FH 5005 09 00 50 - 300

Set composto da: 8 divisori 4 canali, 8 divisori 3 canali, 8 divisori 2 canali, 15 divisori trasversali 36 mm, 10 divisori trasversali 47 mm, 6 divisori trasversali 73 mm

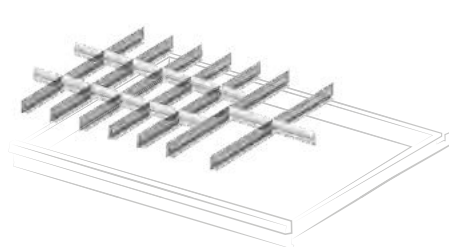

ART. per altezza frontale mm

F FH 5005 15 00 50

F FH 5007 15 00 75

F FH 5010 15 00 100 - 125

Set composto da: 7 divisori longitudinali fessurati 610 mm, 12 divisori trasversali 98 mm, 2 divisori trasversali 149 mm

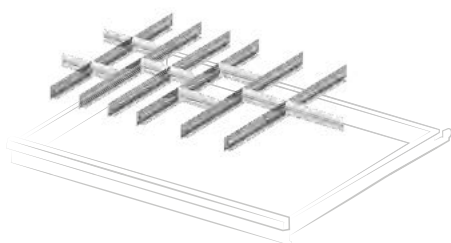

ART. per altezza frontale mm

F FH 5005 14 00 50

F FH 5007 14 00 75

F FH 5010 14 00 100 - 125

Set composto da: 6 divisori longitudinali fessurati 610 mm, 6 divisori trasversali 98 mm, 3 divisori trasversali 149 mm, 1 divisorio trasversale 200 mm

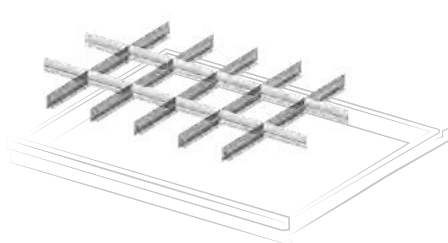

ART. per altezza frontale mm

F FH 5005 13 00 50

F FH 5007 13 00 75

F FH 5010 13 00 100 - 125

F FH 5015 13 00 150

F FH 5020 13 00 200 - 250

F FH 5030 13 00 300

Set composto da: 5 divisori longitudinali fessurati 610 mm, 12 divisori trasversali 149 mm

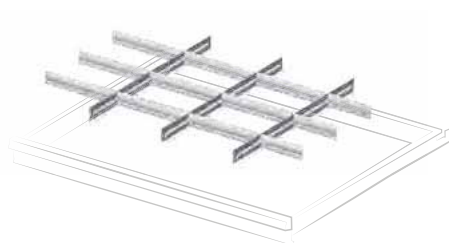

ART. per altezza frontale mm

F FH 5005 01 00 50

F FH 5007 01 00 75

F FH 5010 01 00 100 - 125

F FH 5015 01 00 150

F FH 5020 01 00 200 - 250

F FH 5030 01 00 300

Set composto da: 3 divisori longitudinali fessurati 610 mm, 3 divisori trasversali 149 mm, 9 divisori trasversali 251 mm

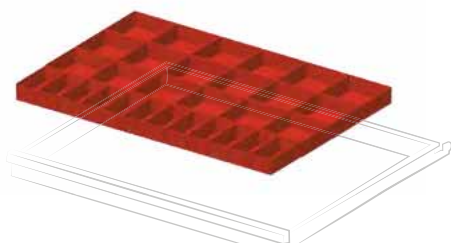

ART. per altezza frontale mm

F FH 5005 08 00 50

F FH 5007 08 00 75

F FH 5010 08 00 100 - 125

Set composto da: 12 cassette divisorio 150x75 mm, 18 cassette divisorio 150x150 mm

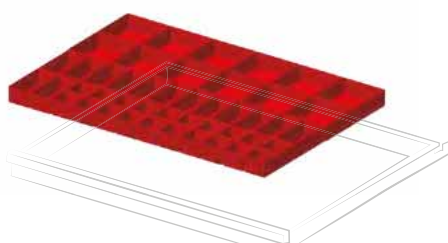

ART. per altezza frontale mm

F FH 5005 17 00 50

F FH 5007 17 00 75

Set composto da: 20 cassette divisorio 75x75 mm, 14 cassette divisorio 150x75 mm, 12 cassette divisorio 150x150 mm

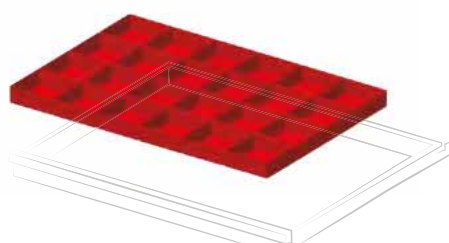

ART. per altezza frontale mm

F FH 5005 18 00 50

F FH 5007 18 00 75

F FH 5010 18 00 100 - 125

Set composto da: 24 cassette divisorio 150x150 mm

CONFIGURA IL CASSETTO FAMI CON UTENSILI BETA

ART. F FH 5007 50 07

Set di predisposizione cassetto per termoformati Beta composto da:

n. 4 F HC 6071 00 07

n. 8 F HC 6471 00 07

n. 4 F HC 6871 00 07

n. 1 F HA 1150 00 99

n. 1 F HA 2150 00 99



1 unit = 1 termoformato Beta 367x147 mm

2 unit = 1 termoformato Beta 367x294 mm

4 unit = 1 termoformato Beta 367x588 mm



ESEMPI DI UTILIZZO TERMOFORMATO

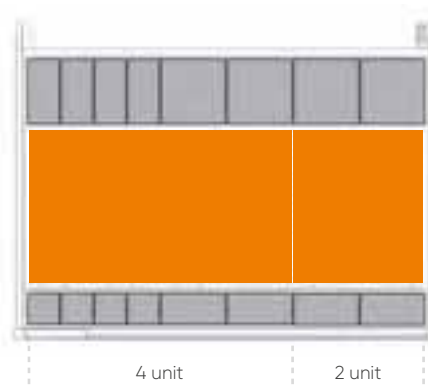
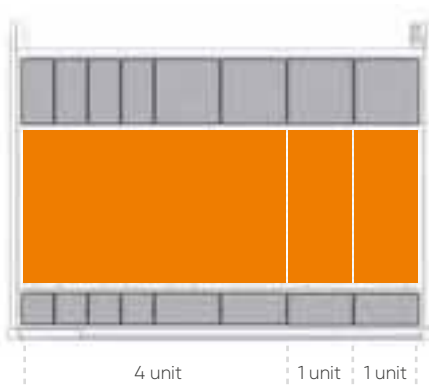
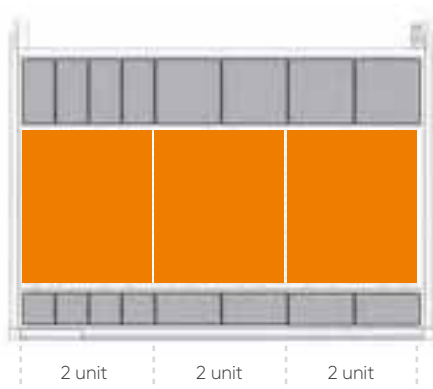
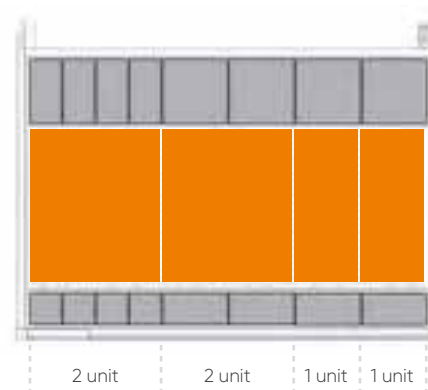
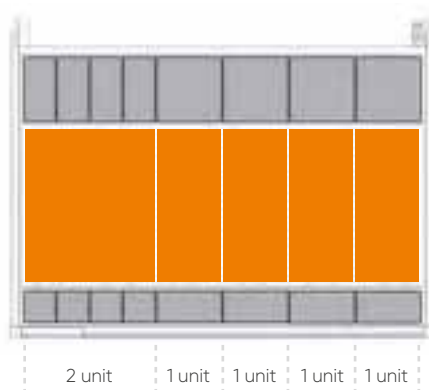
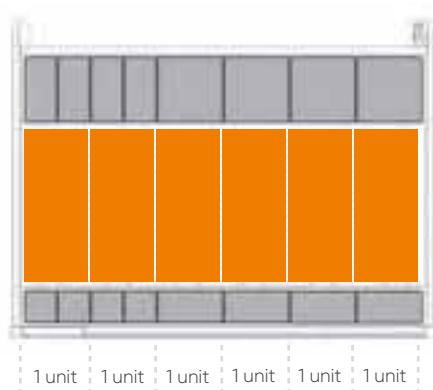

**PIANO REGOLABILE
IN ALTEZZA
DISTANZE RIDOTTE
MAGGIOR CAMPO VISIVO**





DYNAMIC



Il design dinamico ed ergonomico delle postazioni di lavoro Dynamic si presta a svariati ambienti di lavoro, principalmente nel settore metalmeccanico, elettronico, di assemblaggio e di laboratorio. La natura fortemente modulare permette la progettazione di soluzioni che nascono e crescono al passo con il mutare delle esigenze dell'operatore. Ogni soluzione, per dimensioni e composizione, è il risultato della fusione tra la massima oggettiva funzionalità operativa e un aspetto dinamico e moderno. Numerosi i dettagli che puntano al comfort dell'utilizzatore: il tavolo regolabile in altezza ottimizza la libertà di movimento, potenziando le prestazioni e la produttività. Ampio ventaglio di accessori integrabili.

ERGONOMICO



LE PORTATE NELLE SEZIONI SONO NETTE E SI RIFERISCONO A PESI UNIFORMEMENTE DISTRIBUITI

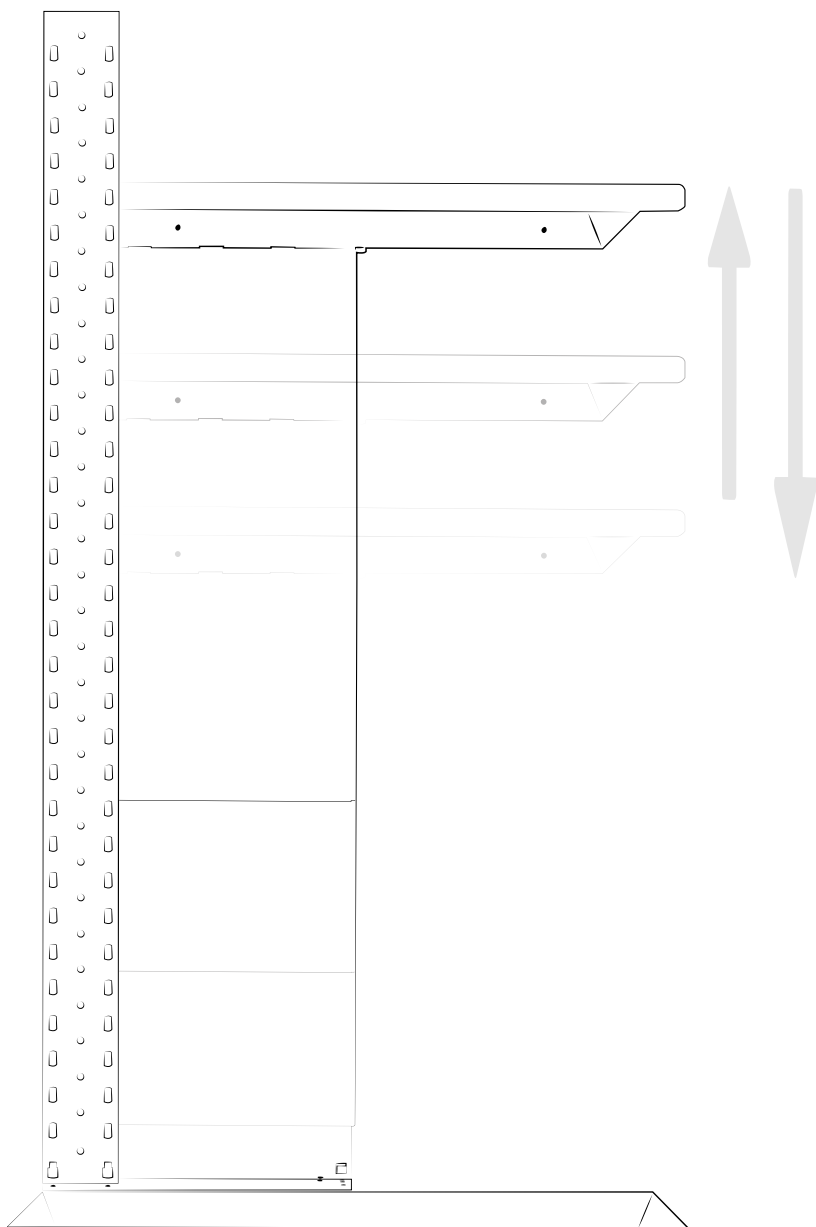

METALMECCANICA

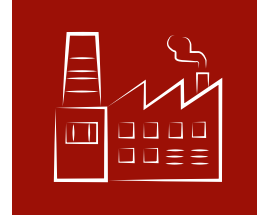

ASSEMBLAGGIO

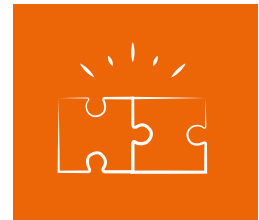

CONTROLLO QUALITA'



LABORATORIO

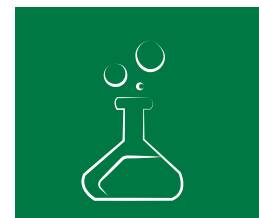

Il piano regolabile in altezza è ideale in ambienti di lavoro dinamici quali l'assemblaggio, la riparazione, la ricerca e il controllo qualità.

REGOLABILE IN ALTEZZA

La configurazione delle postazioni di lavoro Dynamic, soprattutto se accessoriate con carrelli serie Smart, agevola la visibilità e la presa dei materiali e delle attrezzature riposti nelle cassette in plastica e sulle mensole.

TUTTO FACILMENTE VISIBILE



Ogni postazione è totalmente personalizzabile con l'aggiunta di una vasta gamma di accessori e con la nuova colorata linea di mensole e pannelli, disponibile in 10 tinte.

PERSONALIZZABILE

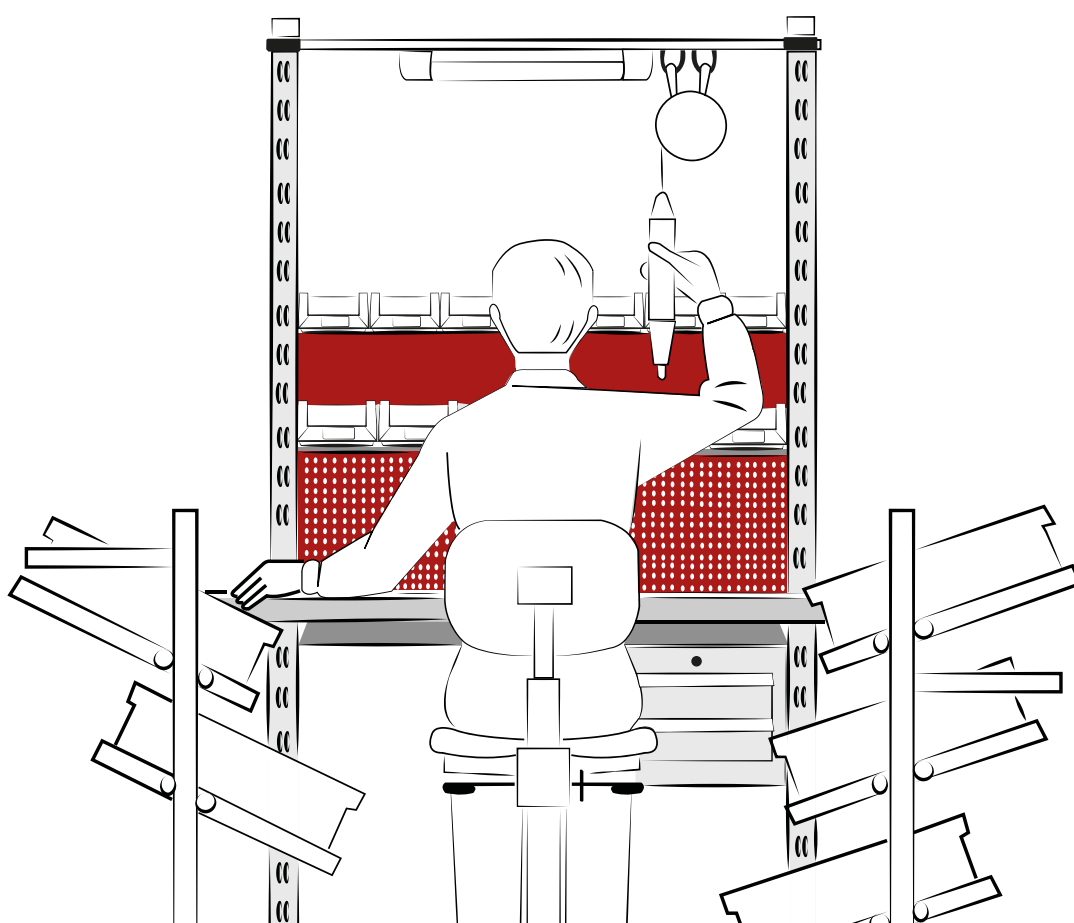

GRIGIO
RAL 7000
.01



VERDE
RAL 6011
.02



BLU
RAL 5012
.04



GRIGIO
RAL 7035
.08



BIANCO GRIGIASTRO
RAL 9002
.1F



ROSSO RUBINO
RAL 3003
.1G



BLU GENZIANA
RAL 5010
.34



BIANCO PURO
RAL 9010
.35



GRIGIO ANTRACITE
RAL 7016
.39



BLU CAPRI
RAL 5019
.48



BANCO SERIE DYNAMIC dim. mm 2052x820x2220 H

composto da:

- 1 telaio monofronte base ART. F LE K213 00 55
- 1 telaio monofronte aggiuntivo ART. F LE L213 00 55
- 1 piano di lavoro con telaio regolabile da 720 a 1138 mm ART. F LE 1970 A1 55
- 1 armadio STEEL ART. F BG 3030 01 08
- 1 coppia supporti per armadio ART. F BL 4600 00 08
- 1 coperchio per armadio ART. F BL 6690 00 08
- 1 foratura laterale per armadio ART. F BL 9043 00 00
- 3 pannelli forati ART. F BL 7620 00 1G

- 1 mensola fissa zincata da 150 mm ART. F BL 7846 00 99
- 9 contenitori grigi PICKING BOX **mis. 1** ART. FAXPBC001A05101
- 1 mensola fissa zincata da 205 mm ART. F BL 7847 00 99
- 6 contenitori grigi PICKING BOX **mis. 2** ART. FAXPBC002A05101
- 2 mensole inclinabili da 320 mm ART. F BL 7755 00 1G
- 4 contenitori grigi PICKING BOX **mis. 3A2** ART. FAXPBC3A2B05101
- 1 braccio doppio snodo con vassoio inclinato ART. F BL 7456 00 08
- 1 binario base con supporto ART. F BL 9810 01 55
- 1 binario aggiuntivo con supporto ART. F BL 9810 03 55
- 1 lampada Philips LED 1504 mm ART. F BL 9915 00 00

ESEMPI DI COMPOSIZIONE



55
ZINCATO+RAL 7035

BANCO SERIE DYNAMIC dim. mm 1067x820x2197 H
composto da:

- 1 telaio monofronte base ART. F LE K213 00 55
- 1 piano di lavoro con telaio regolabile da 720 a 1138 mm ART. F LE 0970 A1 55
- 1 pannello forato ART. F BL 7620 00 08
- 1 mensola inclinabile da 320 mm ART. FBL 7755 00 08
- 4 contenitori blu PICKING BOX **mis. 3A2** ART. FAXPBC3A2B05104



55
ZINCATO+RAL 7035

BANCO SERIE DYNAMIC dim. mm 1067x820x2220 H
composto da:

- 1 telaio monofronte base ART. F LE K213 00 55
- 1 piano di lavoro con telaio regolabile da 720 a 1138 mm ART. F LE 0970 A1 55
- 1 pannello forato ART. F BL 7620 00 08
- 1 mensola inclinabile da 320 mm ART. F BL 7755 00 08
- 4 contenitori blu PICKING BOX **mis. 3A2** ART. FAXPBC3A2B05104
- 1 canaletta vuota ART. F BL 9110 01 08 composta da:
- 1 coppia supporti ART. F BL 9460 00 99
- 5 prese Schuko cablate ART. F BL 9395 57 00
- 1 magnetotermico 220V cablato ART. F BL 9394 51 00
- 1 coperchio ART. F BL 9384 00 08
- 1 binario base con supporti ART. F BL 9810 01 55
- 1 lampada Philips LED 661 mm ART. F BL 9905 00 00



55
ZINCATO+RAL 7035

BANCO SERIE DYNAMIC dim. mm 1552x820x2220 H
composto da:

- 1 telaio monofronte base ART. F LE K215 00 55
- 1 piano di lavoro con telaio regolabile da 720 a 1138 mm ART. F LE 1470 A1 55
- 1 pannello forato ART. F BL 7635 00 08
- 1 mensola inclinabile da 220 mm ART. F BL 7795 00 08
- 9 contenitori grigi PICKING BOX **mis. 2** ART. FAXPBC002A05101
- 1 mensola inclinabile da 320 mm ART. F BL 7800 00 08
- 8 contenitori blu RK BOX ART. FAXRB3016005104
- 1 binario base con supporti ART. F BL 9815 01 55



55
ZINCATO+RAL 7035

BANCO SERIE DYNAMIC dim. mm 1552x820x2220 H
composto da:

- 1 telaio monofronte base ART. F LE K215 00 55
- 1 piano di lavoro con telaio regolabile da 720 a 1138 mm ART. F LE 1470 A1 55
- 1 armadio STEEL ART. F BG 3010 01 08
- 1 coppia supporti per armadio ART. F BL 4600 00 08
- 1 coperchio per armadio ART. F BL 6690 00 08
- 1 foratura laterale per armadio ART. F BL 9043 00 00
- 1 pannello forato ART. F BL 7635 00 08
- 1 mensola inclinabile da 220 mm ART. F BL 7795 00 08
- 9 contenitori blu PICKING BOX **mis. 2** ART. FAXPBC002A05104
- 1 mensola inclinabile da 320 mm ART. F BL 7800 00 08
- 1 canaletta cablata ART. F BL 9260 45 08 composta da :
 - 4 prese Schuko, 5 prese italiane bivalenti, 1 magnetotermico 220V
- 1 coppia supporti ART. F BL 9450 00 99
- 1 binario base con supporti ART. F BL 9815 01 55
- 1 lampada Philips LED 1223 mm ART. F BL 9910 00 00



55
ZINCATO+RAL 7035

BANCO SERIE DYNAMIC dim. mm 1552x820x2197 H
composto da:

- 1 telaio monofronte base ART. F LE K215 00 55
- 1 piano di lavoro con telaio regolabile da 720 a 1138 mm ART. F LE 1470 A1 55
- 1 armadio STEEL ART. F BG 3010 01 08
 - 1 coppia supporti per armadio ART. F BL 4600 00 08
 - 1 coperchio per armadio ART. F BL 6690 00 08
 - 1 foratura laterale per armadio ART. F BL 9043 00 00
- 1 pannello forato ART. F BL 7635 00 08
- 1 mensola inclinabile da 220 mm ART. F BL 7795 00 08
 - 9 contenitori blu PICKING BOX **mis. 2** ART. FAXPBC002A05104
- 1 mensola inclinabile da 320 mm ART. F BL 7800 00 08
 - 6 contenitori grigi PICKING BOX **mis. 3A2** ART. FAXPBC3A2B05101



55
ZINCATO+RAL 7035

BANCO SERIE DYNAMIC dim. mm 1552x820x2220 H
composto da:

- 1 telaio monofronte base ART. F LE K215 00 55
- 1 piano di lavoro con telaio regolabile da 720 a 1138 mm ART. F LE 1470 A1 55
- 1 armadio STEEL ART. F BG 3030 01 08
 - 1 coppia supporti per armadio ART. F BL 4600 00 08
 - 1 coperchio per armadio ART. F BL 6690 00 08
 - 1 foratura laterale per armadio ART. F BL 9043 00 00
- 1 pannello forato ART. F BL 7635 00 08
- 1 mensola inclinabile da 220 mm ART. F BL 7795 00 08
 - 9 contenitori blu PICKING BOX **mis. 2** ART. FAXPBC002A05104
- 1 canaletta vuota ART. F BL 9115 01 08 composta da:
 - 1 coppia supporti ART. F BL 9460 00 99
 - 5 prese Schuko cablate ART. F BL 9395 57 00
 - 4 prese industriali 220V 2P+T cablate ART. F BL 9395 55 00
 - 1 magnetotermico 220V cablato ART. F BL 9394 51 00
 - 2 coperchio ART. F BL 9384 00 08
- 1 binario base con supporti ART. F BL 9815 01 55
- 1 lampada Philips LED 1223 mm ART. F BL 9910 00 00



55
ZINCATO+RAL 7035

BANCO SERIE DYNAMIC dim. mm 2052x820x2220 H
composto da:

- 1 telaio monofronte base ART. F LE K213 00 55
- 1 telaio monofronte aggiuntivo ART. F LE L213 00 55
- 1 piano di lavoro con telaio regolabile da 720 a 1138 mm ART. F LE 1970 A1 55
- 1 armadio STEEL ART. F BG 3010 01 08
 - 1 coppia supporti per armadio ART. F BL 4600 00 08
 - 1 coperchio per armadio ART. F BL 6690 00 08
 - 1 foratura laterale per armadio ART. F BL 9043 00 00
- 2 pannelli forati ART. F BL 7620 00 08
- 2 mensole fisse zincate da 150 mm ART. F BL 7846 00 99
 - 18 contenitori blu PICKING BOX **mis. 1** ART. FAXPBC001A05104
- 1 mensola inclinabile da 220 mm ART. F BL 7750 00 08
- 2 mensole inclinabili da 220 mm ART. F BL 7750 00 08
 - 12 contenitori blu PICKING BOX **mis. 2** ART. FAXPBC002A05104
- 1 braccio doppio snodo con vassoio inclinato ART. F BL 7456 00 08
- 1 binario base con supporti ART. F BL 9810 01 55
- 1 binario aggiuntivo con supporti ART. F BL 9810 03 55
- 1 lampada Philips LED 1504 mm ART. F BL 9915 00 00



55
ZINCATO+RAL 7035

BANCO SERIE DYNAMIC dim. mm 2052x820x2220 H
composto da:

- 1 telaio monofronte base ART. F LE K213 00 55
- 1 telaio monofronte aggiuntivo ART. F LE L213 00 55
- 1 piano di lavoro con telaio regolabile da 720 a 1138 mm ART. F LE 1970 A1 55
- 1 armadio STEEL ART. F BG 3030 01 08
 - 1 coppia supporti per armadio ART. F BL 4600 00 08
 - 1 coperchio per armadio ART. F BL 6690 00 08
 - 1 foratura laterale per armadio ART. F BL 9043 00 00
- 2 pannelli forati ART. F BL 7620 00 08
- 2 mensole fisse zincate da 205 mm ART. F BL 7847 00 99
 - 12 contenitori grigi PICKING BOX **mis. 2** ART. FAXPBC002A05101
- 1 mensola inclinabile da 220 mm ART. F BL 7750 00 08
 - 6 contenitori blu PICKING BOX **mis. 2** ART. FAXPBC002A05104
- 1 mensola inclinabile da 320 mm ART. F BL 7755 00 08
 - 4 contenitori blu PICKING BOX **mis. 3A2** ART. FAXPBC3A2B05104
- 1 canaletta cablata ART. F BL 9310 45 08 composta da :
 - 4 prese Schuko, 5 prese italiane bivalenti, 1 magnetotermico 220V
 - 1 coppia supporti ART. F BL 9450 00 99
- 1 binario base con supporti ART. F BL 9810 01 55
- 1 binario aggiuntivo con supporti ART. F BL 9810 03 55
- 1 lampada Philips LED 1504 mm ART. F BL 9915 00 00

CONFIGURA IL TUO SCAFFALE

MONOFRONTE

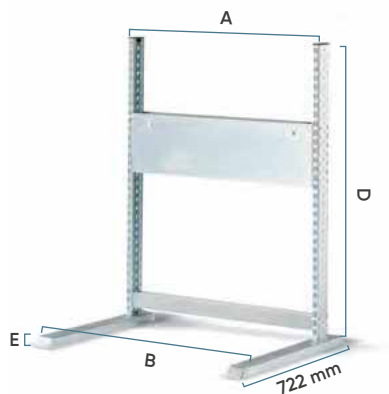

TELAIO MONOFRONTE BASE

ART.	A mm	B mm	D mm	E mm
F LE D123 00 55	985	1067	1240	40
F LE D125 00 55	1470	1552	1240	40

Portata di un montante 150 kg (75 kg PER LATO)

55
ZINCATO+RAL 7035



TELAIO MONOFRONTE AGGIUNTIVO

ART.	A mm	B mm	D mm	E mm
F LE E123 00 55	985	-	1240	40
F LE E125 00 55	1470	-	1240	40

Portata di un montante 150 kg (75 kg PER LATO)

55
ZINCATO+RAL 7035

BIFRONTE

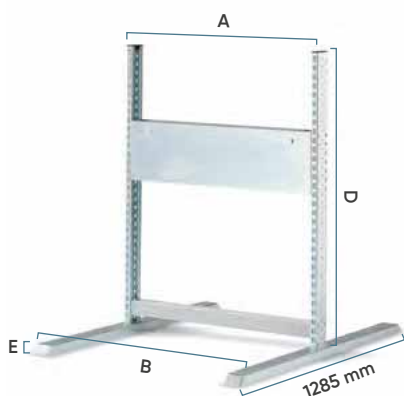

TELAIO BIFRONTE BASE

ART.	A mm	B mm	D mm	E mm
F LE A123 00 55	985	1067	1240	40
F LE A125 00 55	1470	1552	1240	40

Portata di un montante 150 kg (75 kg PER LATO)

55
ZINCATO+RAL 7035



TELAIO BIFRONTE AGGIUNTIVO

ART.	A mm	B mm	D mm	E mm
F LE B123 00 55	985	-	1240	40
F LE B125 00 55	1470	-	1240	40

Portata di un montante 150 kg (75 kg PER LATO)

55
ZINCATO+RAL 7035

MONOFRONTE

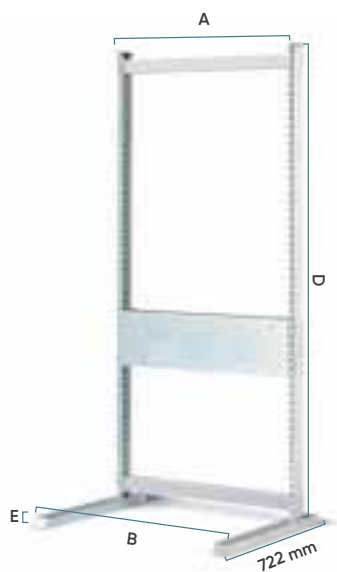

TELAIO MONOFRONTE BASE

ART.	A mm	B mm	D mm	E mm
F LE K173 00 55	985	1067	1772	40
F LE K175 00 55	1470	1552	1772	40
F LE K213 00 55	985	1067	2152	40
F LE K215 00 55	1470	1552	2152	40

Portata di un montante 150 kg (75 kg PER LATO)

55
ZINCATO+RAL 7035



TELAIO MONOFRONTE AGGIUNTIVO

ART.	A mm	B mm	D mm	E mm
F LE L173 00 55	985	-	1772	40
F LE L175 00 55	1470	-	1772	40
F LE L213 00 55	985	-	2152	40
F LE L215 00 55	1470	-	2152	40

Portata di un montante 150 kg (75 kg PER LATO)

55
ZINCATO+RAL 7035

BIFRONTE



TELAIO BIFRONTE BASE

ART.	A mm	B mm	D mm	E mm
F LE G173 00 55	985	1067	1772	40
F LE G175 00 55	1470	1552	1772	40
F LE G213 00 55	985	1067	2152	40
F LE G215 00 55	1470	1552	2152	40

Portata di un montante 150 kg (75 kg PER LATO)

55
ZINCATO+RAL 7035



TELAIO BIFRONTE AGGIUNTIVO

ART.	A mm	B mm	D mm	E mm
F LE H173 00 55	985	-	1772	40
F LE H175 00 55	1470	-	1772	40
F LE H213 00 55	985	-	2152	40
F LE H215 00 55	1470	-	2152	40

Portata di un montante 150 kg (75 kg PER LATO)

55
ZINCATO+RAL 7035

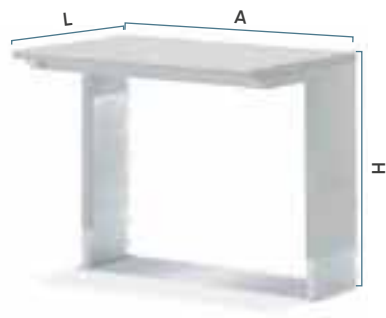

PIANO DI LAVORO CON TELAIO REGOLABILE DA 720 A 1138 mm

ART.	A mm	H mm	L mm	
F LE 0970 A1 55	985	723/1141	700	
F LE 1470 A1 55	1470	723/1141	700	

Regolazione in altezza passo 38 mm.

Portata 200 kg.

 55
ZINCATO+RAL 7035

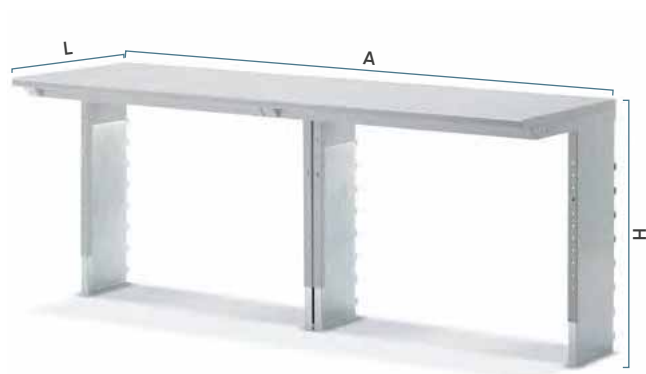

PIANO DI LAVORO CON TELAIO REGOLABILE DA 720 A 1138 mm

ART.	A mm	H mm	L mm	
F LE 1970 A1 55	1970	723/1141	700	

Regolazione in altezza passo 38 mm.

Portata 300 kg.

 55
ZINCATO+RAL 7035



CHIUSURA PER VANO PORTA CAVI

ART.	lunghezza mm	
F BL 4610 00 99	954	
F BL 4615 00 99	1439	



TELAIO BASE AD ANGOLO CON PIANO



Il telaio base ad angolo disponibile in 3 altezze da 1240, 1772 e 2152 mm, unito a 2 telai base monofronti, permette di creare postazioni di lavoro a 90°.

BANCO SERIE DYNAMIC AD ANGOLO

DIM. mm 3130x2630

ALTEZZA 1285/2220 mm

composto da:

- 1 telaio monofronte base ART. F LE K213 00 55
- 1 telaio monofronte aggiuntivo ART. F LE L213 00 55
- 1 piano di lavoro con telaio regolabile da 720 a 1138 mm ART. F LE 1970 A1 55
- 3 pannelli forati ART. F BL 7620 00 08
- 1 mensola inclinabile da 320 mm ART. F BL 7755 00 08
- 4 contenitori PICKING BOX **mis. 3A2** in ESD ART. FAXPBC3A2B05207
- 2 mensole inclinabili da 220 mm ART. F BL 7750 00 08
- 12 contenitori PICKING BOX **mis. 2** ESD ART. FAXPBC002A05207
- 1 binario base con supporti ART. F BL 9810 01 55
- 1 binario aggiuntivo con supporti ART. F BL 9810 03 55
- 1 lampada Philips LED 1504 mm ART. F BL 9915 00 00

-1 telaio base ad angolo con piano ART. **F LE 0970 G1 55**

-2 pannelli forati ART. F BL 7620 00 08

-1 mensola inclinabile da 220 mm ART. F BL 7750 00 08

4 contenitori PICKING BOX **mis. 3A2** in ESD ART. FAXPBC3A2B05207

-1 telaio monofronte base ART. F LE D125 00 55

-1 piano di lavoro con telaio regolabile da 720 a 1138 mm ART. F LE 1470 A1 55

-1 pannello forato ART. F BL 7635 00 08

-1 mensola inclinabile da 320 mm ART. F BL 7800 00 08

4 contenitori PICKING BOX **mis. 3A2** in ESD ART. FAXPBC3A2B05207

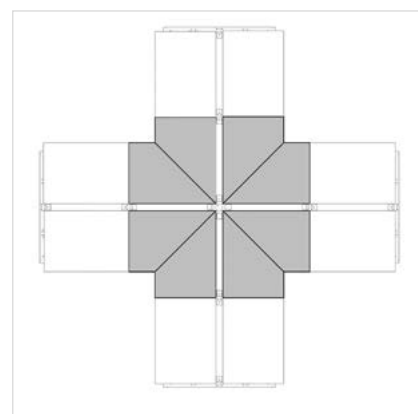
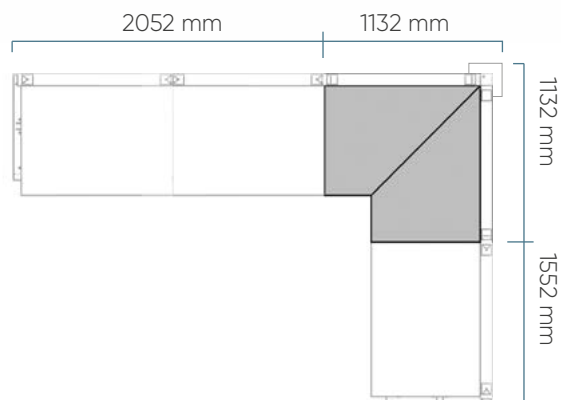

Con l'aggiunta di ulteriori montanti e traversi di collegamento è possibile creare isole di lavoro a croce



TELAI BASE



ART.

F LE 0970 G1 55

55

ZINCATO+RAL 7035

TELAIO BASE AD ANGOLO CON PIANO
D= 1240 E= 40 mm

Dimensioni ingombro : 1132x1132 mm
Dimensioni piano in laminato : 998x998 mm
Portata piano 50 kg
Telaio regolabile in altezza da 720 a 1138 mm



ART.

F LE 0970 G2 55

55

ZINCATO+RAL 7035

TELAIO BASE AD ANGOLO CON PIANO
D= 1772 E= 40 mm

Dimensioni ingombro : 1132x1132 mm
Dimensioni piano in laminato : 998x998 mm
Portata piano 50 kg
Telaio regolabile in altezza da 720 a 1138 mm

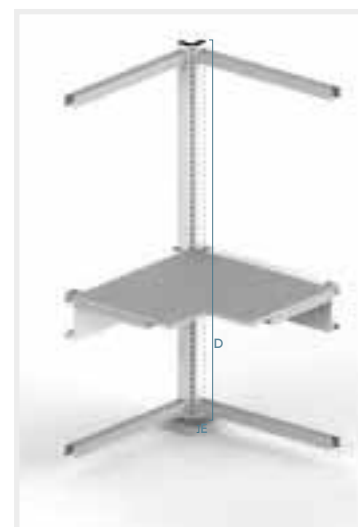

ART.

F LE 0970 G3 55

55

ZINCATO+RAL 7035

TELAIO BASE AD ANGOLO CON PIANO
D= 2152 E= 40 mm

Dimensioni ingombro : 1132x1132 mm
Dimensioni piano in laminato : 998x998 mm
Portata piano 50 kg
Telaio regolabile in altezza da 720 a 1138 mm

DYNAMIC



COPPIA SUPPORTI ARMADIO

ART.

F BL 4600 00 08

08
RAL 7035

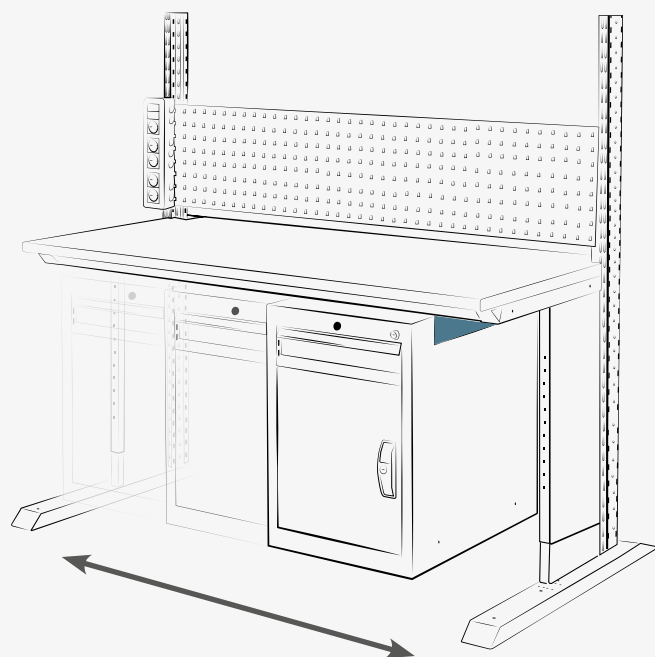

LA COPPIA DI SUPPORTI PERMETTE DI MONTARE L'ARMADIO NELLA POSIZIONE PIU' UTILE SENZA FORARE IL PIANO O LA STRUTTURA .



STEEL



ART.	dim. mm	kg
F BG 3030 01 08	500x607x570 H	25

DA ORDINARE CON ART. **F BL 6690 00 08**

08
RAL 7035



ART.	dim. mm	kg
F BG 3010 01 08	500x607x210 H	25

DA ORDINARE CON ART. **F BL 6690 00 08**

08
RAL 7035



ART. F BL 9043 00 00
FORATURA LATERALE ARMADIO PER FISSAGGIO
ALLA COPPIA SUPPORTI



COPERCHIO PER ARMADIO

ART.	dim. mm
F BL 6690 00 08	496x601 H

08
RAL 7035



ART.	dim. mm	kg	
F DA 1050 53 08	428x600x600 H	70	100%

08
RAL 7035



ART.	dim. mm	kg	
F DA D550 03 08	428x600x790 H	70	100%

2 ruote fisse in gomma standard Ø 100 mm
2 ruote girevoli con freno in gomma standard Ø 100 mm
Portata armadio 170 kg
Serratura centrale

08
RAL 7035

FLEXA 19X27 EH

DYNAMIC

MASTER 18X27 EH

H 400 mm



ART.	kg		
M 12 A040 C0 10 02 08	50-75-100	100-96-92 %	key
M 12 A040 E2 10 02 08	50-75-100	100-96-92 %	code

Dimensioni mm: 408x573x400 H

08
RAL 7035

H 600 mm



ART.	kg		
M 12 A060 C0 10 20 08	50-75-100	100-96-92 %	key
M 12 A060 E2 10 20 08	50-75-100	100-96-92 %	code

Dimensioni mm: 408x573x600 H

08
RAL 7035

H 600 mm



porta 425 mm

profondità 598 mm

ART.	kg		
M 12 A060 C0 10 17 08	50-75-100	100-96-92 %	key
M 12 A060 T2 10 17 08	50-75-100	100-96-92 %	code

Dimensioni mm: 408x598x600 H

08
RAL 7035



ART. F BL 9043 00 00
FORATURA LATERALE ARMADIO PER FISSAGGIO
ALLA COPPIA SUPPORTI

ESCLUSO ARMADIO CON RUOTE

H 818 mm



ART.	kg		
M 12 R060 S0 10 20 08	50-75-100	100-96-92 %	key
M 12 R060 P2 10 20 08	50-75-100	100-96-92 %	code

Dimensioni mm: 434x647x818 H

2 ruote fisse in gomma standard Ø 125 mm

2 ruote girevoli con freno in gomma standard Ø 125 mm

Portata armadio 245 kg

Altezza armadio senza ruote mm 663

08
RAL 7035



BANCO SERIE DYNAMIC dim. mm 2052x820x2197 H

composto da:

- 1 telaio monofronte base ART. F LE K213 00 55
- 1 telaio monofronte aggiuntivo ART. F LE L213 00 55
- 1 piano di lavoro con telaio regolabile da 720 a 1138 mm ART. F LE 1970 A1 55
- 1 armadio STEEL ART. F BG 3010 01 08
- 1 coppia supporti per armadio ART. F BL 4600 00 08
- 1 coperchio per armadio ART. F BL 6690 00 08
- 1 foratura laterale per armadio ART. F BL 9043 00 00
- 3 pannelli forati ART. F BL 7620 00 39
- 2 mensole fisse zincate da 150 mm ART. F BL 7846 00 99
- 18 contenitori grigi PICKING BOX **mis. 1** ART. FAXPBC001A05101
- 2 mensole inclinabili da 220 mm ART. F BL 7750 00 39
- 6 contenitori blu PICKING BOX **mis. 2** ART. FAXPBC002A05104
- 1 mensola inclinabile da 320 mm ART. F BL 7755 00 39
- 4 contenitori grigi PICKING BOX **mis. 3A2** ART. FAXPBC3A2B05101

-1 armadio a cassetti Master con ruote composto da:

- 1 corpo armadio ART. M 12 R060 S0 10 00 08
- 2 ruote fisse in gomma standard Ø 125 mm ART. C RG BAC12 125
- 2 ruote girevoli con freno in gomma standard Ø 125 mm ART. C RG DAC12 125
- 1 cassetto H 50 mm ART. M 12 C050 01 00 0F 08
- 3 cassetti H 150 mm ART. M 12 C150 01 00 0F 08
- 4 kit plastiche mediterran blue ART. M 10 PLS1 00 00 00 M1

DYNAMIC

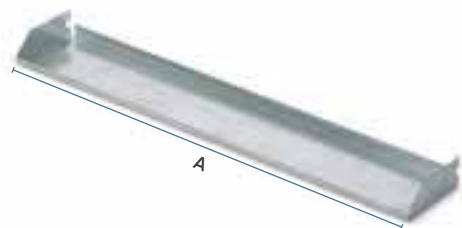

Mis. 1



MENSOLA FISSA LUNGHEZZA 974 mm

ART.	Profondità mm	dim. reali mm	kg
F BL 7846 00 99	150 (A = 985)	974x170x61 H	25

Capacità: 9 contenitori PICKING BOX/STORAGE BOX **mis. 1** - COLORE ZINCATO

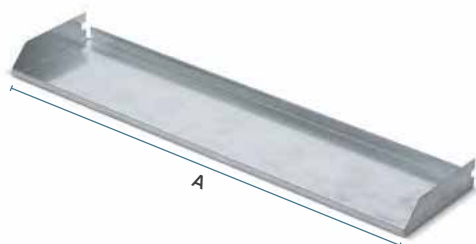

Mis. 2



MENSOLA FISSA LUNGHEZZA 974 mm

ART.	Profondità mm	dim. reali mm	kg
F BL 7847 00 99	205 (A = 985)	974x230x61 H	25

Capacità: 6 contenitori PICKING BOX/STORAGE BOX **mis. 2** - COLORE ZINCATO

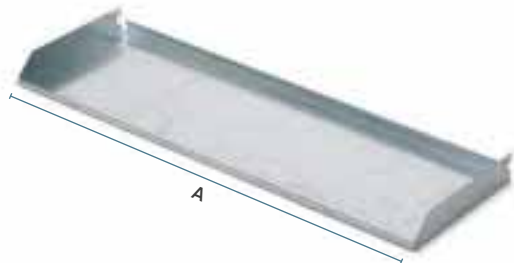

Mis. 3



Mis. 3A2



MENSOLA FISSA LUNGHEZZA 974 mm

ART.	Profondità mm	dim. reali mm	kg
F BL 7848 00 99	295 (A = 985)	974x315x61 H	25

Capacità: 4 contenitori PICKING BOX/STORAGE BOX **mis. 3A2/ mis. 3** - COLORE ZINCATO

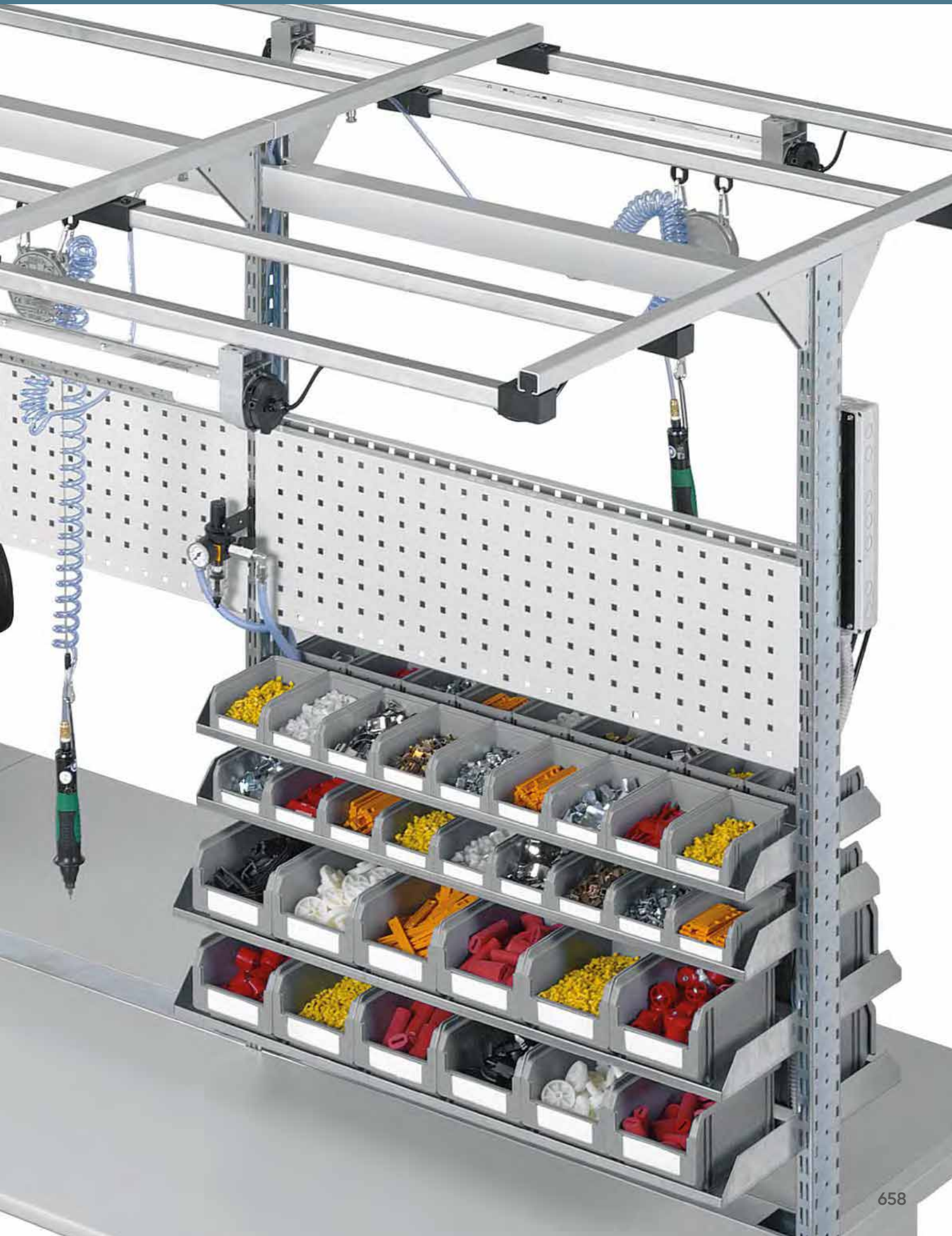

DYNAMIC



PANNELLO FORATO

ART.		Lunghezza mm	
F BL 7620 00	_ _	973x304 H (A= 985)	
F BL 7635 00	_ _	1458x304 H (A= 1470)	

Predisposizione per l'aggancio ai montanti biasolati



PANNELLO NON FORATO

ART.		Lunghezza mm	
F BL 7670 00	_ _	973x304 H (A= 985)	
F BL 7685 00	_ _	1458x304 H (A= 1470)	

Predisposizione per l'aggancio ai montanti biasolati



MENSOLA INCLINABILE LUNGHEZZA 1440 mm

ART.		Profondità mm	kg
F BL 7795 00	_ _	220 (A= 1470)	50
F BL 7800 00	_ _	320 (A= 1470)	50
F BL 7805 00	_ _	420 (A= 1470)	50



MENSOLA INCLINABILE UNGHEZZA 955 mm

ART.		Profondità mm	kg
F BL 7750 00	_ _	220 (A= 985)	50
F BL 7755 00	_ _	320 (A= 985)	50
F BL 7760 00	_ _	420 (A= 985)	50
F BL 7762 00	_ _	600 (A= 985)	50

COLORI OPZIONABILI



GRIGIO
RAL 7000
.01



VERDE
RAL 6011
.02



BLU
RAL 5012
.04



GRIGIO
RAL 7035
.08



BIANCO GRIGIASTRO
RAL 9002
.1F



ROSSO RUBINO
RAL 3003
.1G



BLU GENZIANA
RAL 5010
.34



BIANCO PURO
RAL 9010
.35



GRIGIO ANTRACITE
RAL 7016
.39



BLU CAPRI
RAL 5019
.48



BANCO SERIE DYNAMIC dim. mm 2052x820x2220 H

composto da:

- 1 telaio monofronte base ART. F LE K213 00 55
- 1 telaio monofronte aggiuntivo ART. F LE L213 00 55
- 1 piano di lavoro con telaio regolabile da 720 a 1138 mm ART. F LE 1970 A1 55
- 1 armadio STEEL ART. F BG 3030 01 08
 - 1 coppia supporti per armadio ART. F BL 4600 00 08
 - 1 coperchio per armadio ART. F BL 6690 00 08
 - 1 foratura laterale per armadio ART. F BL 9043 00 00
- 3 pannelli forati ART. F BL 7620 00 1G
- 1 mensola fissa zincata da 150 mm ART. F BL 7846 00 99
 - 9 contenitori grigi PICKING BOX **mis. 1** ART. FAXPBC001A05101
- 1 mensola fissa zincata da 205 mm ART. F BL 7847 00 99
 - 6 contenitori grigi PICKING BOX **mis. 2** ART. FAXPBC002A05101
- 2 mensole inclinabili da 320 mm ART. F BL 7755 00 1G
 - 4 contenitori grigi PICKING BOX **mis. 3A2** ART. FAXPBC3A2B05101
- 1 binario base con supporto ART. F BL 9810 01 55
 - 1 binario aggiuntivo con supporto ART. F BL 9810 03 55
- 1 lampada Philips LED 1504 mm ART. F BL 9915 00 0G
- 1 scatola con 5 prese Schuko 220V IP30, 1 magnetotermico differenziale 2P 230V AC 10A I Δ N=0,01A, 1 supporto frontale ART. F BL 9360 10 59

DYNAMIC



ATTACCHI DI SCORRIMENTO

ART.	
R CMV 0034 00	

L'attacco di scorrimento è composto da: 1 anello in plastica nero completo di cuscinetti e 1 moschettone in acciaio.



SET BILANCIATORE

ART.	Bilanciatore	
F BL 9710 00 00	0,4-1 kg	
F BL 9720 00 00	1-2 kg	

Set completo di: 2 attacchi di scorrimento, 1 moschettone, 1 bilanciatore con cavo in acciaio lunghezza 1600 mm.



SET ARIA COMPRESSA AGGIUNTIVO CON BILANCIATORE

ART.	Bilanciatore	
F BL 9710 02 00	0,4-1 kg	
F BL 9720 02 00	1-2 kg	

Il set è completo di: 1 attacco da 1/4" (B), 2 fermi, 2 attacchi di scorrimento, 1 moschettone, 1 bilanciatore con cavo in acciaio lunghezza 1600 mm, 1 attacco universale 1/4" per utensili (A), 1 tubo a spirale diametro interno 5,5 mm.

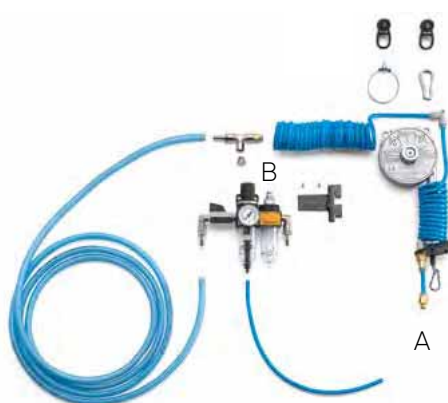

SET ARIA COMPRESSA CON BILANCIATORE E FILTRO

ART.	Bilanciatore	
F BL 9710 03 00	0,4-1 kg	
F BL 9720 03 00	1-2 kg	

Il set è completo di: 1 cavo flessibile Ø 10 mm, 1 connettore a T da 1/4" con tappo (B), 2 fermi, 2 attacchi di scorrimento, 1 moschettone, 1 bilanciatore con cavo in acciaio lunghezza 1600 mm, 1 attacco universale 1/4" per utensili (A), 1 tubo a spirale diametro interno 5,5 mm, 1 gruppo filtro regolatore con manometro* il quale può essere utilizzato con una pressione massima di 10 bar, la sua capacità è di circa 9 litri al secondo (sul punto A) e di 11 litri al secondo (sul punto B) con una pressione di utilizzo pari a 6,3 bar (la capacità può variare a seconda delle caratteristiche tecniche della rete pneumatica a cui l'impianto Fami viene allacciato). Raccordi da 1/4", 1 tubo diametro interno 5,5 mm per lo spurgo del filtro.

* Gruppo filtro regolatore con manometro e oliatore a richiesta

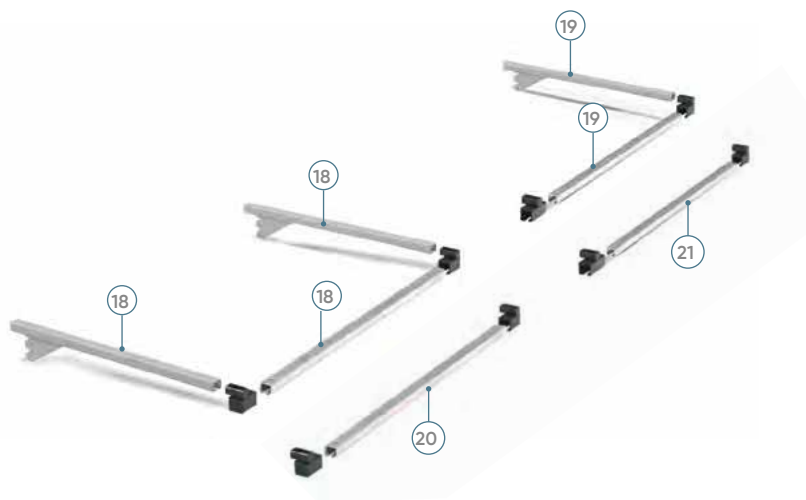
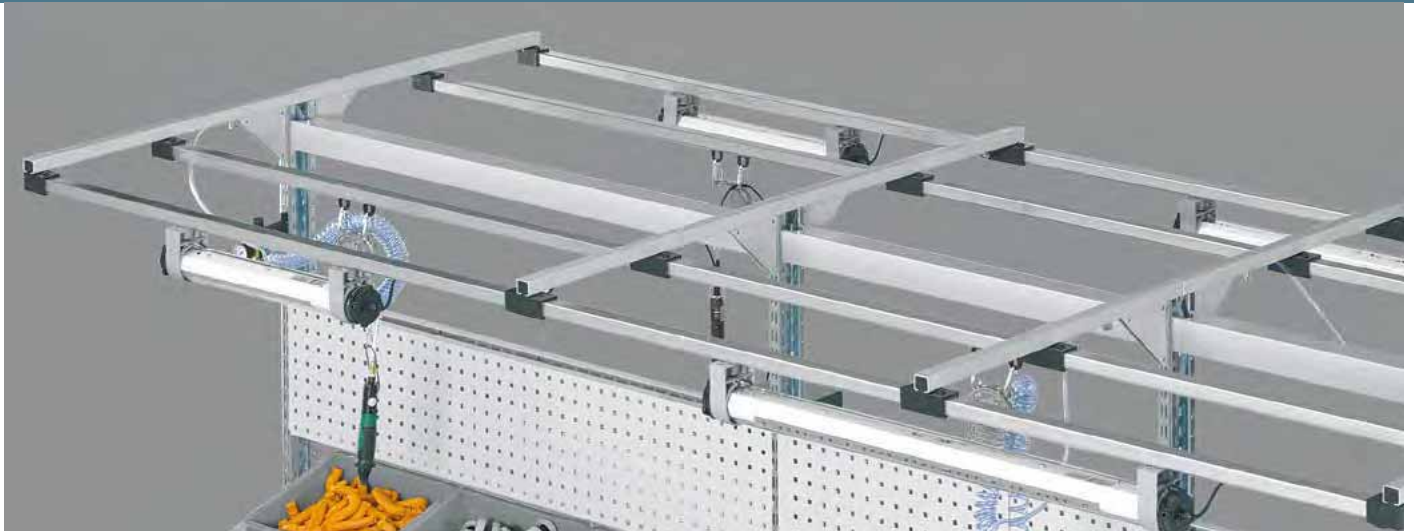

18 COPPIA SUPPORTI CON BINARIO BASE

ART.	Dimensioni mm
F BL 9810 01 55	985x750 (A=985)
F BL 9815 01 55	1470x750 (A=1470)

 55
ZINCATO+RAL 7035

20 BINARIO BASE

ART.	Lunghezza mm
F BL 9810 10 00	A= 985
F BL 9815 10 00	A= 1470

19 SUPPORTO CON BINARIO AGGIUNTIVO

ART.	Dimensioni mm
F BL 9810 03 55	985x750 (A=985)
F BL 9815 03 55	1470x750 (A=1470)

 55
ZINCATO+RAL 7035

21 BINARIO AGGIUNTIVO

ART.	Lunghezza mm
F BL 9810 13 00	A= 985
F BL 9815 13 00	A= 1470

ATTACCHI

ART.	
F BL 9841 00 07	22+23
F BL 9840 00 07	24

COLORE NERO

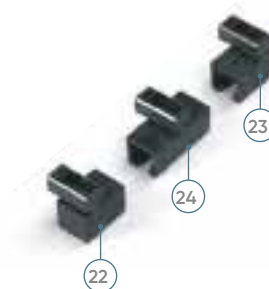



LAMPADA PHILIPS WT120C LED18S/840 PSU L600

ART.	dim. mm	
F BL 9905 00 00	661x96x82 H	

Copertura in policarbonato trasparente, grado di protezione IP 65, tensione di ingresso 220-240V, frequenza di ingresso da 50 a 60 Hz, flusso luminoso iniziale 4000 lm, vita utile media L70B50 ore 50.000, temperatura colore 4000K, indice resa colore 80, protezione IEC classe 1, spina di alimentazione Schuko. Materiale di fissaggio incluso.



LAMPADA PHILIPS WT120C LED40S/840 PSU L1200

ART.	dim. mm	
F BL 9910 00 00	1223x96x82 H	

Copertura in policarbonato trasparente, grado di protezione IP 65, tensione di ingresso 220-240V, frequenza di ingresso da 50 a 60 Hz, flusso luminoso iniziale 4000 lm, vita utile media L70B50 ore 50.000, temperatura colore 4000K, indice resa colore 80, protezione IEC classe 1, spina di alimentazione Schuko. Materiale di fissaggio incluso.



LAMPADA PHILIPS WT120C LED60S/840 PSU L1500

ART.	dim. mm	
F BL 9915 00 00	1504x96x82 H	

Copertura in policarbonato trasparente, grado di protezione IP 65, tensione di ingresso 220-240V, frequenza di ingresso da 50 a 60 Hz, flusso luminoso iniziale 6000 lm, vita utile media L70B50 ore 50.000, temperatura colore 4000K, indice resa colore 80, protezione IEC classe 1, spina di alimentazione Schuko. Materiale di fissaggio incluso.

LAMPADA WALDMANN 2x36 W IP 67

ART.	Lunghezza	Ø mm	
F BL 9960 00 00	1090 mm	70	

Caratteristiche tecniche: tubo in vetri borosilicato - Grado di protezione IP 67 - Neon 2x36W - Impianto elettrico 230V/50Hz - Spina di alimentazione Schuko - Lunghezza cavo 4 metri - Tonalità colore 4000K - Resa colore (Ra) 80-89

LAMPADA WALDMANN 1x39 W IP 20

ART.	dim. mm	
F BL 9930 00 08	956x187x50 H	

Caratteristiche tecniche: Grado di protezione IP 20 - Neon 1x39W - Impianto elettrico 230V/50Hz - Spina di alimentazione Schuko - Lunghezza cavo 3 metri - Tonalità colore 4000K - Resa colore (Ra) 80-89





Componenti elettrici con grado di protezione IP 30 forniti di serie:

- 2 scatole porta prese a 12 moduli
- 1 magnetotermico differenziale 2P 230V AC10A I Δ N=0,01A
- 2 pressacavi PG11
- 1 pressacavo PG16

- 2 raccordi dritti PG16
- 200 cm di guaina proteggicavo Ø 16 mm
- 1 spina fissa industriale 220-250V 16A 2P+T
- 1 cablaggio completo per 6-9 prese (a seconda dell'articolo)
- 6-9 prese 220-250V 10A 2P+T con relativi coprifori (a seconda dell'articolo)



CANALETTE CON PRESE CABLATE DIM. 1420x60x85 H mm

TIPO E NUMERO PRESE CABLATE

ART.	D	F	GB	I	CH	IL
F BL 9260 10 08	9	-	-	-	-	-
F BL 9260 20 08	-	9	-	-	-	-
F BL 9260 25 08	4	5	-	-	-	-
F BL 9260 30 08	-	-	6	-	-	-
F BL 9260 35 08	4	-	3	-	-	-
F BL 9260 40 08	-	-	-	9	-	-
F BL 9260 45 08	4	-	-	5	-	-
F BL 9260 50 08	-	-	-	-	9	-
F BL 9260 55 08	4	-	-	-	5	-
F BL 9260 70 08	-	-	-	-	-	9
F BL 9260 75 08	4	-	-	-	-	5

08
RAL 7035



CANALETTE CON PRESE CABLATE DIM. 1920x60x85 H mm

TIPO E NUMERO PRESE CABLATE

ART.	D	F	GB	I	CH	IL
F BL 9310 10 08	9	-	-	-	-	-
F BL 9310 20 08	-	9	-	-	-	-
F BL 9310 25 08	4	5	-	-	-	-
F BL 9310 30 08	-	-	6	-	-	-
F BL 9310 35 08	4	-	3	-	-	-
F BL 9310 40 08	-	-	-	9	-	-
F BL 9310 45 08	4	-	-	5	-	-
F BL 9310 50 08	-	-	-	-	9	-
F BL 9310 55 08	4	-	-	-	5	-
F BL 9310 70 08	-	-	-	-	-	9
F BL 9310 75 08	4	-	-	-	-	5

08
RAL 7035



COPPIA SUPPORTI ANTERIORI

ART. F BL 9450 00 99

Coppia supporti per l'aggancio della canaletta anteriore



COPPIA SUPPORTI POSTERIORI

ART. F BL 9455 00 99

Coppia supporti per l'aggancio della canaletta posteriore
-Per le canalette lunghezza 1940 mm con coppia supporti posteriori chiedere informazioni alla Fami.

DYNAMIC

Scatola porta prese completa di supporto laterale



SCATOLA PORTA PRESE 220V IP30 SUPPORTO LATERALE

TIPO E NUMERO PRESE CABLATE

ART.	D	F	GB	I	CH	IL
F BL 9361 10 59	5	-	-	-	-	-
F BL 9361 25 59	1	4	-	-	-	-
F BL 9361 30 59	-	-	3	-	-	-
F BL 9361 35 59	1	-	2	-	-	-
F BL 9361 45 59	1	-	-	4	-	-
F BL 9361 55 59	1	-	-	-	4	-
F BL 9361 75 59	1	-	-	-	-	4

Dimensioni mm 85x70x360 H

Componenti elettrici con grado di protezione IP30 forniti di serie:

- 1 scatola porta prese a 12 moduli
- 1 magnetotermico differenziale 2P 230V AC 10A I Δ N=0,01A
- 2 raccordi dritti PG16 cm 200 guaina proteggicavo Ø 16 mm
- 1 spina fissa industriale 220-250V 16A 2P+T
- 1 cablaggio completo per 3-5 prese (a seconda dell'articolo)
- 3-5 prese 220-250V 10A 2P+T con relativi copriferri (a seconda dell'articolo)

Scatola porta prese completa di supporto frontale



SCATOLA PORTA PRESE 220V IP30 SUPPORTO FRONTALE

TIPO E NUMERO PRESE CABLATE

ART.	D	F	GB	I	CH	IL
F BL 9360 10 59	5	-	-	-	-	-
F BL 9360 25 59	1	4	-	-	-	-
F BL 9360 30 59	-	-	3	-	-	-
F BL 9360 35 59	1	-	2	-	-	-
F BL 9360 45 59	1	-	-	4	-	-
F BL 9360 55 59	1	-	-	-	4	-
F BL 9360 75 59	1	-	-	-	-	4

Dimensioni mm 85x70x360 H

Componenti elettrici con grado di protezione IP30 forniti di serie:

- 1 scatola porta prese a 12 moduli
- 1 magnetotermico differenziale 2P 230V AC 10A I Δ N=0,01A
- 2 raccordi dritti PG16 cm 200 guaina proteggicavo Ø 16 mm
- 1 spina fissa industriale 220-250V 16A 2P+T
- 1 cablaggio completo per 3-5 prese (a seconda dell'articolo)
- 3-5 prese 220-250V 10A 2P+T con relativi copriferri (a seconda dell'articolo)



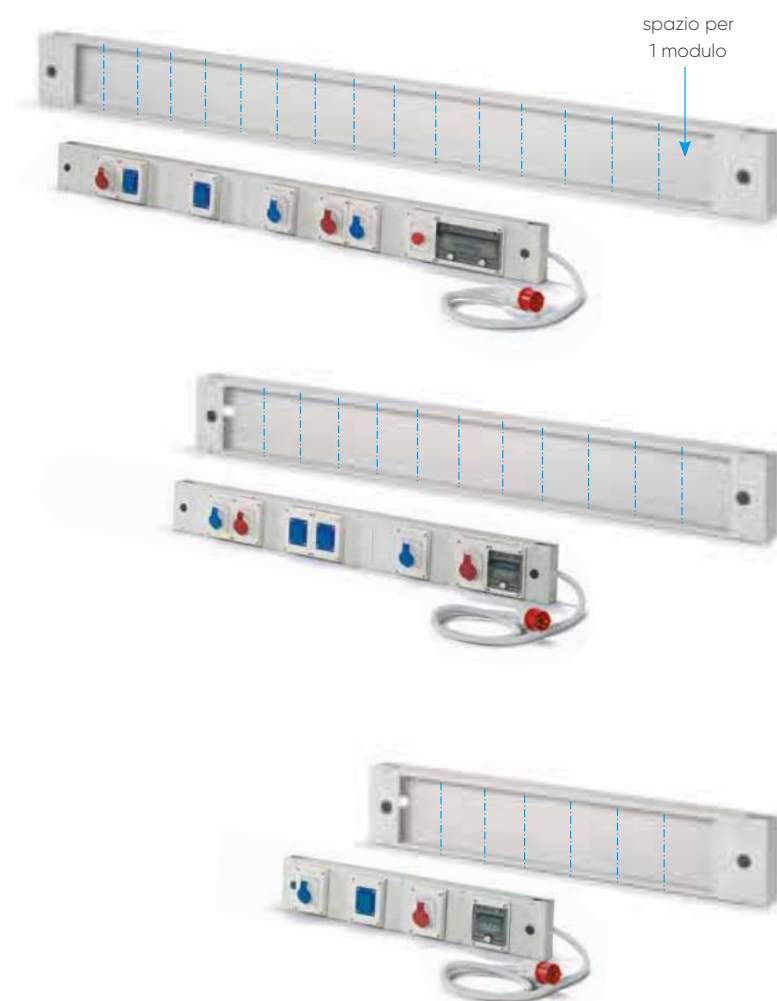

CANALETTA VUOTA 16 MODULI 220V - 380V

ART.	dim. mm	moduli	
F BL 9120 01 08	1920x72x170 H	16	

PER LUNGHEZZA TELAI 1970 mm
Canaletta vuota completa di 2 tamponi laterali con fori di uscita per gli impianti pneumatici. Fori Ø 22 mm

08
RAL 7035

CANALETTA VUOTA 12 MODULI 220V - 380V

ART.	dim. mm	moduli	
F BL 9115 01 08	1420x72x170 H	12	

PER LUNGHEZZA TELAI 1470 mm
Canaletta vuota completa di 2 tamponi laterali con fori di uscita per gli impianti pneumatici. Fori Ø 22 mm

08
RAL 7035

CANALETTA VUOTA 7 MODULI 220V - 380V

ART.	dim. mm	moduli	
F BL 9110 01 08	935x72x170 H	7	

PER LUNGHEZZA TELAI 985 mm
Canaletta vuota completa di 2 tamponi laterali con fori di uscita per gli impianti pneumatici. Fori Ø 22 mm

08
RAL 7035



COPPIA SUPPORTI ANTERIORI

ART. F BL 9460 00 99

Coppia supporti per l'aggancio della canaletta anteriore



COPPIA SUPPORTI POSTERIORI

ART. F BL 9465 00 99

Coppia supporti per l'aggancio della canaletta posteriore

Per le canalette lunghezza 1920 mm con coppia supporti posteriori chiedere informazioni alla Fami

MAGNETOTERMICO DIFFERENZIALE 220V



ART. CABLAGGIO

F BL 9393 51 00 SI

F BL 9393 52 00 NO

Composto da: centralino con coperchio, magnetotermico differenziale 220V 16A 1P+N I Δ N=0,03A, cavo lunghezza 3 metri con spina volante CEE 220V - Grado di protezione IP40

 IL CAVO VIENE FORNITO SOLO CON CENTRALINO CABLATO

MAGNETOTERMICO DIFFERENZIALE 220V



ART. CABLAGGIO

F BL 9393 55 00 SI

F BL 9393 56 00 NO

Composto da: centralino con coperchio, magnetotermico differenziale 220V 16A 1P+N I Δ N=0,03A con sganciatore di emergenza, 1 fungo di emergenza, cavo lunghezza 3 metri con spina volante CEE 220V Grado di protezione IP40

 IL CAVO VIENE FORNITO SOLO CON CENTRALINO CABLATO

MAGNETOTERMICO DIFFERENZIALE 380V



ART. CABLAGGIO

F BL 9393 53 00 SI

F BL 9393 54 00 NO

Composto da: centralino con coperchio, magnetotermico differenziale 380V 16A 4P I Δ N=0,03A, cavo lunghezza 3 metri con spina volante CEE 380V - Grado di protezione IP40

 IL CAVO VIENE FORNITO SOLO CON CENTRALINO CABLATO

MAGNETOTERMICO DIFFERENZIALE 380V



ART. CABLAGGIO

F BL 9393 57 00 SI

F BL 9393 58 00 NO

Composto da: centralino con coperchio, magnetotermico differenziale 380V 16A 4P I Δ N=0,03A con sganciatore di emergenza, 1 fungo di emergenza, cavo lunghezza 3 metri con spina volante CEE 380V Grado di protezione IP40

 IL CAVO VIENE FORNITO SOLO CON CENTRALINO CABLATO

MAGNETOTERMICO 220V



ART. CABLAGGIO

F BL 9394 51 00 SI

F BL 9394 52 00 NO

Composto da: centralino con coperchio, magnetotermico 220V 16A 1P+N, cavo lunghezza 3 metri con spina volante CEE 220V Grado di protezione IP40

 IL CAVO VIENE FORNITO SOLO CON CENTRALINO CABLATO

MAGNETOTERMICO 220V



ART. CABLAGGIO

F BL 9394 55 00 SI

F BL 9394 56 00 NO

Composto da: centralino con coperchio, magnetotermico 220V 16A 1P+N con sganciatore di emergenza, 1 fungo di emergenza, cavo lunghezza 3 metri con spina volante CEE 220V Grado di protezione IP40

 IL CAVO VIENE FORNITO SOLO CON CENTRALINO CABLATO

PRESA SCHUKO



1 MODULO

ART.	CABLAGGIO
F BL 9395 57 00	SI
F BL 9395 58 00	NO

Composto da: 1 presa 220V 16A 2P+T
Grado di protezione IP40

PRESA 380V 3P+N+T



1 MODULO

ART.	CABLAGGIO
F BL 9395 51 00	SI
F BL 9395 52 00	NO

Composto da: 1 presa 380V 16A 3P+N+T
Grado di protezione IP40



COPERCHIO PER CANALETTA

ART.
F BL 9384 00 08

PRESA 220V 2P+T



1 MODULO

ART.	CABLAGGIO
F BL 9395 55 00	SI
F BL 9395 56 00	NO

Composto da: 1 presa 220V CEE 16A 2P+T
Grado di protezione IP40

PRESA 380V 3P+T



1 MODULO

ART.	CABLAGGIO
F BL 9395 53 00	SI
F BL 9395 54 00	NO

Composto da: 1 presa 380V 16A 3P+T
Grado di protezione IP40



TUBO PNEUMATICO DI ALIMENTAZIONE

ART.
F BL 9401 02 00

Il tubo lunghezza 3 metri viene fornito completo di 1 manicotto, 2 porta gomma maschio con fascette, 1 tappo. Raccorderie 3/8"



DYNAMIC

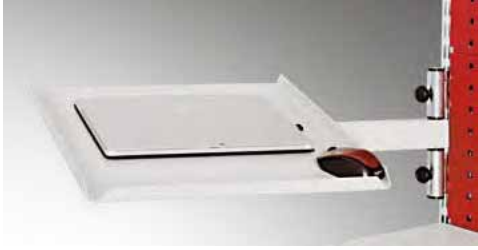

BRACCIO DOPPIO SNODO CON VASSOIO INCLINATO

ART.		
F BL 7456 00 08	20	

COMPLETO DI FRENI A VITE CON POMELLO.
Dimensioni interne vassoio mm: 401x402x21 H

08
RAL 7035



BRACCIO DOPPIO SNODO CON CONTENITORI

ART.		
F BL 7445 03 08	15	

Completo di :
5 contenitori grigi PICKING BOX **mis. 1** ART. FAXPBC001B05101
3 contenitori grigi PICKING BOX **mis. 2** ART. FAXPBC002B05101

08
RAL 7035



BRACCIO DOPPIO SNODO CON CONTENITORI

ART.		
F BL 7445 04 08	15	

Completo di :
15 contenitori grigi PICKING BOX **mis. 1** ART. FAXPBC001B05101

08
RAL 7035



BRACCIO DOPPIO SNODO CON VASSOIO

ART.		
F BL 7455 00 08	20	

COMPLETO DI FRENI A VITE CON POMELLO.

08
RAL 7035



BRACCIO DOPPIO SNODO CON VISUAL BOX

ART.		
F BL 7446 01 08	15	











Completo di : 1 VISUAL BOX a 9 cassette ART. FAXVBCH00900001
2 VISUAL BOX a 6 cassette ART. FAXVBCH00600001

08
RAL 7035



TAPPARELLA

ART.	Dimensioni mm	kg
F BL 7011 02	952x210x810 H	50

 01 RAL 7000	 02 RAL 6011	 04 RAL 5012	 08 RAL 7035	 1F RAL 9002
 1G RAL 3003	 34 RAL 5010	 35 RAL 9010	 39 RAL 7016	 48 RAL 5019



TELAIO PORTA COMPUTER

ART.	Dimensioni mm
F BL 7444 00 08	223x416x134 H

Solo per versioni Tower
Dimensioni utili mm: 210x412 H

 08 RAL 7035
--

DYNAMIC

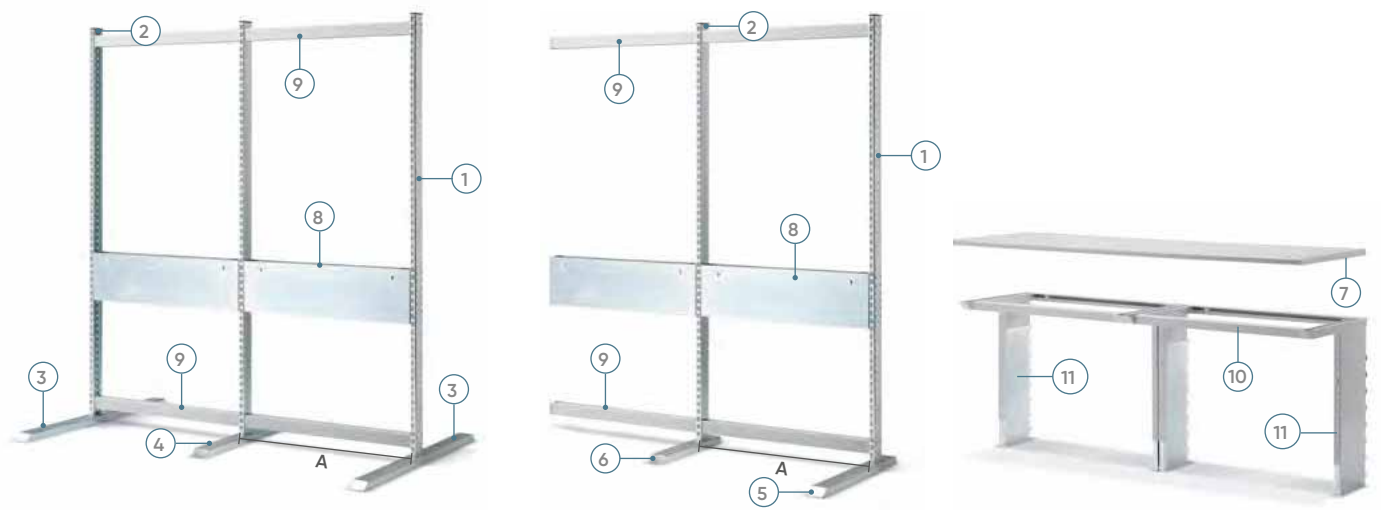

1 MONTANTE BIASOLATO

ART.	H mm
F BL 7540 02 --	1240
F BL 7547 02 --	1772
F BL 7555 02 --	2152



4 PIEDE BIFRONTALE CENTRALE

ART.	Lunghezza mm
F BL 4525 00 99	925



Da utilizzare solamente con il piano di lavoro lunghezza 1970 mm

2 COPPIA TAPPI

ART.
F BL 4420 00 07

COLORE NERO

5 PIEDE MONOFRONTALE LATERALE

ART.	Lunghezza mm
F BL 4530 00 99	722



3 PIEDE BIFRONTALE LATERALE

ART.	Lunghezza mm
F BL 4520 00 99	1285



6 PIEDE MONOFRONTALE CENTRALE

ART.	Lunghezza mm
F BL 4535 00 99	542



Da utilizzare solamente con il piano di lavoro lunghezza 1970 mm

7 PIANO LAMINATO GRIGIO

ART.	Dimensioni mm
F BS 0960 00 08	985x600x30 H
F BS 0970 00 08	985x700x30 H
F BS 1460 00 08	1470x600x30 H
F BS 1470 00 08	1470x700x30 H
F BS 1960 00 08	1970x600x30 H
F BS 1970 00 08	1970x700x30 H

Piano in truciolare rivestito in laminato grigio

8 TRAVERSO CON VANO

ART.	Lunghezza mm
F BL 4620 00 99	955 (A=985)
F BL 4625 00 99	1440 (A=1470)

99
ZINCATO

9 TRAVERSO

ART.	Lunghezza mm
F BL 4630 00 _ _	969 (A=985)
F BL 4635 00 _ _	1455 (A=1470)

01 04 08 02
RAL 7000 RAL 5012 RAL 7035 RAL 6011

10 TELAIO PER PIANO DI LAVORO

ART.	Dimensioni mm
F BL 4650 00 _ _	984x551
F BL 4655 00 _ _	1469x551

01 04 08 02
RAL 7000 RAL 5012 RAL 7035 RAL 6011

Servono due telai da 985 mm per fissare un piano di lavoro con lunghezza 1970 mm.

11 COPPIA MONTANTI TELESCOPICI

ART.	H mm
F BL 4670 00 _ _	611/1029

52 53 54 55
ZINCATO+RAL 7000 ZINCATO+RAL 6011 ZINCATO+RAL 5012 ZINCATO+RAL 7035



10 COLORI ACCIAIO

8 COLORI PLASTICHE

ESTRAIBILITÀ CASSETTI 100%

VERSATILITÀ DELLE

CASSETTIERE MASTER

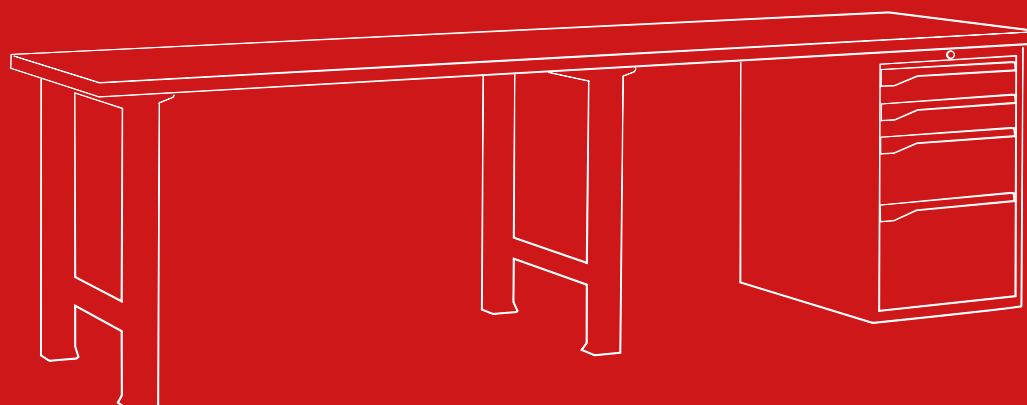



WORK MASTER

CARATTERISTICHE TECNICHE

COLORI

ARMADIO

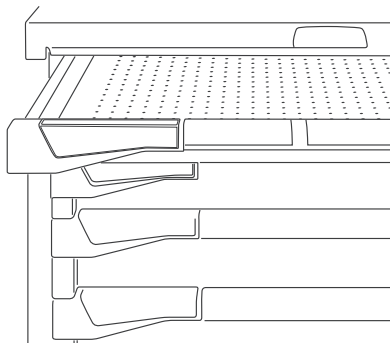

10 colori per la parte metallica



8 colori per gli accessori di plastica



MANIGLIA FRONTALE



ARMADI A CASSETTI

Nuova guida ad estrazione flessibile con regolazione meccanica del fermo posteriore del cassetto in 3 diverse posizioni.



92% = 100 Kg
96% = 75 Kg
100% = 50 Kg

SU RICHIESTA POSSONO ESSERE INSERITE LE
PARETI ATTREZZATE





CHIUSURA CON CILINDRO



Sistema di trasmissione dal cilindro della chiusura alla testa dell'asta vertebrata a filo di acciaio con guaina elastica e movimento lineare.

La chiusura a cilindro è suddivisa in 23 diverse serie: ogni serie ha una numerazione delle chiavi compresa tra 1 e 160, per un totale di 3.680 diverse combinazioni.

FORNITA DI SERIE CON 2 CHIAVI

CHIUSURA CON CODICE NUMERICO

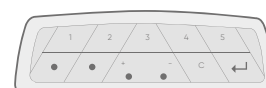

Oltre alla normale chiusura a cilindro, Fami ha deciso di aggiungere alle proprie chiusure la chiusura CODE. La serratura a codice numerico comanda l'apertura e la chiusura dell'asta vertebrata. Gestisce fino a 10 utenti con codice numerico da 3 a 8 cifre. Il download storico degli eventi è possibile tramite cavo collegando il tastierino al pc. Disponibili su richiesta fino a 10 telecomandi.

I CASSETTI HANNO
ESTRAZIONE
FLESSIBILE

ASTA VERTEBRATA

È IL CUORE E IL CERVELLO DEL SISTEMA

L'asta è in profilato d'alluminio e rimane sempre fissa, senza ruotare. Il movimento di chiusura è ottenuto da tasselli che si spostano verticalmente sfruttando una delle forze elementari della fisica: la gravità. Più il movimento è semplice, meno probabilità di rotture ci sono. La chiusura dell'asta è affidata a un sistema a catenaccio posto sulla testa dell'asta.

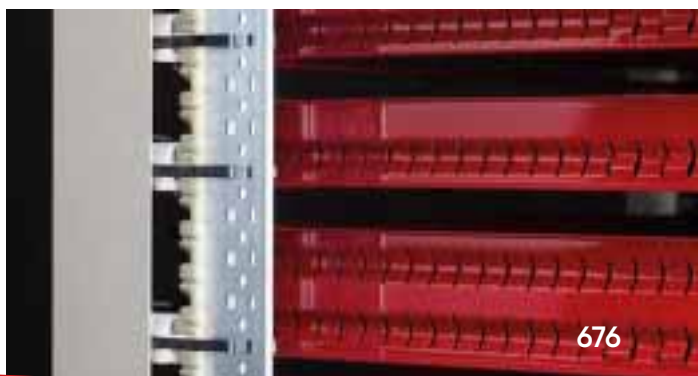













● ART. M BI A228 CO 10 04 04

H = 840 mm - 1 cassetto

Gamma colori ACCIAIO

									
GRIGIO RAL 7000 .01	VERDE RAL 6011 .02	BLU RAL 5012 .04	GRIGIO RAL 7035 .08	BIANCO GRIGIASTRO RAL 9002 .1F	ROSSO RUBINO RAL 3003 .1G	BLU GENZIANA RAL 5010 .34	BIANCO PURO RAL 9010 .35	GRIGIO ANTRACITE RAL 7016 .39	BLU CAPRI RAL 5019 .48

Gamma colori
PLASTICHE



DARK GREY
.MO

LEGENDA



PROFONDITÀ



CHIUSURA
BANCO



PORTATA
BANCO



LE PORTATE SONO NETTE E SI RIFERISCONO A PESI UNIFORMEMENTE DISTRIBUITI.

PIANO IN MULTIPLEX SPESSORE 40 mm



ART.				
M BI A228 00 00 01 04		750 mm	-	1200
M BI A328 00 00 01 04		800 mm	-	1200



Piano inferiore in Multiplex ART. F BI 1135 00 00
Dimensioni mm 1140x612x25 H
Portata 130 kg



1 cassetto



1 cassetto

Armadio dim. mm 561x726x200 H (27x36 EH)

Armadio dim. mm 561x726x300 H (27x36 EH)

ART.				
M BI A228 C0 10 04 04		750 mm	key	1200
M BI A328 C0 10 04 04		800 mm	key	1200

ART.				
M BI A228 C0 10 07 04		750 mm	key	1200
M BI A328 C0 10 07 04		800 mm	key	1200



Piano inferiore in Multiplex ART. F BI 1135 00 00
Dimensioni mm 1140x612x25 H
Portata 130 kg



Piano inferiore in Multiplex ART. F BI 1135 00 00
Dimensioni mm 1140x612x25 H
Portata 130 kg



4 cassetti



5 cassetti

Armadio dim. mm 561x726x800 H (27x36 EH)

Armadio dim. mm 561x726x800 H (27x36 EH)

ART.				
M BI A228 C0 10 16 04		750 mm	key	1500
M BI A328 C0 10 16 04		800 mm	key	1500
M BI A228 E2 10 16 04		750 mm	code	1500
M BI A328 E2 10 16 04		800 mm	code	1500

ART.				
M BI A228 C0 10 30 04		750 mm	key	1500
M BI A328 C0 10 30 04		800 mm	key	1500
M BI A228 E2 10 30 04		750 mm	code	1500
M BI A328 E2 10 30 04		800 mm	code	1500



Piano inferiore in Multiplex ART. F BI 0575 01 01
Dimensioni mm 580x612x25 H
Portata 180 kg



Piano inferiore in Multiplex ART. F BI 0575 01 01
Dimensioni mm 580x612x25 H
Portata 180 kg

PIANO IN MULTIPLEX SPESSORE 40 mm



Armadio dim. mm 561x726x800 H (27x36 EH)

ART.					
M BI A228 C0 10 31 04		750 mm	key	1500	
M BI A328 C0 10 31 04		800 mm	key	1500	
M BI A228 E2 10 31 04		750 mm	code	1500	
M BI A328 E2 10 31 04		800 mm	code	1500	

Piano inferiore in Multiplex ART. F BI 0575 01 01
Dimensioni mm 580x612x25 H
Portata 180 kg



Armadio dim. mm 561x726x800 H (27x36 EH)

ART.					
M BI A228 C0 10 32 04		750 mm	key	1500	
M BI A328 C0 10 32 04		800 mm	key	1500	
M BI A228 T2 10 32 04		750 mm	code	1500	
M BI A328 T2 10 32 04		800 mm	code	1500	

Piano inferiore in Multiplex ART. F BI 0575 01 01
Dimensioni mm 580x612x25 H
Portata 180 kg



ART.					
M BI A228 00 00 22 04		750 mm	key	1200	
M BI A328 00 00 22 04		800 mm	key	1200	

Con armadio completo di 4 prese Schuko 220-250V 10A 2P+T e magnetotermico 2P 230 AC 10A cablati

Piano inferiore in Multiplex ART. F BI 0947 01 01
Dimensioni mm 951x612x25 H
Portata 180 kg



ART.					
M BI A228 00 00 21 04		750 mm	key	1200	
M BI A328 00 00 21 04		800 mm	key	1200	

Con armadio completo di morsa da 120 mm a scomparsa

Piano inferiore in Multiplex ART. F BI 0825 01 01
Dimensioni mm 829x612x25 H
Portata 180 kg



ART. M BI A228 CO 10 AA NQ











Banco serie Master con 1 armadio a 1 cassetto
(H frontale 1x100 mm) + 2 gambe H 800 mm
2 montanti H 632 mm
1 pannello forato mm 973x304 H
1 mensola mm 955x320 H
Dim. mm 1300x750x840 H
COLORE ACCIAIO ROSSO RAL 3003 +
BIANCO RAL 9010
COLORE PLASTICHE DARK GREY

ESCLUSI UTENSILI, GANCI E CONTENITORI



● ART. M BI A242 C0 10 07 04
H = 840 mm - 1 cassetto

Gamma colori ACCIAIO

									
GRIGIO RAL 7000 .01	VERDE RAL 6011 .02	BLU RAL 5012 .04	GRIGIO RAL 7035 .08	BIANCO GRIGIASTRO RAL 9002 .1F	ROSSO RUBINO RAL 3003 .1G	BLU GENZIANA RAL 5010 .34	BIANCO PURO RAL 9010 .35	GRIGIO ANTRACITE RAL 7016 .39	BLU CAPRI RAL 5019 .48

Gamma colori
PLASTICHE



DARK GREY
.M0

LEGENDA



PROFONDITÀ



CHIUSURA
BANCO



PORTATA
BANCO



LE PORTATE SONO NETTE E SI RIFERISCONO A PESI UNIFORMEMENTE DISTRIBUITI

PIANO IN MULTIPLEX SPESSORE 40 mm



ART.				
M BI A242 00 00 01 04	750 mm	-	800	
M BI A342 00 00 01 04	800 mm	-	800	



Piano inferiore in Multiplex ART. F BI 1340 00 00
Dimensioni mm 1340x612x25 H
Portata 130 kg



1 cassetto
100

Armadio dim. mm 561x726x200 H (27x36 EH)

ART.				
M BI A242 C0 10 04 04	750 mm	key	800	
M BI A342 C0 10 04 04	800 mm	key	800	



Piano inferiore in Multiplex ART. F BI 1340 00 00
Dimensioni mm 1340x612x25 H
Portata 130 kg



1 cassetto
200

Armadio dim. mm 561x726x300 H (27x36 EH)

ART.				
M BI A242 C0 10 07 04	750 mm	key	800	
M BI A342 C0 10 07 04	800 mm	key	800	



Piano inferiore in Multiplex ART. F BI 1340 00 00
Dimensioni mm 1340x612x25 H
Portata 130 kg



3 cassetti
50
100
150

Armadio dim. mm 561x726x400 H (27x36 EH)

ART.				
M BI A242 C0 10 10 04	750 mm	key	800	
M BI A342 C0 10 10 04	800 mm	key	800	
M BI A242 E2 10 10 04	750 mm	code	800	
M BI A342 E2 10 10 04	800 mm	code	800	



Piano inferiore in Multiplex ART. F BI 1340 00 00
Dimensioni mm 1340x612x25 H
Portata 130 kg



4 cassetti
100
100
200
300

Armadio dim. mm 561x726x800 H (27x36 EH)

ART.				
M BI A242 C0 10 16 04	750 mm	key	1500	
M BI A342 C0 10 16 04	800 mm	key	1500	
M BI A242 E2 10 16 04	750 mm	code	1500	
M BI A342 E2 10 16 04	800 mm	code	1500	



Piano inferiore in Multiplex ART. F BI 0773 01 01
Dimensioni mm 780x612x25 H
Portata 180 kg

PIANO IN MULTIPLEX SPESSORE 40 mm



Armadio dim. mm 561x726x800 H (27x36 EH)

ART.					
M BI A242 C0 10 30 04		750 mm	key	1500	
M BI A342 C0 10 30 04		800 mm	key	1500	
M BI A242 E2 10 30 04		750 mm	code	1500	
M BI A342 E2 10 30 04		800 mm	code	1500	



Piano inferiore in Multiplex ART. F BI 0773 01 01
Dimensioni mm 780x612x25 H
Portata 180 kg



Armadio dim. mm 561x726x800 H (27x36 EH)

ART.					
M BI A242 C0 10 32 04		750 mm	key	1500	
M BI A342 C0 10 32 04		800 mm	key	1500	
M BI A242 T2 10 32 04		750 mm	code	1500	
M BI A342 T2 10 32 04		800 mm	code	1500	



Piano inferiore in Multiplex ART. F BI 0773 01 01
Dimensioni mm 780x612x25 H
Portata 180 kg



Armadio dim. mm 561x726x800 H (27x36 EH)

ART.					
M BI A242 C0 10 58 04		750 mm	key	1500	
M BI A342 C0 10 58 04		800 mm	key	1500	
M BI A242 E2 10 58 04		750 mm	code	1500	
M BI A342 E2 10 58 04		800 mm	code	1500	

Con armadio completo di 4 prese Schuko 220-250V 10A 2P+T e magnetotermico 2P 230 AC 10A cablati



Armadio dim. mm 561x726x800 H (27x36 EH)

ART.					
M BI A242 C0 10 49 04		750 mm	key	1500	
M BI A342 C0 10 49 04		800 mm	key	1500	
M BI A242 E2 10 49 04		750 mm	code	1500	
M BI A342 E2 10 49 04		800 mm	code	1500	

Con armadio completo di morsa da 120 mm a scomparsa



ART. M BI A242 CO 11 AB 1F

Banco serie Master con 1 armadio a 6 cassetti
(H frontale mm 1x50 - 2x100 - 2x150 - 1x200) + 1 gamba H 850 mm
2 montanti H 1240 mm
2 pannelli forati mm 1458x304 H
1 mensola mm 1440x220 H
1 binario
Dim. mm 1500x750x890 H
COLORE ACCIAIO BIANCO GRIGIASTRO RAL 9002 +
COLORE PLASTICHE BLUE MEDITERRANEAN



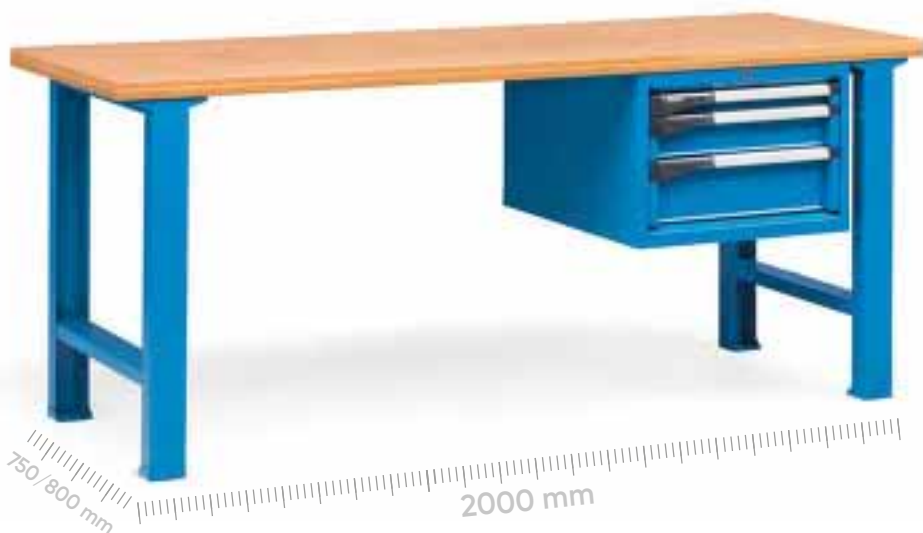







ESCLUSI UTENSILI, GANCI, LAMPADA, CANALETTA E CONTENITORI



● **ART. M BI A270 CO 10 10 04**

H = 840 mm - 3 cassetti

 Gamma colori ACCIAIO

									
GRIGIO RAL 7000 .01	VERDE RAL 6011 .02	BLU RAL 5012 .04	GRIGIO RAL 7035 .08	BIANCO GRIGIASTRO RAL 9002 .1F	ROSSO RUBINO RAL 3003 .1G	BLU GENZIANA RAL 5010 .34	BIANCO PURO RAL 9010 .35	GRIGIO ANTRACITE RAL 7016 .39	BLU CAPRI RAL 5019 .48

Gamma colori
PLASTICHE



DARK GREY
.M0

LEGENDA



PROFONDITÀ



CHIUSURA
BANCO



PORTATA
BANCO



LE PORTATE SONO NETTE E SI RIFERISCONO A PESI UNIFORMEMENTE DISTRIBUITI.

PIANO IN MULTIPLEX SPESSORE 40 mm



ART.				
M BI A270 00 00 01 04	750 mm	-	-	500
M BI A370 00 00 01 04	800 mm	-	-	500

Piano inferiore in Multiplex ART. F BI 1840 00 00
Dimensioni mm 1840x612x25 H
Portata 85 kg



Armadio dim. mm 561x726x200 H (27x36 EH)

ART.				
M BI A270 C0 10 04 04	750 mm	key	-	500
M BI A370 C0 10 04 04	800 mm	key	-	500

Piano inferiore in Multiplex ART. F BI 1840 00 00
Dimensioni mm 1840x612x25 H
Portata 85 kg



Armadio dim. mm 561x726x300 H (27x36 EH)

ART.				
M BI A270 C0 10 07 04	750 mm	key	-	500
M BI A370 C0 10 07 04	800 mm	key	-	500

Piano inferiore in Multiplex ART. F BI 1840 00 00
Dimensioni mm 1840x612x25 H
Portata 85 kg



Armadio dim. mm 561x726x400 H (27x36 EH)

ART.				
M BI A270 C0 10 10 04	750 mm	key	-	500
M BI A370 C0 10 10 04	800 mm	key	-	500
M BI A270 E2 10 10 04	750 mm	code	-	500
M BI A370 E2 10 10 04	800 mm	code	-	500

Piano inferiore in Multiplex ART. F BI 1840 00 00
Dimensioni mm 1840x612x25 H
Portata 85 kg



Armadio dim. mm 561x726x800 H (27x36 EH)

ART.				
M BI A270 C0 10 16 04	750 mm	key	-	800
M BI A370 C0 10 16 04	800 mm	key	-	800
M BI A270 E2 10 16 04	750 mm	code	-	800
M BI A370 E2 10 16 04	800 mm	code	-	800

Piano inferiore in Multiplex ART. F BI 1275 01 01
Dimensioni mm 1280x612x25 H
Portata 130 kg

PIANO IN MULTIPLEX SPESSORE 40 mm



Armadio dim. mm 561x726x800 H (27x36 EH)

ART.					
M BI A270 C0 10 13 04			key	1500	750 mm
M BI A370 C0 10 13 04			key	1500	800 mm
M BI A270 E2 10 13 04			code	1500	750 mm
M BI A370 E2 10 13 04			code	1500	800 mm



Piano inferiore in Multiplex ART. F BI 0710 02 01
Dimensioni mm 720x612x25 H
Portata 180 kg



Armadio dim. mm 561x726x800 H (27x36 EH)

ART.					
M BI A270 C0 10 28 04			key	1500	750 mm
M BI A370 C0 10 28 04			key	1500	800 mm
M BI A270 T2 10 28 04			code	1500	750 mm
M BI A370 T2 10 28 04			code	1500	800 mm



Piano inferiore in Multiplex ART. F BI 0710 02 01
Dimensioni mm 720x612x25 H
Portata 180 kg



Armadio dim. mm 561x726x800 H (27x36 EH)

ART.					
M BI A270 C0 10 58 04			key	800	750 mm
M BI A370 C0 10 58 04			key	800	800 mm
M BI A270 E2 10 58 04			code	800	750 mm
M BI A370 E2 10 58 04			code	800	800 mm

Con armadio completo di 4 prese Schuko 220-250V 10A 2P+T e magnetotermico 2P 230 AC 10A cablati



Piano inferiore in Multiplex ART. F BI 1082 02 01
Dimensioni mm 1091x612x25 H
Portata 130 kg



Armadio dim. mm 561x726x800 H (27x36 EH)

ART.					
M BI A270 C0 10 49 04			key	800	750 mm
M BI A370 C0 10 49 04			key	800	800 mm
M BI A270 E2 10 49 04			code	800	750 mm
M BI A370 E2 10 49 04			code	800	800 mm

Con armadio completo di morsa da 120 mm a scomparsa



Piano inferiore in Multiplex ART. F BI 0960 02 01
Dimensioni mm 969x612x25 H
Portata 180 kg

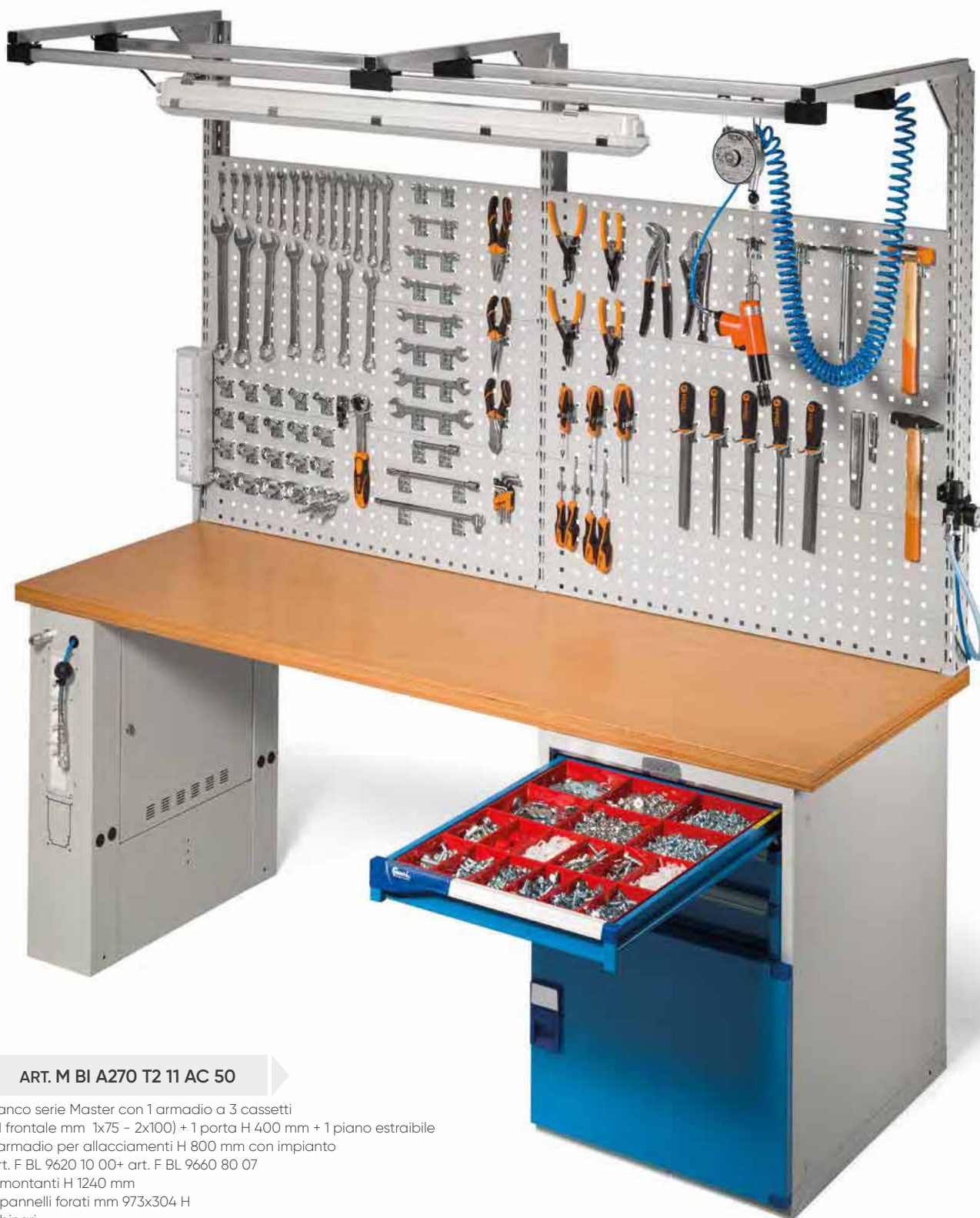

ART. M BI A270 T2 11 AC 50





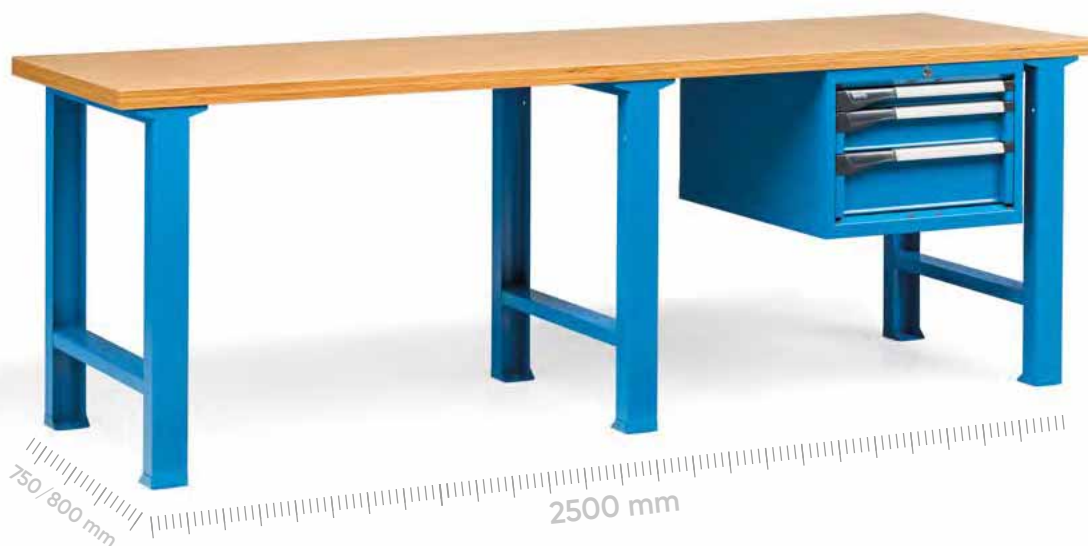



Banco serie Master con 1 armadio a 3 cassetti
(H frontale mm 1x75 - 2x100) + 1 porta H 400 mm + 1 piano estraibile
1 armadio per allacciamenti H 800 mm con impianto
art. F BL 9620 10 00+ art. F BL 9660 80 07
3 montanti H 1240 mm
6 pannelli forati mm 973x304 H
2 binari
Dim.mm 2000x750x840 H
COLORE ACCIAIO GRIGIO RAL 7035 + BLU RAL 5012
COLORE PLASTICHE BLUE MEDITERRANEAN

ESCLUSI UTENSILI, GANCI, LAMPADA, SCATOLA PORTA
PRESE, BILANCIATORE E MATERIALE DI SEPARAZIONE

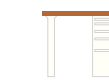

● ART. M BI A284 C0 10 10 04
H = 840 mm - 3 cassetti

Gamma colori ACCIAIO

									
GRIGIO RAL 7000 .01	VERDE RAL 6011 .02	BLU RAL 5012 .04	GRIGIO RAL 7035 .08	BIANCO GRIGIASTRO RAL 9002 .1F	ROSSO RUBINO RAL 3003 .1G	BLU GENZIANA RAL 5010 .34	BIANCO PURO RAL 9010 .35	GRIGIO ANTRACITE RAL 7016 .39	BLU CAPRI RAL 5019 .48

Gamma colori
PLASTICHE



DARK GREY
.M0

LEGENDA



PROFONDITÀ



CHIUSURA
BANCO



PORTATA
BANCO



LE PORTATE SONO NETTE E SI RIFERISCONO A PESI UNIFORMEMENTE DISTRIBUITI

PIANO IN MULTIPLEX SPESSORE 40 mm



ART.				
M BI A284 00 00 01 04	750 mm	-	800	
M BI A384 00 00 01 04	800 mm	-	800	



Piano inferiore in Multiplex ART. F BI 2100 00 00
Dimensioni mm 2340x612x25 H
Portata 260 kg



3 cassetti Armadio dim. mm 561x726x400 H (27x36 EH)

ART.				
M BI A284 C0 10 10 04	750 mm	key	800	
M BI A384 C0 10 10 04	800 mm	key	800	
M BI A284 E2 10 10 04	750 mm	code	800	
M BI A384 E2 10 10 04	800 mm	code	800	



Piano inferiore in Multiplex ART. F BI 2100 00 00
Dimensioni mm 2340x612x25 H
Portata 260 kg



3 cassetti Armadio dim. mm 561x726x400 H (27x36 EH)

ART.				
M BI A284 C0 10 61 04	750 mm	key	800	
M BI A384 C0 10 61 04	800 mm	key	800	
M BI A284 E2 10 61 04	750 mm	code	800	
M BI A384 E2 10 61 04	800 mm	code	800	



Piano inferiore in Multiplex ART. F BI 2100 00 00
Dimensioni mm 2340x612x25 H
Portata 260 kg



4 cassetti Armadio dim. mm 561x726x800 H (27x36 EH)

ART.				
M BI A284 C0 10 16 04	750 mm	key	350	
M BI A384 C0 10 16 04	800 mm	key	350	
M BI A284 E2 10 16 04	750 mm	code	350	
M BI A384 E2 10 16 04	800 mm	code	350	



Piano inferiore in Multiplex ART. F BI 1775 01 01
Dimensioni mm 1780x612x25 H
Portata 85 kg



Armadio dim. mm 561x726x800 H (27x36 EH)

ART.			
M BI A284 CO 10 30 04	750 mm	key	350
M BI A384 CO 10 30 04	800 mm	key	350
M BI A284 E2 10 30 04	750 mm	code	350
M BI A384 E2 10 30 04	800 mm	code	350



Piano inferiore in Multiplex ART. F BI 1775 01 01
Dimensioni mm 1780x612x25 H
Portata 85 kg



Armadio dim. mm 561x726x800 H (27x36 EH)

ART.			
M BI A284 CO 10 58 04	750 mm	key	350
M BI A384 CO 10 58 04	800 mm	key	350
M BI A284 E2 10 58 04	750 mm	code	350
M BI A384 E2 10 58 04	800 mm	code	350



Piano inferiore in Multiplex ART. F BI 1582 02 01
Dimensioni mm 1591x612x25 H
Portata 85 kg

Con armadio completo di 4 prese Schuko 220-250V 10A 2P+T e magnetotermico 2P 230 AC 10A cablati



Armadio dim. mm 561x726x800 H (27x36 EH)

ART.			
M BI A284 CO 10 13 04	750 mm	key	800
M BI A384 CO 10 13 04	800 mm	key	800
M BI A284 E2 10 13 04	750 mm	code	800
M BI A384 E2 10 13 04	800 mm	code	800



Piano inferiore in Multiplex ART. F BI 1210 02 01
Dimensioni mm 1220x612x25 H
Portata 130 kg

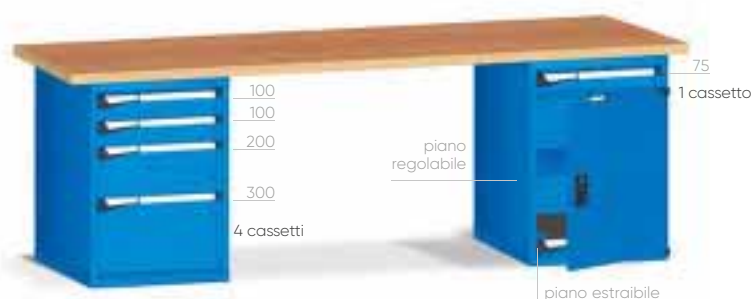

Armadio dim. mm 561x726x800 H (27x36 EH)

ART.			
M BI A284 CO 10 28 04	750 mm	key	800
M BI A384 CO 10 28 04	800 mm	key	800
M BI A284 T2 10 28 04	750 mm	code	800
M BI A384 T2 10 28 04	800 mm	code	800



Piano inferiore in Multiplex ART. F BI 1210 02 01
Dimensioni mm 1220x612x25 H
Portata 130 kg



ART. M BI A284 CO 14 AD 34





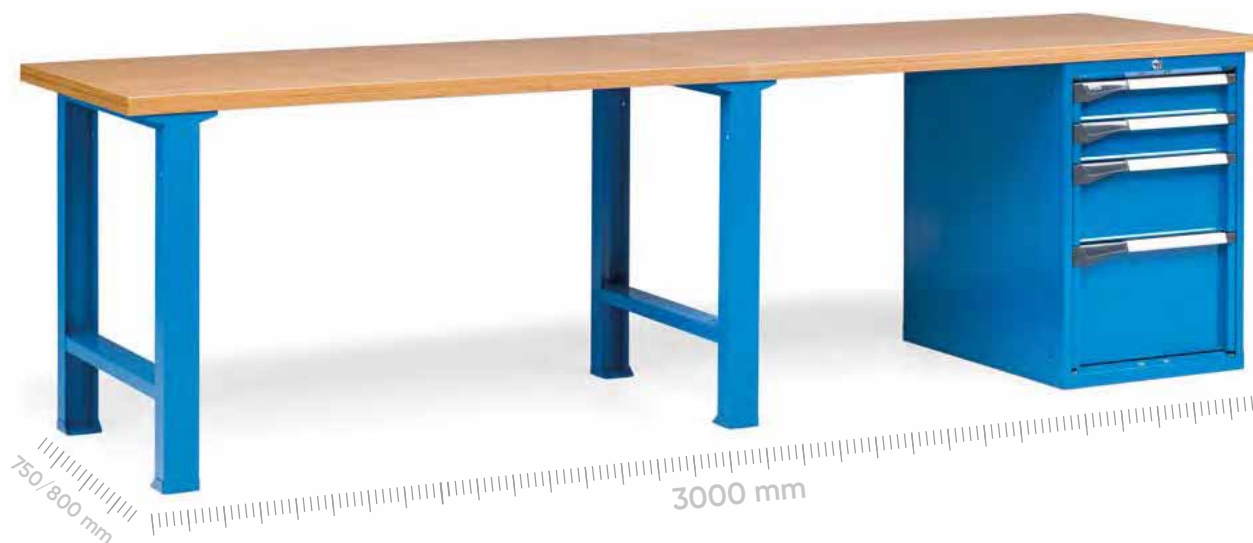





Banco serie Master con 1 armadio a 4 cassettei
 (H frontale mm 2x100 - 1x200 - 1x300) + 1 gamba H 800 mm
 3 montanti H 936 mm
 2 pannelli forati mm 973x304 H + 1 mm 1458x304 H
 1 mensola mm 955x320 + 1 mm 1440x220 + 1 mm 1440x320
 1 piano inferiore
 Dim.mm 2500x750x840 H
 COLORE ACCIAIO BLU RAL 5010
 COLORE PLASTICHE RED CARPET

ESCLUSI UTENSILI, GANCI E CONTENITORI



● **ART. M BI A498 CO 10 16 04**
H = 840 mm - 4 cassetti

Gamma colori ACCIAIO

									
GRIGIO RAL 7000 .01	VERDE RAL 6011 .02	BLU RAL 5012 .04	GRIGIO RAL 7035 .08	BIANCO GRIGIASTRO RAL 9002 .1F	ROSSO RUBINO RAL 3003 .1G	BLU GENZIANA RAL 5010 .34	BIANCO PURO RAL 9010 .35	GRIGIO ANTRACITE RAL 7016 .39	BLU CAPRI RAL 5019 .48

Gamma colori
PLASTICHE



DARK GREY
.MO

LEGENDA



PROFONDITÀ



CHIUSURA
BANCO



PORTATA
BANCO



LE PORTATE SONO NETTE E SI RIFERISCONO A PESI UNIFORMEMENTE DISTRIBUITI.

PIANO IN MULTIPLEX SPESSORE 50 mm



ART.				
M BI A498 00 00 01 04	750 mm	-	800	
M BI A598 00 00 01 04	800 mm	-	800	

Piano inferiore in Multiplex ART. F BI 2690 00 00
Dimensioni mm 2840x612x25 H
Portata 210 kg



3 cassetti

Armadio dim. mm 561x726x400 H (27x36 EH)

ART.				
M BI A498 C0 10 10 04	750 mm	key	800	
M BI A598 C0 10 10 04	800 mm	key	800	
M BI A498 E2 10 10 04	750 mm	code	800	
M BI A598 E2 10 10 04	800 mm	code	800	

Piano inferiore in Multiplex ART. F BI 2690 00 00
Dimensioni mm 2840x612x25 H
Portata 210 kg



3 cassetti

3 cassetti

Armadio dim. mm 561x726x400 h (27x36 EH)

ART.				
M BI A498 C0 10 61 04	750 mm	key	800	
M BI A598 C0 10 61 04	800 mm	key	800	
M BI A498 E2 10 61 04	750 mm	code	800	
M BI A598 E2 10 61 04	800 mm	code	800	

Piano inferiore in Multiplex ART. F BI 2690 00 00
Dimensioni mm 2840x612x25 H
Portata 210 kg



4 cassetti

Armadio dim. mm 561x726x800 H (27x36 EH)

ART.				
M BI A498 C0 10 16 04	750 mm	key	800	
M BI A598 C0 10 16 04	800 mm	key	800	
M BI A498 E2 10 16 04	750 mm	code	800	
M BI A598 E2 10 16 04	800 mm	code	800	

Piano inferiore in Multiplex ART. F BI 2510 01 01
Dimensioni mm 2275x612x25 H
Portata 210 kg



Armadio dim. mm 561x726x800 H (27x36 EH)

ART.			
M BI A498 CO 10 30 04	750 mm	key	800
M BI A598 CO 10 30 04	800 mm	key	800
M BI A498 E2 10 30 04	750 mm	code	800
M BI A598 E2 10 30 04	800 mm	code	800



Piano inferiore in Multiplex ART. F BI 2510 01 01
Dimensioni mm 2280x612x25 H
Portata 210 kg



Armadio dim. mm 561x726x800 h (27x36 EH)

ART.			
M BI A498 CO 10 28 04	750 mm	key	1500
M BI A598 CO 10 28 04	800 mm	key	1500
M BI A498 T2 10 28 04	750 mm	code	1500
M BI A598 T2 10 28 04	800 mm	code	1500



Piano inferiore in Multiplex ART. F BI 1710 02 01
Dimensioni mm 1710x612x25 h
Portata 360 kg



Armadio dim. mm 561x726x800 H (27x36 EH)

ART.			
M BI A498 CO 10 58 04	750 mm	key	800
M BI A598 CO 10 58 04	800 mm	key	800
M BI A498 E2 10 58 04	750 mm	code	800
M BI A598 E2 10 58 04	800 mm	code	800

Con armadio completo di 4 prese Schuko 220-250V 10A 2P+T e magnetotermico 2P 230 AC 10A cablati



Armadio dim. mm 561x726x800 H (27x36 EH)

ART.			
M BI A498 CO 10 63 04	750 mm	key	1500
M BI A598 CO 10 63 04	800 mm	key	1500
M BI A498 E2 10 63 04	750 mm	code	1500
M BI A598 E2 10 63 04	800 mm	code	1500

Con armadio completo di morsa da 120 mm a scomparsa

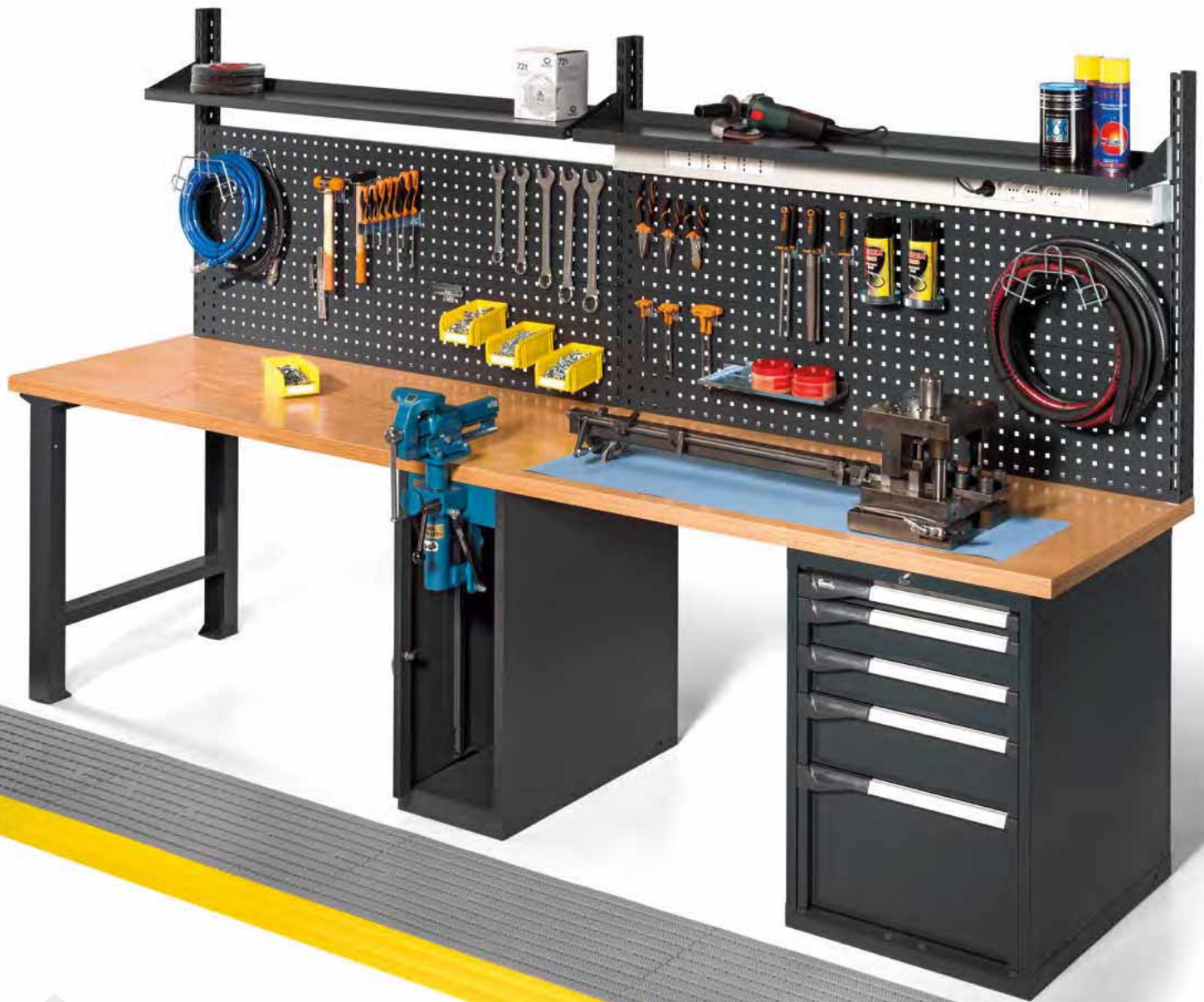

ART. M BI A598 CO 10 AE 39

Banco serie Master con 1 armadio a 5 cassetti
(H frontale mm 1x50 - 2x100 - 1x150 - 1x300)
1 gamba H 800 mm
1 armadio con morsa ribaltabile H 800 mm
3 montanti H 936 mm
4 pannelli forati mm 1458x304 H
2 mensole mm 1440x320
Dim.mm 3000x800x850 H
COLORE ACCIAIO GRIGIO RAL 7016
COLORE PLASTICHE DARK GREY

ESCLUSI UTENSILI, GANCI, CONTENITORI, CANALETTA
E TAPPETO

27x36 EH

MATERIALE DI SEPARAZIONE

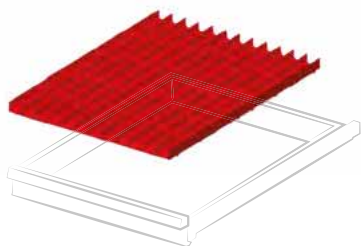

ART. per altezza frontale mm

F FH 8605 01 00 50 - 300

Set composto da: 12 divisori 4 canali, 50 divisori trasversali 36 mm

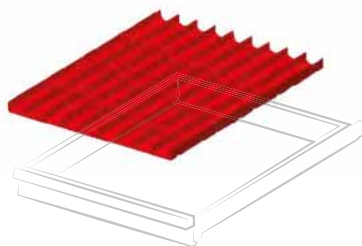

ART. per altezza frontale mm

F FH 8605 06 00 50 - 300

Set composto da: 12 divisori 3 canali, 27 divisori trasversali 47 mm

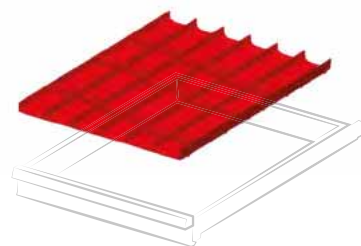

ART. per altezza frontale mm

F FH 8605 04 00 50 - 300

Set composto da: 12 divisori 2 canali, 18 divisori trasversali 73 mm

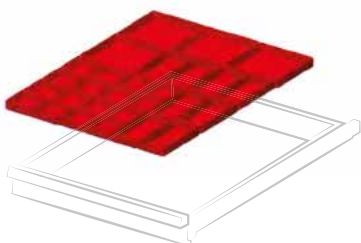

ART. per altezza frontale mm

F FH 8605 17 00 50

F FH 8607 17 00 75

Set composto da: 16 cassette divisorio 75x75 mm, 8 cassette divisorio 150x75 mm, 4 cassette divisorio 150x150 mm

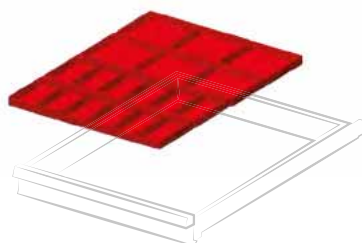

ART. per altezza frontale mm

F FH 8605 18 00 50

F FH 8607 18 00 75

F FH 8610 18 00 100 - 125

Set composto da: 12 cassette divisorio 150x75 mm, 6 cassette divisorio 150x150 mm

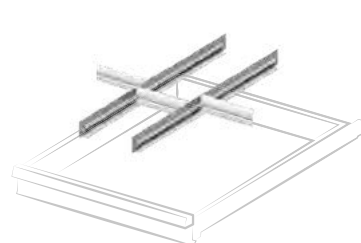

ART. per altezza frontale mm

F FH 8605 08 00 50

F FH 8607 08 00 75

F FH 8610 08 00 100 - 125

F FH 8615 08 00 150

F FH 8620 08 00 200 - 250

F FH 8630 08 00 300

Set composto da: 2 divisori longitudinali fessurati 610 mm, 3 divisori trasversali 149 mm

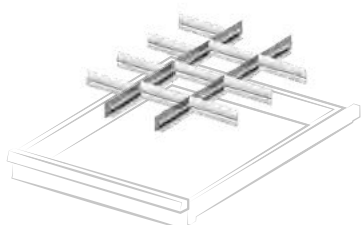

ART. per altezza frontale mm

F FH 8605 09 00 50

F FH 8607 09 00 75

F FH 8610 09 00 100 - 125

F FH 8615 09 00 150

F FH 8620 09 00 200 - 250

Set composto da: 2 divisori longitudinali fessurati 610 mm, 10 divisori trasversali 149 mm

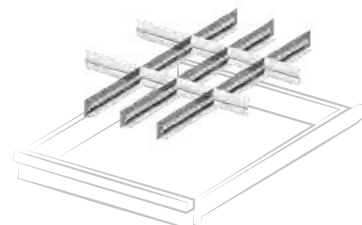

ART. per altezza frontale mm

F FH 8605 10 00 50

F FH 8607 10 00 75

F FH 8610 10 00 100 - 125

F FH 8615 10 00 150

Set composto da: 3 divisori longitudinali fessurati 610 mm, 6 divisori trasversali 98 mm, 2 divisori trasversali 149 mm

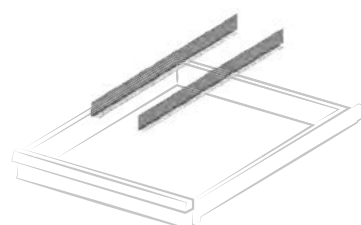

ART. per altezza frontale mm

F FH 8605 13 00 50

F FH 8607 13 00 75

F FH 8610 13 00 100 - 125

F FH 8615 13 00 150

F FH 8620 13 00 200 - 250

F FH 8630 13 00 300

Set composto da: 2 divisori longitudinali non fessurati 610 mm

CONFIGURA IL CASSETTO FAMI CON UTENSILI BETA

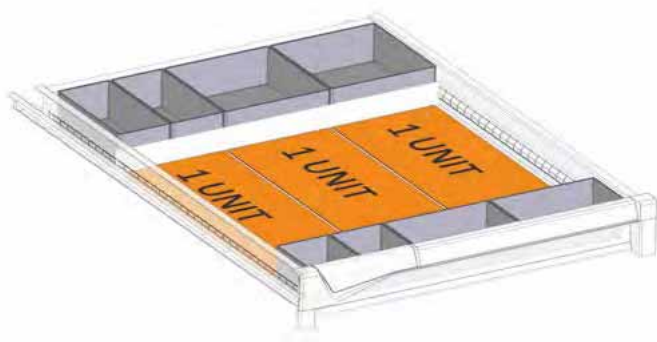

ART. F FH 0907 50 07

Set di predisposizione cassetto per termoformati Beta composto da:

- n. 2 F HC 6071 00 07
- n. 4 F HC 6471 00 07
- n. 2 F HC 6871 00 07
- n. 1 F HA 1120 00 99
- n. 1 F HA 2120 00 99

1 unit = 1 termoformato Beta 367x147 mm

2 unit = 1 termoformato Beta 367x294 mm

ESEMPI DI UTILIZZO TERMOFORMATO

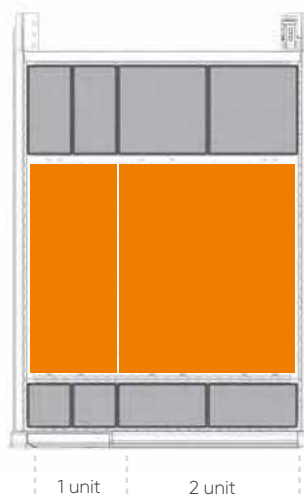
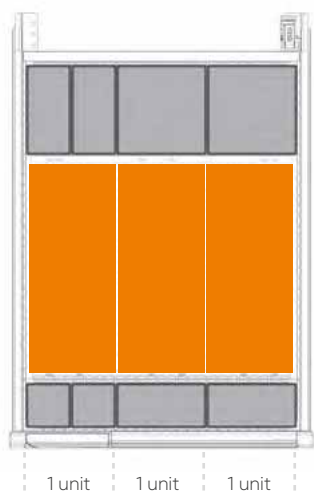

CONFIGURA IL TUO BANCO

ART. M BI A270 CO 11 AF 1F

Banco serie Master con 2 armadi H 850 mm
a 6 cassetti

(H frontale mm 1x50 - 2x100 - 2x150 - 1x200)

3 montanti H 1240 mm

2 pannelli forati mm 973x304 H

1 mensola mm 955x320

1 armadio a tapparella

Dim. mm 2000x750x890 H

COLORE ACCIAIO BIANCO GRIGIASTRO RAL 9002

COLORE PLASTICHE BLUE MEDITERRANEAN

ESCLUSI UTENSILI, GANCI, CONTENITORI, ARROTOLATORE
E LAMPADA



PORTATA PIANO DI LAVORO

LUNGHEZZA 1300 mm



TIPO DI PIANO	SPESSORE mm	kg	kg
Multiplex	40	1200	1500
Multiplex	50	1500	1500
3 STRATI INCROCIATI	50	1500	1500
Laminato con massello/	40	1200	1500
Laminato	50	1500	1500

PORTATA PIANO DI LAVORO LUNGHEZZA 1500 mm



TIPO DI PIANO	SPESSORE mm	kg	kg	kg
Multiplex	40	800	1500	1500
Multiplex	50	1000	1500	1500
3 STRATI INCROCIATI	50	1000	1500	1500
Laminato con massello/	40	800	1500	1500
Laminato	50	1000	1500	1500

PORTATA PIANO DI LAVORO LUNGHEZZA 2000 mm



TIPO DI PIANO	SPESSORE mm	kg	kg	kg
Multiplex	40	500	800	1500
Multiplex	50	700	1000	1500
3 STRATI INCROCIATI	50	700	1000	1500
Laminato con massello/	40	500	800	1500
Laminato	50	700	1000	1500

PORTATA PIANO DI LAVORO LUNGHEZZA 2500 mm



TIPO DI PIANO	SPESSORE mm	kg	kg	kg
Multiplex	40	800	350	800
Multiplex	50	1000	500	1000
3 STRATI INCROCIATI	50	1000	500	1000
Laminato con massello/	40	800	350	800
Laminato	50	1000	500	1000

PORTATA PIANO DI LAVORO LUNGHEZZA 3000 mm



TIPO DI PIANO	SPESSORE mm	kg	kg	kg	kg
Multiplex	50	800	800	1500	350
3 STRATI INCROCIATI	50	800	800	1500	350
Laminato con massello/	50	800	800	1500	350
Laminato	50	800	800	1500	350

PIANI

MULTIPLEX
DI FAGGIO



3 STRATI
INCROCIATI DI
FAGGIO



MULTIPLEX
CON LAMINATO E
BORDI IN MASSELLO



GRIGIO

MULTIPLEX
CON LAMINATO E
BORDI IN MASSELLO

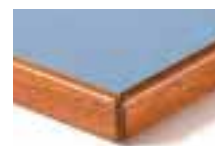

BLU

SPESSORE mm	DIM. mm	ART.	ART.	ART.	ART.
30	1024x750	F BI A014 02 00	-	-	-
	1024x800	-	-	-	-
	1300x750	-	-	-	-
	1300x800	-	-	-	-
	1500x750	F BI A042 02 00	-	-	-
	1500x800	F BI A142 00 00	-	F BH A142 00 08	F BH A142 00 04
	2000x750	F BI A070 02 00	-	-	-
	2000x800	F BI A170 00 00	-	F BH A170 00 08	F BH A170 00 04
	2500x750	F BI A084 02 00	-	-	-
	2500x800	-	-	-	-
	3000x750	-	-	-	-
	3000x800	-	-	-	-
40	1024x750	F BI A214 00 00	-	F BH A214 00 08	F BH A214 00 04
	1024x800	-	-	-	-
	1300x750	F BI A228 00 00	-	F BH A228 00 08	F BH A228 00 04
	1300x800	F BI A328 00 00	-	F BH A328 00 08	F BH A328 00 04
	1500x750	F BI A242 00 00	-	F BH A242 00 08	F BH A242 00 04
	1500x800	F BI A342 00 00	-	F BH A342 00 08	F BH A342 00 04
	2000x750	F BI A270 00 00	-	F BH A270 00 08	F BH A270 00 04
	2000x800	F BI A370 00 00	-	F BH A370 00 08	F BH A370 00 04
	2500x750	F BI A284 00 00	-	F BH A284 00 08	F BH A284 00 04
	2500x800	F BI A384 00 00	-	F BH A384 00 08	F BH A384 00 04
50	1024x750	-	-	-	-
	1024x800	F BI A514 00 00	-	F BH A514 00 08	F BH A514 00 04
	1300x750	F BI A428 00 00	F BK A428 00 00	F BH A428 00 08	F BH A428 00 04
	1300x800	F BI A528 00 00	F BK A528 00 00	F BH A528 00 08	F BH A528 00 04
	1500x750	F BI A442 00 00	F BK A442 00 00	F BH A442 00 08	F BH A442 00 04
	1500x800	F BI A542 00 00	F BK A542 00 00	F BH A542 00 08	F BH A542 00 04
	2000x750	F BI A470 00 00	F BK A470 00 00	F BH A470 00 08	F BH A470 00 04
	2000x800	F BI A570 00 00	F BK A570 00 00	F BH A570 00 08	F BH A570 00 04
	2500x750	F BI A484 00 00	F BK A484 00 00	F BH A484 00 08	F BH A484 00 04
	2500x800	F BI A584 00 00	F BK A584 00 00	F BH A584 00 08	F BH A584 00 04
	3000x750	F BI A498 00 00	F BK A498 00 00	F BH A498 00 08	F BH A498 00 04
	3000x800	F BI A598 00 00	F BK A598 00 00	F BH A598 00 08	F BH A598 00 04

MULTIPLEX
RIVESTITO IN
LAMINATO



GRIGIO

MULTIPLEX
RIVESTITO IN
LAMINATO



BLU

PIANI ESD
A RICHIESTA



ART.	ART.
-	-
-	-
-	-
-	-
-	-
F BH B142 00 08	F BH B142 00 04
-	-
F BH B170 00 08	F BH B170 00 04
-	-
-	-
-	-
F BH B214 00 08	F BH B214 00 04
-	-
F BH B228 00 08	F BH B228 00 04
F BH B328 00 08	F BH B328 00 04
F BH B242 00 08	F BH B242 00 04
F BH B342 00 08	F BH B342 00 04
F BH B270 00 08	F BH B270 00 04
F BH B370 00 08	F BH B370 00 04
F BH B284 00 08	F BH B284 00 04
F BH B384 00 08	F BH B384 00 04
-	-
F BH B514 00 08	F BH B514 00 04
F BH B428 00 08	F BH B428 00 04
F BH B528 00 08	F BH B528 00 04
F BH B442 00 08	F BH B442 00 04
F BH B542 00 08	F BH B542 00 04
F BH B470 00 08	F BH B470 00 04
F BH B570 00 08	F BH B570 00 04
F BH B484 00 08	F BH B484 00 04
F BH B584 00 08	F BH B584 00 04
F BH B498 00 08	F BH B498 00 04
F BH B598 00 08	F BH B598 00 04



LAMINATO
SPESORE 9/10 mm



COPERTURE



COPERTURA SPESSORE 12/10 mm IN ACCIAIO MICROFIORATO PER PIANI IN MULTIPLEX PROVISTA DI SAGOMATURA H 20 mm ANTERIORE E POSTERIORE A "L" RESISTENTE ALL'ABRASIONE E ALL'EFFETTO DEGLI OLI E DEI GRASSI

DIM. mm	ART. SPESSORE 20 mm
1024x750	F BL 7900 00 99
1024x800	F BL 7905 00 99
1300x750	F BL 7915 00 99
1300x800	F BL 7920 00 99
1500x750	F BL 7930 00 99
1500x800	F BL 7935 00 99
2000x750	F BL 7960 00 99
2000x800	F BL 7965 00 99
2500x750	F BL 7975 00 99
2500x800	F BL 7980 00 99
3000x750	F BL 7990 00 99
3000x800	F BL 7995 00 99



COPERTURA IN ACCIAIO 8/10 mm RIVESTITA IN GOMMA ANTIOLIO 12/10 - 15/10 mm PER PIANI IN MULTIPLEX PROVISTA DI SAGOMATURA H 20 mm ANTERIORE E POSTERIORE A "L"

DIM. mm	ART. SPESSORE 20 mm
1024x750	F BL 2230 00 07
1024x800	F BL 2235 00 07
1300x750	F BL 2245 00 07
1300x800	F BL 2250 00 07
1500x750	F BL 2260 00 07
1500x800	F BL 2265 00 07
2000x750	F BL 2290 00 07
2000x800	F BL 2295 00 07
2500x750	F BL 2305 00 07
2500x800	F BL 2310 00 07
3000x750	F BL 2320 00 07
3000x800	F BL 2325 00 07







ART. F BL 9021 00 00
 SET PREMONTAGGIO PER GAMBA/ARMADIO
 COMPRESIVO DI FORATURA E VITI DI FISSAGGIO



GAMBA

ART.	Dim. mm
M 03 G070 0000 00 04	80x726x700 H
M 03 G080 0000 00 04	80x726x800 H
M 03 G085 0000 00 04	80x726x850 H



GAMBA REGOLABILE

ART.	Dim. mm
M 03 G110 0000 00	80x726x700/1100 H

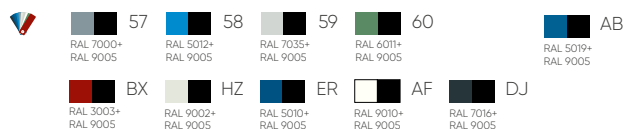

ARMADIO CON MORSA RIBALTABILE

ART.	Dim. mm
M 03 M080 0101 00 04	312x726x800 H



ARMADIO PER ALLACCIAMENTI

ART.	Dim. mm
M 03 E070 0100 00 04	190x726x700 H
M 03 E080 0100 00 04	190x726x800 H



ZOCCOLO 50 mm

ART.	Dim. mm
M 03 Z050 4000 00 04	312x726x50 H



ZOCCOLO 50 mm

ART.	Dim. mm
M 03 Z050 3000 00 04	190x726x50 H



ARROTOLATORE SINGOLO ARIA COMPRESSA CON FILTRO

ART.	H armadio mm
F BL 9670 70 07	700
F BL 9670 80 07	800

L'IMPIANTO PNEUMATICO É COMPOSTO DA:

- 1 entrata fissa posteriore con tubo Ø 10 mm e finale (da 1/4") a spillo (Ø 9-12 mm) per l'aggancio alla rete pneumatica tramite prolunga (non fornita di serie)
 - 1 arrotolatore anteriore con 4 metri di tubo diametro interno di 5,5 mm con un attacco finale filettato da 1/4" per l'aggancio dell'utensile, capacità di circa 9 litri al secondo*
 - 1 uscita fissa anteriore con tubo Ø 10 mm e finale filettato da 1/4" completa di tappo, capacità di circa 11 litri al secondo*
 - 1 gruppo filtro riduttore con manometro il quale può essere utilizzato con una pressione massima di 10 bar, la sua capacità è di circa 11 litri al secondo* con una pressione di utilizzo pari a 6,3 bar
- *la capacità può variare a seconda delle caratteristiche tecniche della rete pneumatica a cui l'impianto Fami viene allacciato



ARROTOLATORE SINGOLO ARIA COMPRESSA

ART.	H armadio mm
F BL 9660 70 07	700
F BL 9660 80 07	800

L'IMPIANTO PNEUMATICO É COMPOSTO DA:

- 1 uscita fissa posteriore con tubo Ø 10 mm e finale (da 3/8") a spillo (Ø 9-12 mm) per l'aggancio alla rete pneumatica tramite prolunga (non fornita di serie)
- 1 arrotolatore anteriore con 4 metri di tubo diametro interno di 5,5 mm con un attacco finale filettato da 1/4" per l'aggancio dell'utensile
- 1 uscita fissa anteriore con tubo Ø 10 mm e finale filettato da 3/8" completa di tappo

N.B. TUTTI I RACCORDI (ESCLUSI QUELLI DELL'ARROTOLATORE) SONO DA 3/8"



APPLICABILE SOLO ALL'ARMADIO PER ALLACCIAMENTI



IMPIANTO ELETTRICO

ART.	D	F	GB	I	CH	IL
F BL 9620 10 00	4	-	-	-	-	-
F BL 9620 20 00	-	4	-	-	-	-
F BL 9620 30 00	-	-	3	-	-	-
F BL 9620 40 00	-	-	-	4	-	-
F BL 9620 50 00	-	-	-	-	4	-
F BL 9620 70 00	-	-	-	-	-	4

Gli armadi per allacciamenti vengono forniti di serie con una porta laterale completa di serratura a cilindro con due chiavi.

In questo armadio può essere montato un impianto elettrico e/o un impianto pneumatico. La scatola porta prese viene inoltre fornita di serie con un magnetotermico 2P 230V AC 10A e collegata (tramite una robusta guaina) a una presa industriale posteriore piatta con chiusura a ghigliottina 220-240V 16A 2P+T. Grado di protezione dell'impianto IP30.

L'IMPIANTO ELETTRICO É COSTITUITO DA UNA SCATOLA PORTA PRESE FORNITA CON 6 TIPI DI ALLESTIMENTO:

- 4 prese italiane bivalenti 220-250V 10A 2P+T
- 4 prese Schuko 220-250V 10A 2P+T
- 4 prese francesi 220-250V 10A 2P+T
- 3 prese inglesi 220-250V 10A 2P+T
- 4 prese svizzere 220-250V 10A 2P+T
- 4 prese israeliane 220-250V 10A 2P+T



ART. F BL 9011 00 00
 SET PREMONTAGGIO PER GAMBA/ARMADIO
 COMPRESIVO DI FORATURA E VITI DI FISSAGGIO
ART. M 00 T030 MD 00 FO 00
 FORATURA PIANO SUPERIORE DELL'ARMADIO
 (ESCLUSO ART. M 23 A020 C0 10 05 04 -
 M 23 A030 C0 10 06 04)

H 200 mm



27x36 EH

ART.			
M 23 A020 C0 10 05 04	50-75-100	100-96-92%	key

ARMADIO SENZA CASSETTO ART. **M 23 A020 C0 00 00 04**
 CASSETTO CON PLASTICHE DARK GREY ART. **M 23 C100 02 10 0F 04**
 CASSETTO SENZA PLASTICHE DARK GREY ART. **M 23 C100 02 00 0F 04**

H 300 mm



27x36 EH

ART.			
M 23 A030 C0 10 06 04	50-75-100	100-96-92%	key

ARMADIO SENZA CASSETTO ART. **M 23 A030 C0 00 00 04**
 CASSETTO CON PLASTICHE DARK GREY ART. **M 23 C200 02 10 0F 04**
 CASSETTO SENZA PLASTICHE DARK GREY ART. **M 23 C200 02 00 0F 04**

H 400 mm



27x36 EH

ART.			
M 23 A040 C0 10 01 04	50-75-100	100-96-92%	key
M 23 A040 E2 10 01 04	50-75-100	100-96-92%	code

H 800 mm



27x36 EH

ART.			
M 23 A080 C0 10 55 04	50-75-100	100-96-92%	key
M 23 A080 E2 10 55 04	50-75-100	100-96-92%	code

H 800 mm



27x36 EH

ART.			
M 23 A080 C0 10 54 04	50-75-100	100-96-92%	key
M 23 A080 E2 10 54 04	50-75-100	100-96-92%	code

H 800 mm



27x36 EH

ART.		kg			
M 23 A080 C0 10 56 04		50-75-100	100-96-92%	key	
M 23 A080 E2 10 56 04		50-75-100	100-96-92%	code	

H 800 mm



27x36 EH

ART.		kg			
M 23 A080 C0 10 66 04		50-75-100	100-96-92%	key	
M 23 A080 E2 10 66 04		50-75-100	100-96-92%	code	

H 800 mm



27x36 EH

ART.		kg			
M 23 A080 C0 10 69 04		50-75-100	100-96-92%	key	
M 23 A080 T2 10 69 04		50-75-100	100-96-92%	code	

H 800 mm



27x36 EH

ART.		kg			
M 23 A080 C0 10 57 04		50-75-100	100-96-92%	key	
M 23 A080 T2 10 57 04		50-75-100	100-96-92%	code	



ZOCCOLO mm 50-100 H

ART.		Dim. mm	
M 23 Z050 00 00 00 04		559x725x50 H	
M 23 Z100 00 00 00 04		559x725x100 H	

4 COLORI

ESTRAIBILITÀ CASSETTI 87%

IMPIANTI ELETTRICI E PNEUMATICI

PERSONALIZZABILI

VASTA GAMMA DI PIANI

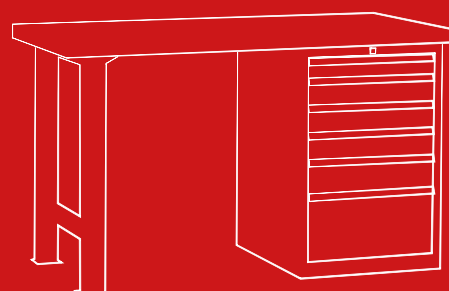



WORK STANDARD

CARATTERISTICHE TECNICHE

COLORI BANCO

 Gamma colori ACCIAIO



GRIGIO
RAL 7000
.01



VERDE
RAL 6011
.02



BLU
RAL 5012
.04



GRIGIO
RAL 7035
.08

MULTIPLEX
DI FAGGIO



3 STRATI
INCROCIATI
DI FAGGIO



MULTIPLEX
CON LAMINATO
E BORDI IN
MASSELLO



MULTIPLEX
CON LAMINATO
E BORDI IN
MASSELLO



MULTIPLEX
RIVESTITO IN
LAMINATO



MULTIPLEX
RIVESTITO IN
LAMINATO



PARTICOLARE
DEL CUSCINETTO

ARMADI A CASSETTI

I cassetti sono forniti con estrazione semplice (pari al 87%) su cuscinetti a sfera ad alta resistenza. Il fondo forato e le pareti fessurate con passo 17 mm permettono un facile inserimento e fissaggio (tramite viti) dei divisori in metallo.



87% = 70 kg

H FRONTALE 50 mm
87% = 50 kg

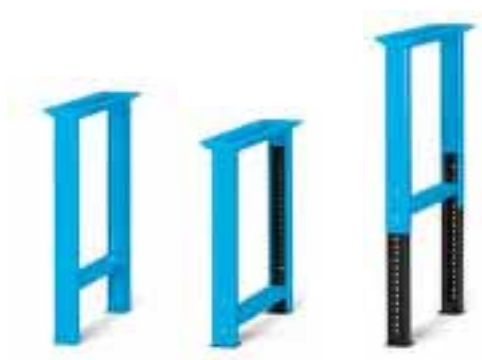

GAMBE FISSE E REGOLABILI

Le gambe sono costruite in lamiera di acciaio con fori sulla parte superiore per il fissaggio al piano di lavoro e sulle piastre di base per il fissaggio a pavimento. Vengono prodotte in 3 differenti altezze (700-800-850 mm) ed è disponibile una versione regolabile in altezza da 750 a 1100 mm tramite due allunghe forate a passo 25 mm (regolazione mediante fissaggio a vite).

SU RICHIESTA POSSONO ESSERE INSERITE LE
PARETI ATTREZZATE



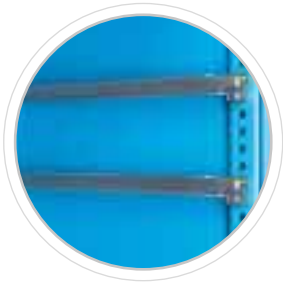

Le pareti sono munite di 4 montanti forati in modo da permettere l'inserimento delle guide dei cassetti o dei piani estraibili.



ASTA ANTIRIBALTAMENTO

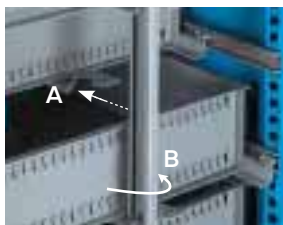

L'asta di chiusura funge da sistema antiribaltamento nel momento in cui il cassetto viene estratto. Il gancio posteriore del cassetto (A) fa ruotare in posizione di chiusura l'asta posteriore (B). In questo modo è impedita all'operatore l'estrazione simultanea di più cassetti, evitando un pericoloso spostamento del peso verso l'esterno.

CHIUSURA CON CILINDRO

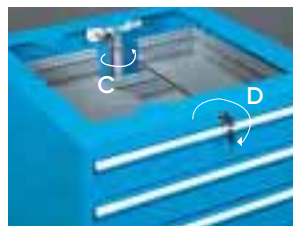

La chiusura con cilindro è collegata tramite un'asta quadra (C) al gruppo di chiusura posteriore, composto da un elemento rotante e dall'asta antiribaltamento. Girando la chiave (D) si aziona il sistema a camme del gruppo di chiusura che fa ruotare l'asta.

FORNITA DI SERIE CON 2 CHIAVI

PIANI AGGIUNTIVI ALLA CASSETTIERA REGOLABILI IN ALTEZZA

All'interno della cassetteria si possono inserire dei piani regolabili in altezza con portata di 150 kg.



Oltre ai piani regolabili, si possono inserire dei piani estraibili su cuscinetti a sfera con portata di 100 kg.



CONFIGURA IL TUO BANCO



PORTATA PIANO DI LAVORO
LUNGHEZZA 1300 mm



TIPO DI PIANO	SPESSORE mm	kg	kg
Multiplex	40	1200	1500
Multiplex	50	1500	1500
3 STRATI INCROCIATI	50	1500	1500
Laminato con massello/	40	1200	1500
Laminato	50	1500	1500

PORTATA PIANO DI LAVORO LUNGHEZZA 1500 mm



TIPO DI PIANO	SPESSORE mm	kg	kg	kg
Multiplex	40	800	1500	1500
Multiplex	50	1000	1500	1500
3 STRATI INCROCIATI	50	1000	1500	1500
Laminato con massello/	40	800	1500	1500
Laminato	50	1000	1500	1500

PORTATA PIANO DI LAVORO LUNGHEZZA 2000 mm



TIPO DI PIANO	SPESSORE mm	kg	kg	kg
Multiplex	40	500	800	1500
Multiplex	50	700	1000	1500
3 STRATI INCROCIATI	50	700	1000	1500
Laminato con massello/	40	500	800	1500
Laminato	50	700	1000	1500

PORTATA PIANO DI LAVORO LUNGHEZZA 2500 mm



TIPO DI PIANO	SPESSORE mm	kg	kg	kg
Multiplex	40	800	350	800
Multiplex	50	1000	500	1000
3 STRATI INCROCIATI	50	1000	500	1000
Laminato con massello/	40	800	350	800
Laminato	50	1000	500	1000

PORTATA PIANO DI LAVORO LUNGHEZZA 3000 mm



TIPO DI PIANO	SPESSORE mm	kg	kg	kg	kg
Multiplex	50	800	800	1500	350
3 STRATI INCROCIATI	50	800	800	1500	350
Laminato con massello/	50	800	800	1500	350
Laminato	50	800	800	1500	350

PIANI

MULTIPLEX
DI FAGGIO



3 STRATI INCROCIATI
DI FAGGIO



MULTIPLEX
CON LAMINATO E
BORDI IN MASSELLO



GRIGIO

MULTIPLEX
CON LAMINATO E
BORDI IN MASSELLO



BLU

SPESSORE mm	DIM. mm	ART.	ART.	ART.	ART.
30	1024x750	F BI A014 02 00	-	-	-
	1024x800	-	-	-	-
	1300x750	-	-	-	-
	1300x800	-	-	-	-
	1500x750	F BI A042 02 00	-	-	-
	1500x800	F BI A142 00 00	-	F BH A142 00 08	F BH A142 00 04
	2000x750	F BI A070 02 00	-	-	-
	2000x800	F BI A170 00 00	-	F BH A170 00 08	F BH A170 00 04
	2500x750	F BI A084 02 00	-	-	-
	2500x800	-	-	-	-
	3000x750	-	-	-	-
	3000x800	-	-	-	-
40	1024x750	F BI A214 00 00	-	F BH A214 00 08	F BH A214 00 04
	1024x800	-	-	-	-
	1300x750	F BI A228 00 00	-	F BH A228 00 08	F BH A228 00 04
	1300x800	F BI A328 00 00	-	F BH A328 00 08	F BH A328 00 04
	1500x750	F BI A242 00 00	-	F BH A242 00 08	F BH A242 00 04
	1500x800	F BI A342 00 00	-	F BH A342 00 08	F BH A342 00 04
	2000x750	F BI A270 00 00	-	F BH A270 00 08	F BH A270 00 04
	2000x800	F BI A370 00 00	-	F BH A370 00 08	F BH A370 00 04
	2500x750	F BI A284 00 00	-	F BH A284 00 08	F BH A284 00 04
	2500x800	F BI A384 00 00	-	F BH A384 00 08	F BH A384 00 04
50	1024x750	-	-	-	-
	1024x800	F BI A514 00 00	-	F BH A514 00 08	F BH A514 00 04
	1300x750	F BI A428 00 00	F BK A428 00 00	F BH A428 00 08	F BH A428 00 04
	1300x800	F BI A528 00 00	F BK A528 00 00	F BH A528 00 08	F BH A528 00 04
	1500x750	F BI A442 00 00	F BK A442 00 00	F BH A442 00 08	F BH A442 00 04
	1500x800	F BI A542 00 00	F BK A542 00 00	F BH A542 00 08	F BH A542 00 04
	2000x750	F BI A470 00 00	F BK A470 00 00	F BH A470 00 08	F BH A470 00 04
	2000x800	F BI A570 00 00	F BK A570 00 00	F BH A570 00 08	F BH A570 00 04
	2500x750	F BI A484 00 00	F BK A484 00 00	F BH A484 00 08	F BH A484 00 04
	2500x800	F BI A584 00 00	F BK A584 00 00	F BH A584 00 08	F BH A584 00 04
	3000x750	F BI A498 00 00	F BK A498 00 00	F BH A498 00 08	F BH A498 00 04
	3000x800	F BI A598 00 00	F BK A598 00 00	F BH A598 00 08	F BH A598 00 04

MULTIPLEX
RIVESTITO IN
LAMINATO



GRIGIO

MULTIPLEX
RIVESTITO IN
LAMINATO



BLU

PIANI ESD
A RICHIESTA



ART.	ART.
-	-
-	-
-	-
-	-
-	-
F BH B142 00 08	F BH B142 00 04
-	-
F BH B170 00 08	F BH B170 00 04
-	-
-	-
-	-
F BH B214 00 08	F BH B214 00 04
-	-
F BH B228 00 08	F BH B228 00 04
F BH B328 00 08	F BH B328 00 04
F BH B242 00 08	F BH B242 00 04
F BH B342 00 08	F BH B342 00 04
F BH B270 00 08	F BH B270 00 04
F BH B370 00 08	F BH B370 00 04
F BH B284 00 08	F BH B284 00 04
F BH B384 00 08	F BH B384 00 04
-	-
F BH B514 00 08	F BH B514 00 04
F BH B428 00 08	F BH B428 00 04
F BH B528 00 08	F BH B528 00 04
F BH B442 00 08	F BH B442 00 04
F BH B542 00 08	F BH B542 00 04
F BH B470 00 08	F BH B470 00 04
F BH B570 00 08	F BH B570 00 04
F BH B484 00 08	F BH B484 00 04
F BH B584 00 08	F BH B584 00 04
F BH B498 00 08	F BH B498 00 04
F BH B598 00 08	F BH B598 00 04



LAMINATO
SPESORE 9/10 mm



COPERTURE

**COPERTURA SPESSORE 12/10 mm IN ACCIAIO MICROFIORATO PER PIANI IN MULTIPLEX
PROVVISTA DI SAGOMATURA H 20 mm ANTERIORE E POSTERIORE A "L"
RESISTENTE ALL'ABRASIONE E ALL'EFFETTO DEGLI OLI E DEI GRASSI**



DIM. mm	ART. SPESSORE 20 mm	
1024x750	F BL 7900 00 99	
1024x800	F BL 7905 00 99	
1300x750	F BL 7915 00 99	
1300x800	F BL 7920 00 99	
1500x750	F BL 7930 00 99	
1500x800	F BL 7935 00 99	
2000x750	F BL 7960 00 99	
2000x800	F BL 7965 00 99	
2500x750	F BL 7975 00 99	
2500x800	F BL 7980 00 99	
3000x750	F BL 7990 00 99	
3000x800	F BL 7995 00 99	

**COPERTURA IN ACCIAIO 8/10 mm RIVESTITA IN GOMMA ANTIOLIO 12/10 - 15/10 mm
PER PIANI IN MULTIPLEX PROVVISTA DI SAGOMATURA H 20 mm ANTERIORE E POSTERIORE A "L"**



DIM. mm	ART. SPESSORE 20 mm	
1024x750	F BL 2230 00 07	
1024x800	F BL 2235 00 07	
1300x750	F BL 2245 00 07	
1300x800	F BL 2250 00 07	
1500x750	F BL 2260 00 07	
1500x800	F BL 2265 00 07	
2000x750	F BL 2290 00 07	
2000x800	F BL 2295 00 07	
2500x750	F BL 2305 00 07	
2500x800	F BL 2310 00 07	
3000x750	F BL 2320 00 07	
3000x800	F BL 2325 00 07	





ART. F BL 9021 00 00
SET PREMONTAGGIO PER GAMBA/ARMADIO
COMPRESIVO DI FORATURA E VITI DI FISSAGGIO



ARMADIO PER ALLACCIAMENTI

ART.		Dim. mm
F BL 6125 01 04		190x726x800 H



ALLUNGA ARMADIO PER ALLACCIAMENTI 50 mm

ART.		Dim. mm
F BL 6655 00 04		189x726x50 H



ARROTOLATORE SINGOLO ARIA COMPRESSA

ART.	H armadio mm
F BL 9660 80 07	800

COLORE NERO



GAMBA

ART.		Dim. mm
F BL 6025 00 04		80x726x800 H
F BL 6040 00 04		80x726x850 H



GAMBA REGOLABILE

ART.		Dim. mm
F BL 6045 00 _ _		80x726x700/1100 H

57	58	59	60

L'IMPIANTO PNEUMATICO É COMPOSTO DA:

- 1 uscita fissa posteriore con tubo Ø 10 mm e finale (da 3/8") a spillo (Ø 9-12 mm) per l'aggancio alla rete pneumatica tramite prolunga (non fornita di serie)
- 1 arrotolatore anteriore con 4 metri di tubo diametro interno di 5,5 mm con un attacco finale filettato da 1/4" per l'aggancio dell'utensile
- 1 uscita fissa anteriore con tubo Ø 10 mm e finale filettato da 3/8" completa di tappo

N.B. TUTTI I RACCORDI (ESCLUSI QUELLI DELL'ARROTOLATORE) SONO DA 3/8"



APPLICABILE SOLO ALL'ARMADIO PER ALLACCIAMENTI



IMPIANTO ELETTRICO

ART.	D	F	GB	I	CH	IL
F BL 9620 10 00	4	-	-	-	-	-
F BL 9620 20 00	-	4	-	-	-	-
F BL 9620 30 00	-	-	3	-	-	-
F BL 9620 40 00	-	-	-	4	-	-
F BL 9620 50 00	-	-	-	-	4	-
F BL 9620 70 00	-	-	-	-	-	4

Gli armadi per allacciamenti vengono forniti di serie con una porta laterale completa di serratura a cilindro con due chiavi.

In questo armadio può essere montato un impianto elettrico e/o un impianto pneumatico. La scatola porta prese viene inoltre fornita di serie con un magnetotermico 2P 230V AC 10A e collegata (tramite una robusta guaina) a una presa industriale posteriore piatta con chiusura a ghigliottina 220-240V 16A 2P+T. Grado di protezione dell'impianto IP30.

L'IMPIANTO ELETTRICO È COSTITUITO DA UNA SCATOLA PORTA PRESE FORNITA CON 6 TIPI DI ALLESTIMENTO:

- 4 prese italiane bivalenti 220-250V 10A 2P+T
- 4 prese Schuko 220-250V 10A 2P+T
- 4 prese francesi 220-250V 10A 2P+T
- 3 prese inglesi 220-250V 10A 2P+T
- 4 prese svizzere 220-250V 10A 2P+T
- 4 prese israeliane 220-250V 10A 2P+T



ART. F BI B570 S1 08

Dim. mm 2000x800x900 H
COLORE GRIGIO RAL 7035
ESCLUSO UTENSILI E SET DI SUDDIVISIONE
DEI CASSETTI



ART. F BL 9011 00 00
 SET PREMONTAGGIO PER ARMADIO COMPRESIVO
 DI FORATURA E VITI DI FISSAGGIO

1 cassetto
 100



27x36 EH

ART.		Dim. mm	kg	
F DE 1010 01 04		565x725x155 H	60	87%

Chiusura laterale

1 cassetto
 200



27x36 EH

ART.		Dim. mm	kg	
F DE 1020 01 04		565x725x255 H	60	87%

Chiusura laterale

2 cassetti
 50
 150



27x36 EH

ART.		Dim. mm	kg	
F DE 1020 02 04		565x725x255 H	60	87%

Chiusura laterale

3 cassetti
 50
 100
 150



27x36 EH

ART.		Dim. mm	kg	
F DE 1030 02 04		565x725x355 H	60	87%

Chiusura laterale



ART. F BL 9011 00 00
SET PREMONTAGGIO PER GAMBA/ARMADIO COMPRESIVO
DI FORATURA E VITI DI FISSAGGIO

H 800 mm



27x36 EH

ART.



kg



F DD 1070 51 04

100

87%

key

Chiusura centrale

*portata massima 60 kg

H 800 mm



27x36 EH

ART.



kg



F DD 1070 52 04

100

87%

key

Chiusura centrale

*portata massima 80 kg

H 800 mm



27x36 EH

ART.



kg



F DD 1070 55 04

100

87%

key

Chiusura centrale

H 800 mm



27x36 EH

porta 425 mm

ART.



kg



F DD 1170 51 04

100

87%

key

Chiusura centrale

*portata massima 70 kg

ZOCCOLO

ART.

H zoccolo mm

F DD 9300 00 07

50

Dim. mm 564x701

Colore nero RAL 9005



ROBUSTI, VERSATILI, PERSONALIZZABILI

2 TIPOLOGIE DI PIANI, 2 COLORI

CASSETTI AD ESTRAZIONE SEMPLICE

CHIUSURA CON CILINDRO

VARIE POSSIBILITÀ DI COMBINAZIONI



WORK UP - ROL UP

CARATTERISTICHE TECNICHE

COLORI BANCO

2 colori per la parte metallica

RAL 5012

RAL 7035





BANCO PROGETTATO PER L'ERGONOMIA DELLA SEDUTA



PIANO INFERIORE AGGIUNTIVO

Il nuovo banco WORK / WORK-UP ha di serie un piano inferiore che funge anche da rinforzo al quale si può aggiungere un secondo per completare il piano di appoggio inferiore.

ACCESSORI

PANNELLO FORATO

PORTA ROTOLI

PORTA BOMBOLETTE



ALTEZZA REGOLABILE

Banco regolabile in altezza disponibile in due versioni:

- senza ruote da un'altezza minima di 740 mm ad un'altezza massima di 1110 mm
- con ruote Ø 125 mm in gomma antistrada sintetica da un'altezza minima di 900 mm ad un'altezza massima di 1110 mm





● ART. F BG S5R0 00 04
H = 740/1110 mm

 Gamma colori ACCIAIO



BLU
RAL 5012
.04



GRIGIO
RAL 7035
.08

PIANO IN LEGNO



RUOTE IN GOMMA ANTISTRACCIATA
SINTETICA Ø 125 mm

LEGENDA



FORNITO
SMONTATO



CHIUSURA



PORTATA
BANCO



LE PORTATE SONO NETTE E SI RIFERISCONO A PESI UNIFORMEMENTE DISTRIBUITI.



ART.			
F BG S5R0 00 04		-	600

DIMENSIONI mm 1024x750x740/1110 H

WORK UP



ART.			
F BG S6R0 00 04		-	600

DIMENSIONI mm 1500x750x740/1110 H



ART.			
F BG S7R0 00 04		-	600

DIMENSIONI mm 2000x750x740/1110 H



ART.			
F BG S5R0 01 04		-	200

DIMENSIONI mm 1024x750x900/1110 H

WORK ROL-UP



ART.			
F BG S6R0 01 04		-	200

DIMENSIONI mm 1500x750x900/1110 H



ART.			
F BG S7R0 01 04		-	200

DIMENSIONI mm 2000x750x900/1110 H



● **ART. F BG S1R0 00 04**

H = 740/1110 mm

 Gamma colori ACCIAIO



BLU
RAL 5012
.04



GRIGIO
RAL 7035
.08

PIANO IN ACCIAIO



RUOTE IN GOMMA ANTISTRACCIATA
SINTETICA Ø 125 mm

LEGENDA

BANCO
MONTATO



BANCO
SMONTATO



CHIUSURA



PORTATA
BANCO



LE PORTATE SONO NETTE E SI RIFERISCONO A PESI UNIFORMEMENTE DISTRIBUITI.



ART.			
F BG S1R0 00 04		-	600

DIMENSIONI mm 1031x705x740/1110 H

WORK UP



ART.			
F BG S2R0 00 04		-	600

DIMENSIONI mm 1507x705x740/1110 H



ART.			
F BG S3R0 00 04		-	600

DIMENSIONI mm 2007x705x740/1110 H



ART.			
F BG S1R0 01 04		-	200

DIMENSIONI mm 1031x705x900/1110 H

WORK ROL-UP



ART.			
F BG S2R0 01 04		-	200

DIMENSIONI mm 1507x705x900/1110 H



ART.			
F BG S3R0 01 04		-	200

DIMENSIONI mm 2007x705x900/1110 H

ARMADI



ART.		Dim. mm	
F BG 3010 01 04		500x607x210 H	

Portata cassetto 25 kg



ART.		Dim. mm	
F BG 3030 01 04		500x607x570 H	

Portata cassetto 25 kg



ART.		Dim. mm	
F BG 3050 01 04		500x607x570 H	

Portata cassetto 25 kg



ART.		Dim. mm	
F BG 3040 01 04		500x607x570 H	

SERRATURA DI RICAMBIO ART. R CSR 0005 00

COPERCHIO PER ARMADIO



ART.		Dim. mm	
F BL 6690 00 04		496x601	

FONDO DI CHIUSURA PER ARMADIO



ART.		Dim. mm	
F BG 3020 01 04		494x572	

PORTA ROTOLI



ART.		Dim. mm	Ø mm	
F CR 1006 00 01		245x88x150 H	130	
F CR 1007 00 01		285x155x200 H	240	

PORTA BOMBOLETTE



ART.		Dim. mm	
F CR 1108 00 04		575x75x167 H	



PANNELLO FORATO

ART.	Dim. mm
F CR 1109 00 04	575x18x655 H

CALAMITE



ART.	Conf.
F BL 9541 00 00	10 pz.

kg LA PORTATA DEI PIANI F BG, APPLICATI AI BANCHI WORK UP E WORK ROL-UP, È DI 600 kg.



PIANO IN ACCIAIO

ART.	Dim. mm	kg
F BG 3110 00 04	1031x705x32 H	600
F BG 3115 00 04	1507x705x32 H	600
F BG 3120 00 04	2000x705x32 H	600



PIANO IN MULTIPLEX

ART.	Dim. mm	kg
F BI A014 02 00	1024x750x30 H	600
F BI A042 02 00	1500x750x30 H	600
F BI A070 02 00	2000x750x30 H	600

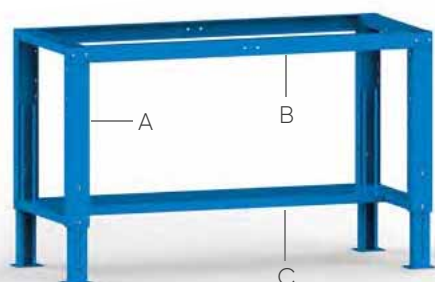

KIT RUOTE

ART.	kg
F BG KITR OU 04	200

Kit ruote in gomma antitraccia sintetica Ø 125 mm comprensivo di piastre di rinforzo angolari per piano superiore

GAMBA, TRAVERSI, SEMIPIANO INFERIORE (con possibilità di inserire un semipiano inferiore aggiuntivo)

ART.	Descrizione	Dim. mm	Larghezza banco mm	Rif.	kg
F BG 300R 00 04	gamba	80x610x705/1080 H	-	A	-
F BG 3510 01 04	coppia traverzi superiori	915x60x48 H	1031/1024	B	-
F BG 2308 00 04	semipiano inferiore	760x300x35 H	1031/1024	C	-
F BG 3515 01 04	coppia traverzi superiori	1415x60x48 H	1507/1500	B	-
F BG 2313 00 04	semipiano inferiore	1260x300x35 H	1507/1500	C	-
F BG 3520 01 04	coppia traverzi superiori	1915x60x48 H	2007/2000	B	-
F BG 2318 00 04	semipiano inferiore	1760x300x35 H	2007/2000	C	-

ROBUSTI, VERSATILI, PERSONALIZZABILI

2 TIPOLOGIE DI PIANI, 2 COLORI

CASSETTI AD ESTRAZIONE SEMPLICE

CHIUSURA CON CILINDRO

VARIE POSSIBILITÀ DI COMBINAZIONI

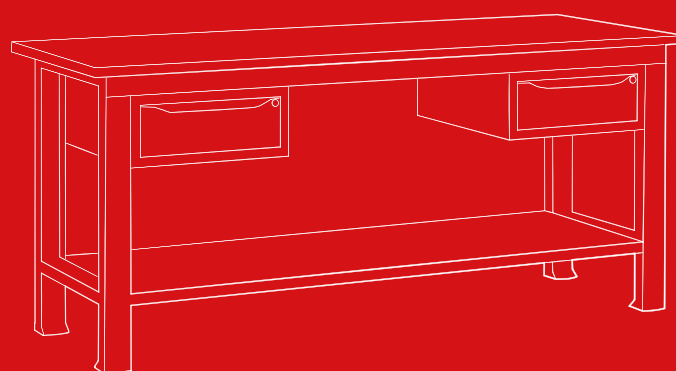



WORK STEEL

CARATTERISTICHE TECNICHE

COLORI BANCO

2 colori per la parte metallica

RAL 5012

RAL 7035



PIANO SUPERIORE
IN ACCIAIO



spessore 3 mm



ARMADI A CASSETTI

I cassetti e la porta sono forniti di chiusura a cilindro con 2 chiavi. Il cassetto, in apertura è dotato di un fermo che ne evita la caduta accidentale. Disponibili in 3 diverse configurazioni.

STRUTTURA

La struttura base, in robusta lamiera di acciaio, è composta da gambe, traversi superiori e piano inferiore con portata di 250 kg, assemblati tra loro con viti in modo tale da garantire una portata di 1000 kg.



SU RICHIESTA POSSONO ESSERE INSERITE LE
PARETI ATTREZZATE





ACCESSORI

I banchi sono predisposti per pareti laterali, posteriori e piani intermedi regolabili in altezza, fessurati e non, implementabili in qualsiasi momento.

La fessurazione permette l'inserimento di guide e contenitori in plastica serie **RK BOX**, con il vantaggio di poter creare, sul banco, un piccolo magazzino per minuterie, componenti e ricambistica.





● ART. F BG M1B0 00 04
H = 855 mm - 3 cassetti

 Gamma colori ACCIAIO



PIANO IN ACCIAIO

LEGENDA



BANCO MONTATO



BANCO SMONTATO



CHIUSURA



PORTATA BANCO



LE PORTATE SONO NETTE E SI RIFERISCONO A PESI UNIFORMEMENTE DISTRIBUITI.



ART.			
F BG M100 00 04		-	1000
F BG S100 00 04		-	1000



pareti chiuse

ART.			
F BG M100 01 04		-	1000
F BG S100 01 04		-	1000



pareti chiuse

ART.			
F BG M100 52 04		-	1000
F BG S100 52 04		-	1000

Completo di 4 RK BOX ART. FAX RB 5012 00 51 04,
6 RK BOX ART. FAX RB 6016 00 51 04,
2 contenitori grigi PICKING BOX mis. 4 ART. FAX PB C004 B0 51 01



1 cassetto

ART.			
F BG M1A0 00 04		key	1000
F BG S1A0 00 04		key	1000



3 cassetti

ART.			
● F BG M1B0 00 04		key	1000
F BG S1B0 00 04		key	1000



1 cassetto + 1 porta

ART.			
F BG M1C0 00 04		key	1000
F BG S1C0 00 04		key	1000



● ART. F BG M2B0 00 04
H = 855 mm - 3 cassetti

PIANO IN ACCIAIO



Gamma colori ACCIAIO



BLU
RAL 5012
.04



GRIGIO
RAL 7035
.08

LEGENDA



BANCO
MONTATO



BANCO
SMONTATO



CHIUSURA



PORTATA
BANCO



LE PORTATE SONO NETTE E SI RIFERISCONO A PESI UNIFORMEMENTE DISTRIBUITI.



ART.			
F BG M200 00 04		-	1000
F BG S200 00 04		-	1000



1 cassetto

ART.			
F BG M2A0 00 04		key	1000
F BG S2A0 00 04		key	1000



3 cassetti

ART.			
● F BG M2B0 00 04		key	1000
F BG S2B0 00 04		key	1000



3 cassetti

pareti chiuse

ART.			
F BG M2B0 01 04		key	1000
F BG S2B0 01 04		key	1000



3 cassetti

pareti chiuse

ART.			
F BG M2B0 52 04		key	1000
F BG S2B0 52 04		key	1000



4 cassetti + 1 porta

ART.			
F BG M2BC 00 04		key	1000
F BG S2BC 00 04		key	1000

Completo di 4 RK BOX ART. FAX RB 5012 00 51 04,
6 RK BOX ART. FAX RB 6016 00 51 04,
2 contenitori grigi PICKING BOX mis. 4 ART. FAX PB C004 B0 51 01



● ART. F BG M3B0 00 04
H = 855 mm - 3 cassetti

 Gamma colori ACCIAIO



BLU
RAL 5012
.04



GRIGIO
RAL 7035
.08

PIANO IN ACCIAIO

LEGENDA



BANCO
MONTATO



BANCO
SMONTATO



CHIUSURA



PORTATA
BANCO



LE PORTATE SONO NETTE E SI RIFERISCONO A PESI UNIFORMEMENTE DISTRIBUITI.

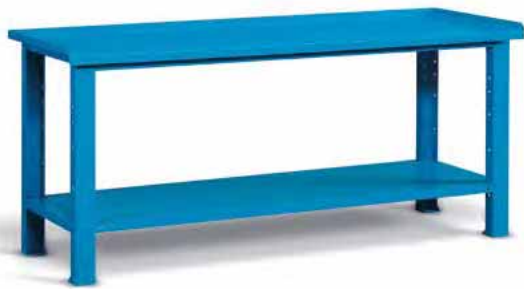

ART.			
F BG M300 00 04		-	1000
F BG S300 00 04		-	1000



1 cassetto

ART.			
F BG M3A0 00 04		key	1000
F BG S3A0 00 04		key	1000



2 cassetti

ART.			
F BG M3AA 00 04		key	1000
F BG S3AA 00 04		key	1000



3 cassetti

ART.			
● F BG M3B0 00 04		key	1000
F BG S3B0 00 04		key	1000



3 cassetti

pareti chiuse

ART.			
F BG M3B0 01 04		key	1000
F BG S3B0 01 04		key	1000



pareti chiuse

ART.			
F BG M3B0 52 04		-	1000
F BG S3B0 52 04		-	1000

Completo di 4 RK BOX ART. FAX RB 5012 00 51 04,
12 RK BOX ART. FAX RB 6016 00 51 04,
4 contenitori grigi PICKING BOX mis. 4 ART. FAX PB C004 B0 51 01



4 cassetti + 1 porta

ART.			
F BG M3BC 00 04		-	1000
F BG S3BC 00 04		-	1000



2 cassetti + 2 porte

ART.			
F BG M3CC 00 04		key	1000
F BG S3CC 00 04		key	1000



4 cassetti + 1 porta

pareti chiuse

ART.			
F BG M3BC 01 04		key	1000
F BG S3BC 01 04		key	1000

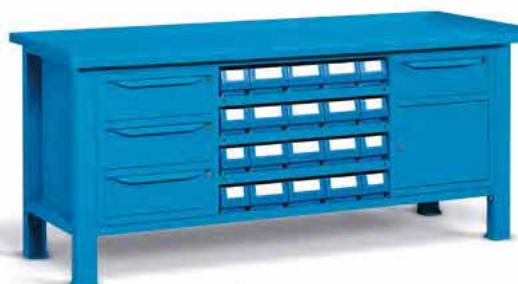

4 cassetti + 1 porta

pareti chiuse

ART.			
F BG M3BC 52 04		key	1000
F BG S3BC 52 04		key	1000

Completo di 8 RK BOX ART. FAX RB 5012 00 51 04,
12 RK BOX ART. FAX RB 6016 00 51 04



pareti chiuse

ART.			
F BG M300 01 04		key	1000
F BG S300 01 04		key	1000



pareti chiuse

ART.			
F BG M300 52 04		-	1000
F BG S300 52 04		-	1000

Completo di 4 RK BOX ART. FAX RB 5012 00 51 04,
18 RK BOX ART. FAX RB 6016 00 51 04,
5 contenitori grigi PICKING BOX mis. 4 ART. FAX PB C004 B0 51 01





● ART. F BG M4B0 00 04
H = 855 mm - 3 cassetti



Gamma colori ACCIAIO



BLU
RAL 5012
.04



GRIGIO
RAL 7035
.08

PIANO IN ACCIAIO

LEGENDA



BANCO
MONTATO



BANCO
SMONTATO



CHIUSURA



PORTATA
BANCO



LE PORTATE SONO NETTE E SI RIFERISCONO A PESI UNIFORMEMENTE DISTRIBUITI.



ART.			
F BG M400 00 04		-	1000
F BG S400 00 04		-	1000



1 cassetto

ART.			
F BG M4A0 00 04		key	1000
F BG S4A0 00 04		key	1000



3 cassetti

ART.			
● F BG M4B0 00 04		key	1000
F BG S4B0 00 04		key	1000



2 cassetti

ART.			
F BG M4AA 00 04		key	1000
F BG S4AA 00 04		key	1000



4 cassetti + 1 porta

ART.			
F BG M4BC 00 04		key	1000
F BG S4BC 00 04		key	1000



8 cassetti + 2 porte

ART.			
F BG M4BC CB 04		key	1000
F BG S4BC CB 04		key	1000



4 cassetti + 1 porta

ART.			
F BG M4CB 01 04		key	1000
F BG S4CB 01 04		key	1000



4 cassetti + 1 porta

ART.			
F BG M4CB 52 04		key	1000
F BG S4CB 52 04		key	1000

Completo di 16 RK BOX ART. FAX RB 5012 00 51 04,
16 RK BOX ART. FAX RB 6016 00 51 04





● **ART. F BG M5B0 00 04**
H = 880 mm - 3 cassetti

 Gamma colori ACCIAIO



PIANO IN MULTIPLEX

LEGENDA



BANCO
MONTATO



BANCO
SMONTATO



CHIUSURA



PORTATA
BANCO



LE PORTATE SONO NETTE E SI RIFERISCONO A PESI UNIFORMEMENTE DISTRIBUITI.



pareti chiuse

ART.			
F BG M500 00 04		-	1000
F BG S500 00 04		-	1000

ART.			
F BG M500 01 04		-	1000
F BG S500 01 04		-	1000



pareti chiuse

1 cassetto

ART.			
F BG M500 52 04		-	1000
F BG S500 52 04		-	1000

ART.			
F BG M5A0 00 04		key	1000
F BG S5A0 00 04		key	1000

Completo di 4 RK BOX ART. FAX RB 5012 00 51 04,
6 RK BOX ART. FAX RB 6016 00 51 04,
2 contenitori grigi PICKING BOX mis. 4 ART. FAX PB C004 B0 51 01



3 cassetti

1 cassetto + 1 porta

ART.			
● F BG M5B0 00 04		key	1000
F BG S5B0 00 04		key	1000

ART.			
F BG M5C0 00 04		key	1000
F BG S5C0 00 04		key	1000



● ART. F BG M6B0 00 04
H = 880 mm - 3 cassetti

 Gamma colori ACCIAIO



PIANO IN MULTIPLEX

LEGENDA



BANCO
MONTATO



BANCO
SMONTATO



CHIUSURA



PORTATA
BANCO



LE PORTATE SONO NETTE E SI RIFERISCONO A PESI UNIFORMEMENTE DISTRIBUITI.



1 cassetto

ART.			
F BG M600 00 04		-	1000
F BG S600 00 04		-	1000

ART.			
F BG M6A0 00 04		key	1000
F BG S6A0 00 04		key	1000



3 cassetti

3 cassetti

pareti chiuse

ART.			
● F BG M6B0 00 04		key	1000
F BG S6B0 00 04		key	1000

ART.			
F BG M6B0 01 04		key	1000
F BG S6B0 01 04		key	1000



3 cassetti

pareti chiuse

4 cassetti + 1 porta

ART.			
F BG M6B0 52 04		key	1000
F BG S6B0 52 04		key	1000

ART.			
F BG M6BC 00 04		key	1000
F BG S6BC 00 04		key	1000

Completo di 4 RK BOX ART. FAX RB 5012 00 51 04,
6 RK BOX ART. FAX RB 6016 00 51 04,
2 contenitori grigi PICKING BOX mis. 4 ART. FAX PB C004 B0 51 01



● **ART. F BG M7B0 00 04**
H = 880 mm - 3 cassetti

 Gamma colori ACCIAIO



PIANO IN MULTIPLEX

LEGENDA



BANCO
MONTATO



BANCO
SMONTATO



CHIUSURA



PORTATA
BANCO



LE PORTATE SONO NETTE E SI RIFERISCONO A PESI UNIFORMEMENTE DISTRIBUITI.

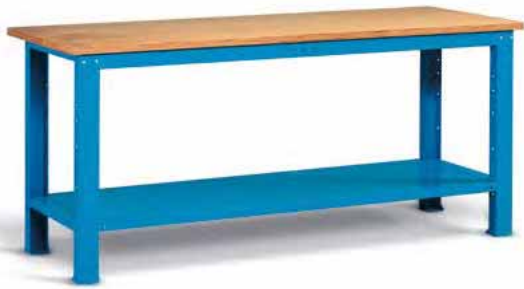

ART.			
F BG M700 00 04		-	1000
F BG S700 00 04		-	1000



1 cassetto

ART.			
F BG M7A0 00 04		key	1000
F BG S7A0 00 04		key	1000



2 cassetti

ART.			
F BG M7AA 00 04		key	1000
F BG S7AA 00 04		key	1000



3 cassetti

ART.			
● F BG M7B0 00 04		key	1000
F BG S7B0 00 04		key	1000



3 cassetti

pareti chiuse

ART.			
F BG M7B0 01 04		key	1000
F BG S7B0 01 04		key	1000



3 cassetti

pareti chiuse

ART.			
F BG M7B0 52 04		key	1000
F BG S7B0 52 04		key	1000

Completo di 4 RK BOX ART. FAX RB 5012 00 51 04,
12 RK BOX ART. FAX RB 6016 00 51 04,
4 contenitori grigi PICKING BOX mis. 4 ART. FAX PB C004 B0 51 01



2 cassetti + 1 porta

ART.			
F BG M7AC 00 04		key	1000
F BG S7AC 00 04		key	1000



4 cassetti + 1 porta

ART.			
F BG M7BC 00 04		key	1000
F BG S7BC 00 04		key	1000



2 cassetti + 2 porte

ART.			
F BG M7CC 00 04		key	1000
F BG S7CC 00 04		key	1000



4 cassetti + 1 porta

pareti chiuse

ART.			
F BG M7BC 01 04		key	1000
F BG S7BC 01 04		key	1000



4 cassetti + 1 porta

pareti chiuse

ART.			
F BG M7BC 52 04		key	1000
F BG S7BC 52 04		key	1000

Completo di 8 RK BOX ART. FAX RB 5012 00 51 04,
12 RK BOX ART. FAX RB 6016 00 51 04



pareti chiuse

ART.			
F BG M700 52 04		-	1000
F BG S700 52 04		-	1000

Completo di 4 RK BOX ART. FAX RB 5012 00 51 04,
18 RK BOX ART. FAX RB 6016 00 51 04,
5 contenitori grigi PICKING BOX mis. 4 ART. FAX PB C004 B0 51 01





● ART. F BG M8B0 00 04
H = 880 mm - 3 cassetti

 Gamma colori ACCIAIO



PIANO IN MULTIPLEX

LEGENDA



BANCO
MONTATO



BANCO
SMONTATO



CHIUSURA



PORTATA
BANCO



LE PORTATE SONO NETTE E SI RIFERISCONO A PESI UNIFORMEMENTE DISTRIBUITI.



ART.			
F BG M800 00 04		-	1000
F BG S800 00 04		-	1000



1 cassetto

ART.			
F BG M8A0 00 04		key	1000
F BG S8A0 00 04		key	1000



3 cassetti

ART.			
● F BG M8B0 00 04		key	1000
F BG S8B0 00 04		key	1000



2 cassetti

ART.			
F BG M8AA 00 04		key	1000
F BG S8AA 00 04		key	1000



4 cassetti + 1 porta

ART.			
F BG M8BC 00 04		key	1000
F BG S8BC 00 04		key	1000



8 cassetti + 2 porte

ART.			
F BG M8BC CB 04		key	1000
F BG S8BC CB 04		key	1000



4 cassetti + 1 porta

ART.			
F BG M8CB 01 04		key	1000
F BG S8CB 01 04		key	1000



4 cassetti + 1 porta

ART.			
F BG M8CB 52 04		key	1000
F BG S8CB 52 04		key	1000

Completo di 16 RK BOX ART. FAX RB 5012 00 51 04,
16 RK BOX ART. FAX RB 6016 00 51 04



CONFIGURA IL TUO BANCO



PIANO IN ACCIAIO

ART.	Dim. mm	kg
F BG 3110 00 04	1031x705x32 H	1000
F BG 3115 00 04	1507x705x32 H	1000
F BG 3120 00 04	2000x705x32 H	1000
F BG 3125 00 04	2507x705x32 H	1000



PIANO IN MULTIPLEX

ART.	Dim. mm	kg
F BI A014 02 00	1024x750x30 H	1000
F BI A042 02 00	1500x750x30 H	1000
F BI A070 02 00	2000x750x30 H	1000
F BI A084 02 00	2500x750x30 H	1000

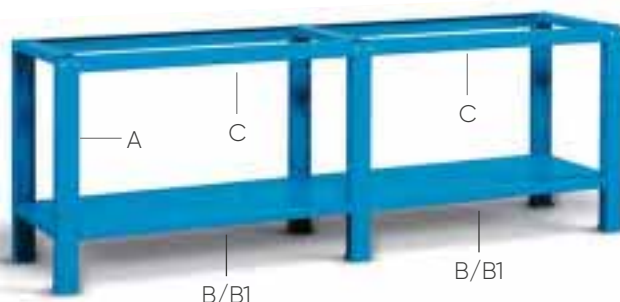
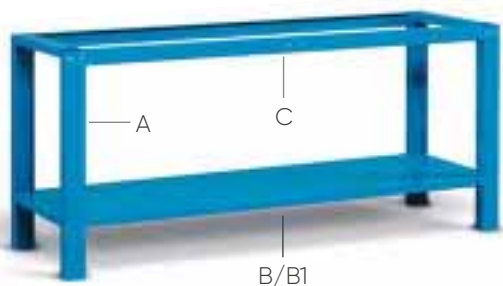

GAMBA, TRAVERSI, PIANI INFERIORI

ART.	Descrizione	Dim. mm	Larghezza banco mm	Rif.	kg
F BG 3000 00 04	gamba	80x610x852 H	-	A	-
F BG 3308 00 04	piano non fessurato in acciaio	760x600x35 H	1031/1024	B	250
F BG 3408 00 04	piano fessurato in acciaio	760x600x35 H	1031/1024	B1	100
F BG 3510 01 04	coppia traversi superiori	915x60x48 H	1031/1024	C	-
F BG 3313 00 04	piano non fessurato in acciaio	1260x600x35 H	1507/1500	B	250
F BG 3413 00 04	piano fessurato in acciaio	1260x600x35 H	1507/1500	B1	100
F BG 3515 01 04	coppia traversi superiori	1415x60x48 H	1507/1500	C	-
F BG 3318 00 04	piano non fessurato in acciaio	1760x600x35 H	2007/2000	B	200
F BG 3418 00 04	piano fessurato in acciaio	1760x600x35 H	2007/2000	B1	80
F BG 3520 01 04	coppia traversi superiori	1915x60x48 H	2007/2000	C	-
F BG 3311 00 04	piano non fessurato in acciaio	1090x600x35 H	2507/2500	B	250
F BG 3411 00 04	piano fessurato in acciaio	1090x600x35 H	2507/2500	B1	100
F BG 3525 01 04	coppia traversi superiori	2415x60x48 H	2507/2500	C	-



ART. F BG 3999 00 00

L'ARTICOLO PREMONTAGGIO VA APPLICATO A TUTTI I COMPONENTI SINGOLI



COPERTURA PER PIANI IN ACCIAIO

ART.	Dim. mm
F BG 3210 00 07	1024x700x27 H
F BG 3215 00 07	1500x700x27 H
F BG 3220 00 07	2000x700x27 H
F BG 3225 00 07	2500x700x27 H

Copertura in acciaio 8/10 mm rivestita in gomma antiolio 12/10 - 15/10 mm per piani in acciaio provvista di sagomatura H 27 mm anteriore a "L"



COPERTURA PER PIANI IN MULTIPLEX

ART.	Dim. mm
F BL 2230 00 07	1024x750x20 H
F BL 2260 00 07	1500x750x20 H
F BL 2290 00 07	2000x750x20 H
F BL 2305 00 07	2500x750x20 H

Copertura in acciaio 8/10 mm rivestita in gomma antiolio 12/10 - 15/10 mm per piani in multiplex provvista di sagomatura H 20 mm anteriore e posteriore a "L"



COPERTURA ZINCATA PER PIANI IN MULTIPLEX

ART.	Dim. mm
F BL 7900 00 99	1024x750x20 H
F BL 7930 00 99	1500x750x20 H
F BL 7960 00 99	2000x750x20 H
F BL 7975 00 99	2500x750x20 H

Copertura spessore 12/10 mm in acciaio microforato per piani in multiplex provvista di sagomatura H 20 mm anteriore e posteriore a "L" resistente all'abrasione e all'effetto degli oli e dei grassi



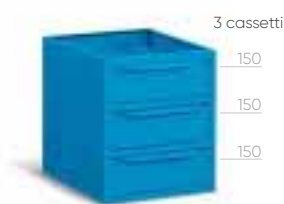

ART.	Dim. mm
F BG 3030 01 04	500x607x570 H

Portata cassetto 25 kg

ART.	Dim. mm
F BG 3050 01 04	500x607x570 H

Portata cassetto 25 kg

ART.	Dim. mm
F BG 3010 01 04	500x607x210 H

Portata cassetto 25 kg



ART. F BG 3999 00 00

L'ARTICOLO PREMONTAGGIO VA APPLICATO A TUTTI I COMPONENTI SINGOLI

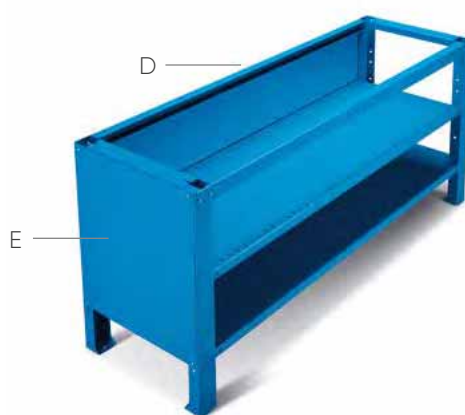

CHIUSURE LATERALI E POSTERIORI

ART.	Descrizione	Dim. mm	Larghezza banco mm	Rif.
F BG 3690 00 04	chiusura laterale	590x660 H	-	E
F BG 3608 00 04	chiusura posteriore	840x48x653 H	1031/1024	D
F BG 3613 00 04	chiusura posteriore	1340x48x653 H	1507/1500	D
F BG 3618 00 04	chiusura posteriore	1840x48x653 H	2007/2000	D
F BG 3611 00 04	chiusura posteriore singola per campata	1170x48x653 H	2507/2500	D



PIANI FESSURATI E NON FESSURATI IN ACCIAIO

ART.	Descrizione	Dim. mm	Portata kg	Rif.
F BG 3308 00 04	piano non fessurato in acciaio	760x600x35 H	60	F
F BG 3408 00 04	piano fessurato in acciaio	760x600x35 H	60	F1
F BG 3313 00 04	piano non fessurato in acciaio	1260x600x35 H	60	G
F BG 3413 00 04	piano fessurato in acciaio	1260x600x35 H	60	G1
F BG 3406 00 04	piano fessurato in acciaio	590x600x35 H	60	H



**LIBERTÀ DI CONFIGURARE
PIÙ SCOMPARTI CON
CASSETTI, PORTE E PIANI**





WORK SYSTEM

CARATTERISTICHE TECNICHE

COLORI BANCO

2 colori per la parte metallica

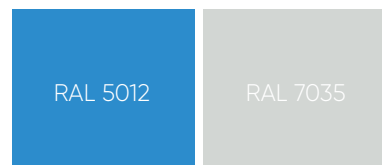

PARTICOLARE DEL CUSCINETTO

ARMADI A CASSETTI

I cassetti sono forniti con estrazione semplice (pari al 100%) su cuscinetti a sfera ad alta resistenza. Il fondo forato e le pareti fessurate con passo 17 mm permettono un facile inserimento e fissaggio (tramite viti) dei divisori in metallo.

Le altezze frontali disponibili sono le seguenti:
50 / 75 / 100 / 125 / 150 / 200 / 250 / 300 mm



100% = 70 kg

H FRONTALE 50 mm

100% = 50 kg

FIANCATE

Ogni fiancata che compone il banco è munita di due montanti forati a passo 25 mm per permettere l'inserimento delle guide dei cassetti e l'aggancio dei piani regolabili.



SU RICHIESTA POSSONO ESSERE INSERITE LE PARETI ATTREZZATE





I BANCHI COMPONENTI DELLA SERIE SYSTEM HANNO UNA STRUTTURA A SCOMPARTI CHE LI RENDE FLESSIBILI NELLA COMPOSIZIONE.

Oltre alle soluzioni presenti a catalogo, è possibile configurarli con piani, cassetti e porte in base alle esigenze produttive e di reparto, rendendoli tra i banchi più versatili della nostra gamma.



CHIUSURA LATERALE
CON CILINDRO

La serratura laterale permette la chiusura di tutti i cassetti inseriti nello stesso comparto. Il sistema può essere fornito in due altezze:

- H 600 mm nel caso in cui lo scomparto sia completamente riempito di cassetti
- H 150 mm nel caso in cui nello scomparto vengano inseriti la porta da 450 mm H e i cassetti.

FORNITA DI SERIE CON 2 CHIAVI



PIANI REGOLABILI

Il piano regolabile, che senza ganci funge anche da piano di chiusura del fondo, viene fornito in due modelli: per gli scomparti di sinistra o per quelli destri/centrali di ogni modulo.

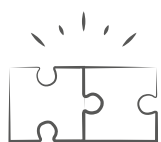

**FORNITI
SEMPRE MONTATI**





● ART. F BR 2242 03 04
H = 865 mm - 3 cassetti



Gamma colori ACCIAIO



BLU
RAL 5012
.04



GRIGIO
RAL 7035
.08

PIANO IN MULTIPLEX

LEGENDA



CHIUSURA



PORTATA
BANCO



LE PORTATE SONO NETTE E SI RIFERISCONO A PESI UNIFORMEMENTE DISTRIBUITI.

PIANO SPESSORE 40 mm



ART.			
F BR 2242 01 04		key	1000



ART.			
● F BR 2242 03 04		key	1000



ART.			
F BR 2242 04 04		key	1000



ART.			
F BR 2242 05 04		key	1000



ART.			
F BR 2242 08 04		key	1000



● **ART. F BR 2243 05 04**
H = 865 mm - 6 cassetti



Gamma colori ACCIAIO



BLU
RAL 5012
.04



GRIGIO
RAL 7035
.08

PIANO IN MULTIPLEX

LEGENDA



CHIUSURA



PORTATA
BANCO



LE PORTATE SONO NETTE E SI RIFERISCONO A PESI UNIFORMEMENTE DISTRIBUITI.

PIANO SPESSORE 40 mm



ART.			
F BR 2243 01 04		key	1000



ART.			
F BR 2243 02 04		key	1000



ART.			
F BR 2243 03 04		key	1000



ART.			
● F BR 2243 05 04		key	1000



ART.			
F BR 2243 09 04		key	1000



● ART. F BR 2244 01 04
H = 865 mm - 10 cassetti



Gamma colori ACCIAIO



BLU
RAL 5012
.04



GRIGIO
RAL 7035
.08

PIANO IN MULTIPLEX

LEGENDA



CHIUSURA



PORTATA
BANCO



LE PORTATE SONO NETTE E SI RIFERISCONO A PESI UNIFORMEMENTE DISTRIBUITI.

PIANO SPESSORE 40 mm



ART.				
F BR 2244 01 04		key	2000	



ART.				
F BR 2244 02 04		key	2000	



ART.				
F BR 2244 03 04		key	2000	



ART.				
F BR 2244 04 04		key	2000	



● ART. F BR 2245 01 04

H = 865 mm - 3 cassetti



Gamma colori ACCIAIO



BLU
RAL 5012
.04



GRIGIO
RAL 7035
.08

PIANO IN MULTIPLEX

LEGENDA



CHIUSURA



PORTATA
BANCO



LE PORTATE SONO NETTE E SI RIFERISCONO A PESI UNIFORMEMENTE DISTRIBUITI.

PIANO SPESSORE 40 mm



ART.				
F BR 2245 01 04		key	2000	



ART.				
F BR 2245 02 04		key	2000	



ART. F BR 2343 S1 08
Dim. mm 2000x800x865/1500 H
ESCLUSE APPARECCHIATURE
COLORE GRIGIO RAL 7035

CONFIGURA IL TUO BANCO

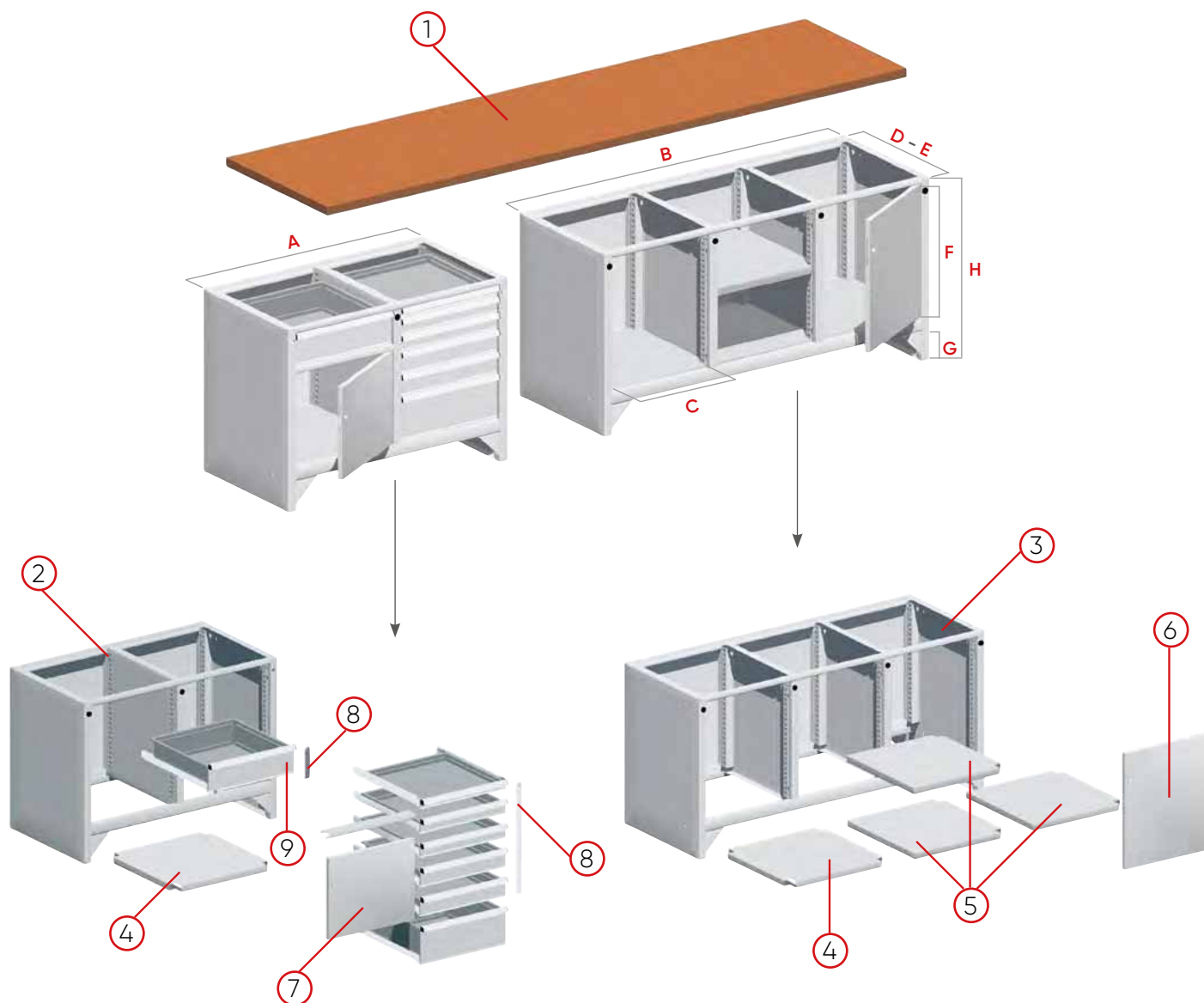

A. Lunghezza modulo 2 scomparti	1135 mm	E. Profondità di ingombro modulo	630 mm
B. Lunghezza modulo 3 scomparti	1683 mm	F. Altezza utile scomparto	600 mm
C. Larghezza utile scomparto	507 mm	G. Altezza zoccolo	135 mm
D. Profondità utile scomparto	595 mm	H. Altezza totale modulo	825 mm



TIPO DI PIANO

SPESSORE mm

kg

kg

kg

kg

MULTIPLEX

40

1000

1000

2000

2000

1

PIANO IN MULTIPLEX PROFONDITÀ 750 mm SPESSORE 40 mm

ART.	PIANO MM	PREMONTAGGIO	ADATTO PER
F BI A242 00 00	1500	1 pz. F BR 0960 00 00	1 modulo a 2 scomparti
F BI A270 00 00	2000	1 pz. F BR 0961 00 00	1 modulo a 3 scomparti
F BI A284 00 00	2500	2 pz. F BR 0960 00 00	2 moduli a 2 scomparti
F BI A298 00 00	3000	1 pz. F BR 0960 00 00 + 1 pz. F BR 0961 00 00	1 modulo a 2 scomparti + 1 modulo a 3 scomparti

2

MODULO A 2 SCOMPARTI DIM. mm 1135x630x825 H

ART.	
F BR 2242 00 08	

3

MODULO A 3 SCOMPARTI DIM. mm 1683x630x825 H

ART.	
F BR 2243 00 08	

4

PIANI IN ACCIAIO SX DIM. mm 579x566x35 H

ART.		
F BR 0220 01 08		50

Questo piano può essere usato come chiusura del fondo oppure come piano regolabile degli scomparti sinistri di ogni modulo.

5

PIANI IN ACCIAIO CENTRALI O DX DIM. mm 543x566x35 H

ART.		
F BR 0230 01 08		50

Questo piano può essere usato come chiusura del fondo oppure come piano regolabile degli scomparti centrali o destri di ogni modulo.

9

CASSETTI AD ESTRAZIONE TOTALE

ART.	H FRONTALE mm	DIM. UTILI mm		
F DB 8050 00 08	50	447x447x36 H	100%	50
F DB 8075 00 08	75	447x447x61 H	100%	70
F DB 8100 00 08	100	447x447x86 H	100%	70
F DB 8125 00 08	125	447x447x111 H	100%	70
F DB 8150 00 08	150	447x447x136 H	100%	70
F DB 8200 00 08	200	447x447x186 H	100%	70
F DB 8250 00 08	250	447x447x236 H	100%	70
F DB 8300 00 08	300	447x447x286 H	100%	70

6

PORTE DIM. mm 504x600 H

ART.		PORTA
F BR 0720 00 08		DX
F BR 0721 00 08		SX

Questa porta è disponibile sia con apertura a destra che a sinistra. La sua altezza di 600 mm copre completamente uno scomparto. Fornita di serie con chiusura a cilindro e 2 chiavi.

7

PORTE DIM. mm 504x450 H

ART.		PORTA
F BR 0710 00 08		DX
F BR 0711 00 08		SX

Questa porta è disponibile sia con apertura a destra che a sinistra. La sua altezza copre parzialmente uno scomparto fino ad una altezza di 450 mm ed è comprensiva di un traverso di 25 mm. Sopra la porta deve essere obbligatoriamente montato un piano oppure dei cassetti. Fornita di serie con chiusura a cilindro e 2 chiavi.

8

CHIUSURE CON ALTEZZE 150 - 600 mm PER CASSETTI

ART.	LUNGHEZZA mm
F BR 0410 00 00	150
F BR 0430 00 00	600

Fornita di serie con chiusura a cilindro e 2 chiavi.

PIANI

MULTIPLEX
DI FAGGIO



3 STRATI
INCROCIATI DI
FAGGIO



MULTIPLEX
CON LAMINATO E
BORDI IN MASSELLO



GRIGIO

Spessore mm	dim. mm	ART.	ART.	ART.
40	1500x750	F BI A242 00 00	-	F BH A242 00 08
	1500x800	F BI A342 00 00	-	F BH A342 00 08
	2000x750	F BI A270 00 00	-	F BH A270 00 08
	2000x800	F BI A370 00 00	-	F BH A370 00 08
	2500x750	F BI A284 00 00	-	F BH A284 00 08
	2500x800	F BI A384 00 00	-	F BH A384 00 08
	3000x750	F BI A298 00 00	-	F BH A298 00 08
	3000x800	F BI A398 00 00	-	-

**COPERTURA SPESSORE 12/10 mm IN ACCIAIO MICROFIORATO PER PIANI IN MULTIPLEX
PROVVISTA DI SAGOMATURA H 20 mm ANTERIORE E POSTERIORE A "L"
RESISTENTE ALL'ABRASIONE E ALL'EFFETTO DEGLI OLI E DEI GRASSI**



dim. mm	ART. SPESSORE 20 mm
1500x750	F BL 7930 00 99
1500x800	F BL 7935 00 99
2000x750	F BL 7960 00 99
2000x800	F BL 7965 00 99
2500x750	F BL 7975 00 99
2500x800	F BL 7980 00 99
3000x750	F BL 7990 00 99
3000x800	F BL 7995 00 99

MULTIPLEX
CON LAMINATO E
BORDI IN MASSELLO



BLU

MULTIPLEX
RIVESTITO IN
LAMINATO



GRIGIO

MULTIPLEX
RIVESTITO IN
LAMINATO

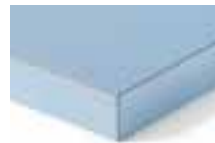

BLU

PIANI ESD
A RICHIESTA



ART.	ART.	ART.
F BH A242 00 04	F BH B242 00 08	F BH B242 00 04
F BH A342 00 04	F BH B342 00 08	F BH B342 00 04
F BH A270 00 04	F BH B270 00 08	F BH B270 00 04
F BH A370 00 04	F BH B370 00 08	F BH B370 00 04
F BH A284 00 04	F BH B284 00 08	F BH B284 00 04
F BH A384 00 04	F BH B384 00 08	F BH B384 00 04
F BH A298 00 04	F BH B298 00 08	F BH B298 00 04
-	-	-

COPERTURA IN ACCIAIO 8/10 mm RIVESTITA IN GOMMA ANTIOLIO 12/10 - 15/10 mm
PER PIANI IN MULTIPLEX PROVISTA DI SAGOMATURA H 20 mm ANTERIORE E POSTERIORE A "L"

dim. mm	ART. SPESSORE 20 mm
1500x750	F BL 2260 00 07
1500x800	F BL 2265 00 07
2000x750	F BL 2290 00 07
2000x800	F BL 2295 00 07
2500x750	F BL 2305 00 07
2500x800	F BL 2310 00 07
3000x750	F BL 2320 00 07
3000x800	F BL 2325 00 07



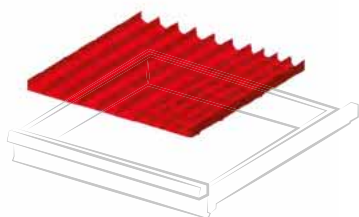

ART. per altezza frontale mm

F FH 8405 02 00 50 - 300

Set composto da: 3 divisori 4 canali, 6 divisori 3 canali, 16 divisori trasversali 36 mm, 7 divisori trasversali 47 mm

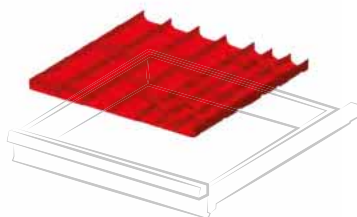

ART. per altezza frontale mm

F FH 8405 03 00 50 - 300

Set composto da: 3 divisori 3 canali, 6 divisori 2 canali, 15 divisori trasversali 47 mm, 8 divisori trasversali 73 mm

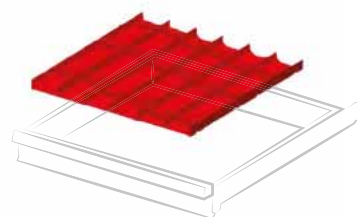

ART. per altezza frontale mm

F FH 8405 04 00 50 - 300

Set composto da: 9 divisori 2 canali, 18 divisori trasversali 73 mm

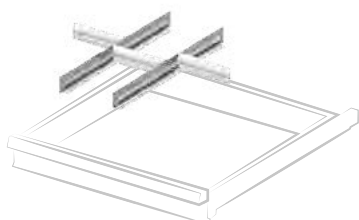

ART. per altezza frontale mm

F FH 8405 08 00 50

F FH 8407 08 00 75

F FH 8410 08 00 100 - 125

F FH 8415 08 00 150

F FH 8420 08 00 200 - 250

F FH 8430 08 00 300

Set composto da: 2 divisori longitudinali fessurati 455 mm, 3 divisori trasversali 149 mm

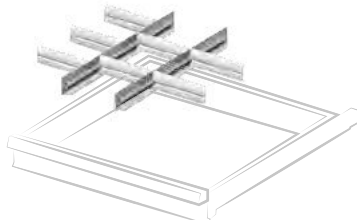

ART. per altezza frontale mm

F FH 8405 09 00 50

F FH 8407 09 00 75

F FH 8410 09 00 100 - 125

F FH 8415 09 00 150

F FH 8420 09 00 200 - 250

Set composto da: 2 divisori longitudinali fessurati 455 mm, 7 divisori trasversali 149 mm

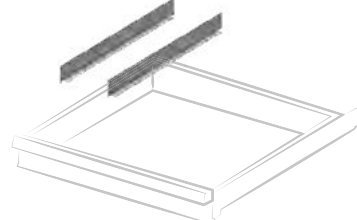

ART. per altezza frontale mm

F FH 8405 13 00 50

F FH 8407 13 00 75

F FH 8410 13 00 100 - 125

F FH 8415 13 00 150

F FH 8420 13 00 200 - 250

Set composto da: 2 divisori longitudinali non fessurati 455 mm

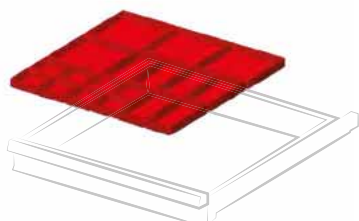

ART. per altezza frontale mm

F FH 8405 17 00 50

F FH 8407 17 00 75

Set composto da: 8 cassette divisorio 75x75 mm, 6 cassette divisorio 150x75 mm, 4 cassette divisorio 150x150 mm

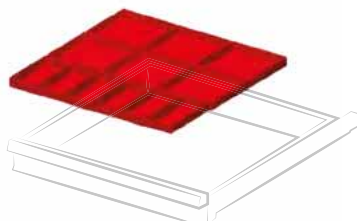

ART. per altezza frontale mm

F FH 8405 18 00 50

F FH 8407 18 00 75

F FH 8410 18 00 100 - 125

Set composto da: 6 cassette divisorio 150x75 mm, 6 cassette divisorio 150x150 mm

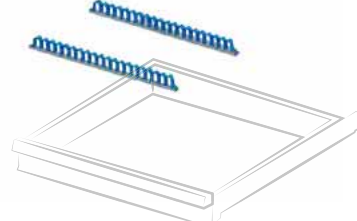

ART. per altezza frontale mm

F FH 8605 19 00 50 - 300

Set composto da: 2 supporti multiuso 440 mm

CONFIGURA IL CASSETTO FAMI CON UTENSILI BETA

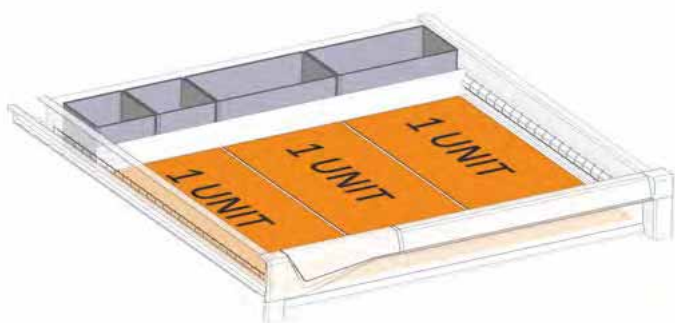

ART. F FH 0807 50 07

Set di predisposizione cassetto per termoformati Beta composto da:

n. 2 F HC 6071 00 07

n. 2 F HC 6471 00 07

n. 1 F HA 1121 00 99

1 unit = 1 termoformato Beta 367x147 mm

2 unit = 1 termoformato Beta 367x294 mm

ESEMPI DI UTILIZZO TERMOFORMATO

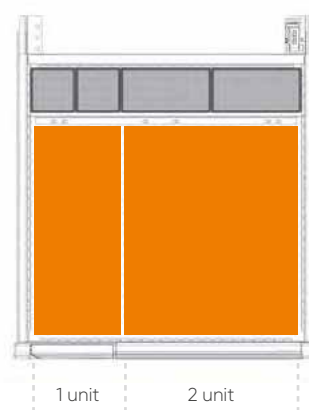
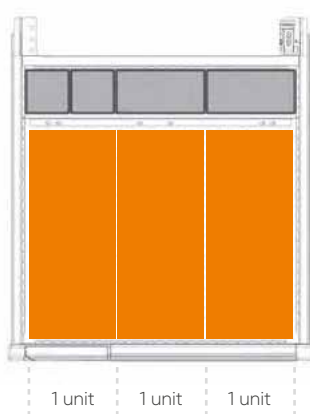

10 COLORI ACCIAIO
8 COLORI PLASTICHE
3 DIVERSE LUNGHEZZE
AMPIA GAMMA DI RUOTE
ACCESSORIABILI
CON PARETI ATTREZZATE
ESTRAIBILITÀ CASSETTI AL 100%

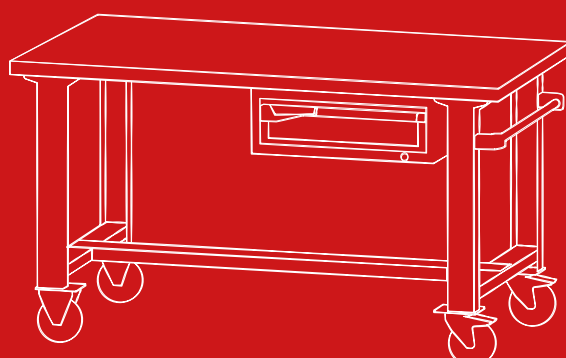
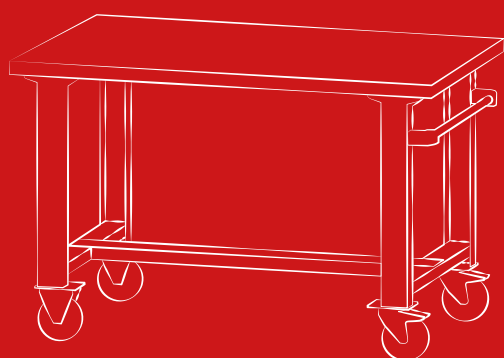



WORK ROL - MASTER

CARATTERISTICHE TECNICHE

COLORI

ARMADIO

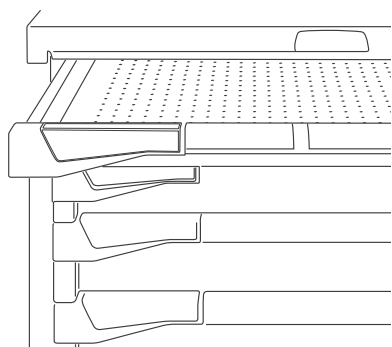

10 colori per la parte metallica



8 colori per gli accessori di plastica



MANIGLIA FRONTALE



ARMADI A CASSETTI

Nuova guida ad estrazione flessibile con regolazione meccanica del fermo posteriore del cassetto in 3 diverse posizioni.

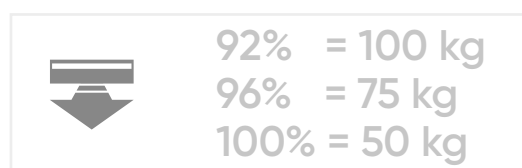

ASTA VERTEBRATA

L'asta è in profilato d'alluminio e rimane sempre fissa, senza ruotare. Il movimento di chiusura è ottenuto da tasselli che si spostano verticalmente sfruttando una delle forze elementari della fisica: la gravità. Più il movimento è semplice, meno probabilità di rotture ci sono. La chiusura dell'asta è affidata a un sistema a catenaccio posto sulla testa dell'asta.



CHIUSURA CON CILINDRO



SISTEMA DI TRASMISSIONE DAL CILINDRO DELLA CHIUSURA ALLA TESTA DELL'ASTA VERTEBRATA A FILO DI ACCIAIO CON GUAINA ELASTICA E MOVIMENTO LINEARE.

LA CHIUSURA A CILINDRO È SUDDIVISA IN 23 DIVERSE SERIE: OGNI SERIE HA UNA NUMERAZIONE DELLE CHIAVI COMPRESA TRA 1 E 160, PER UN TOTALE DI 3.680 DIVERSE COMBINAZIONI.

FORNITA DI SERIE CON 2 CHIAVI

I CASSETTI HANNO
ESTRAZIONE
FLESSIBILE

PUSH TO OPEN- APERTURA SINGOLA DEI CASSETTI

Rispetto ai comuni sistemi che prevedono l'aggiunta di ulteriori componenti sul frontale, l'apertura singola dei cassetti è integrata nel cilindro. Per aprirli basta premere il cilindro della serratura. Meno componenti servono per un meccanismo, meno possibilità di rottura ci sono.



GAMBE FISSE E REGOLABILI CON RUOTE

Le gambe sono costruite in lamiera di acciaio con fori sulla parte superiore per il fissaggio al piano di lavoro e sulle piastre di base per il montaggio delle ruote, disponibili con diametro 125 mm e modelli adatti alle più svariate pavimentazioni. Presente anche la versione regolabile in altezza da 850 a 1250 mm tramite due allunghe forate a passo 25 mm (regolabili mediante fissaggio a vite). Nella gamba con ruote girevoli presente una comoda maniglia per movimentare il banco.



RUOTE IN
GOMMA
STANDARD



RUOTE IN
GOMMA
ANTISTRACCIA



RUOTE IN
GOMMA
ELASTICA



RUOTE IN
POLIURETANO



RUOTE IN
NYLON



SU RICHIESTA POSSONO ESSERE INSERITE LE
PARETI ATTREZZATE



● ART. M CA C228 C010 03 04
H = 840 mm - 1 cassetto

Gamma colori ACCIAIO

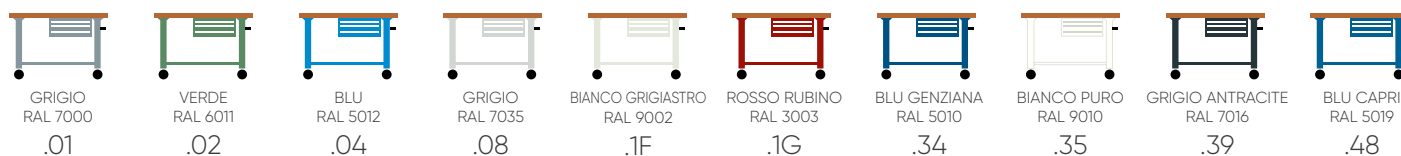

Gamma colori
PLASTICHE



DARK GREY
.MO

LEGENDA



PROFONDITÀ



CHIUSURA



PORTATA
BANCO



LE PORTATE SONO NETTE E SI RIFERISCONO A PESI UNIFORMEMENTE DISTRIBUITI.

PIANO IN MULTIPLEX SPESSORE 40 mm



ART.				
M CA C228 0000 02 04		750 mm	-	240
M CA C328 0000 02 04		800 mm	-	240



ART.				
M CA C228 0000 05 04		750 mm	-	240
M CA C328 0000 05 04		800 mm	-	240

H 890/1290 mm



Armadio dim. mm 561x726x200 H (27x36 EH)

ART.				
● M CA C228 C010 03 04		750 mm	key	220
M CA C328 C010 03 04		800 mm	key	220



Armadio dim. mm 561x726x200 H (27x36 EH)

ART.				
M CA C228 C010 06 04		750 mm	key	220
M CA C328 C010 06 04		800 mm	key	220

H 890/1290 mm



Armadio dim. mm 561x726x400 H (27x36 EH)

ART.				
M CA C228 S010 04 04		750 mm	key	200
M CA C328 S010 04 04		800 mm	key	200
M CA C228 P210 04 04		750 mm	code	200
M CA C328 P210 04 04		800 mm	code	200



Armadio dim. mm 561x726x400 H (27x36 EH)

ART.				
M CA C228 S010 07 04		750 mm	key	200
M CA C328 S010 07 04		800 mm	key	200
M CA C228 P210 07 04		750 mm	code	200
M CA C328 P210 07 04		800 mm	code	200

H 890/1290 mm



2 ruote con freno in gomma standard Ø 125 mm
2 ruote fisse in gomma standard Ø 125 mm



ART. M CA C242 C010 09 04

H = 840 mm - 1 cassetto (H = 200 mm)

Armadio dim. mm 561x726x300 H (27x36 EH)

Gamma colori ACCIAIO

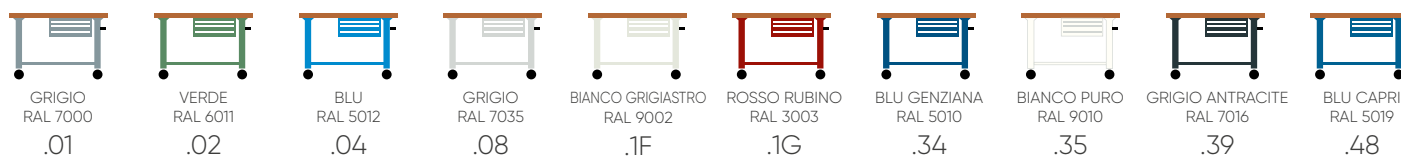

Gamma colori
PLASTICHE



DARK GREY
.MO

LEGENDA



PROFONDITÀ



CHIUSURA



PORTATA
BANCO



LE PORTATE SONO NETTE E SI RIFERISCONO A PESI UNIFORMEMENTE DISTRIBUITI.

PIANO IN MULTIPLEX SPESSORE 40 mm



ART.				
M CA C242 0000 02 04	750 mm	-	-	240
M CA C342 0000 02 04	800 mm	-	-	240



H 890/1290 mm

ART.				
M CA C242 0000 05 04	750 mm	-	-	240
M CA C342 0000 05 04	800 mm	-	-	240



Armadio dim. mm 561x726x200 H (27x36 EH)

ART.				
M CA C242 C010 03 04	750 mm	key	-	220
M CA C342 C010 03 04	800 mm	key	-	220



Armadio dim. mm 561x726x200 H (27x36 EH)

H 890/1290 mm

ART.				
M CA C242 C010 06 04	750 mm	key	-	220
M CA C342 C010 06 04	800 mm	key	-	220



Armadio dim. mm 561x726x400 H (27x36 EH)

ART.				
M CA C242 S010 04 04	750 mm	key	-	200
M CA C342 S010 04 04	800 mm	key	-	200
M CA C242 P210 04 04	750 mm	code	-	200
M CA C342 P210 04 04	800 mm	code	-	200



Armadio dim. mm 561x726x400 H (27x36 EH)

H 890/1290 mm

ART.				
M CA C242 S010 07 04	750 mm	key	-	200
M CA C342 S010 07 04	800 mm	key	-	200
M CA C242 P210 07 04	750 mm	code	-	200
M CA C342 P210 07 04	800 mm	code	-	200



2 ruote con freno in gomma standard Ø 125 mm
2 ruote fisse in gomma standard Ø 125 mm



● **ART. M CA C270 S010 04 04**
H = 840 mm - 3 cassetti

 Gamma colori ACCIAIO

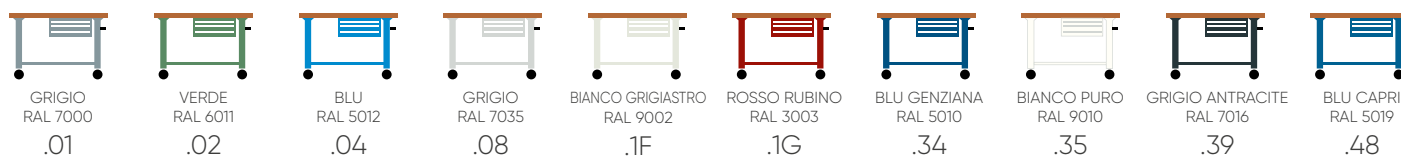

Gamma colori
PLASTICHE



DARK GREY
.MO

LEGENDA



PROFONDITÀ



CHIUSURA



PORTATA
BANCO



LE PORTATE SONO NETTE E SI RIFERISCONO A PESI UNIFORMEMENTE DISTRIBUITI.

PIANO IN MULTIPLEX SPESSORE 40 mm

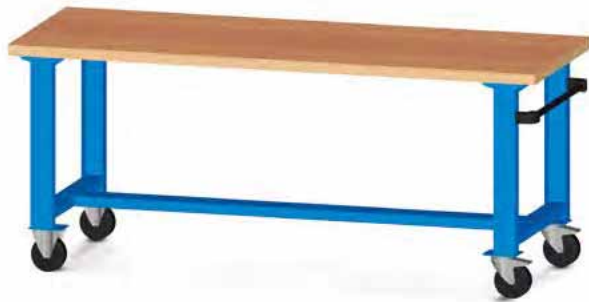

ART.				
M CA C270 0000 02 04	750 mm	-	-	220
M CA C370 0000 02 04	800 mm	-	-	220

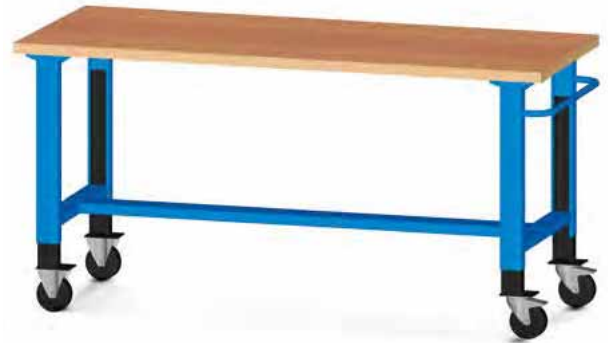

ART.					H 890/1290 mm
M CA C270 0000 05 04	750 mm	-	-	220	
M CA C370 0000 05 04	800 mm	-	-	220	



Armadio dim. mm 561x726x200 H (27x36 EH)

ART.				
M CA C270 C010 03 04	750 mm	key	-	200
M CA C370 C010 03 04	800 mm	key	-	200



Armadio dim. mm 561x726x200 H (27x36 EH)

ART.					H 890/1290 mm
M CA C270 C010 06 04	750 mm	key	-	200	
M CA C370 C010 06 04	800 mm	key	-	200	



Armadio dim. mm 561x726x400 H (27x36 EH)

ART.				
● M CA C270 S010 04 04	750 mm	key	-	180
M CA C370 S010 04 04	800 mm	key	-	180
M CA C270 P210 04 04	750 mm	code	-	180
M CA C370 P210 04 04	800 mm	code	-	180



Armadio dim. mm 561x726x400 H (27x36 EH)

ART.					H 890/1290 mm
M CA C270 S010 07 04	750 mm	key	-	180	
M CA C370 S010 07 04	800 mm	key	-	180	
M CA C270 P210 07 04	750 mm	code	-	180	
M CA C370 P210 07 04	800 mm	code	-	180	



2 ruote con freno in gomma standard Ø 125 mm
2 ruote fisse in gomma standard Ø 125 mm

CONFIGURA IL TUO BANCO



ART. M CA C270 S0 10 08 FD

Banco serie Master con 1 armadio a 3 cassetti
(H frontale 1x50 - 1x100 - 1x150) +
1 armadio a 2 cassetti (H frontale 1x100 - 1x200)
Ruote in gomma standard Ø 125 mm
Dim. mm 2000x750x840 H
COLORE ACCIAIO GRIGIO CHIARO RAL 7035 +
BLU GENZIANA RAL 5010
COLORE PLASTICHE DARK GREY
UTENSILI ESCLUSI

PORTATA BANCO
LUNGHEZZA 1300 mm

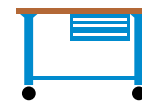
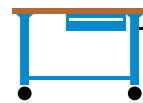
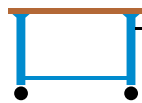

TIPO DI RUOTA	SPESSORE PIANO mm	kg	kg	kg
gomma standard	40	240	220	200
gomma antitraccia	40	240	220	200
gomma elastica	40	600	600	600
poliuretano	40	500	500	500
nylon	40	600	600	600

PORTATA BANCO
LUNGHEZZA 1500 mm

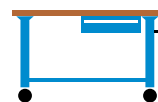
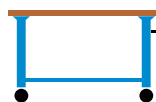

TIPO DI RUOTA	SPESSORE PIANO mm	kg	kg	kg
gomma standard	40	240	220	200
gomma antitraccia	40	240	220	200
gomma elastica	40	600	600	600
poliuretano	40	500	500	500
nylon	40	600	600	600

PORTATA BANCO
LUNGHEZZA 2000 mm

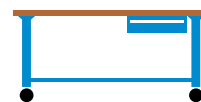

TIPO DI RUOTA	SPESSORE PIANO mm	kg	kg	kg
gomma standard	40	220	200	180
gomma antitraccia	40	220	200	180
gomma elastica	40	500	500	500
poliuretano	40	450	450	450
nylon	40	500	500	500

PIANI

MULTIPLEX
DI FAGGIO



3 STRATI
INCROCIATI
DI FAGGIO



MULTIPLEX
CON LAMINATO E
BORDI IN MASSELLO



GRIGIO

MULTIPLEX
CON LAMINATO E
BORDI IN MASSELLO

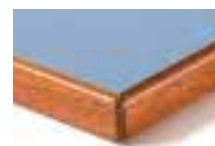

BLU

SPESSORE MM	DIM. mm	ART.	ART.	ART.	ART.
40	1300x750	F BI A228 00 00	-	F BH A228 00 08	F BH A228 00 04
	1300x800	F BI A328 00 00	-	F BH A328 00 08	F BH A328 00 04
	1500x750	F BI A242 00 00	-	F BH A242 00 08	F BH A242 00 04
	1500x800	F BI A342 00 00	-	F BH A342 00 08	F BH A342 00 04
	2000x750	F BI A270 00 00	-	F BH A270 00 08	F BH A270 00 04
	2000x800	F BI A370 00 00	-	F BH A370 00 08	F BH A370 00 04

**COPERTURA SPESSORE 12/10 mm IN ACCIAIO MICROFIORATO PER PIANI IN MULTIPLEX
PROVVISTA DI SAGOMATURA H 20 mm ANTERIORE E POSTERIORE A "L"
RESISTENTE ALL'ABRAZIONE E ALL'EFFETTO DEGLI OLI E DEI GRASSI**



DIM. mm	ART. SPESSORE 20 mm
1300x750	F BL 7915 00 99
1300x800	F BL 7920 00 99
1500x750	F BL 7930 00 99
1500x800	F BL 7935 00 99
2000x750	F BL 7960 00 99
2000x800	F BL 7965 00 99

**COPERTURA IN ACCIAIO 8/10 mm RIVESTITA IN GOMMA ANTIOLIO 12/10 - 15/10 mm
PER PIANI IN MULTIPLEX PROVVISTA DI SAGOMATURA H 20 mm ANTERIORE E POSTERIORE A "L"**



DIM. mm	ART. SPESSORE 20 mm
1300x750	F BL 2245 00 07
1300x800	F BL 2250 00 07
1500x750	F BL 2260 00 07
1500x800	F BL 2265 00 07
2000x750	F BL 2290 00 07
2000x800	F BL 2295 00 07

MULTIPLEX
RIVESTITO IN
LAMINATO



GRIGIO

MULTIPLEX
RIVESTITO IN
LAMINATO



BLU

PIANI ESD
A RICHIESTA



ART.	ART.
F BH B228 00 08	F BH B228 00 04
F BH B328 00 08	F BH B328 00 04
F BH B242 00 08	F BH B242 00 04
F BH B342 00 08	F BH B342 00 04
F BH B270 00 08	F BH B270 00 04
F BH B370 00 08	F BH B370 00 04





GAMBA CON RUOTE FISSE H 800 mm

ART.		Ruota Ø 125 mm
F BL 6075 A0 04		gomma standard
F BL 6075 G0 04		antitraccia
F BL 6075 D0 04		gomma elastica
F BL 6075 K0 04		poliuretano
F BL 6075 N0 04		nylon

Dim. mm 80x726x800 H



GAMBA CON RUOTE GIREVOLI CON FRENO E MANIGLIA H 800 mm

ART.		Ruota Ø 125 mm
F BL 6090 C0 04		gomma standard
F BL 6090 IO 04		antitraccia
F BL 6090 FO 04		gomma elastica
F BL 6090 MO 04		poliuretano
F BL 6090 Q0 04		nylon

Dim. mm 80x726x800 H



GAMBA REGOLABILE CON RUOTE FISSE H 850/1250 mm

ART.		Ruota Ø 125 mm
F BL 6055 A0 _ _		gomma standard
F BL 6055 G0 _ _		antitraccia
F BL 6055 D0 _ _		gomma elastica
F BL 6055 K0 _ _		poliuretano
F BL 6055 N0 _ _		nylon

Dim. mm 80x726x850/1250 H



GAMBA REGOLABILE CON RUOTE GIREVOLI CON FRENO E MANIGLIA H 850/1250 mm

ART.		Ruota Ø 125 mm
F BL 6056 C0 _ _		gomma standard
F BL 6056 IO _ _		antitraccia
F BL 6056 FO _ _		gomma elastica
F BL 6056 MO _ _		poliuretano
F BL 6056 Q0 _ _		nylon

Dim. mm 80x726x850/1250 H

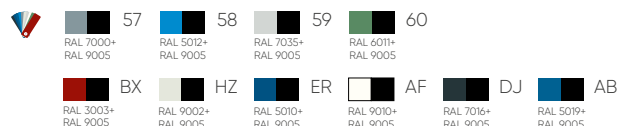
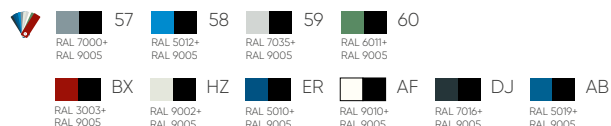

ART. F BL 9021 00 00
SET PREMONTAGGIO PER GAMBE
COMPRESIVO DI FORATURA E VITI DI
FISSAGGIO



TRAVERSO PER BANCHI MOBILI 1300 mm

ART.		Lunghezza mm	
F BL 6605 00 04		980	



TRAVERSO PER BANCHI MOBILI 1500 mm

ART.		Lunghezza mm	
F BL 6610 00 04		1180	



TRAVERSO PER BANCHI MOBILI 2000 mm

ART.		Lunghezza mm	
F BL 6620 00 04		1680	



WORK ROL - MASTER





ART. F BL 9011 00 00
FORATURA DEL PIANO IN LEGNO E VITI DI FISSAGGIO
ART. M 00 T030 MD 00 FO 00
FORATURA PIANO SUPERIORE DELL'ARMADIO

H 200 mm



Dim. mm 561x726x200 H

27x36 EH

ART.			
M 23 A020 C0 10 05 04	50-75-100	100-96-92%	key

ARMADIO SENZA CASSETTO ART. **M 23 A020 C0 00 00 04**
CASSETTO CON PLASTICHE DARK GREY ART. **M 23 C100 02 10 0F 04**
CASSETTO SENZA PLASTICHE DARK GREY ART. **M 23 C100 02 00 0F 04**

H 300 mm



Dim. mm 561x726x300 H

27x36 EH

ART.			
M 23 A030 C0 10 06 04	50-75-100	100-96-92%	key

ARMADIO SENZA CASSETTO ART. **M 23 A030 C0 00 00 04**
CASSETTO CON PLASTICHE DARK GREY ART. **M 23 C200 02 10 0F 04**
CASSETTO SENZA PLASTICHE DARK GREY ART. **M 23 C200 02 00 0F 04**

H 400 mm



Dim. mm 561x726x400 H

27x36 EH

ART.			
M 23 A040 S0 10 01 04	50-75-100	100-96-92%	key
M 23 A040 P2 10 01 04	50-75-100	100-96-92%	code

4 COLORI
3 DIVERSE LUNGHEZZE
AMPIA GAMMA DI RUOTE
ACCESSORIABILI CON
PARETI ATTREZZATE
ESTRAIBILITÀ CASSETTI 87%

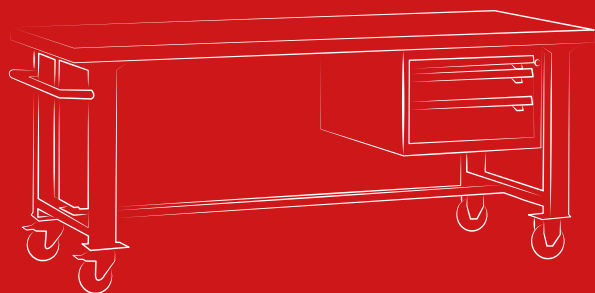
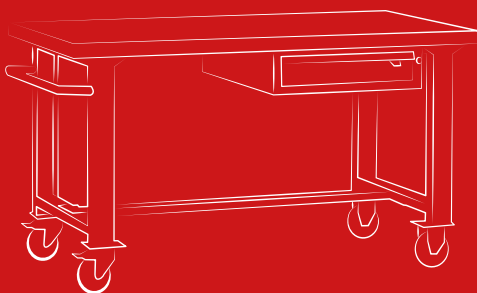



WORK ROL - STANDARD

CARATTERISTICHE TECNICHE

COLORI BANCO

 Gamma colori ACCIAIO



GRIGIO
RAL 7000
.01



VERDE
RAL 6011
.02



BLU
RAL 5012
.04



GRIGIO
RAL 7035
.08

MULTIPLEX
DI FAGGIO



MULTIPLEX
CON LAMINATO
E BORDI IN
MASSELLO



MULTIPLEX
CON LAMINATO
E BORDI IN
MASSELLO



MULTIPLEX
RIVESTITO IN
LAMINATO



MULTIPLEX
RIVESTITO IN
LAMINATO



ARMADI A CASSETTI

I cassetti sono forniti con estrazione semplice (pari al 87%) su cuscinetti a sfera ad alta resistenza. Il fondo forato e le pareti fessurate con passo 17 mm permettono un facile inserimento e fissaggio (tramite viti) dei divisori in metallo. Il dispositivo di apertura singola dei cassetti ne impedisce l'apertura accidentale durante la movimentazione.



87% = 70 kg

H FRONTALE 50 mm

87% = 50 kg

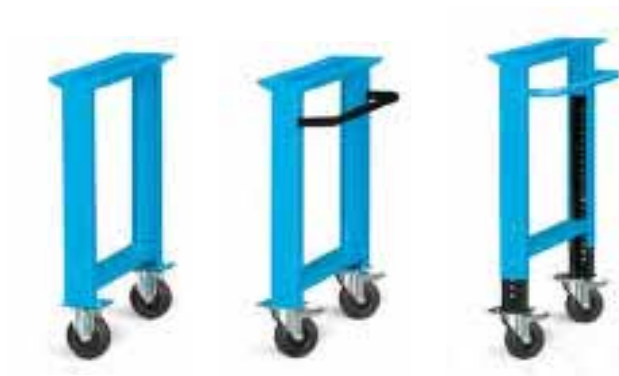

GAMBE FISSE E REGOLABILI CON RUOTE

Le gambe sono costruite in lamiera di acciaio con fori sulla parte superiore per il fissaggio al piano di lavoro e sulle piastre di base per il montaggio delle ruote, disponibili con diametro 125 mm e modelli adatti alle più svariate pavimentazioni. Presente anche la versione regolabile in altezza da 850 a 1250 mm tramite due allunghe forate a passo 25 mm (regolabili mediante fissaggio a vite). Nella gamba con ruote girevoli presente una comoda maniglia per movimentare il banco.



RUOTE IN
GOMMA
STANDARD



RUOTE IN
GOMMA
ANTISTRACCIA



RUOTE IN
GOMMA
ELASTICA



RUOTE IN
POLIURETANO



RUOTE IN
NYLON



CHIUSURA A CILINDRO

La serratura laterale permette la chiusura di tutti i cassetti inseriti nello stesso comparto. Il sistema può essere fornito in due altezze:

- H 600 mm nel caso in cui lo scomparto sia completamente riempito di cassetti
- H 150 mm nel caso in cui nello scomparto vengano inseriti la porta da 450 mm h e i cassetti.

FORNITA DI SERIE CON 2 CHIAVI

TRAVERSO DI COLLEGAMENTO e PIANO INFERIORE IN MULTIPLEX

Costruito in robusta lamiera di acciaio, piegata e sagomata, il traverso di collegamento funge da distanziere e irrigidimento tra le gambe; rendendo i banchi mobili estremamente robusti nella movimentazione con materiali pesanti. Il piano inferiore in multiplex, con spessore 25 mm, può essere applicato in sostituzione del traverso o utilizzato contemporaneamente.



SU RICHIESTA POSSONO ESSERE INSERITE LE PARETI ATTREZZATE

CONFIGURA IL TUO BANCO



PORTATA BANCO
LUNGHEZZA 1300 mm

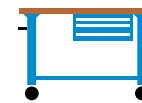
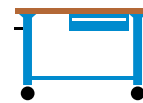
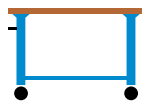

TIPO DI RUOTA	PIANO SPESSORE mm	kg	kg	kg
gomma standard	40	240	220	200
gomma antitraccia	40	240	220	200
gomma elastica	40	600	600	600
poliuretano	40	500	500	500
nylon	40	600	600	600

PORTATA BANCO
LUNGHEZZA 1500 mm

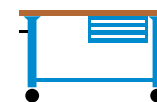
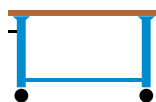

TIPO DI RUOTA	PIANO SPESSORE mm	kg	kg	kg
gomma standard	40	240	220	200
gomma antitraccia	40	240	220	200
gomma elastica	40	600	600	600
poliuretano	40	500	500	500
nylon	40	600	600	600

PORTATA BANCO
LUNGHEZZA 2000 mm



TIPO DI RUOTA	PIANO SPESSORE mm	kg	kg	kg
gomma standard	40	220	200	180
gomma antitraccia	40	220	200	180
gomma elastica	40	500	500	500
poliuretano	40	450	450	450
nylon	40	500	500	500

PIANI

MULTIPLEX
DI FAGGIO



3 STRATI
INCROCIATI DI
FAGGIO



MULTIPLEX
CON LAMINATO E
BORDI IN MASSELLO



GRIGIO

MULTIPLEX
CON LAMINATO E
BORDI IN MASSELLO

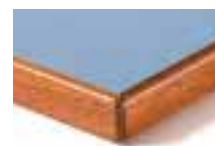

BLU

SPESSORE mm	DIM. mm	ART.	ART.	ART.	ART.
40	1300x750	F BI A228 00 00	-	F BH A228 00 08	F BH A228 00 04
	1300x800	F BI A328 00 00	-	F BH A328 00 08	F BH A328 00 04
	1500x750	F BI A242 00 00	-	F BH A242 00 08	F BH A242 00 04
	1500x800	F BI A342 00 00	-	F BH A342 00 08	F BH A342 00 04
	2000x750	F BI A270 00 00	-	F BH A270 00 08	F BH A270 00 04
	2000x800	F BI A370 00 00	-	F BH A370 00 08	F BH A370 00 04



GAMBA CON RUOTE FISSE H 800 mm

ART.	Ruota Ø 125 mm
F BL 6075 A0 04	gomma standard
F BL 6075 G0 04	antitraccia
F BL 6075 D0 04	gomma elastica
F BL 6075 K0 04	poliuretano
F BL 6075 N0 04	nylon

Dim. mm 80x726x800 H



GAMBA CON RUOTE GIREVOLI CON FRENO
E MANIGLIA H 800 mm

ART.	Ruota Ø 125 mm
F BL 6090 C0 04	gomma standard
F BL 6090 I0 04	antitraccia
F BL 6090 F0 04	gomma elastica
F BL 6090 M0 04	poliuretano
F BL 6090 Q0 04	nylon

Dim. mm 80x726x800 H



ART. F BL 9021 00 00
SET PREMONTAGGIO PER GAMBE
COMPENSIVO DI FORATURA E VITI DI
FISSAGGIO

MULTIPLEX RIVESTITO IN LAMINATO



GRIGIO

MULTIPLEX RIVESTITO IN LAMINATO



BLU

PIANI ESD A RICHIESTA



ART.	ART.
F BH B228 00 08	F BH B228 00 04
F BH B328 00 08	F BH B328 00 04
F BH B242 00 08	F BH B242 00 04
F BH B342 00 08	F BH B342 00 04
F BH B270 00 08	F BH B270 00 04
F BH B370 00 08	F BH B370 00 04



GAMBA REGOLABILE CON RUOTE FISSE H 850/1250 mm

ART.	Ruota Ø 125 mm
F BL 6055 A0 _ _	gomma standard
F BL 6055 G0 _ _	antitraccia
F BL 6055 D0 _ _	gomma elastica
F BL 6055 K0 _ _	poliuretano
F BL 6055 N0 _ _	nylon

Dim. mm 80x726x850/1250 H



GAMBA REGOLABILE CON RUOTE GIREVOLI CON FRENO E MANIGLIA H 850/1250 mm

ART.	Ruota Ø 125 mm
F BL 6056 C0 _ _	gomma standard
F BL 6056 I0 _ _	antitraccia
F BL 6056 F0 _ _	gomma elastica
F BL 6056 M0 _ _	poliuretano
F BL 6056 Q0 _ _	nylon

Dim. mm 80x726x850/1250 H





TRAVERSO PER BANCHI MOBILI 1300 mm

ART.		Lunghezza mm	
F BL 6605 00 04		980	



TRAVERSO PER BANCHI MOBILI 1500 mm

ART.		Lunghezza mm	
F BL 6610 00 04		1180	

1 cassetto

100



27x36 EH

ART.		Dim. mm	kg	
F DE 1010 01 04		565x725x155 H	60	87%

Chiusura laterale

1 cassetto

200



27x36 EH

ART.		Dim. mm	kg	
F DE 1020 01 04		565x725x255 H	60	87%

Chiusura laterale

2 cassetti

50

150



27x36 EH

ART.		Dim. mm	kg	
F DE 1020 02 04		565x725x255 H	60	87%

Chiusura laterale

3 cassetti

50

100

150



27x36 EH

ART.		Dim. mm	kg	
F DE 1030 02 04		565x725x355 H	60	87%

Chiusura laterale

4 cassetti

50

100

100

200



27x36 EH

ART.		Dim. mm	kg	
F DE 1045 04 04		565x725x505 H	40	87%

Chiusura laterale



ART. F BL 9011 00 00

SET PREMONTAGGIO PER ARMADIO
COMPRESIVO DI FORATURA E VITI DI
FISSAGGIO



TRAVERSO PER BANCHI MOBILI 2000 mm

ART.		Lunghezza mm
F BL 6620 00 04		1680



ART. F CA C328 S1 04

Dim. mm 1340x820x1000 H
 Banco a 3 cassetti con ruote
 Completo di bordi e morsa
 Escluso utensili e set di suddivisione
 dei cassetti

L'EVOLUZIONE DEL BANCO MOBILE

10 COLORI ACCIAIO

8 COLORI PLASTICHE

CHIUSURA A CILINDRO

O CODICE NUMERICO

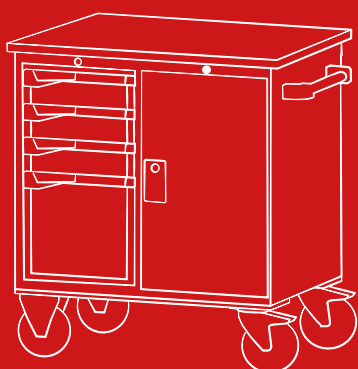



WORK MOBILE - MASTER

CARATTERISTICHE TECNICHE

COLORI

10 colori per la gamma acciaio

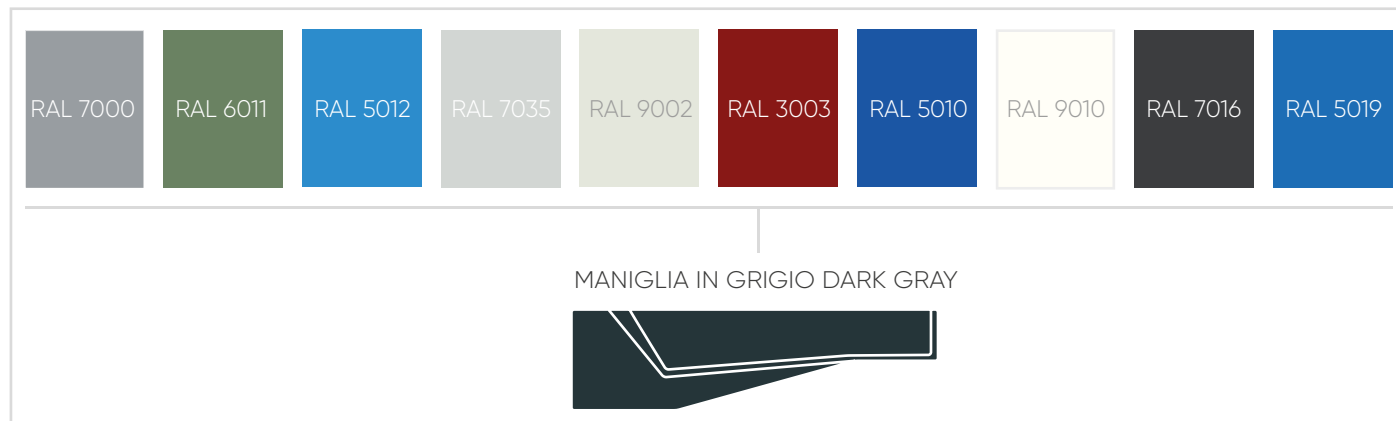

SU RICHIESTA ALTRE VARIANTI DI COLORE



ARMADI A CASSETTI

Nuova guida ad estrazione flessibile con regolazione meccanica del fermo posteriore del cassetto in 3 diverse posizioni.



92% = 100 kg

96% = 75 kg

100% = 50 kg

ASTA VERTEBRATA

L'asta è in profilato d'alluminio e rimane sempre fissa, senza ruotare. Il movimento di chiusura è ottenuto da tasselli che si spostano verticalmente sfruttando una delle forze elementari della fisica: la gravità. Più il movimento è semplice, meno probabilità di rotture ci sono. La chiusura dell'asta è affidata a un sistema a catenaccio posto sulla testa dell'asta.



CHIUSURA CON CILINDRO



SISTEMA DI TRASMISSIONE DAL CILINDRO DELLA CHIUSURA ALLA TESTA DELL'ASTA VERTEBRATA A FILO DI ACCIAIO CON GUAINA ELASTICA E MOVIMENTO LINEARE.

La chiusura a cilindro è suddivisa in 23 diverse serie: ogni serie ha una numerazione delle chiavi compresa tra 1 e 160, per un totale di 3.680 diverse combinazioni.

FORNITA DI SERIE CON 2 CHIAVI

PUSH TO OPEN- APERTURA SINGOLA DEI CASSETTI

Rispetto ai comuni sistemi che prevedono l'aggiunta di ulteriori componenti sul frontale, l'apertura singola dei cassetti è integrata nel cilindro. Per aprirli basta premere il cilindro della serratura. Meno componenti servono per un meccanismo, meno possibilità di rottura ci sono.

CHIUSURA CON CODICE NUMERICO

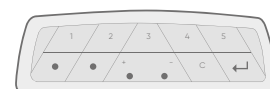

Oltre alla normale chiusura a cilindro, Fami ha deciso di aggiungere alle proprie chiusure la chiusura CODE. La serratura a codice numerico comanda l'apertura e la chiusura dell'asta vertebrata. Gestisce fino a 10 utenti con codice numerico da 3 a 8 cifre. Il download storico degli eventi è possibile tramite cavo collegando il tastierino al pc. Disponibili su richiesta fino a 10 telecomandi.

BORDI PER PIANI IN MULTIPLEX



Bordo posteriore



Bordo laterale

I bordi di contenimento sono in multiplex di faggio e vengono fissati al piano superiore con viti autofilettanti. Lo spessore è 12 mm e l'altezza di 100 mm.

Pratici e robusti per il contenimento di materiali durante la movimentazione del banco.

ACCESSORI



ESEMPIO DI UTILIZZO:

TAPPARELLA











PARETE ATTREZZATA



● **ART. M 02 BM11 A114 10 NN**

H = 928 mm - 1 porta - 6 cassetti

 Gamma colori ACCIAIO

									
GRIGIO RAL 7000 .01	VERDE RAL 6011 .02	BLU RAL 5012 .04	GRIGIO RAL 7035 .08	BIANCO GRIGIASTRO RAL 9002 .1F	ROSSO RUBINO RAL 3003 .1G	BLU GENZIANA RAL 5010 .34	BIANCO PURO RAL 9010 .35	GRIGIO ANTRACITE RAL 7016 .39	BLU CAPRI RAL 5019 .48

Gamma colori
PLASTICHE

 DARK GREY
.M0

LEGENDA



CHIUSURA



PORTATA
BANCO



LE PORTATE SONO NETTE E SI RIFERISCONO A PESI UNIFORMEMENTE DISTRIBUITI

PIANO IN MULTIPLEX 860x600 mm SPESSORE 25 mm

H 908 mm



ART.			
M 02 BH11 S010 01 04		key	250
M 02 BH11 A110 01 04		code	250

H 908 mm



ART.			
M 02 BH11 C010 02 04		key	250
M 02 BH11 P510 02 04		code	250

H 908 mm



ART.			
M 02 BH11 S010 03 04		key	250
M 02 BH11 A110 03 04		code	250

H 908 mm



ART.			
M 02 BH11 S010 04 04		key	250
M 02 BH11 P210 04 04		code	250



2 ruote con freno in gomma standard Ø 150 mm
2 ruote fisse in gomma standard Ø 150 mm

H 908 mm

H 908 mm



ART.				
M 02 BH11 C010 05 04		key	250	
M 02 BH11 P510 05 04		code	250	

ART.				
M 02 BH11 S010 06 04		key	250	
M 02 BH11 P210 06 04		code	250	



2 ruote con freno in gomma standard Ø 150 mm
2 ruote fisse in gomma standard Ø 150 mm

ACCESSORI



BORDO POSTERIORE

ART.	Dim. mm	
F BL 5690 00 00	860x12x100 H	



BORDO LATERALE

ART.	Dim. mm	
F BL 5595 00 00	612x12x100 H	



ART. M 02 BM11 A114 10 NN

BANCO MOBILE CON PIANO IN MULTIPLEX 25 mm,
Completo di 6 cassetti ad estrazione flessibile,
(2x75, 2x100, 1x125, 1x300)
1 porta 425 mm H, 1 piano ad estrazione flessibile.
Ruote in poliuretano Ø 160 mm
Dim. mm 915x600x928 H
COLORE ACCIAIO ROSSO RUBINO RAL 3003 +
BIANCO PURO RAL 9010
COLORE PLASTICHE RED CARPET
ESCLUSO TERMOFORMATI ED UTENSILI



● ART. M 02 BH12 A114 01 PV
H = 908 mm - 1 porta - 6 cassetti

Gamma colori ACCIAIO

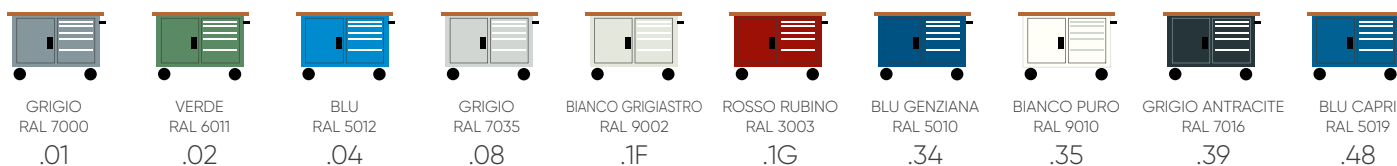

Gamma colori PLASTICHE



LEGENDA



CHIUSURA



PORTATA
BANCO



LE PORTATE SONO NETTE E SI RIFERISCONO A PESI UNIFORMEMENTE DISTRIBUITI

PIANO IN MULTIPLEX 995x600 mm SPESSORE 25 mm

H 908 mm



porta 600 mm H

ART.				
M 02 BH12 C010 07 04		key	250	
M 02 BH12 P510 07 04		code	250	

H 908 mm



porta 425 mm H

ART.				
M 02 BH12 S010 03 04		key	250	
M 02 BH12 A110 03 04		code	250	

H 908 mm



porta 600 mm H

ART.				
M 02 BH12 C010 02 04		key	250	
M 02 BH12 P510 02 04		code	250	

H 908 mm



porta 425/600 mm H

ART.				
M 02 BH12 C010 05 04		key	250	
M 02 BH12 P510 05 04		code	250	



2 ruote con freno in gomma standard Ø 150 mm
2 ruote fisse in gomma standard Ø 150 mm

H 908 mm



ART.			
M 02 BH12 S010 08 04		key	250
M 02 BH12 P210 08 04		code	250

H 908 mm



ART.			
M 02 BH12 S010 09 04		key	250
M 02 BH12 P210 09 04		code	250



2 ruote con freno in gomma standard Ø 150 mm
2 ruote fisse in gomma standard Ø 150 mm

ACCESSORI



BORDO POSTERIORE

ART.	Dim. mm
F BL 5705 00 00	995x12x100 H



BORDO LATERALE

ART.	Dim. mm
F BL 5595 00 00	612x12x100 H



ART. M 02 BH12 A114 01 PV









BANCO MOBILE CON PIANO IN MULTIPLEX 25 mm,
Completo di 6 cassetti ad estrazione flessibile,
(1x75, 4x100, 1x300)
1 porta 425 mm H, 1 piano ad estrazione flessibile.
Ruote in gomma standard Ø 150 mm
Dim. mm 1059x600x908 H
COLORE ACCIAIO GRIGIO ANTRACITE RAL 7016 +
BIANCO PURO RAL 9010
COLORE PLASTICHE RED CARPET
ESCLUSO TERMOFORMATI ED UTENSILI



● **ART. M 02 BH22 P216 08 CQ**

H = 913 mm - 8 cassetti

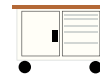
 Gamma colori ACCIAIO

									
GRIGIO RAL 7000 .01	VERDE RAL 6011 .02	BLU RAL 5012 .04	GRIGIO RAL 7035 .08	BIANCO GRIGIASTRO RAL 9002 .1F	ROSSO RUBINO RAL 3003 .1G	BLU GENZIANA RAL 5010 .34	BIANCO PURO RAL 9010 .35	GRIGIO ANTRACITE RAL 7016 .39	BLU CAPRI RAL 5019 .48

Gamma colori
PLASTICHE

 DARK GREY
.M0

LEGENDA



CHIUSURA



PORTATA
BANCO



LE PORTATE SONO NETTE E SI RIFERISCONO A PESI UNIFORMEMENTE DISTRIBUITI.

PIANO IN MULTIPLEX 1150x700 mm SPESSORE 30 mm

H 913 mm



ART.			kg
M 02 BH22 C010 07 04		key	250
M 02 BH22 P510 07 04		code	250

H 913 mm



ART.			kg
M 02 BH22 S010 03 04		key	250
M 02 BH22 A110 03 04		code	250

H 913 mm



ART.			kg
M 02 BH22 C010 02 04		key	250
M 02 BH22 P510 02 04		code	250

H 913 mm



ART.			kg
M 02 BH22 C010 05 04		key	250
M 02 BH22 P510 05 04		code	250



2 ruote con freno in gomma standard Ø 150 mm
2 ruote fisse in gomma standard Ø 150 mm

H 913 mm



ART.			
M 02 BH22 S010 08 04		key	250
M 02 BH22 P210 08 04		code	250

H 913 mm



ART.			
M 02 BH22 S010 09 04		key	250
M 02 BH22 P210 09 04		code	250



2 ruote con freno in gomma standard Ø 150 mm
2 ruote fisse in gomma standard Ø 150 mm

ACCESSORI



BORDO POSTERIORE

ART.	Dim. mm
F BL 5715 00 00	1150x12x100 H



BORDO LATERALE

ART.	Dim. mm
F BL 5605 00 00	712x12x100 H



ART. M 02 BH22 P216 08 CQ

BANCO MOBILE CON PIANO IN MULTIPLEX 30 mm,
Completo di 8 cassetti ad estrazione flessibile
(6x100, 2x300)

Ruote in gomma standard Ø 150 mm

Dim. mm 1213x700x913 H

COLORE ACCIAIO GRIGIO ANTRACITE RAL 7016 +

BIANCO GRIGIASTRO RAL 9002

COLORE PLASTICHE SUNNY YELLOW









ESCLUSO TERMOFORMATI ED UTENSILI



● **ART. M 02 BH13 P512 02 PB**

H = 913 mm - 1 porta - 4 cassetti
(3x100, 1x300, 1 piano estraibile)

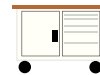
 Gamma colori ACCIAIO

									
GRIGIO RAL 7000 .01	VERDE RAL 6011 .02	BLU RAL 5012 .04	GRIGIO RAL 7035 .08	BIANCO GRIGIASTRO RAL 9002 .1F	ROSSO RUBINO RAL 3003 .1G	BLU GENZIANA RAL 5010 .34	BIANCO PURO RAL 9010 .35	GRIGIO ANTRACITE RAL 7016 .39	BLU CAPRI RAL 5019 .48

Gamma colori
PLASTICHE

 DARK GREY
.M0

LEGENDA



CHIUSURA



PORTATA
BANCO



LE PORTATE SONO NETTE E SI RIFERISCONO A PESI UNIFORMEMENTE DISTRIBUITI

PIANO IN MULTIPLEX 1150x700 mm SPESSORE 30 mm

H 913 mm



ART.				
M 02 BH13 C010 07 04		key	250	
M 02 BH13 P510 07 04		code	250	

H 913 mm



ART.				
M 02 BH13 S010 03 04		key	250	
M 02 BH13 A110 03 04		code	250	

H 913 mm



ART.				
M 02 BH13 C010 05 04		key	250	
M 02 BH13 P510 05 04		code	250	

H 913 mm



ART.				
M 02 BH13 S010 09 04		key	250	
M 02 BH13 P210 09 04		code	250	

BORDO POSTERIORE



ART.	Dim. mm	
F BL 5715 00 00	1150x12x100 H	

BORDO LATERALE



ART.	Dim. mm	
F BL 5605 00 00	712x12x100 H	



2 ruote con freno in gomma standard Ø 150 mm
2 ruote fisse in gomma standard Ø 150 mm

CAPIENTI

MANEGGEVOLI

ROBUSTI

4 COLORI

ESTRAIBILITÀ CASSETTI 100%





WORK MOBILE - FLEXA

CARATTERISTICHE TECNICHE

COLORI BANCO

4 colori per la parte metallica

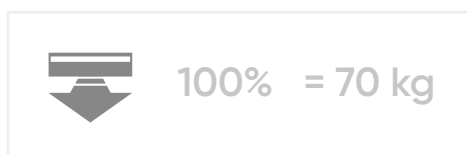

ARMADI A CASSETTI

I cassetti e i piani estraibili sono forniti di serie con estrazione totale (pari al 100%) su cuscinetti a sfera ad alta resistenza. Il fondo forato e le pareti fessurate con passo 17 mm permettono un facile inserimento e fissaggio (tramite viti) dei divisori in metallo.

ASTA ANTIRIBALTAMENTO

L'asta di chiusura funge da sistema antiribaltamento nel momento in cui il cassetto viene estratto. Il gancio posteriore del cassetto (A) fa ruotare in posizione di chiusura l'asta posteriore (B). In questo modo è impedita all'operatore l'estrazione simultanea di più cassetti, evitando un pericoloso spostamento del peso verso l'esterno.

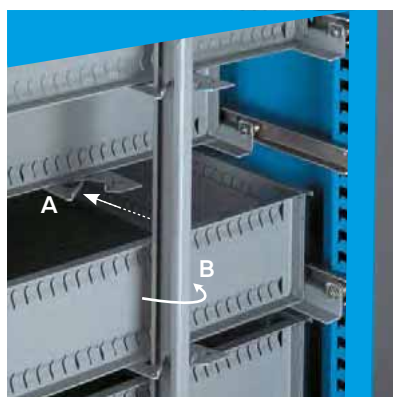

DISPOSITIVO DI
APERTURA SINGOLA
DEI CASSETTI

CHIUSURA CON CILINDRO

La chiusura con cilindro è collegata tramite un'asta quadra (C) al gruppo di chiusura posteriore, composto di un elemento rotante e dall'asta antiribaltamento. Girando la chiave (D) si aziona il sistema a camme del gruppo di chiusura che fa ruotare l'asta.

FORNITA DI SERIE CON 2 CHIAVI

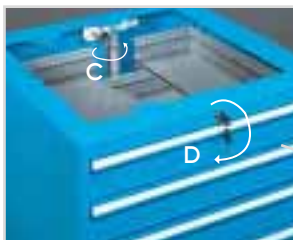

La maniglia viene applicata sul fianco dell'armadio



Le porte sono già predisposte per essere montate sia con apertura a destra che a sinistra. Quando l'armadio è provvisto della porta, sia la serratura dell'armadio che quella della porta vengono fornite con chiavi uguali.

BORDI PER PIANO IN MULTIPLEX

I bordi di contenimento sono in multiplex di faggio e vengono fissati al piano superiore con viti autofilettanti. Lo spessore è 12 mm e l'altezza di 100 mm. Pratici e robusti per il contenimento di materiali durante la movimentazione del banco.



Bordo posteriore



Bordo laterale

ACCESSORI



ESEMPIO DI UTILIZZO:

**PARETE
ATTREZZATA**

TAPPARELLA

VISUAL BOX



● ART. F CB H420 01 04
H = 910 mm - 1 porta + 4 cassetti

 Gamma colori ACCIAIO



GRIGIO
RAL 7000
.01



VERDE
RAL 6011
.02



BLU
RAL 5012
.04



GRIGIO
RAL 7035
.08

LEGENDA



CHIUSURA



PORTATA
BANCO



LE PORTATE SONO NETTE E SI RIFERISCONO A PESI UNIFORMEMENTE DISTRIBUITI.

PIANO IN MULTIPLEX 995x600 mm SPESSORE 25 mm

H 910 mm



ART.			
F CB H420 01 04		key	250

1 serratura con asta antiribaltamento

H 910 mm



ART.			
F CB H420 02 04		key	250

2 serrature con asta laterale 300 mm H

H 910 mm



ART.			
F CB H420 03 04		key	250

2 serrature con asta antiribaltamento

H 910 mm



ART.			
F CB H420 04 04		key	250

1 serratura con asta antiribaltamento

BORDO POSTERIORE



ART.	Dim. mm
F BL 5705 00 00	995x12x100 H

BORDO LATERALE



ART.	Dim. mm
F BL 5595 00 00	612x12x100 H



2 ruote con freno in gomma standard Ø 150 mm
2 ruote fisse in gomma standard Ø 150 mm



● **ART. F CB H510 01 04**

H = 915 mm - 1 porta + 4 cassetti

 Gamma colori ACCIAIO



GRIGIO
RAL 7000
.01



VERDE
RAL 6011
.02



BLU
RAL 5012
.04



GRIGIO
RAL 7035
.08

LEGENDA



CHIUSURA



PORTATA
BANCO



LE PORTATE SONO NETTE E SI RIFERISCONO A PESI UNIFORMEMENTE DISTRIBUITI.

PIANO IN MULTIPLEX 1150x700 mm SPESSORE 30 mm

H 915 mm



ART.			
F CB H510 01 04		key	250

1 serratura con asta antiribaltamento

H 915 mm



ART.			
F CB H510 03 04		key	250

2 serrature con asta antiribaltamento

H 915 mm



ART.			
F CB H510 04 04		key	250

1 serratura con asta antiribaltamento

H 915 mm



ART.			
F CB H510 06 04		key	250

1 serratura con asta antiribaltamento



BORDO POSTERIORE

ART.	Dim. mm
F BL 5715 00 00	1150x12x100 H



BORDO LATERALE

ART.	Dim. mm
F BL 5605 00 00	712x12x100 H



2 ruote con freno in gomma standard Ø 150 mm
2 ruote fisse in gomma standard Ø 150 mm



● ART. F CB H610 01 04

H = 915 mm - 1 porta + 4 cassetti

 Gamma colori ACCIAIO



GRIGIO
RAL 7000
.01



VERDE
RAL 6011
.02



BLU
RAL 5012
.04



GRIGIO
RAL 7035
.08

LEGENDA



CHIUSURA



PORTATA
BANCO



LE PORTATE SONO NETTE E SI RIFERISCONO A PESI UNIFORMEMENTE DISTRIBUITI.

PIANO IN MULTIPLEX 1150x700 mm SPESSORE 30 mm

H 915 mm



ART.				
F CB H610 01 04		key	250	
1 serratura con asta antiribaltamento				

H 915 mm



ART.				
F CB H610 04 04		key	250	
1 serratura con asta antiribaltamento				

H 915 mm



ART.				
F CB H610 03 04		key	250	
2 serrature con asta antiribaltamento				

H 915 mm



ART.				
F CB H630 01 04		key	250	
1 serratura con asta antiribaltamento 4 cassettiere serie VISUAL BOX ART. FAXVBCH00500001				



BORDO POSTERIORE

ART.	Dim. mm	
F BL 5715 00 00	1150x12x100 H	
NON ADATTO PER ART. F CB H630 01 04		



BORDO LATERALE

ART.	Dim. mm	
F BL 5605 00 00	712x12x100 H	
NON ADATTO PER ART. F CB H630 01 04		



2 ruote con freno in gomma standard Ø 150 mm
2 ruote fisse in gomma standard Ø 150 mm

**LA MULTIPOSTAZIONE
A 360 GRADI IDEALE
PER LAVORO IN TEAM
4 COLORI
ESTRAIBILITÀ CASSETTI 100%**





WORK - ESA



● **ART. F BF 1505 01 04**
H = 850 mm - 6 cassetiere 27x36 EH

Gamma colori ACCIAIO



GRIGIO
RAL 7000
.01



VERDE
RAL 6011
.02



BLU
RAL 5012
.04



GRIGIO
RAL 7035
.08

LEGENDA



SPESSORE
PIANO



CHIUSURA



PORTATA



LE PORTATE SONO NETTE E SI RIFERISCONO A PESI UNIFORMEMENTE DISTRIBUITI.

H 840/850 mm



H 840/850 mm



ART.				
F BF 1505 01 04		50	key	1000
F BF 1405 01 04		40	key	800

1 piano in Multiplex - 6 cassettiere cadauna con 5 cassetti ad estrazione semplice 27x36 EH

ART.				
F BF 1505 03 04		50	key	1000
F BF 1405 03 04		40	key	800

1 piano in Multiplex - 6 cassettiere cadauna con 5 cassetti ad estrazione semplice 19x27 EH - 6 gambe per allacciamenti cablate complete cadauna di 4 prese Schuko con magnetotermico 2P 230V AC 10A

H 840/850 mm



H 840/850 mm



ART.				
F BF 1505 04 04		50	key	1000
F BF 1405 04 04		40	key	800

1 piano in Multiplex - 6 cassettiere cadauna con 5 cassetti ad estrazione semplice 19x27 EH - 6 armadi con morse da 120 mm in acciaio regolabili in altezza, girevoli e ripiegabili all'interno dell'armadio. L'armadio è completo di porta.

ART.				
F BF 1505 02 04		50	key	1000
F BF 1405 02 04		40	key	800

1 piano in Multiplex - 6 cassettiere cadauna con 5 cassetti ad estrazione semplice 19x27 EH - 6 gambe per allacciamenti cablate complete cadauna di 4 prese Schuko con magnetotermico 2P 230V AC 10A - 6 morse da 120 mm in acciaio regolabili in altezza, girevoli e ripiegabili sotto il piano in legno.



TORRETTE
NON
CABLATE



TORRETTA CON PRESE

ART.				
F BF 8145 01 04		30	-	-

6 scatole porta prese - 1 magnetotermico differenziale 2P 230V AC 16A IA N=0,03A - 16 prese Schuko 220-250V 16 A 2P+T
Dimensioni mm 800x922x230 H

TORRETTA CON PRESE

ART.				
F BF 8145 02 04		30	-	-

6 scatole porta prese - 1 magnetotermico differenziale 2P 230V AC 16A IA N=0,03A - 11 prese Schuko 220-250V 16 A 2P+T - 5 prese industriali 220-250V 16A 2P+T. Dimensioni mm 800x922x230 H

PARETI ATTREZZATE

PERFETTA INTEGRAZIONE DI

COMPONENTI ED ACCESSORI

MOLTEPLICI SOLUZIONI PERSONALIZZABILI

AMPLIABILI IN QUALSIASI MOMENTO

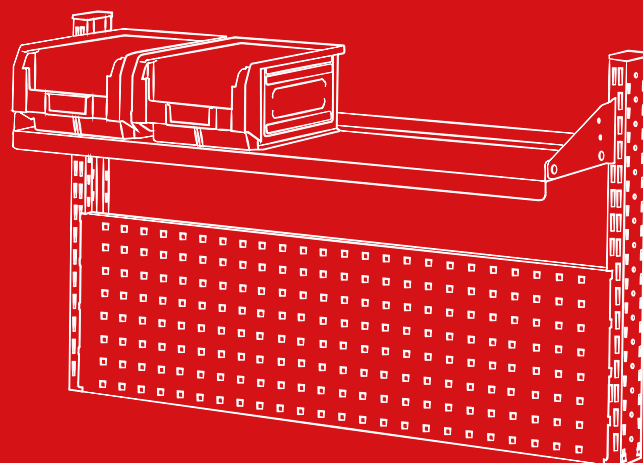



WORK LOOK



SOLUZIONE 4

Gamma colori ACCIAIO



PER PIANI IN LEGNO



GRIGIO
RAL 7000
.01



VERDE
RAL 6011
.02



BLU
RAL 5012
.04



GRIGIO
RAL 7035
.08



BIANCO GRIGIASTRO
RAL 9002
.1F



ROSSO RUBINO
RAL 3003
.1G



BLU GENZIANA
RAL 5010
.34

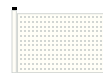

BIANCO PURO
RAL 9010
.35



GRIGIO ANTRACITE
RAL 7016
.39



BLU CAPRI
RAL 5019
.48



LE PORTATE SONO NETTE E SI RIFERISCONO A PESI UNIFORMEMENTE DISTRIBUITI.

H 634 mm



ART. 

F BL A010 03 04

2 montanti 634 mm H ART. F BL 7530 00 04
2 pannelli forati 972x304 mm ART. F BL 7620 00 04

H 634 mm

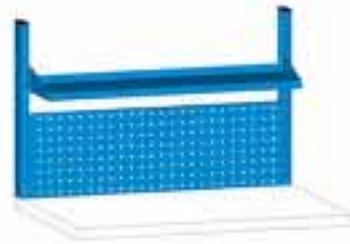

ART. 

F BL A010 25 04

2 montanti 634 mm H ART. F BL 7530 00 04
1 pannello forato 972x304 mm ART. F BL 7620 00 04
1 mensola 955x220 mm ART. F BL 7750 00 04

H 938 mm



ART. 

F BL A010 04 04

2 montanti 938 mm H ART. F BL 7535 00 04
3 pannelli forati 972x304 mm ART. F BL 7620 00 04

H 938 mm



ART. 

F BL A010 26 04

2 montanti 938 mm H ART. F BL 7535 00 04
1 pannello forato 972x304 mm ART. F BL 7620 00 04
1 mensola 955x320 mm ART. F BL 7755 00 04

H 1242 mm



ART. 

F BL A010 27 04

2 montanti 1242 mm H ART. F BL 7540 00 04
1 pannello forato 972x304 mm ART. F BL 7620 00 04
1 mensola 955x220 mm ART. F BL 7750 00 04
1 mensola 955x320 mm ART. F BL 7755 00 04

H 1272 mm



ART. 

F BL A010 28 04

2 montanti 1242 mm H ART. F BL 7540 00 04
1 pannello forato 972x304 mm ART. F BL 7620 00 04
1 mensola 955x220 mm ART. F BL 7750 00 04
1 mensola 955x320 mm ART. F BL 7755 00 04
1 coppia di supporti con binario base in alluminio ART. F BL 9810 10 00
2 supporti singoli per binario mm 34x750x11 H ART. F BL 9805 00 04

H 1242 mm



ART. 
F BL A010 13 04

2 montanti 1242 mm H ART. F BL 7540 00 04
1 pannello forato 972x304 mm ART. F BL 7620 00 04
1 armadio a tapparella ART. F BL 7011 02 04

H 1272 mm



ART. 
F BL A010 29 04

2 montanti 1242 mm H ART. F BL 7540 00 04
1 pannello forato 972x304 mm ART. F BL 7620 00 04
1 armadio a tapparella ART. F BL 7011 02 04
1 coppia di supporti con binario base in alluminio ART. F BL 9810 10 00
2 supporti singoli per binario mm 34x750x11 H ART. F BL 9805 00 04



SOLUZIONE 1





SOLUZIONE 2

H 634 mm

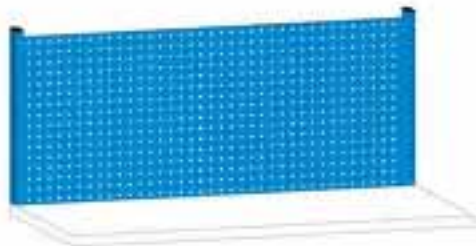

ART.



F BL A015 06 04

2 montanti 634 mm H ART. F BL 7530 00 04
2 pannelli forati 1457x304 mm ART. F BL 7635 00 04

H 634 mm



ART.



F BL A015 05 04

2 montanti 634 mm H ART. F BL 7530 00 04
1 pannello forato 1457x304 mm ART. F BL 7635 00 04
1 mensola 1440x220 mm ART. F BL 7795 00 04

H 938 mm

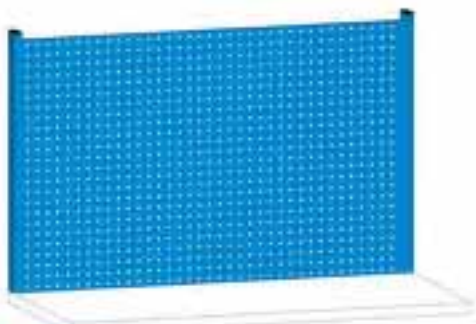

ART.



F BL A015 07 04

2 montanti 938 mm H ART. F BL 7530 00 04
3 pannelli forati 1457x304 mm ART. F BL 7635 00 04

H 938 mm

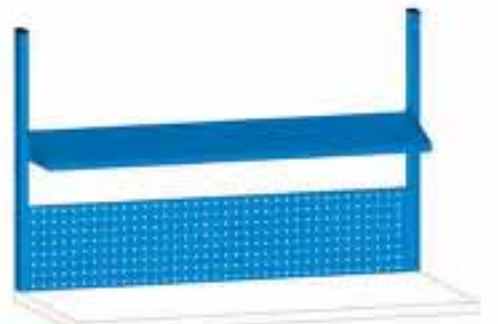

ART.



F BL A015 22 04

2 montanti 938 mm H ART. F BL 7530 00 04
1 pannello forato 1457x304 mm ART. F BL 7635 00 04
1 mensola 1440x320 mm ART. F BL 7800 00 04

H 1242 mm

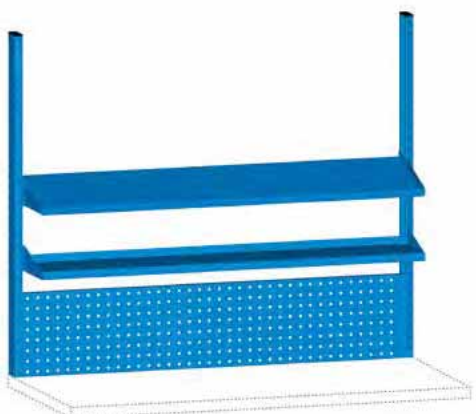

ART.



F BL A015 23 04

2 montanti 1242 mm H ART. F BL 7540 00 04
1 pannello forato 1457x304 mm ART. F BL 7635 00 04
1 mensola 1440x220 mm ART. F BL 7795 00 04
1 mensola 1440x320 mm ART. F BL 7800 00 04

H 1272 mm

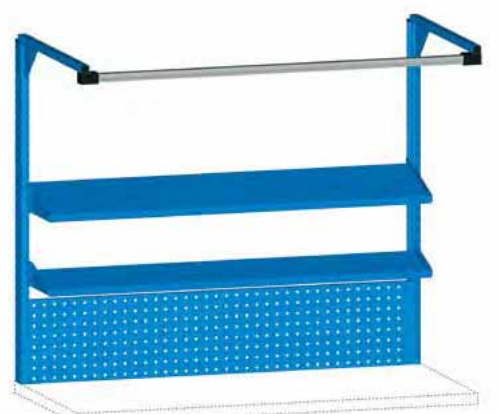

ART.



F BL A015 24 04

2 montanti 1242 mm H ART. F BL 7540 00 04
1 pannello forato 1457x304 mm ART. F BL 7635 00 04
1 mensola 1440x220 mm ART. F BL 7795 00 04
1 mensola 1440x320 mm ART. F BL 7800 00 04
1 coppia di supporti con binario base in alluminio ART. F BL 9815 10 00
2 supporti singoli per binario mm 34x750x11 H ART. F BL 9805 00 04

H 634 mm

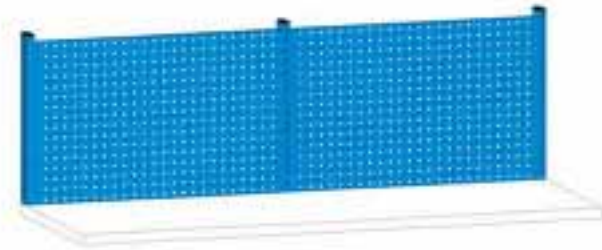

ART.



F BL A020 07 04

3 montanti 634 mm H ART. F BL 7530 00 04
4 pannelli forati 972x304 mm ART. F BL 7620 00 04

H 634 mm

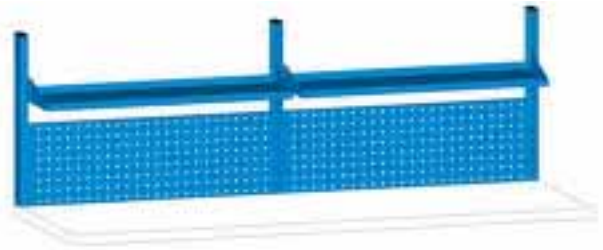

ART.



F BL A020 05 04

3 montanti 634 mm H ART. F BL 7530 00 04
2 pannelli forati 972x304 mm ART. F BL 7620 00 04
2 mensole 955x320 mm ART. F BL 7755 00 04

H 938 mm

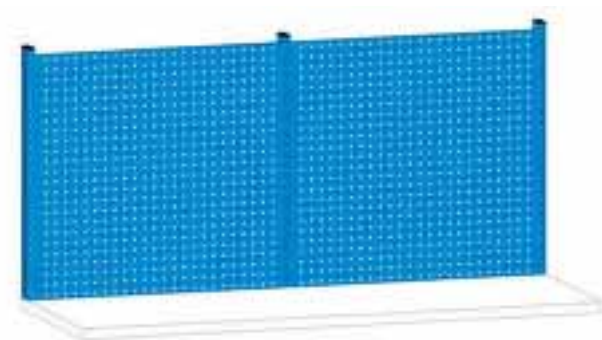

ART.



F BL A020 08 04

3 montanti 938 mm H ART. F BL 7535 00 04
6 pannelli forati 972x304 mm ART. F BL 7620 00 04

H 938 mm

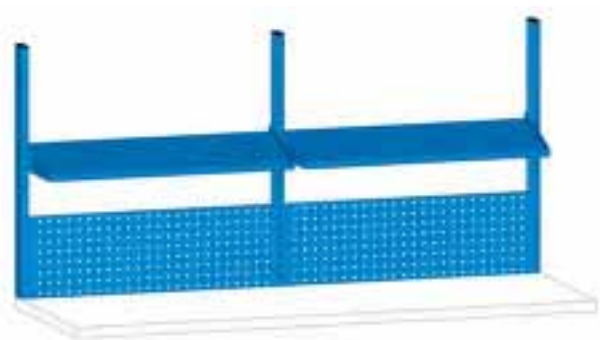

ART.



F BL A020 38 04

3 montanti 938 mm H ART. F BL 7535 00 04
2 pannelli forati 972x304 mm ART. F BL 7620 00 04
2 mensole 955x320 mm ART. F BL 7755 00 04

H 1242 mm

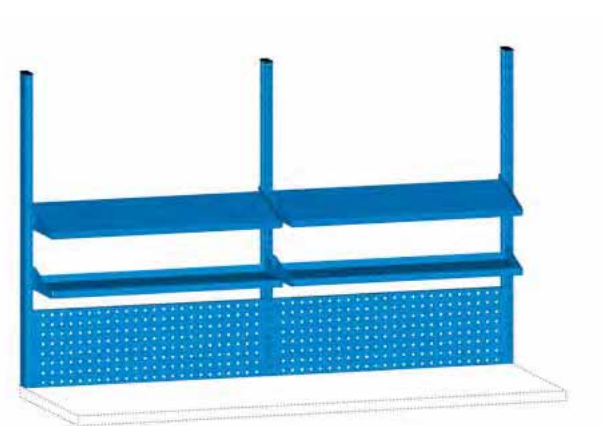

ART.



F BL A020 39 04

3 montanti 1242 mm H ART. F BL 7540 00 04
2 pannelli forati 972x304 mm ART. F BL 7620 00 04
2 mensole 955x220 mm ART. F BL 7750 00 04
2 mensole 955x320 mm ART. F BL 7755 00 04

H 1272 mm

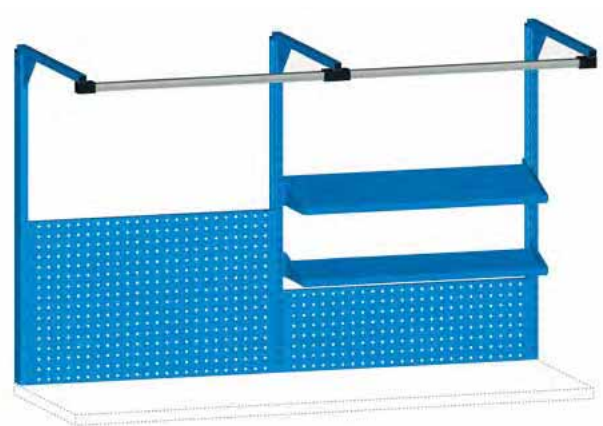

ART.



F BL A020 40 04

3 montanti 1242 mm H ART. F BL 7540 00 04
3 pannelli forati 972x304 mm ART. F BL 7620 00 04
1 mensola 955x220 mm ART. F BL 7750 00 04
1 mensola 955x320 mm ART. F BL 7755 00 04
1 coppia di supporti con binario base in alluminio ART. F BL 9810 10 00
3 supporti singoli per binario mm 34x750x11 H ART. F BL 9805 00 04
1 binario aggiuntivo ART. F BL 9810 13 00

H 1242 mm



ART.



F BL A020 19 04

3 montanti 1242 mm H ART. F BL 7540 00 04
5 pannelli forati 972x304 mm ART. F BL 7620 00 04
1 armadio a tapparella ART. F BL 7011 02 04

H 1242 mm



ART.



F BL A020 41 04

3 montanti 1242 mm H ART. F BL 7540 00 04
1 pannello forato 972x304 mm ART. F BL 7620 00 04
2 mensole 955x220 mm ART. F BL 7750 00 04
1 mensola 955x320 mm ART. F BL 7755 00 04
1 armadio a tapparella ART. F BL 7011 02 04
1 fascia di tenuta ART. F BL 7063 00 04



SOLUZIONE 3

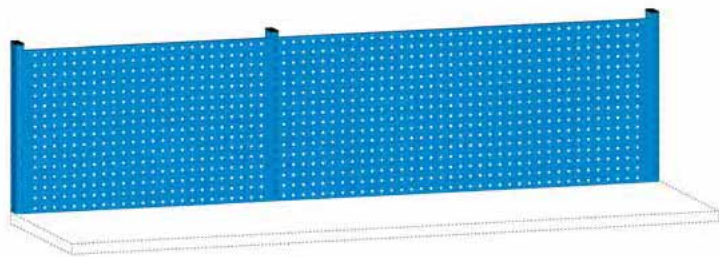

H 634 mm

ART. 

F BL A025 07 04

3 montanti 634 mm H ART. F BL 7530 00 04
2 pannelli forati 972x304 mm ART. F BL 7620 00 04
2 pannelli forati 1457x304 mm ART. F BL 7635 00 04

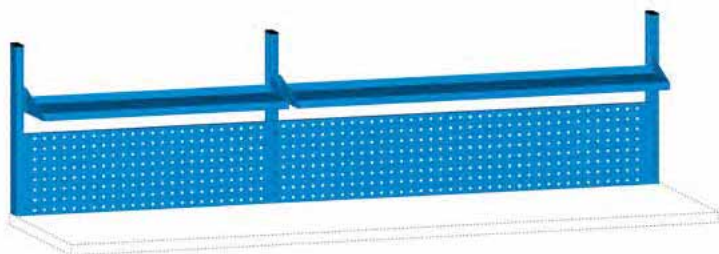

H 634 mm

ART. 

F BL A025 06 04

3 montanti 634 mm H ART. F BL 7530 00 04
1 pannello forato 972x304 mm ART. F BL 7620 00 04
1 pannello forato 1457x304 mm ART. F BL 7635 00 04
1 mensola 955x220 mm ART. F BL 7750 00 04
1 mensola 1440x220 mm ART. F BL 7795 00 04

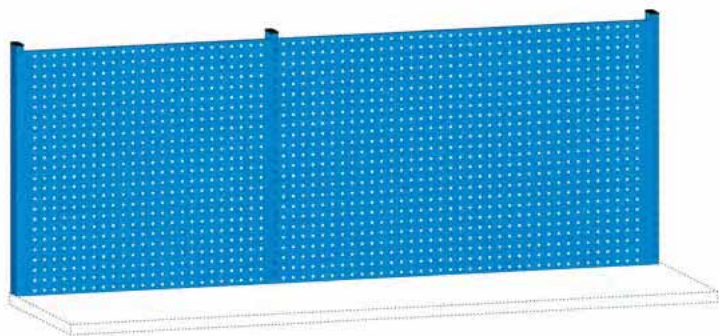

H 938 mm

ART. 

F BL A025 08 04

3 montanti 938 mm H ART. F BL 7535 00 04
3 pannelli forati 972x304 mm ART. F BL 7620 00 04
3 pannelli forati 1457x304 mm ART. F BL 7635 00 04

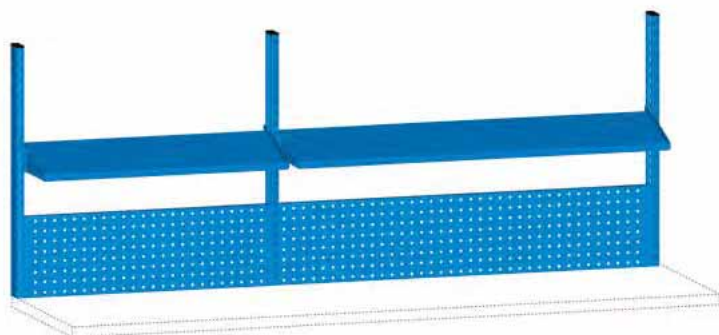

H 938 mm

ART. 

F BL A025 16 04

3 montanti 938 mm H ART. F BL 7535 00 04
1 pannello forato 972x304 mm ART. F BL 7620 00 04
1 pannello forato 1457x304 mm ART. F BL 7635 00 04
1 mensola 955x220 mm ART. F BL 7750 00 04
1 mensola 1440x220 mm ART. F BL 7795 00 04

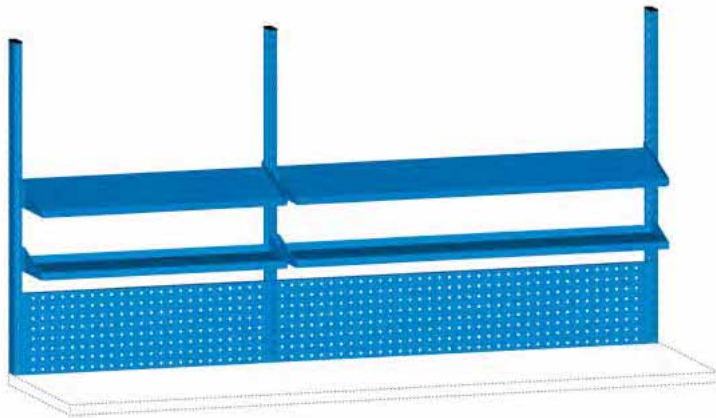

H 1242 mm

ART.



F BL A025 17 04

3 montanti 1242 mm H ART. F BL 7540 00 04
 1 pannello forato 972x304 mm ART. F BL 7620 00 04
 1 pannello forato 1457x304 mm ART. F BL 7635 00 04
 1 mensola 955x220 mm ART. F BL 7750 00 04
 1 mensola 955x320 mm ART. F BL 7755 00 04
 1 mensola 1440x220 mm ART. F BL 7795 00 04
 1 mensola 1440x320 mm ART. F BL 7800 00 04

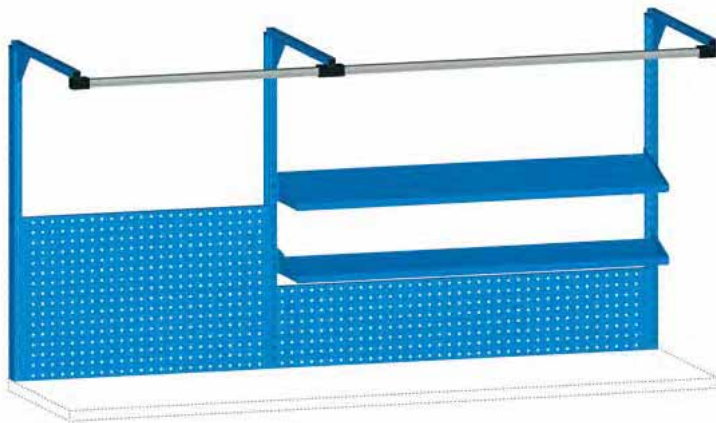

H 1272 mm

ART.



F BL A025 18 04

3 montanti 1242 mm H ART. F BL 7540 00 04
 2 pannelli forati 972x304 mm ART. F BL 7620 00 04
 1 pannello forato 1457x304 mm ART. F BL 7635 00 04
 1 mensola 1440x220 mm ART. F BL 7795 00 04
 1 mensola 1440x320 mm ART. F BL 7800 00 04
 1 coppia di supporti con binario base in alluminio ART. F BL 9810 10 00
 3 supporti singoli per binario mm 34x750x11 H ART. F BL 9805 00 04
 1 binario aggiuntivo ART. F BL 9815 13 00

SOLUZIONE 5

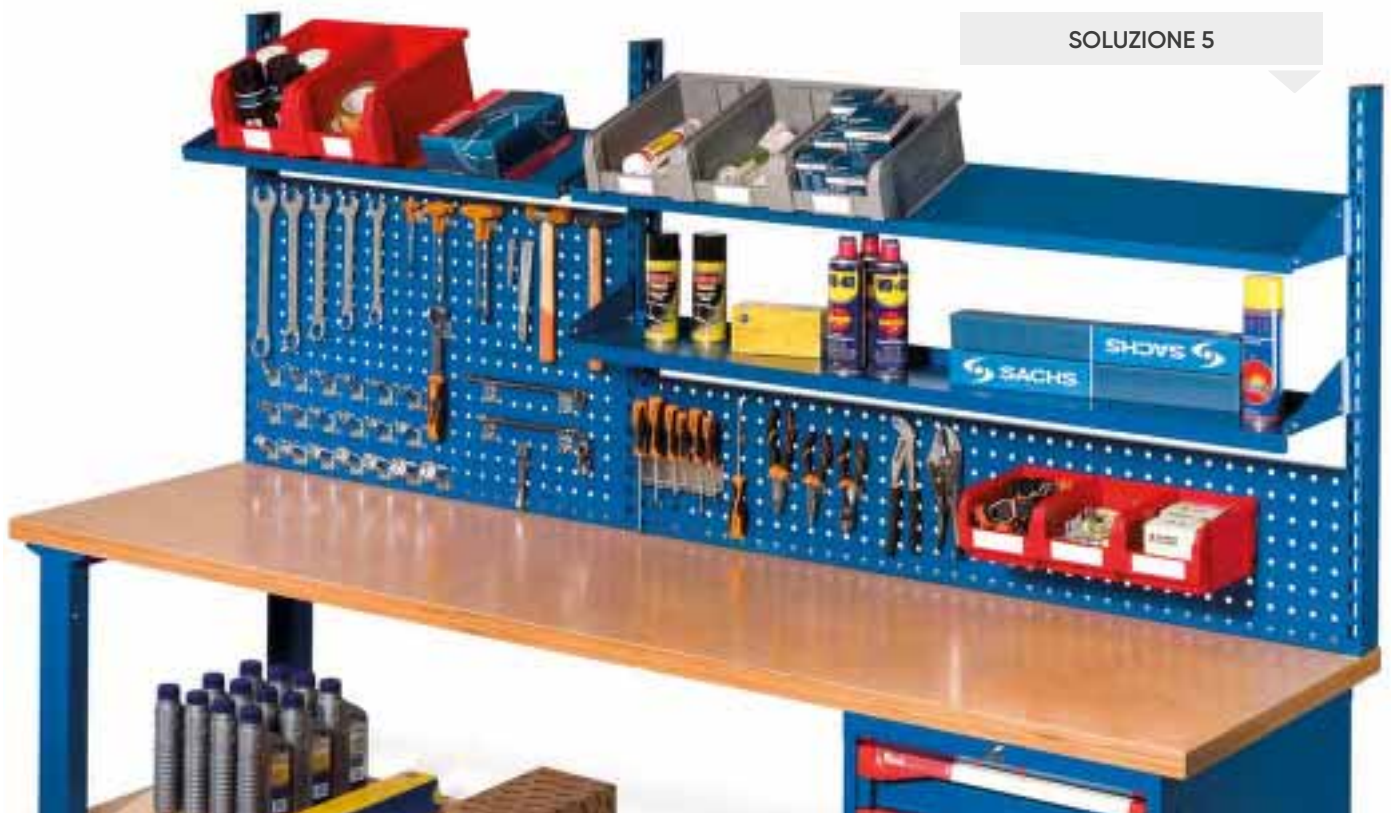

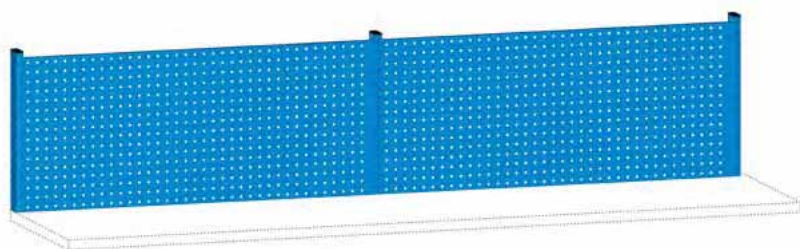

H 634 mm

ART. 

F BL A030 07 04

3 montanti 634 mm H ART. F BL 7530 00 04
4 pannelli forati 1457x304 mm ART. F BL 7635 00 04

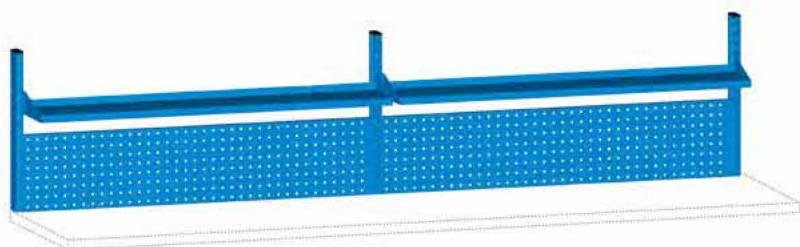

H 634 mm

ART. 

F BL A030 06 04

3 montanti 634 mm H ART. F BL 7530 00 04
2 pannelli forati 1457x304 mm H ART. F BL 7635 00 04
2 mensole 1440x220 mm F BL ART. 7795 00 04

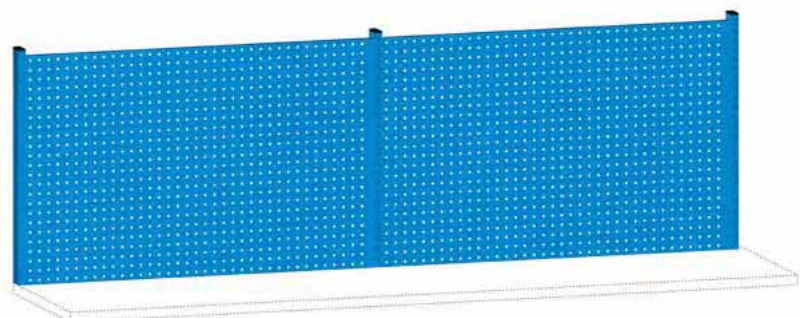

H 938 mm

ART. 

F BL A030 08 04

3 montanti 938 mm H ART. F BL 7535 00 04
6 pannelli forati 1457x304 mm ART. F BL 7635 00 04

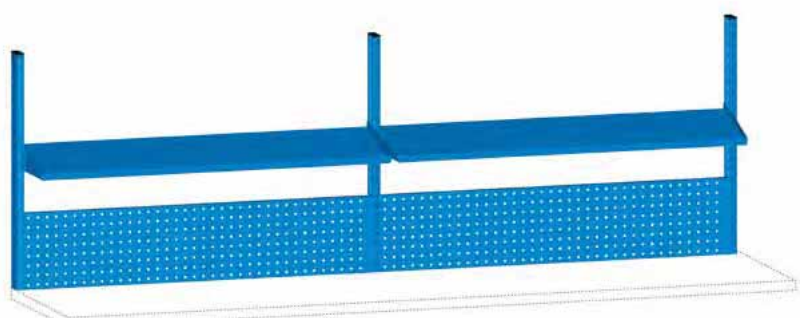

H 938 mm

ART. 

F BL A030 21 04

3 montanti 938 mm H ART. F BL 7535 00 04
2 pannelli forati 1457x304 mm H ART. F BL 7635 00 04
2 mensole 1440x220 mm ART. F BL 7795 00 04

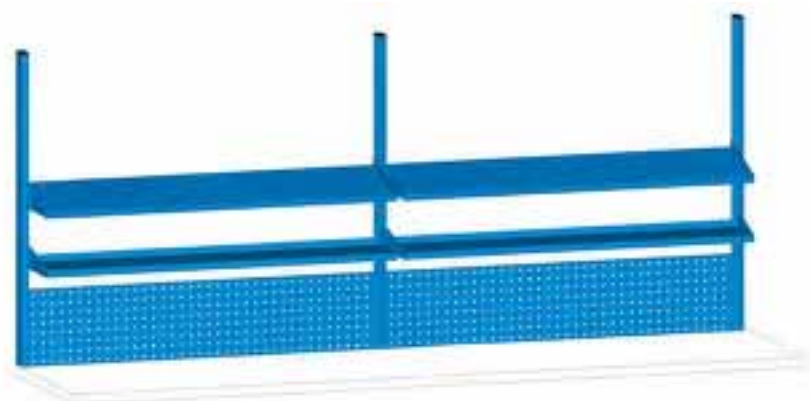

H 1242 mm

ART.



F BL A030 22 04

3 montanti 1242 mm H ART. F BL 7540 00 04
2 pannelli forati 1457x304 mm ART. F BL 7635 00 04
2 mensole 1440x220 mm ART. F BL 7795 00 04
2 mensole 1440x320 mm ART. F BL 7800 00 04

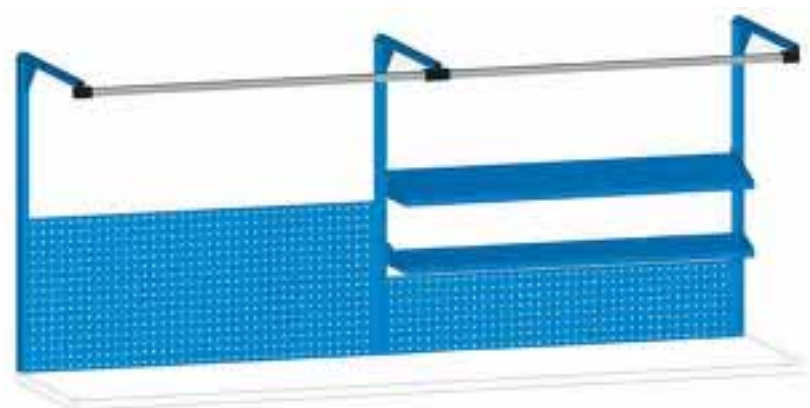

H 1272 mm

ART.



F BL A030 23 04

3 montanti 1242 mm H ART. F BL 7540 00 04
2 pannelli forati 1457x304 mm ART. F BL 7635 00 04
1 mensole 1440x220 mm ART. F BL 7795 00 04
1 mensole 1440x320 mm ART. F BL 7800 00 04
1 coppia di supporti con binario base in alluminio ART. F BL 9815 10 00
3 supporti singoli per binario mm 34x750x11 H ART. F BL 9805 00 04
1 binario aggiuntivo ART. F BL 9815 13 00

SOLUZIONE 6

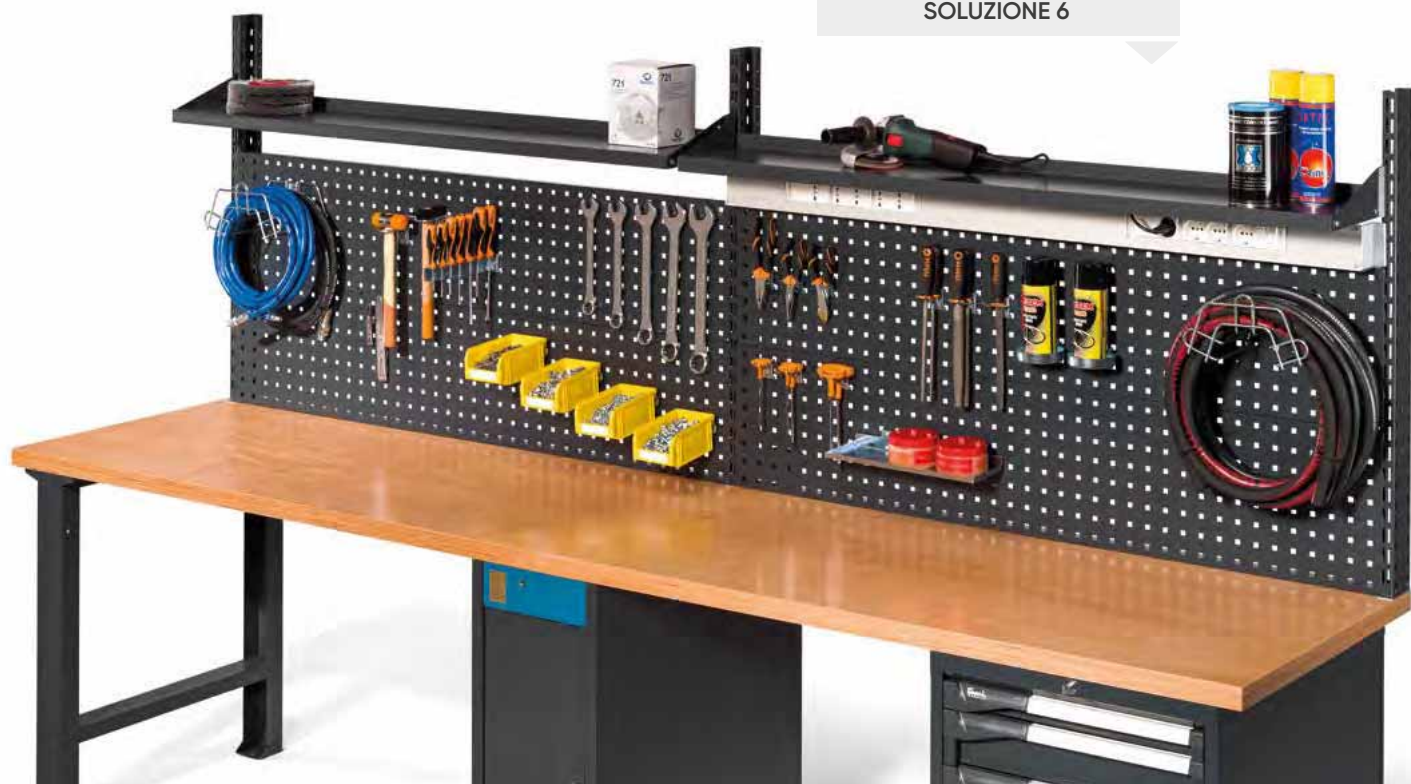



BORDO POSTERIORE PER PIANO 1500 mm

ART.	Dim. mm
F BL 5730 00 00	1500x12x100 H
F BL 5800 00 00	1500x20x150 H
F BL 5870 00 00	1500x20x200 H

BORDO POSTERIORE PER PIANO 2500 mm

ART.	Dim. mm
F BL 5760 00 00	2500x12x100 H
F BL 5830 00 00	2500x20x150 H
F BL 5900 00 00	2500x20x200 H



BORDO LATERALE PROFONDITÀ 750 mm

ART.	Dim. mm
F BL 5610 00 00	762x12x100 H
F BL 5635 00 00	770x20x150 H
F BL 5645 00 00	770x20x200 H

BORDO POSTERIORE PER PIANO 1300 mm

ART.	Dim. mm
F BL 5720 00 00	1300x12x100 H
F BL 5790 00 00	1300x20x150 H
F BL 5860 00 00	1300x20x200 H

BORDO POSTERIORE PER PIANO 2000 mm

ART.	Dim. mm
F BL 5750 00 00	2000x12x100 H
F BL 5820 00 00	2000x20x150 H
F BL 5890 00 00	2000x20x200 H

BORDO POSTERIORE PER PIANO 3000 mm

ART.	Dim. mm
F BL 5770 00 00	3000x12x100 H
F BL 5840 00 00	3000x20x150 H
F BL 5910 00 00	3000x20x200 H

BORDO LATERALE PROFONDITÀ 800 mm

ART.	Dim. mm
F BL 5630 00 00	812x12x100 H
F BL 5640 00 00	820x20x150 H
F BL 5650 00 00	820x20x200 H



MENSOLA A 3 BORDI IN MULTIPLEX CON SOSTEGNI REGOLABILI

ART.	Dim. mm
F BL A015 01 07	1500x355x215/335 H
F BL A020 01 07	2000x355x215/335 H
F BL A025 02 07	2500x355x215/335 H
F BL A030 02 07	3000x355x215/335 H

COLORE NERO RAL 9005





ARMADIO A TAPPARELLA

ART.	TIPO DI FISSAGGIO
F BL 7011 01 04	A PARETE
F BL 7011 02 04	AI MONTANTI BIASOLATI
F BL 7011 03 04	AI PIANI IN LEGNO

Dimensioni esterne mm 952x210x810 H - Dimensioni utili mm 905x150x581 H
Portata 50 kg



ARMADIO A TAPPARELLA

ART.	TIPO DI FISSAGGIO
F BL 7021 01 04	A PARETE
F BL 7021 03 04	AI PIANI IN LEGNO

Dimensioni esterne mm 952x210x1115 H - Dimensioni utili mm 905x150x885 H
Portata 50 kg





ARMADIO A TAPPARELLA

ART.	Dim. mm	TIPO DI FISSAGGIO
F BL 7030 03 _ _	1419x210x810 H	AI PIANI IN LEGNO
F BL 7040 03 _ _	1937x210x810 H	AI PIANI IN LEGNO

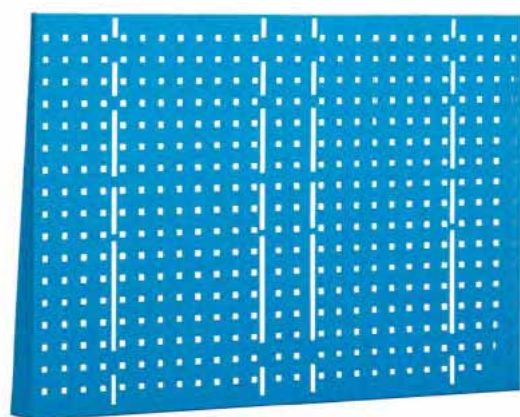

PANNELLI FORATI

ART.	Dim. mm	TIPO DI FISSAGGIO
F DL 7942 00 _ _	1016x93x420 H	AI PIANI IN LEGNO
F DL 7970 00 _ _	1016x93x700 H	AI PIANI IN LEGNO



! Questo pannello si può applicare con un piano superiore in MDF oppure con un piano in multipelex

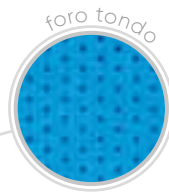
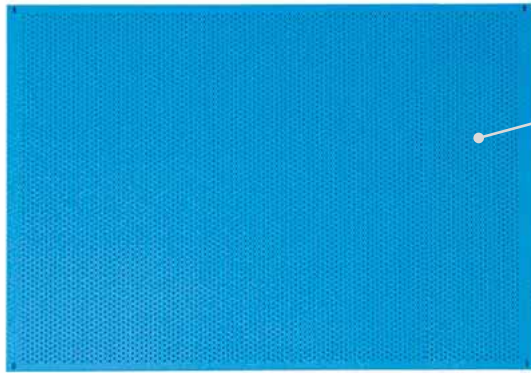

PANNELLI PORTA ATTREZZI DA PARETE

ART.	Dim. mm
F BG 3910 00 __	1000x850 H
F BG 3915 00 __	1500x850 H
F BG 3920 00 __	2000x850 H



MENSOLA PER PANNELLI

ART.	Dim. mm
F BG 3940 00 __	1000x140x146 H
F BG 3945 00 __	1500x140x146 H
F BG 3950 00 __	2000x140x146 H



GANCIO CON OCCHIELLO

ART.
F BG 3970 01 99



GANCI CON SOSTEGNO SEMPLICE

ART.	Lunghezza mm
F BG 3971 01 99	60
F BG 3972 01 99	110
F BG 3973 01 99	150

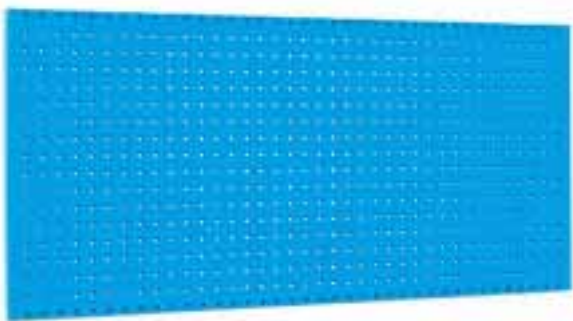

PANNELLI FORATI DA PARETE

ART.	Dim. mm
F BE 0670 00 __	1500x20x670 H
F BE 0675 00 __	2000x20x670 H

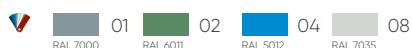

CONFIGURA LA PARETE ATTREZZATA



MONTANTE BIASOLATO PER PIANI IN LEGNO

ART.		H mm	kg
F BL 7530 00 04		634	50
F BL 7535 00 04		938	50
F BL 7540 00 04		1242	50

DISPONIBILE ANCHE IN FINITURA ZINCATA "CODICE 99"



ART. F BL 7540 NON UTILIZZABILE
NEI BANCHI SERIE WORK STEEL



MENSOLA PER PARETI ATTREZZATE LUNGHEZZA 1000 mm

ART.			kg
F BL 7750 00 04		220 mm	50
F BL 7755 00 04		320 mm	50
F BL 7760 00 04		420 mm	50
F BL 7762 00 04		600 mm	50

DISPONIBILE ANCHE IN FINITURA ZINCATA "CODICE 99"



MENSOLA PER PARETI ATTREZZATE LUNGHEZZA 1500 mm

ART.			kg
F BL 7795 00 04		220 mm	50
F BL 7800 00 04		320 mm	50
F BL 7805 00 04		420 mm	50

DISPONIBILE ANCHE IN FINITURA ZINCATA "CODICE 99"

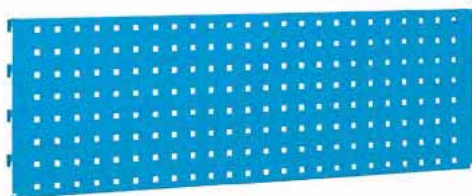

PANNELLO FORATO

ART.		Dim. mm	kg
F BL 7620 00 04		973x304 H	25
F BL 7635 00 04		1458x304 H	25



PANNELLO NON FORATO

ART.		Dim. mm	kg
F BL 7670 00 04		973x304 H	-
F BL 7685 00 04		1458x304 H	-



ESEMPI COPPIA SUPPORTI CON BINARIO IN ALLUMINIO



LUNGHEZZA 1000/1500 mm



LUNGHEZZA 2000 mm



LUNGHEZZA 2500 mm



LUNGHEZZA 3000 mm



LUNGHEZZA 3000 mm



SUPPORTO SINGOLO PER BINARIO

ART.		Dim. mm	
F BL 9805 00 04		34x750x114 H	



BINARIO IN ALLUMINIO CON ATTACCHI

ART.	Lunghezza binario mm	
F BL 9810 10 00	1000	binario per 2 supporti
F BL 9815 10 00	1500	binario per 2 supporti
F BL 9820 10 00	2000	binario per 3 supporti
F BL 9825 10 00	2500	binario per 3 supporti
F BL 9830 10 00	3000	binario per 3 supporti
F BL 9830 11 00	3000	binario per 4 supporti

I BINARI LUNGHEZZA mm 2000 - 2500 - 3000 sono forniti in più pezzi



GRUPPO ATTACCHI AGGIUNTIVO

ART.	
F BL 9842 00 07	

Il gruppo attacchi aggiuntivo viene utilizzato quando si devono unire i binari di più banchi per il passaggio degli attacchi di scorrimento del set bilanciante.



LAMPADA PHILIPS WT120C LED18S/840 PSU L600

ART.	Dim. mm	
F BL 9905 00 00	661x87x96 H	

Copertura in policarbonato trasparente, grado di protezione IP 65, tensione di ingresso 220-240V, frequenza di ingresso da 50 a 60 Hz, flusso luminoso iniziale 4000 lm, vita utile media L70B50 ore 50.000, temperatura colore 4000K, indice resa colore 80, protezione IEC classe 1, spina di alimentazione Schuko. Materiale di fissaggio incluso.



LAMPADA PHILIPS WT120C LED40S/840 PSU L1200

ART.	Dim. mm	
F BL 9910 00 00	1223x87x96 H	

Copertura in policarbonato trasparente, grado di protezione IP 65, tensione di ingresso 220-240V, frequenza di ingresso da 50 a 60 Hz, flusso luminoso iniziale 4000 lm, vita utile media L70B50 ore 50.000, temperatura colore 4000K, indice resa colore 80, protezione IEC classe 1, spina di alimentazione Schuko. Materiale di fissaggio incluso.



LAMPADA PHILIPS WT120C LED60S/840 PSU L1500

ART.	Dim. mm	
F BL 9915 00 00	1504x87x96 H	

Copertura in policarbonato trasparente, grado di protezione IP 65, tensione di ingresso 220-240V, frequenza di ingresso da 50 a 60 Hz, flusso luminoso iniziale 6000 lm, vita utile media L70B50 ore 50.000, temperatura colore 4000K, indice resa colore 80, protezione IEC classe 1, spina di alimentazione Schuko. Materiale di fissaggio incluso.

LAMPADA WALDMANN 2x36 W IP 67

ART.	Lunghezza	Ø mm
F BL 9960 00 00	1090 mm	70

Caratteristiche tecniche: Grado di protezione IP 67 - Neon 2x36W - Impianto elettrico 230V/50Hz - Spina di alimentazione Schuko - Lunghezza cavo 4 metri - Tonalità colore 4000K - Resa colore (Ra) 80-89
Materiale di fissaggio incluso.



LAMPADA WALDMANN 1x39 W IP 20

ART.	Dim. mm	
F BL 9930 00 08	956x187x50 H	

Caratteristiche tecniche: Grado di protezione IP 20 - Neon 1x39W - Impianto elettrico 230V/50Hz - Spina di alimentazione Schuko - Lunghezza cavo 3 metri - Tonalità colore 4000K - Resa colore (Ra) 80-89
Materiale di fissaggio incluso.





LAMPADA A TRIPLO SNODO WALDMANN 1x36 W IP 20

ART.

F BL 9980 00 08

Struttura: corpo in alluminio, diffusore parabolico metallizzato.

L'impianto di illuminazione standard comprende: 1 supporto multiuso in acciaio per l'aggancio del morsetto, 1 morsetto 0-65 mm, 1 lampada a triplo snodo. Caratteristiche tecniche: Grado di protezione IP 20 - Neon 1x36W - Impianto elettrico 230V/50Hz - Spina di alimentazione Schuko - Lunghezza cavo 1,95 metri - Tonalità colore 4000K - Resa colore (Ra) 80-89

COLORE GRIGIO RAL 7035

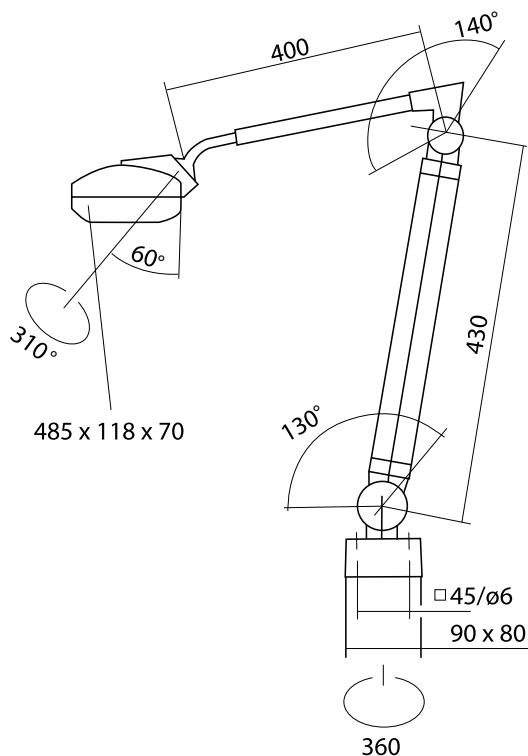

SUPPORTO MULTIUSO

ART.

Dim. mm

F BL 7461 00 08

70x60x70 H

COLORE GRIGIO RAL 7035



ARROTOLATORE

ART.

F BL 9601 01 07

Arrotolatore IP42 230V con 10 metri di cavo avvolgibile 3x1,5 mm² completo di una presa industriale volante 220-250V 16A 2P+T e una spina Schuko 220-250V 10A 2P+T. L'arrotolatore è completo di staffa per il fissaggio ai montanti biasolati. Potere di assorbimento: con cavo completamente avvolto 1200W - con cavo completamente svolto 1800W



SET BILANCIATORE

ART.	CON BILANCIATORE	
F BL 9710 00 00	0,4 - 1 kg	
F BL 9720 00 00	1 - 2 kg	

Set completo di: 2 attacchi di scorrimento, 1 moschettone, 1 bilanciatore con cavo in acciaio lunghezza 1600 mm.



ATTACCHI DI SCORRIMENTO

ART.	
R CMV 0034 00	

L'attacco di scorrimento è composto da: 1 anello in plastica nero completo di cuscinetti e 1 moschettone in acciaio.

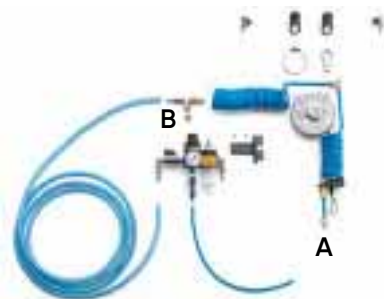

SET PER ARIA COMPRESSA CON BILANCIATORE E FILTRO

ART.	CON BILANCIATORE	
F BL 9710 03 00	0,4 - 1 kg	
F BL 9720 03 00	1 - 2 kg	

Il set è completo di: 1 cavo flessibile Ø 10 mm, 1 connettore a T da 1/4" con tappo (B), 2 fermi, 2 attacchi di scorrimento, 1 moschettone, 1 bilanciatore con cavo in acciaio lunghezza 1600 mm, 1 attacco universale 1/4" per utensili (A), 1 tubo a spirale diametro interno 5,5 mm, 1 gruppo filtro regolatore con manometro* il quale può essere utilizzato con una pressione massima di 10 bar, la sua capacità è di circa 9 litri al secondo (sul punto A) è di 11 litri al secondo (sul punto B) con una pressione di utilizzo pari a 6,3 bar (la capacità può variare a seconda delle caratteristiche tecniche della rete pneumatica a cui l'impianto Fami viene allacciato). Raccordi da 1/4", 1 tubo diametro interno 5,5 mm per lo spurgo del filtro.

*Gruppo filtro regolatore con manometro e oliatore a richiesta

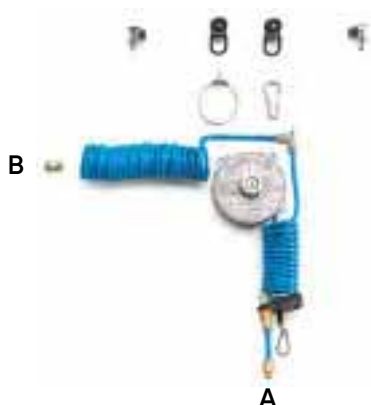





SET PER ARIA COMPRESSA AGGIUNTIVO CON BILANCIATORE E FILTRO

ART.	CON BILANCIATORE	
F BL 9710 02 00	0,4 - 1 kg	
F BL 9720 02 00	1 - 2 kg	

Il set è completo di: 1 attacco da 1/4" (B), 2 fermi, 2 attacchi di scorrimento, 1 moschettone, 1 bilanciatore con cavo in acciaio lunghezza 1600 mm, 1 attacco universale 1/4" per utensili (A), 1 tubo a spirale diametro interno 5,5 mm.





BRACCIO A DOPPIO SNODO

ART.		kg
F BL 7445 01 _ _	CON CONTENITORI	15
5 contenitori PICKING BOX mis. 1 e 3 contenitori PICKING BOX mis. 2 forniti in colore giallo		
F BL 7445 00 _ _	SENZA CONTENITORI	15
 01	 02	 04
 08		







BRACCIO A DOPPIO SNODO

ART.		kg
F BL 7445 02 _ _	CON CONTENITORI	15
15 contenitori PICKING BOX mis. 1 forniti in colore giallo		
F BL 7445 00 _ _	SENZA CONTENITORI	15
 01	 02	 04
 08		







BRACCIO A DOPPIO SNODO CON VISUAL BOX

ART.		kg
F BL 7446 01 _ _		15
Completo di 1 VISUAL BOX a 9 cassetti e 2 VISUAL BOX a 6 cassetti		
 01	 02	 04
 08		



BRACCIO A DOPPIO SNODO CON VASSOIO

ART.		kg
F BL 7455 00 _ _		20
 01	 02	 04
 08		



Componenti elettrici con grado di protezione IP 30 forniti di serie:

- 2 scatole porta prese a 12 moduli
- 1 magnetotermico differenziale 2P 230V AC10A I Δ N=0,01A
- 2 pressacavi PG11
- 1 pressacavo PG16

- 2 raccordi dritti PG16
- 200 cm di guaina proteggicavo Ø 16 mm
- 1 spina fissa industriale 220-250V 16A 2P+T
- 1 cablaggio completo per 6-9 prese (a seconda dell'articolo)
- 6-9 prese 220-250V 10A 2P+T con relativi coprifori (a seconda dell'articolo)



CANALETTE CON PRESE CABLATE DIM. 1420x60x85 H mm

TIPO E NUMERO PRESE CABLATE

ART.	D	F	GB	I	CH	IL
F BL 9260 10 08	9	-	-	-	-	-
F BL 9260 20 08	-	9	-	-	-	-
F BL 9260 25 08	4	5	-	-	-	-
F BL 9260 30 08	-	-	6	-	-	-
F BL 9260 35 08	4	-	3	-	-	-
F BL 9260 40 08	-	-	-	9	-	-
F BL 9260 45 08	4	-	-	5	-	-
F BL 9260 50 08	-	-	-	-	9	-
F BL 9260 55 08	4	-	-	-	5	-
F BL 9260 70 08	-	-	-	-	-	9
F BL 9260 75 08	4	-	-	-	-	5

08
RAL 7035



zincato

COPPIA SUPPORTI ANTERIORI

ART. F BL 9450 00 99

Coppia supporti per l'aggancio della canaletta anteriore



CANALETTE CON PRESE CABLATE DIM. 1920x60x85 H mm

TIPO E NUMERO PRESE CABLATE

ART.	D	F	GB	I	CH	IL
F BL 9310 10 08	9	-	-	-	-	-
F BL 9310 20 08	-	9	-	-	-	-
F BL 9310 25 08	4	5	-	-	-	-
F BL 9310 30 08	-	-	6	-	-	-
F BL 9310 35 08	4	-	3	-	-	-
F BL 9310 40 08	-	-	-	9	-	-
F BL 9310 45 08	4	-	-	5	-	-
F BL 9310 50 08	-	-	-	-	9	-
F BL 9310 55 08	4	-	-	-	5	-
F BL 9310 70 08	-	-	-	-	-	9
F BL 9310 75 08	4	-	-	-	-	5

08
RAL 7035



zincato

COPPIA SUPPORTI POSTERIORI

ART. F BL 9455 00 99

Coppia supporti per l'aggancio della canaletta posteriore
-Per le canalette lunghezza 1920 mm con coppia supporti posteriori chiedere informazioni alla Fami.



Dim. mm 85x70x360 H

Componenti elettrici con grado di protezione IP30 forniti di serie:

- 1 scatola porta prese a 12 moduli
- 1 magnetotermico differenziale 2P 230V AC 10A I Δ N=0,01A
- 2 raccordi dritti PG16
- 200 cm guaina proteggicavo Ø 16 mm
- 1 spina fissa industriale 220-250V 16A 2P+T
- 1 cablaggio completo per 3-5 prese (a seconda dell'articolo)
- 3-5 prese 220-250V 10A 2P+T con relativi coprifori (a seconda dell'articolo)



SCATOLA PORTA PRESE 220V IP30 SUPPORTO LATERALE

ART.	D	F	GB	I	CH	IL
F BL 9361 10 59	5	-	-	-	-	-
F BL 9361 25 59	1	4	-	-	-	-
F BL 9361 30 59	-	-	3	-	-	-
F BL 9361 35 59	1	-	2	-	-	-
F BL 9361 45 59	1	-	-	4	-	-
F BL 9361 55 59	1	-	-	-	4	-
F BL 9361 75 59	1	-	-	-	-	4

SCATOLA PORTA PRESE 220V IP30 SUPPORTO FRONTALE

ART.	D	F	GB	I	CH	IL
F BL 9360 10 59	5	-	-	-	-	-
F BL 9360 25 59	1	4	-	-	-	-
F BL 9360 30 59	-	-	3	-	-	-
F BL 9360 35 59	1	-	2	-	-	-
F BL 9360 45 59	1	-	-	4	-	-
F BL 9360 55 59	1	-	-	-	4	-
F BL 9360 75 59	1	-	-	-	-	4

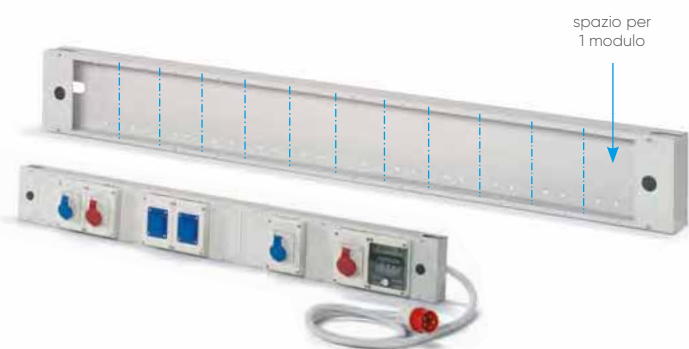

Canalette vuote complete di 2 tamponi laterali con fori di uscita per gli impianti pneumatici. Fori Ø 22 mm.

CANALETTA VUOTA 12 MODULI 220V - 380V

ART.	Dim. mm	Moduli
F BL 9115 01 08	1420x72x170 H	12

PER LUNGHEZZA TELAI 1470 mm

08
RAL 7035

CANALETTA VUOTA 16 MODULI 220V - 380V

ART.	Dim. mm	Moduli
F BL 9120 01 08	1920x72x170 H	16

PER LUNGHEZZA TELAI 1970 mm

08
RAL 7035

CANALETTA VUOTA 7 MODULI 220V - 380V

ART.	Dim. mm	Moduli
F BL 9110 01 08	935x75x170 H	7

PER LUNGHEZZA TELAI 985 mm

08
RAL 7035



ART.

F BL 9460 00 99

Coppia supporti per l'aggancio della canaletta anteriore
zincato

869



ART.

F BL 9465 00 99

Coppia supporti per l'aggancio della canaletta posteriore
zincato

MAGNETOTERMICO DIFFERENZIALE 220V



1 MODULO

ART.	CABLAGGIO
F BL 9393 51 00	SI
F BL 9393 52 00	NO

Composto da: centralino con coperchio, magnetotermico differenziale 220V 16A 1P+N I Δ N=0,03A, cavo lunghezza 3 metri con spina volante CEE 220V - Grado di protezione IP40

IL CAVO VIENE FORNITO SOLO CON CENTRALINO CABLATO

MAGNETOTERMICO 220V



1 MODULO

ART.	CABLAGGIO
F BL 9394 51 00	SI
F BL 9394 52 00	NO

Composto da: centralino con coperchio, magnetotermico 220V 16A 1P+N, cavo lunghezza 3 metri con spina volante CEE 220V Grado di protezione IP40

IL CAVO VIENE FORNITO SOLO CON CENTRALINO CABLATO

MAGNETOTERMICO DIFFERENZIALE 380V



1 MODULO

ART.	CABLAGGIO
F BL 9393 53 00	SI
F BL 9393 54 00	NO

Composto da: centralino con coperchio, magnetotermico differenziale 380V 16A 4P I Δ N=0,03A, cavo lunghezza 3 metri con spina volante CEE 380V - Grado di protezione IP40

IL CAVO VIENE FORNITO SOLO CON CENTRALINO CABLATO

MAGNETOTERMICO DIFFERENZIALE 220V



2 MODULI

ART.	CABLAGGIO
F BL 9393 55 00	SI
F BL 9393 56 00	NO

Composto da: centralino con coperchio, magnetotermico differenziale 220V 16A 1P+N I Δ N=0,03A con sganciatore di emergenza, 1 fungo di emergenza, cavo lunghezza 3 metri con spina volante CEE 220V Grado di protezione IP40

IL CAVO VIENE FORNITO SOLO CON CENTRALINO CABLATO

MAGNETOTERMICO 220V



2 MODULI

ART.	CABLAGGIO
F BL 9394 55 00	SI
F BL 9394 56 00	NO

Composto da: centralino con coperchio, magnetotermico 220V 16A 1P+N con sganciatore di emergenza, 1 fungo di emergenza, cavo lunghezza 3 metri con spina volante CEE 220V Grado di protezione IP40

IL CAVO VIENE FORNITO SOLO CON CENTRALINO CABLATO

MAGNETOTERMICO DIFFERENZIALE 380V



3 MODULI

ART.	CABLAGGIO
F BL 9393 57 00	SI
F BL 9393 58 00	NO

Composto da: centralino con coperchio, magnetotermico differenziale 380V 16A 4P I Δ N=0,03A con sganciatore di emergenza, 1 fungo di emergenza, cavo lunghezza 3 metri con spina volante CEE 380V Grado di protezione IP40

IL CAVO VIENE FORNITO SOLO CON CENTRALINO CABLATO

PRESA SCHUKO



1 MODULO

ART.	CABLAGGIO
F BL 9395 57 00	SI
F BL 9395 58 00	NO

Composto da: 1 presa 220V 16A 2P+T Grado di protezione IP40

PRESA 380V 3P+N+T



1 MODULO

ART.	CABLAGGIO
F BL 9395 51 00	SI
F BL 9395 52 00	NO

Composto da: 1 presa 380V 16A 3P+N+T Grado di protezione IP40



1 MODULO

COPERCHIO PER CANALETTA

ART.
F BL 9384 00 08

PRESA 220V 2P+T



1 MODULO

ART.	CABLAGGIO
F BL 9395 55 00	SI
F BL 9395 56 00	NO

Composto da: 1 presa 220V CEE 16A 2P+T Grado di protezione IP40

PRESA 380V 3P+T



1 MODULO

ART.	CABLAGGIO
F BL 9395 53 00	SI
F BL 9395 54 00	NO

Composto da: 1 presa 380V 16A 3P+T Grado di protezione IP40



TUBO PNEUMATICO DI ALIMENTAZIONE

ART.
F BL 9401 02 00

Il tubo lunghezza 3 metri viene fornito completo di 1 manicotto, 2 porta gomma maschio con fascette, 1 tappo. Raccorderie 3/8"

ESEMPI DI PARETI ATTREZZATE



SOLUZIONE 1 - 1000 mm

ESEMPIO DI PARETE ATTREZZATA CON GANCI E UTENSILI BETA composta da:

- | | |
|---|---|
| 2 montanti 634 mm H ART. F BL 7530 00 1G | 1 set utensili ART. BETA-024000452 (T234) |
| 1 pannello forato 973x304 mm ART. F BL 7620 00 1F | 1 set utensili ART. BETA-024000451 (T131) |
| 1 mensola mm 955x320 ART. F BL 7755 00 1F | |
| 2 contenitori ART. FAXPBC3A2B001 | 3 ganci ART. CMV 10 001 |
| | 4 ganci ART. CMV 10 037 |
| | 1 gancio ART. CMV 10 030 |
| | 1 gancio ART. CMV 10 032 |
| | 10 calamite 1 x ART. F BL 9541 00 00 |



SOLUZIONE 2 - 1500 mm

ESEMPIO DI PARETE ATTREZZATA CON GANCI E UTENSILI BETA composta da:

- | | |
|--|---|
| 2 montanti 1242 mm H ART. F BL 7540 00 08 | 1 set utensili ART. BETA-024240131 (T131) |
| 2 pannelli forati 1458x304 mm ART. F BL 7635 00 08 | 1 set utensili ART. BETA-024240083 (T83) |
| 1 mensola mm 1440x220 ART. F BL 7795 00 08 | 1 set utensili ART. BETA-024240220 (T220) |
| 2 supporti per binario ART. F BL 9805 00 08 | |
| 1 binario base ART. F BL 9815 10 00 | 1 gancio ART. CMV 10 030 |
| 1 lampada ART. F BL 9910 00 00 | 1 gancio ART. CMV 10 032 |
| 1 canaletta mm 1420x60x85 H ART. F BL 9260 45 08 | 23 ganci ART. CMV 10 037 |
| 1 coppia supporti ART. F BL 9450 00 99 | 3 ganci ART. CMV 10 001 |
| 6 contenitori ART. FAXPBC002A004 | 1 gancio ART. CMV 10 022 |
| | 1 gancio ART. CMV 10 009 |
| | 1 gancio ART. CMV 10 017 |
| | 10 calamite 1 x ART. F BL 9541 00 00 |



SOLUZIONE 3 - 2000 mm

ESEMPIO DI PARETE ATTREZZATA CON GANCI E UTENSILI BETA composta da:

- | | |
|---|---|
| 3 montanti 1242 mm H ART. F BL 7540 00 1F | 1 set utensili ART. BETA-024510033 (M33) |
| 2 pannelli forati 973x304 mm ART. F BL 7620 00 1F | 1 set utensili ART. BETA-024510152 (M152) |
| 1 mensola 955x320 mm ART. F BL 7755 00 1F | 1 set utensili ART. BETA-024510265 (M265) |
| 3 supporti per binario ART. F BL 9805 00 1F | 1 set utensili ART. BETA-024510220 (M220) |
| 1 binario base ART. F BL 9810 10 00 | 1 set utensili ART. BETA-024510233 (M233) |
| 1 binario aggiuntivo ART. F BL 9810 13 00 | 1 set utensili ART. BETA-024510297 (M297) |
| 1 lampada ART. F BL 9910 00 00 | |
| 1apparella mm 952x210x810 H ART. F BL 7011 02 1F | 11 ganci ART. CMV 10 037 |
| 1 arrotolatore ART. F BL 9601 01 07 | 2 ganci ART. CMV 10 001 |
| | 1 gancio ART. CMV 10 016 |
| | 20 calamite 2 x ART. F BL 9541 00 00
(confezione 10 pz.) |



SOLUZIONE 4 - 2000 mm

ESEMPIO DI PARETE ATTREZZATA CON GANCI E UTENSILI BETA composta da:

3 montanti 1242 mm H ART. F BL 7540 00 08	26 ganci ART. CMV 10 037
6 pannelli forati 973x304 mm ART. F BL 7620 00 08	16 ganci ART. CMV 10 035
3 supporti per binario ART. F BL 9805 00 08	3 ganci ART. CMV 10 022
2 binari base ART. F BL 9810 10 00	16 ganci ART. CMV 10 016
2 binari aggiuntivi ART. F BL 9810 13 00	6 ganci ART. CMV 10 007
1 lampada ART. F BL 9910 00 00	2 ganci ART. CMV 10 003
1 set bilanciatore ART. F BL 9720 00 00	1 gancio ART. CMV 10 002
	7 ganci ART. CMV 10 001
1 set 98 utensili ART. BETA-059040161	20 calamite 2 x ART. F BL 9541 00 00 (confezione 10 pz.)



SOLUZIONE 5 - 2500 mm

ESEMPIO DI PARETE ATTREZZATA CON GANCI E UTENSILI BETA composta da:

3 montanti 938 mm H ART. F BL 7535 00 34	1 set utensili ART. BETA-024000765 (T52)
2 pannelli forati 973x304 mm ART. F BL 7620 00 34	1 set utensili ART. BETA-024000446 (T16)
1 pannello forato 1458x304 mm ART. F BL 7635 00 34	1 set utensili ART. BETA-024000701 (T208)
1 mensola 955x320 mm ART. F BL 7755 00 34	1 set utensili ART. BETA-024000462 (T153)
1 mensola 1440x320 mm ART. F BL 7800 00 34	
1 mensola 1440x220 mm ART. F BL 7795 00 34	3 ganci ART. CMV 10 001
2 contenitori FAXPBC003B003	3 ganci ART. CMV 10 007
3 contenitori FAXPBC3A2B001	2 ganci ART. CMV 10 016
3 contenitori FAXPBC002A003	1 gancio ART. CMV 10 006
1 barra aggancio contenitori ART. F BL 7438 00 99	24 ganci ART. CMV 10 037
1 set utensili ART. BETA-024000403 (T80)	1 gancio ART. CMV 10 019
1 set utensili ART. BETA-024000451 (T131)	10 calamite 1 x ART. F BL 9541 00 00



SOLUZIONE 6 - 3000 mm

ESEMPIO DI PARETE ATTREZZATA CON GANCI E UTENSILI BETA composta da:

3 montanti 938 mm H ART. F BL 7535 00 39	2 ganci ART. CMV 10 024
4 pannelli forati 1458x304 mm ART. F BL 7635 00 39	2 ganci ART. CMV 10 029
2 mensole 1440x320 mm ART. F BL 7800 00 39	4 ganci ART. CMV 10 026
4 contenitori FAXPBC001A05105	3 ganci ART. CMV 10 001
1 barra aggancio contenitori ART. CMV 10 026	2 ganci ART. CMV 10 009
	1 gancio ART. CMV 10 006
1 set utensili ART. BETA-024000446 (T16)	3 ganci ART. CMV 10 007
1 set utensili ART. BETA-024000451 (T131)	1 gancio ART. CMV 10 018
1 set utensili ART. BETA-024000701 (T208)	2 ganci ART. CMV 10 017
1 set utensili ART. BETA-024000452 (T234)	1 gancio ART. CMV 10 043
1 set utensili ART. BETA-024000453 (T236)	10 calamite 1 x ART. F BL 9541 00 00

SEDIE
MORSE
GANCI

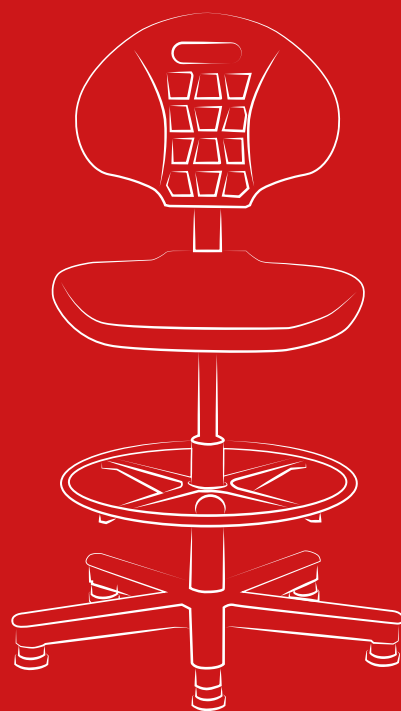

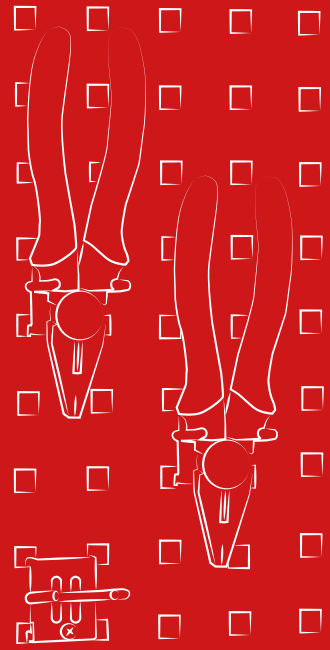
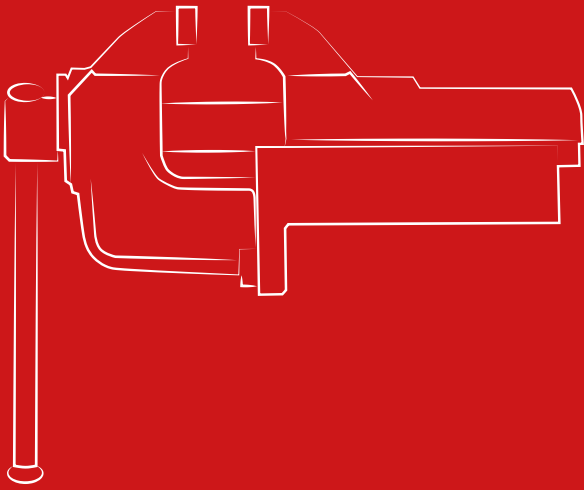

ACCESSORI SEDIE GIREVOLI IN FAGGIO MULTISTRATO



ART.	H mm
F QZ 1111 00 07	530/645

Sedia in faggio, ruote autobloccanti, regolabile in altezza a vite



ART.	H mm
F QZ 1110 00 07	501/620

Sedia in faggio, piedini fonoassorbenti, regolabile in altezza a vite



ART.	H mm
F QZ 1120 00 07	501/710

Sedia in faggio, piedini fonoassorbenti e poggiatesta cromato, regolabile in altezza a vite



ART.	H mm
F QZ 1130 00 07	510/710

Sedia in faggio, piedini fonoassorbenti e poggiatesta fisso verniciato, regolabile in altezza a vite



ART.	H mm
F QZ 1211 00 07	470/645

Sedia in faggio, ruote autobloccanti, regolabile in altezza con pompa a gas



ART.	H mm
F QZ 1210 00 07	445/625

Sedia in faggio, piedini fonoassorbenti, regolabile in altezza con pompa a gas



ART.	H mm
F QZ 1220 00 07	510/760

Sedia in faggio, piedini fonoassorbenti e poggiatesta regolabile cromato, regolabile in altezza con pompa a gas



ART.	H mm
F QZ 1310 00 07	425/565

Sedia in faggio, piedini fonoassorbenti, regolabile in altezza con vite molomatic

SEDIE GIREVOLI IN POLIURETANO



ART.	H mm
F QZ 2211 00 07	495/670

Sedile e schienale in poliuretano, ruote auto-bloccanti, regolabile con pompa a gas



ART.	H mm
F QZ 2210 00 07	470/650

Sedile e schienale in poliuretano, piedini fonosorbenti, regolabile con pompa a gas



ART.	H mm
F QZ 2110 00 07	535/735

Sedile e schienale in poliuretano, piedini fonosorbenti, regolabile in altezza a vite



ART.	H mm
F QZ 2220 00 07	535/785

Sedile e schienale in poliuretano, piedini fonosorbenti e poggiatesta regolabile cromato, regolabile con pompa a gas



ART.	H mm
F AX GREF22 8000 07	420/550

Sedile e schienale in poliuretano integrale antistatico certificato, base in alluminio lucido, piedini antistatici, regolazione in altezza con pompa a gas



ART.	H mm
F AX GREF23 1000 07	420/550

Sedile e schienale in poliuretano integrale antistatico certificato, base in alluminio lucido, ruote antistatiche, regolazione in altezza con pompa a gas

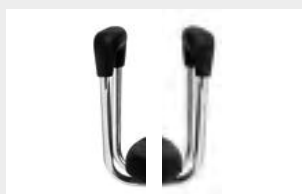

BRACCIOLI

ART. F AX 0H0301 C000 00
coppia braccioli in alluminio



POGGIAPIEDI

ART. F AX 0D0601 0000 00
poggiatesta in alluminio

ACCESSORI MORSE



← - - - - - →
APERTURA ANTERIORE

MORSA FISSA DA BANCO IN ACCIAIO 100 mm

ART.	dim. mm	peso kg	
F22FABL10300000	285x100x105 H	5,2	

APERTURA MASSIMA DELLE GANASCE 100 mm

MORSA FISSA DA BANCO IN ACCIAIO 125 mm

ART.	dim. mm	peso kg	
F22FABL10350000	345x125x132 H	11,2	

APERTURA MASSIMA DELLE GANASCE 125 mm



← - - - - - →
APERTURA ANTERIORE

MORSA GIREVOLE DA BANCO IN ACCIAIO 100 mm

ART.	dim. mm	peso kg	
F22FABL10300100	345x125x132 H	11	

APERTURA MASSIMA DELLE GANASCE 100 mm

MORSA GIREVOLE DA BANCO IN ACCIAIO 125 mm

ART.	dim. mm	peso kg	
F22FABL10350100	345x192x153 H	24	

APERTURA MASSIMA DELLE GANASCE 125 mm



← - - - - - →
APERTURA ANTERIORE

MORSA FISSA DA BANCO IN ACCIAIO 150 mm

ART.	dim. mm	peso kg	
F22FABL10350100	400x150x154 H	11	

APERTURA MASSIMA DELLE GANASCE 150 mm

MORSA GIREVOLE DA BANCO IN ACCIAIO 150 mm

ART.	dim. mm	peso kg	
F22FABL10350100	400x215x177 H	18	

APERTURA MASSIMA DELLE GANASCE 150 mm



ART. F22VT000050Z000

KIT VITI PER FISSAGGIO MORSA SU PIANI IN
MUTIPLEX/ACCIAIO



MORSA DA BANCO IN ACCIAIO 120 mm

ART.	per piani	dim. mm	peso kg
F BL 1085 00 00	in legno	120x56x154 H	11

APERTURA MASSIMA DELLE GANASCE ZIGRINATE 120 mm
 COMPLETA DI SISTEMA DI ELEVAZIONE E RIBALTAMENTO
 SOLO PER PIANI IN LEGNO SPESSORE 40-50 mm



APERTURA POSTERIORE



ACCESSORI GANCI



GANCIO SEMPLICE UNIVERSALE

ART.	∅	A	
C MV 10 035	6 mm	10 mm	
C MV 10 036	6 mm	50 mm	

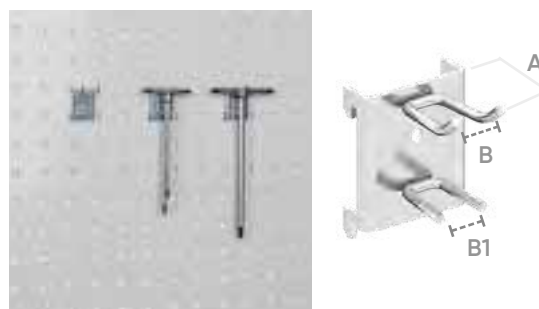

GANCIO DOPPIO

ART.	A	B	B1	
C MV 10 002	28 mm	9 mm	9	
C MV 10 003	33 mm	16 mm	9	



GANCIO INCLINATO UNIVERSALE

ART.	∅	A	
C MV 10 014	5 mm	50 mm	
C MV 10 015	5 mm	100 mm	



PORTA TRAPANO

ART.	A	
C MV 10 030	60 mm	
C MV 10 032	80 mm	



GANCIO AD ANGOLO

ART.	∅	A	B	
C MV 10 016	5 mm	50 mm	40 mm	



DOPPIO GANCIO CHIUSO

ART.	∅	A	B	
C MV 10 004	5 mm	70 mm	26 mm	

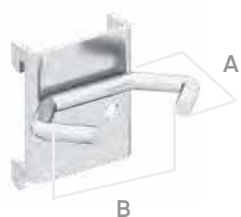

GANCIO CURVO

ART.	Ø	A	B
C MV 10 001	5 mm	28 mm	45 mm

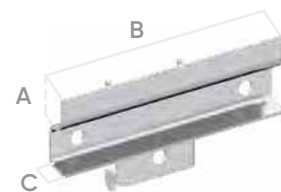

GANCIO PORTA CONTENITORI MIS. 01 - 0 - 1

ART.	A	B	C
C MV 10 026	11 mm	100 mm	10 mm

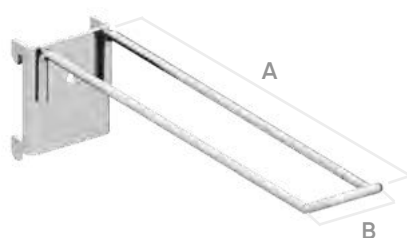

GANCIO PORTA PINZE

ART.	Ø	A	B
C MV 10 027	3,5 mm	172 mm	23 mm

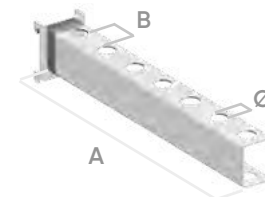

GANCIO PORTA CACCIAVITI

ART.	Ø	A	B
C MV 10 018	12 mm	220 mm	32 mm



GANCIO PORTA BACINELLE

ART.	Ø	B
C MV 10 017	94 mm	23 mm

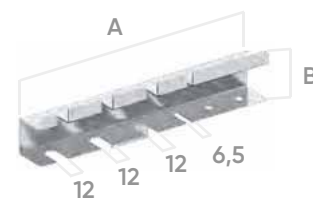

BARRA PORTA CACCIAVITI

ART.	A	B
C MV 10 019	187 mm	40 mm

ACCESSORI GANCI

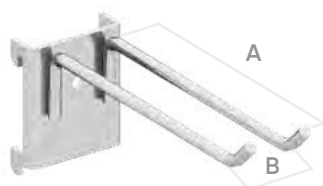

SOSTEGNO DOPPIO

ART.	Ø	A	B
C MV 10 005	5 mm	40 mm	8 mm
C MV 10 006	5 mm	40 mm	11 mm
C MV 10 007	5 mm	55 mm	25 mm
C MV 10 008	5 mm	64 mm	8 mm
C MV 10 009	5 mm	64 mm	9 mm
C MV 10 010	5 mm	105 mm	25 mm
C MV 10 011	5 mm	155 mm	10 mm
C MV 10 012	5 mm	152 mm	25 mm
C MV 10 013	5 mm	200 mm	15 mm

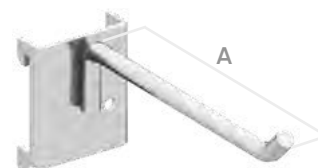

SOSTEGNO SEMPLICE

ART.	Ø	A
C MV 10 037	5 mm	24 mm
C MV 10 038	5 mm	38 mm
C MV 10 039	4 mm	100 mm
C MV 10 040	6 mm	100 mm
C MV 10 041	5 mm	150 mm
C MV 10 042	6 mm	200 mm



PORTA CACCIAVITI

ART.	Ø
C MV 10 020	6 mm
C MV 10 021	12 mm
C MV 10 022	18 mm
C MV 10 023	25 mm



DOPPIO GANCIO CHIUSO

ART.	Ø
C MV 10 029	40 mm
C MV 10 031	60 mm
C MV 10 033	80 mm

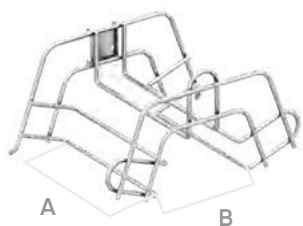

PORTA CAVI

ART.	Ø	A	B
C MV 10 024	5 mm	160 mm	119 mm

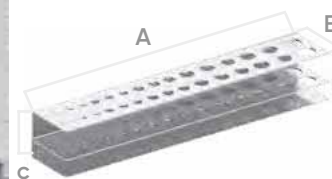
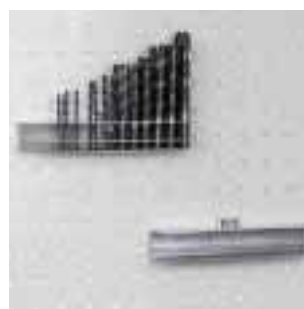

PORTA PUNTE

ART.	A	B	C
C MV 10 028	240 mm	45 mm	38,5 mm



MENSOLA

ART.	A	B	C
C MV 10 043	350 mm	120 mm	10,5 mm



BARRA AGGANCIO CONTENITORI MIS. 1 - 2

ART.	A	B
F BL 7438 00 99	445 mm	86 mm



PORTA CHIAVI

ART.	A
C MV 10 025	555 mm

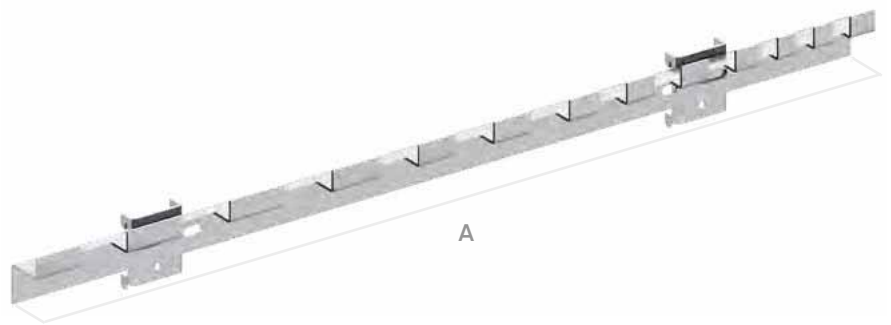

CALAMITE

ART.	CONFEZIONE
F BL 9541 00 00	10 PZ.



VASTA GAMMA

DI CONFIGURAZIONI SU RUOTE

AL SERVIZIO DELLA LOGISTICA

E DEL TRASPORTO IN SICUREZZA

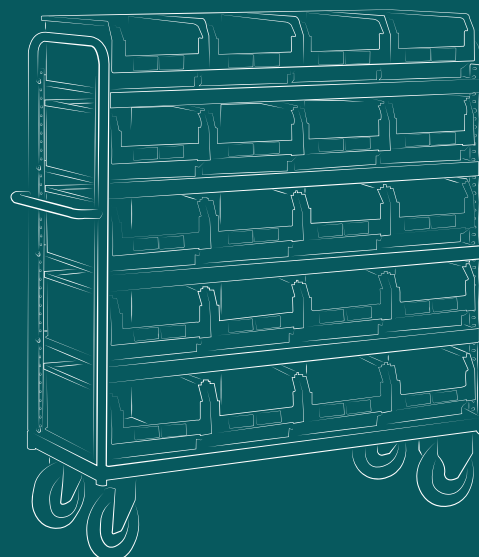
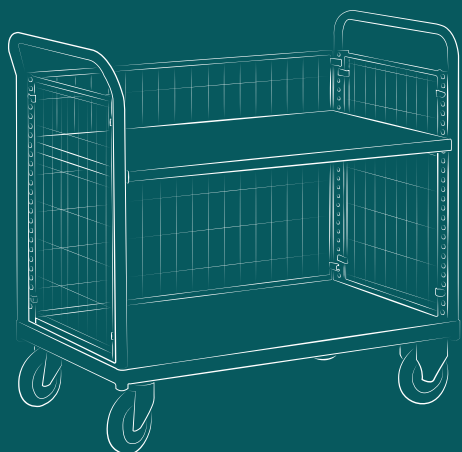



CLEVER-COMBI

CARATTERISTICHE TECNICHE



1



I montanti sono forati con un passo di 26 mm per ottimizzare al massimo il posizionamento dei piani e la loro inclinazione.

2 Il montaggio delle reti laterali è semplice, veloce, senza l'ausilio di alcuna vite. Questo risultato è stato ottenuto grazie alla particolare sagomatura del montante asolato e all'adozione di una clip, che permettono il montaggio senza viti con garanzia assoluta di robustezza e affidabilità nel tempo.



3 Il montaggio delle reti posteriori risulta semplice e veloce grazie all'utilizzo di pannelli standardizzati in rete i quali, mediante viti e clips, vengono fissati ai montanti asolati. La combinazione delle viti e clips permette un fissaggio semplice e robusto.



4 Grazie alla speciale forma del montante e all'utilizzo di una vite, l'innesto risulta preciso, robusto e affidabile nel tempo.



5 Ai carrelli viene applicata un'etichetta di avvertenza per l'uso del carrello e un'etichetta indicante la portata.



7



I carrelli vengono forniti non assemblati per risparmiare fino al 50% sui costi di trasporto.

6



RUOTE IN GOMMA STANDARD



RUOTE IN GOMMA ANTITRACCIA



RUOTE IN GOMMA ELASTICA



RUOTE IN POLIURETANO



RUOTE IN NYLON

H 820 mm



● **ART. F CR 100M 01 04**

Cassette escluse

Gamma colori
ACCIAIO



BLU
RAL 5012
.04



GRIGIO
RAL 7035
.08



FORNITI DI SERIE MONTATI



Completati di 2 ruote fisse, 1 ruota girevole con freno e 1 senza Ø 100 mm in gomma standard



Piano aggiuntivo in acciaio
Dimensioni mm 810x510x35 H

LEGENDA



PORTATA
CARRELLO



Ø RUOTE



LE PORTATE SONO NETTE E SI RIFERISCONO A PESI UNIFORMEMENTE DISTRIBUITI.



ART.			
F CR 100M 00 04		200	100 mm



ART.			
● F CR 100M 01 04		200	100 mm



CLEVER SMALL

ACCESSORI



PIANO AGGIUNTIVO IN ACCIAIO

ART.		dim. mm	
F CR 1004 00 04		810x510x35 H	100



PORTA BOMBOLETTE

ART.		dim. mm
F CR 1008 00 04		475x75x167 H

capacità 6 bombole

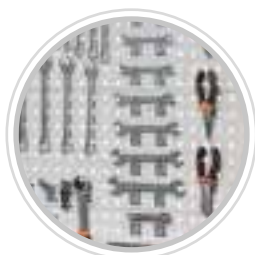

ESEMPIO DI
UTILIZZO DEI
GANCI

PANNELLO FORATO

ART.		dim. mm
F CR 1009 00 04		475x18x665 H



Pannello forato porta attrezzi applicabile in entrambi i lati del CARRELLO.



PORTA ROTOLI IN ACCIAIO

ART.	dim. mm	Ø mm
F CR 1006 00 01	245x88x150 H	130
F CR 1007 00 01	285x155x200 H	240

Rotolo di carta escluso



CLEVER LARGE 1024x615 mm

H 847 mm



● ART. F CR 110M 02 04

Gamma colori

ACCIAIO



BLU
RAL 5012
.04



GRIGIO
RAL 7035
.08



CHIUSURA A CILINDRO (KEY)
FORNITA DI SERIE CON CHIUSURA A CILINDRO



Completati di 2 ruote fisse, 1 ruota girevole con freno
e 1 senza Ø 125 mm in gomma standard



FORNITI DI SERIE MONTATI



Piano aggiuntivo in acciaio
Dimensioni mm 830x610x35 h

LEGENDA



PORTATA
CARRELLO



Ø RUOTE



CHIUSURA
ARMADIO



LE PORTATE SONO NETTE E SI RIFERISCONO A PESI UNIFORMEMENTE DISTRIBUITI.



ART.				
F CR 110M 00 04		300	125 mm	



ART.				
F CR 110M 01 04		300	125 mm	



ART.					
F CR 110M 02 04		300	125 mm	key	



CLEVER LARGE

ACCESSORI



PIANO AGGIUNTIVO IN ACCIAIO

ART.		dim. mm	kg
F CR 1104 00 04		830x610x35 H	100



PORTA ROTOLI IN ACCIAIO

ART.	dim. mm	Ø mm
F CR 1006 00 01	245x88x150 H	130
F CR 1007 00 01	285x155x200 H	240

Rotolo di carta escluso



ESEMPIO DI
UTILIZZO DEL
VISUAL BOX

PANNELLO PORTA VISUAL BOX

ART.	dim. mm
F PG 0430 00 01	600x28x650 H
F PG 0410 00 01	600x28x300 H



PANNELLO FORATO IN ACCIAIO

ART.		dim. mm
F CR 1109 00 04		575x18x655 H



Pannello forato porta attrezzi applicabile in entrambi i lati del CARRELLO.



PORTA BOMBOLETTE

ART.		dim. mm
F CR 1108 00 04		575x75x167 H

capacità 8 bombolette



H 915 mm



● **ART. F CE B105 03 04**

carrello con 2 ruote girevoli con freno e 2 ruote fisse Ø 125 mm in gomma standard.

Gamma colori
ACCIAIO



BLU
RAL 5012
.04



GRIGIO
RAL 7035
.08



FORNITI DI SERIE SMONTATI



Completi di 2 ruote fisse, 1 ruota girevole con freno e 1 senza Ø 200 mm in gomma standard

LEGENDA



PORTATA
CARRELLO



Ø RUOTE



CHIUSURA
ARMADIO



LE PORTATE SONO NETTE E SI RIFERISCONO A PESI UNIFORMEMENTE DISTRIBUITI.



ART.		dim. mm	kg	
F CE P105 04 04		1135x700x1000 h	500	200 mm
F CE P255 04 04		1420x825x1000 h	500	200 mm

CARRELLO SENZA RUOTE

F CE 0105 04 04	1135x700x758 h	-	-
F CE 0255 04 04	1420x825x758 h	-	-

ADATTO PER RUOTE Ø 160-200 mm
Base in acciaio



ART.		dim. mm	kg	
F CE P106 03 04		1135x700x1000 h	500	200 mm
F CE P256 03 04		1420x825x1000 h	500	200 mm

CARRELLO SENZA RUOTE

F CE 0106 03 04	1135x700x758 h	-	-
F CE 0256 03 04	1420x825x758 h	-	-

ADATTO PER RUOTE Ø 160-200 mm
Base in legno



ART.		dim. mm	kg	
F CE P105 03 04		1135x700x1000 h	500	200 mm
F CE P255 03 04		1420x825x1000 h	500	200 mm

CARRELLO SENZA RUOTE

F CE 0105 03 04	1135x700x758 h	-	-
------------------------	----------------	---	---

ADATTO PER RUOTE Ø 160-200 mm
Base in acciaio



ART.		dim. mm	kg	
F CE P105 12 04		1200x700x1000 h	500	200 mm
F CE P255 12 04		1485x825x1000 h	500	200 mm

CARRELLO SENZA RUOTE

F CE 0105 12 04	1200x700x758 h	-	-
F CE 0255 12 04	1485x825x758 h	-	-

ADATTO PER RUOTE Ø 160-200 mm
Base in acciaio

COMBI CE



ART.		dim. mm	kg	
F CE P105 24 04		1095x715x1135 h	500	200 mm

CARRELLO SENZA RUOTE

F CE 0105 24 04		1095x715x893 h	-	-
------------------------	--	----------------	---	---

ADATTO PER RUOTE Ø 160-200 mm
Base in acciaio



ART.		dim. mm	kg	
F CE P105 23 04		1063x700x1080 h	500	200 mm

CARRELLO SENZA RUOTE

F CE 0105 23 04		1063x700x838 h	-	-
------------------------	--	----------------	---	---

ADATTO PER RUOTE Ø 160-200 mm
Base in acciaio



ART.		dim. mm	kg	
F CE P105 06 04		1200x700x1000 h	500	200 mm
F CE P255 06 04		1485x825x1000 h	500	200 mm

CARRELLO SENZA RUOTE

F CE 0105 06 04		1200x700x758 h	-	-
F CE 0255 06 04		1485x825x758 h	-	-

ADATTO PER RUOTE Ø 160-200 mm
Base in acciaio



ART.		dim. mm	kg	
F CE P105 07 04		1200x700x1000 h	500	200 mm
F CE P255 07 04		1485x825x1000 h	500	200 mm

CARRELLO SENZA RUOTE

F CE 0105 07 04		1200x700x758 h	-	-
F CE 0255 07 04		1485x825x758 h	-	-

ADATTO PER RUOTE Ø 160-200 mm
Base in acciaio



ART.		dim. mm	kg	
F CE P105 20 04		1095x700x1000 h	500	200 mm
F CE P255 20 04		1380x825x1000 h	500	200 mm

CARRELLO SENZA RUOTE

F CE 0105 20 04	1095x700x758 h	-	-
F CE 0255 20 04	1380x825x758 h	-	-

ADATTO PER RUOTE Ø 160-200 mm
Base in acciaio



ART.		dim. mm	kg	
F CE P106 20 04		1095x700x1000 h	500	200 mm
F CE P256 20 04		1380x825x1000 h	500	200 mm

CARRELLO SENZA RUOTE

F CE 0106 20 04	1095x700x758 h	-	-
F CE 0256 20 04	1380x825x758 h	-	-

ADATTO PER RUOTE Ø 160-200 mm
Base in legno



ART.		kg		
F CE P105 21 04		500	200 mm	key

CARRELLO SENZA RUOTE

F CE 0105 21 04	-	-	key
-----------------	---	---	-----

Dim. mm 1095x700x758 h
ADATTO PER RUOTE Ø 160-200 mm
Base in acciaio



ART.		kg		
F CE P106 21 04		500	200 mm	key

CARRELLO SENZA RUOTE

F CE 0106 21 04	-	-	key
-----------------	---	---	-----

Dim. mm 1095x700x758 h
ADATTO PER RUOTE Ø 160-200 mm
Base in legno

COMBI CE



GOMMA LISCIA

ART.	dim. mm	per carrelli profondità mm
F CE 0595 00 07	1065x700x2 H	700
F CE 0600 00 07	1345x825x2 H	825



FASCE DI CONTENIMENTO IN ACCIAIO

ART.	dim. mm	per carrelli profondità mm
F CE 0925 00 04	663x38x100 H	700
F CE 0930 00 04	788x38x100 H	825



PORTA DOCUMENTI FORMATO DIN A4

ART.	porta documenti
F CE 0980 00 99	orizzontale in legno
F CE 0985 00 99	verticale in legno





RUOTA GIREVOLE CON FRENO IN GOMMA STANDARD

ART.	Ø mm	C mm	Portata carrello kg
C RG DAC15 200	200	240	500



RUOTA GIREVOLE SENZA FRENO IN GOMMA STANDARD

ART.	Ø mm	C mm	Portata carrello kg
C RG CAC15 200	200	240	500



RUOTA FISSA IN GOMMA STANDARD

ART.	Ø mm	C mm	Portata carrello kg
C RG BAC15 200	200	240	500



RUOTA GIREVOLE CON FRENO ANTITRACCIA

ART.	Ø mm	C mm	Portata carrello kg
C RG DPH25 160	160	200	500



RUOTA FISSA ANTITRACCIA

ART.	Ø mm	C mm	Portata carrello kg
C RG BPH25 160	160	200	500



RUOTA GIREVOLE CON FRENO IN GOMMA ELASTICA

ART.	Ø mm	C mm	Portata carrello kg
C RG DCE15 160	160	200	500



RUOTA FISSA IN GOMMA ELASTICA

ART.	Ø mm	C mm	Portata carrello kg
C RG BCE15 160	160	200	500



RUOTA GIREVOLE CON FRENO IN POLIURETANO

ART.	Ø mm	C mm	Portata carrello kg
C RN DDD44 160	160	200	500



RUOTA FISSA IN POLIURETANO

ART.	Ø mm	C mm	Portata carrello kg
C RN BDD44 160	160	200	500



RUOTA GIREVOLE CON FRENO IN NYLON

ART.	Ø mm	C mm	Portata carrello kg
C RN DAD04 160	160	200	500



RUOTA FISSA IN NYLON

ART.	Ø mm	C mm	Portata carrello kg
C RN BAD04 160	160	200	500



H 1045 mm



● ART. F CF H005 03 04

H 1435 mm



● ART. F CL H005 04 04

Gamma colori

ACCIAIO

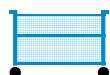

BLU
RAL 5012
.04



GRIGIO
RAL 7035
.08



FORNITI DI SERIE SMONTATI

Completati di 2 ruote fisse, 1 ruota girevole con freno e 1 senza Ø 150 mm in gomma standard



Piano aggiuntivo in acciaio
Dimensioni mm 799x510x30 h



Piano aggiuntivo in legno
Dimensioni mm 795x500x20 h

LEGENDA



PORTATA
CARRELLO



Ø RUOTE



LE PORTATE SONO NETTE E SI RIFERISCONO A PESI UNIFORMEMENTE DISTRIBUITI.



ART.			
● F CF H005 03 04		250	150 mm



ART.			
F CF H005 08 04		250	150 mm



ART.			
F CF H005 07 04		250	150 mm



ART.			
F CF H006 08 04		250	150 mm



ART.			
F CF H006 03 04		250	150 mm



ART.			
F CF H006 04 04		250	150 mm



Completì di 2 ruote fisse, 1 ruota girevole con freno e 1 senza Ø 150 mm in gomma standard





ART.			
F CL H006 06 04		250	150 mm



ART.			
F CL H006 04 04		250	150 mm



ART.			
F CL H006 10 04		250	150 mm



ART.			
● F CL H005 04 04		250	150 mm



ART.			
F CL H005 05 04		250	150 mm



ART.			
F CL H005 03 04		250	150 mm

parete in rete asportabile



Completati di 2 ruote fisse, 1 ruota girevole con freno e 1 senza Ø 150 mm in gomma standard

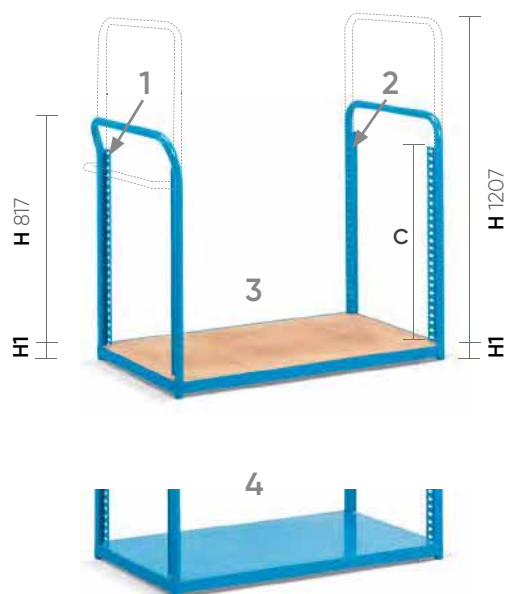

H = 817/ 1207

H1 = 43 mm

C = 685/1100

PIANO AGGIUNTIVO IN ACCIAIO

ART.	dim. mm	kg
F CF 0510 00 04	799x510x30 H	100

ART. F CF 0590 00 07
GOMMA LISCIA PER PIANO
 Colore nero
 Abm. mm 799x510x2 H

BORDI FERMA CASSE IN ACCIAIO

ART.	dim. mm	per
F CF 0900 00 99	795x10x60 H	piani in acciaio
F CF 0901 00 99	795x10x60 H	piani in legno
F CF 0902 00 99	795x10x60 H	basi in acciaio o legno

L'articolo F CF 0902 00 99 non si può ordinare separatamente alla base

PIANO AGGIUNTIVO IN LEGNO

ART.	dim. mm	kg
F CF 0560 00 04	795x500x20 H	100

VASCA AGGIUNTIVA IN LEGNO

ART.	dim. mm	kg
F CF 0800 00 04	795x510x65 H	100

Dimensioni interne mm 755x470x45 H

TESTATA CON MANIGLIA

ART.	dim. mm	rif.
F CF 0605 00 04	521x70x870 H	1
F CL 0605 00 04	521x105x1260 H	1

TESTATA

ART.	dim. mm	rif.
F CF 0615 00 04	521x30x875 H	2
F CL 0615 00 04	521x30x1260 H	2

BASE CON PIANO IN LEGNO

ART.	dim. mm	rif.
F CE G006 00 04	865x525x56 H	3

BASE CON PIANO IN ACCIAIO

ART.	dim. mm	rif.
F CE G005 00 04	865x525x56 H	4

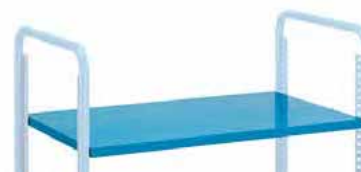

RETI PER TESTATE

ART.	dim. mm
F CF 0625 00 04	384x680 H
F CL 0625 00 04	384x1095 H

Foro maglia mm 50x100

Fornite in 1 pezzo con 4 clips a molla



RETI PER FIANCATE

ART.	dim. mm
F CF 0700 00 04 *	800x680 H
F CL 0700 00 04 **	800x1095 H

Foro maglia mm 50x100

*Fornite in 1 pezzo con 4 staffe a vite - ** Fornite in 2 pezzi con 8 staffe a vite



RUOTA GIREVOLE CON FRENO IN GOMMA STANDARD

ART.	Ø mm	C mm	Portata carrello kg
C RG DAC11 100	100	128	175
C RG DAC12 125	125	155	250
C RG DAC13 150	150	180	250



RUOTA GIREVOLE CON FRENO IN GOMMA ELASTICA

ART.	Ø mm	C mm	Portata carrello kg
C RG DCE15 125	125	155	250



RUOTA FISSA IN GOMMA STANDARD

ART.	Ø mm	C mm	Portata carrello kg
C RG BAC11 100	100	128	175
C RG BAC12 125	125	155	250
C RG BAC13 150	150	180	250



RUOTA FISSA IN GOMMA ELASTICA

ART.	Ø mm	C mm	Portata carrello kg
C RG BCE15 125	125	155	250



RUOTA GIREVOLE SENZA FRENO IN GOMMA STANDARD

ART.	Ø mm	C mm	Portata carrello kg
C RG CAC11 100	100	128	175
C RG CAC12 125	125	155	250
C RG CAC13 150	150	180	250



RUOTA GIREVOLE CON FRENO IN POLIURETANO

ART.	Ø mm	C mm	Portata carrello kg
C RN DDD31 125	125	155	250



RUOTA FISSA IN POLIURETANO

ART.	Ø mm	C mm	Portata carrello kg
C RN BDD31 125	125	155	250



RUOTA GIREVOLE CON FRENO ANTITRACCIA

ART.	Ø mm	C mm	Portata carrello kg
C RG DPH22 125	125	155	250



RUOTA FISSA ANTITRACCIA

ART.	Ø mm	C mm	Portata carrello kg
C RG BPH22 125	125	155	250



RUOTA GIREVOLE CON FRENO IN NYLON

ART.	Ø mm	C mm	Portata carrello kg
C RN DAD10 100	100	128	250
C RN DAD11 125	125	155	250



RUOTA FISSA IN NYLON

ART.	Ø mm	C mm	Portata carrello kg
C RN BAD10 100	100	128	250
C RN BAD11 125	125	155	250



H 1045 mm



● ART. F CF H055 08 04

H 1535 mm



● ART. F CL H056 07 04

Gamma colori

ACCIAIO



BLU
RAL 5012
.04



GRIGIO
RAL 7035
.08



FORNITI DI SERIE SMONTATI



Completati di 2 ruote fisse, 1 ruota girevole con freno e 1 senza Ø 150 mm in gomma standard



Piano aggiuntivo in acciaio
Dimensioni mm 999x610x30 h



Piano aggiuntivo in legno
Dimensioni mm 995x600x20 h

LEGENDA



PORTATA
CARRELLO



Ø RUOTE



LE PORTATE SONO NETTE E SI RIFERISCONO A PESI UNIFORMEMENTE DISTRIBUITI.



ART.			
F CF H055 03 04		250	150 mm



ART.			
F CF H055 08 04		250	150 mm



ART.			
F CF H055 07 04		250	150 mm



ART.			
F CF H056 12 04		250	150 mm



ART.			
F CF H056 03 04		250	150 mm



ART.			
F CF H056 06 04		250	150 mm



Completati di 2 ruote fisse, 1 ruota girevole con freno e 1 senza Ø 150 mm in gomma standard





ART.			
F CL H056 04 04		250	150 mm

ART.			
F CL H056 06 04		250	150 mm



ART.			
● F CL H056 07 04		250	150 mm

ART.			
F CL H055 04 04		250	150 mm



ART.			
F CL H055 05 04		250	150 mm

ART.			
F CL H055 03 04		250	150 mm

parete in rete asportabile



Completati di 2 ruote fisse, 1 ruota girevole con freno e 1 senza Ø 150 mm in gomma standard

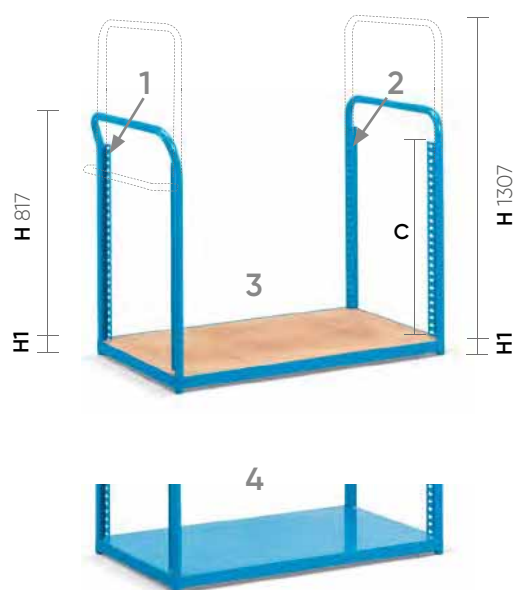

H = 817 / 1307

H1 = 43 mm

C = 685/1200

PIANO AGGIUNTIVO IN ACCIAIO

ART.	dim. mm	kg
F CF 0530 00 04	999x610x30 H	100

ART. F CF 0600 00 07 GOMMA LISCIA PER PIANO

Colore nero
Dim. mm 999x610x2 H

BORDI FERMA CASSE IN ACCIAIO

ART.	dim. mm	per
F CF 0905 00 99	995x10x60 H	piani in acciaio
F CF 0906 00 99	995x10x60 H	piani in legno
F CF 0907 00 99	995x10x60 H	basi in acciaio o legno

L'articolo F CF 0907 00 99 non si può ordinare separatamente alla base

PIANO AGGIUNTIVO IN LEGNO

ART.	dim. mm	kg
F CF 0580 00 04	995x600x20 H	100

VASCA AGGIUNTIVA IN LEGNO

ART.	dim. mm	kg
F CF 0810 00 04	995x610x65 H	100

Dimensioni interne mm 960x580x45 H

TESTATA CON MANIGLIA

ART.	dim. mm	rif.
F CF 0610 00 04	621x70x870 H	1
F CL 0610 00 04	621x105x1360 H	1

TESTATA

ART.	dim. mm	rif.
F CF 0620 00 04	621x30x875 H	2
F CL 0620 00 04	621x30x1360 H	2

BASE CON PIANO IN LEGNO

ART.	dim. mm	rif.
F CE G056 00 04	1065x625x56 H	3

BASE CON PIANO IN ACCIAIO

ART.	dim. mm	rif.
F CE G055 00 04	1065x625x56 H	4

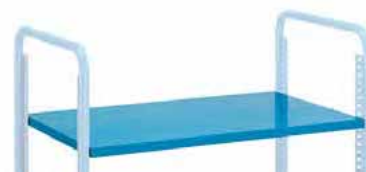

RETI PER TESTATE

ART.	dim. mm
F CF 0630 00 04	484x680 H
F CL 0630 00 04	484x1200 H

Foro maglia mm 50x100

Fornite in 1 pezzo con 4 clips a molla

RETI PER FIANCATE

ART.	dim. mm
F CF 0705 00 04 *	1000x680 H
F CL 0705 00 04 **	1000x1200 H

Foro maglia mm 50x100

*Fornite in 1 pezzo con 4 staffe a vite - ** Fornite in 2 pezzi con 8 staffe a vite

SUPPORTI FORCONABILI

ART.	dim. mm
F CF 0965 00 04	238x615x70 H

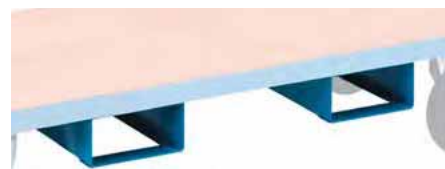
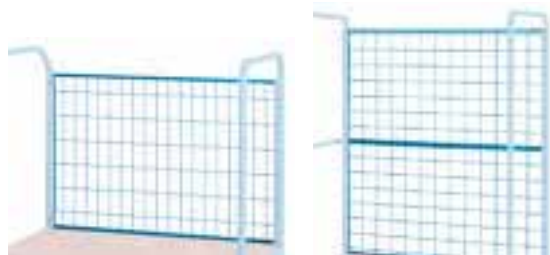

RUOTA GIREVOLE CON FRENO IN GOMMA STANDARD

ART.	Ø mm	C mm	Portata carrello kg
C RG DAC11 100	100	128	175
C RG DAC12 125	125	155	250
C RG DAC13 150	150	180	250



RUOTA GIREVOLE CON FRENO IN GOMMA ELASTICA

ART.	Ø mm	C mm	Portata carrello kg
C RG DCE15 125	125	155	250



RUOTA FISSA IN GOMMA ELASTICA

ART.	Ø mm	C mm	Portata carrello kg
C RG BCE15 125	125	155	250



RUOTA GIREVOLE SENZA FRENO IN GOMMA STANDARD

ART.	Ø mm	C mm	Portata carrello kg
C RG CAC11 100	100	128	175
C RG CAC12 125	125	155	250
C RG CAC13 150	150	180	250



RUOTA GIREVOLE CON FRENO IN POLIURETANO

ART.	Ø mm	C mm	Portata carrello kg
C RN DDD31 125	125	155	250



RUOTA FISSA IN GOMMA STANDARD

ART.	Ø mm	C mm	Portata carrello kg
C RG BAC11 100	100	128	175
C RG BAC12 125	125	155	250
C RG BAC13 150	150	180	250



RUOTA FISSA IN POLIURETANO

ART.	Ø mm	C mm	Portata carrello kg
C RN BDD31 125	125	155	250



RUOTA GIREVOLE CON FRENO ANTITRACCIA

ART.	Ø mm	C mm	Portata carrello kg
C RG DPH22 125	125	155	250



RUOTA FISSA ANTITRACCIA

ART.	Ø mm	C mm	Portata carrello kg
C RG BPH22 125	125	155	250



RUOTA GIREVOLE CON FRENO IN NYLON

ART.	Ø mm	C mm	Portata carrello kg
C RN DAD10 100	100	128	250
C RN DAD11 125	125	155	250



RUOTA FISSA IN NYLON

ART.	Ø mm	C mm	Portata carrello kg
C RN BAD10 100	100	128	250
C RN BAD11 125	125	155	250



H 1200 mm



825 mm

1425 mm

● ART. F CI P255 04 04

H 1800 mm



825 mm

1425 mm

● ART. F CK P256 06 04

Gamma colori
ACCIAIO



BLU
RAL 5012
.04



GRIGIO
RAL 7035
.08



FORNITI DI SERIE SMONTATI



Completati di 2 ruote fisse, 1 ruota girevole con freno e 1 senza Ø 200 mm in gomma standard



Piano aggiuntivo in legno
Dimensioni mm 1280x800x20 h

LEGENDA



PORTATA
CARRELLO



Ø RUOTE



LE PORTATE SONO NETTE E SI RIFERISCONO A PESI UNIFORMEMENTE DISTRIBUITI.



profondità 845 mm

ART.			
------	--	--	--

F CI P255 04 04	500	200 mm
------------------------	-----	--------

parete in rete asportabile



profondità 845 mm

ART.			
------	--	--	--

F CI P256 04 04	500	200 mm
------------------------	-----	--------

parete in rete asportabile



ART.			
------	--	--	--

F CI P256 06 04	500	200 mm
------------------------	-----	--------



ART.			
------	--	--	--

F CI P256 05 04	500	200 mm
------------------------	-----	--------



ART.			
------	--	--	--

F CI P255 03 04	500	200 mm
------------------------	-----	--------



ART.			
------	--	--	--

F CI P255 06 04	500	200 mm
------------------------	-----	--------



Completi di 2 ruote fisse, 1 ruota girevole con freno e 1 senza Ø 200 mm in gomma standard

COMBI





profondità 845 mm

ART.			
F CK P256 04 04		500	200 mm
parete in rete asportabile			



profondità 845 mm

ART.			
F CK P255 04 04		500	200 mm
parete in rete asportabile			



ART.			
F CK P256 03 04		500	200 mm



ART.			
F CK P256 06 04		500	200 mm



ART.			
F CK P255 05 04		500	200 mm



ART.			
F CK P255 07 04		500	200 mm



Completi di 2 ruote fisse, 1 ruota girevole con freno e 1 senza Ø 200 mm in gomma standard

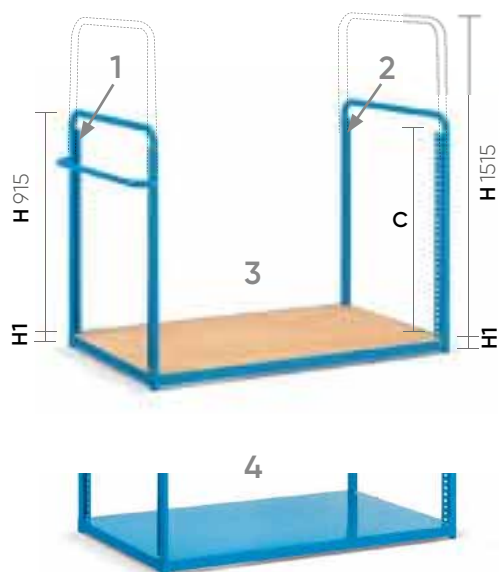

H = 915/ 1515
 H1 = 43 mm
 C = 850/1435

TESTATA CON MANIGLIA

ART.	dim. mm	rif.	
F CI 0605 00 04	821x105x970 H	1	
F CK 0605 00 04	821x105x1570 H	1	

TESTATA

ART.	dim. mm	rif.	
F CI 0615 00 04	821x30x970 H	2	
F CK 0615 00 04	821x30x1570 H	2	

BASE CON PIANO IN LEGNO

ART.	dim. mm	rif.	
F CE N256 00 04	1345x825x56 H	3	

BASE CON PIANO IN ACCIAIO

ART.	dim. mm	rif.	
F CE N255 00 04	1345x825x56 H	4	

PIANO AGGIUNTIVO IN LEGNO

ART.	dim. mm	kg	
F CI 0560 00 04	1280x800x20 H	100	



BORDI FERMA CASSE IN ACCIAIO

ART.	dim. mm	per	
F CG 0911 00 99	1275x10x60 H	piani in legno	
F CG 0912 00 99	1275x10x60 H	basi in acciaio o legno	

L'articolo F CG 0912 00 99 non si può ordinare separatamente alla base



SUPPORTI FORCONABILI

ART.	dim. mm	
F CI 0960 00 04	238x815x70 H	



RETI PER TESTATE

ART.		dim. mm
F CI 0625 00 04		684x810 H
F CK 0625 00 04		684x1405 H

Foro maglia mm 100x100

Fornite in 1 pezzo con 4 clips a molla



RETI PER FIANCATE

ART.		dim. mm
F CI 0700 00 04 *		1280x810 H
F CK 0700 00 04 **		1280x1405 H

Foro maglia mm 100x100

*Fornite in 1 pezzo con 4 staffe a vite - ** Fornite in 2 pezzi con 8 staffe a vite



RUOTA GIREVOLE CON FRENO IN GOMMA STANDARD

ART.	Ø mm	C mm	Portata carrello kg
C RG DAC15 200	200	240	500



RUOTA GIREVOLE CON FRENO IN GOMMA ELASTICA

ART.	Ø mm	C mm	Portata carrello kg
C RG DCE15 160	160	200	500



RUOTA GIREVOLE SENZA FRENO IN GOMMA STANDARD

ART.	Ø mm	C mm	Portata carrello kg
C RG CAC15 200	200	240	500



RUOTA FISSA IN GOMMA ELASTICA

ART.	Ø mm	C mm	Portata carrello kg
C RG BCE15 160	160	200	500



RUOTA FISSA IN GOMMA STANDARD

ART.	Ø mm	C mm	Portata carrello kg
C RG BAC15 200	200	240	500



RUOTA GIREVOLE CON FRENO IN POLIURETANO

ART.	Ø mm	C mm	Portata carrello kg
C RN DDD44 160	160	200	500



RUOTA FISSA IN POLIURETANO

ART.	Ø mm	C mm	Portata carrello kg
C RN BDD44 160	160	200	500



RUOTA GIREVOLE CON FRENO ANTITRACCIA

ART.	Ø mm	C mm	Portata carrello kg
C RG DPH25 160	160	200	500



RUOTA GIREVOLE CON FRENO IN NYLON

ART.	Ø mm	C mm	Portata carrello kg
C RN DAD04 160	160	200	500



RUOTA FISSA ANTITRACCIA

ART.	Ø mm	C mm	Portata carrello kg
C RG BPH25 160	160	200	500



RUOTA FISSA IN NYLON

ART.	Ø mm	C mm	Portata carrello kg
C RN BAD04 160	160	200	500



H 1490 mm



● ART. F CG P155 05 04

Gamma colori

ACCIAIO

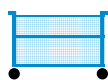

BLU
RAL 5012
.04



GRIGIO
RAL 7035
.08



FORNITI DI SERIE SMONTATI



Completati di 2 ruote fisse, 1 ruota girevole con freno e 1 senza Ø 200 mm in gomma standard



Piano aggiuntivo in acciaio
Dimensioni mm 1280x510x30 h



Piano aggiuntivo in legno
Dimensioni mm 1260x500x12 h

LEGENDA



PORTATA
CARRELLO



Ø RUOTE



LE PORTATE SONO NETTE E SI RIFERISCONO A PESI UNIFORMEMENTE DISTRIBUITI.



ART.			
F CG P156 10 04		500	200 mm



ART.			
F CG P155 05 04		500	200 mm



ART.			
F CG P156 05 04		500	200 mm



ART.			
F CG P155 07 04		500	200 mm



ART.			
F CG P156 13 04		500	200 mm



ART.			
F CG P155 04 04		500	200 mm

CONTENITORI ESCLUSI

1 bordo posteriore zincato sulla base

CARRELLO CON CONTENITORI ART. **F CG P156 19 04**

20 contenitori gialli PICKING BOX **mis.4** art. FAXPBC004B05105

parete in rete asportabile



Completati di 2 ruote fisse, 1 ruota girevole con freno e 1 senza Ø 200 mm in gomma standard

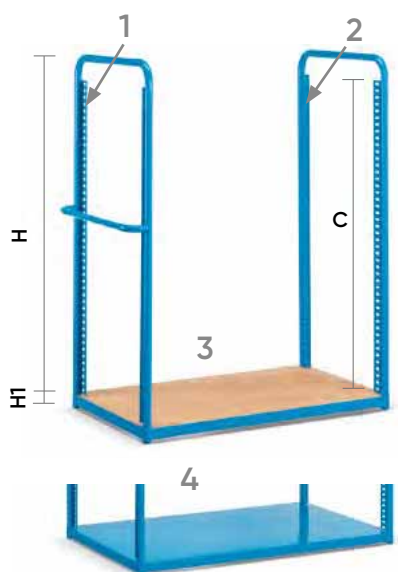

H = 1205 mm

H1 = 43 mm

C = 1100 mm

TESTATA CON MANIGLIA

ART.		dim. mm	rif.	
F CL 0605 00 04		521x105x1260 H	1	

TESTATA

ART.		dim. mm	rif.	
F CL 0615 00 04		521x30x1260 H	2	

BASE CON PIANO IN LEGNO

ART.		dim. mm	rif.	
F CE N156 00 04		1345x525x56 H	3	

BASE CON PIANO IN ACCIAIO

ART.		dim. mm	rif.	
F CE N155 00 04		1345x525x56 H	4	

PIANO AGGIUNTIVO IN ACCIAIO

ART.		dim. mm	kg	
F CG 0510 00 04		1280x510x30 H	100	



ART. F CG 0590 00 07
GOMMA LISCIA PER PIANO
Colore nero
Abm. mm 1280x510x2 H

BORDI FERMA CASSE IN ACCIAIO

ART.	dim. mm	per	
F CG 0910 00 99	1275x10x60 H	piani in acciaio	
F CG 0912 00 99	1275x10x60 H	basi in acciaio o legno	

L'articolo F CG 0912 00 99 non si può ordinare separatamente alla base



PIANO AGGIUNTIVO IN LEGNO

ART.		dim. mm	kg	
F CG 0560 00 04		1260x500x12 H	100	

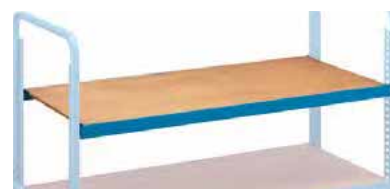

SUPPORTI FORCONABILI

ART.		dim. mm	
F CF 0960 00 04		238x515x70 H	



RETI PER TESTATE

ART.		dim. mm
F CL 0625 00 04		384x1095 H

Foro maglia mm 50x100

Fornite in 1 pezzo con 4 clips a molla



RETI PER FIANCATE

ART.		dim. mm
F CG 0700 00 04 *		1280x1095 H

Foro maglia mm 50x100

*Fornite in 2 pezzi con 8 staffe a vite



RUOTA GIREVOLE CON FRENO IN GOMMA STANDARD

ART.	Ø mm	C mm	Portata carrello kg
C RG DAC15 200	200	240	500



RUOTA GIREVOLE SENZA FRENO IN GOMMA STANDARD

ART.	Ø mm	C mm	Portata carrello kg
C RG CAC15 200	200	240	500



RUOTA FISSA IN GOMMA STANDARD

ART.	Ø mm	C mm	Portata carrello kg
C RG BAC15 200	200	240	500



RUOTA GIREVOLE CON FRENO IN GOMMA ELASTICA

ART.	Ø mm	C mm	Portata carrello kg
C RG DCE15 160	160	200	500



RUOTA FISSA IN GOMMA ELASTICA

ART.	Ø mm	C mm	Portata carrello kg
C RG BCE15 160	160	200	500



RUOTA GIREVOLE CON FRENO IN POLIURETANO

ART.	Ø mm	C mm	Portata carrello kg
C RN DDD44 160	160	200	500



RUOTA FISSA IN POLIURETANO

ART.	Ø mm	C mm	Portata carrello kg
C RN BDD44 160	160	200	500



RUOTA GIREVOLE CON FRENO ANTITRACCIA

ART.	Ø mm	C mm	Portata carrello kg
C RG DPH25 160	160	200	500



RUOTA FISSA ANTITRACCIA

ART.	Ø mm	C mm	Portata carrello kg
C RG BPH25 160	160	200	500



RUOTA GIREVOLE CON FRENO IN NYLON

ART.	Ø mm	C mm	Portata carrello kg
C RN DAD04 160	160	200	500



RUOTA FISSA IN NYLON

ART.	Ø mm	C mm	Portata carrello kg
C RN BAD04 160	160	200	500



H 1590 mm



● ART. F CH P205 05 04

Gamma colori

ACCIAIO



BLU
RAL 5012
.04



GRIGIO
RAL 7035
.08



FORNITI DI SERIE SMONTATI



Completati di 2 ruote fisse, 1 ruota girevole con freno e 1 senza Ø 200 mm in gomma standard



Piano aggiuntivo in acciaio
Dimensioni mm 1280x610x30 h



Piano aggiuntivo in legno
Dimensioni mm 1260x600x12 h

LEGENDA



PORTATA
CARRELLO



Ø RUOTE



LE PORTATE SONO NETTE E SI RIFERISCONO A PESI UNIFORMEMENTE DISTRIBUITI.



ART.			
F CH P205 07 04		500	200 mm



ART.			
F CH P206 11 04		500	200 mm



ART.			
F CH P206 09 04		500	200 mm



ART.			
● F CH P205 05 04		500	200 mm



ART.			
F CH P206 12 04		500	200 mm

CONTENITORI ESCLUSI

1 bordo posteriore zincato sulla base

CARRELLO CON CONTENITORI ART. **F CH P206 14 04**

12 cassette EURO BOX grigie art. FAXEB6417A05101



ART.			
F CH P206 15 04		500	200 mm

CONTENITORI ESCLUSI

1 bordo posteriore zincato sulla base

CARRELLO CON CONTENITORI ART. **F CH P206 16 04**

9 cassette EURO BOX grigie art. FAXEB6422A05101



Completati di 2 ruote fisse, 1 ruota girevole con freno e 1 senza Ø 200 mm in gomma standard

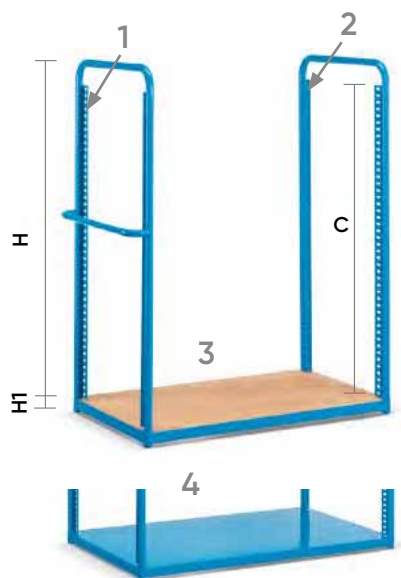

H = 1305 mm
H1 = 43 mm
C = 1200 mm

TESTATA CON MANIGLIA

ART.		dim. mm	rif.	
F CL 0610 00 04		621x105x1360 H	1	

TESTATA

ART.		dim. mm	rif.	
F CL 0620 00 04		621x30x1360 H	2	

BASE CON PIANO IN LEGNO

ART.		dim. mm	rif.	
F CE N206 00 04		1345x625x56 H	3	

BASE CON PIANO IN ACCIAIO

ART.		dim. mm	rif.	
F CE N205 00 04		1345x625x56 H	4	

PIANO AGGIUNTIVO IN ACCIAIO

ART.		dim. mm	kg	
F CH 0510 00 04		1280x610x30 H	100	

ART. F CH 0590 00 07
GOMMA LISCIA PER PIANO
Colore nero
Abm. mm 1280x610x2 H



BORDI FERMA CASSE IN ACCIAIO

ART.	dim. mm	per	
F CG 0910 00 99	1275x10x60 H	piani in acciaio	
F CG 0912 00 99	1275x10x60 H	basi in acciaio o legno	

L'articolo F CG 0912 00 99 non si può ordinare separatamente alla base



PIANO AGGIUNTIVO IN LEGNO

ART.		dim. mm	kg	
F CH 0560 00 04		1260x600x12 H	100	

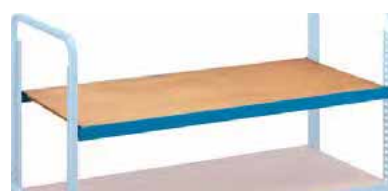

SUPPORTI FORCONABILI

ART.		dim. mm	
F CF 0965 00 04		238x615x70 H	



RETI PER TESTATE

ART.		dim. mm
F CL 0630 00 04		484x1200 H

Foro maglia mm 50x100

Fornite in 1 pezzo con 4 clips a molla

RETI PER FIANCATE

ART.		dim. mm
F CH 0700 00 04 *		1280x1200 H

Foro maglia mm 50x100

*Fornite in 2 pezzi con 8 staffe a vite



RUOTA GIREVOLE CON FRENO IN GOMMA STANDARD

ART.	Ø mm	C mm	Portata carrello kg
C RG DAC15 200	200	240	500



RUOTA GIREVOLE CON FRENO IN GOMMA ELASTICA

ART.	Ø mm	C mm	Portata carrello kg
C RG DCE15 160	160	200	500



RUOTA GIREVOLE SENZA FRENO IN GOMMA STANDARD

ART.	Ø mm	C mm	Portata carrello kg
C RG CAC15 200	200	240	500



RUOTA FISSA IN GOMMA ELASTICA

ART.	Ø mm	C mm	Portata carrello kg
C RG BCE15 160	160	200	500



RUOTA FISSA IN GOMMA STANDARD

ART.	Ø mm	C mm	Portata carrello kg
C RG BAC15 200	200	240	500



RUOTA GIREVOLE CON FRENO IN POLIURETANO

ART.	Ø mm	C mm	Portata carrello kg
C RN DDD44 160	160	200	500



RUOTA FISSA IN POLIURETANO

ART.	Ø mm	C mm	Portata carrello kg
C RN BDD44 160	160	200	500



RUOTA GIREVOLE CON FRENO ANTISTRACCIATA

ART.	Ø mm	C mm	Portata carrello kg
C RG DPH25 160	160	200	500



RUOTA GIREVOLE CON FRENO IN NYLON

ART.	Ø mm	C mm	Portata carrello kg
C RN DAD04 160	160	200	500



RUOTA FISSA ANTISTRACCIATA

ART.	Ø mm	C mm	Portata carrello kg
C RG BPH25 160	160	200	500



RUOTA FISSA IN NYLON

ART.	Ø mm	C mm	Portata carrello kg
C RN BAD04 160	160	200	500





SMART/SLICK



CARRELLI CON CONTENITORI

H 1030 mm



● ART. F CR 0031 02 04

Gamma colori
ACCIAIO 



BLU
RAL 5012
.04



GRIGIO
RAL 7035
.08



FORNITI DI SERIE MONTATI

CARRELLI F CR 0021
Completati di 4 ruote girevoli senza freni Ø 100 mm in gomma standard

CARRELLI F CR 0031
Completati di 2 ruote fisse, 1 ruota girevole con freno e 1 senza Ø 125 mm in gomma standard

LEGENDA



PORTATA
CARRELLO



Ø RUOTE



LE PORTATE SONO NETTE E SI RIFERISCONO A PESI UNIFORMEMENTE DISTRIBUITI.



ART.		kg	
F CR 0031 03 04		300	125 mm

Carrello con:

1 contenitore rosso PICKING BOX **mis.5** art. FAXPBZ005E05103
1 contenitore giallo PICKING BOX **mis.5** art. FAXPBZ005E05105

ART.		kg	
F CR 0031 02 04		300	125 mm

Carrello con:

2 contenitori rossi PICKING BOX **mis.4** art. FAXPBC004B05103
2 contenitori gialli PICKING BOX **mis.4** art. FAXPBC004B05105



ART.		dim. mm	kg	
F CR 0031 00 04		765x560x1030 H	300	125 mm

CARRELLO SENZA RUOTE

F CR 0030 00 04		765x560x875 H	-	-
------------------------	--	---------------	---	---

Carrello adatto per ruote Ø 100/125/150 mm

COMBI CR

RUOTA GIREVOLE CON FRENO IN GOMMA STANDARD

ART.	Ø mm	C mm	Portata carrello kg
C RG DAC11 100	100	128	150
C RG DAC12 125	125	155	300
C RG DAC13 150	150	180	300



RUOTA GIREVOLE CON FRENO IN GOMMA ELASTICA

ART.	Ø mm	C mm	Portata carrello kg
C RG DCE15 125	125	155	300



RUOTA GIREVOLE SENZA FRENO IN GOMMA STANDARD

ART.	Ø mm	C mm	Portata carrello kg
C RG CAC11 100	100	128	150
C RG CAC12 125	125	155	300
C RG CAC13 150	150	180	300



RUOTA FISSA IN GOMMA ELASTICA

ART.	Ø mm	C mm	Portata carrello kg
C RG BCE15 125	125	155	300



RUOTA FISSA IN GOMMA STANDARD

ART.	Ø mm	C mm	Portata carrello kg
C RG BAC11 100	100	128	150
C RG BAC12 125	125	155	300
C RG BAC13 150	150	180	300



RUOTA GIREVOLE CON FRENO IN POLIURETANO

ART.	Ø mm	C mm	Portata carrello kg
C RN DDD31 125	125	155	300



RUOTA FISSA IN POLIURETANO

ART.	Ø mm	C mm	Portata carrello kg
C RN BDD31 125	125	155	300



RUOTA GIREVOLE CON FRENO ANTITRACCIA

ART.	Ø mm	C mm	Portata carrello kg
C RG DPH22 125	125	155	300



RUOTA FISSA ANTITRACCIA

ART.	Ø mm	C mm	Portata carrello kg
C RG BPH22 125	125	155	300



RUOTA GIREVOLE CON FRENO IN NYLON

ART.	Ø mm	C mm	Portata carrello kg
C RN DAD10 100	100	128	300
C RN DAD11 125	125	155	300



RUOTA FISSA IN NYLON

ART.	Ø mm	C mm	Portata carrello kg
C RN BAD10 100	100	128	300
C RN BAD11 125	125	155	300





ART.			
F CR 0021 03 04		150	100 mm

Carrello con:

1 contenitore giallo PICKING BOX **mis.4** art. FAXPBC004B05105
1 contenitore blu PICKING BOX **mis.4** art. FAXPBC004B05104

ART.			
F CR 0021 01 04		150	100 mm

Carrello con:

2 contenitori rossi PICKING BOX **mis.3** art. FAXPBC003B05103
2 contenitori gialli PICKING BOX **mis.3** art. FAXPBC003B05105



ART.			
F CR 0021 00 04		150	100 mm



4 ruote girevoli senza freni Ø 100 mm
in gomma standard

CARRELLO SCALA AUTOFRENANTE

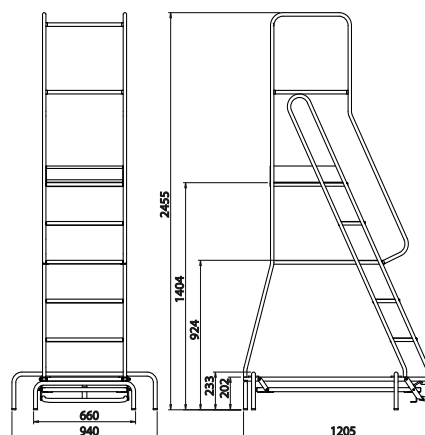

ART.

kg

F CR 0300 00 01

150

Carrello scala autofrenante.
Colore grigio RAL 7000



Il carrello scala è fornito di serie con 4 ruote in gomma girevoli senza freni.



1. Facendo pressione sul primo scalino.

2. il carrello scala scende in posizione di bloccaggio.

3. premendo il pedale di sblocco.

.. il carrello scala è pronto per essere spostato.



ART.

dim. mm

F CR 0800 00 01

200x545x180 H

Piano di appoggio



EURO BOX

EURO BOX LIGHT

NESTABLE BOX

PICKING BOX

STORAGE BOX

RK BOX

VISUAL BOX

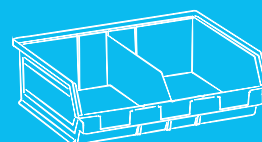
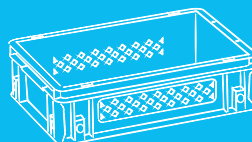
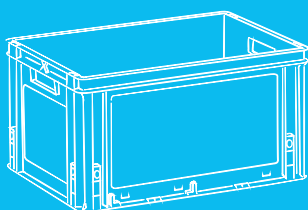



CASSETTE E CONTENITORI

LE MATERIE PRIME



POLIPROPILENE PRIMA SCELTA

Il polipropilene di prima scelta è un materiale plastico atossico particolarmente apprezzato ed impiegato nell'industria e nel design per la realizzazione dei prodotti più disparati in quanto inodore, resistente a molti solventi ed acidi, lavabile e sterilizzabile, resistente all'umidità e non igroscopico. Le performance chimiche e meccaniche rendono il polipropilene ottimale per la produzione di cassette e contenitori, ideali per la movimentazione e lo stoccaggio delle merci.

PP 51 01 polipropilene grigio

PP 51 02 polipropilene verde

PP 51 03 polipropilene rosso

PP 51 04 polipropilene blu

PP 51 05 polipropilene giallo

PP 51 XB polipropilene turchese

 ALTRI COLORI A RICHIESTA



POLIPROPILENE USO ALIMENTARE

Il polipropilene per uso alimentare è un materiale rispondente alla legislazione CEE vigente che disciplina le caratteristiche degli imballaggi e dei contenitori destinati al contatto con gli alimenti. Questo materiale plastico è diffusissimo nell'industria alimentare, dalla fase di preparazione e confezionamento allo stoccaggio e spedizione del prodotto.

 59 00 PP - alimentare bianco

LE CASSETTE IN PLASTICA ALIMENTARE SONO CONFORMI A:

- 1 Decreto Ministeriale 21 marzo 1973 e s.m.i.: Disciplina igienica degli imballaggi, recipienti utensili, destinati a venire in contatto con le sostanze alimentari o con sostanze d'uso personale e successive modifiche ed integrazioni.
- 2 Decreto del Presidente della Repubblica 23 agosto 1982 n. 777 e s.m.i.: Attuazione della Direttiva 76/893/CEE relativa ai materiali e agli oggetti destinati a venire a contatto con i prodotti alimentari e successive modifiche ed integrazioni.
- 3 Regolamento (CE) n. 1935/2004 del Parlamento europeo e del Consiglio, del 27 ottobre 2004, riguardante i materiali e gli oggetti destinati a venire a contatto con i prodotti alimentari e che abroga le direttive 80/590/CEE e 89/109/CEE e successive modifiche ed integrazioni.
- 4 Regolamento (CE) n. 2023/2006 della Commissione del 22 dicembre 2006 sulle buone pratiche di fabbricazione dei materiali e degli oggetti destinati a venire a contatto con prodotti alimentari e successive modifiche ed integrazioni.
- 5 Regolamento (UE) n. 10/2011 della Commissione del 14 gennaio 2011, riguardante i materiali e gli oggetti di materia plastica destinati a venire a contatto con i prodotti alimentari e successive modifiche ed integrazioni.



POLIPROPILENE ECOGREEN

Il polipropilene Ecogreen rappresenta una soluzione ecologica poiché dona nuova vita alla plastica riciclata derivante dalla valorizzazione dei rifiuti plastici da post-consumo.



54 01

ecogreen
grigio



POLIPROPILENE CONDUTTIVO - ESD

Il polipropilene conduttivo è un materiale plastico di alta qualità, perfetto a proteggere dalle scariche elettrostatiche. Le cassette in polipropilene conduttivo consentono lo stoccaggio e il trasporto sicuro di componentistica elettronica sensibile.



52 07

ESD
nero

CARATTERISTICHE TECNICHE

MATERIALE DI BASE	Polipropilene copolimero (PPC)
ADDITTIVO ELETTROCONDUTTIVO	Carbon black
COLORE	Nero
DENSITÀ, A 23°C	1.04 g/cm ³
PUNTO DI RAMMOLLIMENTO DI VICAT	154° C ISO 306
TEMPERATURA DI UTILIZZAZIONE	Permanente: ca. 80-100°C Per breve tempo: ca. 100-120°C
RESISTENZA DI SUPERFICIE	< 10 ⁴ Ω cm (misurata secondo CEI EN 61340-2-3 a 20°C con elettrodo anulare 5 cm ²).
RESISTIVITÀ SPECIFICA	10 ⁴ Ω cm (misurata secondo CEI EN 61340-2-3 a 20°C con elettrodo anulare 5 cm ²)
INVECCHIAMENTO	Nessuna diminuzione secondo conduttività (in 7 anni d'impiego) nessuna migrazione di sostanze corrosive, eccellente resistenza ai raggi UV.
RESISTENZA AGLI AGENTI CHIMICI	Ottima (secondo la classificazione PP, generalmente valida)

SCALA DELLA CONDUTTIVITÀ

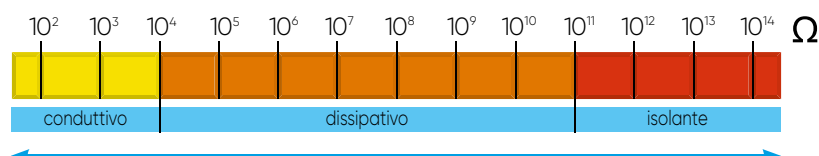

LE MATERIE PRIME

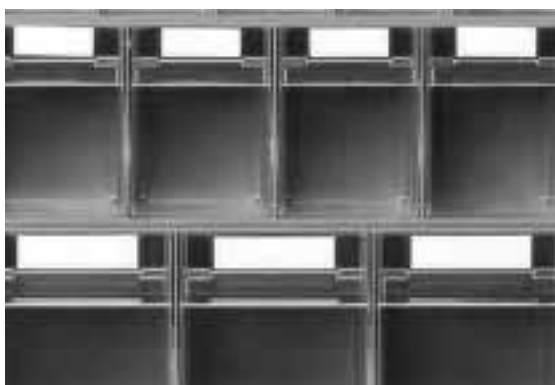

POLISTIROLO

Il polistirolo è una resina trasparente, rigida e brillante, impiegata per la produzione dei cassette estraibili ad apertura basculante della linea Visual Box, per i divisori RK Box e per i coperchi delle cassette divisorio. L'elevata trasparenza, che consente una perfetta visione del contenuto dei cassette, e l'ottima resistenza meccanica ne fanno un prodotto durevole ed affidabile nel tempo.



68 96

polistirolo
trasparente



ABS

L'ABS, deriva dalla pregiata combinazione tra una resina e un elastomero, e deve il suo successo alle ottime proprietà tecniche che lo caratterizzano. Particolarmente lucido, e con migliore estetica superficiale rispetto ad altri polimeri, è un materiale plastico rigido e tenace, con elevato grado di resistenza alle scalfitture e agli urti. Viene sfruttato nella produzione delle cassette Visual Box, che possono essere inserite negli scaffali, nei carrelli oppure fissate direttamente alle pareti.



MARCHIATURA PERSONALIZZATA



MARCHIATURA A CALDO CON
3 TIPOLOGIE DI CLICHÉ

- fino a 100 cm²
- da 101 a 250 cm²
- da 251 a ... cm²



COLORI DISPONIBILI PER LA MARCHIATURA A CALDO



PER LE COLORAZIONI SPECIALI RICHIEDERE FATTIBILITÀ E PREVENTIVO



EURO BOX

Le cassette serie Euro Box, per varietà di materiali impiegati e dimensioni, trovano utilizzo in tutti i settori e rispondono in modo ottimale sia alle esigenze di stoccaggio che di distribuzione. Impilabili con e senza coperchio, sono conformi alle dimensioni degli euro-pallet. Bordi e rinforzi sono stati studiati per conferire alle cassette una struttura tale da renderle resistenti ai carichi più pesanti. Il fondo e le pareti delle cassette possono essere chiusi oppure forati. Anche le maniglie si differenziano in aperte o chiuse. La diversa composizione di questi elementi consente svariate soluzioni e non preclude la possibilità di soluzioni personalizzate.

MANIGLIE

maniglia aperta



maniglia chiusa



PARETI

pareti chiuse



pareti forate



pareti con finestra lato LUNGO



pareti con finestra lato CORTO



FONDI

fondo chiuso



fondo rinforzato

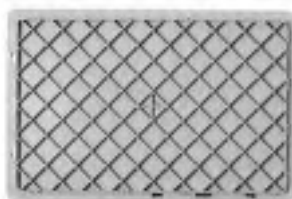

fondo forato



fondo predisposto per ruote

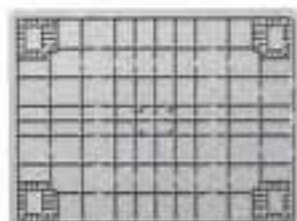

CODIFICA Euro Box



MATERIA PRIMA



51 01

polipropilene grigio



51 XB

polipropilene turchese



52 07

PP - ESD nero



59 00

PP - alimentare bianco



54 01

ecogreen grigio

COPERCHI



A CERNIERA



CON MANIGLIE



L'utilizzo del coperchio non preclude la possibilità di sovrapporre le cassette



CASSETTE DIVISORIO

Le **cassette divisorio** offrono la possibilità di **suddividere** in modo **razionale** le cassette della serie **Euro Box** in due o più comparti a seconda della **soluzione prescelta**. È disponibile un pratico **coperchio parapolvere** realizzato in **polistirolo trasparente**, sollevabile grazie all'**apposita presa**.



MOLLA PORTA BOLLA

La molla porta bolla viene applicata a **scatto** sul lato lungo o sul lato corto delle cassette **Euro Box** con la funzione di **bloccare** bolle o altri documenti.

GANCI DI CHIUSURA

Il **coperchio** delle cassette serie **Euro Box** nella versione a cerniera e con maniglie può essere chiuso con gancio di scorrimento in nylon.



chiusura con piombo





ART.		dim. cassetta mm		minimo d'ordine	multiplo d'ordine	dim. pallet mm	disponibilità
	51 01			1 pezzo	1 pezzo		a magazzino
	51 XB			480 pezzi (pallet)	480 pezzi (pallet)		a magazzino
FAX EB 2115 A O	52 07	200 x 150 x 150 h	2,7	200 pezzi	24 pezzi	1200 x 800 x 2280 h	a richiesta
	54 01			200 pezzi	24 pezzi		a richiesta
	59 00			200 pezzi	24 pezzi		a richiesta

A

Pareti CHIUSE

Pareti CHIUSE
Maniglie CHIUSE

Fondo CHIUSO

Volume in litri
per cassetta singola

**MARCHIATURA
PERSONALIZZATA**
a richiesta

MISURE TECNICHE CASSETTA

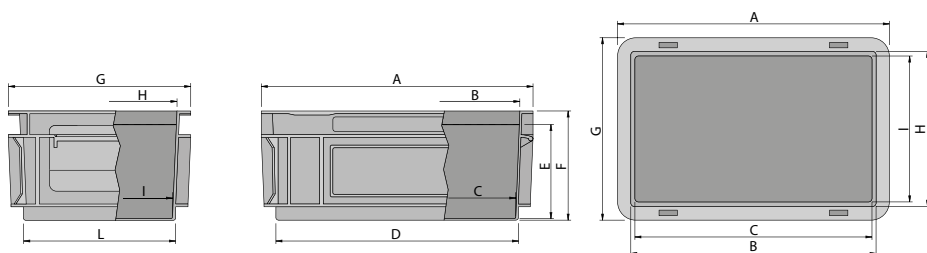

ART. CASSETTA	A	B	C	D	E	F	G	H	I	L
FAX EB 2115 A O	201	167	158	165	140	151	151	116	109	115

Gamma materiali/colore

51 01 polipropilene grigio

51 XB polipropilene turchese

52 07 PP - ESD nero

59 00 PP - alimentare bianco

54 01 ecogreen grigio

**ALTRI COLORI
A RICHIESTA**



EURO BOX

300x200 mm



ART.		dim. cassetta mm		minimo d'ordine	q.tà per pallet	dim. pallet mm	disponibilità
FAX EB 3212 A 0	51 01	300 x 200 x 120 h	5	1 pezzo	320	1200 x 800 x 2240 h	a magazzino
	51 XB			pallet			a magazzino
	52 07			200 pezzi			a richiesta
	54 01			200 pezzi			a richiesta
	59 00			200 pezzi			a richiesta
FAX EB 3217 A 0	51 01	300 x 200 x 170 h	7	1 pezzo	224	1200 x 800 x 2320 h	a magazzino
	51 XB			pallet			a magazzino
	52 07			200 pezzi			a richiesta
	54 01			200 pezzi			a richiesta
	59 00			200 pezzi			a richiesta

A



Pareti CHIUSE



Pareti CHIUSE
Maniglie CHIUSE



Fondo CHIUSO



Volume in litri
per cassetta singola



MARCHIATURA
PERSONALIZZATA
a richiesta

Gamma materiali/colore



51 01 polipropilene grigio



51 XB polipropilene turchese



52 07 PP - ESD nero



59 00 PP - alimentare bianco



54 01 ecogreen grigio

ALTRI COLORI A RICHIESTA

ACCESSORI



MOLLA PORTA BOLLA

ART.	dim. mm	minimo d'ordine	disponibilità
FAX EB MB0 000 00 99	75 x 20 x 20 h	1 pezzo	a magazzino



COPPIA GANCI DI CHIUSURA

ART.	minimo d'ordine	q.tà per confezione	disponibilità
FAX EB GNO 000 81 13	confezione	10	a magazzino

Coppia ganci a scorrimento adatte per coperchi a cerniera per cassette Serie Euro Box

chiusura con piombino



COPERCHIO A CERNIERA

ART.	dim. mm	minimo d'ordine	q.tà per pallet	disponibilità
51 01		1 pezzo		a magazzino
51 XB		pallet		a magazzino
FAX EB 32HG 00	300 x 200	200 pezzi	2560	a richiesta
54 01		200 pezzi		a richiesta
59 00		200 pezzi		a richiesta

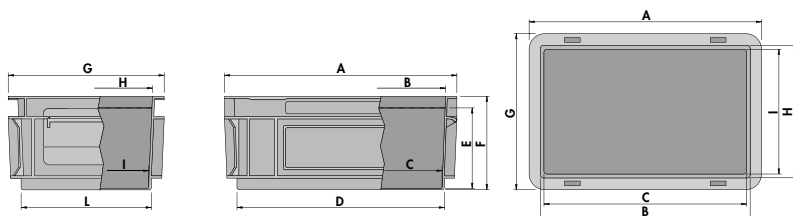

MISURE TECNICHE CASSETTE



ART. CASSETTE	A	B	C	D	E	F	G	H	I	L
FAX EB 3212 A 0	298	268	259	268	102	120	199	168	161	168
FAX EB 3217 A 0	298	267	259	267	151	170	198	166	160	167

EURO BOX 400x300 mm



ART.		dim. cassetta mm		minimo d'ordine	q.tà per pallet	dim. pallet mm	disponibilità
FAX EB 4305 A 0	51 01	400 x 300 x 55 h	3,8	pallet	400	1200 x 800 x 2280 h	a magazzino
	51 XB			pallet			a magazzino
	52 07			200 pezzi			a richiesta
	54 01			200 pezzi			a richiesta
	59 00			200 pezzi			a richiesta
FAX EB 4308 A 0	51 01	400 x 300 x 75 h	6	1 pezzo	280	1200 x 800 x 2335 h	a magazzino
	51 XB			pallet			a magazzino
	52 07			200 pezzi			a richiesta
	54 01			200 pezzi			a richiesta
	59 00			200 pezzi			a richiesta
FAX EB 4312 A 0	51 01	400 x 300 x 120 h	10	1 pezzo	160	1200 x 800 x 2230 h	a magazzino
	51 XB			pallet			a magazzino
	52 07			pallet			a magazzino
	54 01			1 pezzo			a magazzino
	59 00			200 pezzi			a richiesta
FAX EB 4312 H 0	51 01	400 x 300 x 120 h	10	pallet	160	1200 x 800 x 2230 h	a magazzino
	51 XB			pallet			a magazzino
	52 07			200 pezzi			a richiesta
	54 01			200 pezzi			a richiesta
	59 00			200 pezzi			a richiesta
FAX EB 4312 C 0	51 01	400 x 300 x 120 h	10	pallet	160	1200 x 800 x 2230 h	a magazzino
	51 XB			pallet			a magazzino
	52 07			200 pezzi			a richiesta
	54 01			200 pezzi			a richiesta
	59 00			200 pezzi			a richiesta



A

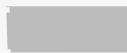

Pareti CHIUSE



Pareti CHIUSE
Maniglie CHIUSE



Fondo CHIUSO

H



Pareti FORATE



Pareti CHIUSE
Maniglie CHIUSE



Fondo FORATO

C



Pareti CHIUSE



Pareti CHIUSE
Maniglie CHIUSE



Fondo RINFORZATO



Volume in litri
per cassetta singola



**MARCHIATURA
PERSONALIZZATA**
a richiesta

EURO BOX 400x300 mm

ART.		dim. cassetta mm		minimo d'ordine	q.tà per pallet	dim. pallet mm	disponibilità
FAX EB 4317 A O	51 01	400 x 300 x 170 h	15	1 pezzo	112	1200 x 800 x 2320 h	a magazzino
	51 XB			pallet			a magazzino
	52 07			pallet			a magazzino
	54 01			1 pezzo			a magazzino
	59 00			200 pezzi			a richiesta
FAX EB 4317 C O	51 01	400 x 300 x 170 h	15	pallet	112	1200 x 800 x 2320 h	a magazzino
	51 XB			pallet			a magazzino
	52 07			200 pezzi			a richiesta
	54 01			200 pezzi			a richiesta
	59 00			200 pezzi			a richiesta
FAX EB 4322 A O	51 01	400 x 300 x 220 h	20	1 pezzo	80	1200 x 800 x 2200 h	a magazzino
	51 XB			pallet			a magazzino
	52 07			pallet			a magazzino
	54 01			1 pezzo			a magazzino
	59 00			200 pezzi			a richiesta
FAX EB 4322 B O	51 01	400 x 300 x 220 h	20	1 pezzo	80	1200 x 800 x 2200 h	a magazzino
	51 XB			pallet			a magazzino
	52 07			200 pezzi			a richiesta
	59 00			200 pezzi			a richiesta
FAX EB 4322 D O	51 01	400 x 300 x 220 h	20	pallet	80	1200 x 800 x 2200 h	a magazzino
	51 XB			pallet			a magazzino
	52 07			200 pezzi			a richiesta
	59 00			200 pezzi			a richiesta
FAX EB 4332 A O	51 01	400 x 300 x 325 h	30	1 pezzo	56	1200 x 800 x 2300 h	a magazzino
	51 XB			pallet			a magazzino
	52 07			pallet			a magazzino
	54 01			1 pezzo			a magazzino
	59 00			200 pezzi			a richiesta
FAX EB 4332 B O	51 01	400 x 300 x 325 h	30	pallet	56	1200 x 800 x 2300 h	a magazzino
	51 XB			pallet			a magazzino
	52 07			200 pezzi			a richiesta
	59 00			200 pezzi			a richiesta



A



Pareti CHIUSE



Pareti CHIUSE
Maniglie CHIUSE



Fondo CHIUSO

B



Pareti CHIUSE



Pareti CHIUSE
Maniglie APERTE



Fondo CHIUSO

C

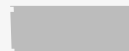

Pareti CHIUSE



Pareti CHIUSE
Maniglie CHIUSE



Fondo RINFORZATO

D

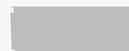

Pareti CHIUSE



Pareti CHIUSE
Maniglie APERTE



Fondo RINFORZATO



Volume in litri
per cassetta singola



**MARCHIATURA
PERSONALIZZATA**
a richiesta

EURO BOX 400x300 ACCESSORI

COPERCHIO A CERNIERA



ART.		dim. mm	minimo d'ordine	q.tà per pallet	disponibilità
FAX EB43 HG 00	51 01	400 x 300	1 pezzo	640	a magazzino
	51 XB		pallet		a magazzino
	52 07		pallet		a magazzino
	54 01		1 pezzo		a magazzino
	59 00		pallet		a magazzino

COPERCHIO CON MANIGLIE



ART.		dim. mm	minimo d'ordine	q.tà per pallet	disponibilità
FAX EB43 SE 00	51 01	400 x 300	1 pezzo	480	a magazzino
	51 XB		pallet		a magazzino
	52 07		pallet		a magazzino
	54 01		200 pezzi		a richiesta
	59 00		200 pezzi		a richiesta

MISURE TECNICHE CASSETTE

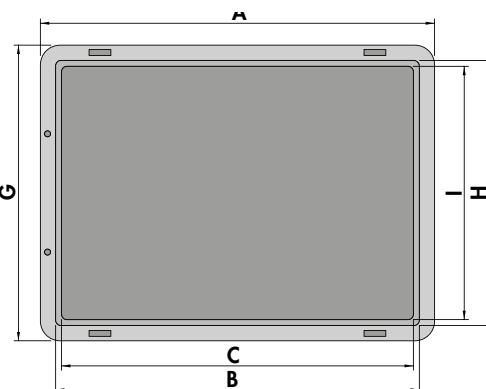
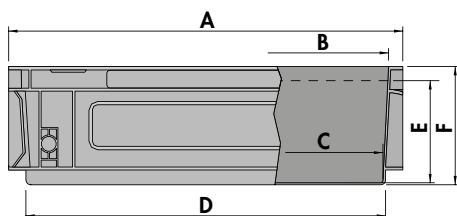
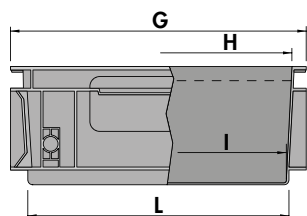

ART. CASSETTE	A	B	C	D	E	F	G	H	I	L
FAX EB 4305 A O	402	366	355	364	36	55	302	265	255	266
FAX EB 4308 A O	400	369	355	365	57	75	300	268	255	267
FAX EB 4312 A O	401	369	358	367	102	121	300	268	258	267
FAX EB 4312 C O	402	369	358	366	94	121	300	268	253	265
FAX EB 4312 H O	402	369	353	364	102	120	300	269	253	264
FAX EB 4317 A O	402	370	358	367	152	171	300	268	258	268
FAX EB 4317 C O	401	370	359	367	145	170	300	269	258	268
FAX EB 4322 A O	401	370	358	367	202	221	301	270	258	268
FAX EB 4322 B O	401	369	358	368	202	221	301	267	257	267
FAX EB 4322 D O	401	370	358	364	195	221	301	270	258	264
FAX EB 4332 A O	402	371	357	367	306	325	301	268	258	268
FAX EB 4332 B O	401	369	357	367	305	324	300	268	257	267



ALTRI COLORI A RICHIESTA

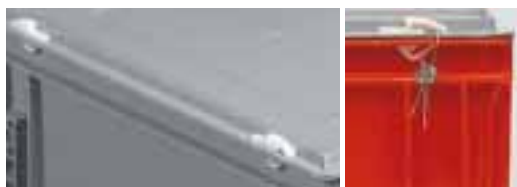

chiusura con piombino

COPPIA GANCI DI CHIUSURA

ART.	minimo d'ordine	q.tà per confezione	disponibilità
FAX EB GNO 000 81 13	confezione	10	a magazzino

Coppia ganci a scorrimento adatte per coperchi a cerniera per cassette Serie Euro Box



MOLLA PORTA BOLLA

ART.	dim. mm	minimo d'ordine	disponibilità
FAX EB MB0 000 00 99	75 x 20 x 20 h	1 pezzo	a magazzino

CASSETTE DIVISORIO



CASSETTE DIVISORIO

ART.		dim. mm	minimo d'ordine	q.tà per cartone	disponibilità
FAX EB 43S1 00	54 07	256 x 178 x 90 h	cartone	20	a magazzino
	52 07		cartone		a magazzino



ART.		dim. mm	minimo d'ordine	q.tà per cartone	disponibilità
FAX EB 43S2 00	54 07	256 x 178 x 90 h	cartone	20	a magazzino
	52 07		cartone		a magazzino



ART.		dim. mm	minimo d'ordine	q.tà per cartone	disponibilità
FAX EB 43S4 00	54 07	256 x 178 x 90 h	cartone	20	a magazzino
	52 07		cartone		a magazzino



COPERCHIO TRASPARENTE PS

ART.	dim. mm	minimo d'ordine	q.tà per cartone	disponibilità
FAX EB LID 400 68 96	256 x 178	cartone	20	a magazzino

ESEMPI SUDDIVISIONE CASSETTE



CASSETTASUDDIVISA CON

1 ART. FAX EB 43S1 00 _____
1 ART. FAX EB 43S2 00 _____



CASSETTASUDDIVISA CON

1 ART. FAX EB 43S1 00 _____
1 ART. FAX EB 43S4 00 _____



CASSETTASUDDIVISA CON

1 ART. FAX EB 43S2 00 _____
1 ART. FAX EB 43S4 00 _____



54 07 ecogreen
nero

EURO BOX

600x400 mm



ART.		dim. cassetta mm		minimo d'ordine	q.tà per pallet	dim. pallet mm	disponibilità
FAX EB 6408 A O	51 01	600 x 400 x 75 h	10	1 pezzo	140	1200 x 800 x 2345 h	a magazzino
	51 XB			pallet			a magazzino
	52 07			pallet			a magazzino
	54 01			pallet			a magazzino
	59 00			pallet			a magazzino
FAX EB 6412 A O	51 01	600 x 400 x 120 h	20	1 pezzo	80	1200 x 800 x 2240 h	a magazzino
	51 XB			pallet			a magazzino
	52 07			pallet			a magazzino
	54 01			1 pezzo			a magazzino
	59 00			pallet			a magazzino
FAX EB 6412 G O	51 01	600 x 400 x 120 h	20	pallet	80	1200 x 800 x 2240 h	a magazzino
	51 XB			pallet			a magazzino
	52 07			pallet			a magazzino
	54 01			pallet			a magazzino
	59 00			pallet			a magazzino
FAX EB 6412 H O	51 01	600 x 400 x 120 h	20	pallet	80	1200 x 800 x 2240 h	a magazzino
	51 XB			pallet			a magazzino
	52 07			pallet			a magazzino
	54 01			pallet			a magazzino
	59 00			pallet			a magazzino
FAX EB 6412 C O	51 01	600 x 400 x 120 h	20	pallet	80	1200 x 800 x 2240 h	a magazzino
	51 XB			pallet			a magazzino
	52 07			pallet			a magazzino
	54 01			pallet			a magazzino
	59 00			pallet			a magazzino

Gamma materiali/colore

 PP

 PP

 ESD

 Alimentare

 Riciclabile

51 01 polipropilene grigio
 51 XB polipropilene turchese
 52 07 PP - ESD nero
 59 00 PP - alimentare bianco
 54 01 ecogreen grigio

 ALTRI COLORI A RICHIESTA

ART.		dim. cassetta mm		minimo d'ordine	q.tà per pallet	dim. pallet mm	disponibilità
FAX EB 6417 A 0	51 01	600 x 400 x 170 h	30	1 pezzo	56	1200 x 800 x 2330 h	a magazzino
	51 XB			pallet			a magazzino
	52 07			pallet			a magazzino
	54 01			1 pezzo			a magazzino
	59 00			pallet			a richiesta
FAX EB 6417 C 0	51 01	600 x 400 x 170 h	30	pallet	56	1200 x 800 x 2330 h	a magazzino
	51 XB			pallet			a magazzino
	52 07			200 pezzi			a richiesta
	54 01			200 pezzi			a richiesta
	59 00			200 pezzi			a richiesta
FAX EB 6422 A 0	51 01	600 x 400 x 220 h	40	1 pezzo	40	1200 x 800 x 2200 h	a magazzino
	51 XB			pallet			a magazzino
	52 07			200 pezzi			a richiesta
	54 01			1 pezzo			a magazzino
	59 00			200 pezzi			a richiesta
FAX EB 6422 B 0	51 01	600 x 400 x 220 h	40	1 pezzo	40	1200 x 800 x 2200 h	a magazzino
	51 XB			pallet			a magazzino
	52 07			200 pezzi			a richiesta
	59 00			200 pezzi			a richiesta
	FAX EB 6422 S 0			51 01			600 x 400 x 220 h
51 XB		pallet	a magazzino				
52 07		200 pezzi	a richiesta				
59 00		200 pezzi	a richiesta				

A



Pareti CHIUSE



Pareti CHIUSE
Maniglie CHIUSE

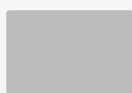

Fondo CHIUSO

G



Pareti FORATE



Pareti CHIUSE
Maniglie CHIUSE

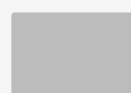

Fondo CHIUSO

B



Pareti CHIUSE



Pareti CHIUSE
Maniglie APERTE

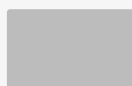

Fondo CHIUSO

H



Pareti FORATE



Pareti CHIUSE
Maniglie CHIUSE

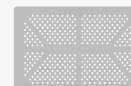

Fondo FORATO

C



Pareti CHIUSE



Pareti CHIUSE
Maniglie CHIUSE



Fondo RINFORZATO

S



Pareti FORATE



Pareti FORATE
Maniglie APERTE



Fondo FORATO



Volume in litri
per cassetta singola



MARCHIATURA
PERSONALIZZATA
a richiesta

ART.		dim. cassetta mm		minimo d'ordine	q.tà per pallet	dim. pallet mm	disponibilità	
FAX EB 6422	D O	600 x 400 x 220 h	40	pallet	40	1200 x 800 x 2200 h	a magazzino	
				51 01			pallet	a magazzino
				51 XB			200 pezzi	a richiesta
				52 07			200 pezzi	a richiesta
				59 00			a richiesta	
FAX EB 6428	A O	600 x 400 x 285 h	53	pallet	32	1200 x 800 x 2270 h	a magazzino	
				51 01			pallet	a magazzino
				51 XB			200 pezzi	a richiesta
				52 07			pallet	a magazzino
				54 01			a richiesta	
				59 00			a richiesta	
FAX EB 6428	B O	600 x 400 x 285 h	53	pallet	32	1200 x 800 x 2270 h	a magazzino	
				51 01			pallet	a magazzino
				51 XB			200 pezzi	a richiesta
				52 07			200 pezzi	a richiesta
				59 00			a richiesta	
FAX EB 6428	D O	600 x 400 x 285 h	53	pallet	32	1200 x 800 x 2270 h	a magazzino	
				51 01			pallet	a magazzino
				51 XB			200 pezzi	a richiesta
				52 07			200 pezzi	a richiesta
				59 00			a richiesta	
FAX EB 6432	A O	600 x 400 x 325 h	60	1 pezzo	40	1200 x 800 x 3275 h	a magazzino	
				51 01			pallet	a magazzino
				51 XB			pallet	a magazzino
				52 07			200 pezzi	a richiesta
				54 01			1 pezzo	a magazzino
				59 00			a richiesta	
FAX EB 6432	B O	600 x 400 x 325 h	60	1 pezzo	40	1200 x 800 x 3275 h	a magazzino	
				51 01			pallet	a magazzino
				51 XB			200 pezzi	a richiesta
				52 07			200 pezzi	a richiesta
				59 00			a richiesta	
FAX EB 6432	R O	600 x 400 x 325 h	60	pallet	40	1200 x 800 x 3275 h	a magazzino	
				51 01			pallet	a magazzino
				51 XB			200 pezzi	a richiesta
				52 07			200 pezzi	a richiesta
				59 00			a richiesta	
FAX EB 6432	D O	600 x 400 x 325 h	60	pallet	40	1200 x 800 x 3275 h	a magazzino	
				51 01			pallet	a magazzino
				51 XB			200 pezzi	a richiesta
				52 07			200 pezzi	a richiesta
				59 00			a richiesta	
FAX EB 6443	B O	600 x 400 x 430 h	90	1 pezzo	20	1200 x 800 x 2200 h	a magazzino	
				51 01			pallet	a magazzino
				51 XB			200 pezzi	a richiesta
				52 07			200 pezzi	a richiesta
				59 00			a richiesta	
FAX EB 6443	R O	600 x 400 x 430 h	90	pallet	20	1200 x 800 x 2200 h	a magazzino	
				51 01			pallet	a magazzino
				51 XB			200 pezzi	a richiesta
				52 07			200 pezzi	a richiesta
				59 00			a richiesta	

ART.		dim. cassetta mm	L	minimo d'ordine	q.tà per pallet	dim. pallet mm	disponibilità
FAX EB 6443 U 0	51 01	600 x 400 x 430 h	90	pallet	20	1200 x 800 x 2200 h	a magazzino
	51 XB			pallet			a magazzino
	52 07			200 pezzi			a richiesta
	59 00			200 pezzi			a richiesta
FAX EB 6443 V 0	51 01	600 x 400 x 430 h	90	pallet	20	1200 x 800 x 2200 h	a magazzino
	51 XB			pallet			a magazzino
	52 07			200 pezzi			a richiesta
	59 00			200 pezzi			a richiesta



U



V

A

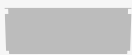

Pareti CHIUSE



Pareti CHIUSE
Maniglie CHIUSE



Fondo CHIUSO

R



Pareti FORATE



Pareti FORATE
Maniglie APERTE



Fondo CHIUSO

B

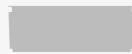

Pareti CHIUSE



Pareti CHIUSE
Maniglie APERTE



Fondo CHIUSO

D



Pareti CHIUSE



Pareti CHIUSE
Maniglie APERTE



Fondo RINFORZATO

U



Pareti CHIUSE



1 parete con finestra
1 parete chiusa con
maniglia



Fondo CHIUSO

V



1 parete con finestra
1 parete chiusa



Pareti CHIUSE
Maniglie APERTE



Fondo CHIUSO



Volume in litri
per cassetta singola



MARCHIATURA
PERSONALIZZATA
a richiesta

EURO BOX 600x400 mm

MISURE TECNICHE CASSETTE

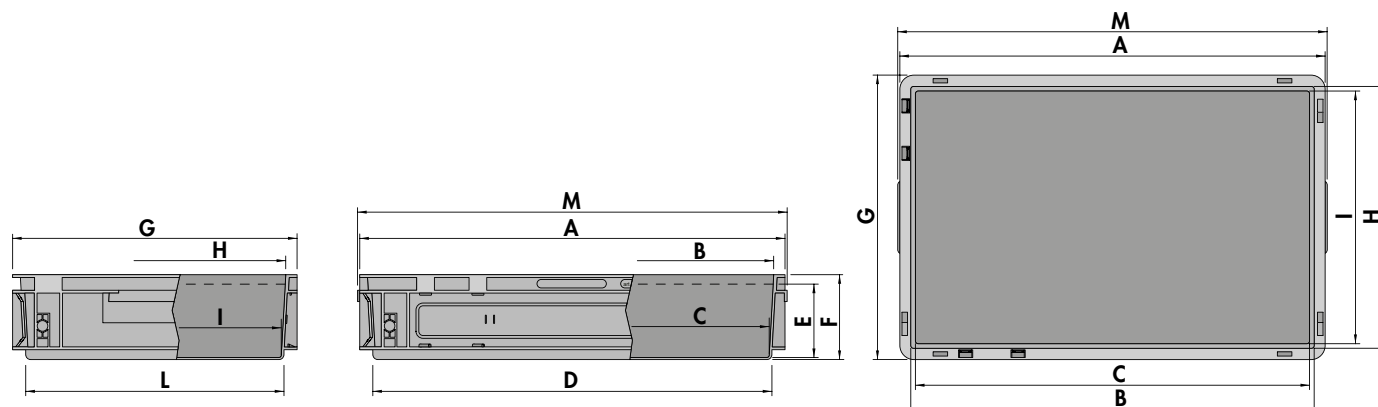

ART. CASSETTA	A	B	C	D	E	F	G	H	I	L	M
FAX EB 6408 A O	602	566	555	563	58	77	404	366	355	364	606
FAX EB 6412 A O	601	569	558	567	101	121	402	369	356	366	601
FAX EB 6412 C O	602	570	554	565	95	121	402	370	354	365	601
FAX EB 6412 G O	601	569	557	566	102	121	402	370	357	366	601
FAX EB 6412 H O	601	569	557	565	101	120	401	369	356	365	601
FAX EB 6417 A O	603	570	556	567	151	171	402	369	357	366	603
FAX EB 6417 C O	602	571	559	566	137	171	402	370	359	365	601
FAX EB 6422 A O	602	570	557	567	201	221	402	369	356	366	603
FAX EB 6422 B O	601	568	556	566	201	221	401	370	356	366	604
FAX EB 6422 D O	602	571	558	567	186	222	405	371	357	367	607
FAX EB 6422 S O	602	570	555	564	199	221	401	370	355	364	605
FAX EB 6428 A O	603	571	556	565	262	281	401	370	357	365	608
FAX EB 6428 B O	600	569	556	565	262	280	400	369	356	364	605
FAX EB 6428 D O	603	572	558	566	251	281	401	369	357	365	603
FAX EB 6432 A O	603	571	558	566	307	326	402	371	356	365	603
FAX EB 6432 B O	602	570	557	567	307	326	402	371	357	365	607
FAX EB 6432 D O	603	570	558	567	294	328	402	371	358	367	608
FAX EB 6432 R O	602	570	558	567	307	326	402	371	358	366	605
FAX EB 6443 B O	603	573	558	568	413	431	401	370	358	367	603
FAX EB 6443 R O	603	573	558	566	411	430	401	368	358	366	605
FAX EB 6443 V O	602	572	557	566	411	430	401	369	356	365	601
FAX EB 6443 U O	603	573	558	567	412	431	401	370	358	366	602



51 01 polipropilene grigio



51 XB polipropilene turchese



52 07 PP - ESD nero



59 00 PP - alimentare bianco



54 01 ecogreen grigio

ALTRI COLORI A RICHIESTA

EURO BOX 600x400 ACCESSORI

COPERCHIO A CERNIERA



ART.		dim. mm	minimo d'ordine	q.tà per pallet	disponibilità
FAX EB 64HG 00	51 01	600 x 400	1 pezzo	320	a magazzino
	51 XB		pallet		a magazzino
	52 07		pallet		a magazzino
	54 01		1 pezzo		a magazzino
	59 00		pallet		a magazzino

COPERCHIO CON MANIGLIE



ART.		dim. mm	minimo d'ordine	q.tà per pallet	disponibilità
FAX EB 64SE 00	51 01	600 x 400	1 pezzo	240	a magazzino
	51 XB		pallet		a magazzino
	52 07		pallet		a magazzino
	54 01		200 pezzi		a richiesta
	59 00		200 pezzi		a richiesta

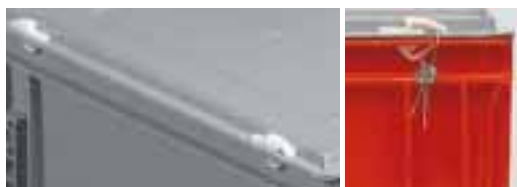

chiusura con piombino

COPPIA GANCI DI CHIUSURA

ART.	minimo d'ordine	q.tà per confezione	disponibilità
FAX EB GNO 000 81 13	confezione	10	a magazzino

Coppia ganci a scorrimento adatte per coperchi a cerniera per cassette Serie Euro Box



MOLLA PORTA BOLLA

ART.	dim. mm	minimo d'ordine	disponibilità
FAX EB MBO 000 00 99	75 x 20 x 20 h	1 pezzo	a magazzino

CASSETTE DIVISORIO

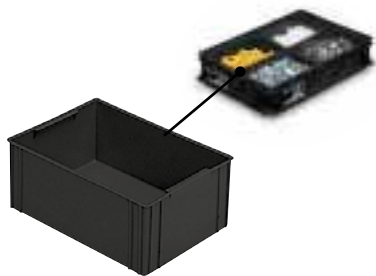

ART.		dim. mm	minimo d'ordine	q.tà per cartone	disponibilità
FAX EB 64S0 00	54 07	277 x 177 x 99 h	cartone	20	a magazzino
	52 07		cartone		a magazzino

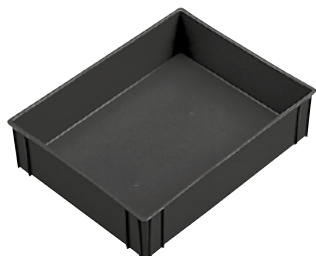

ART.		dim. mm	minimo d'ordine	q.tà per cartone	disponibilità
FAX EB 64S1 00	54 07	357 x 278 x 90 h	cartone	10	a magazzino
	52 07		cartone		a magazzino



ART.		dim. mm	minimo d'ordine	q.tà per cartone	disponibilità
FAX EB 64S2 00	54 07	357 x 278 x 90 h	cartone	10	a magazzino
	52 07		cartone		a magazzino

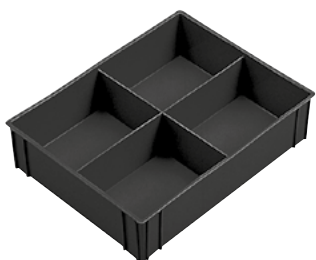

ART.		dim. mm	minimo d'ordine	q.tà per cartone	disponibilità
FAX EB 64S4 00	54 07	357 x 278 x 90 h	cartone	10	a magazzino
	52 07		cartone		a magazzino



COPERCHIO TRASPARENTE

PS

ART.		dim. mm	minimo d'ordine	q.tà per cartone	disponibilità
FAX EB LID 600 68 96		357 x 278	cartone	20	a magazzino

ESEMPI SUDDIVISIONE CASSETTE



CASSETTA SUDDIVISA CON

1 ART. FAX EB 64S 100 ____
1 ART. FAX EB 64S 200 ____



CASSETTA SUDDIVISA CON

1 ART. FAX EB 64S 100 ____
1 ART. FAX EB 64S 400 ____



CASSETTA SUDDIVISA CON

1 ART. FAX EB 64S 200 ____
1 ART. FAX EB 64S 400 ____





ART.		dim. cassetta mm	L	minimo d'ordine	q.tà per pallet	dim. pallet mm	disponibilità
FAX EB 8612 C O	51 01	800 x 600 x 120 h	49	pallet	40	1200 x 800 x 2300 h	a magazzino
	51 XB			pallet			a magazzino
	52 07			pallet			a magazzino
	54 01			200 pezzi			a richiesta
	59 00			200 pezzi			a richiesta
FAX EB 8617 C O	51 01	800 x 600 x 170 h	69	pallet	28	1200 x 800 x 2300 h	a magazzino
	51 XB			pallet			a magazzino
	52 07			pallet			a magazzino
	54 01			200 pezzi			a richiesta
	59 00			200 pezzi			a richiesta
FAX EB 8622 C O	51 01	800 x 600 x 220 h	90	pallet	20	1200 x 800 x 2200 h	a magazzino
	51 XB			pallet			a magazzino
	52 07			pallet			a magazzino
	54 01			200 pezzi			a richiesta
	59 00			200 pezzi			a richiesta
FAX EB 8632 C O	51 01	800 x 600 x 325 h	130	pallet	14	1200 x 800 x 2320 h	a magazzino
	51 XB			pallet			a magazzino
	52 07			pallet			a magazzino
	54 01			200 pezzi			a richiesta
	59 00			200 pezzi			a richiesta
FAX EB 8643 C O	51 01	800 x 600 x 430 h	175	pallet	10	1200 x 800 x 2230 h	a magazzino
	51 XB			pallet			a magazzino
	52 07			pallet			a magazzino
	54 01			200 pezzi			a richiesta
	59 00			200 pezzi			a richiesta

C

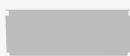

Pareti CHIUSE



Pareti CHIUSE
Maniglie CHIUSE



Fondo RINFORZATO



MARCHIATURA
PERSONALIZZATA
a richiesta



Volume in litri
per cassetta singola

MISURE TECNICHE CASSETTE

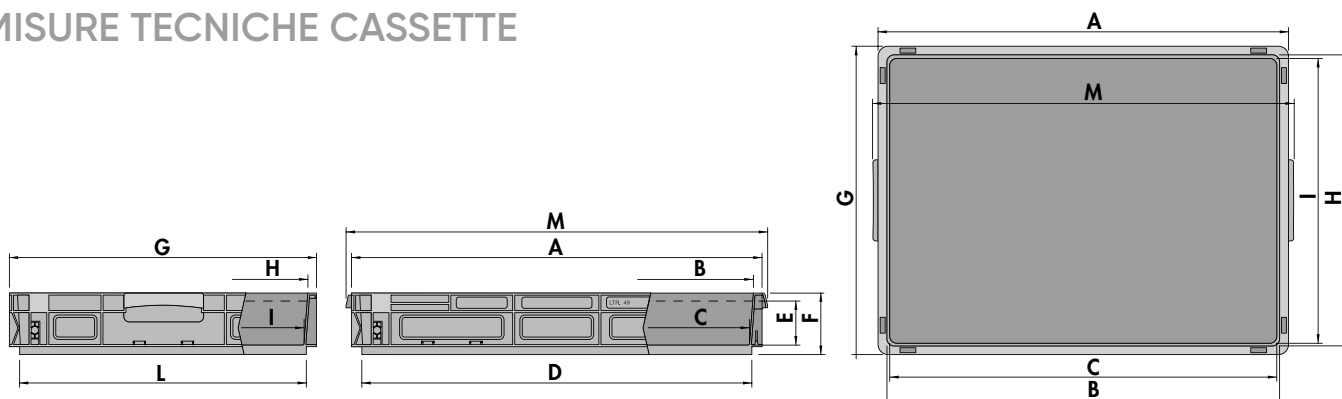

ART. CASSETTE	A	B	C	D	E	F	G	H	I	L	M
FAX EB 8612 C 0	804	770	755	764	85	121	605	568	554	563	824
FAX EB 8617 C 0	803	769	754	763	135	173	602	568	554	563	818
FAX EB 8622 C 0	805	770	755	764	186	222	603	567	554	562	820
FAX EB 8632 C 0	804	771	756	764	293	329	603	569	554	563	820
FAX EB 8643 C 0	803	770	755	763	392	429	602	568	553	562	817



EURO BOX 800x600 ACCESSORI



COPERCHIO CON MANIGLIE

ART.		dim. mm	minimo d'ordine	q.tà per pallet	disponibilità
FAX EB 86SE 00	51 01	800 x 600	pallet	60	a magazzino
	51 XB		pallet		a magazzino
	52 07		pallet		a magazzino
	54 01		200 pezzi		a richiesta
	59 00		200 pezzi		a richiesta



MOLLA PORTA BOLLA

ART.	dim. mm	disponibilità
FAX EB MB0 000 00 99	75 x 20 x 20	a magazzino

 Gamma materiali/colore

 51 01 polipropilene grigio

 51 XB polipropilene turchese

 52 07 PP - ESD nero

 59 00 PP - alimentare bianco

 54 01 ecogreen grigio

 ALTRI COLORI A RICHIESTA

**RUOTA GIREVOLE CON FRENO
IN GOMMA STANDARD**



ART.	Ø mm	C mm	
C RG DAC11 100	100	128	
C RG DAC12 125	125	155	

RUOTA FISSA IN GOMMA STANDARD



ART.	Ø mm	C mm	
C RG BAC11 100	100	128	
C RG BAC12 125	125	155	

**RUOTA GIREVOLE SENZA FRENO
IN GOMMA STANDARD**



ART.	Ø mm	C mm	
C RG CAC11 100	100	128	
C RG CAC12 125	125	155	

Set di 16 viti per il
fissaggio delle ruote
alla cassetta.



ART. FVT01380000

RUOTA GIREVOLE CON FRENO IN NYLON



ART.	Ø mm	C mm	
C RN DAD10 100	100	128	
C RN DAD11 125	125	155	

RUOTA FISSA IN NYLON



ART.	Ø mm	C mm	
C RN BAD10 100	100	128	
C RN BAD11 125	125	155	

**RUOTA GIREVOLE CON FRENO
IN GOMMA ANTISTRACCIATA SINTETICA**



ART.	Ø mm	C mm	
C RG DPH22 125	125	155	

**RUOTA FISSA IN GOMMA
ANTISTRACCIATA SINTETICA**



ART.	Ø mm	C mm	
C RG BPH22 125	125	155	

LITR. 40

EURO BOX LIGHT

Le cassette serie Euro Box Light sono state progettate e realizzate per le nuove tecniche di magazzinaggio e trasporto dei più svariati materiali. Leggere e maneggevoli, sono disponibili in polipropilene grigio o turchese, nella versione per alimenti e conduttiva. A differenza della serie Euro Box sono disponibili con fori più ampi che consentono una maggiore areazione e visibilità del prodotto.

MANIGLIE



maniglia aperta



maniglia chiusa



PARETI

pareti chiuse



pareti forate



FONDI

fondo chiuso



fondo forato

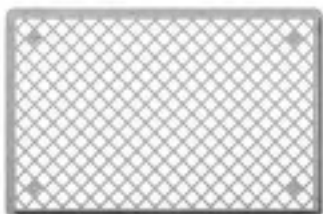

SOLUZIONI

A



Pareti CHIUSE



Pareti CHIUSE
Maniglie CHIUSE



Fondo CHIUSO

B



Pareti CHIUSE



Pareti CHIUSE
Maniglie APERTE



Fondo CHIUSO

S



Pareti FORATE



Pareti FORATE
Maniglie APERTE



Fondo FORATO

MATERIA PRIMA



51 01

polipropilene
grigio



51 XB

polipropilene
turchese



52 07

PP - ESD
nero



54 01

ecogreen
grigio



59 00

PP - alimentare
bianco

CODIFICA Euro Box Light

		configurazione pareti e fondi		materiale	colore
FAX	EL	6422	A	0	51
					01
	serie cassetta	altezza	profondità	larghezza	

EURO BOX LIGHT 600x400 mm



FORI PIÙ AMPI CHE CONSENTONO UNA MAGGIORE AREAZIONE E VISIBILITÀ DEL PRODOTTO

ART.		dim. cassetta mm	L	minimo d'ordine	q.tà per pallet	dim. pallet mm	disponibilità
FAX EL 6422 A O	51 01	600 x 400 x 220 h	40	pallet	40	1200 x 800 x 2200 h	a magazzino
	51 XB			pallet			a magazzino
	52 07			1 pezzo			a magazzino
	54 01			200 pezzi			a richiesta
	59 00			200 pezzi			a richiesta
FAX EL 6422 B O	51 01	600 x 400 x 220 h	40	pallet	40	1200 x 800 x 2200 h	a magazzino
	51 XB			pallet			a magazzino
	52 07			200 pezzi			a richiesta
	59 00			200 pezzi			a richiesta
	51 01			600 x 400 x 220 h			40
51 XB	pallet	a magazzino					
52 07	200 pezzi	a richiesta					
59 00	200 pezzi	a richiesta					
51 01	600 x 400 x 220 h	40	pallet		40	1200 x 800 x 2200 h	
51 XB			pallet	a magazzino			
52 07			200 pezzi	a richiesta			
59 00			200 pezzi	a richiesta			

A

Pareti CHIUSE

Pareti CHIUSE
Maniglie CHIUSE

Fondo CHIUSO

B

Pareti CHIUSE

Pareti CHIUSE
Maniglie APERTE

Fondo CHIUSO

S

Pareti FORATE

Pareti FORATE
Maniglie APERTE

Fondo FORATO

Volume in litri
per cassetta singola



**MARCHIATURA
PERSONALIZZATA**
a richiesta

Gamma colori/materiali

51 01 polipropilene grigio

51 XB polipropilene turchese

52 07 PP - ESD nero

59 00 PP - alimentare bianco

54 01 ecogreen grigio

**ALTRI COLORI
A RICHIESTA**

ACCESSORI

COPERCHIO A CERNIERA



ART.		dim. mm	minimo d'ordine	q.tà per pallet	disponibilità
FAX EB64 HG 00	51 01	600 x 400	1 pezzo	320	a magazzino
	51 XB		pallet		a magazzino
	52 07		pallet		a magazzino
	54 01		1 pezzo		a magazzino
	59 00		pallet		a magazzino

COPERCHIO CON MANIGLIE



ART.		dim. mm	minimo d'ordine	q.tà per pallet	disponibilità
FAX EB64 SE 00	51 01	600 x 400	1 pezzo	240	a magazzino
	51 XB		pallet		a magazzino
	52 07		pallet		a magazzino
	54 01		200 pezzi		a richiesta
	59 00		200 pezzi		a richiesta



chiusura con piombino

COPPIA GANCI DI CHIUSURA

ART.	minimo d'ordine	q.tà per confezione	disponibilità
FAX EB GNO 000 81 13	confezione	10	a magazzino

Coppia ganci a scorrimento adatte per coperchi a cerniera per cassette Serie Euro Box



MOLLA PORTA BOLLA

ART.	dim. mm	minimo d'ordine	disponibilità
FAX EB MB0 000 00 99	75 x 20 x 20 h	1 pezzo	a magazzino

MISURE TECNICHE CASSETTE

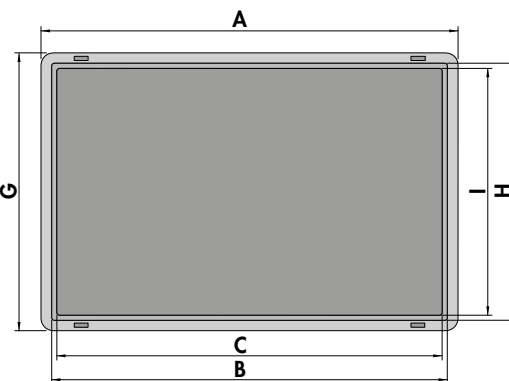
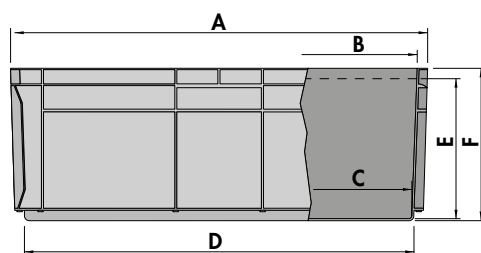
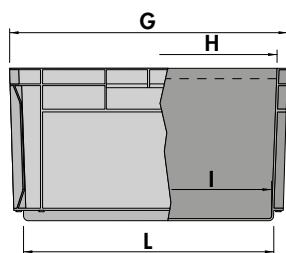

ART. CASSETTE	A	B	C	D	E	F	G	H	I	L
FAX EL 6422 A 0	601	568	554	560	200	220	401	367	355	361
FAX EL 6422 B 0	601	569	555	560	200	220	400	368	354	360
FAX EL 6422 S 0	600	568	554	559	198	220	400	367	354	360

CARRELLI

PORTA CASSETTE E CONTENITORI



ART.	kg	mm
F CP 2011 01 99	150	100 mm

Dimensioni mm 615x415x170 h

4 ruote girevoli senza freni Ø 100 mm in gomma standard

CARRELLI PER IL TRASPORTO CASSETTE
SERIE EURO BOX - EURO BOX LIGHT



ART.	kg	mm
F CP 2011 02 99	150	100 mm

Dimensioni mm 695x415x170/870 h

4 ruote girevoli senza freni Ø 100 mm in gomma standard

CARRELLI PER IL TRASPORTO CASSETTE
SERIE EURO BOX - EURO BOX LIGHT







NESTABLE BOX

Realizzate in polipropilene, le cassette serie Nestable Box presentano una struttura tronco-conica: a pieno carico sono sovrapponibili in modo stabile e sicuro, a vuoto si inseriscono l'una dentro l'altra con una riduzione del 70% del loro volume.

Per queste caratteristiche vengono utilizzate per consentire l'ideale sfruttamento degli spazi in magazzino e soprattutto nel trasporto: in particolare, nei trasporti con ritorni a vuoto o comunque dove l'imballo deve occupare il minor spazio possibile.

MANIGLIE

Le maniglie chiuse garantiscono una presa facile e sicura anche da mani guantate.



Accatamento coperchio chiuso

Inserimento coperchio aperto



Accatamento supporti aperti

Inserimento supporti chiusi

Frontale



SUPPORTI

il supporto (fig. 1) viene spinto fino a fine corsa (fig. 2) e viene bloccato con una pressione verso il basso (fig. 3).



blocco del supporto

MATERIA PRIMA

CODIFICA NESTABLE BOX



51 01

polipropilene grigio



51 XB

polipropilene turchese



59 00

PP - alimentare bianco

configurazione pareti e fondi		materiale		colore		
FAX	NB	6422	A	0	51	01
	serie cassetta	altezza	profondità	larghezza		

NESTABLE BOX

600x400 mm



ART.		dim. cassetta mm	L	minimo d'ordine	q.tà per pallet	dim. pallet mm	disponibilità
	51 01			pallet			a magazzino
FAX NB 6422 A O	51 XB	600 x 400 x 225 h	38	pallet	136	1200 x 800 x 2100 h	a magazzino
	59 00			200 pezzi			a richiesta
FAX NB 6422 C O	51 01			pallet			a magazzino
	51 XB	600 x 400 x 240 h	38	pallet	104	1200 x 800 x 2050 h	a magazzino
	59 00			200 pezzi			a richiesta
FAX NB 6422 B O	51 01			pallet			a magazzino
	51 XB	600 x 400 x 230 h	38	pallet	136	1200 x 800 x 2100 h	a magazzino
	59 00			200 pezzi			a richiesta
FAX NB 6432 A O	51 01			pallet			a magazzino
	51 XB	600 x 400 x 325 h	58	pallet	80	1200 x 800 x 2000 h	a magazzino
	59 00			200 pezzi			a richiesta
FAX NB 6432 C O	51 01			pallet			a magazzino
	51 XB	600 x 400 x 340 h	58	pallet	76	1200 x 800 x 2200 h	a magazzino
	59 00			200 pezzi			a richiesta
FAX NB 6432 B O	51 01			pallet			a magazzino
	51 XB	600 x 400 x 330 h	58	pallet	80	1200 x 800 x 2000 h	a magazzino
	59 00			200 pezzi			a richiesta
FAX NB 6442 A O	51 01			pallet			a magazzino
	51 XB	600 x 400 x 425 h	74	pallet	64	1200 x 800 x 2120 h	a magazzino
	59 00			200 pezzi			a richiesta
FAX NB 6442 C O	51 01			pallet			a magazzino
	51 XB	600 x 400 x 440 h	74	pallet	56	1200 x 800 x 2100 h	a magazzino
	59 00			200 pezzi			a richiesta
FAX NB 6442 B O	51 01			pallet			a magazzino
	51 XB	600 x 400 x 430 h	74	pallet	64	1200 x 800 x 2120 h	a magazzino
	59 00			200 pezzi			a richiesta

A



B



C





Volume in litri
per cassetta singola

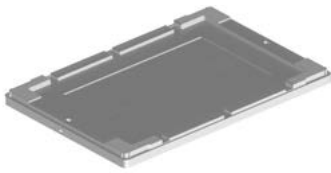

**MARCHIATURA
PERSONALIZZATA**
a richiesta

COPERCHIO



ART.		dim. mm	minimo d'ordine	q.tà per pallet	disponibilità
	51 01		pallet		a magazzino
FAX NB 64SE 00	51 XB	610 x 400	pallet	160	a magazzino
	59 00		200 pezzi		a richiesta

MISURE TECNICHE CASSETTE

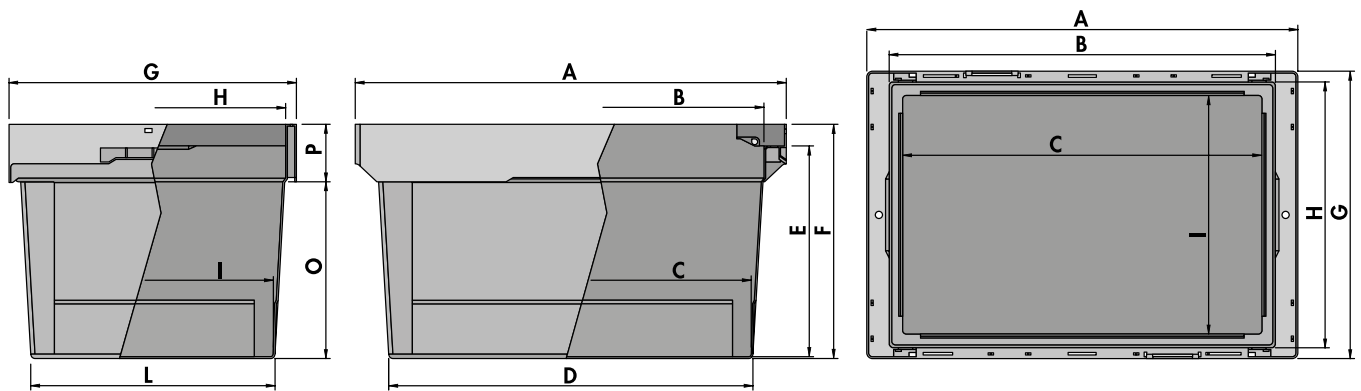

ART. CASSETTE	A	B	C	D	E	F	G	H	I	L	O	P
FAX NB 6422 A 0	601	540	501	509	292	325	401	373	330	339	245	81
FAX NB 6432 A 0	601	524	455	535	178	201	398	368	338	345	141	60
FAX NB 6442 A 0	601	540	499	508	394	426	400	372	329	338	326	100
FAX NB 6422 B 0	601	532	501	508	192	229	400	370	330	339	174	50
FAX NB 6432 B 0	601	540	501	509	292	330	401	373	330	339	245	81
FAX NB 6442 B 0	601	540	499	508	394	431	400	372	329	338	326	100
FAX NB 6422 C 0	611	532	501	508	192	239	400	370	330	339	174	50
FAX NB 6432 C 0	611	540	501	509	292	340	401	373	330	339	245	81
FAX NB 6442 C 0	611	540	499	508	394	441	400	372	329	338	326	100



NESTABLE BOX LIGHT

Realizzate in polipropilene di colore grigio, le cassette serie Nestable Box Light presentano una struttura tronco-conica: a pieno carico sono sovrapponibili in modo stabile e sicuro, a vuoto si inseriscono l'una dentro l'altra con una riduzione di $\frac{2}{3}$ del loro volume. Per queste caratteristiche vengono utilizzate per consentire l'ideale sfruttamento degli spazi in magazzino e soprattutto nel trasporto: in particolare, nei trasporti con ritorni a vuoto o comunque dove l'imballo deve occupare il minor spazio possibile.

MANIGLIE

maniglia aperta



PARETI

pareti chiuse



pareti forate



FONDI

fondo chiuso



fondo forato



ACCATAMENTO

frontale

laterale con coperchio

senza coperchio



MATERIA PRIMA

PP

51 01

polipropilene
grigio

PP

51 XB

polipropilene
turchese

PP

59 00

PP - alimentare
bianco

CODIFICA Nestable Box Light

		configurazione pareti e fondi			materiale		colore	
FAX	NL	6420	B	0	51	01		
		serie cassetta	altezza	profondità	larghezza			

NESTABLE BOX LIGHT 600x400 mm



ART.		dim. cassetta mm	L	minimo d'ordine	q.tà per pallet	dim. pallet mm	disponibilità
FAX NL 6420 B O	51 O1	600 x 400 x 200 h	32	pallet	128	1200 x 800 x 2200 h	a magazzino
	51 XB			pallet			a magazzino
	59 00			pallet			a magazzino
FAX NL 6420 S O	51 O1	600 x 400 x 200 h	32	pallet	128	1200 x 800 x 2200 h	a magazzino
	51 XB			pallet			a magazzino
	59 00			pallet			a magazzino
FAX NL 6430 B O	51 O1	600 x 400 x 300 h	50	pallet	88	1200 x 800 x 2070 h	a magazzino
	51 XB			pallet			a magazzino
	59 00			pallet			a magazzino
FAX NL 6430 S O	51 O1	600 x 400 x 300 h	50	pallet	88	1200 x 800 x 2070 h	a magazzino
	51 XB			pallet			a magazzino
	59 00			pallet			a magazzino
FAX NL 6440 B O	51 O1	600 x 400 x 400 h	70	pallet	60	1200 x 800 x 2200 h	a magazzino
	51 XB			pallet			a magazzino
	59 00			pallet			a magazzino
FAX NL 6440 S O	51 O1	600 x 400 x 400 h	70	pallet	60	1200 x 800 x 2000 h	a magazzino
	51 XB			pallet			a magazzino
	59 00			pallet			a magazzino

B



Pareti CHIUSE



Pareti CHIUSE
Maniglie APERTE



Fondo CHIUSO

S



Pareti FORATE



Pareti FORATE
Maniglie APERTE



Fondo FORATO



Volume in litri
per cassetta singola



MARCHIATURA
PERSONALIZZATA
a richiesta

ACCESSORI

COPERCHIO



ART.		dim. mm	minimo d'ordine	q.tà per pallet	disponibilità
	51 01		pallet		a magazzino
FAX NL 64SE 00	51 XB	600 x 400	pallet	160	a magazzino
	59 00		pallet		a magazzino



MOLLA PORTA BOLLA

ART.	dim. mm	disponibilità
FAXEBMB00000099	75 x 20 x 20	a magazzino



MOLLA A SCATTO PER COPERCHIO

ART.	dim. mm	disponibilità
FAXNLMSC00000099	34 x 20 x 17	a magazzino

MISURE TECNICHE CASSETTA

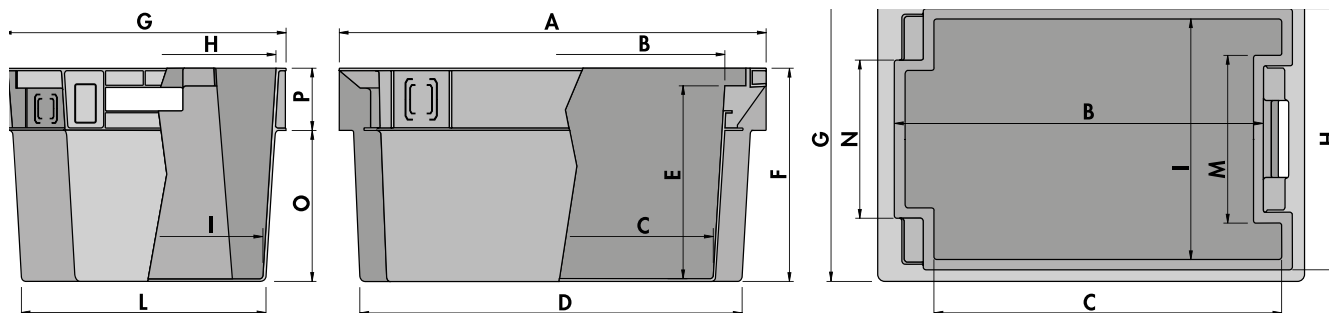

ART. CASSETTE	A	B	C	D	E	F	G	H	I	L	M	N	O	P
FAX NL 6420 B 0	601	524	455	536	178	201	399	371	338	345	220	202	141	60
FAX NL 6420 S 0	601	524	455	535	178	201	398	368	338	345	219	202	141	60
FAX NL 6430 B 0	602	527	453	537	272	301	398	370	338	346	220	202	214	86
FAX NL 6430 S 0	601	525	455	536	273	300	398	370	336	345	220	202	214	86
FAX NL 6440 B 0	602	526	453	535	372	401	398	367	336	345	218	203	284	117
FAX NL 6440 S 0	601	526	454	535	374	401	399	370	337	344	220	202	285	117



PICKING BOX

I contenitori in polipropilene serie Picking Box, sono la soluzione ideale ad ogni problema di stoccaggio, in magazzino, in officina, lungo le linee di montaggio. Consentono di avere sempre a portata di mano e ben in vista il contenuto, rendendolo prelevabile con estrema facilità. Questi contenitori sono impilabili in modo stabile e sicuro e la pronta disponibilità del materiale non viene meno anche quando sono sovrapposti.

FONDI

fondo liscio



A

fondo nervato



B

fondo nervato a 45°
con traversino



E

TRAVERSINO

I contenitori più voluminosi sono dotati di traversino fissato anteriormente al contenitore, con la funzione di evitare qualsiasi deformazione delle pareti laterali in caso di grande carico e di facilitarne la presa.



RINFORZO LATERALE

Un rinforzo laterale sul fondo permette di accatastare i contenitori con la massima sicurezza anche a pieno carico.



MANIGLIE



Il sollevamento e il trasporto sono resi possibili da comode maniglie che consentono una rapida presa anche con guanti.

CODIFICA Picking Box

		configurazione fondo			materiale	colore
FAX	PB	C3A2	B	0	51	01
serie contenitore		misura contenitore				

MATERIA PRIMA

PP

51 01

polipropilene
grigio

PP

51 02

polipropilene
verde

PP

51 03

polipropilene
rosso

PP

51 04

polipropilene
blu

PP

51 05

polipropilene
giallo



54 01

ecogreen
grigio



52 07

PP - ESD
nero

PICKING BOX



rif.	ART.	dim. cassetta mm	L	mis.	minimo d'ordine	q.tà per cartone	q.tà per pallet	dim. pallet mm	disponibilità	
①	FAX PB Z001 A 0	72/60 x 45 x 32 h	0,08	01	51 01	cartone	100	-	-	a magazzino
	51 02				cartone	a magazzino				
	51 03				cartone	a magazzino				
	51 04				cartone	a magazzino				
	51 05				cartone	a magazzino				
②	FAX PB Z000 A 0	85/65 x 95 x 45 h	0,25	0	51 01	cartone	98	-	-	a magazzino
	51 02				cartone	a magazzino				
	51 03				cartone	a magazzino				
	51 04				cartone	a magazzino				
	51 05				cartone	a magazzino				
	52 07				cartone	a magazzino				
③	FAX PB C001 A 0	160/140 x 95 x 75 h	1	1	51 01	cartone	50	1750	1300 x 1100 x 2000 h	a magazzino
	51 02				cartone	a magazzino				
	51 03				cartone	a magazzino				
	51 04				cartone	a magazzino				
	51 05				cartone	a magazzino				
	54 01				cartone	a magazzino				
	52 07				cartone	a magazzino				
④	FAX PB C002 A 0	230/200 x 140 x 130 h	3,8	2	51 01	cartone	54	1080	1450 x 1200 x 2100 h	a magazzino
	51 02				cartone	a magazzino				
	51 03				cartone	a magazzino				
	51 04				cartone	a magazzino				
	51 05				cartone	a magazzino				
	54 01				cartone	a magazzino				
	52 07				cartone	a magazzino				



rif.	ART.	dim. cassetta mm	L	mis.	minimo d'ordine	q.tà per cartone	q.tà per pallet	dim. pallet mm	disponibilità	
⑤	FAX PB C3A2 B 0	51 01	350/300 x 200 x 145 h	9,4	3A2	cartone	21	252	1400 x 1100 x 2000 h	a magazzino
		51 02								a magazzino
		51 03								a magazzino
		51 04								a magazzino
		51 05								a magazzino
		54 01								a magazzino
		52 07								a magazzino
⑥	FAX PB C003 B 0	51 01	350/300 x 200 x 200 h	12,5	3	cartone	15	180	1300 x 1000 x 2000 h	a magazzino
		51 02								a magazzino
		51 03								a magazzino
		51 04								a magazzino
		51 05								a magazzino
		54 01								a magazzino
		52 07								a magazzino
⑦	FAX PB Z3L5 B 0	51 01	350/300 x 450 x 145 h	19	3L5	cartone	14	112	1450 x 1000 x 2100 h	a magazzino
		51 02								a magazzino
		51 03								a magazzino
		51 04								a magazzino
		51 05								a magazzino
⑧	FAX PB C4A2 B 0	51 01	500/450 x 300 x 145 h	20	4A2	cartone	14	112	1300 x 1000 x 2000 h	a magazzino
		51 02								a magazzino
		51 03								a magazzino
		51 04								a magazzino
		51 05								a magazzino

fondo liscio



A

fondo nervato



B



Volume in litri per cassetta singola



MARCHIATURA PERSONALIZZATA a richiesta





52 07

PP - ESD nero



ALTRI COLORI A RICHIESTA

PICKING BOX

Rif.	ART.	 dim. cassetta mm	 L	mis.	minimo d'ordine	q.tà per cartone	q.tà per pallet	dim. pallet mm	disponibilità	
9	FAX PB C004 B 0	51 01	500/450 x 300 x 200 h	28	4	cartone	10	80	1300 x 1000 x 2000 h	a magazzino
		51 02				cartone				a magazzino
		51 03				cartone				a magazzino
		51 04				cartone				a magazzino
		51 05				cartone				a magazzino
		54 01				cartone				a magazzino
		52 07				cartone				a magazzino
10	FAX PB C4A5 B 0	51 01	500/450 x 300 x 300 h	42	4A5	cartone	6	48	1300 x 1000 x 1850 h	a magazzino
		51 02				cartone				a magazzino
		51 03				cartone				a magazzino
		51 04				cartone				a magazzino
		51 05				cartone				a magazzino
11	FAX PB Z5P4 E 0	51 01	520/450 x 450 x 300 h	63	5P4	1 pezzo	-	42	1400 x 1100 x 2100 h	a magazzino
		51 02				1 pezzo				a magazzino
		51 03				1 pezzo				a magazzino
		51 04				1 pezzo				a magazzino
		51 05				1 pezzo				a magazzino
12	FAX PB Z005 E 0	51 01	700/630 x 450 x 300 h	88	5	1 pezzo	-	28	1450 x 1000 x 2100 h	a magazzino
		51 02				1 pezzo				a magazzino
		51 03				1 pezzo				a magazzino
		51 04				1 pezzo				a magazzino
		51 05				1 pezzo				a magazzino



A

fondo liscio



B

fondo nervato



E

fondo nervato a 45° con traversino



Volume in litri per cassetta singola



MARCHIATURA PERSONALIZZATA a richiesta

 Gamma colori/materiali

PP

51 01 Polipropilene grigio

PP

51 02 polipropilene verde

PP

51 03 polipropilene rosso

PP

51 04 polipropilene blu

PP

51 05 polipropilene giallo



54 01 ecogreen grigio

PICKING BOX ACCESSORI



DIVISORIO LONGITUDINALE ZINCATO

ART.	dim. mm	per art.	disponibilità
FPBDC0030000099	307 x 160 h	FAX PB C003 B0	a magazzino
FPBDC3A20000099	302 x 105 h	FAX PB C3A2 B0	a magazzino
FPBDC3L50000099	326 x 115 h	FAX PB C3L5 B0	a magazzino
FPBDC4A20000099	457 x 120 h	FAX PB C4A2 B0	a magazzino
FPBDC0040000099	462 x 160 h	FAX PB C004 B0	a magazzino
FPBDC4A50000099	460 x 249 h	FAX PB C4A5 B0	a magazzino

ZINCATO



DIVISORIO TRASVERSALE ZINCATO

ART.	per art.	disponibilità
FPBDC0040000199	FAX PB C004 B0	a magazzino

ZINCATO



DIVISORIO LONGITUDINALE CON COPPIA SUPPORTI IN METALLO

ART.	dim. mm	per art.	disponibilità
FPBDZ5P40000299	473 x 215 H	FAX PB Z5P4 E0	a magazzino
FPBDZ0050000299	654 x 214 H	FAX PB Z005 E0	a magazzino

ZINCATO

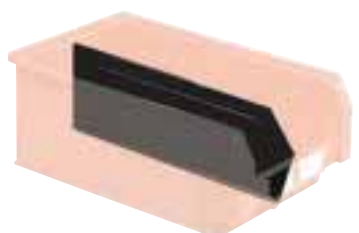

DIVISORIO LONGITUDINALE AGGIUNTIVO

ART.	dim. mm	per art.	disponibilità
FPBDZ5P40000099	473 x 215 H	FAX PB Z5P4 E0	a magazzino
FPBDZ0050000099	654 x 214 H	FAX PB Z005 E0	a magazzino

ZINCATO

DIVISORIO LONGITUDINALE IN PLASTICA

PS

ART.	dim. mm	per art.	minimo d'ordine	q.tà per confezione	disponibilità
FAX PB DC3A 2071 07	300 x 105 h	FAX PB C3A2 B0	confezione	10	a magazzino
FAX PB DC00 3071 07	305 x 160 h	FAX PB C003 B0	confezione	10	a magazzino
FAX PB DZ3L 5071 07	325 x 105 h	FAX PB Z3L5 B0	confezione	10	a magazzino
FAX PB DC00 4071 07	460 x 160 h	FAX PB C004 B0	confezione	10	a magazzino
FAX PB DC4A 5071 07	460 x 250 h	FAX PB C4A5 B0	confezione	10	a magazzino



52 07

PP - ESD
nero



ALTRI COLORI
A RICHIESTA



Realizzata in polistirolo trasparente, la mascherina permette di identificare facilmente il prodotto che, allo stesso tempo, è protetto dalla polvere. Può essere aperta a cerniera sul fronte del contenitore e, da chiusa, aumenta la capacità di carico.

MASCHERINA PARAPOLVERE

PS

ART.	per art.	minimo d'ordine	q.tà per confezione	disponibilità
FAX PB MC 0030 68 96	FAX PB C003 B0	confezione	10	a magazzino
FAX PB MC 3A20 68 96	FAX PB C3A2 B0	confezione	10	a magazzino
FAX PB MC 0040 68 96	FAX PB C004 B0	confezione	10	a magazzino
FAX PB MC 4A50 68 96	FAX PB C4A5 B0	confezione	10	a magazzino



finitura zincata

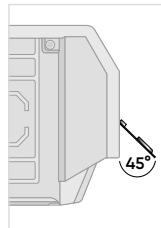

PORTA CARTELLINO INCLINATO

ART.	dim. mm	per art.	disponibilità
FPBHC0000000099	100 x 67	FAX PB C3A2 B0	a magazzino
		FAX PB C003 B0	a magazzino
		FAX PB C004 B0	a magazzino
		FAX PB C4A5 B0	a magazzino
FPBHZ0000000099	128 x 90	FAX PB Z5P4 E0	a magazzino
		FAX PB Z005 E0	a magazzino



MISURE TECNICHE CONTENITORE

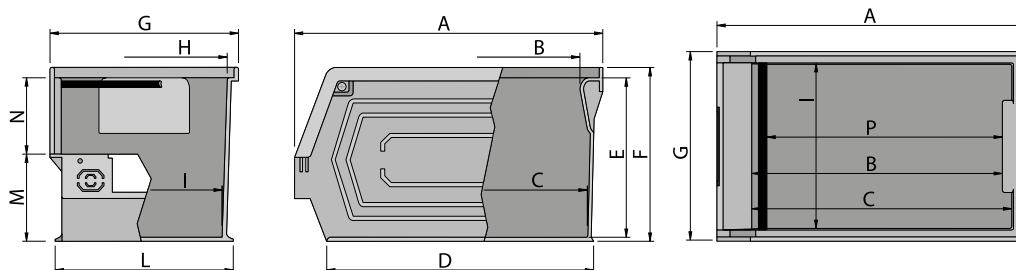

ART. CASSETTE	A	B	C	D	E	F	G	H	I	L	M	N	O
FAX PB Z001 A O	77	55	55	59	32	37	50	40	39	47	18	15	-
FAX PB Z000 A O	93	63	63	67	44	52	103	92	90	99	27	21	-
FAX PB Z3L5 B O	352	295	295	307	131	146	469	439	432	455	75	60	-
FAX PB Z5P4 E O	535	412	433	452	277	300	472	436	430	459	151	132	362
FAX PB Z005 E O	720	598	618	636	276	300	471	434	428	459	150	131	545

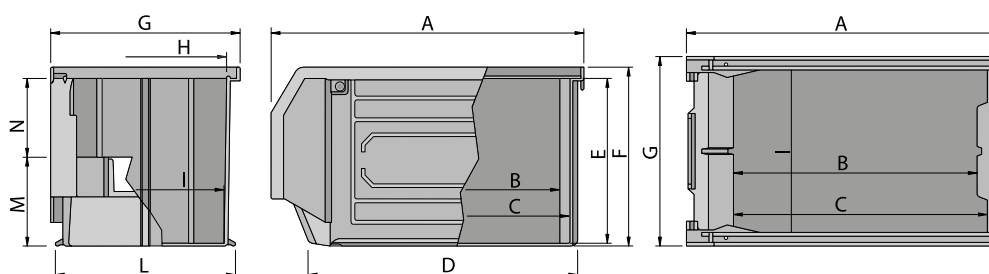

ART. CASSETTE	A	B	C	D	E	F	G	H	I	L	M	N
FAX PB C001 A O	169	134	134	136	66	75	102	88	87	96	35	34
FAX PB C002 A O	235	193	193	202	111	122	149	128	125	141	61	52
FAX PB C3A2 B O	342	272	285	296	130	142	209	185	182	201	71	61
FAX PB C003 B O	347	269	279	291	186	200	209	181	178	200	99	90
FAX PB C4A2 B O	501	427	440	450	129	143	311	284	279	300	75	60
FAX PB C004 B O	500	425	436	443	185	200	312	285	281	303	100	88
FAX PB C4A5 B O	501	423	433	445	286	301	313	284	279	302	150	141



STORAGE BOX

Le cassette in polipropilene serie Storage Box rispondono alle più specifiche esigenze di contenimento, movimentazione e stoccaggio delle merci. Maneggevoli, leggere e facili da pulire grazie all'interno perfettamente liscio, sono dotate di un robusto bordo che consente la sovrapposizione in modo stabile e sicuro. La sovrapposibilità, unita all'elevata capacità di contenimento, consente l'ideale sfruttamento dello spazio.

RINFORZO LATERALE

Un rinforzo laterale sul fondo permette di accatastare le cassette con la massima sicurezza anche a pieno carico.



FONDI

fondo liscio

A



fondo nervato

B



fondo nervato a 45°

C



MANIGLIE - PARETI



maniglia chiusa

pareti chiuse

CODIFICA Storage Box



MATERIA PRIMA

PP

51 01

polipropilene grigio

PP

51 02

polipropilene verde

PP

51 03

polipropilene rosso

PP

51 04

polipropilene blu

PP

51 05

polipropilene giallo

54 01



ecogreen grigio







52 07

PP - ESD nero

STORAGE BOX



rif.	ART.	 dim. cassetta mm	 L	mis.	minimo d'ordine	q.tà per cartone	q.tà per pallet	dim. pallet mm	disponibilità	
①	FAX SB Z701 A O	51 01	145 x 90 x 70 h	0,9	701	cartone	50	1600	-	a magazzino
		51 02				cartone				a magazzino
		51 03				cartone				a magazzino
		51 04				cartone				a magazzino
		51 05				cartone				a magazzino
		52 07				pallet				a magazzino
②	FAX SB Z702 A O	51 01	145 x 140 x 70 h	1,4	702	cartone	30	960	-	a magazzino
		51 02				cartone				a magazzino
		51 03				cartone				a magazzino
		51 04				cartone				a magazzino
		51 05				cartone				a magazzino
		52 07				pallet				a magazzino
③	FAX SB Z002 B O	51 01	200 x 140 x 130 h	3,6	272-2	cartone	54	1080	1400 x 1100 x 1660 h	a magazzino
		51 02				cartone				a magazzino
		51 03				cartone				a magazzino
		51 04				cartone				a magazzino
		51 05				cartone				a magazzino
		52 07				pallet				a magazzino
④	FAX SB Z3A2 B O	51 01	300 x 200 x 145 h	8,7	272-3A2	cartone	21	252	1350 x 1100 x 2000 h	a magazzino
		51 02				cartone				a magazzino
		51 03				cartone				a magazzino
		51 04				cartone				a magazzino
		51 05				cartone				a magazzino
		52 07				pallet				a magazzino

 Gamma colori/materiali
  51 01 polipropilene grigio
 51 02 polipropilene verde
 51 03 polipropilene rosso
 51 04 polipropilene blu
 51 05 polipropilene giallo
 54 01 ecogreen grigio

rif.	ART.	dim. cassetta mm	L	mis.	minimo d'ordine	q.tà per cartone	q.tà per pallet	dim. pallet mm	disponibilità	
5	FAX SB Z4A2 B 0	51 01	450 x 300 x 120 h	16,2	272-4A2	cartone	16	128	1300 x 1100 x 1900 h	a magazzino
		51 02				cartone				a magazzino
		51 03				cartone				a magazzino
		51 04				cartone				a magazzino
		51 05				cartone				a magazzino
		52 07				pallet				a magazzino
6	FAX SB Z004 B 0	51 01	450 x 300 x 200 h	27	272-4	cartone	10	80	1300 x 1100 x 2000 h	a magazzino
		51 02				cartone				a magazzino
		51 03				cartone				a magazzino
		51 04				cartone				a magazzino
		51 05				cartone				a magazzino
		52 07				pallet				a magazzino
7	FAX SB Z4A5 C 0	51 01	450 x 300 x 300 h	40,5	272-4A5	cartone	6	48	1300 x 1100 x 2160 h	a magazzino
		51 02				cartone				a magazzino
		51 03				cartone				a magazzino
		51 04				cartone				a magazzino
		51 05				cartone				a magazzino
8	FAX SB Z005 C 0	51 01	630 x 450 x 300 h	85	272-5	1 pezzo	-	28	1300 x 1000 x 2110 h	a magazzino
		51 02				1 pezzo				a magazzino
		51 03				1 pezzo				a magazzino
		51 04				1 pezzo				a magazzino
		51 05				1 pezzo				a magazzino

fondo liscio



A

fondo nervato



B

fondo nervato a 45°



C



Volume in litri per cassetta singola



MARCHIATURA PERSONALIZZATA a richiesta



52 07

PP - ESD
nero



ALTRI COLORI A RICHIESTA

STORAGE BOX





MISURE TECNICHE CASSETTA

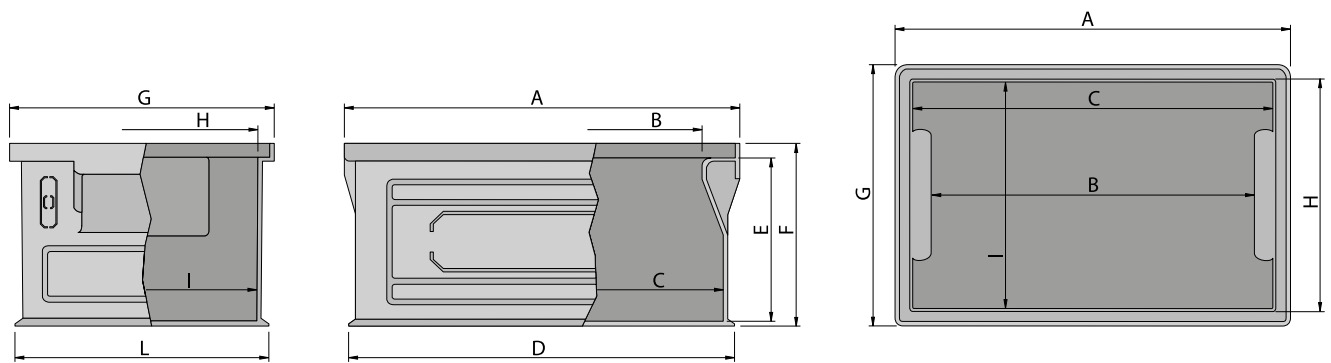

ART. CASSETTE	A	B	C	D	E	F	G	H	I	L
FAX SB Z701 A 0	144	127	123	137	63	70	91	84	81	84
FAX SB Z702 A 0	144	126	124	137	63	70	139	132	126	132
FAX SB Z002 B 0	211	178	187	202	110	123	148	129	125	140
FAX SB Z3A2 B 0	311	255	284	303	130	144	209	184	182	201
FAX SB Z4A2 B 0	463	427	423	453	105	120	313	277	275	304
FAX SB Z004 B 0	464	403	425	452	181	197	312	288	277	301
FAX SB Z4A5 C 0	466	407	426	453	285	301	314	281	276	302
FAX SB Z005 C 0	655	570	604	638	276	299	471	435	429	458



RK BOX

Tutto in ordine e ben in vista per un magazzino flessibile e funzionale: questo è il risultato ottenuto dallo studio e dalla realizzazione delle cassette in polipropilene serie RK Box e degli appositi scaffali per il loro contenimento. Disponibili in dieci diverse misure per rispondere ad ogni esigenza, le cassette sono particolarmente indicate per i ricambisti, sia per la loro resistenza agli olii che per la loro divisibilità interna.

PARETI

Realizzate in polipropilene di prima scelta, le cassette serie RK Box hanno le pareti rinforzate da apposite nervature per resistere agli urti.



FONDI

Fondo liscio



MANIGLIE

Un'apposita maniglia, fornita su richiesta, facilita il sollevamento e il trasporto delle cassette serie RK Box.



MARCHIATURA



a richiesta

ETICHETTE

Dotati di porta etichette, le relative etichette sono disponibili in diverse misure proporzionate alle dimensioni delle cassette alle quali vengono applicate.



DIVISORI

Realizzati in polistirolo trasparente, i divisori consentono la suddivisione interna delle cassette in più scomparti.



MATERIA PRIMA



51 04

polipropilene
blu



52 07

PP - ESD
nero

CODIFICA RK Box



RK BOX



rif.	ART.		dim. cassetta mm	L	divisori inseribili	minimo d'ordine	q.tà per cartone	q.tà per pallet	dim. pallet mm	disponibilità
①	FAX RB 3012 00	51 04	300 x 120 x 100 h	2	4	cartone	32	512	1300 x 1000 x 1700 h	a magazzino
		52 07				cartone				a magazzino
②	FAX RB 4012 00	51 04	400 x 120 x 100 h	3	6	cartone	32	384	1300 x 1000 x 1700 h	a magazzino
		52 07				cartone				a magazzino
③	FAX RB 5012 00	51 04	500 x 120 x 100 h	4	8	cartone	32	256	1300 x 1000 x 1700 h	a magazzino
		52 07				cartone				a magazzino
④	FAX RB 3016 00	51 04	300 x 160 x 100 h	3	4	cartone	24	284	1300 x 1000 x 1700 h	a magazzino
		52 07				cartone				a magazzino
⑤	FAX RB 4016 00	51 04	400 x 160 x 100 h	5	6	cartone	24	288	1300 x 1000 x 1700 h	a magazzino
		52 07				cartone				a magazzino
⑥	FAX RB 5016 00	51 04	500 x 160 x 100 h	5,5	8	cartone	24	192	1300 x 1000 x 1700 h	a magazzino
		52 07				cartone				a magazzino
⑦	FAX RB 6016 00	51 04	600 x 160 x 100 h	7	10	cartone	24	192	1300 x 1000 x 1700 h	a magazzino
		52 07				cartone				a magazzino
⑧	FAX RB 4024 00	51 04	400 x 240 x 100 h	7	6	cartone	16	192	1300 x 1000 x 1700 h	a magazzino
		52 07				cartone				a magazzino
⑨	FAX RB 5024 00	51 04	500 x 240 x 100 h	9	8	cartone	16	128	1300 x 1000 x 1700 h	a magazzino
		52 07				cartone				a magazzino



⑩



⑪

rif.	ART.		dim. cassetta mm		divisori inseribili	minimo d'ordine	q.tà per cartone	q.tà per pallet	disponibilità
⑩	FAX RB 6516 00	52 07	650 x 160 x 100 h	7,5	11	cartone	24	192	a magazzino
⑪	FAX RB 4314 00	51 04	435 x 140 x 80 h	3,5	7	cartone	30	540	a magazzino

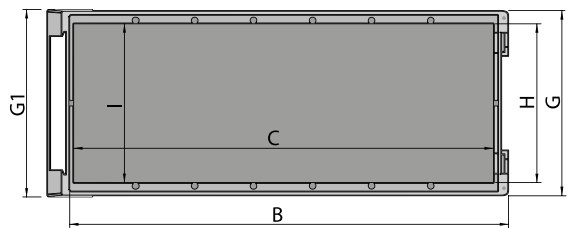
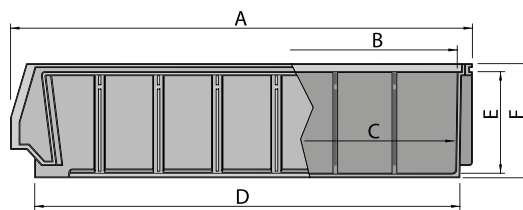
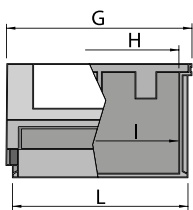

ART. CASSETTE	A	B	C	D	E	F	G	G1	H	I	L
FAX RB 3012 00	299	262	257	265	89	100	121	121	98	95	112
FAX RB 4012 00	401	365	357	367	89	100	121	121	98	96	111
FAX RB 5012 00	503	466	461	468	89	100	120	120	97	95	112
FAX RB 3016 00	299	263	260	267	89	100	160	162	138	136	151
FAX RB 4016 00	399	363	358	367	89	100	160	162	138	136	150
FAX RB 5016 00	499	464	460	467	89	100	159	162	139	136	150
FAX RB 6016 00	601	565	560	569	89	100	160	162	138	136	151
FAX RB 4024 00	401	363	358	367	89	100	240	242	216	215	232
FAX RB 5024 00	504	466	461	469	89	100	241	243	217	215	231
FAX RB 6516 00	655	618	613	621	88	101	161	163	138	136	151
FAX RB 4314 00	434	421	403	420	70	79	139	139	122	121	127

RK BOX



Le cassette RK BOX trovano collocazione ideale negli appositi scaffali: realizzati in lamiera di acciaio, sono stati progettati secondo criteri di componibilità per rispondere alle molteplici esigenze operative. Nella parte superiore lo scaffale presenta due alette di posizionamento per agevolare la sovrapposizione dello scaffale, mentre nella parte inferiore è possibile inserire lo zoccolo. Si possono sovrapporre scaffali della stessa profondità e di profondità decrescente. I piani sono fissi e presentano delle fessure per l'inserimento delle guide utili allo scorrimento delle cassette.

FERMO ANTERIORE



Gli scaffali possono essere montati su furgoni. In questo caso è consigliabile l'uso di appositi fermi in acciaio zincato che impediscono la fuoriuscita delle cassette.

FERMO POSTERIORE



Fermo in acciaio zincato che impedisce la fuoriuscita della cassetta dagli scaffali quando viene estratta.



SOVRAPPOSIZIONE SCAFFALI



INSERIMENTO ZOCCOLO

Per gentile concessione di Fral srl





ART.	Dim. mm
FRBBX3000000001	500x300x545 H

01
RAL 7000



ART.	Dim. mm
FRBBX3016000001	500x300x545 H

COMPLETO DI 16 PZ. ART. FAX RB 3012 00 51 04

01
RAL 7000



ART.	Dim. mm
FRBBX3012000001	500x300x545 H

COMPLETO DI 12 PZ. ART. FAX RB 3016 00 51 04

01
RAL 7000



ART.	Dim. mm
FRBBX3014000001	500x300x545 H

COMPLETO DI 8 PZ. ART. FAX RB 3012 00 51 04
6 PZ. ART. FAX RB 3016 00 51 04

01
RAL 7000





ART.	Dim. mm
FRBBX4000000001	500x400x545 H

01
RAL 7000



ART.	Dim. mm
FRBBX4016000001	500x400x545 H

COMPLETO DI 16 PZ. ART. FAX RB 4012 00 51 04

01
RAL 7000



ART.	Dim. mm
FRBBX4012000001	500x400x545 H

COMPLETO DI 12 PZ. ART. FAX RB 4016 00 51 04

01
RAL 7000



ART.	Dim. mm
FRBBX4014000001	500x400x545 H

COMPLETO DI 8 PZ. ART. FAX RB 4012 00 51 04

6 PZ. ART. FAX RB 4016 00 51 04

01
RAL 7000



ART.	Dim. mm
FRBBX4008000001	500x400x545 H

COMPLETO DI 8 PZ. ART. FAX RB 4024 00 51 04

01
RAL 7000



ART.	Dim. mm
FRBBX4012000101	500x400x545 H

COMPLETO DI 8 PZ. ART. FAX RB 4012 00 51 04

4 PZ. ART. FAX RB 4024 00 51 04

01
RAL 7000



ART.	Dim. mm
FRBBX4010000001	500x400x545 H

COMPLETO DI 6 PZ. ART. FAX RB 4016 00 51 04

4 PZ. ART. FAX RB 4024 00 51 04

01
RAL 7000



ART.	Dim. mm
FRBBX4012000201	500x400x545 H

COMPLETO DI 4 PZ. ART. FAX RB 4012 00 51 04

6 PZ. ART. FAX RB 4016 00 51 04

2 PZ. ART. FAX RB 4024 00 51 04

01
RAL 7000





ART.	Dim. mm
FRBBX5000000001	500x500x545 H

01
RAL 7000



ART.	Dim. mm
FRBBX5016000001	500x500x545 H

COMPLETO DI 16 PZ. ART. FAX RB 5012 00 51 04

01
RAL 7000



ART.	Dim. mm
FRBBX5012000001	500x500x545 H

COMPLETO DI 12 PZ. ART. FAX RB 5016 00 51 04

01
RAL 7000



ART.	Dim. mm
FRBBX5014000001	500x500x545 H

COMPLETO DI 8 PZ. ART. FAX RB 5012 00 51 04

6 PZ. ART. FAX RB 5016 00 51 04

01
RAL 7000



ART.	Dim. mm
FRBBX5008000001	500x500x545 H

COMPLETO DI 8 PZ. ART. FAX RB 5024 00 51 04

01
RAL 7000



ART.	Dim. mm
FRBBX5012000101	500x500x545 H

COMPLETO DI 8 PZ. ART. FAX RB 5012 00 51 04

4 PZ. ART. FAX RB 5024 00 51 04

01
RAL 7000



ART.	Dim. mm
FRBBX5010000001	500x500x545 H

COMPLETO DI 6 PZ. ART. FAX RB 5016 00 51 04

4 PZ. ART. FAX RB 5024 00 51 04

01
RAL 7000



ART.	Dim. mm
FRBBX5012000201	500x500x545 H

COMPLETO DI 4 PZ. ART. FAX RB 5012 00 51 04

6 PZ. ART. FAX RB 5016 00 51 04
2 PZ. ART. FAX RB 5024 00 51 04

01
RAL 7000



ART.	Dim. mm
FRBBX6000000001	500x600x545 H

01
RAL 7000



ART.	Dim. mm
FRBBX6012000001	500x600x545 H

COMPLETO DI 12 PZ. ART. FAX RB 6016 00 51 04

01
RAL 7000



RK BOX ACCESSORI



ZOCCOLI

ART.	dim. mm	per scaffale ART.	disponibilità
FR BB X3Z0 000 00 01	485 x 275 x 90 h	FR BB X300 000 00 01	a magazzino
FR BB X4Z0 000 00 01	485 x 375 x 90 h	FR BB X400 000 00 01	a magazzino
FR BB X5Z0 000 00 01	485 x 475 x 90 h	FR BB X500 000 00 01	a magazzino
FR BB X6Z0 000 00 01	485 x 575 x 90 h	FR BB X600 000 00 01	a magazzino

01
RAL 7000

FERMO ZINCATO PER SCAFFALI

ART.	dim. mm	per scaffale ART.	disponibilità
FRBS50000000099	509 x 140	FR BB X300 000 00 01	a magazzino
		FR BB X400 000 00 01	a magazzino
		FR BB X500 000 00 01	a magazzino
		FR BB X600 000 00 01	a magazzino

GUIDE PER SCAFFALI

ART.	per scaffale ART.	disponibilità
F ST 9830 00 99	FR BB X300 000 00 01	a magazzino
F ST 9840 00 99	FR BB X400 000 00 01	a magazzino
F ST 9850 00 99	FR BB X500 000 00 01	a magazzino
F ST 9860 00 99	FR BB X600 000 00 01	a magazzino



MANIGLIE

ART.	dim. mm	per cassette ART.	disponibilità
FAX RBH12 000	70 x 90 h	FAX RB 3012 00	a magazzino
		FAX RB 4012 00	a magazzino
		FAX RB 5012 00	a magazzino
FAX RBH16 000	120 x 80 h	FAX RB 3016 00	a magazzino
		FAX RB 4016 00	a magazzino
		FAX RB 5016 00	a magazzino
FAX RBH24 000	110 x 90 h	FAX RB 6016 00	a magazzino
		FAX RB 4024 00	a magazzino
		FAX RB 5024 00	a magazzino



FERMO ZINCATO PER CASSETTE

ART.	Ø mm	per cassette ART.	disponibilità
FRBS12000000099	3 Ø	FAX RB 3012 00	a magazzino
		FAX RB 4012 00	a magazzino
		FAX RB 5012 00	a magazzino
		FAX RB 3016 00	a magazzino
FRBS16000000099	3 Ø	FAX RB 4016 00	a magazzino
		FAX RB 5016 00	a magazzino
		FAX RB 6016 00	a magazzino
		FAX RB 4024 00	a magazzino
		FAX RB 5024 00	a magazzino



DIVISORI LONGITUDINALI ZINCATI



ART.	dim. mm	per cassette ART.	disponibilità
FRBD30000000099	268 x 88 h	FAX RB 3012 00	a magazzino
		FAX RB 3016 00	a magazzino
FRBD40000000099	368 x 88 h	FAX RB 4012 00	a magazzino
		FAX RB 4016 00	a magazzino
		FAX RB 4024 00	a magazzino
		FAX RB 5012 00	a magazzino
FRBD50000000099	468 x 88 h	FAX RB 5016 00	a magazzino
		FAX RB 5024 00	a magazzino
FRBD60000000099	568 x 88 h	FAX RB 6016 00	a magazzino

DIVISORI TRASVERSALI



ART.	dim. mm	per scaffale ART.	disponibilità
FAX RBD12 000	100 x 90 h	FAX RB 3012 00	a magazzino
		FAX RB 4012 00	a magazzino
		FAX RB 5012 00	a magazzino
FAX RBD14 000	137 x 75 h	FAX RB 4314 00	a magazzino
FAX RBD16 000	145 x 90 h	FAX RB 3016 00	a magazzino
		FAX RB 4016 00	a magazzino
		FAX RB 5016 00	a magazzino
		FAX RB 6016 00	a magazzino
FAX RBD24 000	225 x 90 h	FAX RB 4024 00	a magazzino
		FAX RB 5024 00	a magazzino



ETICHETTE PER DIVISORI TRASVERSALI

ART.	dim. etichetta mm	nr. etichette per foglio	per divisorio ART.	disponibilità
FAX RBE T240 000 00	80 x 24	24	FAX RB D120 00	a magazzino
FAX RBE T160 000 00	121 x 24	16	FAX RB D160 00	a magazzino
			FAX RB D240 00	a magazzino



ETICHETTE PER CASSETTE

ART.	dim. etichetta mm	nr. etichette per foglio	per cassette ART.	disponibilità
FAX RB ET120 000 00	79 x 44	12	FAX RB 3012 00	a magazzino
			FAX RB 4012 00	a magazzino
			FAX RB 5012 00	a magazzino
FAX RB ET080 000 00	121 x 44	8	FAX RB 3016 00	a magazzino
			FAX RB 4016 00	a magazzino
			FAX RB 5016 00	a magazzino
			FAX RB 6016 00	a magazzino
FAX RB ET060 000 00	200 x 43	6	FAX RB 4314 00	a magazzino
			FAX RB 4024 00	a magazzino
			FAX RB 5024 00	a magazzino

A grid of clear plastic drawers on a grey frame. The drawers are arranged in a 4x4 grid, with the bottom row partially obscured by text. The drawers are empty and have a slightly reflective surface.

VISUAL BOX

Le cassettiere serie Visual Box sono composte da una struttura in ABS di colore grigio e da cassetti in polistirolo trasparente ad alta resistenza meccanica.

Disponibili in modelli diversi, per profondità ed altezza, hanno in comune la larghezza di 600 mm che permette di sovrapporli consentendo le più svariate combinazioni.

CASSETTI



I cassetti, realizzati in polistirolo trasparente ad alta resistenza meccanica, sono alloggiati nell'apposito contenitore in ABS, predisposto per essere inserito negli scaffali e nei carrelli serie Visual Box o fissato a parete con tasselli.

SOVRAPPOSIZIONE



Disponibili in modelli diversi per profondità ed altezza, le cassettiere serie Visual Box hanno in comune la larghezza di mm 600. Grazie a questa caratteristica si possono sovrapporre moduli della stessa profondità e di profondità decrescente consentendo le più svariate combinazioni.

APERTURA BASCULANTE

Dotate di una comoda apertura basculante le cassettiere serie Visual Box offrono un ottimale accesso al prodotto.



ORDINE

Dotate di una comoda maniglia le cassettiere serie Visual Box rispondono in modo ottimale alle più diverse esigenze.



MATERIA PRIMA

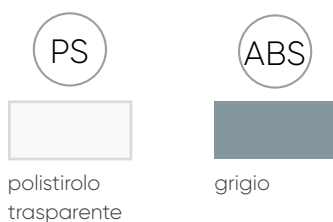

CODIFICA cassetiera Visual Box

FAX	VB	CHO	02	000	01
	serie contenitore		nr. cassetti basculanti		colore

VISUAL BOX

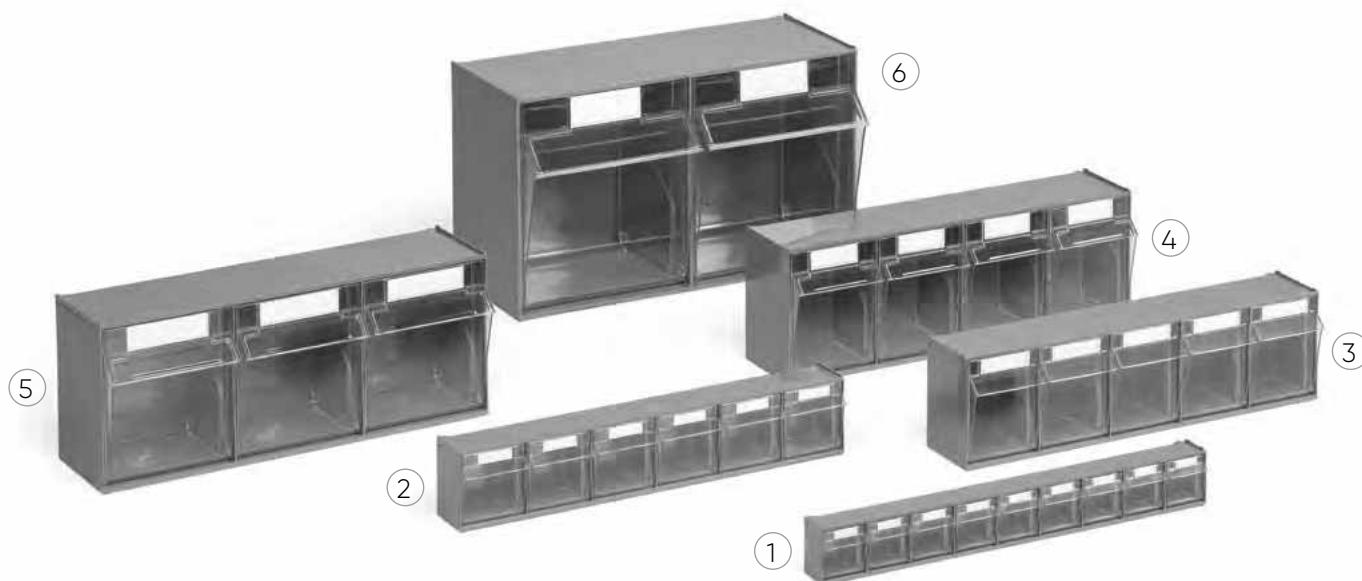

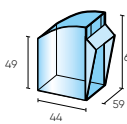
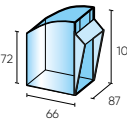
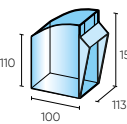
rif.	ART.	dim. cassettera mm	dim. cassetta mm	minimo d'ordine	q.tà per cartone	q.tà per pallet	disponibilità
①	FAX VB CHO 09 000 01	600 x 69 x 77 h		cartone	2	468	a magazzino
②	FAX VB CHO 06 000 01	600 x 98 x 112 h		cartone	2	216	a magazzino
③	FAX VB CHO 05 000 01	600 x 141 x 164 h		cartone	1	120	a magazzino

PS

ABS

1009

polistirolo trasparente

01

colore grigio

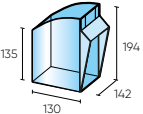
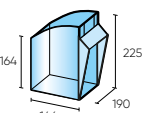
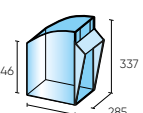

rif.	ART.	dim. cassetiera mm	dim. cassetta mm	minimo d'ordine	q.tà per cartone	q.tà per pallet	disponibilità
④	FAX VB CH0 04 000 01	600 x 174 x 206 h		cartone	1	80	a magazzino
⑤	FAX VB CH0 03 000 01	600 x 209 x 240 h		cartone	1	56	a magazzino
⑥	FAX VB CH0 02 000 01	600 x 311 x 353 h		cartone	1	30	a magazzino

VISUAL BOX



TELAIO DA BANCO

ART.	Dim. mm	
FV BS D050 000 00 01	610x150x500 H	

01
RAL 7000



TELAIO DA BANCO CON CASSETTIERE

ART.	Dim. mm	
FV BS D050 015 00 01	610x189,5x500 H	

COMPLETO CON:

- 1 ART. FAX VB CH0 06 000 01
- 1 ART. FAX VB CH0 05 000 01
- 1 ART. FAX VB CH0 04 000 01

01
RAL 7000

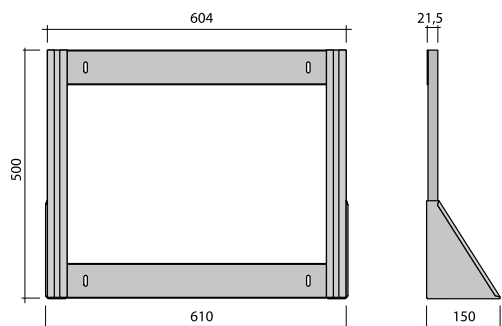

Pratico supporto atto a contenere le cassettiere serie Visual Box, il telaio è ideale per essere appoggiato sul banco da lavoro e consente all'operatore di avere sempre a portata di mano un piccolo magazzino. Realizzato in lamiera d'acciaio verniciata, viene fornito in colore grigio RAL 7000.



VISUAL BOX



(A)



(B) 36 cassetti totali



(C) 21 cassetti totali



(D) 10 cassetti totali

TELAIO DA PARETE

Rif.	ART.	Dim. mm	Cassettiere incluse	Q.tà
(A)	FV BS W030 000 00 01	600x28x300 H	-	-
(B)	FV BS W030 036 00 01	600x78x308 H	FAX VB CHO 09 000 01	4
(C)	FV BS W030 021 00 01	600x107x300 H	FAX VB CHO 09 000 01 FAX VB CHO 06 000 01	1 2
(D)	FV BS W030 010 00 01	600x150x328 H	FAX VB CHO 05 000 01	2

01
RAL 7000



(A)



(B) 54 cassetti totali



(C) 36 cassetti totali



(D) 15 cassetti totali

TELAIO DA PARETE

Rif.	ART.	Dim. mm	Cassettiere incluse	Q.tà
(A)	FV BS W050 000 00 01	600x28x500 H	-	-
(B)	FV BS W050 054 00 01	600x78x500 H	FAX VB CHO 09 000 01	6
(C)	FV BS W050 036 00 01	600x107x500 H	FAX VB CHO 09 000 01 FAX VB CHO 06 000 01	2 3
(D)	FV BS W050 015 00 01	600x183x500 H	FAX VB CHO 06 000 01 FAX VB CHO 05 000 01 FAX VB CHO 04 000 01	1 1 1

01
RAL 7000



(A)



(B) 72 cassetti totali



(C) 39 cassetti totali



(D) 28 cassetti totali

TELAIO DA PARETE

Rif.	ART.	Dim. mm	Cassettiere incluse	Q.tà
(A)	FV BS W065 000 00 01	600x28x650 H	-	-
(B)	FV BS W065 072 00 01	600x78x650 H	FAX VB CHO 09 000 01	8
(C)	FV BS W065 039 00 01	600x107x650 H	FAX VB CHO 09 000 01 FAX VB CHO 06 000 01	1 5
(D)	FV BS W065 028 00 01	600x150x664 H	FAX VB CHO 06 000 01 FAX VB CHO 05 000 01	3 2

01
RAL 7000

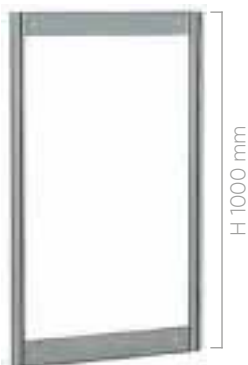

(A)



(B) 84 cassetti totali



(C) 54 cassetti totali



(D) 29 cassetti totali

TELAIO DA PARETE

Rif.	ART.	Dim. mm	Cassettiere incluse	Q.tà
(A)	FV BS W100 000 00 01	600x41x1000 H	-	-
(B)	FV BS W100 084 00 01	600x113x1022 H	FAX VB CHO 09 000 01 FAX VB CHO 06 000 01	6 5
(C)	FV BS W100 054 00 01	600x113x1008 H	FAX VB CHO 06 000 01	9
(D)	FV BS W100 029 00 01	600x224x1000 H	FAX VB CHO 06 000 01 FAX VB CHO 05 000 01 FAX VB CHO 04 000 01 FAX VB CHO 03 000 01	2 2 1 1

01
RAL 7000

VISUAL BOX

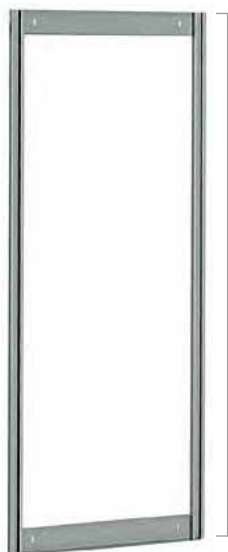

H 1500 mm



(B) 123 cassetti totali



(C) 84 cassetti totali



(D) 64 cassetti totali

TELAIO DA PARETE

Rif.	ART.	Dim. mm	Cassettiere incluse	Q.tà
(A)	FV BS W150 000 00 01	600x41x1500 H	-	-
(B)	FV BS W150 123 00 01	600x113x1500 H	FAX VB CHO 09 000 01 FAX VB CHO 06 000 01	9 7
(C)	FV BS W150 084 00 01	600x113x1568 H	FAX VB CHO 06 000 01	14
(D)	FV BS W150 064 00 01	600x224x1540 H	FAX VB CHO 09 000 01 FAX VB CHO 06 000 01 FAX VB CHO 05 000 01 FAX VB CHO 04 000 01 FAX VB CHO 03 000 01	2 4 3 1 1

01
RAL 7000





H 1750 mm

(A)



(B) 132 cassetti totali



(C) 99 cassetti totali



(D) 66 cassetti totali

TELAIO DA PARETE

Rif.	ART.	Dim. mm	Cassettiere incluse	Q.tà
(A)	FV BS W175 000 00 01	600x41x1750 H	-	-
(B)	FV BS W175 132 00 01	600x113x1750 H	FAX VB CHO 09 000 01 FAX VB CHO 06 000 01	8 10
(C)	FV BS W175 099 00 01	600x113x1757 H	FAX VB CHO 09 000 01 FAX VB CHO 06 000 01	1 15
(D)	FV BS W175 066 00 01	600x224x1750 H	FAX VB CHO 09 000 01 FAX VB CHO 06 000 01 FAX VB CHO 05 000 01 FAX VB CHO 04 000 01 FAX VB CHO 03 000 01	1 6 2 2 1

01
RAL 7000



VISUAL BOX

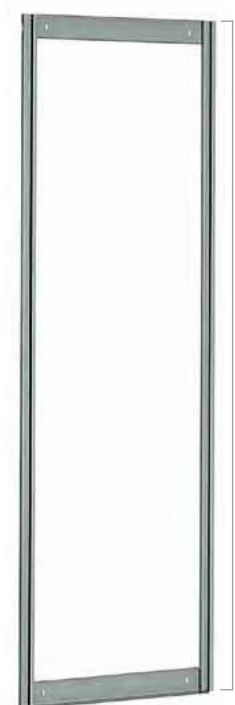

H 1950 mm

(A)



(B) 144 cassetti totali



(C) 100 cassetti totali



(D) 43 cassetti totali

TELAIO DA PARETE

Rif.	ART.	Dim. mm	Cassettiere incluse	Qtà
(A)	FV BS W195 000 00 01	600x41x1950 H	-	-
(B)	FV BS W195 144 00 01	600x113x1960 H	FAX VB CHO 09 000 01 FAX VB CHO 06 000 01	8 12
(C)	FV BS W195 100 00 01	600x156x1950 H	FAX VB CHO 09 000 01 FAX VB CHO 06 000 01 FAX VB CHO 05 000 01	3 8 5
(D)	FV BS W195 043 00 01	600x326x1989 H	FAX VB CHO 05 000 01 FAX VB CHO 04 000 01 FAX VB CHO 03 000 01 FAX VB CHO 02 000 01	6 2 1 1

01
RAL 7000

BASE PER SCAFFALE



ART. FV BS BASE 000 00 01

larghezza mm 600
profondità mm 300
altezza mm 100
COMPLETO DI KIT VITI PER IL FISSAGGIO
Colore grigio RAL 7000



VISUAL BOX

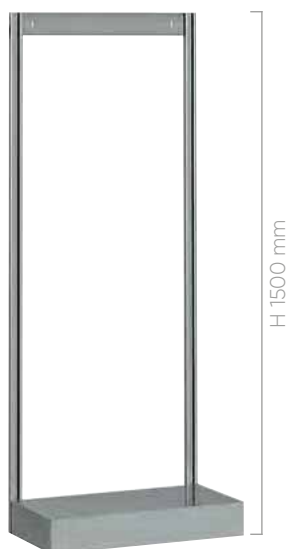

(A) H utile inserimento cassettiere 1400 mm



(B) 114 cassetti totali



(C) 78 cassetti totali



(D) 58 cassetti totali

TELAIO CON BASE

Rif.	ART.	Dim. mm	Cassettiere incluse	Q.tà
(A)	FV BS B150 000 00 01	600x325x1500 H	-	-
(B)	FV BS B150 114 00 01	600x325x1500 H	FAX VB CHO 09 000 01 FAX VB CHO 06 000 01	8 7
(C)	FV BS B150 078 00 01	600x325x1556 H	FAX VB CHO 06 000 01	13
(D)	FV BS B150 058 00 01	600x325x1528 H	FAX VB CHO 09 000 01 FAX VB CHO 06 000 01 FAX VB CHO 05 000 01 FAX VB CHO 04 000 01 FAX VB CHO 03 000 01	2 3 3 1 1

01
RAL 7000



TELAIO CON BASE

Rif.	ART.	Dim. mm	Cassettiere incluse	Q.tà
(A)	FV BS B175 000 00 01	600x325x1750 H	-	-
(B)	FV BS B175 112 00 01	600x325x1786 H	FAX VB CHO 09 000 01 FAX VB CHO 06 000 01 FAX VB CHO 05 000 01	6 8 2
(C)	FV BS B175 062 00 01	600x325x1750 H	FAX VB CHO 09 000 01 FAX VB CHO 06 000 01 FAX VB CHO 05 000 01 FAX VB CHO 04 000 01 FAX VB CHO 03 000 01	2 3 3 2 1
(D)	FV BS B175 057 00 01	600x325x1770 H	FAX VB CHO 06 000 01 FAX VB CHO 05 000 01 FAX VB CHO 04 000 01	5 3 3

01
RAL 7000

VISUAL BOX



(A) H utile inserimento cassettiere 1850 mm



(B) 117 cassetti totali



(C) 66 cassetti totali



(D) 61 cassetti totali

TELAIO CON BASE

Rif.	ART.	Dim. mm	Cassettiere incluse	Q.tà
(A)	FV BS B195 000 00 01	600x325x1950 H	-	-
(B)	FV BS B195 117 00 01	600x325x1950 H	FAX VB CHO 09 000 01 FAX VB CHO 06 000 01 FAX VB CHO 05 000 01 FAX VB CHO 04 000 01	6 9 1 1
(C)	FV BS B195 066 00 01	600x325x1950 H	FAX VB CHO 09 000 01 FAX VB CHO 06 000 01 FAX VB CHO 05 000 01 FAX VB CHO 04 000 01 FAX VB CHO 03 000 01	2 3 3 3 1
(D)	FV BS B195 061 00 01	600x325x1976 H	FAX VB CHO 06 000 01 FAX VB CHO 05 000 01 FAX VB CHO 04 000 01	5 3 4

01
RAL 7000



Lo scaffale girevole Visual Box è costituito da una base girevole a 360° sulla quale vengono fissati 4 telai porta cassettiere Visual Box, fornibili in 3 diverse altezze. Capiente, robusto, pratico, caratteristiche che lo rendono fruibile sia nei grandi che nei piccoli spazi.

STRUTTURA GIREVOLE

ART.	Dim. mm	Telai	Cassettiere incluse	Qtà
FV BS R186 260 00 01	900x900x1865 H	4 x FV BS W175 000 00 01	FAX VB CH0 09 000 01 FAX VB CH0 06 000 01 FAX VB CH0 05 000 01 FAX VB CH0 04 000 01	2 18 22 6
FV BS R161 000 00 01	900x900x1615 H	4 x FV BS W150 000 00 01	-	-
FV BS R186 000 00 01	900x900x1865 H	4 x FV BS W175 000 00 01	-	-
FV BS R206 000 00 01	900x900x2065 H	4 x FV BS W195 000 00 01	-	-

01
RAL 7000

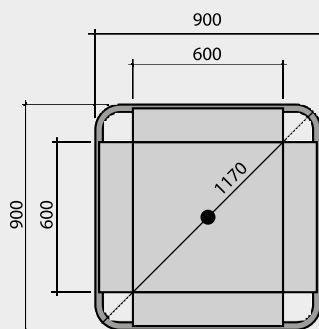
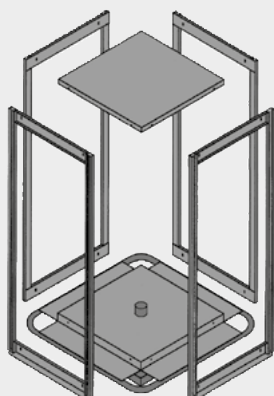

GLI SCAFFALI DEVONO ESSERE
OBBLIGATORIAMENTE FISSATI AL
PAVIMENTO

VISUAL BOX



SISTEMA VERTICALE

Il sistema verticale è costituito da un armadio modulare nel quale si inseriscono cassette da completare con cassettiere Visual Box. L'armadio è formato da una struttura in acciaio debitamente sagomata e irrobustita per poter sopportare anche carichi gravosi: viene fornito di serie con un dispositivo di apertura singola dei cassettei e deve essere fissato a pavimento o a parete. I cassettei scorrono su guide telescopiche montate su cuscinetti a sfera che garantiscono un'agevole apertura anche a pieno carico.



GRUPPO DI CHIUSURA



PIASTRA DISTRIBUZIONE

di serie nel cassetto verticale con portata 400 kg



GUIDA TELESCOPICA

cassetto verticale - estrazione 100%
con portata 100 kg



GUIDA TELESCOPICA

cassetto verticale - estrazione 100%
con portata 400 kg

MATERIALE di fissaggio

ART. F SR 8999 00 99

Set di fissaggio per una fiancata composto da 2 viti ad espansione in acciaio M10x90 mm per pavimenti in calcestruzzo non fessurato uguali o maggiori alla classe C20/25.



CODIFICA sistema verticale

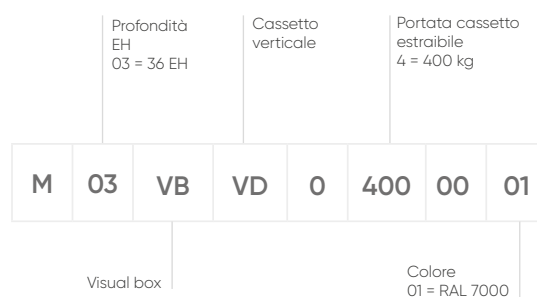

VISUAL BOX

ARMADI CON CASSETTI VERTICALI PORTATA 400 kg

ARMADI SENZA CASSETTI VERTICALI

ART. con serratura	Dim. mm	Larghezza utile armadio mm	
M 53 VBVC 0C00 00 01	1107x785x2000 H	969	
M 73 VBVC 0C00 00 01	1515x785x2000 H	1377	

CASSETTO VERTICALE PORTATA 400 kg

ART.	Dim. mm	Altezza utile cassetto mm	
M 03 VBVD 0400 00 01	705x1900 H	1725	

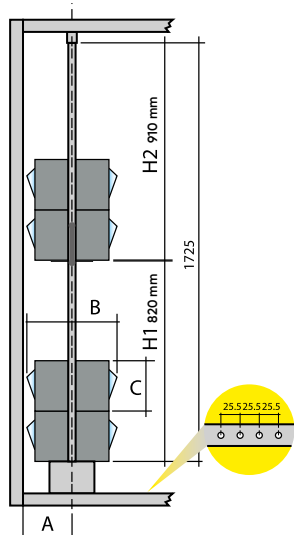

ART. cassettiere	A	B*	C	quantità H1	quantità H2
FAX VB CH0 02 000 01	330,5	650	352	2	2
FAX VB CH0 03 000 01	228,5	445	241	3	3
FAX VB CH0 04 000 01	203,5	380	207	4	4
FAX VB CH0 05 000 01	177,5	315	164	5	5
FAX VB CH0 06 000 01	126,5	225	112	7	8
FAX VB CH0 09 000 01	101,5	170	77	10	11

B* - vedi larghezza utile armadi senza cassette



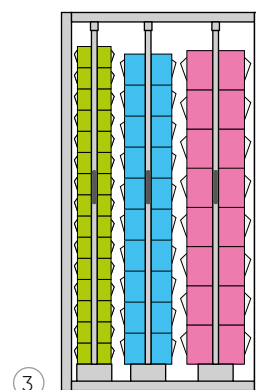
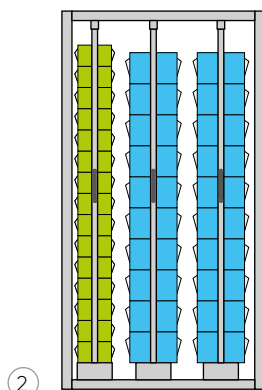
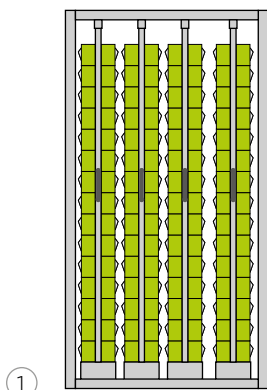

Rif.	ART. con serratura	Dim. mm	Cassettiere incluse	Qtà
①	M 53 VBVC 4C00 00 01	1107x785x2000 H	-	-
	M 53 VBVC 4C07 20 01		FAX VB CHO 06 000 01	120
②	M 53 VBVC 3C00 00 01	1107x785x2000 H	-	-
	M 53 VBVC 3C03 80 01		FAX VB CHO 06 000 01 FAX VB CHO 05 000 01	30 40
③	M 53 VBVC 3C00 01 01	1107x785x2000 H	-	-
	M 53 VBVC 3C03 44 01		FAX VB CHO 06 000 01 FAX VB CHO 05 000 01 FAX VB CHO 04 000 01	30 20 16

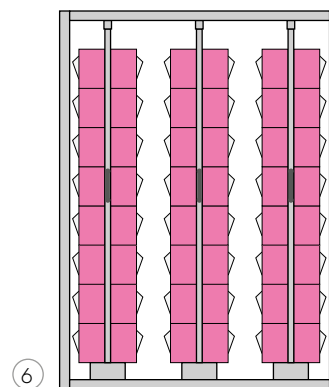
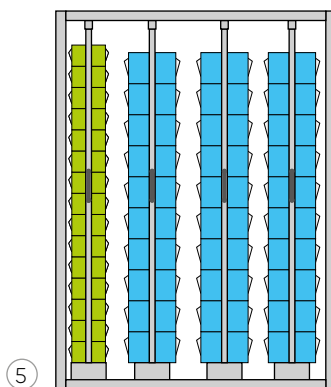
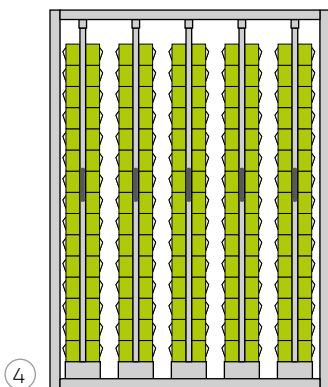

Rif.	ART. con serratura	Dim. mm	Cassettiere incluse	Qtà
④	M 73 VBVC 5C00 00 01	1515x785x2000 H	-	-
	M 73 VBVC 5C09 00 01		FAX VB CHO 06 000 01	150
⑤	M 73 VBVC 4C00 00 01	1515x785x2000 H	-	-
	M 73 VBVC 4C04 80 01		FAX VB CHO 06 000 01 FAX VB CHO 05 000 01	30 60
⑥	M 73 VBVC 3C00 00 01	1515x785x2000 H	-	-
	M 73 VBVC 3C01 92 01		FAX VB CHO 04 000 01	48

VISUAL BOX ACCESSORI

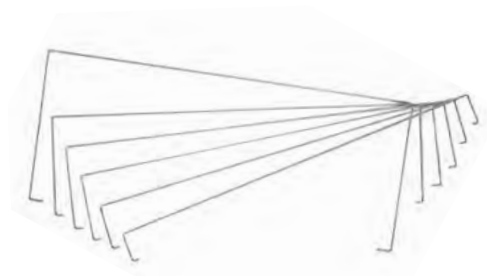

FERMI ZINCATI PER CASSETTIERE

ART.	per cassettera ART.
FAX VBCH L090 00 99	FAX VB CHO 09 000 01
FAX VBCH L060 00 99	FAX VB CHO 06 000 01
FAX VBCH L050 00 99	FAX VB CHO 05 000 01
FAX VBCH L040 00 99	FAX VB CHO 04 000 01
FAX VBCH L030 00 99	FAX VB CHO 03 000 01
FAX VBCH L020 00 99	FAX VB CHO 02 000 01



ETICHETTE IN CARTA



ART.	dim. etichetta mm	n. etichette per foglio	per cassette ART.
FAX VBET 0900 00 00	35x10	9	FAX VB CHO 09 000 01
FAX VBET 0600 00 00	53x15	6	FAX VB CHO 06 000 01
FAX VBET 0500 00 00	80x22	5	FAX VB CHO 05 000 01
FAX VBET 0400 00 00	80x28	4	FAX VB CHO 04 000 01
FAX VBET 0300 00 00	121x34	3	FAX VB CHO 03 000 01
FAX VBET 0200 00 00	121x50	2	FAX VB CHO 02 000 01



STEP MAT



TAPPETO ANTISDRUCCIOLO CHIUSO

ART.		dim. mm
FAXSMTC08004001		800x400x25 H
FAXSMTC08004006		800x400x25 H
 FAXSMTC08004107		800x400x25 H





TAPPETO ANTISDRUCCIOLO APERTO

ART.		dim. mm
FAXSMTA08004001		800x400x25 H
FAXSMTA08004006		800x400x25 H



RACCORDO PER TAPPETO

ART.		dim. mm
FAXSMRC04001205		400x120x25 H
 FAXSMRC04001207		400x120x25 H



ANGOLO PER TAPPETO

ART.		dim. mm
FAXSMAN01201205		120x120x25 H
 FAXSMAN01201207		120x120x25 H

CLIPS ZINCATE



ART. FAXSMCL00000099
DIM. MM 120X120

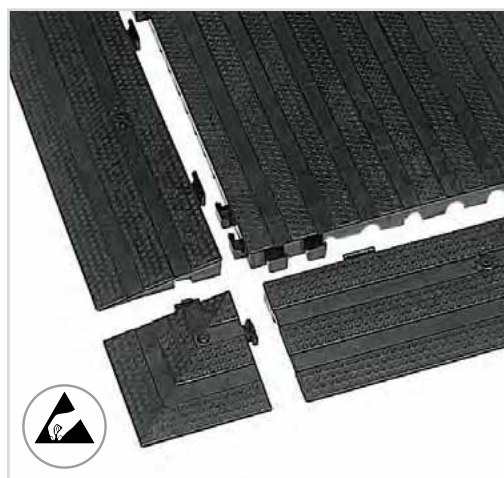

**NUMEROSI MODELLI
PER OGNI NECESSITÀ
IN LAMIERA D'ACCIAIO
VERNICIATA O ZINCATA**

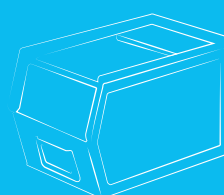
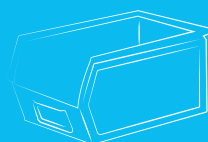
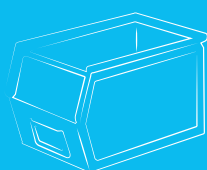



METALLO



CARATTERISTICHE TECNICHE

I contenitori e le cassette in metallo FAMI rappresentano la soluzione ideale per lo stoccaggio e la movimentazione del materiale che richiede pronta reperibilità tanto nei magazzini quanto nei reparti di produzione e montaggio. Realizzati in lamiera lucida di acciaio laminato a freddo, sono rinforzati con apposite nervature alle pareti e sul fondo per aumentarne la resistenza al carico e l'indefornabilità all'urto.

Cassette e contenitori sono agevolmente trasportabili a mano grazie a comode maniglie con blocco a 90 gradi e a traversini di sollevamento. Per il sollevamento e la movimentazione rapida e funzionale di cassette e contenitori sono disponibili pratici carrelli che consentono la massima manovrabilità anche a pieno carico e permettono di alzare pile di contenitori.



CON SLITTA

CON DOPPIO TRAVERSINO



Se il peso dei materiali da riporre è consistente, sono disponibili contenitori con slitta e quelli con doppio traversino portante che agevolano il sollevamento e lo spostamento mediante carrelli elevatori.

I CONTENITORI E LE CASSETTE

sono accatastabili tra loro, in modo da sfruttare al massimo gli spazi in magazzino e durante il trasporto. Il bordo rinforzato e rialzato assicura una perfetta aderenza nella sovrapposizione.



CASSETTE IN METALLO

Gamma colori
ACCIAIO



LEGENDA



CAPACITÀ
LITRI



LE PORTATE SONO NETTE E SI RIFERISCONO A PESI UNIFORMEMENTE DISTRIBUITI.



ZINCATO

ART.	Dim. mm	L	
F LA 3320 00 99	300x200x145 H	8,7	

VERNICIATO

ART.	Dim. mm	L	
F LA 3320 00 _ _	300x200x145 H	8,7	

Dim. interne mm 290x183x132 H



Ordinabili in lotti da: 10 pz.



Ordinabili in lotti da: 252 pz.



ZINCATO

ART.	Dim. mm	L	
F LA 4120 00 99	300x200x200 H	12	

VERNICIATO

ART.	Dim. mm	L	
F LA 4120 00 _ _	300x200x200 H	12	

Dim. interne mm 290x186x184 H



Ordinabili in lotti da: 8 pz.



Ordinabili in lotti da: 180 pz.



ZINCATO

ART.	Dim. mm	L	
F LA 6520 00 99	450x300x200 H	27	

VERNICIATO

ART.	Dim. mm	L	
F LA 6520 00 _ _	450x300x200 H	27	

Dim. interne mm 442x285x182 H



Ordinabili in lotti da: 6 pz.



Ordinabili in lotti da: 56 pz.



ZINCATO

ART.	Dim. mm	L	
F LA 7320 00 99	450x300x300 H	40,5	

VERNICIATO

ART.	Dim. mm	L	
F LA 7320 00 _ _	450x300x300 H	40,5	

Dim. interne mm 440x280x278 H



Ordinabili in lotti da: 4 pz.



Ordinabili in lotti da: 56 pz.



ZINCATO

ART.	Dim. mm	L	
F LA 8920 00 99	630x450x300 H	85	

VERNICIATO

ART.	Dim. mm	L	
F LA 8920 00 _ _	630x450x300 H	85	

Dim. interne mm 617x430x278 H



-



Ordinabili in lotti da: 6 pz.



ETICHETTE PER CONTENITORI E CASSETTE

ART.		per cassette e contenitori	dim. mm etichetta singola	n. etichette per foglio	
F LS 9040 00 00	F LA 3320 00 ..		73x37	15	
F LS 9060 00 00	F LA 4120 00 ..		80x48	12	
	F LA 6520 00 ..				
F LS 9080 00 00	F LA 7320 00 ..		102x76	6	
	F LA 8920 00 ..				



CASSETTE FORATE

Gamma colori
ACCIAIO



ACCIAIO INOX

.ZZ



ZINCATO

.99

LEGENDA



SCATOLA



PALETTA



CAPACITÀ
LITRI





LE PORTATE SONO NETTE E SI RIFERISCONO A PESI UNIFORMEMENTE DISTRIBUITI.



● FORO Ø 3 mm acciaio inox

ART.	Dim. mm	L	
F LA 6511 00 ZZ	450x300x200 H	27	

Dim. interne mm 442x285x182 H



-  Ordinabili in lotti da: 6 pz.
-  Ordinabili in lotti da: 56 pz.



● FORO Ø 4,2 mm zincato

ART.	Dim. mm	L	
F LA 6511 00 ZZ	450x300x200 H	27	

Dim. interne mm 442x285x182 H



-  Ordinabili in lotti da: 6 pz.
-  Ordinabili in lotti da: 56 pz.



● FORO Ø 5,5 mm zincato

ART.	Dim. mm	L	
F LA 6512 00 99	450x300x200 H	27	

Dim. interne mm 442x285x182 H



-  Ordinabili in lotti da: 6 pz.
-  Ordinabili in lotti da: 56 pz.



● FORO Ø 7 mm zincato

ART.	Dim. mm	L	
F LA 6513 00 99	450x300x200 H	27	

Dim. interne mm 442x285x182 H



-  Ordinabili in lotti da: 6 pz.
-  Ordinabili in lotti da: 56 pz.



● FORO Ø 10 mm zincato

ART.	Dim. mm	L	
F LA 6515 00 99	450x300x200 H	27	

Dim. interne mm 442x285x182 H



-  Ordinabili in lotti da: 6 pz.
-  Ordinabili in lotti da: 56 pz.



● FORO Ø 15 mm zincato

ART.	Dim. mm	L	
F LA 6517 00 99	450x300x200 H	27	

Dim. interne mm 442x285x182 H

-  Ordinabili in lotti da: 6 pz.
-  Ordinabili in lotti da: 56 pz.



CONTENITORI IN METALLO

Gamma colori
ACCIAIO



GRIGIO RAL 7000
.01

VERDE RAL 6011
.02

ZINCATO
.99



Traversino di sollevamento abbinato alla
maniglia blocco a 90°

LEGENDA



SCATOLA



PALETTA



CAPACITÀ
LITRI



LE PORTATE SONO NETTE E SI RIFERISCONO A PESI UNIFORMEMENTE DISTRIBUITI.



ZINCATO NON DISPONIBILE

ART.	Dim. mm	L
F LS 1700 00 _ _	160/140x95x75 H	1

Dim. interne mm 138x86x66 H

	Ordinabili in lotti da: 20 pz.
	-



ZINCATO

ART.	Dim. mm	L
F LS 2500 00 99	230/200x140x130 H	3,8

VERNICIATO

ART.	Dim. mm	L
F LS 2500 00 _ _	230/200x140x130 H	3,8

Dim. interne mm 196x131x113 H

	Ordinabili in lotti da: 20 pz.
	-



ZINCATO

ART.	Dim. mm	L
F LS 3300 00 99	350/300x200x145 H	9,4

VERNICIATO

ART.	Dim. mm	L
F LS 3300 00 _ _	350/300x200x145 H	9,4

Dim. interne mm 298x181x135 H

	Ordinabili in lotti da: 10 pz.
	Ordinabili in lotti da: 252 pz.



ZINCATO

ART.	Dim. mm	L
F LS 4100 00 99	350/300x200x200 H	12,5

VERNICIATO

ART.	Dim. mm	L
F LS 4100 00 _ _	350/300x200x200 H	12,5

Dim. interne mm 300x185x184 H

	Ordinabili in lotti da: 8 pz.
	Ordinabili in lotti da: 180 pz.



ZINCATO

ART.	Dim. mm	L
F LS 4900 00 99	500/450x200x200 H	18

VERNICIATO

ART.	Dim. mm	L
F LS 4900 00 _ _	500/450x200x200 H	18

Dim. interne mm 448x184x184 H

	Ordinabili in lotti da: 6 pz.
	-



ZINCATO

ART.	Dim. mm	L
F LS 5700 00 99	500/450x300x145 H	20

VERNICIATO

ART.	Dim. mm	L
F LS 5700 00 _ _	500/450x300x145 H	20

Dim. interne mm 448x281x135 H

	-
	-



ZINCATO

ART.	Dim. mm	L	
F LS 6500 00 99	500/450x300x200 H	28	

VERNICIATO

ART.	Dim. mm	L	
F LS 6500 00 _ _	500/450x300x200 H	28	

Dim. interne mm 448x284x185 H



Ordinabili in lotti da: 6 pz.

Ordinabili in lotti da: 56 pz.



ZINCATO

ART.	Dim. mm	L	
F LS 7300 00 99	520/450x300x300 H	42	

VERNICIATO

ART.	Dim. mm	L	
F LS 7300 00 _ _	520/450x300x300 H	42	

Dim. interne mm 446x288x278 H



Ordinabili in lotti da: 4 pz.

Ordinabili in lotti da: 56 pz.



ZINCATO

ART.	Dim. mm	L	
F LS 8100 00 99	520/450x450x300 H	63	

VERNICIATO

ART.	Dim. mm	L	
F LS 8100 00 _ _	520/450x450x300 h	63	

Dim. interne mm 448x428x278 H



Ordinabili in lotti da: 6 pz.



ZINCATO

ART.	Dim. mm	L	
F LS 8900 00 99	700/630x450x300 H	88	

VERNICIATO

ART.	Dim. mm	L	
F LS 8900 00 _ _	700/630x450x300 H	88	

Dim. interne mm 630x428x278 H



Ordinabili in lotti da: 6 pz.

APPLICAZIONI SPECIALI

CONTENITORI CON DOPPIO TRAVERSINO

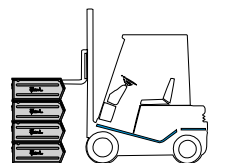

sistema di prelievamento con carrello elevatore

CONTENITORI CON SLITTA

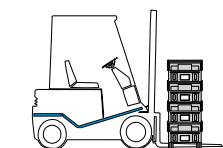

sistema di prelievamento con carrello elevatore



ZINCATO

ART.	Dim. mm	L	
F LS 6501 00 99	500/450x300x200 H	28	

VERNICIATO

ART.	Dim. mm	L	
F LS 6501 00 _ _	500/450x300x200 H	28	

Dim. interne mm 448x284x185 H



Ordinabili in lotti da: 6 pz.



Ordinabili in lotti da: 56 pz.



ZINCATO

ART.	Dim. mm	L	
F LS 7301 00 99	520/450x300x300 H	42	

VERNICIATO

ART.	Dim. mm	L	
F LS 7301 00 _ _	520/450x300x300 H	42	

Dim. interne mm 446x288x278 H



Ordinabili in lotti da: 4 pz.



Ordinabili in lotti da: 56 pz.



ZINCATO

ART.	Dim. mm	L	
F LS 8101 00 99	520/450x450x300 H	63	

VERNICIATO

ART.	Dim. mm	L	
F LS 8101 00 _ _	520/450x450x300 H	63	

Dim. interne mm 448x428x278 H



-



Ordinabili in lotti da: 6 pz.



ZINCATO

ART.	Dim. mm	L	
F LS 8901 00 99	700/630x450x300 H	88	

VERNICIATO

ART.	Dim. mm	L	
F LS 8901 00 _ _	700/630x450x300 H	88	

Dim. interne mm 630x428x278 H



-



Ordinabili in lotti da: 6 pz.



ZINCATO

ART.	Dim. mm	L	
F LS 8110 00 99	520/450x450x390 H	63	

VERNICIATO

ART.	Dim. mm	L	
F LS 8110 00 _ _	520/450x450x390 H	63	

Dim. interne mm 448x428x278 H



-



Ordinabili in lotti da: 6 pz.



ZINCATO

ART.	Dim. mm	L	
F LS 8910 00 99	700/630x450x390 H	88	

VERNICIATO

ART.	Dim. mm	L	
F LS 8910 00 _ _	700/630x450x390 H	88	

Dim. interne mm 630x428x278 H



-



Ordinabili in lotti da: 6 pz.

PORTA ETICHETTE INCLINATO



ART.

F ND 2120 00 99

ADATTO PER CONTENITORI:

ART. F LS 7300 00 - F LS 7301 00
 - F LS 8100 00 - F LS 8101 00
 - F LS 8110 00 - F LS 8900 00
 - F LS 8901 00 - F LS 8910 00



ART.

F ND 2110 00 99

ADATTO PER CONTENITORI:

ART. F LS 4100 00 - F LS 6500 00
 - F LS 6501 00



ETICHETTE PER CONTENITORI E CASSETTE

ART.	per cassette e contenitori	dim. mm etichetta singola	n. etichette per foglio
F LS 9020 00 00	F LS 1700 00 ..	47x17	60
	F LS 2500 00 ..		
F LS 9040 00 00	F LS 3300 00 ..	73x37	15
	F LS 5700 00 ..		
F LS 9060 00 00	F LS 4100 00 ..	80x48	12
	F LS 4900 00 ..		
	F LS 6500 00 ..		
F LS 9080 00 00	F LS 6501 00 ..	102x76	6
	F LS 7300 00 ..		
	F LS 7301 00 ..		
	F LS 8900 00 ..		
	F LS 8901 00 ..		
	F LS 8910 00 ..		
	F LS 8100 00 ..		
F LS 8101 00 ..			
	F LS 8110 00 ..		

DIVISORI LONGITUDINALI IN METALLO



DIVISORIO LONGITUDINALE IN METALLO CON COPPIA SUPPORTI

DIVISORIO LONGITUDINALE SUPPLEMENTARE



ART.	per cassette e contenitori
F ND 0130 01 99	F LS 4100 00 ..
	F LS 6500 00 ..
F ND 0190 01 99	F LS 6501 00 ..
	F LS 7300 00 ..
F ND 0221 01 99	F LS 7301 00 ..
	F LS 8100 00 ..
F ND 0221 02 99	F LS 8101 00 ..
	F LS 8110 00 ..
	F LS 8900 00 ..
F ND 0241 01 99	F LS 8901 00 ..
	F LS 8910 00 ..

ART.	per cassette e contenitori
F ND 0130 00 99	F LS 4100 00 ..
F ND 0190 00 99	F LS 6500 00 ..
	F LS 6501 00 ..
F ND 0221 00 99	F LS 7300 00 ..
	F LS 7301 00 ..
	F LS 8100 00 ..
F ND 0221 00 99	F LS 8101 00 ..
	F LS 8110 00 ..
	F LS 8900 00 ..
F ND 0241 00 99	F LS 8901 00 ..
	F LS 8910 00 ..



CONTAINERS METALLICI



I containers in metallo possono essere corredati di portaetichette, da agganciare al bordo, o di targa di portata, stampata a rilievo, saldata nella posizione richiesta dal cliente.



Lo spazio interno dei containers può essere suddiviso in più scomparti grazie ai pratici divisori in lamiera verniciata.



● ART. F ML 0321 00 01

● ART. F ML 0320 00 01

Gamma colori
ACCIAIO



GRIGIO RAL 7000
.01

LEGENDA



PORTATA



LE PORTATE SONO NETTE E SI RIFERISCONO A PESI UNIFORMEMENTE DISTRIBUITI.

PALLETS IN LAMIERA

Realizzati in lamiera di acciaio verniciata, i pallets, ideali per la movimentazione del materiale con i carrelli elevatori, si caratterizzano per la maggiore portata e durata nel tempo dei tradizionali pallets in legno.

ART.		dim. mm	kg
F ML 0610 00 01		1000x800x155 H	2000*
F ML 0620 00 01		1200x800x155 H	2000*

*Portata con carico uniformemente distribuito, calcolata con la paletta appoggiata su una superficie uniforme



CONTAINERS IN LAMIERA



ART.		dim. mm	kg
F ML 0320 00 01		800x500x600 H	700



ART.		dim. mm	kg
F ML 0321 00 01		800x500x600 H	700

Con portello apribile

CONTAINERS A BOCCA DI LUPO

ART.		dim. mm	kg
F ML 0510 00 01		800x700x600 H	1000



STEEL





STEEL

CONTAINERS IN RETE



ART.		dim. mm	foro maglia mm	kg
F MM 0400 00 01		1000x800x800 H	60x30	1000
F MM 0410 00 01		1000x800x800 H	40x40	1500



ART.		dim. mm	foro maglia mm	kg
F MM 0401 00 01		1000x800x800 H	60x30	1000
F MM 0411 00 01		1000x800x800 H	40x40	1500

Con portello apribile



ART.		dim. mm	foro maglia mm	kg
F MM 0420 00 01		1200x800x800 H	60x30	1000
F MM 0430 00 01		1200x800x800 H	40x40	1500



ART.		dim. mm	foro maglia mm	kg
F MM 0421 00 01		1200x800x800 H	60x30	1000
F MM 0431 00 01		1200x800x800 H	40x40	1500

Con portello apribile



DIVISORI MOBILI PER CONTAINERS



ART.		dim. mm
F MM 0710 00 01		225x760x470 H

ADATTO PER ARTICOLI:
F MM 0400 - F MM 0401 - F MM 0410 - F MM 0411 - F MM 0430
F MM 0431 - F ML 0440 - F ML 0441 - F ML 0460 - F ML 0461



ZINCATO

ART.		dim. mm
F ML 0710 00 99		630/460x405 H

VERNICIATO

ART.		dim. mm
F ML 0710 00 01		630/460x405 H

ADATTO PER ARTICOLI:
F MM 0510



Esempi di utilizzo dei divisori



STEEL



ART.		dim. mm	kg
F ML 0430 00 01		1000x800x690 H	1500



ART.		dim. mm	kg
F ML 0431 00 01		1000x800x690 H	1500

Con portello apribile



ART.		dim. mm	kg
F ML 0440 00 01		1000x800x800 H	1500



ART.		dim. mm	kg
F ML 0441 00 01		1000x800x800 H	1500

Con portello apribile



ART.		dim. mm	kg
F ML 0420 00 01		1000x800x670 H	2000



PARTICOLARE DEL FONDO



ART.		dim. mm	kg
F ML 0450 00 01		1200x800x690 H	1500



ART.		dim. mm	kg
F ML 0451 00 01		1200x800x690 H	1500

Con portello apribile



ART.		dim. mm	kg
F ML 0461 00 01		1200x800x800 H	1500

Con portello apribile



ART.		dim. mm	kg
F ML 0460 00 01		1200x800x800 H	1500





ART.		dim. mm	kg
F ML 0121 00 01		1000x800x1150 H	2000

ART.		dim. mm	kg
F ML 0111 00 01		1000x800x800 H	2000

CONTAINERS CON FONDO APRIBILE A RULLI

Sollevati con carrello elevatore tramite le quattro maniglie saldate al bordo superiore, consentono di scaricare il materiale per mezzo del fondo apribile a rulli (apertura del 87%). L'apertura avviene in modo facile e sicuro tramite la leva posta sul lato da 800 mm, mentre la chiusura mediante un particolare dispositivo composto di leve e rulli d'acciaio.



1.



2.



3.



4.

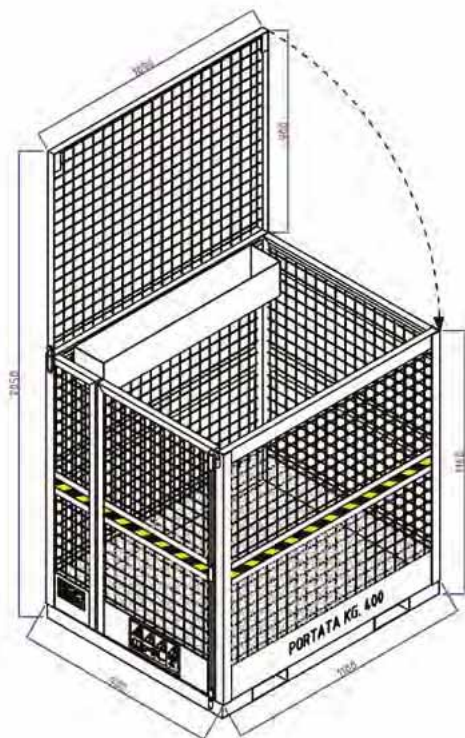

ART.

dim. mm

kg

F AX PPSE00 0000 HE

1100x900x2050 H

400

Colore arancione RAL 2010

Con porta



CONTAINERS PER MANUTENZIONE AEREA



1.



2.

BENNE RIBALTABILI



• ART. F AX BBRE00 0000 04



• ART. F ML 0200 10 01

LEGENDA



PORTATA



RUOTE



CAPACITÀ
LITRI



LE PORTATE SONO NETTE E SI RIFERISCONO A PESI UNIFORMEMENTE DISTRIBUITI.



ART.	dim. mm	kg		L
● F AX BBRE00 0000 04	1300x1000x1120 H	800	Ø 200 mm	400
F AX BBRF00 0000 04	1720x1100x1580 H	1200	Ø 200 mm	800

04
RAL 5012

F AX BBRE00 0000 04

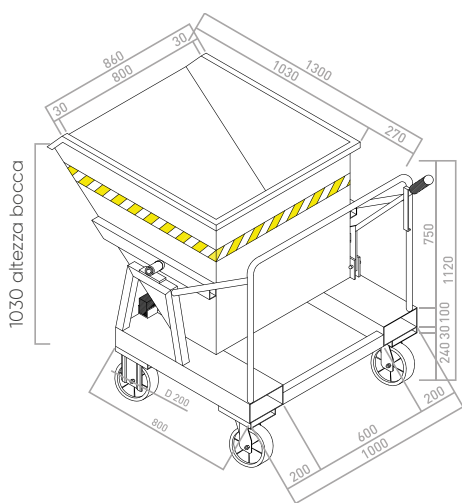

F AX BBRF00 0000 04

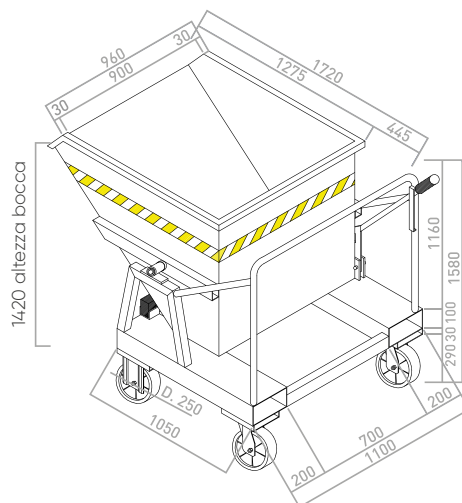



ART.	dim. mm	kg	
F ML 0200 05 01	965x1480x1161 H	1000	

Con 4 zoccoli per il trasporto con transpallet

■ 01
RAL 7000

ART.	dim. mm	kg	
F ML 0200 00 01	965x1480x1060 H	1000	

■ 01
RAL 7000



ART.	dim. mm	kg	RUOTE
F ML 0200 10 01	965x1480x1265 H	900	160 mm

Con 2 ruote in nylon Ø 160 mm con supporto fisso e 2 ruote in nylon Ø 160 mm con supporto girevole senza freno

■ 01
RAL 7000

BENNE RIBALTABILI

Prelevare la benna, per lo scarico del contenuto con carrello elevatore. Tirare il cavo d'acciaio per azionare il meccanismo di ribaltamento, rimanendo seduti in totale sicurezza.



1.



2.

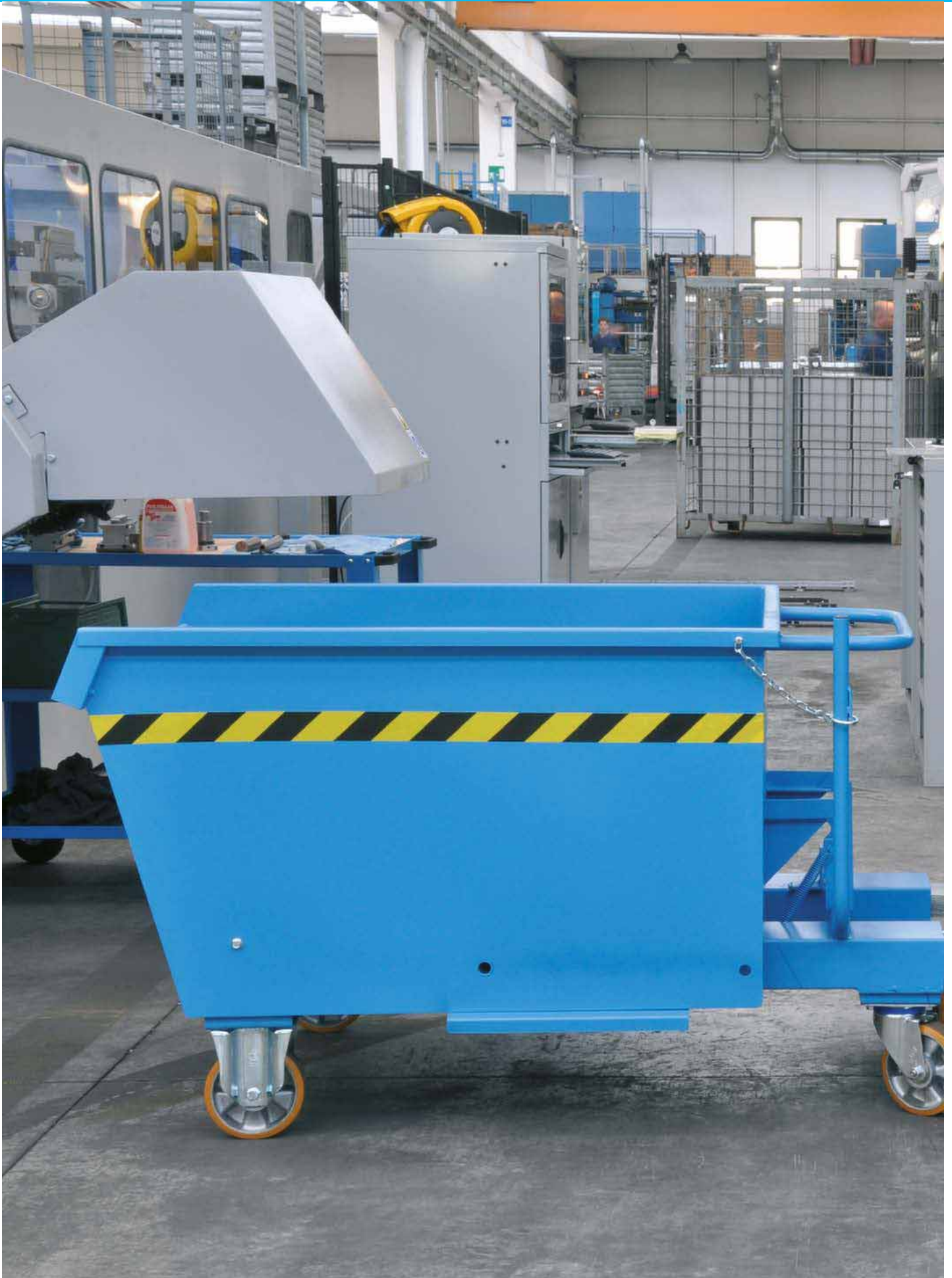

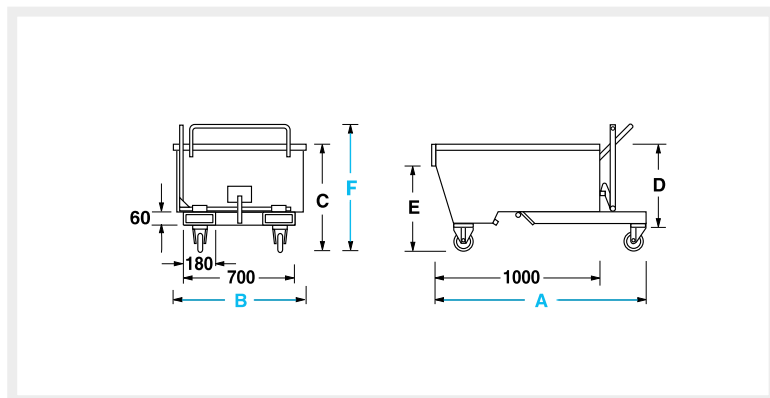

ART.	dim. mm						kg	L
	A	B	C	D	E	F		
F AX LT0300 0000 04	1370	820	650	491	527	870	600	285
F AX LT0400 0000 04	1370	820	855	695	730	855	800	420

Benna ribaltabile con ruote in poliuretano Ø 125 mm

KIT VASCA E RUBINETTO

per benna

F AX LT0300 KTGO 04	F AX LT0300 0000 04
F AX LT0400 KTGO 04	F AX LT0400 0000 04

04
RAL 5012

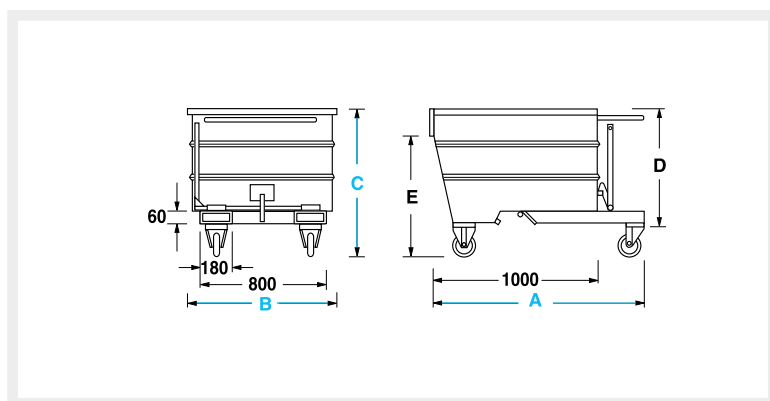

ART.	dim. mm					kg	L
	A	B	C	D	E		
F AX LT0500 0000 04	1370	920	900	700	720	1000	490
F AX LT0750 0000 04	1350	1070	1025	825	780	1350	755

Benna ribaltabile con ruote in poliuretano Ø 160 mm

KIT VASCA E RUBINETTO

per benna

F AX LT0500 KTGO 04	F AX LT0500 0000 04
F AX LT0750 KTGO 04	F AX LT0750 0000 04

04
RAL 5012

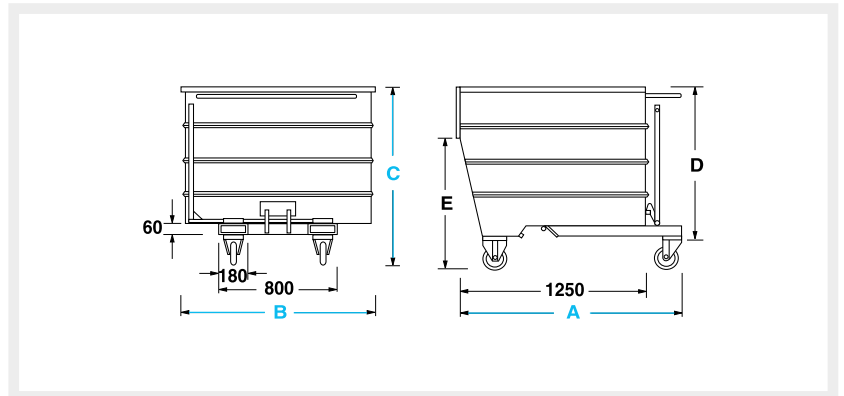

ART.	dim. mm					kg	L
	A	B	C	D	E		
F AX LT1000 0000 04	1550	1070	1165	965	880	1700	1070
F AX LT1350 0000 04	1550	1320	1165	965	880	2000	1320
F AX LT1600 0000 04	1550	1550	1170	970	880	2000	1610

Benna ribaltabile con ruote in poliuretano Ø 160 mm

KIT VASCA E RUBINETTO

per benna

F AX LT1000K TGO 04	F AX LT1000 0000 04
F AX LT1350K TGO 04	F AX LT1350 0000 04
F AX LT1600K TGO 04	F AX LT1600 0000 04

04
RAL 5012

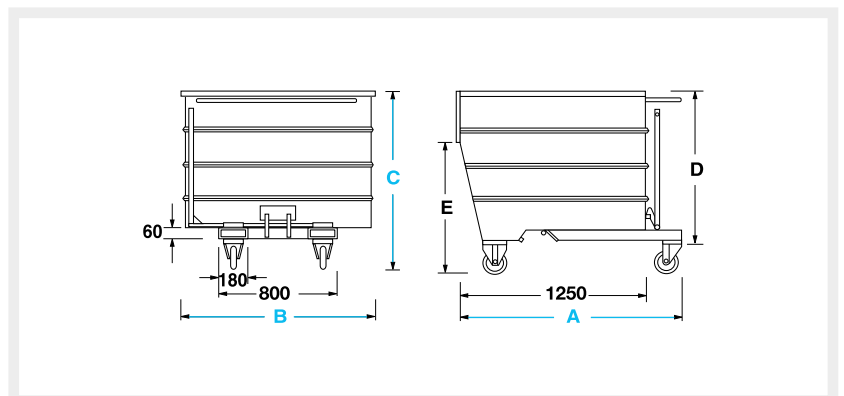

ART.	L	dim. mm	
		A	B
F AX LT2000 0000 04	2040	1550	2040

Benna ribaltabile con ruote in poliuretano Ø 160 mm

KIT VASCA E RUBINETTO

per benna

F AX LT2000K TGO 04	F AX LT2000 0000 04
---------------------	---------------------

04
RAL 5012

**MATERIALE ORGANIZZATO
E SEMPRE A PORTATA DI MANO,
IN LINEA CON LA FILOSOFIA
"LEAN PRODUCTION"**

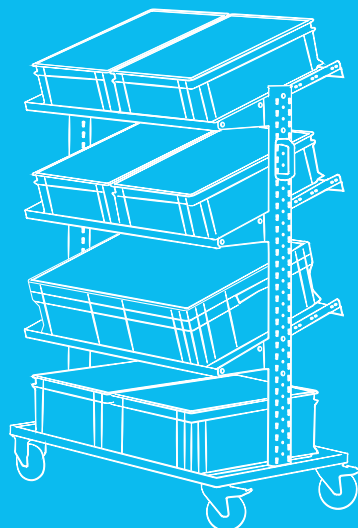
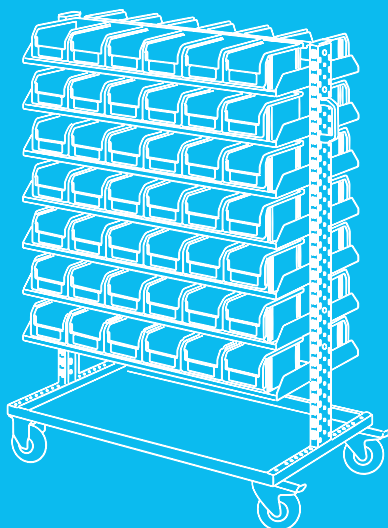



SMART

CARATTERISTICHE TECNICHE

Oltre la comune struttura composta da montanti, mensole e ruote, la natura modulare del carrello serie Smart offre infinite configurazioni customizzabili con mensole inclinabili, cassette e contenitori di varie dimensioni, armadi a persiana e pannelli forati porta utensili.



LARGHEZZA

Il carrello serie Smart è disponibile con altezza 1430 H e 2 diverse larghezze:

- Passo 687 mm per carrelli smart 073
- Passo 985 mm per carrelli smart 101-102-103

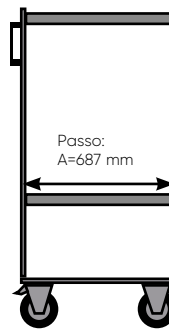

CARRELLI SMART 073

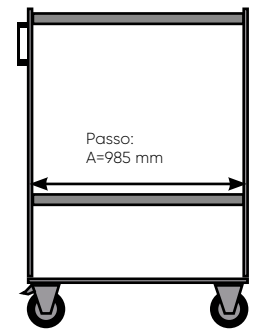

CARRELLI SMART 101
CARRELLI SMART 103
CARRELLI SMART 102

MENSOLE

Le mensole inclinabili per carrelli smart con lunghezza 955 mm passo 985 mm possono essere di 4 profondità mm: 220- 320-420-600.

La mensola inclinabile per carrelli smart con lunghezza 657 mm passo 687 mm possono essere di 2 profondità mm: 220-420.

Oltre alle mensole inclinate il carrello è configurabile anche con mensole fisse per contenitori entrambi con diversa profondità.



mensole inclinabili



mensole fisse

REGOLAZIONI

Il traverso forato base permette la regolazione dei montanti e l'inserimento di diverse tipologie di cassette, massima flessibilità di regolazione per inserire cassette dalla più piccola alla più grande.

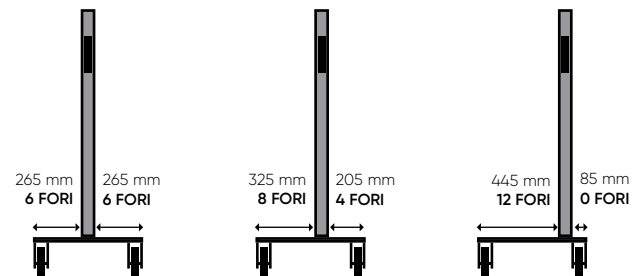

ACCESSORI

Per sfruttare al meglio gli spazi del carrello sono opzionabili accessori quali il pannello forato, l'armadio a persiana, le cassette VISUAL BOX e i traversi di irrigidimento.





● ART. F LB B102 56 52

H = 1430 mm



● ART. F LB B073 54 52

H = 1430 mm



● ART. F LB B103 52 52

H = 1430 mm

Gamma colori
ACCIAIO

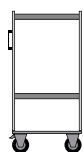

ZINCATO +
GRIGIO RAL 7000
.52



FORNITI DI SERIE CON RUOTE MONTATE E TELAIO SMONTATO



Completati di 2 ruote fisse e 2 ruote girevoli con freno
Ø 125 mm in gomma standard

GLI ACCESSORI E I MATERIALI STOCCATI NEI CARRELLI
NON DEVONO SPORGERE DALLA BASE DEL CARRELLO
STESSO.

LEGENDA



PORTATA
CARRELLO



LE PORTATE SONO NETTE E SI RIFERISCONO A PESI UNIFORMEMENTE DISTRIBUITI.



SMART 101

ART.		Dim. mm	kg
F LB B101 52 52		1023x613x1430 H	300

3 mensole per mis. 2 - 2 mensole per mis. 3A2 - 1 mensola profondità 420 mm
 18 contenitori PICKING BOX **mis. 2** art. FAX PB C002 A0 51 01
 8 contenitori PICKING BOX **mis. 3A2** art. FAX PB C3A2 B0 51 01
 3 contenitori PICKING BOX **mis. 4A2** art. FAX PB C4A2 B0 51 01
 3 contenitori PICKING BOX **mis. 4** art. FAX PB C004 B0 51 01

CARRELLO SENZA CONTENITORI ART. **F LB B101 02 52**







SMART 102

ART.		Dim. mm	
F LB B102 52 52		1023x613x1430 H	300

20 mensole per mis. 1
180 contenitori PICKING BOX **mis. 1** art. FAX PB C001 A0 51 01
Portata 300 kg (150 kg PER LATO)
COLORE ZINCATO + GRIGIO RAL 7000

CARRELLO SENZA CONTENITORI ART. **F LB B102 02 52**

ART.		Dim. mm	
F LB B102 53 52		1023x613x1430 H	300

10 mensole per mis. 1 - 8 mensole per mis. 2
90 contenitori PICKING BOX **mis. 1** art. FAX PB C001 A0 51 01
24 contenitori PICKING BOX **mis. 2** art. FAX PB C002 A0 51 01
Portata 300 kg (150 kg PER LATO)
COLORE ZINCATO + GRIGIO RAL 7000

CARRELLO SENZA CONTENITORI ART. **F LB B102 03 52**





SMART 102

ART.		Dim. mm	kg
F LB B102 54 52		1023x613x1430 H	300

14 mensole per mis. 2
84 contenitori PICKING BOX **mis. 2** art. FAX PB C002 A0 51 01
Portata 300 kg (150 kg PER LATO)
COLORE ZINCATO + GRIGIO RAL 7000

CARRELLO SENZA CONTENITORI ART. **F LB B102 04 52**

ART.		Dim. mm	kg
F LB B102 59 52		1023x613x1430 H	300

6 mensole profondità 220 mm
12 cassette **EURO BOX** art. FAX EB 3212 A0 51 01
12 cassette **EURO BOX** art. FAX EB 3217 A0 51 01
4 pannelli forati ESCLUSI UTENSILI
2 set di 54 ganci (cadauno) art. F BL 9510 00 99 (25 ART. CMV10037, 1 ART. CMV10016, 9 ART. CMV10022, 6 ART. CMV10021, 1 ART. CMV 10020, 4 ART. CMV 10007, 1 ART. CMV 10001)
Portata 300 kg (150 kg PER LATO)
COLORE ZINCATO + GRIGIO RAL 7000

CARRELLO SENZA CASSETTE E GANCI ART. **F LB B102 09 52**



**CONTENITORI
SERIE PICKING BOX**



SMART 102

ART.		Dim. mm	
F LB B102 57 52		1023x613x1430 H	300

3 mensole per mis. 1 - 4 mensole per mis. 2 - 3 mensole per mis. 3A2
 27 contenitori PICKING BOX **mis. 1** art. FAX PB C001 A0 51 01
 24 contenitori PICKING BOX **mis. 2** art. FAX PB C002 A0 51 01
 12 contenitori PICKING BOX **mis. 3A2** art. FAX PB C3A2 B0 51 01
 1 armadio a persiana ESCLUSI UTENSILI
 1 set di 54 ganci art. F BL 9510 00 99 (25 ART. CMV10037, 1 ART. CMV10016,
 9 ART. CMV10022, 6 ART. CMV10021, 1 ART. CMV 10020, 4 ART. CMV 10007,
 1 ART. CMV 10001)
 Portata 300 kg (150 kg PER LATO)
 COLORE ZINCATO + GRIGIO RAL 7000

CARRELLO SENZA CONTENITORI E GANCI ART. **F LB B102 07 52**

ART.		Dim. mm	
F LB B102 56 52		1023x613x1430 H	300

● 5 mensole per mis. 1 - 4 mensole per mis. 2 - 6 mensole per mis. 3A2
 45 contenitori PICKING BOX **mis. 1** art. FAX PB C001 A0 51 01
 24 contenitori PICKING BOX **mis. 2** art. FAX PB C002 A0 51 01
 28 contenitori PICKING BOX **mis. 3A2** art. FAX PB C3A2 B0 51 01
 Portata 300 kg (150 kg PER LATO)
 COLORE ZINCATO + GRIGIO RAL 7000

CARRELLO SENZA CONTENITORI ART. **F LB B102 06 52**

CASSETTE SERIE EURO BOX





SMART 102

ART.		Dim. mm	kg
F LB B102 58 52		1023x613x1430 H	300

5 mensole per mis. 1 - 4 mensole per mis. 2 - 5 mensole profondità 320 mm
 45 contenitori PICKING BOX **mis. 1** art. FAX PB C001 A0 51 01
 24 contenitori PICKING BOX **mis. 2** art. FAX PB C002 A0 51 01
 6 cassette **EURO BOX** art. FAX EB 4312 A0 51 01
 4 cassette **EURO BOX** art. FAX EB 4317 A0 51 01
 Portata 300 kg (150 kg PER LATO)
 COLORE ZINCATO + GRIGIO RAL 7000

CARRELLO SENZA CONTENITORI E CASSETTE ART. **F LB B102 08 52**

ART.		Dim. mm	kg
F LB B102 62 52		1023x613x1430 H	300

3 mensole profondità 420 mm
 9 cassette **EURO BOX** art. FAX EB 4317 A0 51 01
 2 cassette **EURO BOX** art. FAX EB 6417 A0 51 01
 Portata 300 kg (150 kg PER LATO)
 COLORE ZINCATO + GRIGIO RAL 7000

CARRELLO SENZA CASSETTE ART. **F LB B102 12 52**





SMART 103

ART.		Dim. mm	kg
F LB B103 52 52		1023x613x1430 H	300

3 mensole profondità 600 mm
 4 cassette **EURO BOX** art. FAX EB 6417 A0 51 01
 2 cassette **EURO BOX** art. FAX EB 6422 A0 51 01
 1 cassetta **EURO BOX** art. FAX EB 8622 C0 51 01
 Portata 300 kg (150 kg PER LATO)

CARRELLO SENZA CASSETTE ART. **F LB B103 02 52**



SMART 073

ART.		Dim. mm	kg
F LB B073 55 52		725x613x1430 H	300

3 mensole profondità 420 mm
 4 cassette **EURO BOX** art. FAX EB 4317 A0 51 01
 1 cassetta **EURO BOX** art. FAX EB 6417 A0 51 01
 1 cassetta **EURO BOX** art. FAX EB 6422 A0 51 01
 Portata 300 kg (150 kg PER LATO)

CARRELLO SENZA CASSETTE ART. **F LB B073 05 52**





SMART 073

ART.		Dim. mm	kg
F LB B073 53 52		725x613x1430 H	300

6 mensole profondità 220 mm - 4 coppie profili parziali per VISUAL BOX (Portata 50 kg)
 4 cassettiere **VISUAL BOX** art. FAX VB CH00 60 00 01
 4 cassettiere **VISUAL BOX** art. FAX VB CH00 50 00 01
 12 cassette **EURO BOX** art. FAX EB 3212 A0 51 01
 Portata 300 kg (150 kg PER LATO)

CARRELLO SENZA CASSETTE E CASSETTIERE ART. **F LB B073 03 52**

ART.		Dim. mm	kg
F LB B073 54 52		725x613x1430 H	300

4 coppie profili per VISUAL BOX
 4 cassettiere **VISUAL BOX** art. FAX VB CH00 90 00 01
 6 cassettiere **VISUAL BOX** art. FAX VB CH00 60 00 01
 4 cassettiere **VISUAL BOX** art. FAX VB CH00 50 00 01
 2 cassettiere **VISUAL BOX** art. FAX VB CH00 40 00 01
 2 cassettiere **VISUAL BOX** art. FAX VB CH00 30 00 01
 Portata 300 kg (150 kg PER LATO)

CARRELLO SENZA CASSETTIERE ART. **F LB B073 04 52**



VISUAL BOX

SMART



CONFIGURA IL TUO CARRELLO

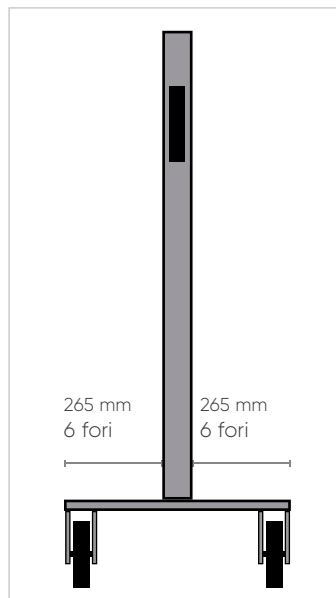

CARRELLI SMART 102 - 103

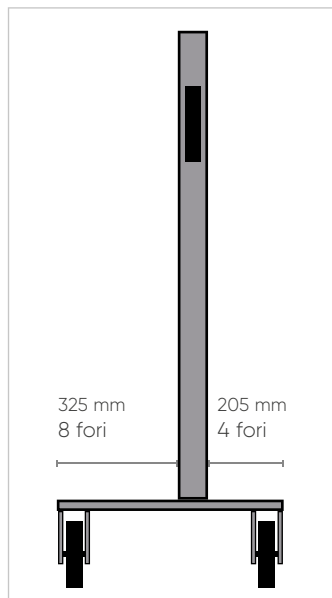

CARRELLI SMART 102

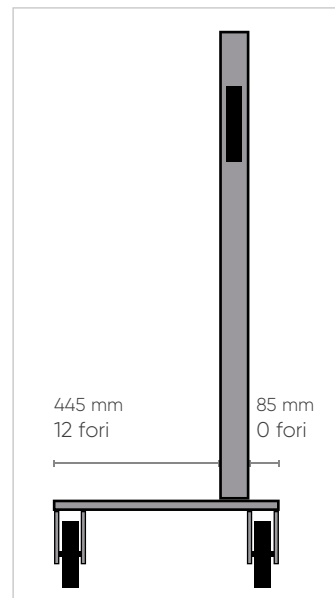

CARRELLI SMART 101 - 102

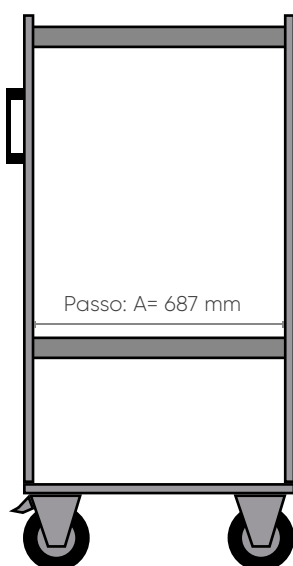

CARRELLI SMART 073

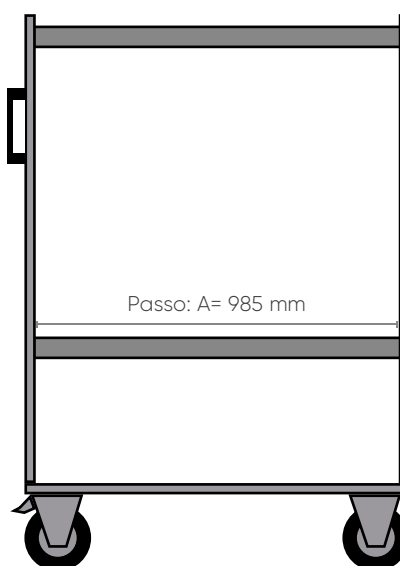

CARRELLI SMART 101 - 102 - 103

POSSIBILITÀ DI UTILIZZARE MONTANTI ALTEZZA 1772 mm

GLI ACCESSORI E I MATERIALI STOCCATI NEI CARRELLI NON DEVONO SPORGERE DALLA BASE DEL CARRELLO STESSO

A= 985 mm D= 1240 mm (32 FORI)
 B= 1023 mm E= 30 mm
 C= 160 mm



SMART 101

ART.	Dim. mm	kg
F LB B101 01 52	1023x613x1430 H	300

52
 ZINCATO + RAL7000

2 ruote girevoli con freno in gomma standard Ø 125 mm -
 2 ruote fisse in gomma standard Ø 125 mm

CARRELLO SENZA RUOTE ART. F LB 0101 01 52 (H 1270 mm)

SMART 102

ART.	Dim. mm	kg
F LB B102 01 52	1023x613x1430 H	300

52
 ZINCATO + RAL7000

2 ruote girevoli con freno in gomma standard Ø 125 mm -
 2 ruote fisse in gomma standard Ø 125 mm

CARRELLO SENZA RUOTE ART. F LB 0102 01 52 (H 1270 mm)



SMART 103

ART.	Dim. mm	kg
F LB B103 01 52	1023x613x1430 H	300

52
 ZINCATO + RAL7000

2 ruote girevoli con freno in gomma standard Ø 125 mm -
 2 ruote fisse in gomma standard Ø 125 mm

CARRELLO SENZA RUOTE ART. F LB 0103 01 52 (H 1270 mm)



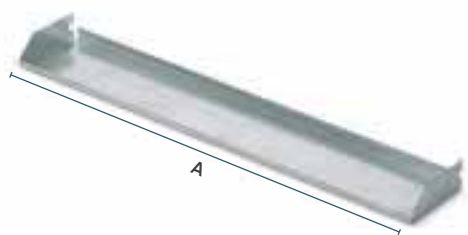

Mis. 1



SMART 101-102-103

MENSOLA FISSA LUNGHEZZA 974 mm

ART.	Profondità mm	Dim. reali mm	kg
F BL 7846 00 99	150 (A = 985)	974x170x61 H	25

Capacità: 9 contenitori COMPAT **mis. 1**
COLORE ZINCATO

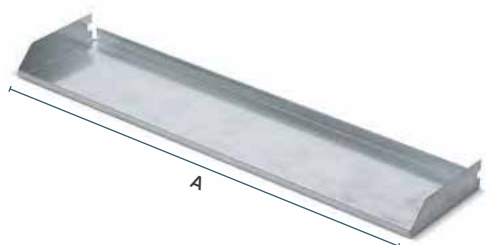

Mis. 2



SMART 101-102-103

MENSOLA FISSA LUNGHEZZA 974 mm

ART.	Profondità mm	Dim. reali mm	kg
F BL 7847 00 99	205 (A = 985)	974x230x61 H	25

Capacità: 6 contenitori COMPAT **mis. 2**
COLORE ZINCATO

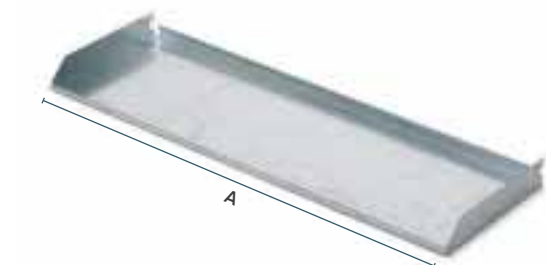

Mis. 3



Mis. 3A2



SMART 101-102-103

MENSOLA FISSA LUNGHEZZA 974 mm

ART.	Profondità mm	Dim. reali mm	kg
F BL 7848 00 99	295 (A = 985)	974x315x61 H	25

Capacità: 4 contenitori COMPAT **mis. 3A2/ mis. 3**
COLORE ZINCATO





SMART 101-102-103

PANNELLO FORATO

ART.		Lunghezza mm
------	--	--------------

F BL 7620 00 _ _ 973 (A= 985)

Predisposizione per l'aggancio ai montanti biasolati

	01		04		08		02
	RAL 7000		RAL 5012		RAL 7035		RAL 6011



SMART 101-102-103

MENSOLA INCLINABILE LUNGHEZZA 955 mm

ART.		Lunghezza mm	kg
------	--	--------------	----

F BL 7750 00 _ _ 220 (A= 985) 50

F BL 7755 00 _ _ 320 (A= 985) 50

F BL 7760 00 _ _ 420 (A= 985) 50

F BL 7762 00 _ _ 600 (A= 985) 50

	99		01		04		08		02
	ZINCATO		RAL 7000		RAL 5012		RAL 7035		RAL 6011



SMART 103

TRAVERSO DI IRRIGIDIMENTO

ART.	Dim. mm
------	---------

F BL 4505 00 01 1011 (A = 985)

Il traverso montato sotto la mensola (profondità 420/600 mm) aumenta la portata della stessa da 50 a 100 kg

	01
	RAL 7000



I carrelli serie SMART 103 hanno di serie 2 traversi di irrigidimento

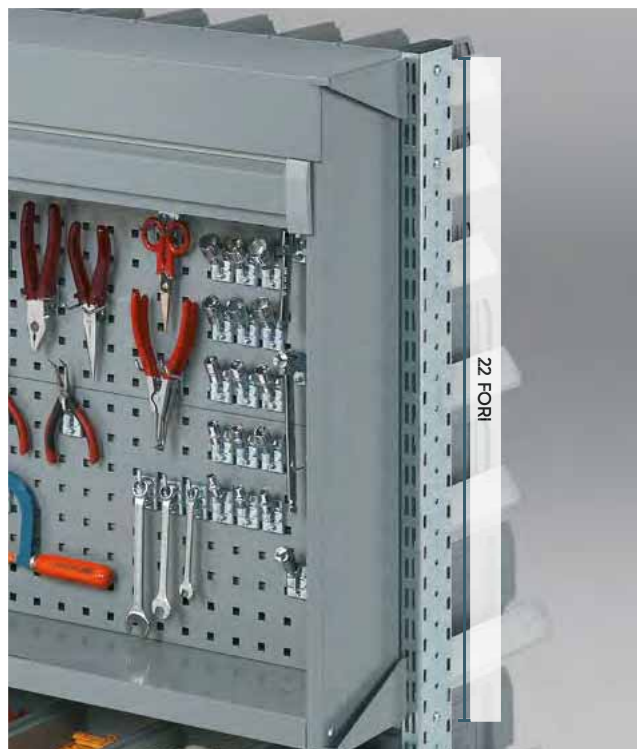

SMART 101-102-103

ARMADIO A TAPPARELLA

ART.		Profondità mm	kg
F BL 7011 02	01	190	50

PER IL FISSAGGIO AI MONTANTI BIASOLATI
 Dimensioni ingombro mm 952x210x810 H
 Dimensioni utili mm 905x150x581 H

01 04 08 02
 RAL 7000 RAL 5012 RAL 7035 RAL 6011



A= 687 mm
 B= 724 mm
 C= 160 mm
 D= 1240 mm (32 FORI)
 E= 30 mm

SMART 073

ART.	Dim. mm	kg
F LB B073 01 52	725x613x1430 H	300

52
 ZINCATO + RAL7000

2 ruote girevoli con freno in gomma standard Ø 125 mm -
 2 ruote fisse in gomma standard Ø 125 mm

CARRELLO SENZA RUOTE ART. **F LB 0073 01 52** (H 1270 mm)

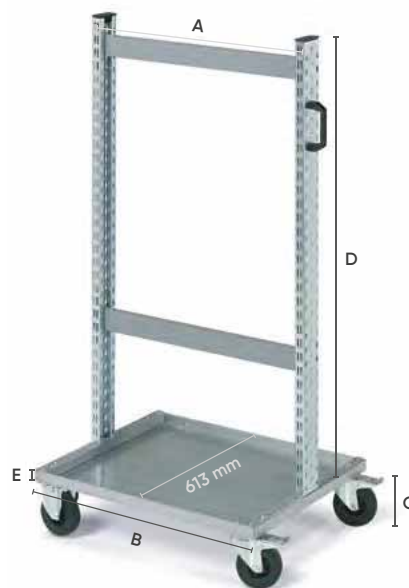

TRAVERSO DI IRRIGIDIMENTO

ART.	Dim. mm
F BL 4500 00 01	703 (A = 687)

Il traverso montato sotto la mensola (profondità 420/600 mm) aumenta la portata della stessa da 50 a 100 kg

01
 RAL 7000



I carrelli serie SMART 073 hanno di serie 2 traversi di irrigidimento



MENSOLA INCLINABILE LUNGHEZZA 657 mm

ART.	Lunghezza mm	kg
F BL 7820 00 _ _	220 (A= 687)	50
F BL 7830 00 _ _	420 (A= 687)	50

ZINCATO 99 RAL 7000 01 RAL 5012 04 RAL 7035 08 RAL 6011 02





CASSETTIERA PRACTIBOX

ART.	dim. mm	
FP PR 9077 000 00 01	600x69x77 H	

Cassettiera a 9 cassette



CASSETTIERA PRACTIBOX

ART.	dim. mm	
FP PR 6112 000 00 01	600x98x112 H	

Cassettiera a 6 cassette



CASSETTIERA PRACTIBOX

ART.	dim. mm	
FP PR 5164 000 00 01	600x141x164 H	

Cassettiera a 5 cassette



CASSETTIERA PRACTIBOX

ART.	dim. mm	
FP PR 4206 000 00 01	600x174x206 H	

Cassettiera a 4 cassette



CASSETTIERA PRACTIBOX

ART.	dim. mm	
FP PR 3240 000 00 01	600x209x240 H	

Cassettiera a 3 cassette





COPPIA PROFILI PER PRACTIBOX

ART.	Lunghezza mm	
F BL 4430 00 01	1200 (A= 687)	

Per un lato del carrello

01
RAL 7000



COPPIA PROFILI PARZIALI PER PRACTIBOX

ART.	H mm	
F BL 4425 00 52	280 (A= 687)	

Completi di supporto inferiore per un lato del carrello

52
ZINCATO+ RAL 7000



SMART 101-102-103

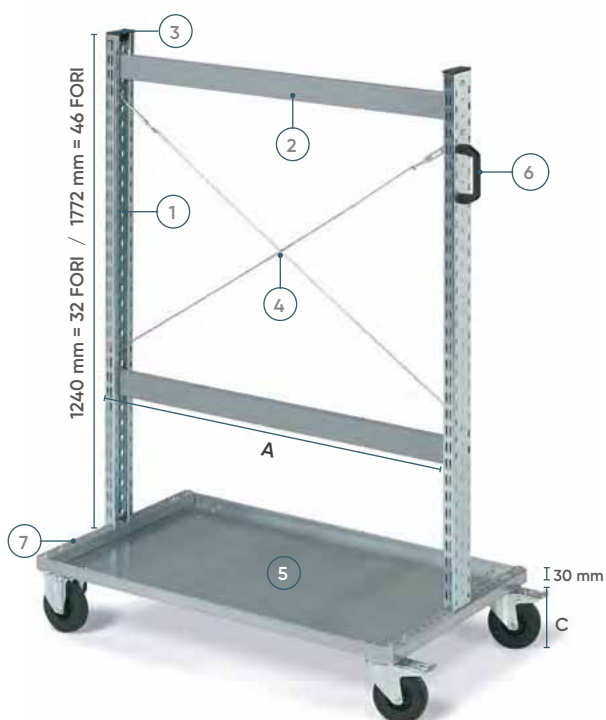

SMART 073

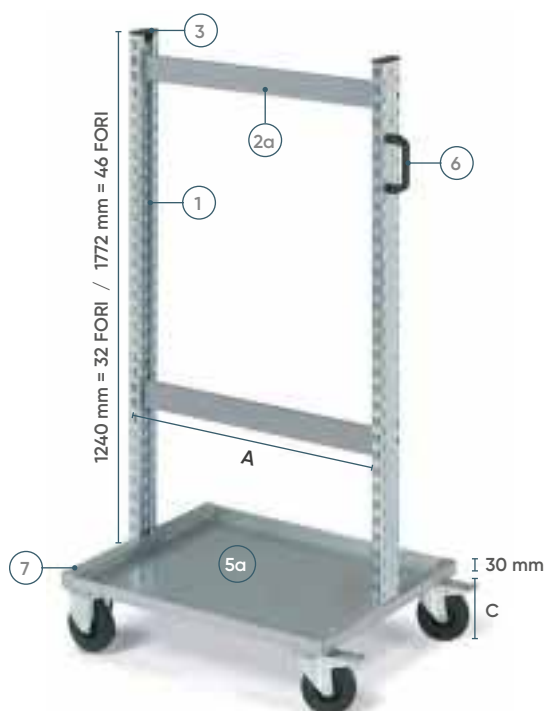

1 MONTANTE BIASOLATO

ART.	H mm
F BL 7540 01 _ _	1240
F BL 7547 01 _ _	1772



4 CROCIERA

ART.	MODULO mm
F BL 4705 00 99	A=985 / H=1240
F BL 4720 00 99	A=985 / H=1772



2 TRAVERSO DI IRRIGIDIMENTO

ART.	H mm
F BL 4505 00 01	1010 (A=985)



5a BASE

ART.	Dimensioni mm
F BL 4400 00 99	725x613x30 H (A=687)



2a TRAVERSO DI IRRIGIDIMENTO

ART.	H mm
F BL 4500 00 01	712 (A=687)



6 MANIGLIA

ART.
F BL 4415 00 07

COLORE NERO

3 COPPIA TAPPI

ART.
F BL 4420 00 07

COLORE NERO

7 TRAVERSO BASE

ART.	Dimensioni mm
F BL 4410 00 01	604x30x30 H



5 BASE

ART.	Dimensioni mm
F BL 4405 00 99	1023x613x30 H (A=985)



RUOTA GIREVOLE CON FRENO IN GOMMA STANDARD

ART.	Ø mm	C mm	
C RG DAC12 125	125	160	
C RG DAC13 150	150	185	



RUOTA FISSA IN GOMMA STANDARD

ART.	Ø mm	C mm	
C RG BAC12 125	125	160	
C RG BAC13 150	150	185	



RUOTA GIREVOLE CON FRENO IN GOMMA ANTISTRACCIATA SINTETICA

ART.	Ø mm	C mm	
C RG DPH22 125	125	160	



RUOTA FISSA IN GOMMA ANTISTRACCIATA SINTETICA

ART.	Ø mm	C mm	
C RG BPH22 125	125	160	



RUOTA GIREVOLE CON FRENO IN GOMMA ELASTICA

ART.	Ø mm	C mm	
C RG DCE15 125	125	160	



RUOTA FISSA IN GOMMA ELASTICA

ART.	Ø mm	C mm	
C RG BCE15 125	125	160	



RUOTA GIREVOLE CON FRENO IN POLIURETANO

ART.	Ø mm	C mm	
C RN DDD31 125	125	160	



RUOTA FISSA IN POLIURETANO

ART.	Ø mm	C mm	
C RN BDD31 125	125	160	



RUOTA GIREVOLE CON FRENO IN NYLON

ART.	Ø mm	C mm	
C RN DAD10 100	100	130	
C RN DAD11 125	125	160	



RUOTA FISSA IN NYLON

ART.	Ø mm	C mm	
C RN BAD10 100	100	130	
C RN BAD11 125	125	160	



**SCAFFALI PER PICCOLI E
GRANDI CONTENITORI
NON SOLO MENSOLE
MA ACCESSORI DIVERSIFICATI
PER TRASFORMARLI IN
PARETI ATTREZZATE**



SLICK

CARATTERISTICHE TECNICHE

Integrando lo scaffale serie Slick alla comune struttura composta da mensole, cassette, contenitori e accessori, si possono realizzare molteplici varianti personalizzate ed esclusive.



TELAIO

Lo scaffale serie Slick è disponibile con altezza 1817 H con due diverse presentazioni: con il telaio bifronte base con crociera (dove possono essere inserite mensole ambo i lati) e con telaio monofronte con crociera (dove possono essere inserite mensole solo lungo il lato del piede).



MENSOLE

Le mensole inclinabili per scaffali slick con lunghezza 955 mm passo 985 mm possono essere di 4 profondità mm 220 - 320 - 420 - 600.

Oltre alle mensole inclinate il carrello è configurabile anche con mensole fisse per contenitori, entrambi di diverse profondità.

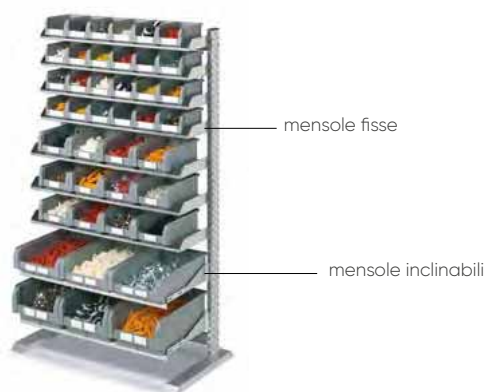

CASSETTE/CONTENITORI

Il traverso forato base permette la regolazione dei montanti e l'inserimento di diverse tipologie di contenitori PICKING BOX mis. 1/2/3/3A2/4/4A2 e cassette serie EURO BOX.



PICKING BOX



EURO BOX

ACCESSORI

Per sfruttare al meglio gli spazi dello scaffale sono opzionabili accessori quali il pannello forato utilizzato per l'aggancio di utensili industriali e pannello non forato a cui appendere calamite, l'armadio a persiana, la scatola porta prese e le canalette con prese cablate.





● ART. F LC C173 54 52
H = 1813 mm

Gamma colori
ACCIAIO 

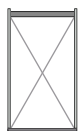

ZINCATO +
GRIGIO RAL 7000
.52

FORNITI SMONTATI
OBBLIGO DI FISSAGGIO A PAVIMENTO O A PARETE

LEGENDA



PORTATA
SCAFFALE



LE PORTATE SONO NETTE E SI RIFERISCONO A PESI UNIFORMEMENTE DISTRIBUITI.



ART.		Dim. mm	kg
F LC C173 52 52		1065x542x1813	150

7 mensole per mis. 1 - 6 mensole per mis. 2
63 contenitori PICKING BOX **mis. 1** art. FAX PB C001 A0 51 01
36 contenitori PICKING BOX **mis. 2** art. FAX PB C002 A0 51 01

SCAFFALE SENZA CONTENITORI ART. **F LC C173 02 52**

ART.		Dim. mm	kg
F LC A173 52 52		1065x925x1813	300

14 mensole per mis. 1 - 12 mensole per mis. 2
126 contenitori PICKING BOX **mis. 1** art. FAX PB C001 A0 51 01
72 contenitori PICKING BOX **mis. 2** art. FAX PB C002 A0 51 01
Portata 300 kg (150 kg PER LATO)

SCAFFALE SENZA CONTENITORI ART. **F LC A173 02 52**



ART.		Dim. mm	kg
F LC C173 54 52		1065x542x1813	150

4 mensole per mis. 2 - 3 mensole per mis. 3A2 - 2 mensole profondità 420 mm (A=985 mm)
24 contenitori PICKING BOX **mis. 2** art. FAX PB C002 A0 51 01
12 contenitori PICKING BOX **mis. 3A2** art. FAX PB C3A2 B0 51 01
3 contenitori PICKING BOX **mis. 4A2** art. FAX PB C4A2 B0 51 01
3 contenitori PICKING BOX **mis. 4** art. FAX PB C004 B0 51 01

SCAFFALE SENZA CONTENITORI ART. **F LC C173 04 52**

ART.		Dim. mm	kg
F LC A173 54 52		1065x925x1813	300

8 mensole per mis. 2 - 6 mensole per mis. 3A2 - 4 mensole profondità 420 mm (A=985 mm)
48 contenitori PICKING BOX **mis. 2** art. FAX PB C002 A0 51 01
24 contenitori PICKING BOX **mis. 3A2** art. FAX PB C3A2 B0 51 01
6 contenitori PICKING BOX **mis. 4A2** art. FAX PB C4A2 B0 51 01
6 contenitori PICKING BOX **mis. 4** art. FAX PB C004 B0 51 01
Portata 300 kg (150 kg PER LATO)

SCAFFALE SENZA CONTENITORI ART. **F LC A173 04 52**



ART.		Dim. mm	
F LC C173 53 52		1065x542x1813	150

5 mensole per mis. 1 - 5 mensole per mis. 2 - 2 mensole per mis. 3A2
 45 contenitori PICKING BOX **mis. 1** art. FAX PB C001 A0 51 01
 30 contenitori PICKING BOX **mis. 2** art. FAX PB C002 A0 51 01
 8 contenitori PICKING BOX **mis. 3A2** art. FAX PB C3A2 B0 51 01

SCAFFALE SENZA CONTENITORI ART. **F LC C173 03 52**



ART.		Dim. mm	
F LC A173 53 52		1065x925x1813	300

10 mensole per mis. 1 - 10 mensole per mis. 2 - 4 mensole per mis. 3A2
 90 contenitori PICKING BOX **mis. 1** art. FAX PB C001 A0 51 01
 60 contenitori PICKING BOX **mis. 2** art. FAX PB C002 A0 51 01
 16 contenitori PICKING BOX **mis. 3A2** art. FAX PB C3A2 B0 51 01
 Portata 300 kg (150 kg PER LATO)

SCAFFALE SENZA CONTENITORI ART. **F LC A173 03 52**



ART.		Dim. mm	
F LC C173 51 52		1065x542x1813	150

5 mensole profondità 420 mm (A=985 mm)
 9 cassette **EURO BOX** art. FAX EB 4317 A0 51 01
 3 cassette **EURO BOX** art. FAX EB 6417 A0 51 01

SCAFFALE SENZA CASSETTE ART. **F LC C173 01 52**



ART.		Dim. mm	
F LC A173 51 52		1065x925x1813	300

10 mensole profondità 420 mm (A=985 mm)
 18 cassette **EURO BOX** art. FAX EB 4317 A0 51 01
 6 cassette **EURO BOX** art. FAX EB 6417 A0 51 01
 Portata 300 kg (150 kg PER LATO)

SCAFFALE SENZA CASSETTE ART. **F LC A173 01 52**



**STRUTTURA MODULARE
PER CONTENITORI
E CASSETTE SERIE:
EURO BOX, EURO BOX LIGHT,
PICKING BOX, STORAGE BOX**





SYSTEM TR

CARATTERISTICHE TECNICHE

Adatta all'inserimento delle cassette/contenitori in PP serie EURO BOX, EURO BOX LIGHT, PICKING BOX e STORAGE BOX e delle cassette/contenitori in ferro Steel, la scaffalatura serie F TR è disponibile in due diverse altezze:

-1010 mm

-2010 mm

La coppia guide che sostiene la cassetta/contenitore è regolabile in altezza, ha una portata massima di 50 kg, e permette l'utilizzo contemporaneo di cassette/contenitori della stessa dimensione ma con altezze diverse.

La portata della campata è di 250 kg.

La modularità del sistema consente in qualsiasi momento eventuali ampliamenti degli impianti esistenti.



PIANO DI TENUTA SUPERIORE

I piani vengono fissati nella parte superiore di ogni campata e, oltre ad irrobustire la scaffalatura, svolgono una funzione parapolvere e di appoggio.



COPPIA GUIDE

Le guide per lo scorrimento delle cassette vengono agganciate ai montanti e fissate tramite l'apposita clip. Regolabili in altezza.

PORTATA 50 kg



FIANCATE

Le fiancate vengono fornite montate, hanno una fessurazione laterale con passo 25 mm e sono accessoriate con piedini predisposti per il fissaggio a terra.

PORTATA CAMPATA 250 kg



COPPIA ZOCCOLI DI TENUTA

Gli zoccoli vengono fissati con quattro viti autofilettanti ai montanti delle fiancate per conferire maggiore stabilità alla struttura.



SYSTEM TR



PER CASSETTE
300x200 mm



EURO BOX

● **ART. F TR S200 A2 99**

H = 2010 mm

12 art. FAX EB 3212 AO 51 01,18 art. FAX EB 3217 AO 51 01

Gamma colori
ACCIAIO

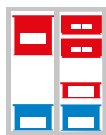

ZINCATO
.99



DISPONIBILE IN DUE DIVERSE ALTEZZE

SET DI FISSAGGIO A PAVIMENTO

ART. F NC 8999 00 99



Materiale di fissaggio composto da 2 viti ad espansione in acciaio M8x75 mm per pavimenti in calcestruzzo non fessurato uguali o maggiori alla classe: C20/25.

OBBLIGO DI FISSAGGIO A TERRA

LEGENDA



PORTATA
PER CAMPATA



LE PORTATE SONO NETTE E SI RIFERISCONO A PESI UNIFORMEMENTE DISTRIBUITI.

CONFIGURA LA TUA SCAFFALATURA

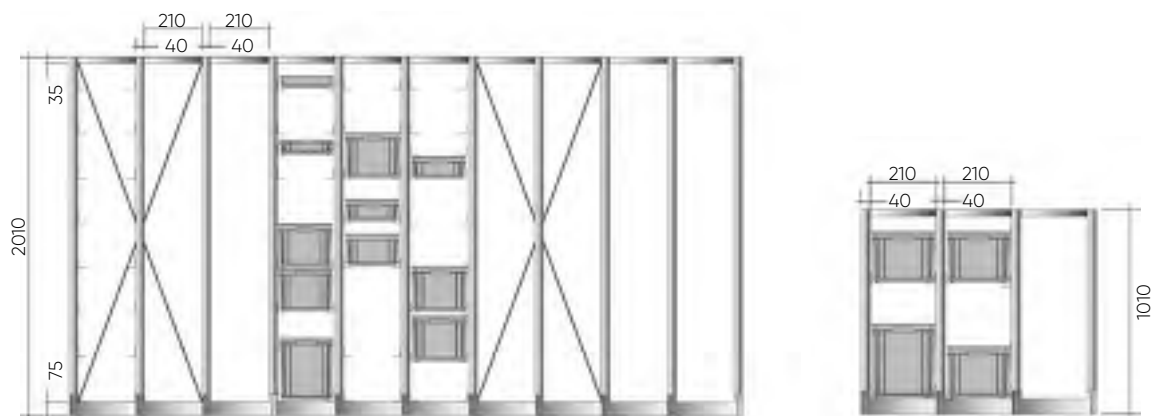

PROFONDITA' SCAFFALE 300 mm

ALTEZZA UTILE INSERIMENTO 1900 mm

ALTEZZA UTILE INSERIMENTO 900 mm

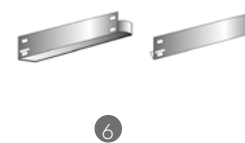
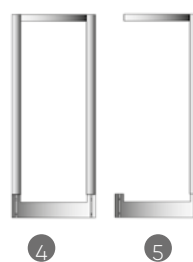
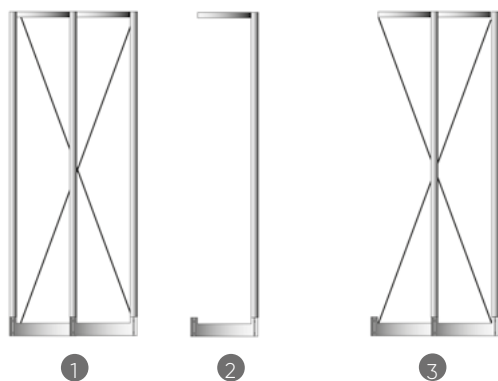

ART.	Tipo di campata mm	kg
1	F TR D200 30 99 Campata base doppia con crociera 2010 H	250
2	F TR E200 30 99 Campata aggiuntiva singola 2010 H	250
3	F TR F200 30 99 Campata aggiuntiva doppia con crociera 2010 H	250
4	F TR G100 30 99 Campata base singola 1010 H	250
5	F TR E100 30 99 Campata aggiuntiva singola 1010 H	250
6	F TR 9000 00 99 Coppia guide zincate	50

Le crociere di irrigidimento sono realizzate in lamiera zincata. Per la stabilità delle scaffalature 2000 mm H è necessario installare una crociera ogni 6 campate.

dim. mm	passo guide
300x200x120 H	150 mm
300x200x170 H	200 mm
300x200x147,5 H	175 mm

CASSETTE
(EURO BOX)

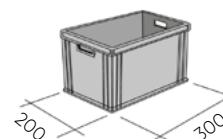

SYSTEM TR



PER CASSETTE
400x300 mm



EURO BOX

● **ART. F TR S200 B1 99**

H = 2010 mm

9 art. FAX EB 4317 A0 51 01, 18 art. FAX EB 4308 A0 51 01

5 art. FAX EB 4332 B0 51 01, 12 art. FAX EB 4312 A0 51 01

Gamma colori
ACCIAIO

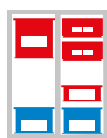

ZINCATO
.99



DISPONIBILE IN DUE DIVERSE ALTEZZE

SET DI FISSAGGIO A PAVIMENTO

ART. F NC 8999 00 99



Materiale di fissaggio composto da 2 viti ad espansione in acciaio M8x75 mm per pavimenti in calcestruzzo non fessurato uguali o maggiori alla classe: C20/25.

OBBLIGO DI FISSAGGIO A TERRA

LEGENDA



PORTATA
PER CAMPATA



LE PORTATE SONO NETTE E SI RIFERISCONO A PESI UNIFORMEMENTE DISTRIBUITI.

CONFIGURA LA TUA SCAFFALATURA

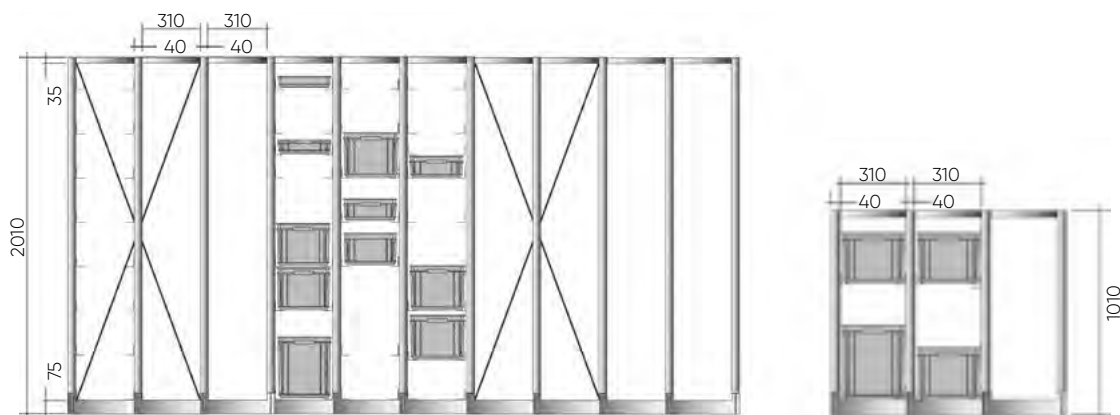

PROFONDITA' SCAFFALE 400 mm

ALTEZZA UTILE INSERIMENTO 1900 mm

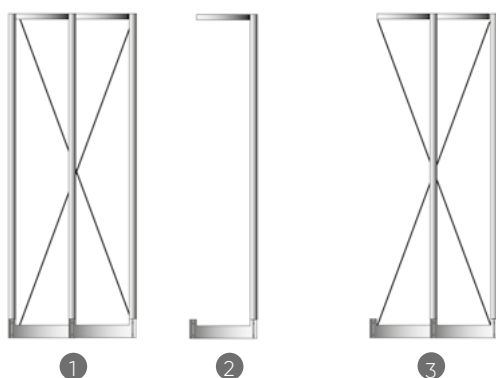

ALTEZZA UTILE INSERIMENTO 900 mm

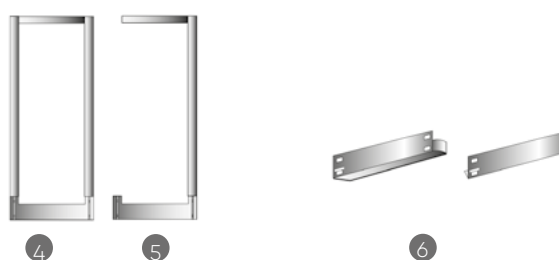

ART.	Tipo di campata mm		kg
1	F TR D200 40 99	Campata base doppia con crociera 2010 H	250
2	F TR E200 40 99	Campata aggiuntiva singola 2010 H	250
3	F TR F200 40 99	Campata aggiuntiva doppia con crociera 2010 H	250
4	F TR G100 40 99	Campata base singola 1010 H	250
5	F TR E100 40 99	Campata aggiuntiva singola 1010 H	250
6	F TR 9040 00 99	Coppia guide zincate	50

Le crociere di irrigidimento sono realizzate in lamiera zincata. Per la stabilità delle scaffalature 2000 mm H è necessario installare una crociera ogni 6 campate.

dim. mm	passo guide
400x300x55 H	75 mm
400x300x78 H	100 mm
400x300x120 H	150 mm
400x300x170 H	200 mm
400x300x220 H	250 mm
400x300x325 H	350 mm

CASSETTE
(EURO BOX)



SYSTEM TR



PER CASSETTE
600x400 mm



EURO BOX

● **ART. F TR S200 C1 99**

H = 2010 mm

18 art. FAX EB 6412 A0 51 01, 11 art. FAX EB 6422 B0 51 01

Gamma colori
ACCIAIO

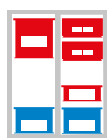

ZINCATO
.99



DISPONIBILE IN DUE DIVERSE ALTEZZE

SET DI FISSAGGIO A PAVIMENTO

ART. F NC 8999 00 99



Materiale di fissaggio composto da 2 viti ad espansione in acciaio M8x75 mm per pavimenti in calcestruzzo non fessurato uguali o maggiori alla classe: C20/25.

OBBLIGO DI FISSAGGIO A TERRA

LEGENDA



PORTATA
PER CAMPATA



LE PORTATE SONO NETTE E SI RIFERISCONO A PESI UNIFORMEMENTE DISTRIBUITI.

CONFIGURA LA TUA SCAFFALATURA

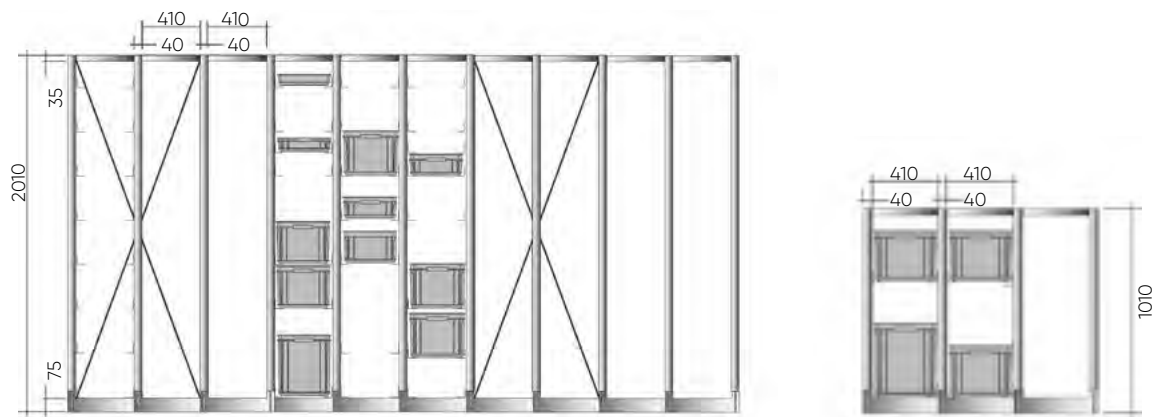

PROFONDITA' SCAFFALE 600 mm

ALTEZZA UTILE INSERIMENTO 1900 mm

ALTEZZA UTILE INSERIMENTO 900 mm

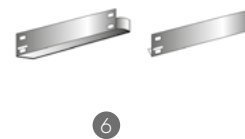
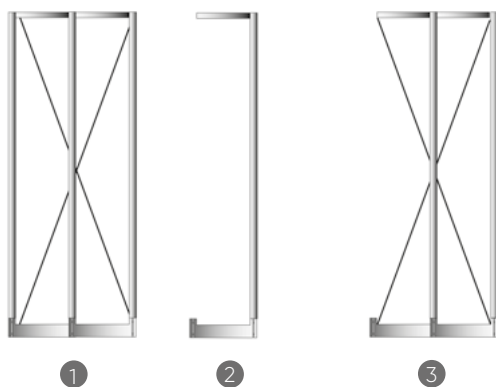

ART.	Tipo di campata mm	kg
1	FTRD200 60 99 Campata base doppia con crociera 2010 H	250
2	FTR E200 60 99 Campata aggiuntiva singola 2010 H	250
3	FTR F200 60 99 Campata aggiuntiva doppia con crociera 2010 H	250
4	FTR G100 60 99 Campata base singola 1010 H	250
5	FTR E100 60 99 Campata aggiuntiva singola 1010 H	250
6	FTR 9080 00 99 Coppia guide zincate	50

Le crociere di irrigidimento sono realizzate in lamiera zincata. Per la stabilità delle scaffalature 2000 mm H è necessario installare una crociera ogni 6 campate.

dim. mm	passo guide
600x400x78 H	100 mm
600x400x120 H	150 mm
600x400x170 H	200 mm
600x400x220 H	250 mm
600x400x285 H	325 mm
600x400x325 H	350 mm
600x400x430 H	450 mm

CASSETTE
(EURO BOX)



SYSTEM TR



PER CASSETTE
350/300x200 mm



PICKING BOX



STORAGE BOX

● **ART. F TR S200 D1 99**

H= 2010 mm

10 art. FAX PB C3A2 B0 51 03, 10 art. FAX PB C3A2 B0 51 04,
10 art. FAX PB C3A2 B0 51 02, 10 art. FAX PB C003 B0 51 05,
10 art. FAX PB C003 B0 51 03

Gamma colori
ACCIAIO

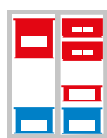

ZINCATO
.99



DISPONIBILE IN DUE DIVERSE ALTEZZE

CONFIGURA LA TUA SCAFFALATURA DA PAG. B157

SET DI FISSAGGIO A PAVIMENTO

ART. F NC 8999 00 99



Materiale di fissaggio composto da 2 viti ad espansione in acciaio M8x75 mm per pavimenti in calcestruzzo non fessurato uguali o maggiori alla classe: C20/25.

OBBLIGO DI FISSAGGIO A TERRA

LEGENDA



PORTATA
PER CAMPATA



LE PORTATE SONO NETTE E SI RIFERISCONO A PESI UNIFORMEMENTE DISTRIBUITI.

CONFIGURA LA TUA SCAFFALATURA

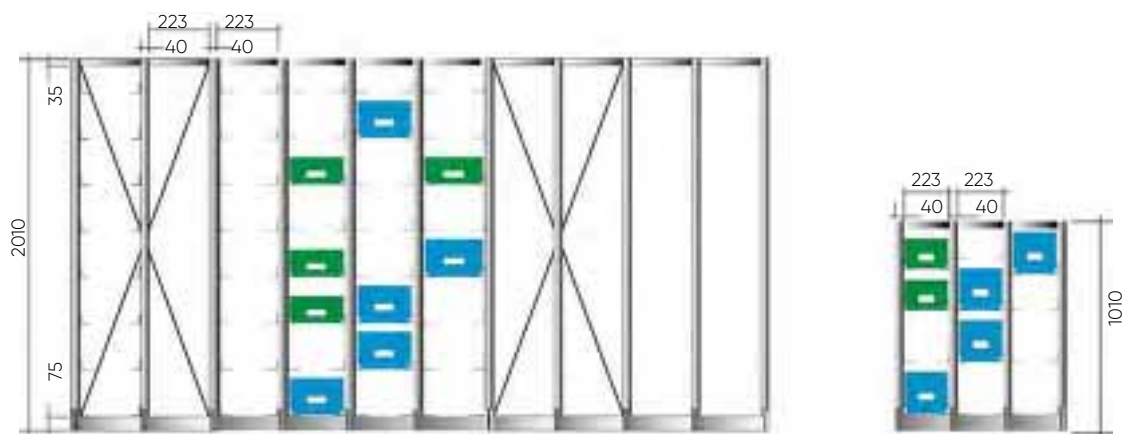

PROFONDITA' SCAFFALE 350 mm

ALTEZZA UTILE INSERIMENTO 1900 mm

ALTEZZA UTILE INSERIMENTO 900 mm

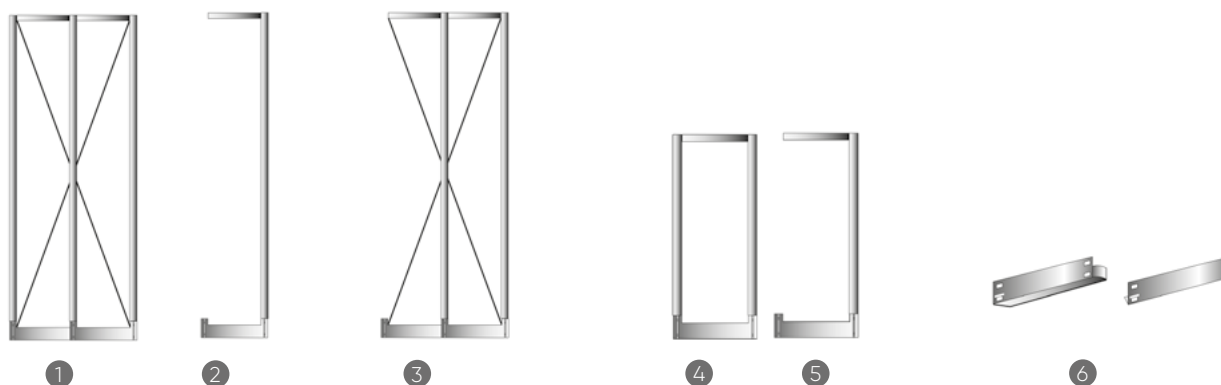

ART.	Tipo di campata mm	kg
1	F TR D200 35 99 Campata base doppia con crociera 2010 H	250
2	F TR E200 35 99 Campata aggiuntiva singola 2010 H	250
3	F TR F200 35 99 Campata aggiuntiva doppia con crociera 2010 H	250
4	F TR G100 35 99 Campata base singola 1010 H	250
5	F TR E100 35 99 Campata aggiuntiva singola 1010 H	250
6	F TR 9020 00 99 Coppia guide zincate	50

Le crociere di irrigidimento sono realizzate in lamiera zincata. Per la stabilità delle scaffalature 2000 mm H è necessario installare una crociera ogni 6 campate.

rif.	passo guide
mis. 3A2	175 mm
mis. 3	225 mm
mis. 272-3A2	175 mm
mis. 272-3	225 mm

CASSETTE E
CONTENITORI
(PICKING BOX)

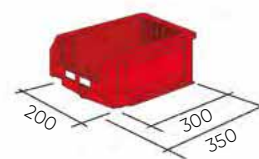

(STORAGE BOX)

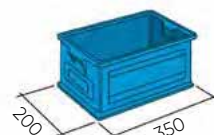

SYSTEM TR



● **ART. F TR S200 E2 99**

H = 2010 mm

8 art. FAX PB C004B0 51 02, 8 art. FAX PB C004B0 51 03,
8 art. FAX PB C004B0 51 04, 8 art. FAX PB C004B0 51 05

PER CASSETTE
500/450x300 mm



PICKING BOX



STORAGE BOX

Gamma colori
ACCIAIO

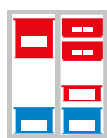

ZINCATO
.99



DISPONIBILE IN DUE DIVERSE ALTEZZE

SET DI FISSAGGIO A PAVIMENTO

ART. F NC 8999 00 99



Materiale di fissaggio composto da 2 viti ad espansione in acciaio M8x75 mm per pavimenti in calcestruzzo non fessurato uguali o maggiori alla classe: C20/25.

OBBLIGO DI FISSAGGIO A TERRA

LEGENDA



PORTATA
PER CAMPATA



LE PORTATE SONO NETTE E SI RIFERISCONO A PESI UNIFORMEMENTE DISTRIBUITI.

CONFIGURA LA TUA SCAFFALATURA

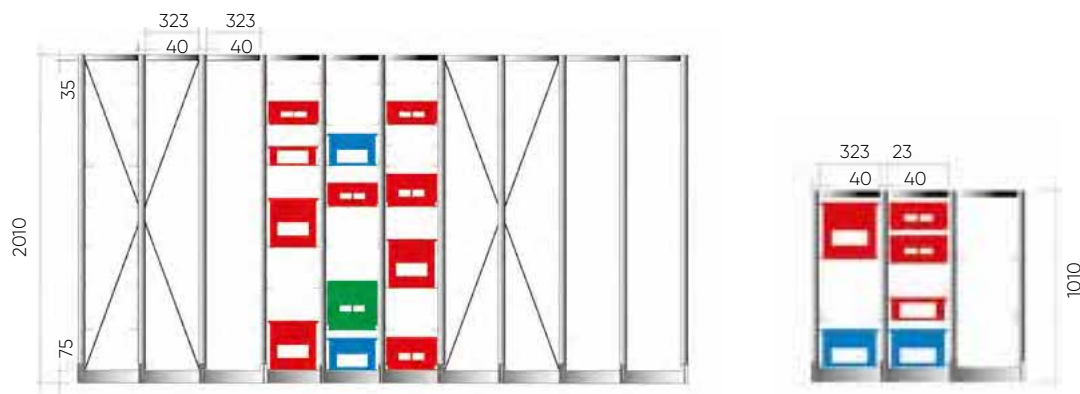

PROFONDITA' SCAFFALE 500 mm

ALTEZZA UTILE INSERIMENTO 1900 mm

ALTEZZA UTILE INSERIMENTO 900 mm

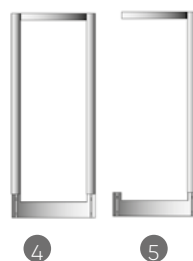
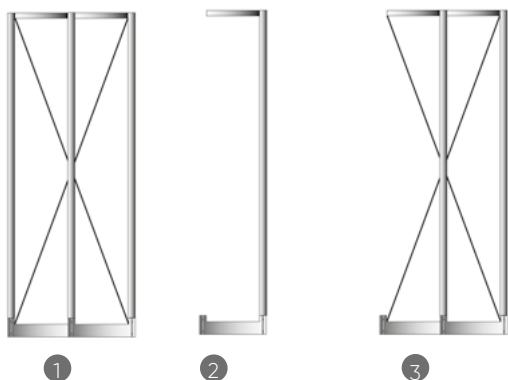

ART.	Tipo di campata mm	kg
1	F TR D200 50 99 Campata base doppia con crociera 2010 H	250
2	F TR E200 50 99 Campata aggiuntiva singola 2010 H	250
3	F TR F200 50 99 Campata aggiuntiva doppia con crociera 2010 H	250
4	F TR G100 50 99 Campata base singola 1010 H	250
5	F TR E100 50 99 Campata aggiuntiva singola 1010 H	250
6	F TR 9060 00 99 Coppia guide zincate	50

Le crociere di irrigidimento sono realizzate in lamiera zincata. Per la stabilità delle scaffalature 2000 mm H è necessario installare una crociera ogni 6 campate.

rif.	passo guide
mis. 4A2	200 mm
mis. 4	225 mm
mis. 4A5	325 mm
mis. 272-4A2	150 mm
mis. 272-4	225 mm
mis. 272-4A5	325 mm

CASSETTE E
CONTENITORI

(PICKING BOX)

(STORAGE BOX)

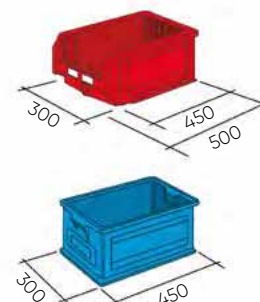

SYSTEM TR

219 GIARRE-IMPER.

263 SHERALDO

203 SIMIUS
207 BLUETTE
208 OTTANIO
215 ZAFFIRO
M215 LOTUS
218 AVIO

LAMPO FISSA
INVISIBILE
cm. 20

282 SPAGO-BAMBU
290 CAST. - LAND
293 WOOD - NUT

LAMPO FISSA
INVISIBILE
cm. 20

284 MARRONE
297 CALLA
300 ACCIAIO
308 TEA TREE

CERNIERA
cm 10
SPIRALE

BIANCO
MARRONE

LAMPO INVISIBILE
CM. 25

810 TERRA
820 ROSSO
863 MALVA
841 BURRO
919 BLU-NAVY

LAMPO SP-Arg.V.
SPIR. FISSA + DIV.
N7001#410000
FISSA
7002000005
DIV.

Mod.: LELLA
DIV. cm 62
FISSA cm. 74-8
COL. 629-245-330
M2

CERNIERA
cm 16
MET. 4

BIANCO
MARRONE



**MODULI SALDATI
AD ALVEARE PER
CONTENITORI IN
PLASTICA E ACCIAIO
SOVRAPPONIBILI CON
FERMO ANTICADUTA**

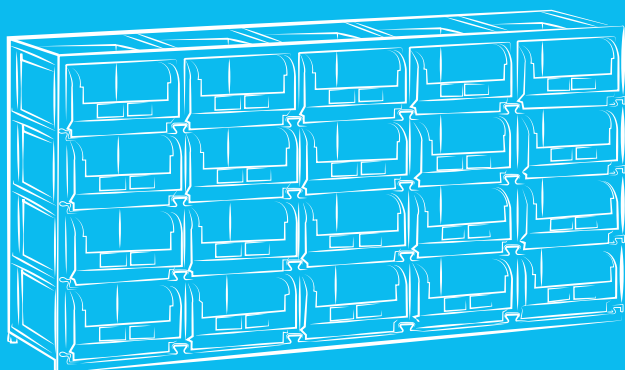



Per gentile concessione di Vimar S.p.A.

STORAGE DOMINO

CARATTERISTICHE TECNICHE

La grande esperienza acquisita in molti anni di attività nel ramo del magazzinaggio e della logistica, ci hanno portato alla realizzazione degli scaffali porta contenitori DOMINO. Sovrapponibili, permettono di realizzare veri e propri magazzini, con soluzioni personalizzate che si sviluppano in altezza e larghezza a seconda delle necessità.

Vengono costruiti per 4 misure di cassette o contenitori, in robusta lamiera di acciaio profilata, che consente notevole robustezza anche a pieno carico. La sovrapposizione degli scaffali e la loro modularità, permette di realizzare dei magazzini che possono essere modificati in ogni momento a seconda delle necessità.



COPERCHIO PARAPOLVERE E PIANO DI LAVORO

L'applicazione del coperchio parapolvere e del piano di lavoro permette, non solo una maggiore protezione dei materiali, ma anche la realizzazione di comodi e pratiche postazioni per la distribuzione dei materiali.



ZOCCOLO

Lo zoccolo rialza lo scaffale da terra di 85 mm, lo isola dal pavimento ed evita che l'ultima fila di cassette/contenitori tocchi terra durante l'estrazione.



PICKING
BOX

STORAGE
BOX

CONTENITORI

L'estrazione singola della cassetta/contenitore avviene in modo semplice e rapido ed un apposito gancio, posto anteriormente sulle guide, impedisce la fuoriuscita totale ed accidentale.

Gamma colori
ACCIAIO



RAL 7000
.01



LE PORTATE SONO NETTE E SI RIFERISCONO A PESI UNIFORMEMENTE DISTRIBUITI.

STORAGE DOMINO



ART.		dim. mm	
F ED 3044 00 01		1025x310x885 H	

Qtà max di contenitori in metallo o polipropilene inseribili:
16 pezzi mis. 3

Adatta per contenitori PICKING BOX:



mis. 3



SOVRAPPONIBILITA'

TELAI SOVRAPPOSTI	Portata di ogni telaio	Portata di ogni box	
2	960 kg	60 kg	
max 3	640 kg	40 kg	

■ Scaffale fornito senza contenitori



ART.		dim. mm	
F ED 3074 00 01		1765x310x885 H	

Qtà max di contenitori in metallo o polipropilene inseribili:
28 pezzi mis. 3

Adatta per contenitori PICKING BOX:



mis. 3

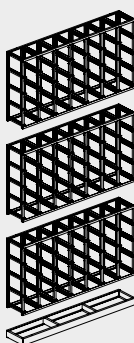

SOVRAPPONIBILITA'

TELAI SOVRAPPOSTI	Portata di ogni telaio	Portata di ogni box	
2	1680 kg	60 kg	
max 3	1120 kg	40 kg	

■ Scaffale fornito senza contenitori



ART.		dim. mm	
F ED 4034 00 01		1075x460x885 H	

Qtà max di contenitori in metallo o polipropilene inseribili:
12 pezzi mis. 4

Adatta per contenitori PICKING BOX/STORAGE BOX:



mis. 4



mis. 272-4



SOVRAPPONIBILITA'

TELAI SOVRAPPOSTI	Portata di ogni telaio	Portata di ogni box	
max 3	1200 kg	100 kg	

■ Scaffale fornito senza contenitori



ART.		dim. mm	
F ED 4054 00 01		1765x460x885 H	

Q.tà max di contenitori in metallo o polipropilene inseribili:
20 pezzi mis. 4

Adatta per contenitori PICKING BOX/STORAGE BOX:



ART.		dim. mm	
F ED 4056 00 01		1765x460x1300 H	

Q.tà max di contenitori in metallo o polipropilene inseribili:
30 pezzi mis. 4

Adatta per contenitori PICKING BOX/STORAGE BOX:



ART.		dim. mm	
F ED 4555 00 01		1765x460x1300 H	

Q.tà max di contenitori in metallo o polipropilene inseribili:
20 pezzi mis. 4A5

Adatta per contenitori PICKING BOX/STORAGE BOX:



SOVRAPPONIBILITA'

TELAII SOVRAPPOSTI	Portata di ogni telaio	Portata di ogni box	
max 3	1600 kg	80 kg	

■ Scaffale fornito senza contenitori

SOVRAPPONIBILITA'

TELAII SOVRAPPOSTI	Portata di ogni telaio	Portata di ogni box	
2	2400 kg	80 kg	
max 3	1500 kg	50 kg	

■ Scaffale fornito senza contenitori

SOVRAPPONIBILITA'

TELAII SOVRAPPOSTI	Portata di ogni telaio	Portata di ogni box	
2	1600 kg	80 kg	
max 3	1000 kg	50 kg	

■ Scaffale fornito senza contenitori

STORAGE DOMINO



ART.		dim. mm
F ED 5023 00 01		1125x660x1180 H

Q.tà max di contenitori in metallo o polipropilene inseribili :
6 pezzi mis. 5

Adatta per contenitori PICKING BOX/STORAGE BOX:



mis. 5



mis. 272-5

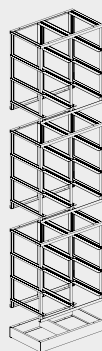

SOVRAPPONIBILITA'

TELAI SOVRAPPOSTI	Portata di ogni telaio	Portata di ogni box
max 3	1200 kg	200 kg

■ Scaffale fornito senza contenitori



ART.		dim. mm
F ED 5033 00 01		1670x660x1180 H

Q.tà max di contenitori in metallo o polipropilene inseribili :
9 pezzi mis. 5

Adatta per contenitori PICKING BOX/STORAGE BOX:



mis. 5



mis. 272-5

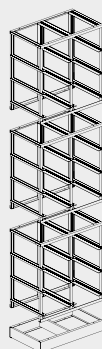

SOVRAPPONIBILITA'

TELAI SOVRAPPOSTI	Portata di ogni telaio	Portata di ogni box
max 3	1800 kg	200 kg

■ Scaffale fornito senza contenitori



COPERCHIO PARAPOLVERE



ART.	PER SCAFFALE	dim. mm
F ED 9034 00 01	F ED 3044 00 01	1020x315x20 H
F ED 9037 00 01	F ED 3074 00 01	1765x315x20 H
F ED 9043 00 01	F ED 4034 00 01	1070x465x20 H
	F ED 4054 00 01	1765x465x20 H
F ED 9045 00 01	F ED 4056 00 01	1765x465x20 H
	F ED 4555 00 01	1765x465x20 H
F ED 9052 00 01	F ED 5023 00 01	1120x665x30 H
F ED 9053 00 01	F ED 5033 00 01	1667x665x30 H

PIANO DI LAVORO



ART.	PER SCAFFALE	dim. mm
F ED 9134 00 01	F ED 3044 00 01	1025x315x32 H
F ED 9137 00 01	F ED 3074 00 01	1770x315x32 H
F ED 9143 00 01	F ED 4034 00 01	1075x465x32 H
	F ED 4054 00 01	1770x465x32 H
F ED 9145 00 01	F ED 4056 00 01	1770x465x32 H
	F ED 4555 00 01	1770x465x32 H

ZOCCOLO



ART.	PER SCAFFALE	dim. mm
F ED 9234 00 01	F ED 3044 00 01	1020x315x85 H
F ED 9237 00 01	F ED 3074 00 01	1765x315x85 H
F ED 9243 00 01	F ED 4034 00 01	1070x465x85 H
	F ED 4054 00 01	1765x465x85 H
F ED 9245 00 01	F ED 4056 00 01	1765x465x85 H
	F ED 4555 00 01	1765x465x85 H
F ED 9352 00 01	F ED 5023 00 01	1125x660x155 H
F ED 9353 00 01	F ED 5033 00 01	1670x660x155 H

PER CONTENITORI IN PLASTICA E ACCIAIO

STORAGE DOMINO





C A P I E N T I
S O L U Z I O N I D I
S T O C C A G G I O
P E R S O N A L I Z Z A B I L I
C O N P O R T E

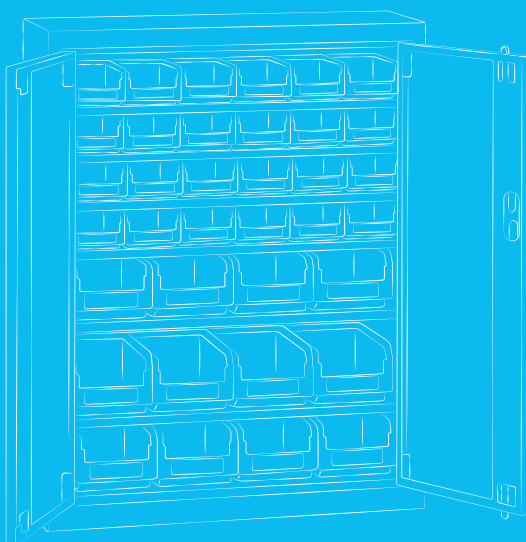



PERFOM AK

CARATTERISTICHE TECNICHE

Gli armadi porta contenitori FAMI rappresentano la soluzione ideale per lo stoccaggio ad uso commerciale ed industriale di minuterie ed oggetti di piccole dimensioni .

Sono composti da una struttura in lamiera di acciaio e da piani regolabili in altezza, inseriti in numero variabile a seconda della soluzione di impiego più idonea.

Sono inseribili contenitori in metallo serie Steel e in polipropilene serie PICKING BOX misura 1 o 2 .

Questi armadi vengono forniti nella versione "senza porta" o "con porta" con chiusura a chiave.



Gli armadi FAMI sono ideali per alloggiare contenitori in metallo e in polipropilene.

RIPIANI REGOLABILI

E' possibile suddividere l'armadio con ripiani regolabili in altezza, passo di 25 mm, inseribili in numero variabile a seconda delle esigenze.

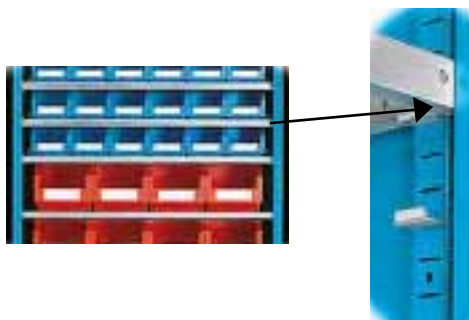

CONTENITORI

I contenitori sono stati realizzati per rispondere in modo razionale alle molteplici esigenze di stoccaggio e movimentazione del materiale.

Nel piano può essere inserito un fermo posteriore che evita lo spostamento in profondità del contenitore Mis. 1



MIS. 1

dim. 160/140x95x75 mm H



MIS. 2

dim. 230/200x140x130 mm H

SICUREZZA

Ai fini della sicurezza, gli armadi porta contenitori FAMI devono essere fissati a pavimento o a parete.



PERFOM F AK

H 2000 mm



• ART. F AK 2080 52 04

H 1000 mm



• ART. F AK 2040 52 04

H 1655 mm



• ART. F AK 1066 54 04

Gamma colori
ACCIAIO



GRIGIO
RAL 7000
.01



VERDE
RAL 6011
.02



BLU
RAL 5012
.04

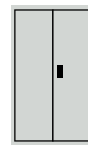

GRIGIO
RAL 7035
.08

- LA PORTATA DEL PIANO SUPERIORE È DI 50 kg

LEGENDA



PORTATA
ARMADIO



CHIUSURA
ARMADIO



LE PORTATE SONO NETTE E SI RIFERISCONO A PESI UNIFORMEMENTE DISTRIBUITI.



ART.				
F AK 2040 51 04		450	-	

8 piani regolabili ART. F AK 9020 01 99 - portata 50 kg
9 fermi per contenitori
54 contenitori blu PICKING BOX **mis. 1** art. FAX PB C001 A0 51 04



ART.				
F AK 2040 52 04		450	-	

6 piani regolabili ART. F AK 9020 01 99 - portata 50 kg
4 fermi per contenitori
24 contenitori blu PICKING BOX **mis. 1** art. FAX PB C001 A0 51 04
12 contenitori grigi PICKING BOX **mis. 2** art. FAX PB C002 A0 51 01



ART.				
F AK 1040 51 04		450	key	

8 piani regolabili ART. F AK 9020 01 99 - portata 50 kg
9 fermi per contenitori
54 contenitori blu PICKING BOX **mis. 1** art. FAX PB C001 A0 51 04



ART.				
F AK 2040 53 04		450	-	

5 piani regolabili ART. F AK 9020 01 99 - portata 50 kg
24 contenitori grigi PICKING BOX **mis. 2** art. FAX PB C002 A0 51 01



ART.				
F AK 1040 53 04		450	key	

5 piani regolabili ART. F AK 9020 01 99 - portata 50 kg
24 contenitori grigi PICKING BOX **mis. 2** art. FAX PB C002 A0 51 01



ART.				
F AK 1040 52 04		450	key	

6 piani regolabili ART. F AK 9020 01 99 - portata 50 kg
4 fermi per contenitori
24 contenitori blu PICKING BOX **mis. 1** art. FAX PB C001 A0 51 04
12 contenitori grigi PICKING BOX **mis. 2** art. FAX PB C002 A0 51 01

PERFOM F AK



H 1655 mm



ART.		kg	
F AK 2066 54 04		500	-

12 piani regolabili ART. F AK 9020 01 99 - portata 50 kg
 7 fermi per contenitori
 42 contenitori blu PICKING BOX **mis. 1** art. FAX PB C001 A0 51 04
 24 contenitori grigi PICKING BOX **mis. 2** art. FAX PB C002 A0 51 01

H 1655 mm



ART.		kg	
● F AK 1066 54 04		500	key

12 piani regolabili ART. F AK 9020 01 99 - portata 50 kg
 7 fermi per contenitori
 42 contenitori blu PICKING BOX **mis. 1** art. FAX PB C001 A0 51 04
 24 contenitori grigi PICKING BOX **mis. 2** art. FAX PB C002 A0 51 01

H 2000 mm



ART.		kg	
F AK 1080 52 04		500	key

15 piani regolabili ART. F AK 9020 01 99 - portata 50 kg
9 fermi per contenitori
54 contenitori blu PICKING BOX **mis. 1** art. FAX PB C001 A0 51 04
28 contenitori grigi PICKING BOX **mis. 2** art. FAX PB C002 A0 51 01

H 2000 mm



ART.		kg	
F AK 2080 52 04		500	-

15 piani regolabili profondità 235 mm - portata 50 kg
9 fermi per contenitori
54 contenitori blu PICKING BOX **mis. 1** art. FAX PB C001 A0 51 04
28 contenitori grigi PICKING BOX **mis. 2** art. FAX PB C002 A0 51 01

H 1655 mm



ART.		kg	
F AK 1066 63 04		500	key

armadio composto da:
1 telaio porta Visual Box altezza 1500 mm art. FVB SW 1500 00 00 01
2 art. FAX VB CH00 90 00 01
4 art. FAX VB CH00 60 00 01
3 art. FAX VB CH00 50 00 01
1 art. FAX VB CH00 40 00 01
1 art. FAX VB CH00 30 00 01

H 2000 mm



ART.		kg	
F AK 1080 58 04		450	key

armadio composto da:
1 telaio porta Visual Box altezza 1750 mm art. FVB SW 1750 00 00 01
1 art. FAX VB CH00 90 00 01
6 art. FAX VB CH00 60 00 01
2 art. FAX VB CH00 50 00 01
2 art. FAX VB CH00 40 00 01
1 art. FAX VB CH00 30 00 01

**MONTAGGIO
AD INCASTRO
VASTA GAMMA DI
ACCESSORI
PORTATE PER PIANO
DA 100 A 400 kg**

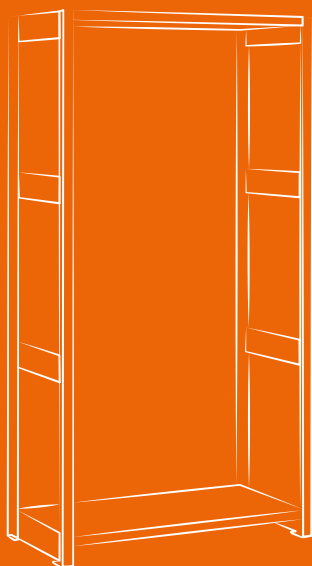



Per gentile concessione di Animo S.p.A.

SYSTEM ST

CARATTERISTICHE TECNICHE

Gli scaffali della serie F ST hanno una struttura componibile facile da montare: fiancate, pareti laterali, pareti centrali e pareti posteriori s'incastano tra loro senza l'uso di viti.

I piani corredati di 4 ganci, hanno una portata variabile dai 100 ai 400 kg. Questa tipologia di scaffalatura è predisposta a diventare un armadio con l'aggiunta di porte a battente o scorrevoli, mentre l'uso di divisori verticali, separatori, bandinelle e cassetti ad estrazione semplice (87%) e telescopica (100%) la rendono un magazzino organizzato.

Al bisogno, può essere arricchita da vari accessori.

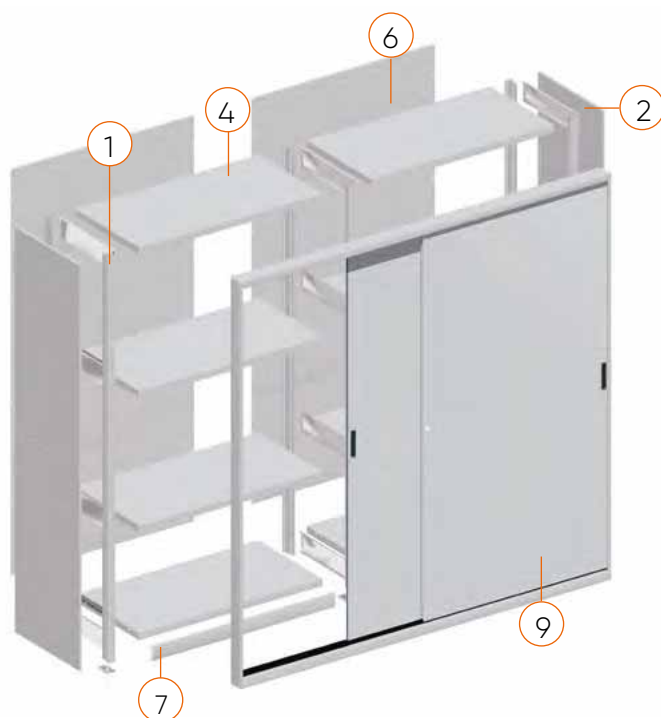

COMPONENTI SCAFFALATURA F ST

1	fiancate
2	pareti laterali
3	pareti centrali
4	piani
5	crociere
6	pareti posteriori
7	zoccoli
8	porte a battente
9	porte scorrevoli
10	divisori verticali
11	separatori
12	bandinelle posteriori e anteriori, divisori trapezoidali
13	cassetti

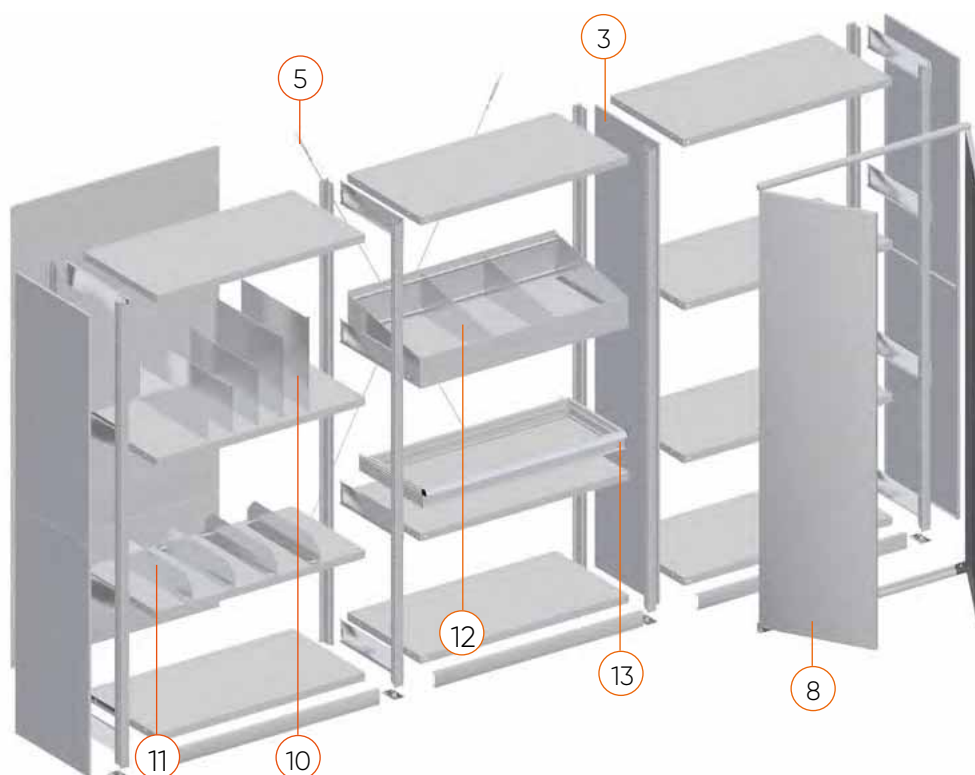

FIANCATE DELLA SCAFFALATURA

Le fiancate della scaffalatura F ST vengono montate in modo semplice e veloce tramite degli appositi traversini zincati e senza l'ausilio di viti.



PARETI LATERALI, CENTRALI E POSTERIORI

Le pareti laterali, centrali e posteriori vengono montate ad incastro senza l'ausilio di viti, formando dei vani chiusi.



PORTE SCORREVOLI O A BATTENTE

Le porte servono per proteggere la merce da urti e polvere. Entrambi i tipi di porta sono provvisti di serratura di sicurezza e di due chiavi.



ACCESSORI

Per sfruttare al meglio gli spazi della scaffalatura possono essere aggiunti accessori quali: divisori, separatori e bandinelle forniti zincati.



SYSTEM F ST

H 2000 mm



● ART. F ST S200 53 99

Dimensioni mm 4100x500x2000 H
16 piani 1000x500x35 H - portata di ogni piano 300 kg

Gamma colori
ACCIAIO 

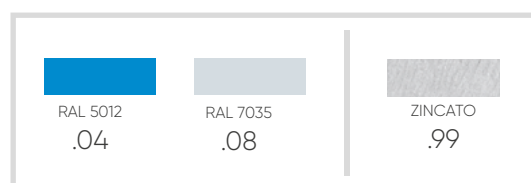
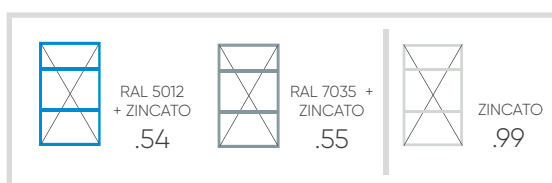

LEGENDA



PORTATA
SCAFFALE



LUNGHEZZA



CHIUSURA
SCAFFALE



LE PORTATE SONO NETTE E SI RIFERISCONO A PESI UNIFORMEMENTE DISTRIBUITI.



H 2000 mm

ART.	dim. mm
F ST S200 56 99	3100x500x2000 H

15 piani 1000x500x35 H - portata di ogni piano 300 kg
COLORE ZINCATO



H 2000 mm

ART.	dim. mm
F ST S200 57 99	2100x500x2000 H

8 piani 1000x500x35 H - portata di ogni piano 300 kg
COLORE ZINCATO

SYSTEM F ST



INGOMBRO CAMPATE

	A	B	C	
1000 mm	974 mm			LUNGHEZZA PIANI
1300 mm	1274 mm			
300 mm		321 mm	642 mm	PROFONDITÀ PIANI
400 mm		421 mm	842 mm	
500 mm		521 mm	1042 mm	
600 mm		621 mm	1242 mm	
800 mm		821 mm	1642 mm	

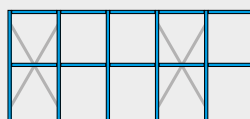
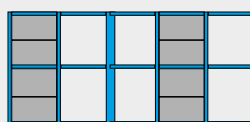

È obbligatorio almeno ogni **3 campate** utilizzare una campata con parete posteriore oppure una con crociera.

PORTATA DI OGNI CAMPATA 2300 kg

FISSAGGIO

SET DI FISSAGGIO A PAVIMENTO



ART. F NC 8999 00 99

Materiale di fissaggio composto da 2 viti ad espansione in acciaio M8x75 mm per pavimenti in calcestruzzo non fessurato uguali o maggiori alla classe: C20/25.

STAFFA DI FISSAGGIO ALLA PARETE



ART. F ST 0710 00 99

Tutte le campate con obbligo di fissaggio alla parete, vengono fornite di serie con le apposite staffe di fissaggio.

FISSAGGIO DEI PIEDINI



Le campate base vengono fornite di serie con chiave a brugola per il fissaggio dei piedini.

LE CAMPATE VENGONO FORNITE SMONTATE E COMPLETE DI PIEDINI.

CONFIGURA IL TUO SCAFFALE

CAMPATA BASE CON CROCIERA

←→ 1000 mm

VERNICIATO

ART.	profondità
F ST A200 30 _ _	300 mm
F ST A200 40 _ _	400 mm
F ST A200 50 _ _	500 mm
F ST A200 60 _ _	600 mm
F ST A200 80 _ _	800 mm

ZINCATO

F ST A200 30 99	300 mm
F ST A200 40 99	400 mm
F ST A200 50 99	500 mm
F ST A200 60 99	600 mm
F ST A200 80 99	800 mm

←→ 1300 mm

ART.	profondità
F ST F200 30 _ _	300 mm
F ST F200 40 _ _	400 mm
F ST F200 50 _ _	500 mm
F ST F200 60 _ _	600 mm
F ST F200 80 _ _	800 mm

F ST F200 30 99	300 mm
F ST F200 40 99	400 mm
F ST F200 50 99	500 mm
F ST F200 60 99	600 mm
F ST F200 80 99	800 mm



CAMPATA AGGIUNTIVA

←→ 1000 mm

VERNICIATO

ART.	profondità
F ST B200 30 _ _	300 mm
F ST B200 40 _ _	400 mm
F ST B200 50 _ _	500 mm
F ST B200 60 _ _	600 mm
F ST B200 80 _ _	800 mm

ZINCATO

F ST B200 30 99	300 mm
F ST B200 40 99	400 mm
F ST B200 50 99	500 mm
F ST B200 60 99	600 mm
F ST B200 80 99	800 mm

←→ 1300 mm

ART.	profondità
F ST G200 30 _ _	300 mm
F ST G200 40 _ _	400 mm
F ST G200 50 _ _	500 mm
F ST G200 60 _ _	600 mm
F ST G200 80 _ _	800 mm

F ST G200 30 99	300 mm
F ST G200 40 99	400 mm
F ST G200 50 99	500 mm
F ST G200 60 99	600 mm
F ST G200 80 99	800 mm



CAMPATA AGGIUNTIVA CON CROCIERA

←→ 1000 mm

VERNICIATO

ART.	profondità
F ST C200 40 _ _	400 mm
F ST C200 50 _ _	500 mm
F ST C200 60 _ _	600 mm
F ST C200 80 _ _	800 mm

ZINCATO

F ST C200 40 99	400 mm
F ST C200 50 99	500 mm
F ST C200 60 99	600 mm
F ST C200 80 99	800 mm

←→ 1300 mm

ART.	profondità
F ST H200 40 _ _	400 mm
F ST H200 50 _ _	500 mm
F ST H200 60 _ _	600 mm
F ST H200 80 _ _	800 mm

F ST H200 40 99	400 mm
F ST H200 50 99	500 mm
F ST H200 60 99	600 mm
F ST H200 80 99	800 mm



Gamma colori
ACCIAIO

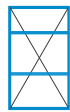

RAL 5012
+ ZINCATO
.54



RAL 7035 +
ZINCATO
.55

CAMPATA BASE CON PARETE POSTERIORE

←→ 1000 mm

←→ 1300 mm

VERNICIATO

ART.	profondità
F ST D200 30	300 mm
F ST D200 40	400 mm
F ST D200 50	500 mm
F ST D200 60	600 mm
F ST D200 80	800 mm

ART.	profondità
F ST L200 30	300 mm
F ST L200 40	400 mm
F ST L200 50	500 mm
F ST L200 60	600 mm
F ST L200 80	800 mm

ZINCATO

F ST D200 30 99	300 mm
F ST D200 40 99	400 mm
F ST D200 50 99	500 mm
F ST D200 60 99	600 mm
F ST D200 80 99	800 mm

F ST L200 30 99	300 mm
F ST L200 40 99	400 mm
F ST L200 50 99	500 mm
F ST L200 60 99	600 mm
F ST L200 80 99	800 mm



CAMPATA AGGIUNTIVA CON PARETE POSTERIORE

←→ 1000 mm

←→ 1300 mm

VERNICIATO

ART.	profondità
F ST E200 30	300 mm
F ST E200 40	400 mm
F ST E200 50	500 mm
F ST E200 60	600 mm
F ST E200 80	800 mm

ART.	profondità
F ST M200 30	300 mm
F ST M200 40	400 mm
F ST M200 50	500 mm
F ST M200 60	600 mm
F ST M200 80	800 mm

ZINCATO

F ST E200 30 99	300 mm
F ST E200 40 99	400 mm
F ST E200 50 99	500 mm
F ST E200 60 99	600 mm
F ST E200 80 99	800 mm

F ST M200 30 99	300 mm
F ST M200 40 99	400 mm
F ST M200 50 99	500 mm
F ST M200 60 99	600 mm
F ST M200 80 99	800 mm



CAMPATE LARGHEZZA 1000 mm

Ogni campata è completa di 4 piani. Per la profondità 300 mm vengono forniti i piani senza rinforzi con portata di 120 kg. Per le profondità 400/500/600/800 mm vengono forniti i piani completi di rinforzi con portata 300 kg.

CAMPATE LARGHEZZA 1300 mm

Ogni campata è completa di 4 piani. Per la profondità 300 mm vengono forniti i piani senza rinforzi con portata di 100 kg. Per le profondità 400/500/600/800 mm vengono forniti i piani completi di rinforzi con portata 230 kg.

CAMPATA BASE CON CROCIERA

←→ 1000 mm

VERNICIATO

ART.		profondità
F ST A201 30 _ _		300+300 mm
F ST A201 40 _ _		400+400 mm
F ST A201 50 _ _		500+500 mm
F ST A201 60 _ _		600+600 mm
F ST A201 80 _ _		800+800 mm

ZINCATO

F ST A201 30 99		300+300 mm
F ST A201 40 99		400+400 mm
F ST A201 50 99		500+500 mm
F ST A201 60 99		600+600 mm
F ST A201 80 99		800+800 mm

←→ 1300 mm

ART.		profondità
F ST F201 30 _ _		300+300 mm
F ST F201 40 _ _		400+400 mm
F ST F201 50 _ _		500+500 mm
F ST F201 60 _ _		600+600 mm
F ST F201 80 _ _		800+800 mm

F ST F201 30 99		300+300 mm
F ST F201 40 99		400+400 mm
F ST F201 50 99		500+500 mm
F ST F201 60 99		600+600 mm
F ST F201 80 99		800+800 mm



CAMPATA AGGIUNTIVA

←→ 1000 mm

VERNICIATO

ART.		profondità
F ST B201 30 _ _		300+300 mm
F ST B201 40 _ _		400+400 mm
F ST B201 50 _ _		500+500 mm
F ST B201 60 _ _		600+600 mm
F ST B201 80 _ _		800+800 mm

ZINCATO

F ST B201 30 99		300+300 mm
F ST B201 40 99		400+400 mm
F ST B201 50 99		500+500 mm
F ST B201 60 99		600+600 mm
F ST B201 80 99		800+800 mm

←→ 1300 mm

ART.		profondità
F ST G201 30 _ _		300+300 mm
F ST G201 40 _ _		400+400 mm
F ST G201 50 _ _		500+500 mm
F ST G201 60 _ _		600+600 mm
F ST G201 80 _ _		800+800 mm

F ST G201 30 99		300+300 mm
F ST G201 40 99		400+400 mm
F ST G201 50 99		500+500 mm
F ST G201 60 99		600+600 mm
F ST G201 80 99		800+800 mm



CAMPATA AGGIUNTIVA CON CROCIERA

←→ 1000 mm

VERNICIATO

ART.		profondità
F ST C201 30 _ _		300+300 mm
F ST C201 40 _ _		400+400 mm
F ST C201 50 _ _		500+500 mm
F ST C201 60 _ _		600+600 mm
F ST C201 80 _ _		800+800 mm

ZINCATO

F ST C201 30 99		300+300 mm
F ST C201 40 99		400+400 mm
F ST C201 50 99		500+500 mm
F ST C201 60 99		600+600 mm
F ST C201 80 99		800+800 mm

←→ 1300 mm

ART.		profondità
F ST H201 30 _ _		300+300 mm
F ST H201 40 _ _		400+400 mm
F ST H201 50 _ _		500+500 mm
F ST H201 60 _ _		600+600 mm
F ST H201 80 _ _		800+800 mm

F ST H201 30 99		300+300 mm
F ST H201 40 99		400+400 mm
F ST H201 50 99		500+500 mm
F ST H201 60 99		600+600 mm
F ST H201 80 99		800+800 mm



Gamma colori
ACCIAIO

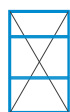

RAL 5012
+ ZINCATO
.54



RAL 7035 +
ZINCATO
.55

CAMPATA BASE CON PARETE POSTERIORE

←→ 1000 mm

←→ 1300 mm

VERNICIATO

ART.	profondità
F ST D201 30 _ _	300+300 mm
F ST D201 40 _ _	400+400 mm
F ST D201 50 _ _	500+500 mm
F ST D201 60 _ _	600+600 mm
F ST D201 80 _ _	800+800 mm

ART.	profondità
F ST L201 30 _ _	300+300 mm
F ST L201 40 _ _	400+400 mm
F ST L201 50 _ _	500+500 mm
F ST L201 60 _ _	600+600 mm
F ST L201 80 _ _	800+800 mm

ZINCATO

F ST D201 30 99	300+300 mm
F ST D201 40 99	400+400 mm
F ST D201 50 99	500+500 mm
F ST D201 60 99	600+600 mm
F ST D201 80 99	800+800 mm

F ST L201 30 99	300+300 mm
F ST L201 40 99	400+400 mm
F ST L201 50 99	500+500 mm
F ST L201 60 99	600+600 mm
F ST L201 80 99	800+800 mm



CAMPATA AGGIUNTIVA CON PARETE POSTERIORE

←→ 1000 mm

←→ 1300 mm

VERNICIATO

ART.	profondità
F ST E201 30 _ _	300+300 mm
F ST E201 40 _ _	400+400 mm
F ST E201 50 _ _	500+500 mm
F ST E201 60 _ _	600+600 mm
F ST E201 80 _ _	800+800 mm

ART.	profondità
F ST M201 30 _ _	300+300 mm
F ST M201 40 _ _	400+400 mm
F ST M201 50 _ _	500+500 mm
F ST M201 60 _ _	600+600 mm
F ST M201 80 _ _	800+800 mm

ZINCATO

F ST E201 30 99	300+300 mm
F ST E201 40 99	400+400 mm
F ST E201 50 99	500+500 mm
F ST E201 60 99	600+600 mm
F ST E201 80 99	800+800 mm

F ST M201 30 99	300+300 mm
F ST M201 40 99	400+400 mm
F ST M201 50 99	500+500 mm
F ST M201 60 99	600+600 mm
F ST M201 80 99	800+800 mm



CAMPATE LARGHEZZA 1000 mm

Ogni campata è completa di 8 piani. Per la profondità 300 mm vengono forniti i piani senza rinforzi con portata di 120 kg. Per le profondità 400/500/600/800 mm vengono forniti i piani completi di rinforzi con portata 300 kg.

CAMPATE LARGHEZZA 1300 mm

Ogni campata è completa di 8 piani. Per la profondità 300 mm vengono forniti i piani senza rinforzi con portata di 100 kg. Per le profondità 400/500/600/800 mm vengono forniti i piani completi di rinforzi con portata 230 kg.

CAMPATA BASE CON CROCIERA

←→ 1000 mm

VERNICIATO

ART.	profondità
F ST A220 30 _ _	300 mm
F ST A220 40 _ _	400 mm
F ST A220 50 _ _	500 mm
F ST A220 60 _ _	600 mm
F ST A220 80 _ _	800 mm

ZINCATO

F ST A220 30 99	300 mm
F ST A220 40 99	400 mm
F ST A220 50 99	500 mm
F ST A220 60 99	600 mm
F ST A220 80 99	800 mm

←→ 1300 mm

ART.	profondità
F ST F220 30 _ _	300 mm
F ST F220 40 _ _	400 mm
F ST F220 50 _ _	500 mm
F ST F220 60 _ _	600 mm
F ST F220 80 _ _	800 mm

F ST F220 30 99	300 mm
F ST F220 40 99	400 mm
F ST F220 50 99	500 mm
F ST F220 60 99	600 mm
F ST F220 80 99	800 mm



CAMPATA AGGIUNTIVA

←→ 1000 mm

VERNICIATO

ART.	profondità
F ST B220 30 _ _	300 mm
F ST B220 40 _ _	400 mm
F ST B220 50 _ _	500 mm
F ST B220 60 _ _	600 mm
F ST B220 80 _ _	800 mm

ZINCATO

F ST B220 30 99	300 mm
F ST B220 40 99	400 mm
F ST B220 50 99	500 mm
F ST B220 60 99	600 mm
F ST B220 80 99	800 mm

←→ 1300 mm

ART.	profondità
F ST G220 30 _ _	300 mm
F ST G220 40 _ _	400 mm
F ST G220 50 _ _	500 mm
F ST G220 60 _ _	600 mm
F ST G220 80 _ _	800 mm

F ST G220 30 99	300 mm
F ST G220 40 99	400 mm
F ST G220 50 99	500 mm
F ST G220 60 99	600 mm
F ST G220 80 99	800 mm



CAMPATA AGGIUNTIVA CON CROCIERA

←→ 1000 mm

VERNICIATO

ART.	profondità
F ST C220 40 _ _	400 mm
F ST C220 50 _ _	500 mm
F ST C220 60 _ _	600 mm
F ST C220 80 _ _	800 mm

ZINCATO

F ST C220 40 99	400 mm
F ST C220 50 99	500 mm
F ST C220 60 99	600 mm
F ST C220 80 99	800 mm

←→ 1300 mm

ART.	profondità
F ST H220 40 _ _	400 mm
F ST H220 50 _ _	500 mm
F ST H220 60 _ _	600 mm
F ST H220 80 _ _	800 mm

F ST H220 40 99	400 mm
F ST H220 50 99	500 mm
F ST H220 60 99	600 mm
F ST H220 80 99	800 mm



Gamma colori
ACCIAIO

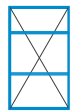

RAL 5012
+ ZINCATO
.54



RAL 7035 +
ZINCATO
.55

CAMPATA BASE CON PARETE POSTERIORE

←→ 1000 mm

VERNICIATO

ART.	profondità
F ST D220 30	300 mm
F ST D220 40	400 mm
F ST D220 50	500 mm
F ST D220 60	600 mm
F ST D220 80	800 mm

←→ 1300 mm

ART.	profondità
F ST L220 30	300 mm
F ST L220 40	400 mm
F ST L220 50	500 mm
F ST L220 60	600 mm
F ST L220 80	800 mm



ZINCATO

F ST D220 30 99	300 mm
F ST D220 40 99	400 mm
F ST D220 50 99	500 mm
F ST D220 60 99	600 mm
F ST D220 80 99	800 mm

F ST L220 30 99	300 mm
F ST L220 40 99	400 mm
F ST L220 50 99	500 mm
F ST L220 60 99	600 mm
F ST L220 80 99	800 mm

CAMPATA AGGIUNTIVA CON PARETE POSTERIORE

←→ 1000 mm

VERNICIATO

ART.	profondità
F ST E220 30	300 mm
F ST E220 40	400 mm
F ST E220 50	500 mm
F ST E220 60	600 mm
F ST E220 80	800 mm

←→ 1300 mm

ART.	profondità
F ST M220 30	300 mm
F ST M220 40	400 mm
F ST M220 50	500 mm
F ST M220 60	600 mm
F ST M220 80	800 mm

ZINCATO

F ST E220 30 99	300 mm
F ST E220 40 99	400 mm
F ST E220 50 99	500 mm
F ST E220 60 99	600 mm
F ST E220 80 99	800 mm

F ST M220 30 99	300 mm
F ST M220 40 99	400 mm
F ST M220 50 99	500 mm
F ST M220 60 99	600 mm
F ST M220 80 99	800 mm



CAMPATE LARGHEZZA 1000 mm

Ogni campata è completa di 4 piani. Per la profondità 300 mm vengono forniti i piani senza rinforzi con portata di 120 kg. Per le profondità 400/500/600/800 mm vengono forniti i piani completi di rinforzi con portata 300 kg.

CAMPATE LARGHEZZA 1300 mm

Ogni campata è completa di 4 piani. Per la profondità 300 mm vengono forniti i piani senza rinforzi con portata di 100 kg. Per le profondità 400/500/600/800 mm vengono forniti i piani completi di rinforzi con portata 230 kg.

CAMPATA BASE CON CROCIERA

←→ 1000 mm

VERNICIATO

ART.		profondità	
F ST A221 30	..	300+300 mm	
F ST A221 40	..	400+400 mm	
F ST A221 50	..	500+500 mm	
F ST A221 60	..	600+600 mm	
F ST A221 80	..	800+800 mm	

ZINCATO

F ST A221 30	99	300+300 mm	
F ST A221 40	99	400+400 mm	
F ST A221 50	99	500+500 mm	
F ST A221 60	99	600+600 mm	
F ST A221 80	99	800+800 mm	

←→ 1300 mm

ART.		profondità	
F ST F221 30	..	300+300 mm	
F ST F221 40	..	400+400 mm	
F ST F221 50	..	500+500 mm	
F ST F221 60	..	600+600 mm	
F ST F221 80	..	800+800 mm	

F ST F221 30	99	300+300 mm	
F ST F221 40	99	400+400 mm	
F ST F221 50	99	500+500 mm	
F ST F221 60	99	600+600 mm	
F ST F221 80	99	800+800 mm	



CAMPATA AGGIUNTIVA

←→ 1000 mm

VERNICIATO

ART.		profondità	
F ST B221 30	..	300+300 mm	
F ST B221 40	..	400+400 mm	
F ST B221 50	..	500+500 mm	
F ST B221 60	..	600+600 mm	
F ST B221 80	..	800+800 mm	

ZINCATO

F ST B221 30	99	300+300 mm	
F ST B221 40	99	400+400 mm	
F ST B221 50	99	500+500 mm	
F ST B221 60	99	600+600 mm	
F ST B221 80	99	800+800 mm	

←→ 1300 mm

ART.		profondità	
F ST G221 30	..	300+300 mm	
F ST G221 40	..	400+400 mm	
F ST G221 50	..	500+500 mm	
F ST G221 60	..	600+600 mm	
F ST G221 80	..	800+800 mm	

F ST G221 30	99	300+300 mm	
F ST G221 40	99	400+400 mm	
F ST G221 50	99	500+500 mm	
F ST G221 60	99	600+600 mm	
F ST G221 80	99	800+800 mm	



CAMPATA AGGIUNTIVA CON CROCIERA

←→ 1000 mm

VERNICIATO

ART.		profondità	
F ST C221 30	..	300+300 mm	
F ST C221 40	..	400+400 mm	
F ST C221 50	..	500+500 mm	
F ST C221 60	..	600+600 mm	
F ST C221 80	..	800+800 mm	

ZINCATO

F ST C221 30	99	300+300 mm	
F ST C221 40	99	400+400 mm	
F ST C221 50	99	500+500 mm	
F ST C221 60	99	600+600 mm	
F ST C221 80	99	800+800 mm	

←→ 1300 mm

ART.		profondità	
F ST H221 30	..	300+300 mm	
F ST H221 40	..	400+400 mm	
F ST H221 50	..	500+500 mm	
F ST H221 60	..	600+600 mm	
F ST H221 80	..	800+800 mm	

F ST H221 30	99	300+300 mm	
F ST H221 40	99	400+400 mm	
F ST H221 50	99	500+500 mm	
F ST H221 60	99	600+600 mm	
F ST H221 80	99	800+800 mm	



Gamma colori
ACCIAIO

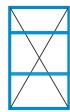

RAL 5012
+ ZINCATO
.54



RAL 7035 +
ZINCATO
.55

CAMPATA BASE CON PARETE POSTERIORE

←→ 1000 mm

←→ 1300 mm

VERNICIATO

ART.	profondità
F ST D221 30 _ _	300+300 mm
F ST D221 40 _ _	400+400 mm
F ST D221 50 _ _	500+500 mm
F ST D221 60 _ _	600+600 mm
F ST D221 80 _ _	800+800 mm

ART.	profondità
F ST L221 30 _ _	300+300 mm
F ST L221 40 _ _	400+400 mm
F ST L221 50 _ _	500+500 mm
F ST L221 60 _ _	600+600 mm
F ST L221 80 _ _	800+800 mm

ZINCATO

F ST D221 30 99	300+300 mm
F ST D221 40 99	400+400 mm
F ST D221 50 99	500+500 mm
F ST D221 60 99	600+600 mm
F ST D221 80 99	800+800 mm

F ST L221 30 99	300+300 mm
F ST L221 40 99	400+400 mm
F ST L221 50 99	500+500 mm
F ST L221 60 99	600+600 mm
F ST L221 80 99	800+800 mm



CAMPATA AGGIUNTIVA CON PARETE POSTERIORE

←→ 1000 mm

←→ 1300 mm

VERNICIATO

ART.	profondità
F ST E221 30 _ _	300+300 mm
F ST E221 40 _ _	400+400 mm
F ST E221 50 _ _	500+500 mm
F ST E221 60 _ _	600+600 mm
F ST E221 80 _ _	800+800 mm

ART.	profondità
F ST M221 30 _ _	300+300 mm
F ST M221 40 _ _	400+400 mm
F ST M221 50 _ _	500+500 mm
F ST M221 60 _ _	600+600 mm
F ST M221 80 _ _	800+800 mm

ZINCATO

F ST E221 30 99	300+300 mm
F ST E221 40 99	400+400 mm
F ST E221 50 99	500+500 mm
F ST E221 60 99	600+600 mm
F ST E221 80 99	800+800 mm

F ST M221 30 99	300+300 mm
F ST M221 40 99	400+400 mm
F ST M221 50 99	500+500 mm
F ST M221 60 99	600+600 mm
F ST M221 80 99	800+800 mm



CAMPATE LARGHEZZA 1000 mm

Ogni campata è completa di 8 piani. Per la profondità 300 mm vengono forniti i piani senza rinforzi con portata di 120 kg. Per le profondità 400/500/600/800 mm vengono forniti i piani completi di rinforzi con portata 300 kg.

CAMPATE LARGHEZZA 1300 mm

Ogni campata è completa di 8 piani. Per la profondità 300 mm vengono forniti i piani senza rinforzi con portata di 100 kg. Per le profondità 400/500/600/800 mm vengono forniti i piani completi di rinforzi con portata 230 kg.

SYSTEM F ST



SYSTEM F ST
SISTEMA A SCALFONE PER
L'ARCHIVIO E IL MAGAZZINO
TELEFONICO
SISTEMA A SCALFONE PER
L'ARCHIVIO E IL MAGAZZINO
TELEFONICO
SISTEMA A SCALFONE PER
L'ARCHIVIO E IL MAGAZZINO
TELEFONICO





MOONWALL 1.57

Capacità massima 3 x 1 piano
 Max. capacità massima per piano
 Max. capacità massima per colonna
 Max. carico massimo per piano
 Max. carico massimo per colonna

800 mm
2300 Kg

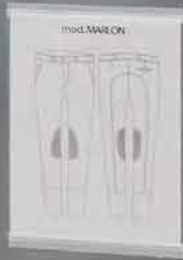

CAMPATA BASE CON CROCIERA

		←→ 1000 mm		←→ 1300 mm	
	ART.	profondità		ART.	profondità
VERNICIATO	F ST A250 30 __	300 mm		F ST F250 30 __	300 mm
	F ST A250 40 __	400 mm		F ST F250 40 __	400 mm
	F ST A250 50 __	500 mm		F ST F250 50 __	500 mm
	F ST A250 60 __	600 mm		F ST F250 60 __	600 mm
	F ST A250 80 __	800 mm		F ST F250 80 __	800 mm
ZINCATO	F ST A250 30 99	300 mm		F ST F250 30 99	300 mm
	F ST A250 40 99	400 mm		F ST F250 40 99	400 mm
	F ST A250 50 99	500 mm		F ST F250 50 99	500 mm
	F ST A250 60 99	600 mm		F ST F250 60 99	600 mm
	F ST A250 80 99	800 mm		F ST F250 80 99	800 mm



CAMPATA AGGIUNTIVA

		←→ 1000 mm		←→ 1300 mm	
	ART.	profondità		ART.	profondità
VERNICIATO	F ST B250 30 __	300 mm		F ST G250 30 __	300 mm
	F ST B250 40 __	400 mm		F ST G250 40 __	400 mm
	F ST B250 50 __	500 mm		F ST G250 50 __	500 mm
	F ST B250 60 __	600 mm		F ST G250 60 __	600 mm
	F ST B250 80 __	800 mm		F ST G250 80 __	800 mm
ZINCATO	F ST B250 30 99	300 mm		F ST G250 30 99	300 mm
	F ST B250 40 99	400 mm		F ST G250 40 99	400 mm
	F ST B250 50 99	500 mm		F ST G250 50 99	500 mm
	F ST B250 60 99	600 mm		F ST G250 60 99	600 mm
	F ST B250 80 99	800 mm		F ST G250 80 99	800 mm



CAMPATA AGGIUNTIVA CON CROCIERA

		←→ 1000 mm		←→ 1300 mm	
	ART.	profondità		ART.	profondità
VERNICIATO	F ST C250 50 __	500 mm		F ST H250 50 __	500 mm
	F ST C250 60 __	600 mm		F ST H250 60 __	600 mm
	F ST C250 80 __	800 mm		F ST H250 80 __	800 mm
ZINCATO	F ST C250 50 99	500 mm		F ST H250 50 99	500 mm
	F ST C250 60 99	600 mm		F ST H250 60 99	600 mm
	F ST C250 80 99	800 mm		F ST H250 80 99	800 mm



Gamma colori
ACCIAIO

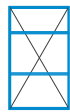

RAL 5012
+ ZINCATO
.54



RAL 7035 +
ZINCATO
.55

CAMPATA BASE CON PARETE POSTERIORE

←→ 1000 mm

←→ 1300 mm

VERNICIATO

ART.	profondità
F ST D250 30 _ _	300 mm
F ST D250 40 _ _	400 mm
F ST D250 50 _ _	500 mm
F ST D250 60 _ _	600 mm
F ST D250 80 _ _	800 mm

ART.	profondità
F ST L250 30 _ _	300 mm
F ST L250 40 _ _	400 mm
F ST L250 50 _ _	500 mm
F ST L250 60 _ _	600 mm
F ST L250 80 _ _	800 mm

ZINCATO

F ST D250 30 99	300 mm
F ST D250 40 99	400 mm
F ST D250 50 99	500 mm
F ST D250 60 99	600 mm
F ST D250 80 99	800 mm

F ST L250 30 99	300 mm
F ST L250 40 99	400 mm
F ST L250 50 99	500 mm
F ST L250 60 99	600 mm
F ST L250 80 99	800 mm



CAMPATA AGGIUNTIVA CON PARETE POSTERIORE

←→ 1000 mm

←→ 1300 mm

VERNICIATO

ART.	profondità
F ST E250 30 _ _	300 mm
F ST E250 40 _ _	400 mm
F ST E250 50 _ _	500 mm
F ST E250 60 _ _	600 mm
F ST E250 80 _ _	800 mm

ART.	profondità
F ST M250 30 _ _	300 mm
F ST M250 40 _ _	400 mm
F ST M250 50 _ _	500 mm
F ST M250 60 _ _	600 mm
F ST M250 80 _ _	800 mm

ZINCATO

F ST E250 30 99	300 mm
F ST E250 40 99	400 mm
F ST E250 50 99	500 mm
F ST E250 60 99	600 mm
F ST E250 80 99	800 mm

F ST M250 30 99	300 mm
F ST M250 40 99	400 mm
F ST M250 50 99	500 mm
F ST M250 60 99	600 mm
F ST M250 80 99	800 mm



CAMPATE LARGHEZZA 1000 mm

Ogni campata è completa di 5 piani. Per la profondità 300 mm vengono forniti i piani senza rinforzi con portata di 120 kg. Per le profondità 400/500/600/800 mm vengono forniti i piani completi di rinforzi con portata 300 kg.

CAMPATE LARGHEZZA 1300 mm

Ogni campata è completa di 5 piani. Per la profondità 300 mm vengono forniti i piani senza rinforzi con portata di 100 kg. Per le profondità 400/500/600/800 mm vengono forniti i piani completi di rinforzi con portata 230 kg.

CAMPATA BASE CON CROCIERA

←→ 1000 mm

VERNICIATO	ART.	profondità
	F ST A251 30 __	300+300 mm
	F ST A251 40 __	400+400 mm
	F ST A251 50 __	500+500 mm
	F ST A251 60 __	600+600 mm
	F ST A251 80 __	800+800 mm

F ST A251 30 99	300+300 mm
F ST A251 40 99	400+400 mm
F ST A251 50 99	500+500 mm
F ST A251 60 99	600+600 mm
F ST A251 80 99	800+800 mm

←→ 1300 mm

ART.	profondità
F ST F251 30 __	300+300 mm
F ST F251 40 __	400+400 mm
F ST F251 50 __	500+500 mm
F ST F251 60 __	600+600 mm
F ST F251 80 __	800+800 mm

F ST F251 30 99	300+300 mm
F ST F251 40 99	400+400 mm
F ST F251 50 99	500+500 mm
F ST F251 60 99	600+600 mm
F ST F251 80 99	800+800 mm



CAMPATA AGGIUNTIVA

←→ 1000 mm

VERNICIATO	ART.	profondità
	F ST B251 30 __	300+300 mm
	F ST B251 40 __	400+400 mm
	F ST B251 50 __	500+500 mm
	F ST B251 60 __	600+600 mm
	F ST B251 80 __	800+800 mm

F ST B251 30 99	300+300 mm
F ST B251 40 99	400+400 mm
F ST B251 50 99	500+500 mm
F ST B251 60 99	600+600 mm
F ST B251 80 99	800+800 mm

←→ 1300 mm

ART.	profondità
F ST G251 30 __	300+300 mm
F ST G251 40 __	400+400 mm
F ST G251 50 __	500+500 mm
F ST G251 60 __	600+600 mm
F ST G251 80 __	800+800 mm

F ST G251 30 99	300+300 mm
F ST G251 40 99	400+400 mm
F ST G251 50 99	500+500 mm
F ST G251 60 99	600+600 mm
F ST G251 80 99	800+800 mm



CAMPATA AGGIUNTIVA CON CROCIERA

←→ 1000 mm

VERNICIATO	ART.	profondità
	F ST C251 30 __	300+300 mm
	F ST C251 40 __	400+400 mm
	F ST C251 50 __	500+500 mm
	F ST C251 60 __	600+600 mm
	F ST C251 80 __	800+800 mm

F ST C251 30 99	300+300 mm
F ST C251 40 99	400+400 mm
F ST C251 50 99	500+500 mm
F ST C251 60 99	600+600 mm
F ST C251 80 99	800+800 mm

←→ 1300 mm

ART.	profondità
F ST H251 30 __	300+300 mm
F ST H251 40 __	400+400 mm
F ST H251 50 __	500+500 mm
F ST H251 60 __	600+600 mm
F ST H251 80 __	800+800 mm

F ST H251 30 99	300+300 mm
F ST H251 40 99	400+400 mm
F ST H251 50 99	500+500 mm
F ST H251 60 99	600+600 mm
F ST H251 80 99	800+800 mm



Gamma colori
ACCIAIO

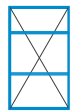

RAL 5012
+ ZINCATO
.54



RAL 7035 +
ZINCATO
.55

CAMPATA BASE CON PARETE POSTERIORE

		↔ 1000 mm		↔ 1300 mm	
	ART.	profondità		ART.	profondità
VERNICIATO	F ST D251 30 _ _	300+300 mm		F ST L251 30 _ _	300+300 mm
	F ST D251 40 _ _	400+400 mm		F ST L251 40 _ _	400+400 mm
	F ST D251 50 _ _	500+500 mm		F ST L251 50 _ _	500+500 mm
	F ST D251 60 _ _	600+600 mm		F ST L251 60 _ _	600+600 mm
	F ST D251 80 _ _	800+800 mm		F ST L251 80 _ _	800+800 mm
ZINCATO	F ST D251 30 99	300+300 mm		F ST L251 30 99	300+300 mm
	F ST D251 40 99	400+400 mm		F ST L251 40 99	400+400 mm
	F ST D251 50 99	500+500 mm		F ST L251 50 99	500+500 mm
	F ST D251 60 99	600+600 mm		F ST L251 60 99	600+600 mm
	F ST D251 80 99	800+800 mm		F ST L251 80 99	800+800 mm



CAMPATA AGGIUNTIVA CON PARETE POSTERIORE

		↔ 1000 mm		↔ 1300 mm	
	ART.	profondità		ART.	profondità
VERNICIATO	F ST E251 30 _ _	300+300 mm		F ST M251 30 _ _	300+300 mm
	F ST E251 40 _ _	400+400 mm		F ST M251 40 _ _	400+400 mm
	F ST E251 50 _ _	500+500 mm		F ST M251 50 _ _	500+500 mm
	F ST E251 60 _ _	600+600 mm		F ST M251 60 _ _	600+600 mm
	F ST E251 80 _ _	800+800 mm		F ST M251 80 _ _	800+800 mm
ZINCATO	F ST E251 30 99	300+300 mm		F ST M251 30 99	300+300 mm
	F ST E251 40 99	400+400 mm		F ST M251 40 99	400+400 mm
	F ST E251 50 99	500+500 mm		F ST M251 50 99	500+500 mm
	F ST E251 60 99	600+600 mm		F ST M251 60 99	600+600 mm
	F ST E251 80 99	800+800 mm		F ST M251 80 99	800+800 mm



CAMPATE LARGHEZZA 1000 mm

Ogni campata è completa di 10 piani. Per la profondità 300 mm vengono forniti i piani senza rinforzi con portata di 120 kg. Per le profondità 400/500/600/800 mm vengono forniti i piani completi di rinforzi con portata 300 kg.

CAMPATE LARGHEZZA 1300 mm

Ogni campata è completa di 10 piani. Per la profondità 300 mm vengono forniti i piani senza rinforzi con portata di 100 kg. Per le profondità 400/500/600/800 mm vengono forniti i piani completi di rinforzi con portata 230 kg.

CAMPATA BASE CON CROCIERA

←→ 1000 mm

VERNICIATO

ART.	profondità
F ST A300 30 _ _	300 mm
F ST A300 40 _ _	400 mm
F ST A300 50 _ _	500 mm
F ST A300 60 _ _	600 mm
F ST A300 80 _ _	800 mm

ZINCATO

F ST A300 30 99	300 mm
F ST A300 40 99	400 mm
F ST A300 50 99	500 mm
F ST A300 60 99	600 mm
F ST A300 80 99	800 mm

←→ 1300 mm

ART.	profondità
F ST F300 30 _ _	300 mm
F ST F300 40 _ _	400 mm
F ST F300 50 _ _	500 mm
F ST F300 60 _ _	600 mm
F ST F300 80 _ _	800 mm

F ST F300 30 99	300 mm
F ST F300 40 99	400 mm
F ST F300 50 99	500 mm
F ST F300 60 99	600 mm
F ST F300 80 99	800 mm



CAMPATA AGGIUNTIVA

←→ 1000 mm

VERNICIATO

ART.	profondità
F ST B300 30 _ _	300 mm
F ST B300 40 _ _	400 mm
F ST B300 50 _ _	500 mm
F ST B300 60 _ _	600 mm
F ST B300 80 _ _	800 mm

ZINCATO

F ST B300 30 99	300 mm
F ST B300 40 99	400 mm
F ST B300 50 99	500 mm
F ST B300 60 99	600 mm
F ST B300 80 99	800 mm

←→ 1300 mm

ART.	profondità
F ST G300 30 _ _	300 mm
F ST G300 40 _ _	400 mm
F ST G300 50 _ _	500 mm
F ST G300 60 _ _	600 mm
F ST G300 80 _ _	800 mm

F ST G300 30 99	300 mm
F ST G300 40 99	400 mm
F ST G300 50 99	500 mm
F ST G300 60 99	600 mm
F ST G300 80 99	800 mm



CAMPATA AGGIUNTIVA CON CROCIERA

←→ 1000 mm

VERNICIATO

ART.	profondità
F ST C300 50 _ _	500 mm
F ST C300 60 _ _	600 mm
F ST C300 80 _ _	800 mm

ZINCATO

F ST C300 50 99	500 mm
F ST C300 60 99	600 mm
F ST C300 80 99	800 mm

←→ 1300 mm

ART.	profondità
F ST H300 50 _ _	500 mm
F ST H300 60 _ _	600 mm
F ST H300 80 _ _	800 mm

F ST H300 50 99	500 mm
F ST H300 60 99	600 mm
F ST H300 80 99	800 mm



Gamma colori
ACCIAIO

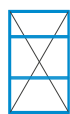

RAL 5012
+ ZINCATO
.54



RAL 7035 +
ZINCATO
.55

CAMPATA BASE CON PARETE POSTERIORE

←→ 1000 mm

←→ 1300 mm

VERNICIATO

ART.	profondità
F ST D300 30 _ _	300 mm
F ST D300 40 _ _	400 mm
F ST D300 50 _ _	500 mm
F ST D300 60 _ _	600 mm
F ST D300 80 _ _	800 mm

ART.	profondità
F ST L300 30 _ _	300 mm
F ST L300 40 _ _	400 mm
F ST L300 50 _ _	500 mm
F ST L300 60 _ _	600 mm
F ST L300 80 _ _	800 mm

ZINCATO

F ST D300 30 99	300 mm
F ST D300 40 99	400 mm
F ST D300 50 99	500 mm
F ST D300 60 99	600 mm
F ST D300 80 99	800 mm

F ST L300 30 99	300 mm
F ST L300 40 99	400 mm
F ST L300 50 99	500 mm
F ST L300 60 99	600 mm
F ST L300 80 99	800 mm



CAMPATA AGGIUNTIVA CON PARETE POSTERIORE

←→ 1000 mm

←→ 1300 mm

VERNICIATO

ART.	profondità
F ST E300 30 _ _	300 mm
F ST E300 40 _ _	400 mm
F ST E300 50 _ _	500 mm
F ST E300 60 _ _	600 mm
F ST E300 80 _ _	800 mm

ART.	profondità
F ST M300 30 _ _	300 mm
F ST M300 40 _ _	400 mm
F ST M300 50 _ _	500 mm
F ST M300 60 _ _	600 mm
F ST M300 80 _ _	800 mm

ZINCATO

F ST E300 30 99	300 mm
F ST E300 40 99	400 mm
F ST E300 50 99	500 mm
F ST E300 60 99	600 mm
F ST E300 80 99	800 mm

F ST M300 30 99	300 mm
F ST M300 40 99	400 mm
F ST M300 50 99	500 mm
F ST M300 60 99	600 mm
F ST M300 80 99	800 mm



CAMPATE LARGHEZZA 1000 mm

Ogni campata è completa di 6 piani. Per la profondità 300 mm vengono forniti i piani senza rinforzi con portata di 120 kg. Per le profondità 400/500/600/800 mm vengono forniti i piani completi di rinforzi con portata 300 kg.

CAMPATE LARGHEZZA 1300 mm

Ogni campata è completa di 6 piani. Per la profondità 300 mm vengono forniti i piani senza rinforzi con portata di 100 kg. Per le profondità 400/500/600/800 mm vengono forniti i piani completi di rinforzi con portata 230 kg.

CAMPATA BASE CON CROCIERA

←→ 1000 mm

VERNICIATO

ART.	profondità
F ST A301 30	300+300 mm
F ST A301 40	400+400 mm
F ST A301 50	500+500 mm
F ST A301 60	600+600 mm
F ST A301 80	800+800 mm

ZINCATO

F ST A301 30 99	300+300 mm
F ST A301 40 99	400+400 mm
F ST A301 50 99	500+500 mm
F ST A301 60 99	600+600 mm
F ST A301 80 99	800+800 mm

←→ 1300 mm

ART.	profondità
F ST F301 30	300+300 mm
F ST F301 40	400+400 mm
F ST F301 50	500+500 mm
F ST F301 60	600+600 mm
F ST F301 80	800+800 mm

F ST F301 30 99	300+300 mm
F ST F301 40 99	400+400 mm
F ST F301 50 99	500+500 mm
F ST F301 60 99	600+600 mm
F ST F301 80 99	800+800 mm



CAMPATA AGGIUNTIVA

←→ 1000 mm

VERNICIATO

ART.	profondità
F ST B301 30	300+300 mm
F ST B301 40	400+400 mm
F ST B301 50	500+500 mm
F ST B301 60	600+600 mm
F ST B301 80	800+800 mm

ZINCATO

F ST B301 30 99	300+300 mm
F ST B301 40 99	400+400 mm
F ST B301 50 99	500+500 mm
F ST B301 60 99	600+600 mm
F ST B301 80 99	800+800 mm

←→ 1300 mm

ART.	profondità
F ST G301 30	300+300 mm
F ST G301 40	400+400 mm
F ST G301 50	500+500 mm
F ST G301 60	600+600 mm
F ST G301 80	800+800 mm

F ST G301 30 99	300+300 mm
F ST G301 40 99	400+400 mm
F ST G301 50 99	500+500 mm
F ST G301 60 99	600+600 mm
F ST G301 80 99	800+800 mm



CAMPATA AGGIUNTIVA CON CROCIERA

←→ 1000 mm

VERNICIATO

ART.	profondità
F ST C301 30	300+300 mm
F ST C301 40	400+400 mm
F ST C301 50	500+500 mm
F ST C301 60	600+600 mm
F ST C301 80	800+800 mm

ZINCATO

F ST C301 30 99	300+300 mm
F ST C301 40 99	400+400 mm
F ST C301 50 99	500+500 mm
F ST C301 60 99	600+600 mm
F ST C301 80 99	800+800 mm

←→ 1300 mm

ART.	profondità
F ST H301 30	300+300 mm
F ST H301 40	400+400 mm
F ST H301 50	500+500 mm
F ST H301 60	600+600 mm
F ST H301 80	800+800 mm

F ST H301 30 99	300+300 mm
F ST H301 40 99	400+400 mm
F ST H301 50 99	500+500 mm
F ST H301 60 99	600+600 mm
F ST H301 80 99	800+800 mm



Gamma colori
ACCIAIO

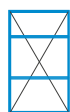

RAL 5012
+ ZINCATO
.54



RAL 7035 +
ZINCATO
.55

CAMPATA BASE CON PARETE POSTERIORE

←→ 1000 mm

←→ 1300 mm

VERNICIATO

ART.	profondità
F ST D301 30	300+300 mm
F ST D301 40	400+400 mm
F ST D301 50	500+500 mm
F ST D301 60	600+600 mm
F ST D301 80	800+800 mm

ART.	profondità
F ST L301 30	300+300 mm
F ST L301 40	400+400 mm
F ST L301 50	500+500 mm
F ST L301 60	600+600 mm
F ST L301 80	800+800 mm

ZINCATO

F ST D301 30 99	300+300 mm
F ST D301 40 99	400+400 mm
F ST D301 50 99	500+500 mm
F ST D301 60 99	600+600 mm
F ST D301 80 99	800+800 mm

F ST L301 30 99	300+300 mm
F ST L301 40 99	400+400 mm
F ST L301 50 99	500+500 mm
F ST L301 60 99	600+600 mm
F ST L301 80 99	800+800 mm



CAMPATA AGGIUNTIVA CON PARETE POSTERIORE

←→ 1000 mm

←→ 1300 mm

VERNICIATO

ART.	profondità
F ST E301 30	300+300 mm
F ST E301 40	400+400 mm
F ST E301 50	500+500 mm
F ST E301 60	600+600 mm
F ST E301 80	800+800 mm

ART.	profondità
F ST M301 30	300+300 mm
F ST M301 40	400+400 mm
F ST M301 50	500+500 mm
F ST M301 60	600+600 mm
F ST M301 80	800+800 mm

ZINCATO

F ST E301 30 99	300+300 mm
F ST E301 40 99	400+400 mm
F ST E301 50 99	500+500 mm
F ST E301 60 99	600+600 mm
F ST E301 80 99	800+800 mm

F ST M301 30 99	300+300 mm
F ST M301 40 99	400+400 mm
F ST M301 50 99	500+500 mm
F ST M301 60 99	600+600 mm
F ST M301 80 99	800+800 mm



CAMPATE LARGHEZZA 1000 mm

Ogni campata è completa di 12 piani. Per la profondità 300 mm vengono forniti i piani senza rinforzi con portata di 120 kg. Per le profondità 400/500/600/800 mm vengono forniti i piani completi di rinforzi con portata 300 kg.

CAMPATE LARGHEZZA 1300 mm

Ogni campata è completa di 12 piani. Per la profondità 300 mm vengono forniti i piani senza rinforzi con portata di 100 kg. Per le profondità 400/500/600/800 mm vengono forniti i piani completi di rinforzi con portata 230 kg.

SYSTEM F ST





SYSTEM F ST

FIANCATE CON TRAVERSINI

FIANCATA ALTEZZA 1000 mm H



ZINCATO

ART.	profondità	
F ST 0100 30 99	300 mm	
F ST 0100 40 99	400 mm	
F ST 0100 50 99	500 mm	
F ST 0100 60 99	600 mm	
F ST 0100 80 99	800 mm	

Fiancata con 2 traversini

VERNICIATO

ART.		profondità	
F ST 0100 30 _ _		300 mm	
F ST 0100 40 _ _		400 mm	
F ST 0100 50 _ _		500 mm	
F ST 0100 60 _ _		600 mm	
F ST 0100 80 _ _		800 mm	

Fiancata con 2 traversini

FIANCATA ALTEZZA 2000 mm H



ZINCATO

ART.	profondità	
F ST 0200 30 99	300 mm	
F ST 0200 40 99	400 mm	
F ST 0200 50 99	500 mm	
F ST 0200 60 99	600 mm	
F ST 0200 80 99	800 mm	

Fiancata con 4 traversini

VERNICIATO

ART.		profondità	
F ST 0200 30 _ _		300 mm	
F ST 0200 40 _ _		400 mm	
F ST 0200 50 _ _		500 mm	
F ST 0200 60 _ _		600 mm	
F ST 0200 80 _ _		800 mm	

Fiancata con 4 traversini

FIANCATA ALTEZZA 2200 mm H

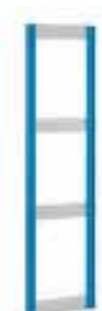

ZINCATO

ART.	profondità	
F ST 0220 30 99	300 mm	
F ST 0220 40 99	400 mm	
F ST 0220 50 99	500 mm	
F ST 0220 60 99	600 mm	
F ST 0220 80 99	800 mm	

Fiancata con 4 traversini

VERNICIATO

ART.		profondità	
F ST 0220 30 _ _		300 mm	
F ST 0220 40 _ _		400 mm	
F ST 0220 50 _ _		500 mm	
F ST 0220 60 _ _		600 mm	
F ST 0220 80 _ _		800 mm	

Fiancata con 4 traversini

Gamma colori
ACCIAIO 

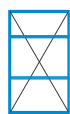

RAL 5012
+ ZINCATO
.54



RAL 7035
+ ZINCATO
.55







FIANCATA ALTEZZA 2500 mm H

ZINCATO

ART.	profondità	
 F ST 0250 30 99	300 mm	
 F ST 0250 40 99	400 mm	
 F ST 0250 50 99	500 mm	
 F ST 0250 60 99	600 mm	
 F ST 0250 80 99	800 mm	

Fiancata con 6 traversini

VERNICIATO

ART.		profondità	
 F ST 0250 30 _ _		300 mm	
 F ST 0250 40 _ _		400 mm	
 F ST 0250 50 _ _		500 mm	
 F ST 0250 60 _ _		600 mm	
 F ST 0250 80 _ _		800 mm	

Fiancata con 6 traversini









FIANCATA ALTEZZA 3000 mm H

ZINCATO

ART.	profondità	
 F ST 0300 30 99	300 mm	
 F ST 0300 40 99	400 mm	
 F ST 0300 50 99	500 mm	
 F ST 0300 60 99	600 mm	
 F ST 0300 80 99	800 mm	

Fiancata con 6 traversini

VERNICIATO

ART.		profondità	
 F ST 0300 30 _ _		300 mm	
 F ST 0300 40 _ _		400 mm	
 F ST 0300 50 _ _		500 mm	
 F ST 0300 60 _ _		600 mm	
 F ST 0300 80 _ _		800 mm	

Fiancata con 6 traversini



FISSAGGIO

STAFFA DI FISSAGGIO ALLA PARETE

ART. F ST 0710 00 99

Tutte le fiancate con obbligo di fissaggio alla parete, vengono fornite di serie con le apposite staffe di fissaggio.



SET DI FISSAGGIO A PAVIMENTO

ART. F NC 8999 00 99

Materiale di fissaggio composto da 2 viti ad espansione in acciaio M8x75 mm per pavimenti in calcestruzzo non fessurato uguali o maggiori alla classe: C20/25.



SET DI FISSAGGIO TRA FIANCATE

ART. F ST 0720 00 99

Le clips sono costruite in acciaio zincato e vengono inserite nella parte posteriore delle fiancate. Ogni set di fissaggio è composto da 4 clips fornite zincate.



TUTTE LE FIANCATE VENGONO FORNITE SMONTATE E COMPLETE DI PIEDINI

SYSTEM F ST

FIANCATE CON TRAVERSINI E PARETI CENTRALI

FIANCATA ALTEZZA 1000 mm H



ZINCATO

ART.	profondità
F ST 0101 30 99	300 mm
F ST 0101 40 99	400 mm
F ST 0101 50 99	500 mm
F ST 0101 60 99	600 mm
F ST 0101 80 99	800 mm

Fiancata con 2 traversini e parete centrale

VERNICIATO

ART.	profondità
F ST 0101 30 __	300 mm
F ST 0101 40 __	400 mm
F ST 0101 50 __	500 mm
F ST 0101 60 __	600 mm
F ST 0101 80 __	800 mm

Fiancata con 2 traversini e parete centrale

FIANCATA ALTEZZA 2000 mm H



ZINCATO

ART.	profondità
F ST 0202 30 99	300 mm
F ST 0202 40 99	400 mm
F ST 0202 50 99	500 mm
F ST 0202 60 99	600 mm
F ST 0202 80 99	800 mm

Fiancata con 2 traversini e pareti centrali

VERNICIATO

ART.	profondità
F ST 0202 30 __	300 mm
F ST 0202 40 __	400 mm
F ST 0202 50 __	500 mm
F ST 0202 60 __	600 mm
F ST 0202 80 __	800 mm

Fiancata con 2 traversini e pareti centrali

FIANCATA ALTEZZA 2200 mm H



ZINCATO

ART.	profondità
F ST 0223 30 99	300 mm
F ST 0223 40 99	400 mm
F ST 0223 50 99	500 mm
F ST 0223 60 99	600 mm
F ST 0223 80 99	800 mm

Fiancata con 2 traversini e pareti centrali

VERNICIATO

ART.	profondità
F ST 0223 30 __	300 mm
F ST 0223 40 __	400 mm
F ST 0223 50 __	500 mm
F ST 0223 60 __	600 mm
F ST 0223 80 __	800 mm

Fiancata con 2 traversini e pareti centrali

Gamma colori
ACCIAIO

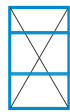

RAL 5012
+ ZINCATO
.54



RAL 7035 +
ZINCATO
.55

FIANCATA ALTEZZA 2500 mm H

ZINCATO

ART.	profondità
F ST 0254 30 99	300 mm
F ST 0254 40 99	400 mm
F ST 0254 50 99	500 mm
F ST 0254 60 99	600 mm
F ST 0254 80 99	800 mm

Fiancata con 2 traversini e pareti centrali

VERNICIATO

ART.	profondità
F ST 0254 30 __	300 mm
F ST 0254 40 __	400 mm
F ST 0254 50 __	500 mm
F ST 0254 60 __	600 mm
F ST 0254 80 __	800 mm

Fiancata con 2 traversini e pareti centrali



FIANCATA ALTEZZA 3000 mm H

ZINCATO

ART.	profondità
F ST 0305 30 99	300 mm
F ST 0305 40 99	400 mm
F ST 0305 50 99	500 mm
F ST 0305 60 99	600 mm
F ST 0305 80 99	800 mm

Fiancata con 2 traversini e pareti centrali

VERNICIATO

ART.	profondità
F ST 0305 30 __	300 mm
F ST 0305 40 __	400 mm
F ST 0305 50 __	500 mm
F ST 0305 60 __	600 mm
F ST 0305 80 __	800 mm

Fiancata con 2 traversini e pareti centrali



FISSAGGIO

STAFFA DI FISSAGGIO ALLA PARETE

ART. F ST 0710 00 99

Tutte le fiancate con obbligo di fissaggio alla parete, vengono fornite di serie con le apposite staffe di fissaggio.



SET DI FISSAGGIO A PAVIMENTO

ART. F NC 8999 00 99

Materiale di fissaggio composto da 2 viti ad espansione in acciaio M8x75 mm per pavimenti in calcestruzzo non fessurato uguali o maggiori alla classe: C20/25.



SET DI FISSAGGIO TRA FIANCATE

ART. F ST 0720 00 99

Le clips sono costruite in acciaio zincato e vengono inserite nella parte posteriore delle fiancate. Ogni set di fissaggio è composto da 4 clips fornite zincate.



TUTTE LE FIANCATE VENGONO FORNITE SMONTATE E COMPLETE DI PIEDINI

SYSTEM F ST

PIANI FESSURATI

I piani sono fessurati a passo 40,5 mm per l'inserimento di separatori o divisori verticali. Sui lati lunghi presentano una speciale modanatura che conferisce ai piani una struttura particolarmente robusta. Con l'inserimento di rinforzi, applicabili senza viti, si può aumentare la portata dei piani.



Fornito con 4 ganci

←→ 1000 mm

ZINCATO

ART.	dim. mm	n. rinforzi	kg
F ST 1030 00 99	300x35 H	-	120
F ST 1040 00 99	400x35 H	-	120
F ST 1040 01 99	400x35 H	1	300
F ST 1050 00 99	500x35 H	-	120
F ST 1050 01 99	500x35 H	1	300
F ST 1050 02 99	500x35 H	2	400
F ST 1060 00 99	600x35 H	-	120
F ST 1060 01 99	600x35 H	1	300
F ST 1060 02 99	600x35 H	2	400
F ST 1080 00 99	800x35 H	-	120
F ST 1080 01 99	800x35 H	1	300
F ST 1080 02 99	800x35 H	2	400

←→ 1300 mm

ZINCATO

ART.	dim. mm	n. rinforzi	kg
F ST 1130 00 99	300x35 H	-	100
F ST 1140 00 99	400x35 H	-	100
F ST 1140 01 99	400x35 H	1	230
F ST 1150 00 99	500x35 H	-	100
F ST 1150 01 99	500x35 H	1	230
F ST 1150 02 99	500x35 H	2	300
F ST 1160 00 99	600x35 H	-	100
F ST 1160 01 99	600x35 H	1	230
F ST 1160 02 99	600x35 H	2	300
F ST 1180 00 99	800x35 H	-	100
F ST 1180 01 99	800x35 H	1	230
F ST 1180 02 99	800x35 H	2	300

VERNICIATO

ART.	dim. mm	n. rinforzi	kg
F ST 1030 00 __	300x35 H	-	120
F ST 1040 00 __	400x35 H	-	120
F ST 1040 01 __	400x35 H	1	300
F ST 1050 00 __	500x35 H	-	120
F ST 1050 01 __	500x35 H	1	300
F ST 1050 02 __	500x35 H	2	400
F ST 1060 00 __	600x35 H	-	120
F ST 1060 01 __	600x35 H	1	300
F ST 1060 02 __	600x35 H	2	400
F ST 1080 00 __	800x35 H	-	120
F ST 1080 01 __	800x35 H	1	300
F ST 1080 02 __	800x35 H	2	400

VERNICIATO

ART.	dim. mm	n. rinforzi	kg
F ST 1130 00 __	300x35 H	-	100
F ST 1140 00 __	400x35 H	-	100
F ST 1140 01 __	400x35 H	1	230
F ST 1150 00 __	500x35 H	-	100
F ST 1150 01 __	500x35 H	1	230
F ST 1150 02 __	500x35 H	2	300
F ST 1160 00 __	600x35 H	-	100
F ST 1160 01 __	600x35 H	1	230
F ST 1160 02 __	600x35 H	2	300
F ST 1180 00 __	800x35 H	-	100
F ST 1180 01 __	800x35 H	1	230
F ST 1180 02 __	800x35 H	2	300

Gamma colori
ACCIAIO



RAL 5012
.04

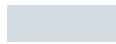

RAL 7035
.08



TUTTI I PIANI DI QUESTA SERIE VENGONO FORNITI CON ETICHETTA DI PORTATA

↔ 1000 mm



RINFORZO ZINCATO DI RICAMBIO

ART. R FST 0005 99

↔ 1300 mm



RINFORZO ZINCATO DI RICAMBIO

ART. R FST 0006 99



SET 2 RINFORZI ZINCATI DI RICAMBIO
LATERALI PER PIANI PROFONDITÀ 800 mm

ART. R FST 0004 99

Per gentile concessione di Animo S.p.A.



SYSTEM F ST

Gamma colori
ACCIAIO 

RAL 5012
.04

RAL 7035
.08

PARETI POSTERIORI

Anche le pareti posteriori vengono agganciate allo scaffale dalla parte anteriore dello stesso senza l'ausilio di viti. Questo sistema facilita il montaggio specialmente se lo scaffale viene posizionato a ridosso della parete. Fornite in più pezzi a seconda dell'altezza dello scaffale.



↔ 1000 mm

ZINCATO

ART.	dim. mm
F ST 2020 10 99	1000x2000 H
F ST 2022 10 99	1000x2200 H
F ST 2025 10 99	1000x2500 H
F ST 2030 10 99	1000x3000 H

↔ 1300 mm

ZINCATO

ART.	dim. mm
F ST 2020 13 99	1300x2000 H
F ST 2022 13 99	1300x2200 H
F ST 2025 13 99	1300x2500 H
F ST 2030 13 99	1300x3000 H

VERNICIATO

ART.		dim. mm
F ST 2020 10 _ _		1000x2000 H
F ST 2022 10 _ _		1000x2200 H
F ST 2025 10 _ _		1000x2500 H
F ST 2030 10 _ _		1000x3000 H

VERNICIATO

ART.		dim. mm
F ST 2020 13 _ _		1300x2000 H
F ST 2022 13 _ _		1300x2200 H
F ST 2025 13 _ _		1300x2500 H
F ST 2030 13 _ _		1300x3000 H

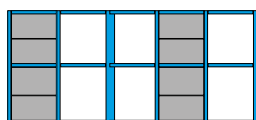

E' OBBLIGATORIO ALMENO OGNI 3 CAMPATE MONTARE UNA PARETE POSTERIORE.

TRAVERSI DI IRRIGIDIMENTO

Questo set è composto da 4 traversi di irrigidimento completi di 8 supporti e viene utilizzato per irrigidire la scaffalatura senza dovere utilizzare crociere o chiusure posteriori.
Per ogni campata devono essere applicati 2 traversi nella parte superiore e 2 traversi nella parte inferiore.



ART.	Per campate lunghezza mm
F ST 9550 01 99	1000
F ST 9560 01 99	1300

Forniti zincati
Set di 4 traversi di irrigidimento completi di 8 supporti



E' OBBLIGATORIO MONTARE IL SET DEI TRAVERSI DI IRRIGIDIMENTO SU OGNI CAMPATA.

SYSTEM F ST

CROCIERE DI IRRIGIDIMENTO

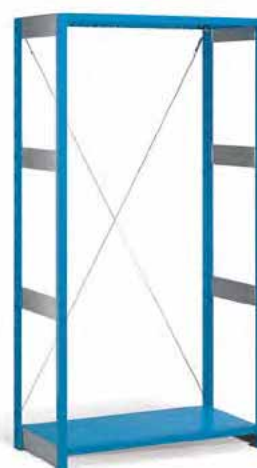

Le crociere vengono agganciate allo scaffale nella parte anteriore dello stesso senza l'ausilio di viti. Questo sistema facilita il montaggio specialmente se lo scaffale viene posizionato a ridosso della parete.

←→ 1000 mm

ART.	dim. mm
F ST 7110 00 99	1000x1000 H
F ST 7120 00 99	1000x2000 H
F ST 7122 00 99	1000x2200 H
F ST 7125 00 99	1000x2500 H
F ST 7130 00 99	1000x3000 H

Fornite zincate

←→ 1300 mm

ART.	dim. mm
F ST 7210 00 99	1300x1000 H
F ST 7220 00 99	1300x2000 H
F ST 7222 00 99	1300x2200 H
F ST 7225 00 99	1300x2500 H
F ST 7230 00 99	1300x3000 H

Fornite zincate

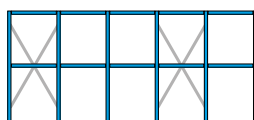

E' OBBLIGATORIO ALMENO OGNI 3 CAMPATE MONTARE UNA CROCIERA.

RETI POSTERIORI

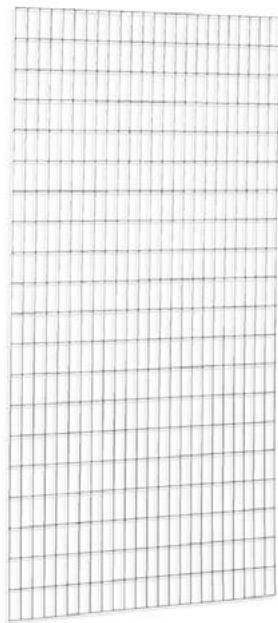

Dim. maglia rete 40,5x100 mm H

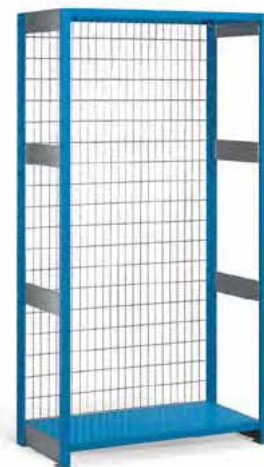

Le reti posteriori vengono agganciate allo scaffale nella parte anteriore dello stesso senza l'ausilio di viti tramite degli appositi ganci zincati. Questo sistema facilita il montaggio specialmente se lo scaffale viene posizionato a ridosso della parete.

↔ 1000 mm

ART.	dim. mm
F ST 2820 10 99	1000x2000 H
F ST 2822 10 99	1000x2200 H
F ST 2825 10 99	1000x2500 H
F ST 2830 10 99	1000x3000 H

Fornite zincate

↔ 1300 mm

ART.	dim. mm
F ST 2820 13 99	1300x2000 H
F ST 2822 13 99	1300x2200 H
F ST 2825 13 99	1300x2500 H
F ST 2830 13 99	1300x3000 H

Fornite zincate

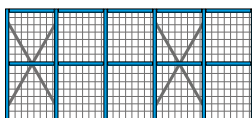

E' OBBLIGATORIO ALMENO OGNI 3 CAMPATE MONTARE UNA CROCIERA.

**SET DI 14 GANCI DI RICAMBIO
ZINCATI PER RETI**

ART. R FST 0002 99

SYSTEM F ST

Gamma colori
ACCIAIO



RAL 5012
.04



RAL 7035
.08



PARETI LATERALI NON FORATE



Le pareti laterali vengono montate nella fiancata tramite apposite clips e senza l'ausilio di viti

ZINCATO

1000 mm

ART.	Per fiancate dim. mm
F ST 2210 30 99	300x1000 H
F ST 2210 40 99	400x1000 H
F ST 2210 50 99	500x1000 H
F ST 2210 60 99	600x1000 H
F ST 2210 80 99	800x1000 H

2000 mm

F ST 2220 30 99	300x2000 H
F ST 2220 40 99	400x2000 H
F ST 2220 50 99	500x2000 H
F ST 2220 60 99	600x2000 H
F ST 2220 80 99	800x2000 H

2200 mm

F ST 2222 30 99	300x2200 H
F ST 2222 40 99	400x2200 h
F ST 2222 50 99	500x2200 H
F ST 2222 60 99	600x2200 H
F ST 2222 80 99	800x2200 H

2500 mm

F ST 2225 30 99	300x2500 H
F ST 2225 40 99	400x2500 H
F ST 2225 50 99	500x2500 H
F ST 2225 60 99	600x2500 H
F ST 2225 80 99	800x2500 H

3000 mm

F ST 2230 30 99	300x3000 H
F ST 2230 40 99	400x3000 H
F ST 2230 50 99	500x3000 H
F ST 2230 60 99	600x3000 H
F ST 2230 80 99	800x3000 H

VERNICIATO

ART.	Per fiancate dim. mm
F ST 2210 30 __	300x1000 H
F ST 2210 40 __	400x1000 H
F ST 2210 50 __	500x1000 H
F ST 2210 60 __	600x1000 H
F ST 2210 80 __	800x1000 H

F ST 2220 30 __	300x2000 H
F ST 2220 40 __	400x2000 H
F ST 2220 50 __	500x2000 H
F ST 2220 60 __	600x2000 H
F ST 2220 80 __	800x2000 H

F ST 2222 30 __	300x2200 H
F ST 2222 40 __	400x2200 H
F ST 2222 50 __	500x2200 H
F ST 2222 60 __	600x2200 H
F ST 2222 80 __	800x2200 H

F ST 2225 30 __	300x2500 H
F ST 2225 40 __	400x2500 H
F ST 2225 50 __	500x2500 H
F ST 2225 60 __	600x2500 H
F ST 2225 80 __	800x2500 H

F ST 2230 30 __	300x3000 H
F ST 2230 40 __	400x3000 H
F ST 2230 50 __	500x3000 H
F ST 2230 60 __	600x3000 H
F ST 2230 80 __	800x3000 H

Gamma colori
ACCIAIO



PARETI LATERALI FORATE



Le pareti laterali vengono montate nella fiancata tramite apposite clips e senza l'ausilio di viti

ZINCATO

1000 mm

ART.	Per fiancate dim. mm
F ST 2310 30 99	300x1000 H
F ST 2310 40 99	400x1000 H
F ST 2310 50 99	500x1000 H
F ST 2310 60 99	600x1000 H
F ST 2310 80 99	800x1000 H

2000 mm

F ST 2320 30 99	300x2000 H
F ST 2320 40 99	400x2000 H
F ST 2320 50 99	500x2000 H
F ST 2320 60 99	600x2000 H
F ST 2320 80 99	800x2000 H

2200 mm

F ST 2322 30 99	300x2200 H
F ST 2322 40 99	400x2200 H
F ST 2322 50 99	500x2200 H
F ST 2322 60 99	600x2200 H
F ST 2322 80 99	800x2200 H

2500 mm

F ST 2325 30 99	300x2500 H
F ST 2325 40 99	400x2500 H
F ST 2325 50 99	500x2500 H
F ST 2325 60 99	600x2500 H
F ST 2325 80 99	800x2500 H

3000 mm

F ST 2330 30 99	300x3000 H
F ST 2330 40 99	400x3000 H
F ST 2330 50 99	500x3000 H
F ST 2330 60 99	600x3000 H
F ST 2330 80 99	800x3000 H

VERNICIATO

ART.	Per fiancate dim. mm
F ST 2310 30 __	300x1000 H
F ST 2310 40 __	400x1000 H
F ST 2310 50 __	500x1000 H
F ST 2310 60 __	600x1000 H
F ST 2310 80 __	800x1000 H

F ST 2320 30 __	300x2000 H
F ST 2320 40 __	400x2000 H
F ST 2320 50 __	500x2000 H
F ST 2320 60 __	600x2000 H
F ST 2320 80 __	800x2000 H

F ST 2322 30 __	300x2200 H
F ST 2322 40 __	400x2200 H
F ST 2322 50 __	500x2200 H
F ST 2322 60 __	600x2200 H
F ST 2322 80 __	800x2200 H

F ST 2325 30 __	300x2500 H
F ST 2325 40 __	400x2500 H
F ST 2325 50 __	500x2500 H
F ST 2325 60 __	600x2500 H
F ST 2325 80 __	800x2500 H

F ST 2330 30 __	300x3000 H
F ST 2330 40 __	400x3000 H
F ST 2330 50 __	500x3000 H
F ST 2330 60 __	600x3000 H
F ST 2330 80 __	800x3000 H

SYSTEM F ST

Gamma colori
ACCIAIO



RAL 5012
.04



RAL 7035
.08

PORTE A BATTENTE



ART.		dim. mm	
F ST 5110 00 _ _		1000x1000 H	key
F ST 5120 00 _ _		1000x2000 H	key
F ST 5210 00 _ _		1300x1000 H	key
F ST 5220 00 _ _		1300x2000 H	key

Le porte a battente hanno un ingombro in profondità di 22 mm e un coppia di porte chiude 1 campata. Fornite per le campate di lunghezza 1000 mm e 1300 mm sono di facile montaggio (per una coppia di porte vengono utilizzate soltanto 4 viti). Le porte sono provviste di chiusura a cilindro con 2 chiavi.

PORTE SCORREVOLI



ART.		dim. mm	
F ST 5720 00 _ _		2000x2000 H	key
F ST 5820 00 _ _		2600x2000 H	key

Le porte scorrevoli hanno un ingombro in profondità di 80 mm e una coppia di porte chiude 2 campate. Fornite per le campate di lunghezza 1000 mm e 1300 mm sono di facile montaggio (per una coppia di porte vengono utilizzate soltanto 6 viti). Le porte sono provviste di serratura di sicurezza e due chiavi.

ZOCCOLI



Gli zoccoli vengono utilizzati come chiusura della parte inferiore dello scaffale. Montati senza viti sono forniti in due lunghezze di 1000 mm e 1300 mm

ZINCATO

ART.	dim. mm
F ST 7510 00 99	1000
F ST 7520 00 99	1300

VERNICIATO

ART.		dim. mm
F ST 7510 00 _ _		1000
F ST 7520 00 _ _		1300

DIVISORI VERTICALI ZINCATI PER PIANI



PROFONDITA' SCAFFALE 400 mm

ART.	Spazio utile mm	Distanza tra i piani mm
F ST 9030 00 99	165	200
F ST 9035 00 99	215	250
F ST 9040 00 99	265	300
F ST 9045 00 99	315	350
F ST 9050 00 99	365	400
F ST 9055 00 99	415	450

PROFONDITA' SCAFFALE 600 mm

ART.	Spazio utile mm	Distanza tra i piani mm
F ST 9090 00 99	165	200
F ST 9095 00 99	215	250
F ST 9100 00 99	265	300
F ST 9105 00 99	315	350
F ST 9110 00 99	365	400
F ST 9115 00 99	415	450

PROFONDITA' SCAFFALE 300 mm

ART.	Spazio utile mm	Distanza tra i piani mm
F ST 9000 00 99	165	200
F ST 9005 00 99	215	250
F ST 9010 00 99	265	300
F ST 9015 00 99	315	350
F ST 9020 00 99	365	400
F ST 9025 00 99	415	450

PROFONDITA' SCAFFALE 500 mm

ART.	Spazio utile mm	Distanza tra i piani mm
F ST 9060 00 99	165	200
F ST 9065 00 99	215	250
F ST 9070 00 99	265	300
F ST 9075 00 99	315	350
F ST 9080 00 99	365	400
F ST 9085 00 99	415	450

PROFONDITA' SCAFFALE 800 mm

ART.	Spazio utile mm	Distanza tra i piani mm
F ST 9150 00 99	165	200
F ST 9155 00 99	215	250
F ST 9160 00 99	265	300
F ST 9165 00 99	315	350
F ST 9170 00 99	365	400
F ST 9175 00 99	415	450



SYSTEM F ST

SEPARATORI ZINCATI PER PIANI



ART.	Profondità scaffale mm
F ST 9230 00 99	300
F ST 9240 00 99	400
F ST 9250 00 99	500
F ST 9260 00 99	600
F ST 9280 00 99	800

I separatori vengono inseriti nelle fessurazioni dei piani con passo 40,5 mm. Hanno un'altezza di 100 mm e sono forniti esclusivamente zincati.

La distanza dei piani, per permetterne l'inserimento, deve essere minimo di 150 mm.

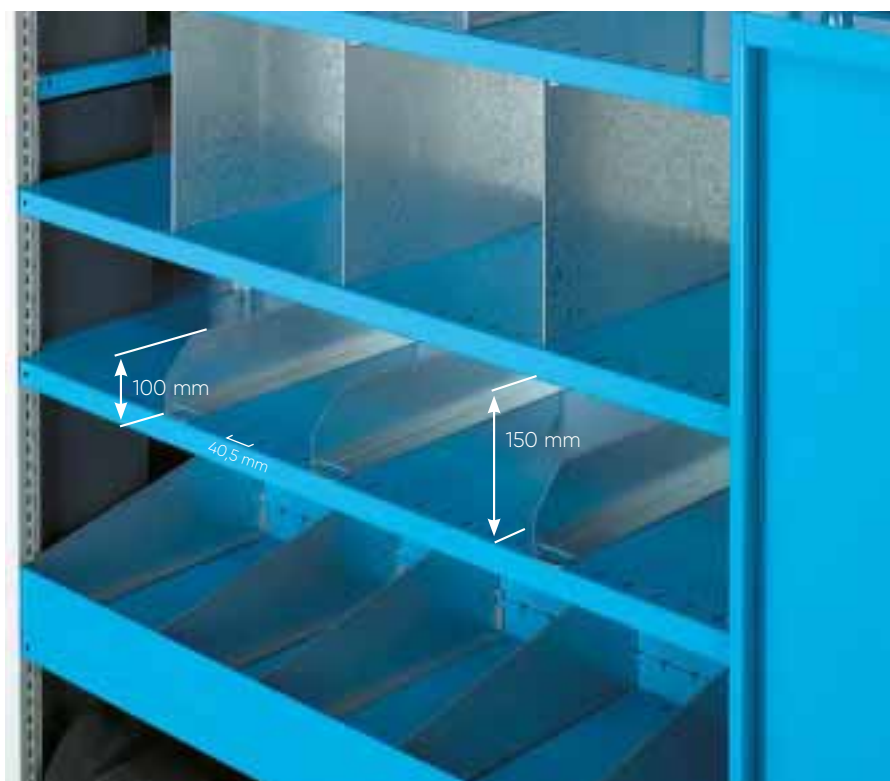

Gamma colori
ACCIAIO



ZINCATO
.99

SET BANDINELLE CON 2 DIVISORI TRAPEZOIDALI



ZINCATO

ART.	Profondità scaffale mm
F ST 9510 30 99	300
F ST 9510 40 99	400
F ST 9510 50 99	500
F ST 9510 60 99	600

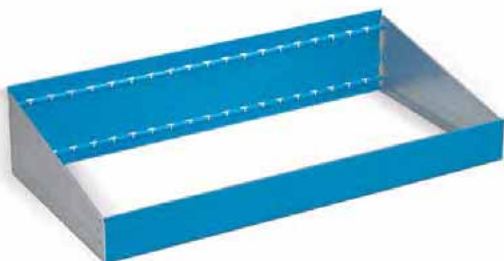

ZINCATO

ART.	Profondità scaffale mm
F ST 9520 30 99	300
F ST 9520 40 99	400
F ST 9520 50 99	500
F ST 9520 60 99	600



Entrambe le bandinelle sono provviste di una fessurazione con interasse di 50 mm per l'inserimento dei divisori. Il montaggio risulta facile e rapido e senza l'utilizzo di viti.

DIVISORI TRAPEZOIDALI ZINCATI AGGIUNTIVI



ART.	Profondità scaffale mm
F ST 9630 00 99	300
F ST 9640 00 99	400
F ST 9650 00 99	500
F ST 9660 00 99	600

SYSTEM F ST

Gamma colori
ACCIAIO 





RAL 5012
.04



RAL 7035
.08

CASSETTI AD ESTRAZIONE SEMPLICE





ART.		dim. utili mm	altezza frontale mm			
F ST 8510 00 _ _		906x447x85 H	100	50	88%	

Si possono inserire massimo 6 cassette per ogni campata e la massima altezza di inserimento è di 1000 mm.

CASSETTI AD ESTRAZIONE TELESCOPICA





ART.		dim. utili mm	altezza frontale mm			
F ST 8610 00 _ _		906x447x85 H	100	100	100%	

Si possono inserire massimo 3 cassette per ogni campata (oppure 6 se si riduce la portata a 50 kg) e la massima altezza di inserimento è di 1000 mm.

 I cassette possono essere forniti con guide ad estrazione semplice (estrazione pari a 88%) o telescopica (estrazione pari a 100%) con altezza frontale 100 mm. Le pareti interne fessurate e il fondo forato con passo 17 mm permettono un facile inserimento e fissaggio (tramite viti) dei divisori in metallo. Costruiti in lamiera di acciaio sono adatti solo per campate con lunghezza 1000 mm e profondità 500 mm.

TELAIO AD ESTRAZIONE TELESCOPICA PORTA CARTELLE SOSPENSE DIN A4



ART.	dim. mm			
F ST 7850 00 07	990x500	30	100%	

Colore nero RAL 9005

I telai sono adatti solo per campate con lunghezza 1000 mm e profondità 500 mm.

TRAVERSI DI COLLEGAMENTO TRA SCAFFALI

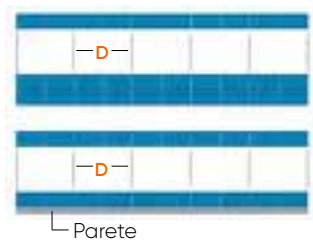

A	Fiancata con fissaggio tramite traverso.
B	Fiancata doppia con fissaggio a pavimento.
C	Fiancata singola con fissaggio a parete.
D	Traverso superiore di collegamento

- LE FIANCATE ESTERNE DEVONO ESSERE SEMPRE COLLEGATE
- LE FIANCATE INTERNE DEVO ESSERE COLLEGATE OGNI DUE CAMPATE.

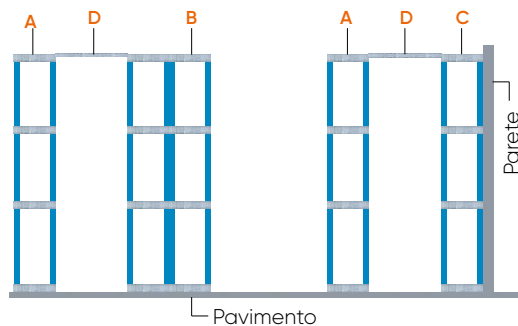

Il traversino di collegamento serve per le fiancate con l'obbligo di fissaggio alla parete ma che non hanno la possibilità di essere fissate alla parete stessa. In questo caso la fiancata in oggetto dovrà essere collegata ad una fiancata doppia con fissaggio a terra oppure ad una fiancata fissa a parete.

CORRIDOI:

Se con l'installazione della scaffalatura si vengono a creare passaggi o corridoi adiacenti alla stessa, la scaffalatura deve essere chiusa con pareti in lamiera o rete su tutti i lati non adibiti al prelievo del materiale, ed i corridoi o passaggi dovranno avere le seguenti larghezze:

- Corridoi adibiti al prelievo o deposito manuale di materiale nella scaffalatura priva di cassette e senza l'ausilio di carrelli spinti a mano : larghezza minima 800 mm.
- Corridoi adibiti al prelievo o deposito manuale di materiale con l'ausilio di carrelli spinti a mano , con o senza cassette nella scaffalatura: larghezza minima 1250 mm.
- Corridoi adibiti al passaggio del personale: larghezza minima 1250 mm.

I corridoi adibiti al prelievo e/o deposito dei materiali non possono essere utilizzati come passaggi per il personale. Per passaggi adibiti al passaggio di carrelli azionati a motore chiedere informazioni alla FAMI.

ATTENZIONE: nelle scaffalature doppie si devono obbligatoriamente montare, tra le due scaffalature, le chiusure posteriori o le reti posteriori o una fascia, in modo tale da evitare che in fase di carico del materiale, da un lato della scaffalatura, non ci sia il pericolo di spinta accidentale del materiale riposto dall'altro lato della scaffalatura.

Per gentile concessione di Animo S.p.A.



ART.	lunghezza mm
F ST 0820 00 99	800
F ST 0830 00 99	1000
F ST 0840 00 99	1250

Forniti zincati



SYSTEM F ST

GUIDE PER RK BOX



ART.	Profondità scaffale mm
F ST 9830 00 99	300
F ST 9840 00 99	400
F ST 9850 00 99	500
F ST 9860 00 99	600

Fornite zincate

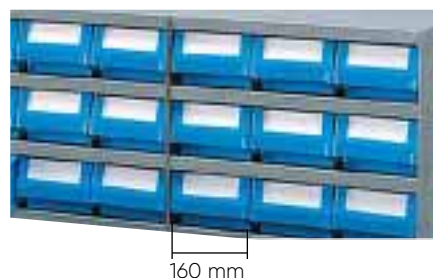
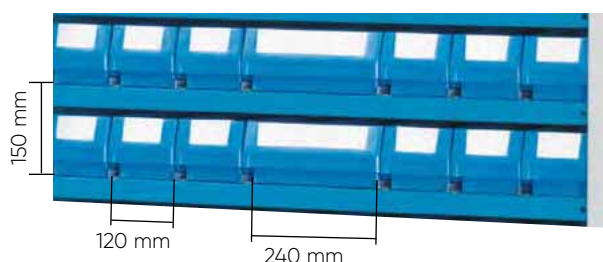

FERMI PER CASSETTE RK BOX

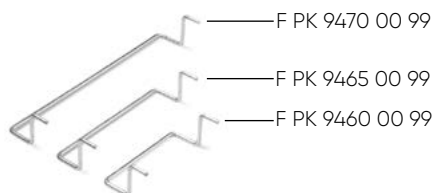

ART.	Per cassette	Ø mm
F PK 9460 00 99	FAX RB 3012 00	4,2
	FAX RB 4012 00	
	FAX RB 5012 00	
F PK 9465 00 99	FAX RB 3016 00	4,2
	FAX RB 4016 00	
	FAX RB 5016 00	
	FAX RB 6016 00	
F PK 9470 00 99	FAX RB 4024 00	4,2
	FAX RB 5024 00	

Realizzati in acciaio zincato, i fermi hanno la funzione di evitare la fuoriuscita accidentale della cassetta.



Se nella scaffalatura vengono utilizzate le cassette serie RK BOX, è obbligatorio inserire i perni di sicurezza in tutti i piani della scaffalatura stessa per evitare che, facendo leva sulla cassetta estratta, si possa sganciare il piano superiore.



SET PERNI DI SICUREZZA

ART. F ST 9996 00 99

Set di 2 perni di sicurezza zincati per il bloccaggio dei piani.



NON SI PUO' MONTARE IL RINFORZO NEI PIANI DOVE SI DEVONO INSERIRE GLI RK BOX CON IL FERMO.

RK BOX



SYSTEM F ST

ESEMPIO DI CONFIGURAZIONE DELLO SCAFFALE CON PIANI LUNGHEZZA 1000 mm

Separatori altezza minima indispensabile per l'inserimento 150 mm H

Cassette RK BOX larghezza 240 Max n. 4

Cassette RK BOX larghezza 160 Max n. 6

Cassette RK BOX larghezza 120 Max n. 6

Cassette RK BOX larghezza 240 Max n. 1

Cassetta EURO BOX dim. mm 400x300x55 H

Cassetta EURO BOX dim. mm 400x300x78 H

Cassetta EURO BOX dim. mm 400x300x120 H

Cassetta EURO BOX dim. mm 600x400x170 h

Cassetta PICKING BOX dim. mm 350/300x200x220 H

Cassetta EURO BOX dim. mm 600x400x220 H

Cassetta EURO BOX dim. mm 600x400x285 H

Cassetta EURO BOX dim. mm 600x400x325 H

Cassetta EURO BOX dim. mm 600x400x430 H

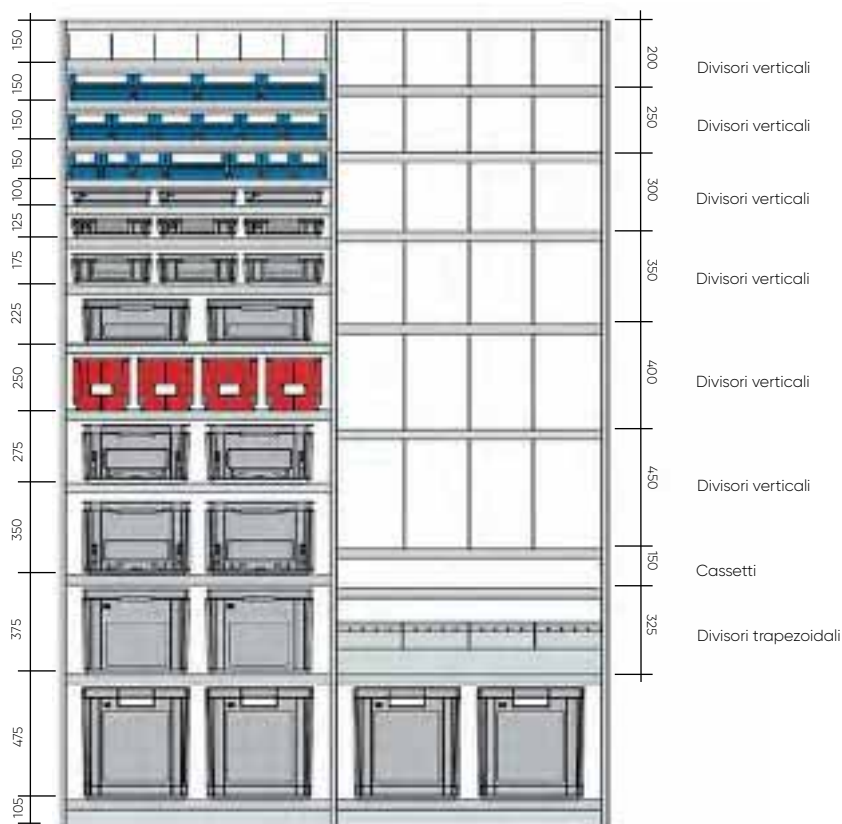

ESEMPIO DI CONFIGURAZIONE DELLO SCAFFALE CON PIANI LUNGHEZZA 1300 mm

Separatori altezza minima indispensabile per l'inserimento 150 mm H

Cassette RK BOX larghezza 240 Max n. 5

Cassette RK BOX larghezza 160 Max n. 7

Cassette RK BOX larghezza 120 Max n. 10

Cassetta EURO BOX dim. mm 400x300x55 H

Cassetta EURO BOX dim. mm 400x300x78 H

Cassetta EURO BOX dim. mm 400x300x120 H

Cassetta EURO BOX dim. mm 600x400x170 H

Cassetta PICKING BOX dim. mm 350/300x200x220 H

Cassetta EURO BOX dim. mm 600x400x220 H

Cassetta EURO BOX dim. mm 600x400x285 H

Cassetta EURO BOX dim. mm 600x400x325 H

Cassetta EURO BOX dim. mm 600x400x430 H

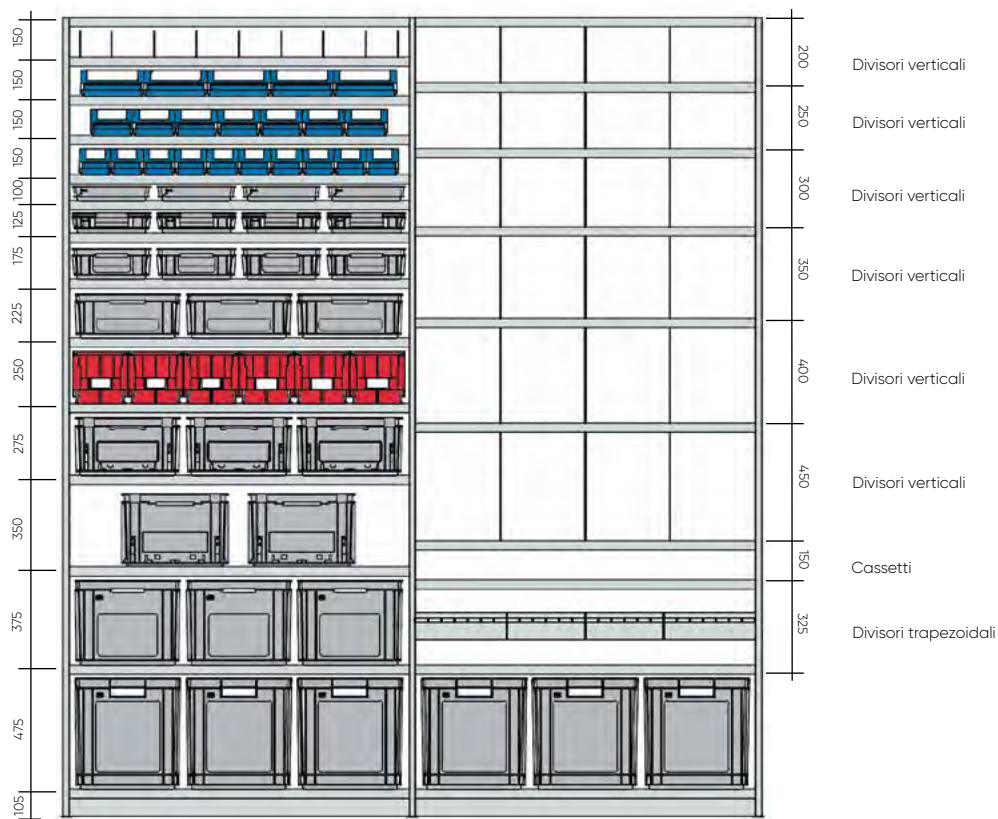

CARRELLO SCALA AUTOFRENANTE

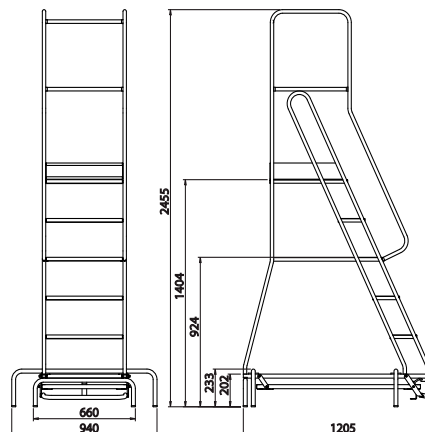

ART.



F CR 0300 00 01

150

Carrello scala autofrenante.
Colore grigio RAL 7000



Il carrello scala è fornito di serie con 4 ruote in gomma girevoli senza freni.



1



2



3

1. Facendo pressione sul primo scalino.
 2. il carrello scala scende in posizione di bloccaggio.
 3. premendo il pedale di sblocco.
- ... il carrello scala è pronto per essere spostato.



ART.

dim. mm

F CR 0800 00 01

200x545x180 H

Piano di appoggio

SYSTEM F ST

SCAFFALATURA PORTA PNEUMATICI



LA PARTICOLARE SAGOMATURA DEL PROFILO DEL SUPPORTO, RENDE PIU' SICURO L'APPOGGIO DEL PNEUMATICO.

ART.

dim. mm

F ST R200 41 99

2700x400x2000 H

Scaffale zincato con 6 coppie di supporti composto da: 1 campata base con 3 coppie di supporti lunghezza 1300 mm e 1 campata aggiuntiva con 3 coppie di supporti lunghezza 1300 mm.

PORTATA DI OGNI CAMPATA 250 kg





CAMPATA
BASE
ZINCATA

←→ 1000 mm

ART.	dim. mm	
■ F ST N200 40 99	400x2000 H	

←→ 1300 mm

ART.	dim. mm	
■ F ST T200 40 99	400x2000 H	



CAMPATA
AGGIUNTIVA
ZINCATA

←→ 1000 mm

ART.	dim. mm	
■ F ST P200 40 99	400x2000 H	

←→ 1300 mm

ART.	dim. mm	
■ F ST U200 40 99	400x2000 H	

COMPLETI DI 3 COPPIE SUPPORTI



Le campate vengono fornite smontate, complete di piedini e chiave a brugola per il fissaggio a pavimento.



COPPIA SUPPORTI ZINCATI

La particolare sagomatura del profilo del supporto, rende più sicuro l'appoggio del pneumatico

ART.	←→	kg
F ST 9580 00 99	1000 mm	50

Coppia supporti porta pneumatici

ART.	←→	kg
F ST 9590 00 99	1300 mm	50

Coppia supporti porta pneumatici

SYSTEM F ST







DOMINO/TR



SCAFFALI CON CONTENITORI

LA GIUSTA COMBINAZIONE TRA L'ARMADIO

MASTER E LA SCAFFALATURA A PIANI

ROBUSTA VERSATILE

M O D U L A R E

3 TIPOLOGIE DI PORTE

BATTENTE, SCORREVOLI, TAPPARELLE

10 COLORI DISPONIBILI

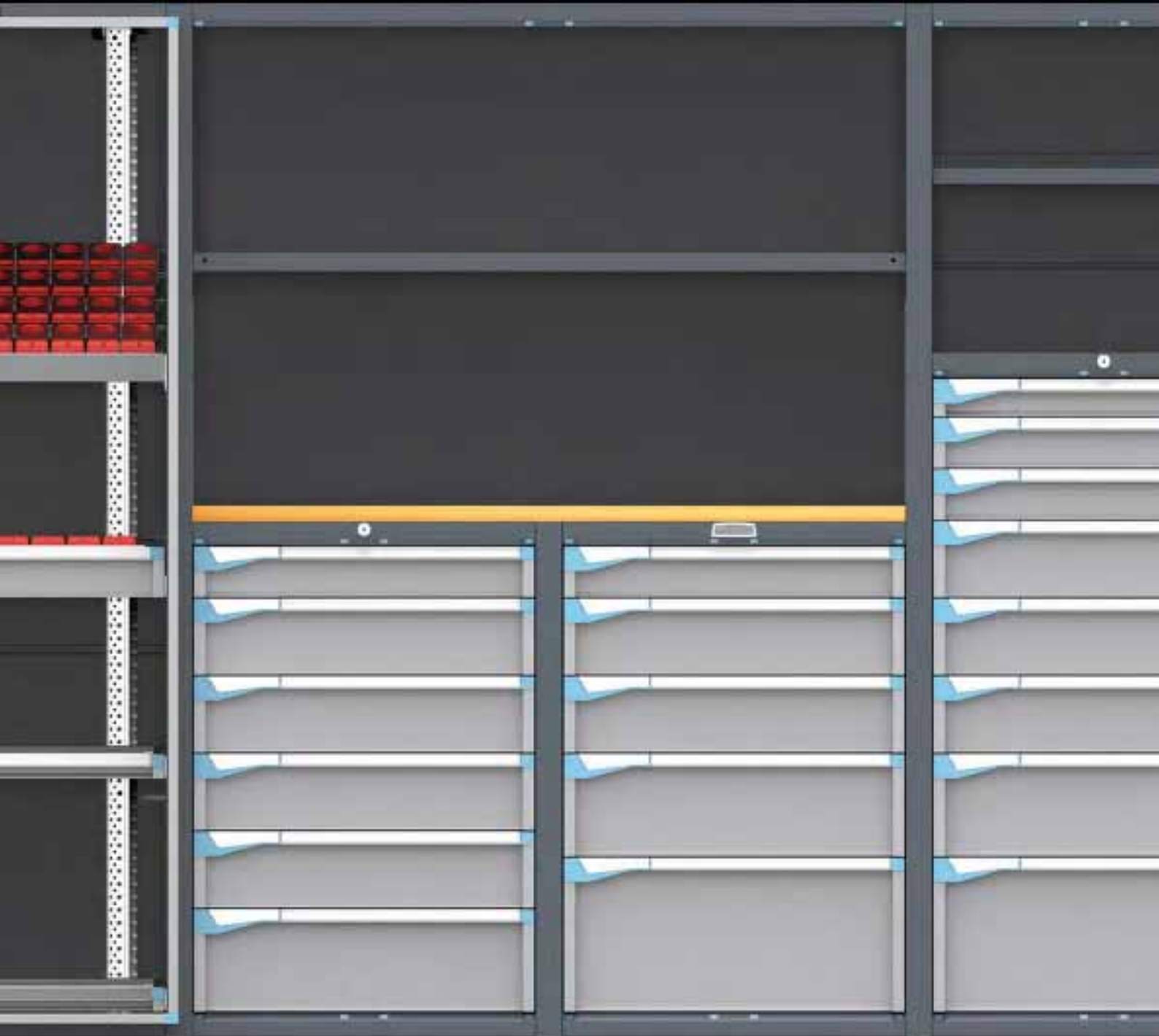

SYSTEM SR-MASTER

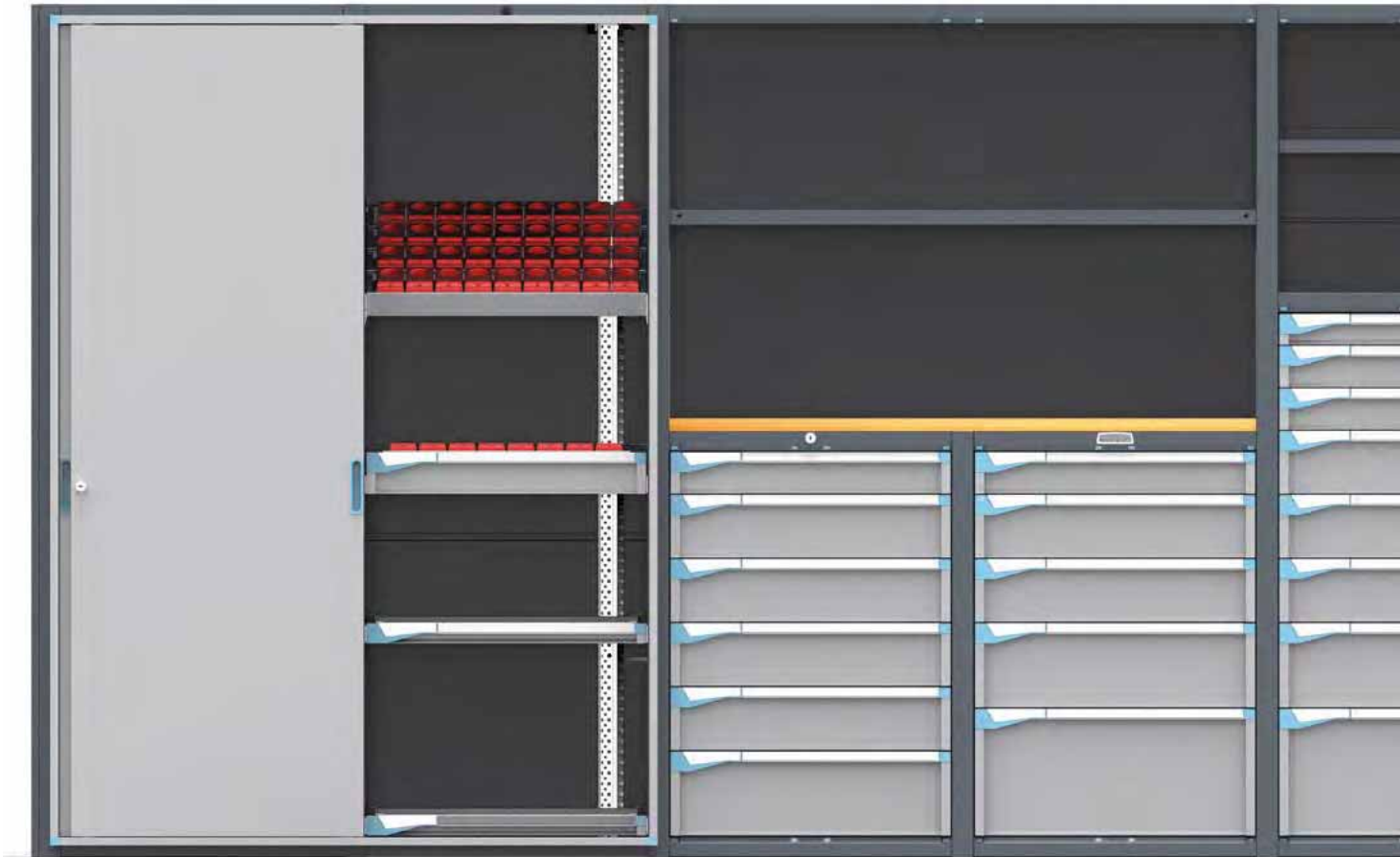

PORTATA PER CAMPATA

		mm
PORTATA PER CAMPATA	Distanza tra i piani di tenuta o per serrature	
4500	2000	
5000	1500	
5500	1000	

PIANI DI TENUTA O PIANI PER SERRATURE NECESSARI PER OGNI CAMPATA

mm	
ALTEZZA SCAFFALATURA	NUMERO PIANI DI TENUTA O PER SERRATURE
1000	2
1500	2
2000	2
2250	3
2500	3
3000	3



SICUREZZA

PIASTRA DI APPOGGIO A PAVIMENTO

La piastra di appoggio ha la funzione di distribuire la pressione esercitata sul pavimento dalla fiancata. Una scheda tecnica fornita dalla FAMI, permette di verificare l'idoneità del pavimento destinato al montaggio della scaffalatura.

trazione consigliata del tassello	5,6 kN
diametro tassello	Ø10 mm
diametro foro nel calcestruzzo	Ø10 mm
profondità minima del foro	h_1 70 mm
profondità minima di posa	h_{nom} 50 mm
spessore max fissabile	t_{fix} 20 mm
coppia di serraggio max	T_{inst} 25 NM

spessore min. del pavimento relativo al fissaggio del tassello *	H: 100 mm
distanza min. del fissaggio dal bordo del pavimento	B: 50 mm
zona di influenza del tassello **	A: 75 mm
distanza min. del montante dal bordo del pavimento	C: 0 mm

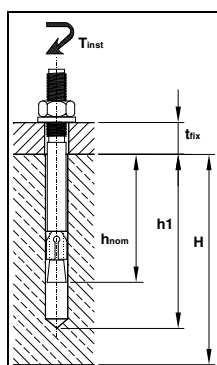

* È obbligatorio verificare che il pavimento su cui appoggia la scaffalatura sia idoneo a sopportare la pressione e il valore di punzonamento (foratura) esercitata dalla scaffalatura stessa e la trazione esercitata dal tassello.

** La zona deve rimanere libera dall'azione di qualsiasi altra forza.

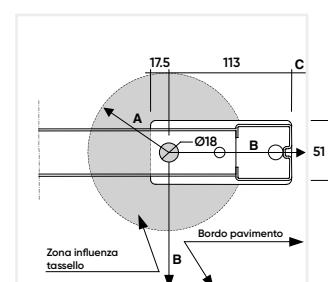

CARATTERISTICHE TECNICHE

I nuovi scaffali serie SYSTEM SR-MASTER coniugano i benefici di uno scaffale a piani con la tecnologia e l'unicità di un armadio custodia utensili Master, per offrire soluzioni modulari di logistica innovative, performanti, sicure e personalizzate, con varianti esclusive nel mercato degli arredamenti industriali.

COLORI

ARMADIO

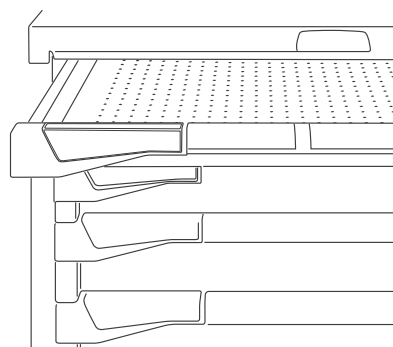

10 colori per la parte metallica



8 colori per gli accessori plastici



MANIGLIA FRONTALE



FIANCATA

In profilato d'acciaio, presenta su ambo i lati una fessurazione con passo 25 mm. Gli elementi che la compongono, montanti, traversini di collegamento e piedini, sono saldati tra loro e questo permette di avere una portata fino a 5.500 kg per campata.



PARETI LATERALI, CENTRALI E POSTERIORI

Le pareti laterali, centrali e posteriori sono costruite in lamiera d'acciaio, unite formano dei vani chiusi.



ACCESSORI

SEPARATORI

Vengono inseriti nelle fessurazioni dei piani con passo 40,5 mm. Hanno un'altezza variabile dai 100 ai 200 mm e sono forniti esclusivamente zincati. Ideali per organizzare e ottimizzare gli spazi sul piano.



TELAI PORTA BOCCOLE

Utili per immagazzinare utensili NC, possono essere inseriti nei cassetti o sospesi tra le fiancate. Indispensabile supporto per macchine a controllo numerico, proteggono da urti e polvere, organizzano lo spazio e ottimizzano i tempi di prelievo.



MATERIALE DI SEPARAZIONE

Divisori longitudinali, trasversali, a 2-3-4 canali e cassette divisorio permettono di suddividere lo spazio dei cassetti in modo razionale e sulle specifiche esigenze dell'operatore.



ESTRAZIONE FLESSIBILE

Nuova guida ad estrazione flessibile con regolazione meccanica del fermo posteriore del cassetto/piano estraibile, in 3 diverse posizioni. Permette di ottenere 3 portate differenti: 50, 75, 100 kg.

✓ syFLEX

Sistema di apertura brevettato che permette di configurare l'estrazione e la portata direttamente dall'utilizzatore.



92% = 100 kg
96% = 75 kg
100% = 50 kg

ESTRAZIONE TELESCOPICA

Nuova guida ad estrazione telescopica (estraibilità 100%) che garantisce una portata di 200 kg nelle 10 dimensioni disponibili dell'armadio Master.

ASTA VERTEBRATA

È IL CUORE E IL CERVELLO DEL SISTEMA

L'asta è in profilato d'alluminio e rimane sempre fissa, senza ruotare. Il movimento di chiusura è ottenuto da tasselli che si spostano verticalmente sfruttando una delle forze elementari della fisica: la gravità. Più il movimento è semplice, meno probabilità di rotture ci sono. La chiusura dell'asta è affidata a un sistema a catenaccio posto sulla testa dell'asta.



CASSETTI E PIANI ESTRAIBILI



I cassetti/piani estraibili della serie Master possono montare indipendentemente sia le guide ad estrazione flessibile che telescopica.



PIANI REGOLABILI, PIANI DI TENUTA/PER SERRATURE

I piani intermedi regolabili in altezza, sostenuti da 4 ganci, sono disponibili fessurati, per alloggiare separatori, con portata dai 100 ai 200 kg e non fessurati con portata dai 70 ai 150 kg.

I piani di tenuta, fissati con viti alle fiancate, sono le "colonne portanti" della scaffalatura e variano di numero (2-3) in relazione all'altezza. Portata di 250 kg.

I piani per serrature, che svolgono la stessa funzione portante dei piani di tenuta, sono predisposti per alloggiare la chiusura con cilindro o con codice numerico e sostenere l'asta vertebrata. Portata di 150 kg.



PORTE SCORREVOLI

Sono realizzate in lamiera d'acciaio debitamente sagomata per garantirne la solidità, con un ingombro in profondità di 50 mm. Le porte servono per proteggere la merce da urti e polvere. Provviste di chiusura a cilindro con due chiavi.



TAPPARELLE

Le tapparelle sono in materiale plastico grigio con maniglia in lamiera di acciaio e chiusura a cilindro integrata. Ideali per spazi ristretti, dove non è possibile utilizzare le porte a battente, si muovono lungo i montanti su guide verticali.



CHIUSURA CON CILINDRO

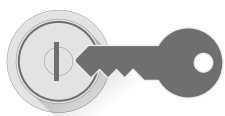

Sistema di trasmissione dal cilindro della chiusura alla testa dell'asta vertebrata a filo di acciaio con guaina elastica e movimento lineare.

La chiusura a cilindro è suddivisa in 23 diverse serie: ogni serie ha una numerazione delle chiavi compresa tra 1 e 160, per un totale di 3.680 diverse combinazioni.

FORNITA DI SERIE CON 2 CHIAVI

PORTE A BATTENTE

Le porte a battente sono realizzate in robusta lamiera di acciaio debitamente sagomata, con un ingombro in profondità di 25 mm. La chiusura a 3 punti garantisce un'elevata sicurezza allo scasso. Disponibili con chiusura a cilindro e due chiavi o chiusura con codice numerico



CASSETTI VERTICALI

I cassetti verticali, con portata di 400 kg, si adattano ad alloggiare sia materiali pesanti, quali brocche, come i più svariati materiali, quali utensili, golfari, corde, da alloggiare su pratici pannelli forati

CHIUSURA CON CODICE NUMERICO

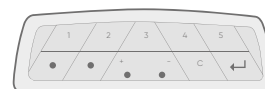

Oltre alla normale chiusura a cilindro, Fami ha deciso di aggiungere alle proprie chiusure la chiusura CODE. La serratura a codice numerico comanda l'apertura e la chiusura dell'asta vertebrata. Gestisce fino a 10 utenti con codice numerico da 3 a 8 cifre. Il download storico degli eventi è possibile tramite cavo collegando il tastierino al pc. Disponibili su richiesta fino a 10 telecomandi.

SYSTEM SR-MASTER





SYSTEM SR-MASTER

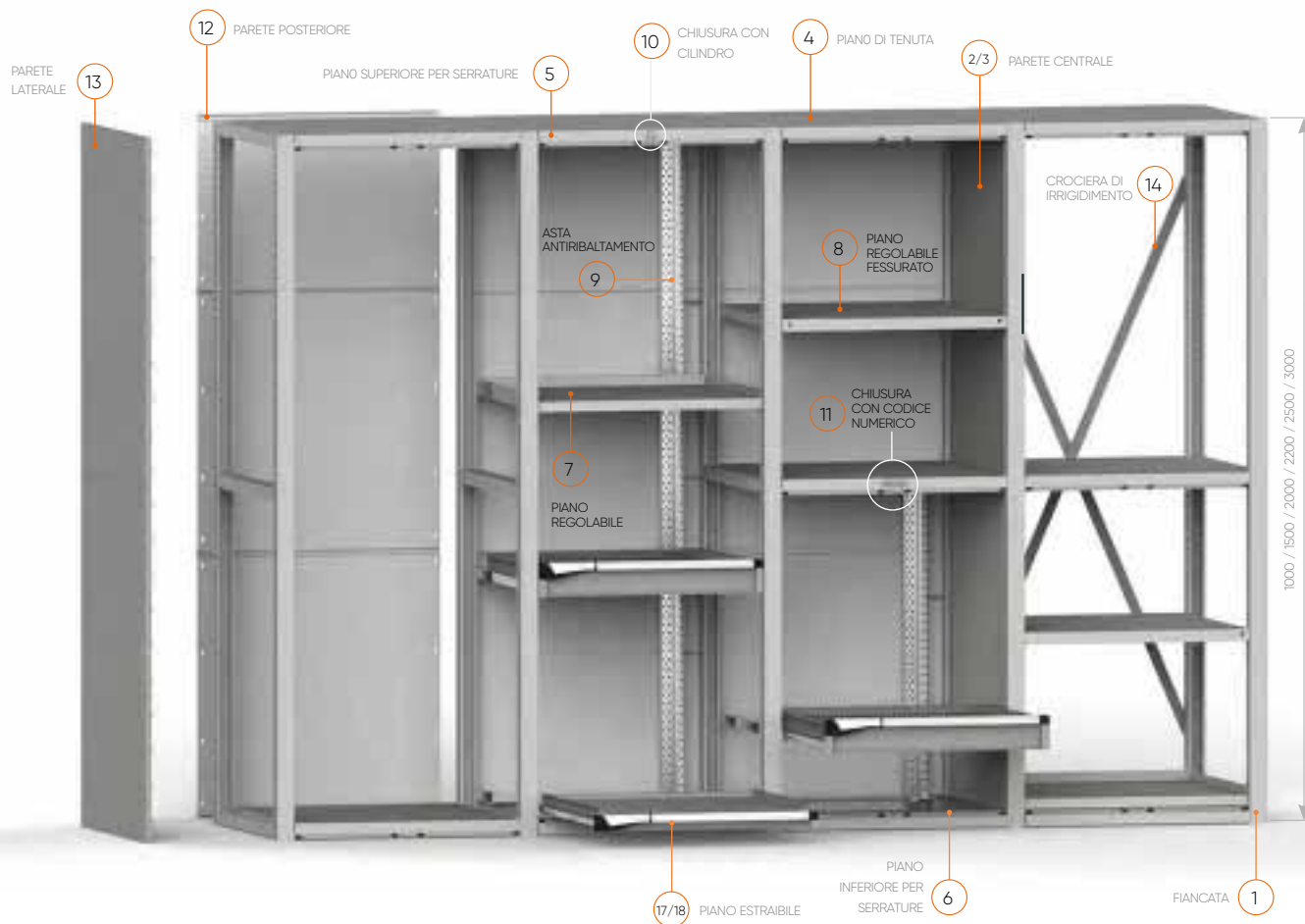

Gamma colori



FIANCATE

1	ART.	Dim. mm
	M 02 F100 00 00 01	51x573x1000 H
	M 02 F150 00 00 01	51x573x1500 H
	M 02 F200 00 00 01	51x573x2000 H
	M 02 F225 00 00 01	51x573x2250 H
	M 02 F250 00 00 01	51x573x2500 H
	M 02 F300 00 00 01	51x573x3000 H

COMPLETE DI TAPPI DI CHIUSURA

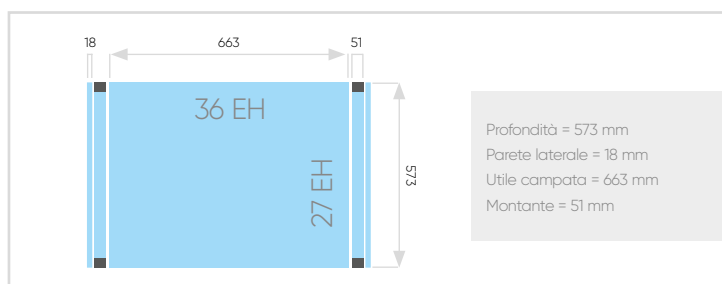

2 PARETE INFERIORE

H fiancata	ART.	Dim. mm H
1000	-	1000
1500	-	1500
2000	M 02 W100 MO 20 00	1000
2250	M 02 W100 MO 20 00	1000
2500	M 02 W100 MO 20 00	1000
3000	M 02 W100 MO 20 00	1000

3 PARETE SUPERIORE

ART.	Dim. mm H
-	-
-	-
M 02 W100 MO 10 00	1000
M 02 W125 MO 10 00	1250
M 02 W150 MO 10 00	1500
M 02 W100 MO 10 00*	1000

*Nell'altezza 3000 mm sono necessarie due pareti centrali superiori a chiusura della fiancata

PARETI CENTRALI

PIANO DI TENUTA

4	ART.		Dim. mm
	M 32 PT46 00 10 00 _ _		663x571x46 H
PORTATA 250 kg			

PIANO SUPERIORE PER SERRATURE

5	ART.		Dim. mm
	M 32 PS46 00 10 00 _ _		663x571x46 H
PORTATA 150 kg			

PIANO INFERIORE PER SERRATURE

6	ART.		Dim. mm
	M 32 PS46 10 10 00 _ _		663x571x46 H
PORTATA 150 kg			

PIANO REGOLABILE

7	ART.		Dim. mm
	M 32 PR25 00 00 01 _ _		657x478x60 H
INSERIBILE DAVANTI ALL'ASTA VERTEBRATA PORTATA 150 kg			

PIANO REGOLABILE FESSURATO

8	ART.		Dim. mm
	M 32 PR35 10 00 01 _ _		663x568x35 H
NON INSERIBILE IN PRESENZA DELL'ASTA VERTEBRATA PORTATA 300 kg			

ASTA ANTIRIBALTAMENTO

9	ART.	H asta mm
	M 00 V030 00 00 00 00	300
	M 00 V050 00 00 00 00	500
	M 00 V060 00 00 00 00	600
	M 00 V070 00 00 00 00	700
	M 00 V075 00 00 00 00	750
	M 00 V090 00 00 00 00	900
	M 00 V105 00 00 00 00	1050
	M 00 V122 00 00 00 00	1225
	M 00 V140 00 00 00 00	1400
	M 00 V152 00 00 00 00	1525
	M 00 V190 00 00 00 00	1900

È obbligatorio l'utilizzo dell'asta antiribaltamento con cassetti e con piani per evitare il ribaltamento della scaffalatura

CHIUSURA CON CILINDRO (KEY)

10	ART.	
	M 32 V000 C0 00 00 00	C0 numerazione diversa
	M 32 V000 C1 00 00 00	C1 gruppi di 160 numeri
	M 32 V000 C2 00 00 00	C2 numerazione uguale

COMPLETA DI: 1 serratura a cilindro con 2 chiavi, 1 filo in acciaio con guaina, 1 gruppo percussore anteriore, 1 gruppo cursore posteriore



SERRATURA A CHIAVE
Fornita di serie la chiusura a cilindro "C0".
Vedi sezione Master



CHIUSURA CON CODICE NUMERICO (CODE)

11	ART.	
	M 32 V000 E2 00 00 00	E2 apertura/chiusura asta
	M 32 V000 T2 00 00 00	T2 apertura/chiusura asta+porta

ART. TELECOMANDO

M 00 VRC0 00 00 00 00	Modulo ricevitore con telecomando
M 00 VRC0 00 00 01 00	Telecomando aggiuntivo

PARETI POSTERIORI

12	ART.		Dim. mm
	M 30 W100 P0 00 00 _ _		713x1000 H
	M 30 W150 P0 00 00 _ _		713x1500 H
	M 30 W200 P0 00 00 _ _		713x2000 H
	M 30 W225 P0 00 00 _ _		713x2250 H
	M 30 W250 P0 00 00 _ _		713x2500 H
	M 30 W300 P0 00 00 _ _		713x3000 H

È obbligatorio almeno ogni 3 campate utilizzare una campata con parete posteriore

PARETI LATERALI

13	ART.		Dim. mm
	M 02 W100 L0 00 00 _ _		18x572x1000 H
	M 02 W125 L0 00 00 _ _		18x572x1250 H
	M 02 W150 L0 00 00 _ _		18x572x1500 H

CROCIERE DI IRRIGIDIMENTO

14	ART.		Per altezza scaffali
	M 30 X150 00 00 00 _ _		1500/2250
	M 30 X250 00 00 00 _ _		2500/3000

È obbligatorio almeno ogni 3 campate utilizzare una campata con crociera

SYSTEM SR-MASTER



15

CASSETTI AD ESTRAZIONE FLESSIBILE

ART. CON kit plastiche Dark Grey	ART. SENZA kit plastiche*	Dim. utili mm	H frontale mm	kg	
M 32 C050 0110 OF __	M 32 C050 0100 OF __	600x447x31 H	50	50 - 75 - 100	100% - 96% - 92%
M 32 C075 0110 OF __	M 32 C075 0100 OF __	600x447x56 H	75	50 - 75 - 100	100% - 96% - 92%
M 32 C100 0110 OF __	M 32 C100 0100 OF __	600x447x81 H	100	50 - 75 - 100	100% - 96% - 92%
M 32 C125 0110 OF __	M 32 C125 0100 OF __	600x447x106 H	125	50 - 75 - 100	100% - 96% - 92%
M 32 C150 0110 OF __	M 32 C150 0100 OF __	600x447x131 H	150	50 - 75 - 100	100% - 96% - 92%
M 32 C200 0110 OF __	M 32 C200 0100 OF __	600x447x181 H	200	50 - 75 - 100	100% - 96% - 92%
M 32 C250 0110 OF __	M 32 C250 0100 OF __	600x447x231 H	250	50 - 75 - 100	100% - 96% - 92%
M 32 C300 0110 OF __	M 32 C300 0100 OF __	600x447x281 H	300	50 - 75 - 100	100% - 96% - 92%

* ABBINARE AL CODICE ARTICOLO UNO DEI KIT PLASTICHE DISPONIBILI NELLA TABELLA SOTTOSTANTE



16

CASSETTI AD ESTRAZIONE TELESCOPICA

ART. CON kit plastiche Dark Grey	ART. SENZA kit plastiche*	Dim. utili mm	H frontale mm	kg	
M 32 C075 0110 OT __	M 32 C075 0100 OT __	600x447x56 H	75	200	100%
M 32 C100 0110 OT __	M 32 C100 0100 OT __	600x447x81 H	100	200	100%
M 32 C125 0110 OT __	M 32 C125 0100 OT __	600x447x106 H	125	200	100%
M 32 C150 0110 OT __	M 32 C150 0100 OT __	600x447x131 H	150	200	100%
M 32 C200 0110 OT __	M 32 C200 0100 OT __	600x447x181 H	200	200	100%
M 32 C250 0110 OT __	M 32 C250 0100 OT __	600x447x231 H	250	200	100%
M 32 C300 0110 OT __	M 32 C300 0100 OT __	600x447x281 H	300	200	100%

* ABBINARE AL CODICE ARTICOLO UNO DEI KIT PLASTICHE DISPONIBILI NELLA TABELLA SOTTOSTANTE

KIT PLASTICHE PER CASSETTI E PIANI ESTRAIBILI



GAMMA COLORI PLASTICHE	ART.
MEDITERRANEAN BLUE	M 30 PLS1 00 00 00 M1
SKY BLUE	M 30 PLS1 00 00 00 M2
GLAMOUR RED	M 30 PLS1 00 00 00 M3
RED CARPET	M 30 PLS1 00 00 00 M4
JUICY ORANGE	M 30 PLS1 00 00 00 M5
SUNNY YELLOW	M 30 PLS1 00 00 00 M6
FOREST GREEN	M 30 PLS1 00 00 00 M7



17

PIANO ESTRAIBILE AD ESTRAZIONE FLESSIBILE

ART. CON kit plastiche Dark Grey	ART. SENZA kit plastiche*	Dim. utili mm	H frontale mm	kg	
M 32 C057 0110 0F _ _	M 32 C057 0100 0F _ _	600x447	70	50 - 75 - 100	100% - 96% - 92%

* ABBINARE AL CODICE ARTICOLO UNO DEI KIT PLASTICHE DISPONIBILI NELLA TABELLA A SINISTRA



18

PIANO ESTRAIBILE AD ESTRAZIONE TELESCOPICA

ART. CON kit plastiche Dark Grey	ART. SENZA kit plastiche*	Dim. utili mm	H frontale mm	kg	
M 32 C057 0110 0T _ _	M 32 C057 0100 0T _ _	600x447	70	200	100%

* ABBINARE AL CODICE ARTICOLO UNO DEI KIT PLASTICHE DISPONIBILI NELLA TABELLA A SINISTRA



SYSTEM SR-MASTER

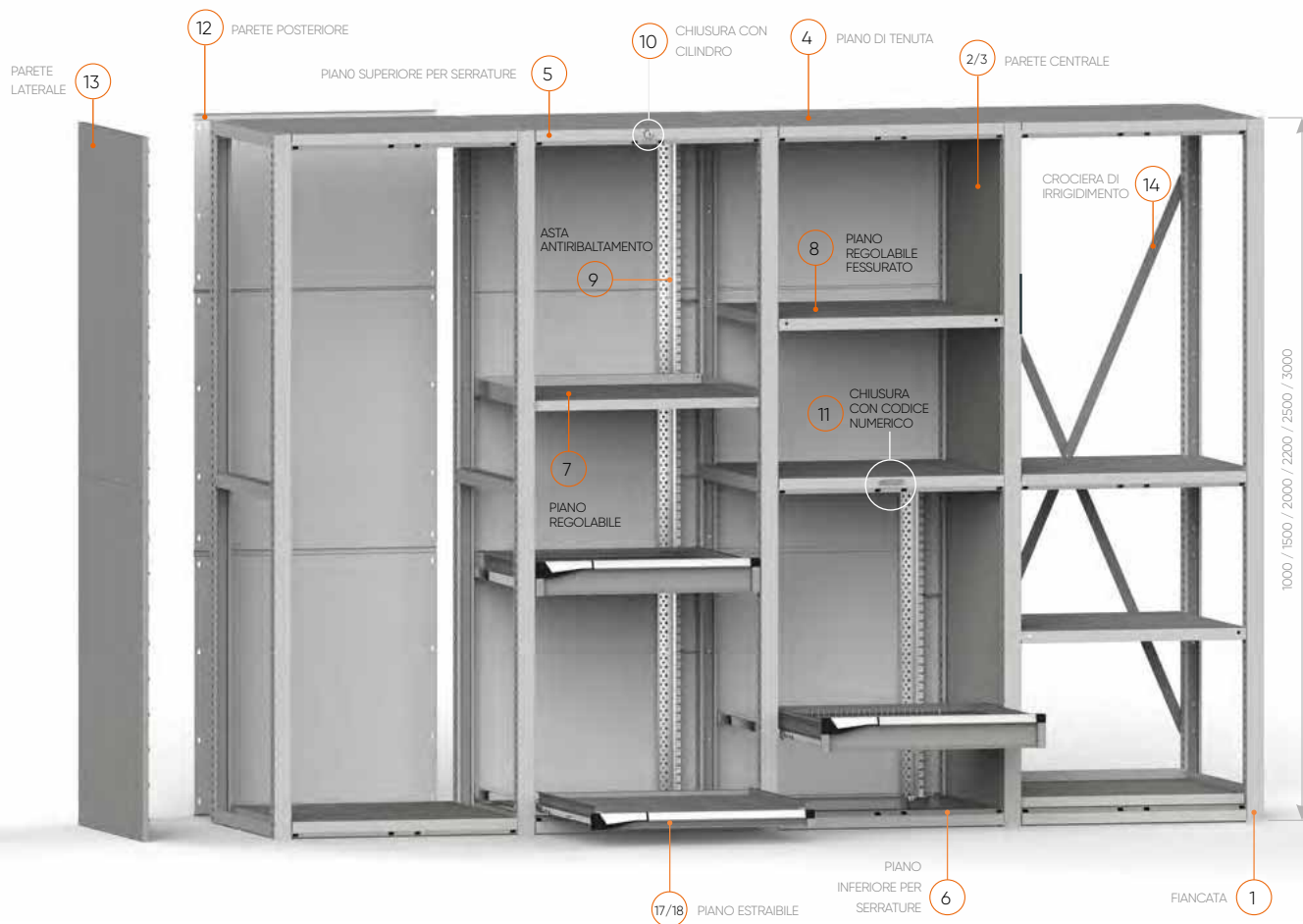

Gamma colori

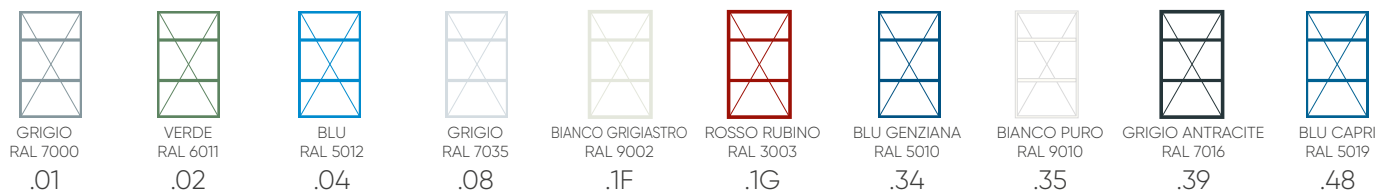

FIANCATE

1	ART.		Dim. mm
	M 02 F100 00 00 01		51x573x1000 H
	M 02 F150 00 00 01		51x573x1500 H
	M 02 F200 00 00 01		51x573x2000 H
	M 02 F225 00 00 01		51x573x2250 H
	M 02 F250 00 00 01		51x573x2500 H
	M 02 F300 00 00 01		51x573x3000 H

COMPLETE DI TAPPI DI CHIUSURA

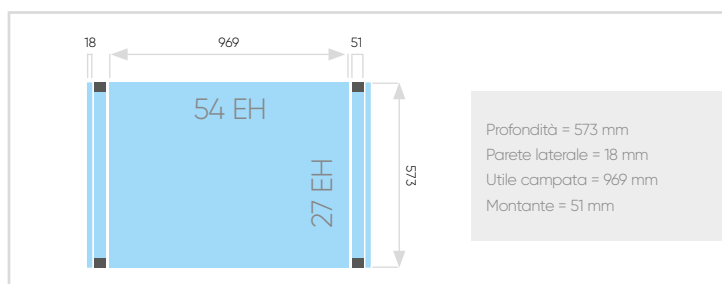

2 PARETE INFERIORE

H fiancata	ART.		Dim. mm H
1000	-		1000
1500	-		1500
2000	M 02 W100 MO 20 00		1000
2250	M 02 W100 MO 20 00		1000
2500	M 02 W100 MO 20 00		1000
3000	M 02 W100 MO 20 00		1000

3 PARETE SUPERIORE

ART.		Dim. mm H
-		-
M 02 W100 MO 10 00		1000
M 02 W125 MO 10 00		1250
M 02 W150 MO 10 00		1500
M 02 W100 MO 10 00*		1000

*Nell'altezza 3000 mm sono necessarie due pareti centrali superiori a chiusura della fiancata

PIANO DI TENUTA

4	ART.		Dim. mm	
	M 52 PT46 00 10 00		969x571x46 H	
PORTATA 250 kg				

PIANO SUPERIORE PER SERRATURE

5	ART.		Dim. mm	
	M 52 PS46 00 10 00		969x571x46 H	
PORTATA 150 kg				

PIANO INFERIORE PER SERRATURE

6	ART.		Dim. mm	
	M 52 PS46 10 10 00		969x571x46 H	
PORTATA 150 kg				

PIANO REGOLABILE

7	ART.		Dim. mm	
	M 52 PR25 00 00 01		963x478x60 H	
INSERIBILE DAVANTI ALL'ASTA VERTEBRATA PORTATA 100 kg				

PIANO REGOLABILE FESSURATO

8	ART.		Dim. mm	
	M 52 PR35 10 00 01		969x568x35 H	
NON INSERIBILE IN PRESENZA DELL'ASTA VERTEBRATA PORTATA 300 kg				

ASTA ANTIRIBALTAMENTO

9	ART.		H asta mm	
	M 00 V030 00 00 00 00		300	
	M 00 V050 00 00 00 00		500	
	M 00 V060 00 00 00 00		600	
	M 00 V070 00 00 00 00		700	
	M 00 V075 00 00 00 00		750	
	M 00 V090 00 00 00 00		900	
	M 00 V105 00 00 00 00		1050	
	M 00 V122 00 00 00 00		1225	
	M 00 V140 00 00 00 00		1400	
	M 00 V152 00 00 00 00		1525	
	M 00 V190 00 00 00 00		1900	

È obbligatorio l'utilizzo dell'asta antiribaltamento con cassetti e con piani per evitare il ribaltamento della scaffalatura

CHIUSURA CON CILINDRO (KEY)

10	ART.		
	M 52 V000 C0 00 00 00	C0	numerazione diversa
	M 52 V000 C1 00 00 00	C1	gruppi di 160 numeri
	M 52 V000 C2 00 00 00	C2	numerazione uguale

COMPLETA DI: 1 serratura a cilindro con 2 chiavi, 1 filo in acciaio con guaina, 1 gruppo percussore anteriore, 1 gruppo cursore posteriore



SERRATURA A CHIAVE
Fornita di serie la chiusura a cilindro "C0".

CHIUSURA CON CODICE NUMERICO (CODE)

11	ART.		
	M 52 V000 E2 00 00 00	E2	apertura/chiusura asta
	M 52 V000 T2 00 00 00	T2	apertura/chiusura asta+porta

ART. TELECOMANDO		
M 00 VRC0 00 00 00 00		Modulo ricevitore con telecomando
M 00 VRC0 00 00 01 00		Telecomando aggiuntivo

PARETI POSTERIORI

12	ART.		Dim. mm	
	M 50 W100 P0 00 00		1019x1000 H	
	M 50 W150 P0 00 00		1019x1500 H	
	M 50 W200 P0 00 00		1019x2000 H	
	M 50 W225 P0 00 00		1019x2250 H	
	M 50 W250 P0 00 00		1019x2500 H	
	M 50 W300 P0 00 00		1019x3000 H	

È obbligatorio almeno ogni 3 campate utilizzare una campata con parete posteriore

PARETI LATERALI

13	ART.		Dim. mm	
	M 02 W100 L0 00 00		18x572x1000 H	
	M 02 W125 L0 00 00		18x572x1250 H	
	M 02 W150 L0 00 00		18x572x1500 H	

CROCIERE DI IRRIGIDIMENTO

14	ART.		Per altezza scaffali	
	M 50 X150 00 00 00		1500/2250	
	M 50 X250 00 00 00		2500/3000	

È obbligatorio almeno ogni 3 campate utilizzare una campata con crociera

SYSTEM SR-MASTER



15

CASSETTI AD ESTRAZIONE FLESSIBILE

ART. CON kit plastiche Dark Grey	ART. SENZA kit plastiche*	Dim. utili mm	H frontale mm	kg	
M 52 C050 0110 OF __	M 52 C050 0100 OF __	906x447x31 H	50	50 - 75 - 100	100% - 96% - 92%
M 52 C075 0110 OF __	M 52 C075 0100 OF __	906x447x56 H	75	50 - 75 - 100	100% - 96% - 92%
M 52 C100 0110 OF __	M 52 C100 0100 OF __	906x447x81 H	100	50 - 75 - 100	100% - 96% - 92%
M 52 C125 0110 OF __	M 52 C125 0100 OF __	906x447x106 H	125	50 - 75 - 100	100% - 96% - 92%
M 52 C150 0110 OF __	M 52 C150 0100 OF __	906x447x131 H	150	50 - 75 - 100	100% - 96% - 92%
M 52 C200 0110 OF __	M 52 C200 0100 OF __	906x447x181 H	200	50 - 75 - 100	100% - 96% - 92%
M 52 C250 0110 OF __	M 52 C250 0100 OF __	906x447x231 H	250	50 - 75 - 100	100% - 96% - 92%
M 52 C300 0110 OF __	M 52 C300 0100 OF __	906x447x281 H	300	50 - 75 - 100	100% - 96% - 92%

* ABBINARE AL CODICE ARTICOLO UNO DEI KIT PLASTICHE DISPONIBILI NELLA TABELLA SOTTOSTANTE



16

CASSETTI AD ESTRAZIONE TELESCOPICA

ART. CON kit plastiche Dark Grey	ART. SENZA kit plastiche*	Dim. utili mm	H frontale mm	kg	
M 52 C075 0110 OT __	M 52 C075 0100 OT __	906x447x56 H	75	200	100%
M 52 C100 0110 OT __	M 52 C100 0100 OT __	906x447x81 H	100	200	100%
M 52 C125 0110 OT __	M 52 C125 0100 OT __	906x447x106 H	125	200	100%
M 52 C150 0110 OT __	M 52 C150 0100 OT __	906x447x131 H	150	200	100%
M 52 C200 0110 OT __	M 52 C200 0100 OT __	906x447x181 H	200	200	100%
M 52 C250 0110 OT __	M 52 C250 0100 OT __	906x447x231 H	250	200	100%
M 52 C300 0110 OT __	M 52 C300 0100 OT __	906x447x281 H	300	200	100%

* ABBINARE AL CODICE ARTICOLO UNO DEI KIT PLASTICHE DISPONIBILI NELLA TABELLA SOTTOSTANTE

KIT PLASTICHE PER CASSETTI E PIANI ESTRAIBILI



GAMMA COLORI PLASTICHE	ART.
 MEDITERRANEAN BLUE	M 50 PLS1 00 00 00 M1
 SKY BLUE	M 50 PLS1 00 00 00 M2
 GLAMOUR RED	M 50 PLS1 00 00 00 M3
 RED CARPET	M 50 PLS1 00 00 00 M4
 JUICY ORANGE	M 50 PLS1 00 00 00 M5
 SUNNY YELLOW	M 50 PLS1 00 00 00 M6
 FOREST GREEN	M 50 PLS1 00 00 00 M7



17

PIANO ESTRAIBILE AD ESTRAZIONE FLESSIBILE

ART. CON kit plastiche Dark Grey	ART. SENZA kit plastiche*	Dim. utili mm	H frontale mm	kg	
M 52 C057 0110 0F _ _	M 52 C057 0100 0F _ _	906x447	70	50 - 75 - 100	100% - 96% - 92%

* ABBINARE AL CODICE ARTICOLO UNO DEI KIT PLASTICHE DISPONIBILI NELLA TABELLA A SINISTRA



18

PIANO ESTRAIBILE AD ESTRAZIONE TELESCOPICA

ART. CON kit plastiche Dark Grey	ART. SENZA kit plastiche*	Dim. utili mm	H frontale mm	kg	
M 52 C057 0110 0T _ _	M 52 C057 0100 0T _ _	906x447	70	200	100%

* ABBINARE AL CODICE ARTICOLO UNO DEI KIT PLASTICHE DISPONIBILI NELLA TABELLA A SINISTRA



SYSTEM SR-MASTER



P

N

M

MID2_P1
4PK388
Kabelarm Revidieren

MID1_P1
H152089C
Kabelarm 10 D805LA

MID1_P4
H152188C
Kabelarm 10 D805LA

MID1_P5
H152091A 01
Kabelarm 10 D805LA

MID1_P6
H152091A
Kabelarm 10 D805LA

MID1_P7
H152091A
Kabelarm 10 D805LA

MID1_P8
H152091A
Kabelarm 10 D805LA

MID1_C3
H1520714 M
Funktionsarm

MID1_C4
H1520714 M
Funktionsarm

MID1_C5
H1520714 M
Funktionsarm

MID1_C6
H1520714 M
Funktionsarm

MID1_C7
H1520714 M
Funktionsarm

Original Kienzle
SPEZIALSCANNER
125-24 EC 4 B

Original Kienzle
SPEZIALSCANNER
125-24 EC 4 B

Original Kienzle
SPEZIALSCANNER
125-24 EC 4 B

Original Kienzle
SPEZIALSCANNER
125-24 EC 4 B



SYSTEM SR-MASTER

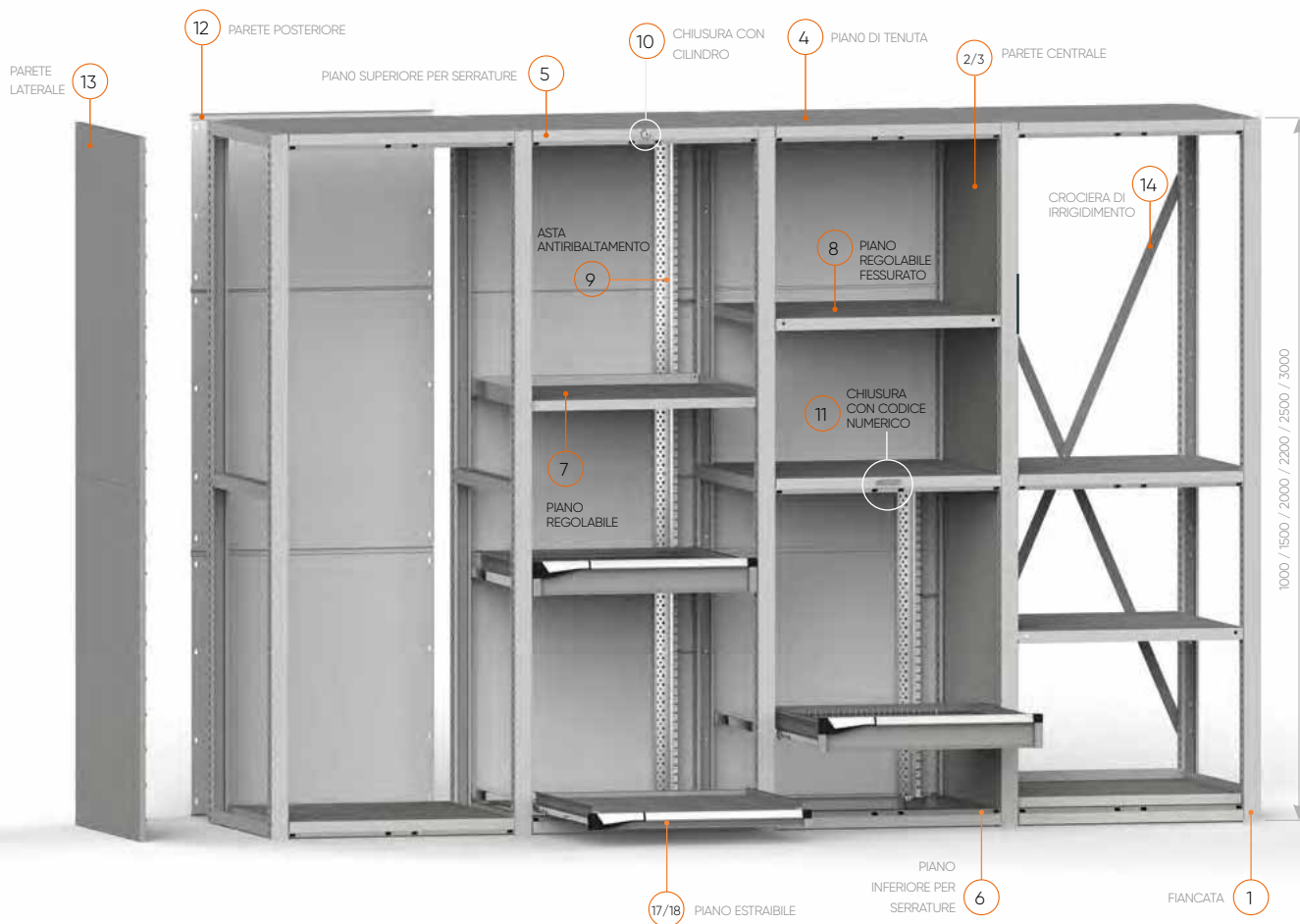

Gamma colori

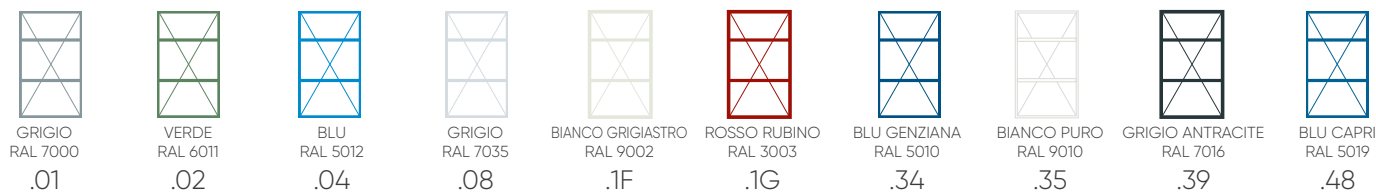

FIANCATE

1	ART.	Dim. mm
	M 03 F100 00 00 01	51x726x1000 H
	M 03 F150 00 00 01	51x726x1500 H
	M 03 F200 00 00 01	51x726x2000 H
	M 03 F225 00 00 01	51x726x2250 H
	M 03 F250 00 00 01	51x726x2500 H
	M 03 F300 00 00 01	51x726x3000 H

COMPLETE DI TAPPI DI CHIUSURA

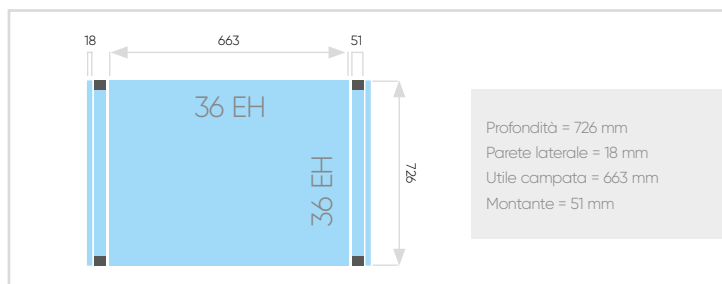

2 PARETE INFERIORE

H fiancata	ART.	Dim. mm H
1000	-	1000
1500	-	1500
2000	M 03 W100 MO 20 00	1000
2250	M 03 W100 MO 20 00	1000
2500	M 03 W100 MO 20 00	1000
3000	M 03 W100 MO 20 00	1000

3 PARETE SUPERIORE

ART.	Dim. mm H
-	-
M 03 W100 MO 10 00	1000
M 03 W125 MO 10 00	1250
M 03 W150 MO 10 00	1500
M 03 W100 MO 10 00	1000

*Nell'altezza 3000 mm sono necessarie due pareti centrali superiori a chiusura della fiancata

PARETI CENTRALI

PIANO DI TENUTA

4	ART.		Dim. mm
	M 33 PT46 00 10 00 _ _		663x724x46 H
PORTATA 250 kg			

PIANO SUPERIORE PER SERRATURE

5	ART.		Dim. mm
	M 33 PS46 00 10 00 _ _		663x724x46 H
PORTATA 150 kg			

PIANO INFERIORE PER SERRATURE

6	ART.		Dim. mm
	M 33 PS46 10 10 00 _ _		663x724x46 H
PORTATA 150 kg			

PIANO REGOLABILE

7	ART.		Dim. mm
	M 33 PR25 00 00 01 _ _		657x631x60 H
INSERIBILE DAVANTI ALL'ASTA VERTEBRATA PORTATA 150 kg			

PIANO REGOLABILE FESSURATO

8	ART.		Dim. mm
	M 33 PR35 10 00 01 _ _		663x721x35 H
NON INSERIBILE IN PRESENZA DELL'ASTA VERTEBRATA PORTATA 300 kg			

ASTA ANTIRIBALTAMENTO

9	ART.	H asta mm
	M 00 V030 00 00 00 00	300
	M 00 V050 00 00 00 00	500
	M 00 V060 00 00 00 00	600
	M 00 V070 00 00 00 00	700
	M 00 V075 00 00 00 00	750
	M 00 V090 00 00 00 00	900
	M 00 V105 00 00 00 00	1050
	M 00 V122 00 00 00 00	1225
	M 00 V140 00 00 00 00	1400
	M 00 V152 00 00 00 00	1525
	M 00 V190 00 00 00 00	1900

È obbligatorio l'utilizzo dell'asta antiribaltamento con cassetti e con piani per evitare il ribaltamento della scaffalatura

CHIUSURA CON CILINDRO (KEY)

10	ART.	
	M 33 V000 C0 00 00 00	C0 numerazione diversa
	M 33 V000 C1 00 00 00	C1 gruppi di 160 numeri
	M 33 V000 C2 00 00 00	C2 numerazione uguale

COMPLETA DI: 1 serratura a cilindro con 2 chiavi, 1 filo in acciaio con guaina, 1 gruppo percussore anteriore, 1 gruppo cursore posteriore



SERRATURA A CHIAVE
Fornita di serie la chiusura a cilindro "C0".

CHIUSURA CON CODICE NUMERICO (CODE)

11	ART.	
	M 33 V000 E2 00 00 00	E2 apertura/chiusura asta
	M 33 V000 T2 00 00 00	T2 apertura/chiusura asta+porta

ART. TELECOMANDO	
M 00 VRC0 00 00 00 00	Modulo ricevitore con telecomando
M 00 VRC0 00 00 01 00	Telecomando aggiuntivo

PARETI POSTERIORI

12	ART.		Dim. mm
	M 30 W100 P0 00 00 _ _		713x1000 H
	M 30 W150 P0 00 00 _ _		713x1500 H
	M 30 W200 P0 00 00 _ _		713x2000 H
	M 30 W225 P0 00 00 _ _		713x2250 H
	M 30 W250 P0 00 00 _ _		713x2500 H
	M 30 W300 P0 00 00 _ _		713x3000 H

È obbligatorio almeno ogni 3 campate utilizzare una campata con parete posteriore

PARETI LATERALI

13	ART.		Dim. mm
	M 03 W100 L0 00 00 _ _		18x725x1000 H
	M 03 W125 L0 00 00 _ _		18x725x1250 H
	M 03 W150 L0 00 00 _ _		18x725x1500 h

CROCIERE DI IRRIGIDIMENTO

14	ART.		Per altezza scaffali
	M 30 X150 00 00 00 _ _		1500/2250
	M 30 X250 00 00 00 _ _		2500/3000

È obbligatorio almeno ogni 3 campate utilizzare una campata con crociera

SYSTEM SR-MASTER



15

CASSETTI AD ESTRAZIONE FLESSIBILE

ART. CON kit plastiche Dark Grey	ART. SENZA kit plastiche*	Dim. utili mm	H frontale mm	kg	
M 33 C050 0110 OF __	M 33 C050 0100 OF __	600x600x31 H	50	50 - 75 - 100	100% - 96% - 92%
M 33 C075 0110 OF __	M 33 C075 0100 OF __	600x600x56 H	75	50 - 75 - 100	100% - 96% - 92%
M 33 C100 0110 OF __	M 33 C100 0100 OF __	600x600x81 H	100	50 - 75 - 100	100% - 96% - 92%
M 33 C125 0110 OF __	M 33 C125 0100 OF __	600x600x106 H	125	50 - 75 - 100	100% - 96% - 92%
M 33 C150 0110 OF __	M 33 C150 0100 OF __	600x600x131 H	150	50 - 75 - 100	100% - 96% - 92%
M 33 C200 0110 OF __	M 33 C200 0100 OF __	600x600x181 H	200	50 - 75 - 100	100% - 96% - 92%
M 33 C250 0110 OF __	M 33 C250 0100 OF __	600x600x231 H	250	50 - 75 - 100	100% - 96% - 92%
M 33 C300 0110 OF __	M 33 C300 0100 OF __	600x600x281 H	300	50 - 75 - 100	100% - 96% - 92%

* ABBINARE AL CODICE ARTICOLO UNO DEI KIT PLASTICHE DISPONIBILI NELLA TABELLA SOTTOSTANTE



16

CASSETTI AD ESTRAZIONE TELESCOPICA

ART. CON kit plastiche Dark Grey	ART. SENZA kit plastiche*	Dim. utili mm	H frontale mm	kg	
M 33 C075 0110 OT __	M 33 C075 0100 OT __	600x600x56 H	75	200	100%
M 33 C100 0110 OT __	M 33 C100 0100 OT __	600x600x81 H	100	200	100%
M 33 C125 0110 OT __	M 33 C125 0100 OT __	600x600x106 H	125	200	100%
M 33 C150 0110 OT __	M 33 C150 0100 OT __	600x600x131 H	150	200	100%
M 33 C200 0110 OT __	M 33 C200 0100 OT __	600x600x181 h	200	200	100%
M 33 C250 0110 OT __	M 33 C250 0100 OT __	600x600x231 H	250	200	100%
M 33 C300 0110 OT __	M 33 C300 0100 OT __	600x600x281 H	300	200	100%

* ABBINARE AL CODICE ARTICOLO UNO DEI KIT PLASTICHE DISPONIBILI NELLA TABELLA SOTTOSTANTE

KIT PLASTICHE PER CASSETTI E PIANI ESTRAIBILI



GAMMA COLORI PLASTICHE	ART.
MEDITERRANEAN BLUE	M 30 PLS1 00 00 00 M1
SKY BLUE	M 30 PLS1 00 00 00 M2
GLAMOUR RED	M 30 PLS1 00 00 00 M3
RED CARPET	M 30 PLS1 00 00 00 M4
JUICY ORANGE	M 30 PLS1 00 00 00 M5
SUNNY YELLOW	M 30 PLS1 00 00 00 M6
FOREST GREEN	M 30 PLS1 00 00 00 M7



17

PIANO ESTRAIBILE AD ESTRAZIONE FLESSIBILE

ART. CON kit plastiche Dark Grey	ART. SENZA kit plastiche*	Dim. utili mm	H frontale mm	kg	
M 33 C057 0110 0F _ _	M 33 C057 0100 0F _ _	600x600	70	50 - 75 - 100	100% - 96% - 92%

* ABBINARE AL CODICE ARTICOLO UNO DEI KIT PLASTICHE DISPONIBILI NELLA TABELLA A SINISTRA



18

PIANO ESTRAIBILE AD ESTRAZIONE TELESCOPICA

ART. CON kit plastiche Dark Grey	ART. SENZA kit plastiche*	Dim. utili mm	H frontale mm	kg	
M 33 C057 0110 0T _ _	M 33 C057 0100 0T _ _	600x600	70	200	100%

* ABBINARE AL CODICE ARTICOLO UNO DEI KIT PLASTICHE DISPONIBILI NELLA TABELLA A SINISTRA



SYSTEM SR-MASTER

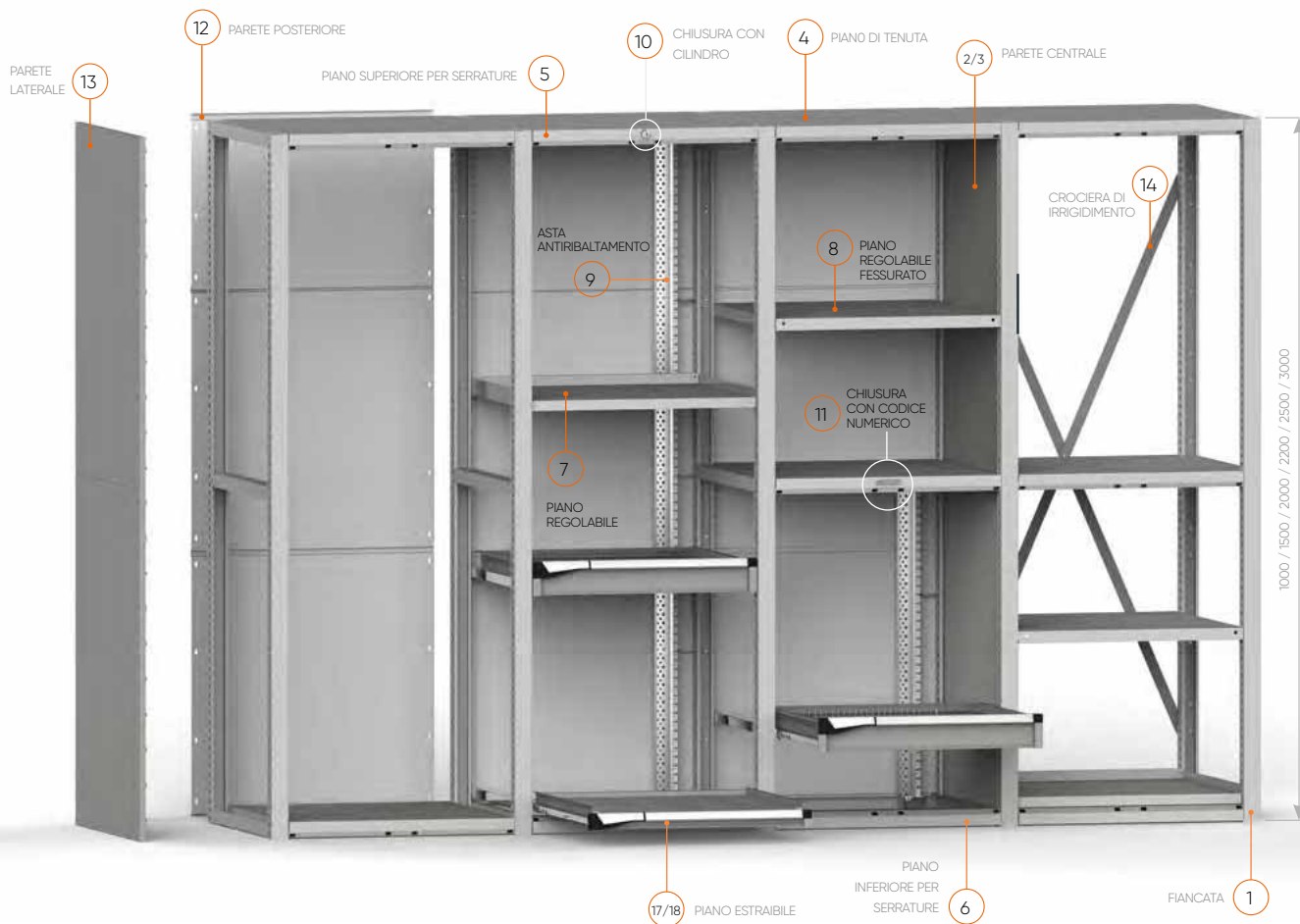

Gamma colori



FIANCATE

1	ART.	Dim. mm
	M 03 F100 00 00 01	51x726x1000 H
	M 03 F150 00 00 01	51x726x1500 H
	M 03 F200 00 00 01	51x726x2000 H
	M 03 F225 00 00 01	51x726x2250 H
	M 03 F250 00 00 01	51x726x2500 H
	M 03 F300 00 00 01	51x726x3000 H

COMPLETE DI TAPPI DI CHIUSURA

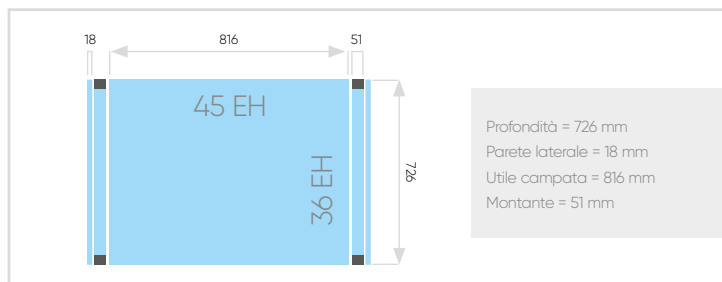

2 PARETE INFERIORE

H fiancata	ART.	Dim. mm H
1000	-	-
1500	-	-
2000	M 03 W100 MO 20 00	1000
2250	M 03 W100 MO 20 00	1000
2500	M 03 W100 MO 20 00	1000
3000	M 03 W100 MO 20 00	1000

3 PARETE SUPERIORE

ART.	Dim. mm H
-	-
-	-
M 03 W100 MO 10 00	1000
M 03 W125 MO 10 00	1250
M 03 W150 MO 10 00	1500
M 03 W100 MO 10 00*	1000

*Nell'altezza 3000 mm sono necessarie due pareti centrali superiori a chiusura della fiancata

PARETI CENTRALI

PIANO DI TENUTA

4	ART.		Dim. mm	
	M 43 PT46 00 10 00 _ _		816x724x46 H	
PORTATA 250 kg				

PIANO SUPERIORE PER SERRATURE

5	ART.		Dim. mm	
	M 43 PS46 00 10 00 _ _		816x724x46 H	
PORTATA 150 kg				

PIANO INFERIORE PER SERRATURE

6	ART.		Dim. mm	
	M 43 PS46 10 10 00 _ _		816x724x46 H	
PORTATA 150 kg				

PIANO REGOLABILE

7	ART.		Dim. mm	
	M 43 PR25 00 00 01 _ _		810x631x60 H	
INSERIBILE DAVANTI ALL'ASTA VERTEBRATA PORTATA 100 kg				

PIANO REGOLABILE FESSURATO

8	ART.		Dim. mm	
	M 43 PR35 10 00 01 _ _		816x721x35 H	
NON INSERIBILE IN PRESENZA DELL'ASTA VERTEBRATA PORTATA 200 kg				

ASTA ANTIRIBALTAMENTO

9	ART.	H asta mm	
	M 00 V030 00 00 00 00	300	
	M 00 V050 00 00 00 00	500	
	M 00 V060 00 00 00 00	600	
	M 00 V070 00 00 00 00	700	
	M 00 V075 00 00 00 00	750	
	M 00 V090 00 00 00 00	900	
	M 00 V105 00 00 00 00	1050	
	M 00 V122 00 00 00 00	1225	
	M 00 V140 00 00 00 00	1400	
	M 00 V152 00 00 00 00	1525	
	M 00 V190 00 00 00 00	1900	

È obbligatorio l'utilizzo dell'asta antiribaltamento con cassetti e con piani per evitare il ribaltamento della scaffalatura



CHIUSURA CON CILINDRO (KEY)

10	ART.		
	M 43 V000 C0 00 00 00	C0	numerazione diversa
	M 43 V000 C1 00 00 00	C1	gruppi di 160 numeri
	M 43 V000 C2 00 00 00	C2	numerazione uguale

COMPLETA DI: 1 serratura a cilindro con 2 chiavi, 1 filo in acciaio con guaina, 1 gruppo percussore anteriore, 1 gruppo cursore posteriore



SERRATURA A CHIAVE
Fornita di serie la chiusura a cilindro "C0".



CHIUSURA CON CODICE NUMERICO (CODE)

11	ART.		
	M 43 V000 E2 00 00 00	E2	apertura/chiusura asta
	M 43 V000 T2 00 00 00	T2	apertura/chiusura asta+porta

ART. TELECOMANDO

M 00 VRC0 00 00 00 00	Modulo ricevitore con telecomando
M 00 VRC0 00 00 01 00	Telecomando aggiuntivo

PARETI POSTERIORI

12	ART.		Dim. mm	
	M 40 W100 PO 00 00 _ _		866x1000 H	
	M 40 W150 PO 00 00 _ _		866x1500 H	
	M 40 W200 PO 00 00 _ _		866x2000 H	
	M 40 W225 PO 00 00 _ _		866x2250 H	
	M 40 W250 PO 00 00 _ _		866x2500 H	
	M 40 W300 PO 00 00 _ _		866x3000 H	

È obbligatorio almeno ogni 3 campate utilizzare una campata con parete posteriore

PARETI LATERALI

13	ART.		Dim. mm	
	M 03 W100 LO 00 00 _ _		18x725x1000 H	
	M 03 W125 LO 00 00 _ _		18x725x1250 H	
	M 03 W150 LO 00 00 _ _		18x725x1500 H	

CROCIERE DI IRRIGIDIMENTO

14	ART.		Per altezza scaffali	
	M 40 X150 00 00 00 _ _		1500/2250	
	M 40 X250 00 00 00 _ _		2500/3000	

È obbligatorio almeno ogni 3 campate utilizzare una campata con crociera

SYSTEM SR-MASTER



15

CASSETTI AD ESTRAZIONE FLESSIBILE

ART. CON kit plastiche Dark Grey	ART. SENZA kit plastiche*	Dim. utili mm	H frontale mm	kg	
M43 C050 0110 OF __	M43 C050 0100 OF __	753x600x31 H	50	50 - 75 - 100	100% - 96% - 92%
M43 C075 0110 OF __	M43 C075 0100 OF __	753x600x56 H	75	50 - 75 - 100	100% - 96% - 92%
M43 C100 0110 OF __	M43 C100 0100 OF __	753x600x81 H	100	50 - 75 - 100	100% - 96% - 92%
M43 C125 0110 OF __	M43 C125 0100 OF __	753x600x106 H	125	50 - 75 - 100	100% - 96% - 92%
M43 C150 0110 OF __	M43 C150 0100 OF __	753x600x131 H	150	50 - 75 - 100	100% - 96% - 92%
M43 C200 0110 OF __	M43 C200 0100 OF __	753x600x181 H	200	50 - 75 - 100	100% - 96% - 92%
M43 C250 0110 OF __	M43 C250 0100 OF __	753x600x231 H	250	50 - 75 - 100	100% - 96% - 92%
M43 C300 0110 OF __	M43 C300 0100 OF __	753x600x281 H	300	50 - 75 - 100	100% - 96% - 92%

* ABBINARE AL CODICE ARTICOLO UNO DEI KIT PLASTICHE DISPONIBILI NELLA TABELLA SOTTOSTANTE



16

CASSETTI AD ESTRAZIONE TELESCOPICA

ART. CON kit plastiche Dark Grey	ART. SENZA kit plastiche*	Dim. utili mm	H frontale mm	kg	
M43 C075 0110 OT __	M43 C075 0100 OT __	753x600x56 H	75	200	100%
M43 C100 0110 OT __	M43 C100 0100 OT __	753x600x81 H	100	200	100%
M43 C125 0110 OT __	M43 C125 0100 OT __	753x600x106 H	125	200	100%
M43 C150 0110 OT __	M43 C150 0100 OT __	753x600x131 H	150	200	100%
M43 C200 0110 OT __	M43 C200 0100 OT __	753x600x181 H	200	200	100%
M43 C250 0110 OT __	M43 C250 0100 OT __	753x600x231 H	250	200	100%
M43 C300 0110 OT __	M43 C300 0100 OT __	753x600x281 H	300	200	100%

* ABBINARE AL CODICE ARTICOLO UNO DEI KIT PLASTICHE DISPONIBILI NELLA TABELLA SOTTOSTANTE

KIT PLASTICHE PER CASSETTI E PIANI ESTRAIBILI



GAMMA COLORI PLASTICHE	ART.
MEDITERRANEAN BLUE	M 40 PLS1 00 00 00 M1
SKY BLUE	M 40 PLS1 00 00 00 M2
GLAMOUR RED	M 40 PLS1 00 00 00 M3
RED CARPET	M 40 PLS1 00 00 00 M4
JUICY ORANGE	M 40 PLS1 00 00 00 M5
SUNNY YELLOW	M 40 PLS1 00 00 00 M6
FOREST GREEN	M 40 PLS1 00 00 00 M7



17

PIANO ESTRAIBILE AD ESTRAZIONE FLESSIBILE

ART. CON kit plastiche Dark Grey	ART. SENZA kit plastiche*	Dim. utili mm	H frontale mm	kg	
M43 C057 0110 0F _ _	M43 C057 0100 0F _ _	753x600	70	50 - 75 - 100	100% - 96% - 92%

* ABBINARE AL CODICE ARTICOLO UNO DEI KIT PLASTICHE DISPONIBILI NELLA TABELLA A SINISTRA



18

PIANO ESTRAIBILE AD ESTRAZIONE TELESCOPICA

ART. CON kit plastiche Dark Grey	ART. SENZA kit plastiche*	Dim. utili mm	H frontale mm	kg	
M43 C057 0110 0T _ _	M43 C057 0100 0T _ _	753x600	70	200	100%

* ABBINARE AL CODICE ARTICOLO UNO DEI KIT PLASTICHE DISPONIBILI NELLA TABELLA A SINISTRA



SYSTEM SR-MASTER

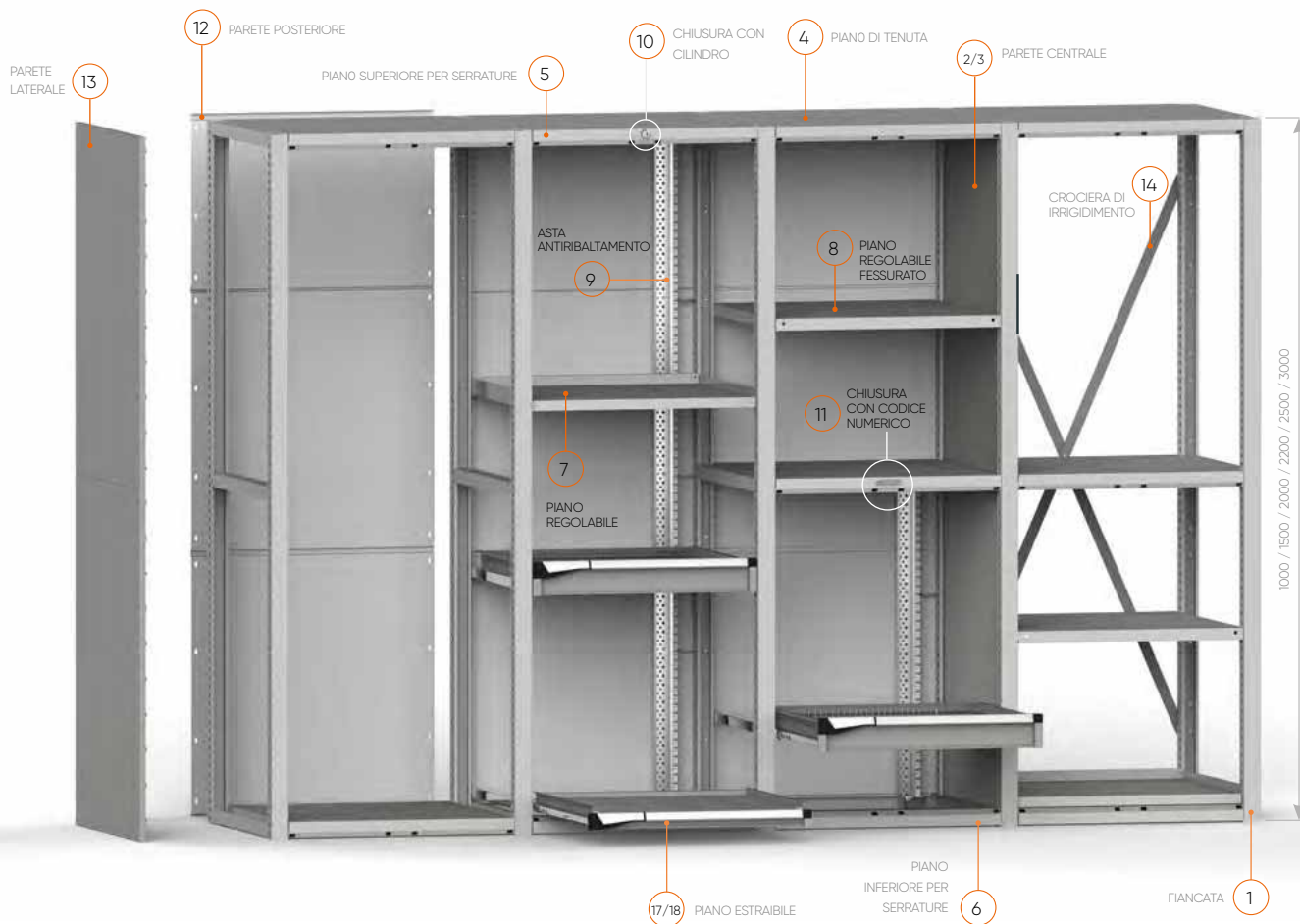

Gamma colori

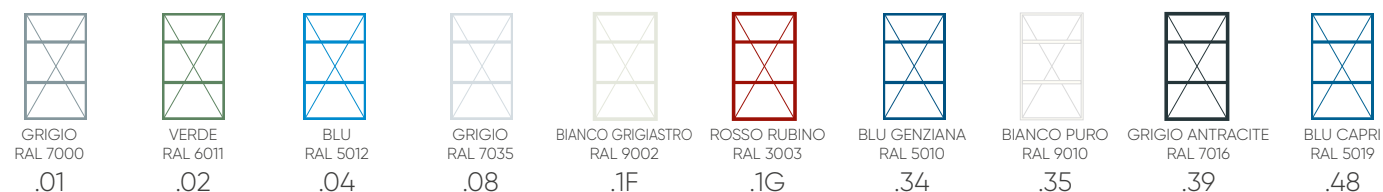

FIANCATE

1	ART.	Dim. mm
	M 03 F100 00 00 01	51x726x1000 H
	M 03 F150 00 00 01	51x726x1500 H
	M 03 F200 00 00 01	51x726x2000 H
	M 03 F225 00 00 01	51x726x2250 H
	M 03 F250 00 00 01	51x726x2500 H
	M 03 F300 00 00 01	51x726x3000 H

COMPLETE DI TAPPI DI CHIUSURA

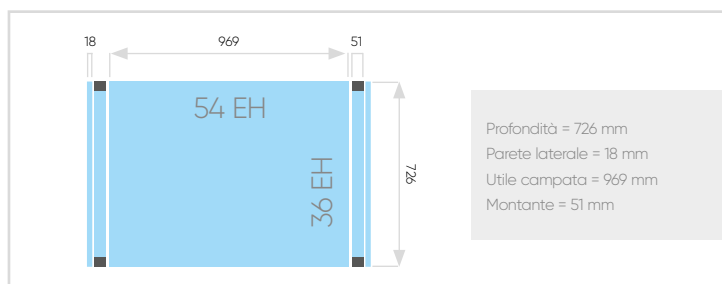

2 PARETE INFERIORE

H fiancata	ART.	Dim. mm H
1000	-	1000
1500	-	1500
2000	M 03 W100 MO 20 00	1000
2250	M 03 W100 MO 20 00	1000
2500	M 03 W100 MO 20 00	1000
3000	M 03 W100 MO 20 00	1000

3 PARETE SUPERIORE

ART.	Dim. mm H
-	-
M 03 W100 MO 10 00	1000
M 03 W125 MO 10 00	1250
M 03 W150 MO 10 00	1500
M 03 W100 MO 10 00*	1000

*Nell'altezza 3000 mm sono necessarie due pareti centrali superiori a chiusura della fiancata

PARETI CENTRALI

PIANO DI TENUTA

4	ART.		Dim. mm	
	M 53 PT46 00 10 00 _ _		969x724x46 H	
PORTATA 250 kg				

PIANO SUPERIORE PER SERRATURE

5	ART.		Dim. mm	
	M 53 PS46 00 10 00 _ _		969x724x46 H	
PORTATA 150 kg				

PIANO INFERIORE PER SERRATURE

6	ART.		Dim. mm	
	M 53 PS46 10 10 00 _ _		969x724x46 H	
PORTATA 150 kg				

PIANO REGOLABILE

7	ART.		Dim. mm	
	M 53 PR25 00 00 01 _ _		963x631x60 H	
INSERIBILE DAVANTI ALL'ASTA VERTEBRATA PORTATA 100 kg				

PIANO REGOLABILE FESSURATO

8	ART.		Dim. mm	
	M 53 PR35 10 00 01 _ _		969x721x35 H	
NON INSERIBILE IN PRESENZA DELL'ASTA VERTEBRATA PORTATA 250 kg				

ASTA ANTIRIBALTAMENTO

9	ART.		H asta mm	
	M 00 V030 00 00 00 00		300	
	M 00 V050 00 00 00 00		500	
	M 00 V060 00 00 00 00		600	
	M 00 V070 00 00 00 00		700	
	M 00 V075 00 00 00 00		750	
	M 00 V090 00 00 00 00		900	
	M 00 V105 00 00 00 00		1050	
	M 00 V122 00 00 00 00		1225	
	M 00 V140 00 00 00 00		1400	
	M 00 V152 00 00 00 00		1525	
M 00 V190 00 00 00 00		1900		

È obbligatorio l'utilizzo dell'asta antiribaltamento con cassetti e con piani per evitare il ribaltamento della scaffalatura

CHIUSURA CON CILINDRO (KEY)

10	ART.		
	M 53 V000 C0 00 00 00	C0	numerazione diversa
	M 53 V000 C1 00 00 00	C1	gruppi di 160 numeri
	M 53 V000 C2 00 00 00	C2	numerazione uguale

COMPLETA DI: 1 serratura a cilindro con 2 chiavi, 1 filo in acciaio con guaina, 1 gruppo percussore anteriore, 1 gruppo cursore posteriore



SERRATURA A CHIAVE
Fornita di serie la chiusura a cilindro "C0".

CHIUSURA CON CODICE NUMERICO (CODE)

11	ART.		
	M 53 V000 E2 00 00 00	E2	apertura/chiusura asta
	M 53 V000 T2 00 00 00	T2	apertura/chiusura asta+porta

ART. TELECOMANDO		
M 00 VRC0 00 00 00 00		Modulo ricevitore con telecomando
M 00 VRC0 00 00 01 00		Telecomando aggiuntivo

PARETI POSTERIORI

12	ART.		Dim. mm	
	M 50 W100 PO 00 00 _ _		1019x1000 H	
	M 50 W150 PO 00 00 _ _		1019x1500 H	
	M 50 W200 PO 00 00 _ _		1019x2000 H	
	M 50 W225 PO 00 00 _ _		1019x2250 H	
	M 50 W250 PO 00 00 _ _		1019x2500 H	
	M 50 W300 PO 00 00 _ _		1019x3000 H	

È obbligatorio almeno ogni 3 campate utilizzare una campata con parete posteriore

PARETI LATERALI

13	ART.		Dim. mm	
	M 03 W100 LO 00 00 _ _		18x725x1000 H	
	M 03 W125 LO 00 00 _ _		18x725x1250 H	
	M 03 W150 LO 00 00 _ _		18x725x1500 H	

CROCIERE DI IRRIGIDIMENTO

14	ART.		Per altezza scaffali	
	M 50 X150 00 00 00 _ _		1500/2250	
	M 50 X250 00 00 00 _ _		2500/3000	

È obbligatorio almeno ogni 3 campate utilizzare una campata con crociera

SYSTEM SR-MASTER



15

CASSETTI AD ESTRAZIONE FLESSIBILE

ART. CON kit plastiche Dark Grey	ART. SENZA kit plastiche*	Dim. utili mm	H frontale mm	kg	
M 53 C050 0110 OF __	M 53 C050 0100 OF __	906x600x31 H	50	50 - 75 - 100	100% - 96% - 92%
M 53 C075 0110 OF __	M 53 C075 0100 OF __	906x600x56 H	75	50 - 75 - 100	100% - 96% - 92%
M 53 C100 0110 OF __	M 53 C100 0100 OF __	906x600x81 H	100	50 - 75 - 100	100% - 96% - 92%
M 53 C125 0110 OF __	M 53 C125 0100 OF __	906x600x106 H	125	50 - 75 - 100	100% - 96% - 92%
M 53 C150 0110 OF __	M 53 C150 0100 OF __	906x600x131 H	150	50 - 75 - 100	100% - 96% - 92%
M 53 C200 0110 OF __	M 53 C200 0100 OF __	906x600x181 H	200	50 - 75 - 100	100% - 96% - 92%
M 53 C250 0110 OF __	M 53 C250 0100 OF __	906x600x231 H	250	50 - 75 - 100	100% - 96% - 92%
M 53 C300 0110 OF __	M 53 C300 0100 OF __	906x600x281 H	300	50 - 75 - 100	100% - 96% - 92%

* ABBINARE AL CODICE ARTICOLO UNO DEI KIT PLASTICHE DISPONIBILI NELLA TABELLA SOTTOSTANTE



16

CASSETTI AD ESTRAZIONE TELESCOPICA

ART. CON kit plastiche Dark Grey	ART. SENZA kit plastiche*	Dim. utili mm	H frontale mm	kg	
M 53 C075 0110 OT __	M 53 C075 0100 OT __	906x600x56 H	75	200	100%
M 53 C100 0110 OT __	M 53 C100 0100 OT __	906x600x81 H	100	200	100%
M 53 C125 0110 OT __	M 53 C125 0100 OT __	906x600x106 H	125	200	100%
M 53 C150 0110 OT __	M 53 C150 0100 OT __	906x600x131 H	150	200	100%
M 53 C200 0110 OT __	M 53 C200 0100 OT __	906x600x181 H	200	200	100%
M 53 C250 0110 OT __	M 53 C250 0100 OT __	906x600x231 H	250	200	100%
M 53 C300 0110 OT __	M 53 C300 0100 OT __	906x600x281 H	300	200	100%

* ABBINARE AL CODICE ARTICOLO UNO DEI KIT PLASTICHE DISPONIBILI NELLA TABELLA SOTTOSTANTE

KIT PLASTICHE PER CASSETTI E PIANI ESTRAIBILI



GAMMA COLORI PLASTICHE	ART.
MEDITERRANEAN BLUE	M 50 PLS1 00 00 00 M1
SKY BLUE	M 50 PLS1 00 00 00 M2
GLAMOUR RED	M 50 PLS1 00 00 00 M3
RED CARPET	M 50 PLS1 00 00 00 M4
JUICY ORANGE	M 50 PLS1 00 00 00 M5
SUNNY YELLOW	M 50 PLS1 00 00 00 M6
FOREST GREEN	M 50 PLS1 00 00 00 M7



17

PIANO ESTRAIBILE AD ESTRAZIONE FLESSIBILE

ART. CON kit plastiche Dark Grey	ART. SENZA kit plastiche*	Dim. utili mm	H frontale mm	kg	
M 53 C057 0110 0F _ _	M 53 C057 0100 0F _ _	906x600	70	50 - 75 - 100	100% - 96% - 92%

* ABBINARE AL CODICE ARTICOLO UNO DEI KIT PLASTICHE DISPONIBILI NELLA TABELLA A SINISTRA



18

PIANO ESTRAIBILE AD ESTRAZIONE TELESCOPICA

ART. CON kit plastiche Dark Grey	ART. SENZA kit plastiche*	Dim. utili mm	H frontale mm	kg	
M 53 C057 0110 0T _ _	M 53 C057 0100 0T _ _	906x600	70	200	100%

* ABBINARE AL CODICE ARTICOLO UNO DEI KIT PLASTICHE DISPONIBILI NELLA TABELLA A SINISTRA



SYSTEM SR-MASTER

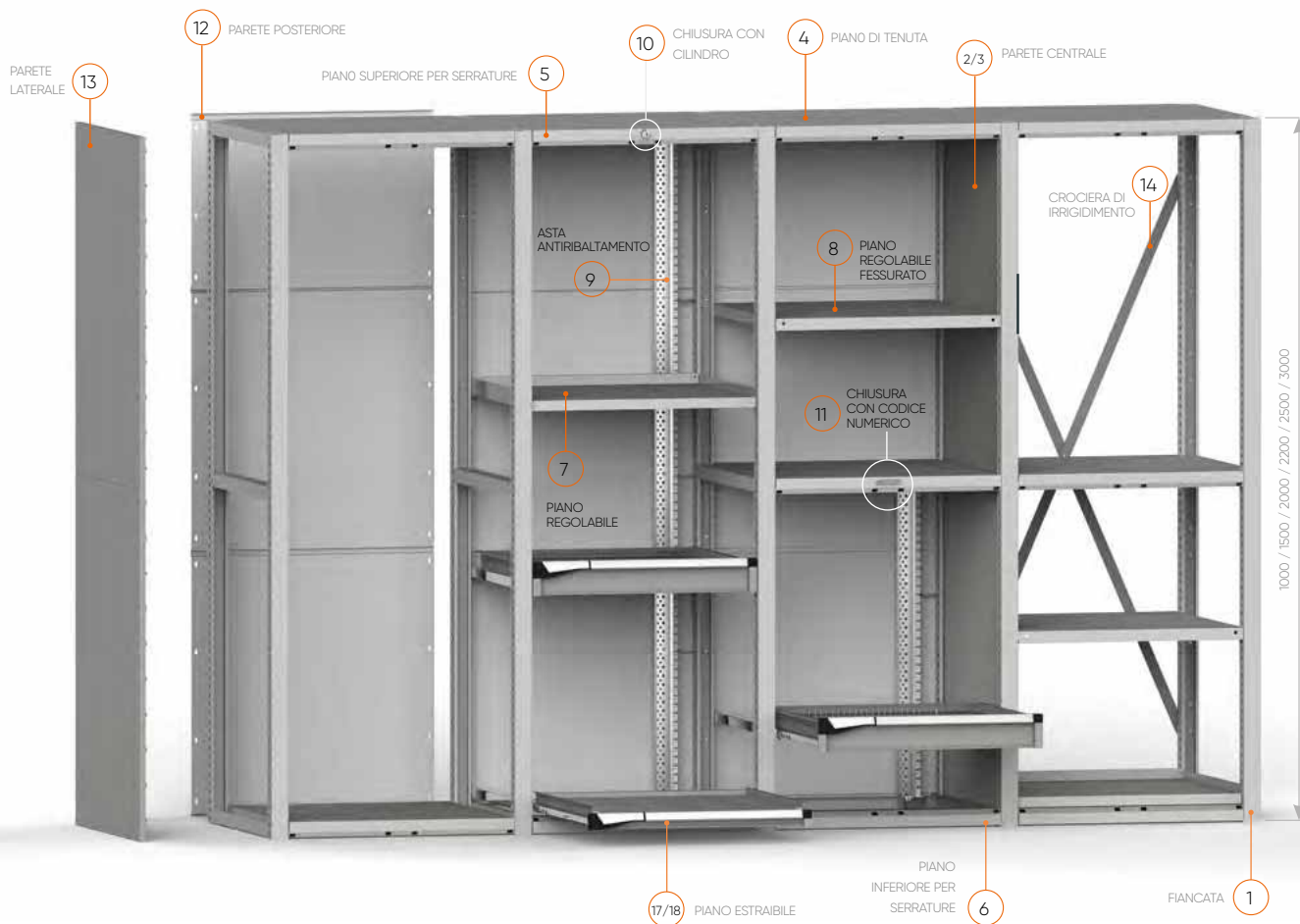

Gamma colori



FIANCATE

1	ART.	Dim. mm
	M 03 F100 00 00 01	51x726x1000 H
	M 03 F150 00 00 01	51x726x1500 h
	M 03 F200 00 00 01	51x726x2000 H
	M 03 F225 00 00 01	51x726x2250 H
	M 03 F250 00 00 01	51x726x2500 H
	M 03 F300 00 00 01	51x726x3000 H

COMPLETE DI TAPPI DI CHIUSURA

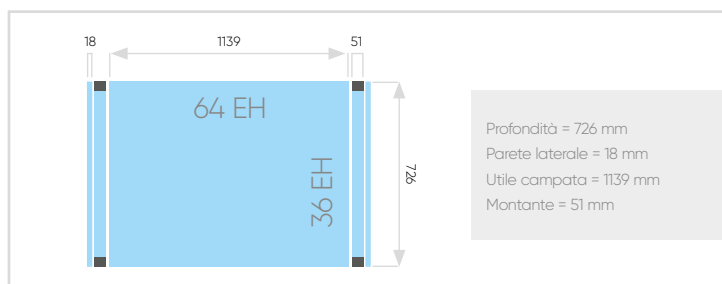

2 PARETE INFERIORE

H fiancata	ART.	Dim. mm H
1000	-	1000
1500	-	1500
2000	M 03 W100 MO 20 00	1000
2250	M 03 W100 MO 20 00	1000
2500	M 03 W100 MO 20 00	1000
3000	M 03 W100 MO 20 00	1000

3 PARETE SUPERIORE

ART.	Dim. mm H
-	-
M 03 W100 MO 10 00	1000
M 03 W125 MO 10 00	1250
M 03 W150 MO 10 00	1500
M 03 W100 MO 10 00*	1000

*Nell'altezza 3000 mm sono necessarie due pareti centrali superiori a chiusura della fiancata

PARETI CENTRALI

PIANO DI TENUTA

4	ART.		Dim. mm
	M 63 PT46 00 10 00 _ _		1139x724x46 H

PORTATA 250 kg

PIANO SUPERIORE PER SERRATURE

5	ART.		Dim. mm
	M 63 PS46 00 10 00 _ _		1139x724x46 H

PORTATA 150 kg

PIANO INFERIORE PER SERRATURE

6	ART.		Dim. mm
	M 63 PS46 10 10 00 _ _		1139x724x46 H

PORTATA 150 kg

PIANO REGOLABILE

7	ART.		Dim. mm
	M 63 PR25 00 00 01 _ _		1133x631x60 H

INSERIBILE DAVANTI ALL'ASTA VERTEBRATA
PORTATA 150 kg

PIANO REGOLABILE FESSURATO

8	ART.		Dim. mm
	M 63 PR35 10 00 01 _ _		1139x721x35 H

NON INSERIBILE IN PRESENZA DELL'ASTA VERTEBRATA
PORTATA 300 kg

ASTA ANTIRIBALTAMENTO

9	ART.	H asta mm
	M 00 V030 00 00 00 00	300
	M 00 V050 00 00 00 00	500
	M 00 V060 00 00 00 00	600
	M 00 V070 00 00 00 00	700
	M 00 V075 00 00 00 00	750
	M 00 V090 00 00 00 00	900
	M 00 V105 00 00 00 00	1050
	M 00 V122 00 00 00 00	1225
	M 00 V140 00 00 00 00	1400
	M 00 V152 00 00 00 00	1525
	M 00 V190 00 00 00 00	1900

È obbligatorio l'utilizzo dell'asta antiribaltamento con cassetti e con piani per evitare il ribaltamento della scaffalatura

CHIUSURA CON CILINDRO (KEY)

10	ART.		
	M 63 V000 C0 00 00 00	C0	numerazione diversa
	M 63 V000 C1 00 00 00	C1	gruppi di 160 numeri
	M 63 V000 C2 00 00 00	C2	numerazione uguale

COMPLETA DI: 1 serratura a cilindro con 2 chiavi, 1 filo in acciaio con guaina, 1 gruppo percussore anteriore, 1 gruppo cursore posteriore



SERRATURA A CHIAVE
Fornita di serie la chiusura a cilindro "C0".

CHIUSURA CON CODICE NUMERICO (CODE)

11	ART.		
	M 63 V000 E2 00 00 00	E2	apertura/chiusura asta
	M 63 V000 T2 00 00 00	T2	apertura/chiusura asta+porta

ART. TELECOMANDO		
M 00 VRC0 00 00 00 00		Modulo ricevitore con telecomando
M 00 VRC0 00 00 01 00		Telecomando aggiuntivo

PARETI POSTERIORI

12	ART.		Dim. mm
	M 60 W100 PO 00 00 00 _ _		1189x1000 H
	M 60 W150 PO 00 00 00 _ _		1189x1500 H
	M 60 W200 PO 00 00 00 _ _		1189x2000 H
	M 60 W225 PO 00 00 00 _ _		1189x2250 H
	M 60 W250 PO 00 00 00 _ _		1189x2500 H
	M 60 W300 PO 00 00 00 _ _		1189x3000 H

È obbligatorio almeno ogni 3 campate utilizzare una campata con parete posteriore

PARETI LATERALI

13	ART.		Dim. mm
	M 03 W100 LO 00 00 _ _		18x725x1000 H
	M 03 W125 LO 00 00 _ _		18x725x1250 H
	M 03 W150 LO 00 00 _ _		18x725x1500 H

CROCIERE DI IRRIGIDIMENTO

14	ART.		Per altezza scaffali
	M 60 X150 00 00 00 _ _		1500/2250
	M 60 X250 00 00 00 _ _		2500/3000

È obbligatorio almeno ogni 3 campate utilizzare una campata con crociera

SYSTEM SR-MASTER



15

CASSETTI AD ESTRAZIONE FLESSIBILE

ART. CON kit plastiche Dark Grey	ART. SENZA kit plastiche*	Dim. utili mm	H frontale mm	kg	
M 63 C075 0110 OF __	M 63 C075 0100 OF __	1076x600x56 H	75	50 - 75 - 100	100% - 96% - 92%
M 63 C100 0110 OF __	M 63 C100 0100 OF __	1076x600x81 H	100	50 - 75 - 100	100% - 96% - 92%
M 63 C125 0110 OF __	M 63 C125 0100 OF __	1076x600x106 H	125	50 - 75 - 100	100% - 96% - 92%
M 63 C150 0110 OF __	M 63 C150 0100 OF __	1076x600x131 H	150	50 - 75 - 100	100% - 96% - 92%
M 63 C200 0110 OF __	M 63 C200 0100 OF __	1076x600x181 H	200	50 - 75 - 100	100% - 96% - 92%
M 63 C250 0110 OF __	M 63 C250 0100 OF __	1076x600x231 H	250	50 - 75 - 100	100% - 96% - 92%
M 63 C300 0110 OF __	M 63 C300 0100 OF __	1076x600x281 H	300	50 - 75 - 100	100% - 96% - 92%

* ABBINARE AL CODICE ARTICOLO UNO DEI KIT PLASTICHE DISPONIBILI NELLA TABELLA SOTTOSTANTE



16

CASSETTI AD ESTRAZIONE TELESCOPICA

ART. CON kit plastiche Dark Grey	ART. SENZA kit plastiche*	Dim. utili mm	H frontale mm	kg	
M 63 C075 0110 OT __	M 63 C075 0100 OT __	1076x600x56 H	75	200	100%
M 63 C100 0110 OT __	M 63 C100 0100 OT __	1076x600x81 H	100	200	100%
M 63 C125 0110 OT __	M 63 C125 0100 OT __	1076x600x106 H	125	200	100%
M 63 C150 0110 OT __	M 63 C150 0100 OT __	1076x600x131 H	150	200	100%
M 63 C200 0110 OT __	M 63 C200 0100 OT __	1076x600x181 H	200	200	100%
M 63 C250 0110 OT __	M 63 C250 0100 OT __	1076x600x231 H	250	200	100%
M 63 C300 0110 OT __	M 63 C300 0100 OT __	1076x600x281 H	300	200	100%

* ABBINARE AL CODICE ARTICOLO UNO DEI KIT PLASTICHE DISPONIBILI NELLA TABELLA SOTTOSTANTE

KIT PLASTICHE PER CASSETTI E PIANI ESTRAIBILI



GAMMA COLORI PLASTICHE	ART.
MEDITERRANEAN BLUE	M 60 PLS1 00 00 00 M1
SKY BLUE	M 60 PLS1 00 00 00 M2
GLAMOUR RED	M 60 PLS1 00 00 00 M3
RED CARPET	M 60 PLS1 00 00 00 M4
JUICY ORANGE	M 60 PLS1 00 00 00 M5
SUNNY YELLOW	M 60 PLS1 00 00 00 M6
FOREST GREEN	M 60 PLS1 00 00 00 M7



17

PIANO ESTRAIBILE AD ESTRAZIONE FLESSIBILE

ART. CON kit plastiche Dark Grey	ART. SENZA kit plastiche*	Dim. utili mm	H frontale mm	kg	
M 63 C057 0110 0F _ _	M 63 C057 0100 0F _ _	1076x600	70	50 - 75 - 100	100% - 96% - 92%

* ABBINARE AL CODICE ARTICOLO UNO DEI KIT PLASTICHE DISPONIBILI NELLA TABELLA A SINISTRA



18

PIANO ESTRAIBILE AD ESTRAZIONE TELESCOPICA

ART. CON kit plastiche Dark Grey	ART. SENZA kit plastiche*	Dim. utili mm	H frontale mm	kg	
M 63 C057 0110 0T _ _	M 63 C057 0100 0T _ _	1076x600	70	200	100%

* ABBINARE AL CODICE ARTICOLO UNO DEI KIT PLASTICHE DISPONIBILI NELLA TABELLA A SINISTRA



SYSTEM SR-MASTER

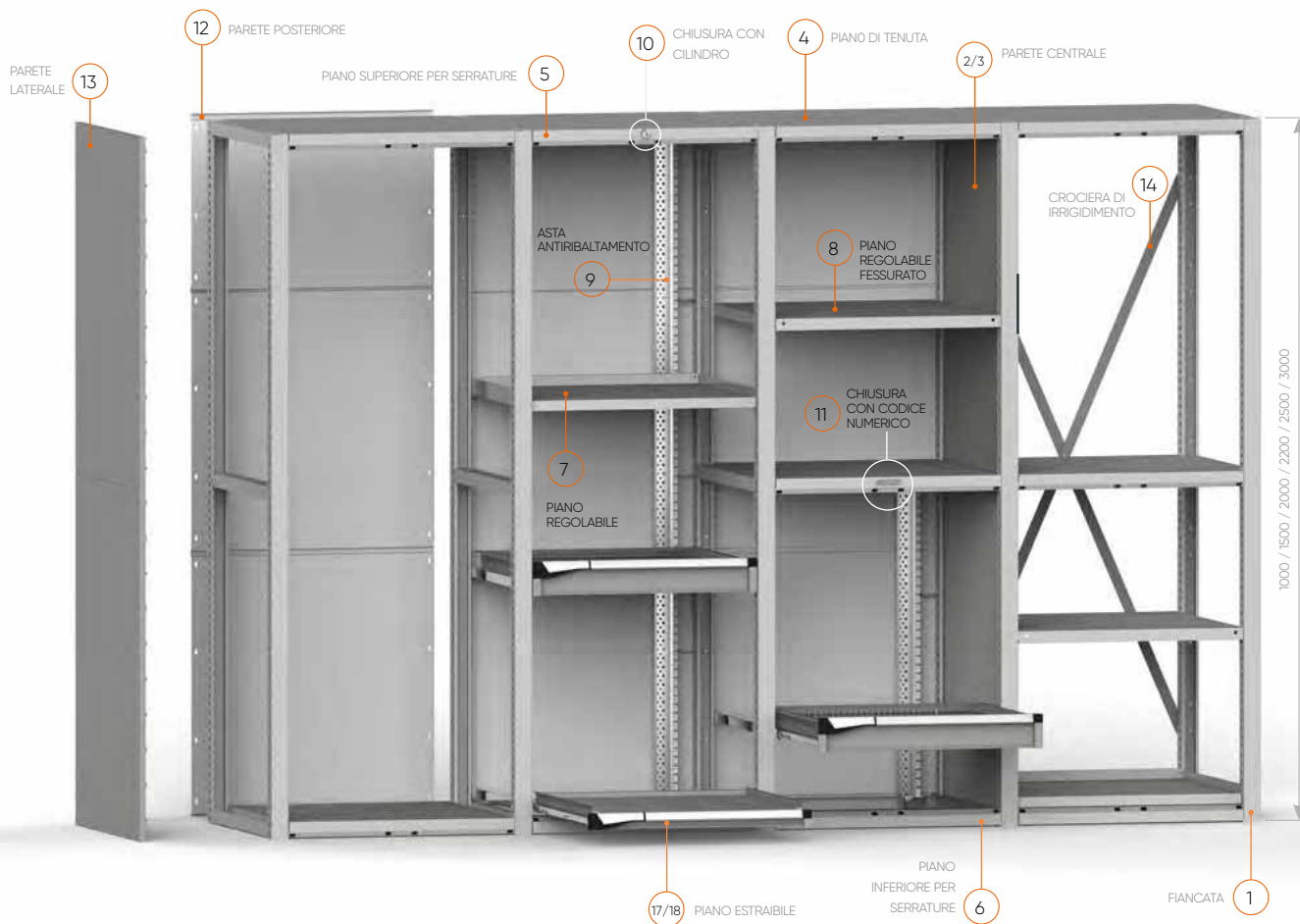

Gamma colori

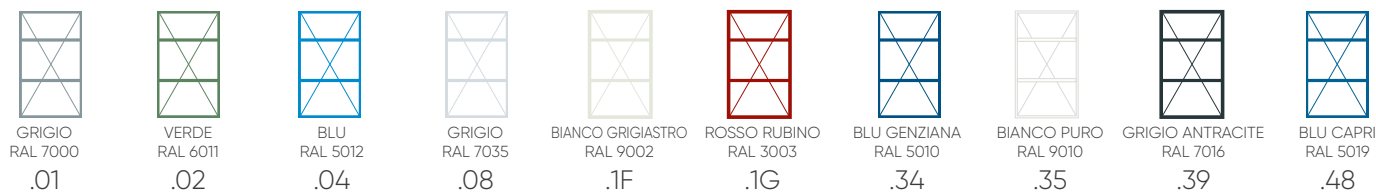

FIANCATE

1	ART.	Dim. mm
	M 03 F100 00 00 01	51x726x1000 H
	M 03 F150 00 00 01	51x726x1500 H
	M 03 F200 00 00 01	51x726x2000 H
	M 03 F225 00 00 01	51x726x2250 H
	M 03 F250 00 00 01	51x726x2500 H
	M 03 F300 00 00 01	51x726x3000 H

COMPLETE DI TAPPI DI CHIUSURA

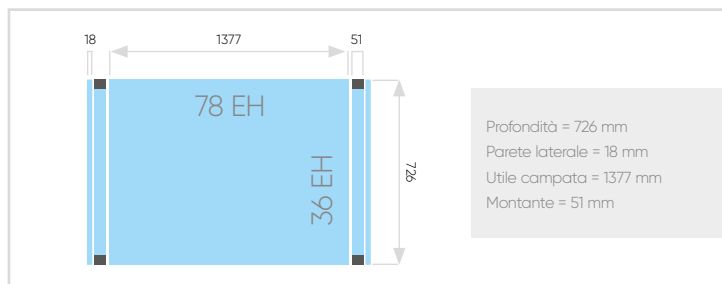

Profondità = 726 mm
 Parete laterale = 18 mm
 Utile campata = 1377 mm
 Montante = 51 mm

2 PARETE INFERIORE

H fiancata	ART.	Dim. mm H
1000	-	-
1500	-	-
2000	M 03 W100 MO 20 00	1000
2250	M 03 W100 MO 20 00	1000
2500	M 03 W100 MO 20 00	1000
3000	M 03 W100 MO 20 00	1000

3 PARETE SUPERIORE

ART.	Dim. mm H
-	-
-	-
M 03 W100 MO 10 00	1000
M 03 W125 MO 10 00	1250
M 03 W150 MO 10 00	1500
M 03 W100 MO 10 00*	1000

*Nell'altezza 3000 mm sono necessarie due pareti centrali superiori a chiusura della fiancata

PARETI CENTRALI

PIANO DI TENUTA

4	ART.		Dim. mm
	M 73 PT46 00 10 00 _ _		1377x724x46 H

PORTATA 250 kg

PIANO SUPERIORE PER SERRATURE

5	ART.		Dim. mm
	M 73 PS46 00 10 00 _ _		1377x724x46 H

PORTATA 150 kg

PIANO INFERIORE PER SERRATURE

6	ART.		Dim. mm
	M 73 PS46 10 10 00 _ _		1377x724x46 H

PORTATA 150 kg

PIANO REGOLABILE

7	ART.		Dim. mm
	M 73 PR25 00 00 01 _ _		1371x631x60 H

INSERIBILE DAVANTI ALL'ASTA VERTEBRATA
PORTATA 150 kg

PIANO REGOLABILE FESSURATO

8	ART.		Dim. mm
	M 73 PR35 10 00 01 _ _		1377x721x35 H

NON INSERIBILE IN PRESENZA DELL'ASTA VERTEBRATA
PORTATA 300 kg

ASTA ANTIRIBALTAMENTO

9	ART.	H asta mm
	M 00 V030 00 00 00 00	300
	M 00 V050 00 00 00 00	500
	M 00 V060 00 00 00 00	600
	M 00 V070 00 00 00 00	700
	M 00 V075 00 00 00 00	750
	M 00 V090 00 00 00 00	900
	M 00 V105 00 00 00 00	1050
	M 00 V122 00 00 00 00	1225
	M 00 V140 00 00 00 00	1400
	M 00 V152 00 00 00 00	1525
	M 00 V190 00 00 00 00	1900

È obbligatorio l'utilizzo dell'asta antiribaltamento con cassetti e con piani per evitare il ribaltamento della scaffalatura

CHIUSURA CON CILINDRO (KEY)

10	ART.		
	M 73 V000 C0 00 00 00	C0	numerazione diversa
	M 73 V000 C1 00 00 00	C1	gruppi di 160 numeri
	M 73 V000 C2 00 00 00	C2	numerazione uguale

COMPLETA DI: 1 serratura a cilindro con 2 chiavi, 1 filo in acciaio con guaina, 1 gruppo percussore anteriore, 1 gruppo cursore posteriore

SERRATURA A CHIAVE
Fornita di serie la chiusura a cilindro "C0".

CHIUSURA CON CODICE NUMERICO (CODE)

11	ART.		
	M 73 V000 E2 00 00 00	E2	apertura/chiusura asta
	M 73 V000 T2 00 00 00	T2	apertura/chiusura asta+porta

ART. TELECOMANDO		
M 00 VRC0 00 00 00 00		Modulo ricevitore con telecomando
M 00 VRC0 00 00 01 00		Telecomando aggiuntivo

PARETI POSTERIORI

12	ART.		Dim. mm
	M 70 W100 PO 00 00 _ _		1427x1000 H
	M 70 W150 PO 00 00 _ _		1427x1500 H
	M 70 W200 PO 00 00 _ _		1427x2000 H
	M 70 W225 PO 00 00 _ _		1427x2250 H
	M 70 W250 PO 00 00 _ _		1427x2500 H
	M 70 W300 PO 00 00 _ _		1427x3000 H

È obbligatorio almeno ogni 3 campate utilizzare una campata con parete posteriore

PARETI LATERALI

13	ART.		Dim. mm
	M 03 W100 LO 00 00 _ _		18x725x1000 H
	M 03 W125 LO 00 00 _ _		18x725x1250 H
	M 03 W150 LO 00 00 _ _		18x725x1500 H

CROCIERE DI IRRIGIDIMENTO

14	ART.		Per altezza scaffali
	M 70 X150 00 00 00 _ _		1500/2250
	M 70 X250 00 00 00 _ _		2500/3000

È obbligatorio almeno ogni 3 campate utilizzare una campata con crociera

SYSTEM SR-MASTER



CASSETTI AD ESTRAZIONE FLESSIBILE

ART. CON kit plastiche Dark Grey	ART. SENZA kit plastiche*	Dim. utili mm	H frontale mm	kg	
M 73 C075 0110 OF __	M 73 C075 0100 OF __	1314x600x56 H	75	50 - 75 - 100	100% - 96% - 92%
M 73 C100 0110 OF __	M 73 C100 0100 OF __	1314x600x81 H	100	50 - 75 - 100	100% - 96% - 92%
M 73 C125 0110 OF __	M 73 C125 0100 OF __	1314x600x106 H	125	50 - 75 - 100	100% - 96% - 92%
M 73 C150 0110 OF __	M 73 C150 0100 OF __	1314x600x131 H	150	50 - 75 - 100	100% - 96% - 92%
M 73 C200 0110 OF __	M 73 C200 0100 OF __	1314x600x181 H	200	50 - 75 - 100	100% - 96% - 92%
M 73 C250 0110 OF __	M 73 C250 0100 OF __	1314x600x231 H	250	50 - 75 - 100	100% - 96% - 92%
M 73 C300 0110 OF __	M 73 C300 0100 OF __	1314x600x281 H	300	50 - 75 - 100	100% - 96% - 92%

* ABBINARE AL CODICE ARTICOLO UNO DEI KIT PLASTICHE DISPONIBILI NELLA TABELLA SOTTOSTANTE



CASSETTI AD ESTRAZIONE TELESCOPICA

ART. CON kit plastiche Dark Grey	ART. SENZA kit plastiche*	Dim. utili mm	H frontale mm	kg	
M 73 C075 0110 OT __	M 73 C075 0100 OT __	1314x600x56 H	75	200	100%
M 73 C100 0110 OT __	M 73 C100 0100 OT __	1314x600x81 H	100	200	100%
M 73 C125 0110 OT __	M 73 C125 0100 OT __	1314x600x106 H	125	200	100%
M 73 C150 0110 OT __	M 73 C150 0100 OT __	1314x600x131 H	150	200	100%
M 73 C200 0110 OT __	M 73 C200 0100 OT __	1314x600x181 H	200	200	100%
M 73 C250 0110 OT __	M 73 C250 0100 OT __	1314x600x231 H	250	200	100%
M 73 C300 0110 OT __	M 73 C300 0100 OT __	1314x600x281 H	300	200	100%

* ABBINARE AL CODICE ARTICOLO UNO DEI KIT PLASTICHE DISPONIBILI NELLA TABELLA SOTTOSTANTE

KIT PLASTICHE PER CASSETTI E PIANI ESTRAIBILI



GAMMA COLORI PLASTICHE	ART.
MEDITERRANEAN BLUE	M 70 PLS1 00 00 00 M1
SKY BLUE	M 70 PLS1 00 00 00 M2
GLAMOUR RED	M 70 PLS1 00 00 00 M3
RED CARPET	M 70 PLS1 00 00 00 M4
JUICY ORANGE	M 70 PLS1 00 00 00 M5
SUNNY YELLOW	M 70 PLS1 00 00 00 M6
FOREST GREEN	M 70 PLS1 00 00 00 M7



PIANO ESTRAIBILE AD ESTRAZIONE FLESSIBILE

ART. CON kit plastiche Dark Grey	ART. SENZA kit plastiche*	Dim. utili mm	H frontale mm	kg	
M73 C057 0110 0F __	M73 C057 0100 0F __	1314x600	70	50 - 75 - 100	100% - 96% - 92%

* ABBINARE AL CODICE ARTICOLO UNO DEI KIT PLASTICHE DISPONIBILI NELLA TABELLA A SINISTRA



PIANO ESTRAIBILE AD ESTRAZIONE TELESCOPICA

ART. CON kit plastiche Dark Grey	ART. SENZA kit plastiche*	Dim. utili mm	H frontale mm	kg	
M73 C057 0110 0T __	M73 C057 0100 0T __	1314x600	70	200	100%

* ABBINARE AL CODICE ARTICOLO UNO DEI KIT PLASTICHE DISPONIBILI NELLA TABELLA A SINISTRA



SYSTEM SR-MASTER



KIT PLASTICHE







COLORI

8 colori per gli accessori in plastica









KIT PLASTICHE CHIUSURA A CILINDRO



GAMMA COLORI PLASTICHE	ART. per porta singola	ART. per coppia porte
 MEDITERRANEAN BLUE	M 00 PLS0 00 00 20 M1	M 00 PLS0 00 00 30 M1
 SKY BLUE	M 00 PLS0 00 00 20 M2	M 00 PLS0 00 00 30 M2
 GLAMOUR RED	M 00 PLS0 00 00 20 M3	M 00 PLS0 00 00 30 M3
 RED CARPET	M 00 PLS0 00 00 20 M4	M 00 PLS0 00 00 30 M4
 JUICY ORANGE	M 00 PLS0 00 00 20 M5	M 00 PLS0 00 00 30 M5
 SUNNY YELLOW	M 00 PLS0 00 00 20 M6	M 00 PLS0 00 00 30 M6
 FOREST GREEN	M 00 PLS0 00 00 20 M7	M 00 PLS0 00 00 30 M7







KIT PLASTICHE CODICE NUMERICO

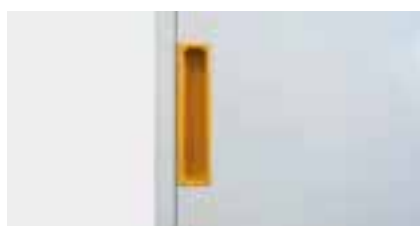

GAMMA COLORI PLASTICHE	ART. per porta singola	ART. per coppia porte
 MEDITERRANEAN BLUE	M 00 PLS0 00 00 21 M1	M 00 PLS0 00 00 31 M1
 SKY BLUE	M 00 PLS0 00 00 21 M2	M 00 PLS0 00 00 31 M2
 GLAMOUR RED	M 00 PLS0 00 00 21 M3	M 00 PLS0 00 00 31 M3
 RED CARPET	M 00 PLS0 00 00 21 M4	M 00 PLS0 00 00 31 M4
 JUICY ORANGE	M 00 PLS0 00 00 21 M5	M 00 PLS0 00 00 31 M5
 SUNNY YELLOW	M 00 PLS0 00 00 21 M6	M 00 PLS0 00 00 31 M6
 FOREST GREEN	M 00 PLS0 00 00 21 M7	M 00 PLS0 00 00 31 M7

KIT PLASTICHE PER PORTE SCORREVOLI









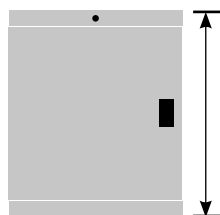

GAMMA COLORI PLASTICHE	ART. 2 PORTE SCORREVOLI	ART. 1 PORTA SCORREVOLE
 MEDITERRANEAN BLUE	M 00 PLS0 00 00 50 M1	M 00 PLS0 00 00 40 M1
 SKY BLUE	M 00 PLS0 00 00 50 M2	M 00 PLS0 00 00 40 M2
 GLAMOUR RED	M 00 PLS0 00 00 50 M3	M 00 PLS0 00 00 40 M3
 RED CARPET	M 00 PLS0 00 00 50 M4	M 00 PLS0 00 00 40 M4
 JUICY ORANGE	M 00 PLS0 00 00 50 M5	M 00 PLS0 00 00 40 M5
 SUNNY YELLOW	M 00 PLS0 00 00 50 M6	M 00 PLS0 00 00 40 M6
 FOREST GREEN	M 00 PLS0 00 00 50 M7	M 00 PLS0 00 00 40 M7

SYSTEM SR-MASTER

🔑 PORTE A BATTENTE CON CILINDRO

PORTE A BATTENTE ALTEZZA TOTALE - REVERSIBILE









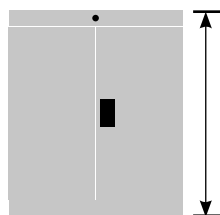







H INGOMBRO PORTA mm**	TIPO DI CHIUSURA	ART. CON kit plastiche Dark Grey 	ART. SENZA kit plastiche* 
600	 C0 KEY chiusura a cilindro	M30P050C01000 __	M30P050C00000 __
	 C1 KEY chiusura a cilindro	M30P050C11000 __	M30P050C10000 __
	 C2 KEY chiusura a cilindro	M30P050C21000 __	M30P050C20000 __
700	 C0 KEY chiusura a cilindro	M30P060C01000 __	M30P060C00000 __
	 C1 KEY chiusura a cilindro	M30P060C11000 __	M30P060C10000 __
	 C2 KEY chiusura a cilindro	M30P060C21000 __	M30P060C20000 __

**ALTEZZA COMPRESIVA DI PIANI DI TENUTA SUPERIORE E INFERIORE

COPIA PORTE A BATTENTE ALTEZZA TOTALE



H INGOMBRO PORTA mm**	TIPO DI CHIUSURA	ART. CON kit plastiche Dark Grey 	ART. SENZA kit plastiche* 
850	 C0 KEY chiusura a cilindro	M30P075C01010 __	M30P075C00010 __
	 C1 KEY chiusura a cilindro	M30P075C11010 __	M30P075C10010 __
	 C2 KEY chiusura a cilindro	M30P075C21010 __	M30P075C20010 __
1000	 C0 KEY chiusura a cilindro	M30P090C01010 __	M30P090C00010 __
	 C1 KEY chiusura a cilindro	M30P090C11010 __	M30P090C10010 __
	 C2 KEY chiusura a cilindro	M30P090C21010 __	M30P090C20010 __
1500	 C0 KEY chiusura a cilindro	M30P140C01010 __	M30P140C00010 __
	 C1 KEY chiusura a cilindro	M30P140C11010 __	M30P140C10010 __
	 C2 KEY chiusura a cilindro	M30P140C21010 __	M30P140C20010 __
2000	 C0 KEY chiusura a cilindro	M30P190C01010 __	M30P190C00010 __
	 C1 KEY chiusura a cilindro	M30P190C11010 __	M30P190C10010 __
	 C2 KEY chiusura a cilindro	M30P190C21010 __	M30P190C20010 __

**ALTEZZA COMPRESIVA DI PIANI DI TENUTA SUPERIORE E INFERIORE



PORTE A BATTENTE CON CODICE NUMERICO

PORTE A BATTENTE ALTEZZA TOTALE - APERTURA SOLO A DESTRA

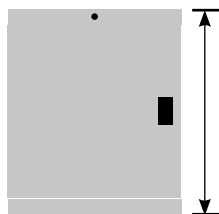

H ARMADIO mm**	TIPO DI CHIUSURA	ART. CON kit plastiche Dark Grey	ART. SENZA kit plastiche*
600	 P5 CODE codice numerico	M 30 P050 P5 10 00 __	M 30 P050 P5 00 00 __
700	 P5 CODE codice numerico	M 30 P060 P5 10 00 __	M 30 P050 P5 00 00 __

**ALTEZZA COMPRESIVA DI PIANI DI TENUTA SUPERIORE E INFERIORE

COPPIA PORTE A BATTENTE ALTEZZA TOTALE

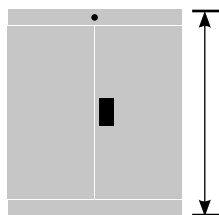

H ARMADIO mm**	TIPO DI CHIUSURA	ART. CON kit plastiche Dark Grey	ART. SENZA kit plastiche*
850	 P5 CODE codice numerico	M 30 P075 P5 10 10 __	M 30 P075 P5 00 10 __
1000	 P5 CODE codice numerico	M 30 P090 P5 10 10 __	M 30 P090 P5 00 10 __
1500	 P5 CODE codice numerico	M 30 P140 P5 10 10 __	M 30 P140 P5 00 10 __
2000	 P5 CODE codice numerico	M 30 P190 P5 10 10 __	M 30 P190 P5 00 10 __

**ALTEZZA COMPRESIVA DI PIANI DI TENUTA SUPERIORE E INFERIORE



🔑 PORTE A BATTENTE CON CILINDRO

COPPIA PORTE A BATTENTE ALTEZZA TOTALE

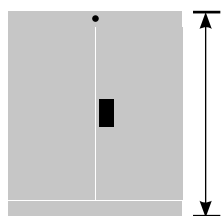

H INGOMBRO PORTA mm**	TIPO DI CHIUSURA	ART. CON kit plastiche Dark Grey	ART. SENZA kit plastiche*
850	C0 KEY chiusura a cilindro	M 40 P075 C010 10 __	M 40 P075 C0 00 10 __
	C1 KEY chiusura a cilindro	M 40 P075 C110 10 __	M 40 P075 C1 00 10 __
	C2 KEY chiusura a cilindro	M 40 P075 C210 10 __	M 40 P075 C2 00 10 __
1000	C0 KEY chiusura a cilindro	M 40 P090 C010 10 __	M 40 P090 C0 00 10 __
	C1 KEY chiusura a cilindro	M 40 P090 C110 10 __	M 40 P090 C1 00 10 __
	C2 KEY chiusura a cilindro	M 40 P090 C210 10 __	M 40 P090 C2 00 10 __
1500	C0 KEY chiusura a cilindro	M 40 P140 C010 10 __	M 40 P140 C0 00 10 __
	C1 KEY chiusura a cilindro	M 40 P140 C110 10 __	M 40 P140 C1 00 10 __
	C2 KEY chiusura a cilindro	M 40 P140 C210 10 __	M 40 P140 C2 00 10 __
2000	C0 KEY chiusura a cilindro	M 40 P190 C010 10 __	M 40 P190 C0 00 10 __
	C1 KEY chiusura a cilindro	M 40 P190 C110 10 __	M 40 P190 C1 00 10 __
	C2 KEY chiusura a cilindro	M 40 P190 C210 10 __	M 40 P190 C2 00 10 __

**ALTEZZA COMPRESIVA DI PIANI DI TENUTA SUPERIORE E INFERIORE



PORTE A BATTENTE CON CODICE NUMERICO

COPPIA PORTE A BATTENTE ALTEZZA TOTALE

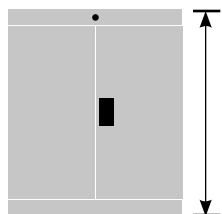

H INGOMBRO PORTA mm**	TIPO DI CHIUSURA	ART. CON kit plastiche Dark Grey	ART. SENZA kit plastiche*
850	P5 CODE codice numerico	M 40 P075 P5 10 10 __	M 40 P075 P5 00 10 __
1000	P5 CODE codice numerico	M 40 P090 P5 10 10 __	M 40 P090 P5 00 10 __
1500	P5 CODE codice numerico	M 40 P140 P5 10 10 __	M 40 P140 P5 00 10 __
2000	P5 CODE codice numerico	M 40 P190 P5 10 10 __	M 40 P190 P5 00 10 __

**ALTEZZA COMPRESIVA DI PIANI DI TENUTA SUPERIORE E INFERIORE



🔑 PORTE A BATTENTE CON CILINDRO

COPPIA PORTE A BATTENTE ALTEZZA TOTALE

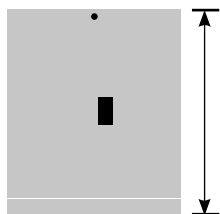

H INGOMBRO PORTA mm**	TIPO DI CHIUSURA	ART. CON kit plastiche Dark Grey	ART. SENZA kit plastiche*
850	C0 KEY chiusura a cilindro	M 50 P075 C0 10 10 __	M 50 P075 C0 00 10 __
	C1 KEY chiusura a cilindro	M 50 P075 C1 10 10 __	M 50 P075 C1 00 10 __
	C2 KEY chiusura a cilindro	M 50 P075 C2 10 10 __	M 50 P075 C2 00 10 __
1000	C0 KEY chiusura a cilindro	M 50 P090 C0 10 10 __	M 50 P090 C0 00 10 __
	C1 KEY chiusura a cilindro	M 50 P090 C1 10 10 __	M 50 P090 C1 00 10 __
	C2 KEY chiusura a cilindro	M 50 P090 C2 10 10 __	M 50 P090 C2 00 10 __
1500	C0 KEY chiusura a cilindro	M 50 P140 C0 10 10 __	M 50 P140 C0 00 10 __
	C1 KEY chiusura a cilindro	M 50 P140 C1 10 10 __	M 50 P140 C1 00 10 __
	C2 KEY chiusura a cilindro	M 50 P140 C2 10 10 __	M 50 P140 C2 00 10 __
2000	C0 KEY chiusura a cilindro	M 50 P190 C0 10 10 __	M 50 P190 C0 00 10 __
	C1 KEY chiusura a cilindro	M 50 P190 C1 10 10 __	M 50 P190 C1 00 10 __
	C2 KEY chiusura a cilindro	M 50 P190 C2 10 10 __	M 50 P190 C2 00 10 __

**ALTEZZA COMPRESIVA DI PIANI DI TENUTA SUPERIORE E INFERIORE



PORTE A BATTENTE CON CODICE NUMERICO

COPPIA PORTE A BATTENTE ALTEZZA TOTALE

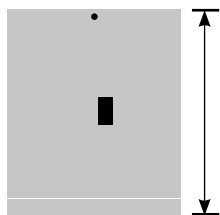









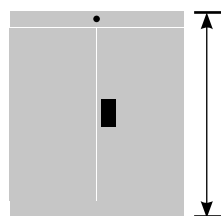





H INGOMBRO PORTA mm**	TIPO DI CHIUSURA	ART. CON kit plastiche Dark Grey	ART. SENZA kit plastiche*
850	P5 CODE codice numerico	M 50 P075 P5 10 10 __	M 50 P075 P5 00 10 __
1000	P5 CODE codice numerico	M 50 P090 P5 10 10 __	M 50 P090 P5 00 10 __
1500	P5 CODE codice numerico	M 50 P140 P5 10 10 __	M 50 P140 P5 00 10 __
2000	P5 CODE codice numerico	M 50 P190 P5 10 10 __	M 50 P190 P5 00 10 __

**ALTEZZA COMPRESIVA DI PIANI DI TENUTA SUPERIORE E INFERIORE

🔑 PORTE A BATTENTE CON CILINDRO

COPIA PORTE A BATTENTE ALTEZZA TOTALE







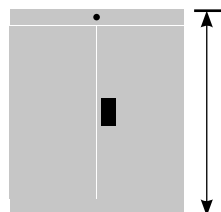

H INGOMBRO PORTA mm**	TIPO DI CHIUSURA	ART. CON kit plastiche Dark Grey 	ART. SENZA kit plastiche* 
850	 C0 KEY chiusura a cilindro	M 60 P075 C010 10 __	M 60 P075 C00010 __
	 C1 KEY chiusura a cilindro	M 60 P075 C110 10 __	M 60 P075 C10010 __
	 C2 KEY chiusura a cilindro	M 60 P075 C210 10 __	M 60 P075 C20010 __
1000	 C0 KEY chiusura a cilindro	M 60 P090 C010 10 __	M 60 P090 C00010 __
	 C1 KEY chiusura a cilindro	M 60 P090 C110 10 __	M 60 P090 C10010 __
	 C2 KEY chiusura a cilindro	M 60 P090 C210 10 __	M 60 P090 C20010 __
1500	 C0 KEY chiusura a cilindro	M 60 P140 C010 10 __	M 60 P140 C00010 __
	 C1 KEY chiusura a cilindro	M 60 P140 C110 10 __	M 60 P140 C10010 __
	 C2 KEY chiusura a cilindro	M 60 P140 C210 10 __	M 60 P140 C20010 __
2000	 C0 KEY chiusura a cilindro	M 60 P190 C010 10 __	M 60 P190 C00010 __
	 C1 KEY chiusura a cilindro	M 60 P190 C110 10 __	M 60 P190 C10010 __
	 C2 KEY chiusura a cilindro	M 60 P190 C210 10 __	M 60 P190 C20010 __

**ALTEZZA COMPRESIVA DI PIANI DI TENUTA SUPERIORE E INFERIORE

PORTE A BATTENTE CON CODICE NUMERICO

COPIA PORTE A BATTENTE ALTEZZA TOTALE



H INGOMBRO PORTA mm**	TIPO DI CHIUSURA	ART. CON kit plastiche Dark Grey 	ART. SENZA kit plastiche* 
850	 P5 CODE codice numerico	M 60 P075 P510 10 __	M 60 P075 P50010 __
1000	 P5 CODE codice numerico	M 60 P090 P510 10 __	M 60 P090 P50010 __
1500	 P5 CODE codice numerico	M 60 P140 P510 10 __	M 60 P140 P50010 __
2000	 P5 CODE codice numerico	M 60 P190 P510 10 __	M 60 P190 P50010 __

**ALTEZZA COMPRESIVA DI PIANI DI TENUTA SUPERIORE E INFERIORE



🔑 PORTE A BATTENTE CON CILINDRO

COPPIA PORTE A BATTENTE ALTEZZA TOTALE

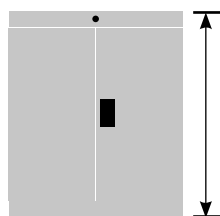

H INGOMBRO PORTA mm**	TIPO DI CHIUSURA	ART. CON kit plastiche Dark Grey	ART. SENZA kit plastiche*
850	C0 KEY chiusura a cilindro	M 70 P075 C0 10 10 __	M 70 P075 C000 10 __
	C1 KEY chiusura a cilindro	M 70 P075 C1 10 10 __	M 70 P075 C100 10 __
	C2 KEY chiusura a cilindro	M 70 P075 C2 10 10 __	M 70 P075 C200 10 __
1000	C0 KEY chiusura a cilindro	M 70 P090 C0 10 10 __	M 70 P090 C000 10 __
	C1 KEY chiusura a cilindro	M 70 P090 C1 10 10 __	M 70 P090 C100 10 __
	C2 KEY chiusura a cilindro	M 70 P090 C2 10 10 __	M 70 P090 C200 10 __
1500	C0 KEY chiusura a cilindro	M 70 P140 C0 10 10 __	M 70 P140 C000 10 __
	C1 KEY chiusura a cilindro	M 70 P140 C1 10 10 __	M 70 P140 C100 10 __
	C2 KEY chiusura a cilindro	M 70 P140 C2 10 10 __	M 70 P140 C200 10 __
2000	C0 KEY chiusura a cilindro	M 70 P190 C0 10 10 __	M 70 P190 C000 10 __
	C1 KEY chiusura a cilindro	M 70 P190 C1 10 10 __	M 70 P190 C100 10 __
	C2 KEY chiusura a cilindro	M 70 P190 C2 10 10 __	M 70 P190 C200 10 __

**ALTEZZA COMPRESIVA DI PIANI DI TENUTA SUPERIORE E INFERIORE



PORTE A BATTENTE CON CODICE NUMERICO

COPPIA PORTE A BATTENTE ALTEZZA TOTALE

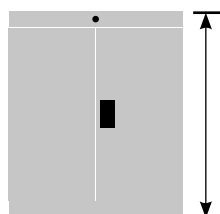

H INGOMBRO PORTA mm**	TIPO DI CHIUSURA	ART. CON kit plastiche Dark Grey	ART. SENZA kit plastiche*
850	P5 CODE codice numerico	M 70 P075 P5 10 10 __	M 70 P075 P500 10 __
1000	P5 CODE codice numerico	M 70 P090 P5 10 10 __	M 70 P090 P500 10 __
1500	P5 CODE codice numerico	M 70 P140 P5 10 10 __	M 70 P140 P500 10 __
2000	P5 CODE codice numerico	M 70 P190 P5 10 10 __	M 70 P190 P500 10 __

**ALTEZZA COMPRESIVA DI PIANI DI TENUTA SUPERIORE E INFERIORE

SYSTEM SR-MASTER









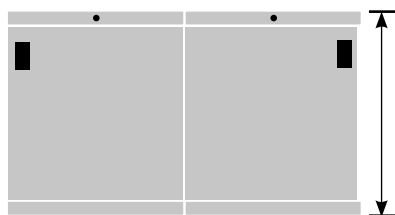











COPPIA PORTE SCORREVOLI CON CILINDRO



H INGOMBRO PORTA mm**	TIPO DI CHIUSURA	ART. con kit plastiche Dark Grey 	ART. SENZA kit plastiche* 
850 (utile 750 mm)	 C0 KEY chiusura a cilindro	M 30 P075 C0 10 31 _ _	M 30 P075 C0 00 31 _ _
	 C1 KEY chiusura a cilindro	M 30 P075 C1 10 31 _ _	M 30 P075 C1 00 31 _ _
	 C2 KEY chiusura a cilindro	M 30 P075 C2 10 31 _ _	M 30 P075 C2 00 31 _ _
1000 (utile 900 mm)	 C0 KEY chiusura a cilindro	M 30 P090 C0 10 31 _ _	M 30 P090 C0 00 31 _ _
	 C1 KEY chiusura a cilindro	M 30 P090 C1 10 31 _ _	M 30 P090 C1 00 31 _ _
	 C2 KEY chiusura a cilindro	M 30 P090 C2 10 31 _ _	M 30 P090 C2 00 31 _ _
1500 (utile 1400 mm)	 C0 KEY chiusura a cilindro	M 30 P140 C0 10 31 _ _	M 30 P140 C0 00 31 _ _
	 C1 KEY chiusura a cilindro	M 30 P140 C1 10 31 _ _	M 30 P140 C1 00 31 _ _
	 C2 KEY chiusura a cilindro	M 30 P140 C2 10 31 _ _	M 30 P140 C2 00 31 _ _
2000 (utile 1900 mm)	 C0 KEY chiusura a cilindro	M 30 P190 C0 10 31 _ _	M 30 P190 C0 00 31 _ _
	 C1 KEY chiusura a cilindro	M 30 P190 C1 10 31 _ _	M 30 P190 C1 00 31 _ _
	 C2 KEY chiusura a cilindro	M 30 P190 C2 10 31 _ _	M 30 P190 C2 00 31 _ _

**ALTEZZA COMPRESIVA DI PIANI DI TENUTA SUPERIORE ED INFERIORE

🔑 COPPIA PORTE SCORREVOLI CON CILINDRO

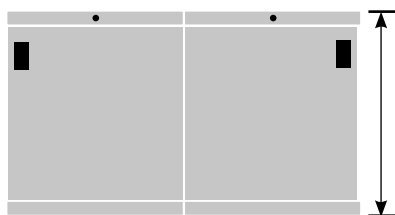

H INGOMBRO PORTA mm**	TIPO DI CHIUSURA	ART. con kit plastiche Dark Grey	ART. SENZA kit plastiche*
850 (utile 750 mm)	C0 KEY chiusura a cilindro	M 50 P075 C0 10 31 _ _	M 50 P075 C0 00 31 _ _
	C1 KEY chiusura a cilindro	M 50 P075 C1 10 31 _ _	M 50 P075 C1 00 31 _ _
	C2 KEY chiusura a cilindro	M 50 P075 C2 10 31 _ _	M 50 P075 C2 00 31 _ _
1000 (utile 900 mm)	C0 KEY chiusura a cilindro	M 50 P090 C0 10 31 _ _	M 50 P090 C0 00 31 _ _
	C1 KEY chiusura a cilindro	M 50 P090 C1 10 31 _ _	M 50 P090 C1 00 31 _ _
	C2 KEY chiusura a cilindro	M 50 P090 C2 10 31 _ _	M 50 P090 C2 00 31 _ _
1500 (utile 1400 mm)	C0 KEY chiusura a cilindro	M 50 P140 C0 10 31 _ _	M 50 P140 C0 00 31 _ _
	C1 KEY chiusura a cilindro	M 50 P140 C1 10 31 _ _	M 50 P140 C1 00 31 _ _
	C2 KEY chiusura a cilindro	M 50 P140 C2 10 31 _ _	M 50 P140 C2 00 31 _ _
2000 (utile 1900 mm)	C0 KEY chiusura a cilindro	M 50 P190 C0 10 31 _ _	M 50 P190 C0 00 31 _ _
	C1 KEY chiusura a cilindro	M 50 P190 C1 10 31 _ _	M 50 P190 C1 00 31 _ _
	C2 KEY chiusura a cilindro	M 50 P190 C2 10 31 _ _	M 50 P190 C2 00 31 _ _

**ALTEZZA COMPRESIVA DI PIANI DI TENUTA SUPERIORE ED INFERIORE

SYSTEM SR-MASTER

TAPPARELLE CON CILINDRO

36 EH
|←→|

H SCAFFALE mm	TIPO DI CHIUSURA	ART. *	
1500 (utile 1400 mm)	 C0	M 30 S150 C0 00 00 __	
	 C1	M 30 S150 C1 00 00 __	
	 C2	M 30 S150 C2 00 00 __	
2000 (utile 1900 mm)	 C0	M 30 S200 C0 00 00 __	
	 C1	M 30 S200 C1 00 00 __	
	 C2	M 30 S200 C2 00 00 __	

*Tapparelle e maniglia fornite esclusivamente in colore grigio

TAPPARELLE CON CILINDRO

54 EH
|←→|

H SCAFFALE mm	TIPO DI CHIUSURA	ART. *	
1500 (utile 1400 mm)	 C0	M 50 S150 C0 00 00 __	
	 C1	M 50 S150 C1 00 00 __	
	 C2	M 50 S150 C2 00 00 __	
2000 (utile 1900 mm)	 C0	M 50 S200 C0 00 00 __	
	 C1	M 50 S200 C1 00 00 __	
	 C2	M 50 S200 C2 00 00 __	

*Tapparelle e maniglia fornite esclusivamente in colore grigio



LE TAPPARELLE SONO COMPATIBILI ED UTILIZZABILI ANCHE NEGLI ARMADI SERIE MASTER

TAPPARELLE CON CILINDRO







64 EH
|←→|

H SCAFFALE mm	TIPO DI CHIUSURA	ART. *	
1500 (utile 1400 mm)	 C0	M 60 S150 C0 00 00 __	
	 C1	M 60 S150 C1 00 00 __	
	 C2	M 60 S150 C2 00 00 __	
2000 (utile 1900 mm)	 C0	M 60 S200 C0 00 00 __	
	 C1	M 60 S200 C1 00 00 __	
	 C2	M 60 S200 C2 00 00 __	

*Tapparelle e maniglia fornite esclusivamente in colore grigio

TAPPARELLE CON CILINDRO

78 EH
|←→|

H SCAFFALE mm	TIPO DI CHIUSURA	ART. *	
1500 (utile 1400 mm)	 C0	M 70 S150 C0 00 00 __	
	 C1	M 70 S150 C1 00 00 __	
	 C2	M 70 S150 C2 00 00 __	
2000 (utile 1900 mm)	 C0	M 70 S200 C0 00 00 __	
	 C1	M 70 S200 C1 00 00 __	
	 C2	M 70 S200 C2 00 00 __	

*Tapparelle e maniglia fornite esclusivamente in colore grigio



TAPPARELLA



PORTA A
BATTENTE



PORTA
SCORREVOLE

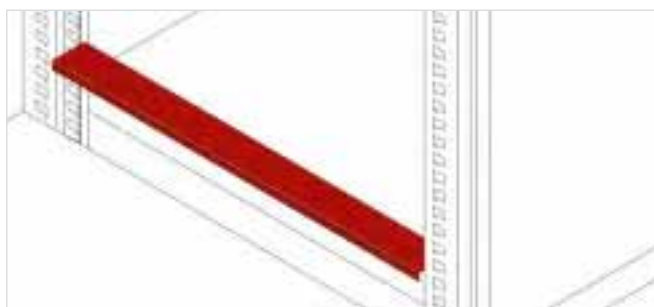

CHIUSURE TRA I PIANI 27 EH

ART.		H mm
M 02 CP00 00 00 00 _ _		51x471x20 H

CHIUSURE TRA I PIANI 36 EH

ART.		H mm
M 03 CP00 00 00 00 _ _		51x624x20 H

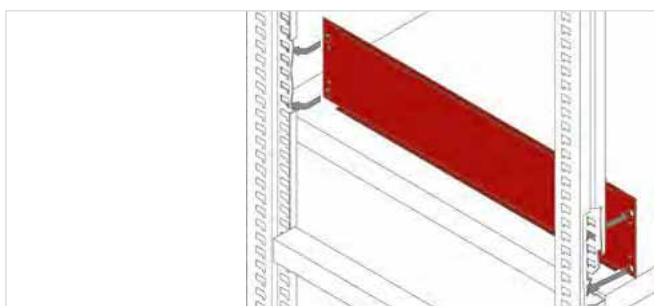

CHIUSURE LATERALI 27 EH

ART.		Dim. mm
M 02 CL15 00 00 00 _ _		567x150 H
M 02 CL20 00 00 00 _ _		567x200 H
M 02 CL25 00 00 00 _ _		567x250 H

PER SCAFFALE PROFONDITÀ 573 mm

CHIUSURE LATERALI 36 EH

ART.		Dim. mm
M 03 CL15 00 00 00 _ _		720x150 H
M 03 CL20 00 00 00 _ _		720x200 H
M 03 CL25 00 00 00 _ _		720x250 H

PER SCAFFALE PROFONDITÀ 726 mm

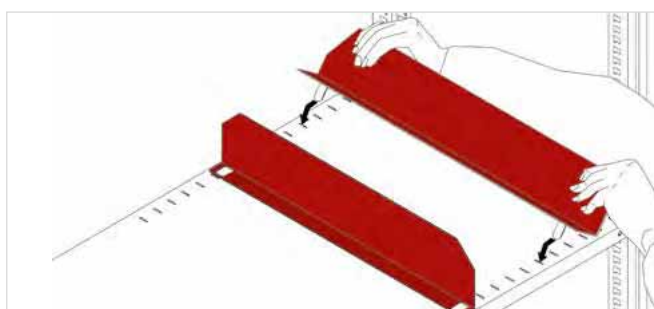

SEPARATORI 27 EH

ART.		H mm
M 02 SE10 00 00 00 _ _		100
M 02 SE15 00 00 00 _ _		150
M 02 SE20 00 00 00 _ _		200

PER SCAFFALE PROFONDITÀ 573 mm

SEPARATORI 36 EH

ART.		H mm
M 03 SE10 00 00 00 _ _		100
M 03 SE15 00 00 00 _ _		150
M 03 SE20 00 00 00 _ _		200

PER SCAFFALE PROFONDITÀ 726 mm



PORTA DISEGNI

ART.	Dim. mm
C MV 15 005	332x210 H DIN A4
C MV 15 006	218x148 H DIN A5

COLORE NERO RAL 9005



SUPPORTO CALAMITATO

ART.	Lunghezza mm
F ST 9997 00 00	1000

CON ETICHETTA E CELLOPHAN

ETICHETTA E CELLOPHAN DI RICAMBIO

ART.	Nr. pezzi
R FST 0007 00	100



PIANO DI COPERTURA IN MULTIPLEX
DISPONIBILE SU RICHIESTA



RICAMBI - FISSAGGIO

SERRATURA DI RICAMBIO

ART. M 00 CSRO 8800 00 00

Serratura di ricambio con due chiavi



CHIAVE DI RICAMBIO

ART. M 00 CF00 0000 00 00

Specificare sempre il numero indicato nella serratura a cilindro dove si vuole sostituire la chiave



PASSEPARTOUT

ART. M 00 PF.. 0000 00 00

Disponibile in 23 serie, con numerazione da F 01 a F 23.

Passepartout serie F 01

ART. M 00 PF01 00 00 00 00

Passepartout serie F 02

ART. M 00 PF02 00 00 00 00

Passepartout serie F ..

ART. M 00 PF.. 00 00 00 00

SET DI FISSAGGIO PER UNA FIANCATA

ART. F SR 8999 00 99

Materiale per fissaggio composto da 2 viti ad espansione in acciaio M10x90 mm per pavimenti in calcestruzzo non fessurato maggiore o uguale alla classe: C20/25. Trazione consigliata del tassello: 5,3 kN. Diametro tassello: 10 mm



MANIGLIA DI RICAMBIO

ART. M 00 PLS0 0000 22 M0

Maniglia di ricambio per porte disponibile in colore Dark Grey.



ALTRI COLORI A RICHIESTA



OBBLIGO DI FISSAGGIO A PARETE O A PAVIMENTO

MATERIALE DI SEPARAZIONE



36x27 EH



54x27 EH



36x36 EH



45x36 EH



54x36 EH



64x36 EH



78x36 EH





SYSTEM SR-MASTER V3

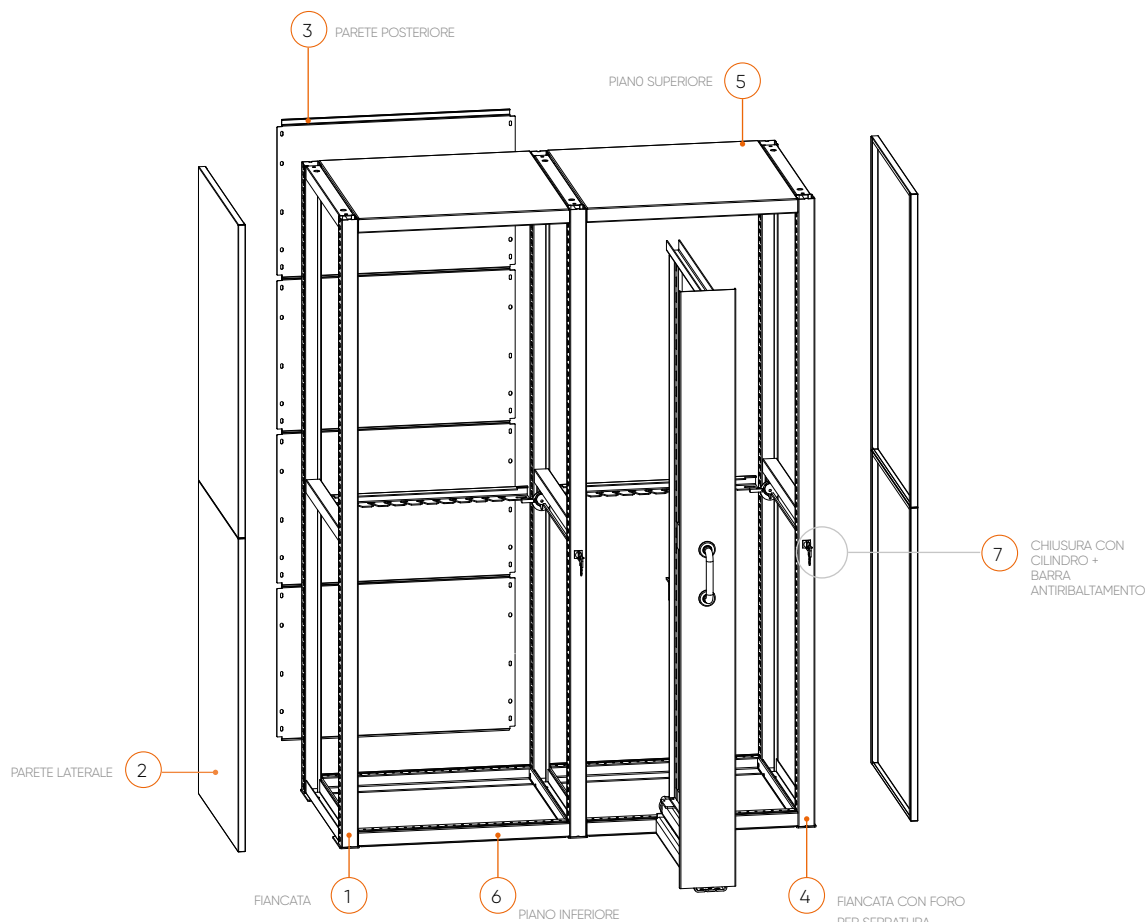

Gamma colori



GRIGIO
RAL 7000
.01



VERDE
RAL 6011
.02



BLU
RAL 5012
.04



GRIGIO
RAL 7035
.08



BIANCO GRIGIASTRO
RAL 9002
.1F



ROSSO RUBINO
RAL 3003
.1G



BLU GENZIANA
RAL 5010
.34



BIANCO PURO
RAL 9010
.35



GRIGIO ANTRACITE
RAL 7016
.39



BLU CAPRI
RAL 5019
.48

FIANCATE

1	ART.	Dim. mm
	M 03 F200 00 00 01 __	51x726x2000 H
	M 03 F250 00 00 01 __	51x726x2500 H

COMPLETE DI TAPPI DI CHIUSURA

FIANCATE CON FORO PER SERRATURA

4	ART.	Dim. mm
	M 03 F200 10 00 01 __	51x726x2000 H
	M 03 F250 10 00 01 __	51x726x2500 H

COMPLETE DI TAPPI DI CHIUSURA

PARETI LATERALI

2	ART.	Dim. mm
	M 03 W100 LO 00 00 __	23x725x1000 H
	M 03 W125 LO 00 00 __	23x725x1250 H
	M 03 W150 LO 00 00 __	23x725x1500 H

PIANO SUPERIORE

5	ART.	Dim. mm
	M 33 PV46 00 00 00 __	663x726x46 H

PARETI POSTERIORI

3	ART.	Dim. mm
	M 30 W200 PO 00 00 __	2000 H
	M 30 W250 PO 00 00 __	2500 H

PIANO INFERIORE

6	ART.	Dim. mm
	M 33 PV46 10 00 00 __	663x726x46 H

CHIUSURA CON CILINDRO (KEY) + BARRA ANTIRIBALTAMENTO

7	ART.	tipo di chiusura
	M 33 VV00 C0 00 00 00	NUMERAZIONE DIVERSA
	M 33 VV00 C1 00 00 00	PER GRUPPI DI 160 NUMERI
	M 33 VV00 C2 00 00 00	CON NUMERAZIONE UGUALE

COMPLETA DI: 1 serratura a cilindro con 2 chiavi, barra antiribaltamento e accessori in acciaio



SERRATURA A CHIAVE
Fornita di serie la chiusura a cilindro "C0".
A richiesta la versione "C1" o "C2".

CASSETTI VERTICALI MONOFRONTI

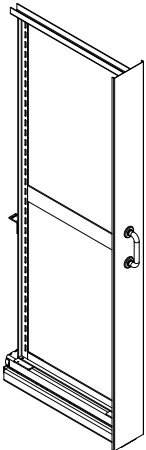

ART.	ART.	Larghezza frontale	Larghezza utile	kg
1715 mm H	2215 mm H	mm	mm	
F SR 3110 00 __	F SR 3310 00 __	100	68	400
F SR 3115 00 __	F SR 3315 00 __	125	93	400
F SR 3120 00 __	F SR 3320 00 __	150	118	400
F SR 3125 00 __	F SR 3325 00 __	175	143	400
F SR 3130 00 __	F SR 3330 00 __	200	168	400
F SR 3135 00 __	F SR 3335 00 __	225	193	400
F SR 3140 00 __	F SR 3340 00 __	250	212	400
Altezza utile mm	1715	2215		
Profondità utile mm	620	620		
Altezza frontale mm	1900	2400		
Per altezza scaffale mm	2000	2500		

CASSETTI VERTICALI BIFRONTI

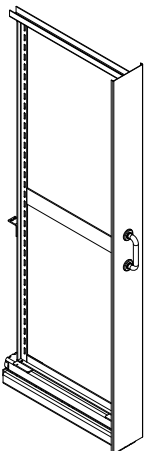

ART.	ART.	Larghezza frontale	Larghezza utile	kg
1715 mm H	2215 mm H	mm	mm	
F SR 3610 00 __	F SR 3810 00 __	150	68+68	400
F SR 3615 00 __	F SR 3815 00 __	175	68+93	400
F SR 3620 00 __	F SR 3820 00 __	200	93+93	400
F SR 3625 00 __	F SR 3825 00 __	200	68+118	400
F SR 3630 00 __	F SR 3830 00 __	225	93+118	400
F SR 3635 00 __	F SR 3835 00 __	225	68+143	400
F SR 3640 00 __	F SR 3840 00 __	250	118+118	400
F SR 3645 00 __	F SR 3845 00 __	250	93+143	400
F SR 3650 00 __	F SR 3850 00 __	250	68+168	400
Altezza utile mm	1715	2215		
Profondità utile mm	620	620		
Altezza frontale mm	1900	2400		
Per altezza scaffale mm	2000	2500		

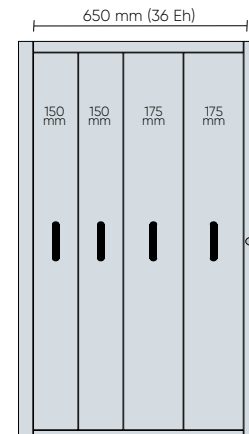
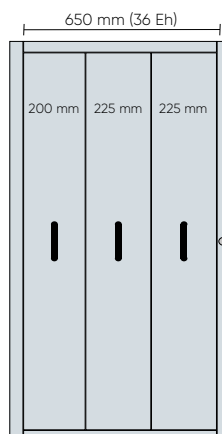
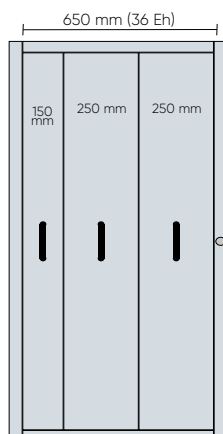

! LE PORTATE SONO NETTE E SI RIFERISCONO A PESI UNIFORMEMENTE DISTRIBUITI

SYSTEM SR-MASTER V4

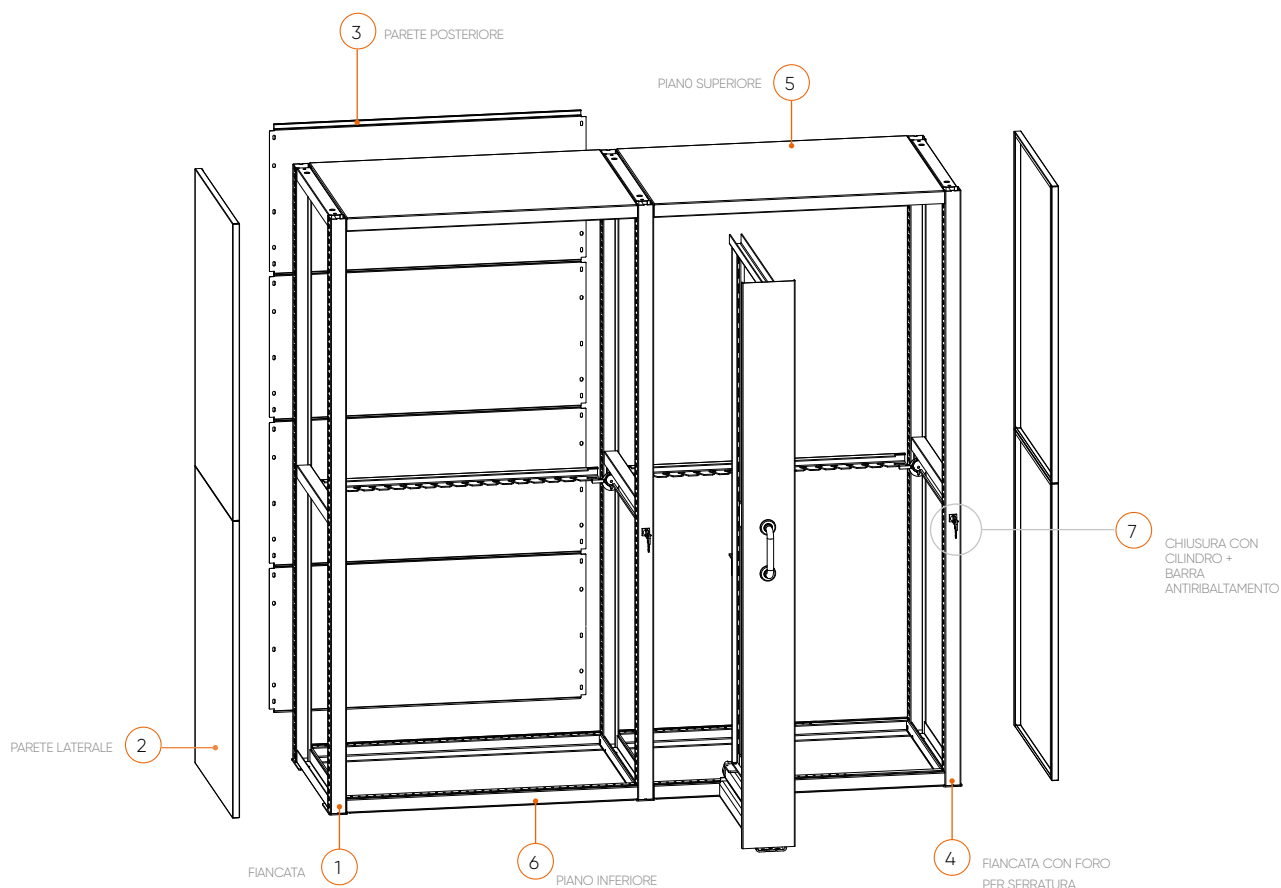

Gamma colori



FIANCATE

1	ART.	Dim. mm
	M 03 F200 00 00 01 __	51x726x2000 H
	M 03 F250 00 00 01 __	51x726x2500 H

COMPLETE DI TAPPI DI CHIUSURA

FIANCATE CON FORO PER SERRATURA

4	ART.	Dim. mm
	M 03 F200 10 00 01 __	51x726x2000 H
	M 03 F250 10 00 01 __	51x726x2500 H

COMPLETE DI TAPPI DI CHIUSURA

PARETI LATERALI

2	ART.	Dim. mm
	M 03 W100 LO 00 00 __	23x725x1000 H
	M 03 W125 LO 00 00 __	23x725x1250 H
	M 03 W150 LO 00 00 __	23x725x1500 H

PIANO SUPERIORE

5	ART.	Dim. mm
	M 53 PV46 00 00 00 __	969x726x46 H

PARETI POSTERIORI

3	ART.	Dim. mm
	M 50 W200 PO 00 00 __	1019x2000 H
	M 50 W250 PO 00 00 __	1019x2500 H

PIANO INFERIORE

6	ART.	Dim. mm
	M 53 PV46 10 00 00 __	969x726x46 H

CHIUSURA CON CILINDRO (KEY) + BARRA ANTIRIBALTAMENTO

7	ART.	tipo di chiusura
	M 53 VV00 C0 00 00 00	NUMERAZIONE DIVERSA
	M 53 VV00 C1 00 00 00	PER GRUPPI DI 160 NUMERI
	M 53 VV00 C2 00 00 00	CON NUMERAZIONE UGUALE

COMPLETA DI: 1 serratura a cilindro con 2 chiavi, 1 filo in acciaio con guaina, 1 gruppo percussore anteriore, 1 gruppo cursore posteriore



SERRATURA A CHIAVE
Fornita di serie la chiusura a cilindro "C0".
A richiesta la versione "C1" o "C2".

CASSETTI VERTICALI MONOFRONTI

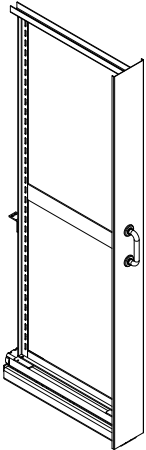

ART.	ART.	Larghezza frontale mm	Larghezza utile mm	kg
1715 mm H	2215 mm H			
F SR 3110 00 __	F SR 3310 00 __	100	68	400
F SR 3115 00 __	F SR 3315 00 __	125	93	400
F SR 3120 00 __	F SR 3320 00 __	150	118	400
F SR 3125 00 __	F SR 3325 00 __	175	143	400
F SR 3130 00 __	F SR 3330 00 __	200	168	400
F SR 3135 00 __	F SR 3335 00 __	225	193	400
F SR 3140 00 __	F SR 3340 00 __	250	212	400
Altezza utile mm	1715	2215		
Profondità utile mm	620	620		
Altezza frontale mm	1900	2400		
Per altezza scaffale mm	2000	2500		

CASSETTI VERTICALI BIFRONTI

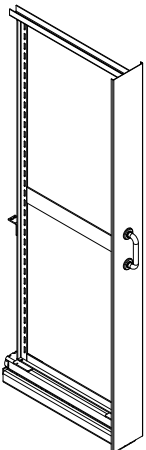

ART.	ART.	Larghezza frontale mm	Larghezza utile mm	kg
1715 mm H	2215 mm H			
F SR 3610 00 __	F SR 3810 00 __	150	68+68	400
F SR 3615 00 __	F SR 3815 00 __	175	68+93	400
F SR 3620 00 __	F SR 3820 00 __	200	93+93	400
F SR 3625 00 __	F SR 3825 00 __	200	68+118	400
F SR 3630 00 __	F SR 3830 00 __	225	93+118	400
F SR 3635 00 __	F SR 3835 00 __	225	68+143	400
F SR 3640 00 __	F SR 3840 00 __	250	118+118	400
F SR 3645 00 __	F SR 3845 00 __	250	93+143	400
F SR 3650 00 __	F SR 3850 00 __	250	68+168	400
Altezza utile mm	1715	2215		
Profondità utile mm	620	620		
Altezza frontale mm	1900	2400		
Per altezza scaffale mm	2000	2500		

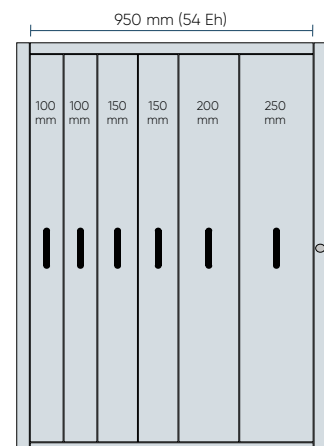
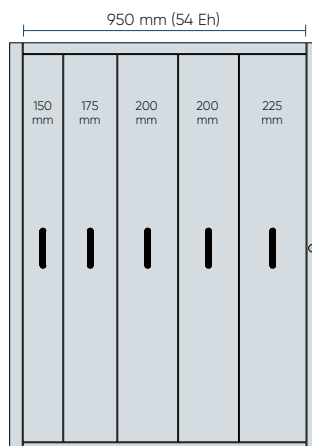
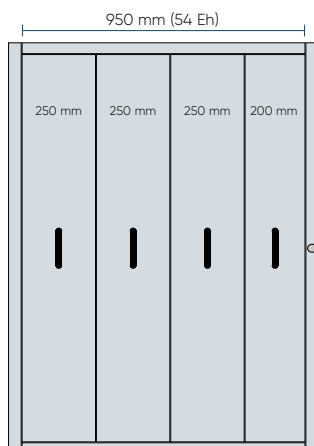

ACCESSORI

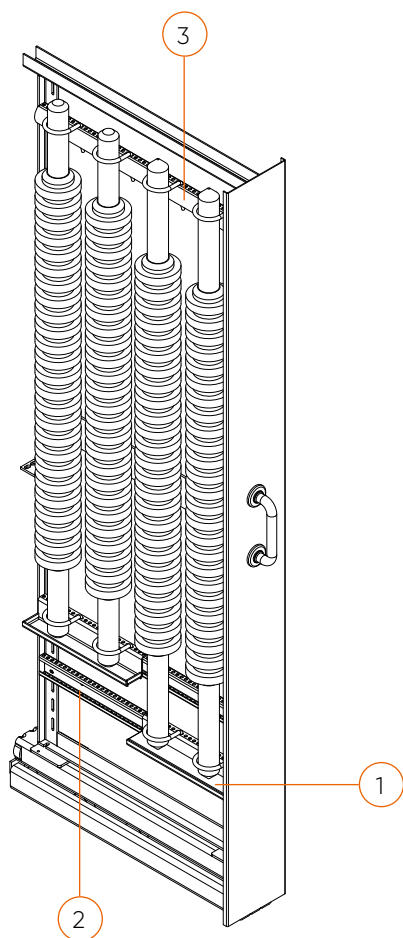

CASSETTO BIFRONTE

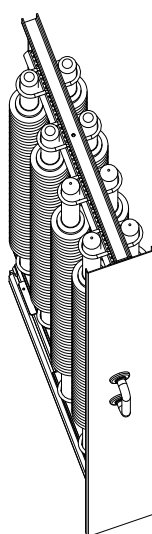

CASSETTO MONOFRONTE

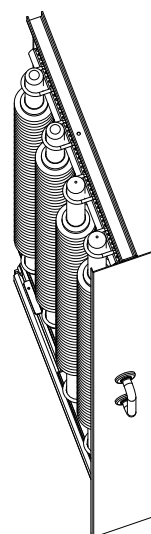

PIANI DI APOGGIO CON LEGNO

1	ART.	Dim. mm	kg
	F SR 4260 01 01	310x50	150
	F SR 4265 01 01	310x75	150
	F SR 4270 01 01	310x100	150
	F SR 4275 01 01	310x125	150
	F SR 4280 01 01	310x150	150



TRAVERSO FORATO

2	ART.	Dim. mm
	F CN 3010 00 01	623x28x50 H

PROFILO IN NEOPRENE - Colore nero

3	ART.	Dim. mm
	F CN 3030 00 07	620x17x45 H

CASSETTO BIFRONTE

CASSETTO MONOFRONTE

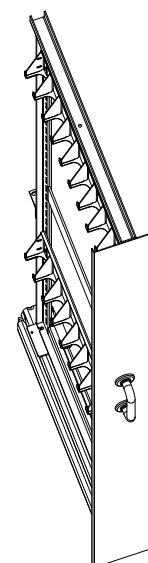
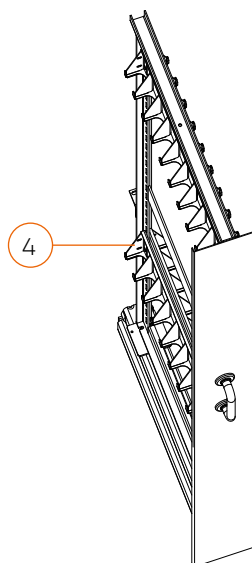

PORTA UTENSILI

4

ART.	per utensili	flangia Ø max. mm	cono Ø max. mm	nr. posti	larghezza mm	profondità mm	per larghezza utile cassetto verticale mm
F CN 3210 00 01	ISO 40	63	50	9	597	56	68
F CN 3220 00 01	ISO 45	82	63	7	597	75	93
F CN 3230 00 01	ISO 50	98	80	5	597	84	118
F CN 3240 00 01	ISO 50	112	80	5	597	100	118
F CN 3250 00 01	ISO 50	98	80	6	623	84	118
F CN 3260 00 01	ISO 55	130	89	4	597	120	143
F CN 3270 00 01	ISO 60	160	109	3	597	140	168

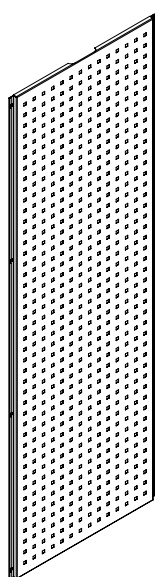

PANNELLO FORATO

ART.	Dim. mm
F SR 4210 00 01	620x500 H
F SR 4215 00 01	620x1715 H
F SR 4225 00 01	620x2215 H

ACCESSORI

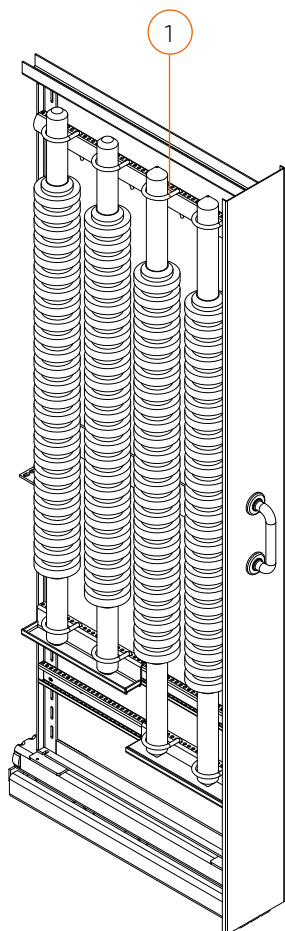

ANELLI DI SICUREZZA

ART.	per utensili Ø max. mm	nr. max. anelli per traverso forato	nr. fori per anello
F CN 3105 00 99	15	16	3
F CN 3110 00 99	27	12	4
F CN 3115 00 99	35	9	5
F CN 3120 00 99	48	8	6
F CN 3125 00 99	60	6	7
F CN 3130 00 99	73	6	8
F CN 3135 00 99	85	5	9
F CN 3140 00 99	98	4	10
F CN 3145 00 99	110	4	11
F CN 3150 00 99	123	4	12
F CN 3155 00 99	135	3	13

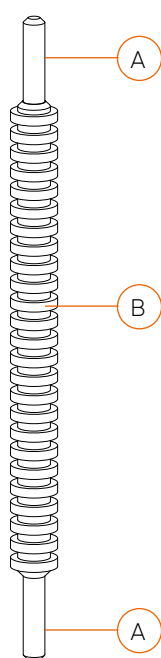

SCHEMA TECNICO DEGLI ANELLI DI SICUREZZA NEI CASSETTI VERTICALI

MONOFRONTE

ART.	larghezza frontale cassetto	utensile Ø mm (A)	utensile Ø mm (B)
F CN 3115 00 99	100	35	55
F CN 3110 00 99	100	27	68
F CN 3125 00 99	125	60	80
F CN 3120 00 99	125	48	93
F CN 3135 00 99	150	85	105
F CN 3130 00 99	150	73	118
F CN 3145 00 99	175	110	130
F CN 3140 00 99	175	98	143
F CN 3155 00 99	200	135	155

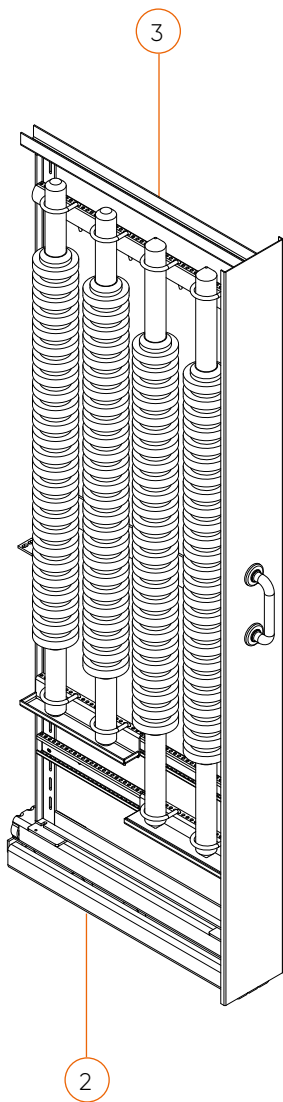

BIFRONT LATO SX

ART.	larghezza frontale cassetto	utensile Ø mm (A)	utensile Ø mm (B)
F CN 3115 00 99	150	35	55
F CN 3115 00 99	150	35	55
F CN 3110 00 99	150	27	68
F CN 3115 00 99	175	35	55
F CN 3115 00 99	175	35	55
F CN 3110 00 99	175	27	68
F CN 3110 00 99	175	27	68
F CN 3125 00 99	200	60	80
F CN 3125 00 99	200	60	80
F CN 3120 00 99	200	48	93
F CN 3125 00 99	225	60	80
F CN 3125 00 99	225	60	80
F CN 3120 00 99	225	48	93
F CN 3120 00 99	225	48	93
F CN 3120 00 99	225	48	93
F CN 3135 00 99	250	85	105
F CN 3135 00 99	250	85	105
F CN 3130 00 99	250	73	118

BIFRONT LATO DX

ART.	larghezza frontale cassetto	utensile Ø mm (A)	utensile Ø mm (B)
F CN 3115 00 99	150	35	55
F CN 3110 00 99	150	27	68
F CN 3110 00 99	150	27	68
F CN 3125 00 99	175	60	80
F CN 3120 00 99	175	48	93
F CN 3125 00 99	175	60	80
F CN 3120 00 99	175	48	93
F CN 3125 00 99	200	60	80
F CN 3120 00 99	200	48	93
F CN 3120 00 99	200	48	93
F CN 3120 00 99	200	48	93
F CN 3135 00 99	225	85	105
F CN 3130 00 99	225	73	118
F CN 3135 00 99	225	85	105
F CN 3130 00 99	225	73	118
F CN 3135 00 99	250	85	105
F CN 3130 00 99	250	73	118
F CN 3130 00 99	250	73	118

**SCAFFALATURA A
PIANI ESTRAIBILI
PER MERCI PESANTI
IDEALI PER IL
PRELIEVO TRAMITE
CARROPONTE**





Per gentile concessione di Vimar S.p.A.

SYSTEM AR

CARATTERISTICHE TECNICHE

La scaffalatura F AR, grazie ai suoi piani estraibili, è particolarmente adatta all'immagazzinamento di materiale molto pesante (stampi, motori, ecc.) movimentabile, in totale sicurezza, con l'utilizzo di carro ponte e carrello elevatore. I piani possono essere ad estrazione semplice o telescopica, con portata variabile da 800 a 1000 kg.

Per gentile concessione di Meccanostampi S.r.l



FIANCATE DELLA SCAFFALATURA

In profilato d'acciaio, presentano su ambo i lati una fessurazione con passo da 50 mm.

I due montanti sono collegati fra loro da due traversi orizzontali ed una crociera, formando così una robusta fiancata.

Le fiancate sono provviste di piastre in acciaio per il fissaggio a pavimento.

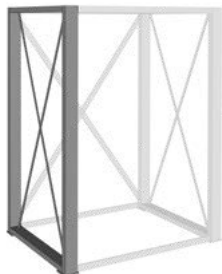

PORTE SCORREVOLI

Sono realizzate in lamiera d'acciaio debitamente sagomata per garantire la solidità.

Le porte servono per proteggere la merce da urti e polvere. Ogni coppia porte scorrevoli copre due campate dello scaffale e dispone di una serratura a cilindro con due chiavi.



PARETI LATERALI E POSTERIORI

Le pareti laterali e posteriori vengono fissate con viti alla struttura e, utilizzate insieme, possono formare dei vani chiusi. Inoltre, le pareti posteriori escludono il montaggio delle crociere.

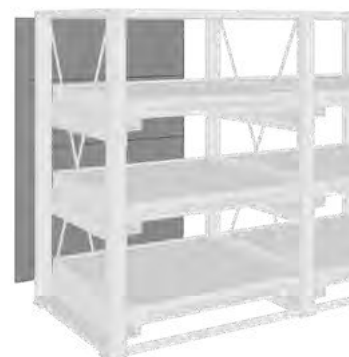
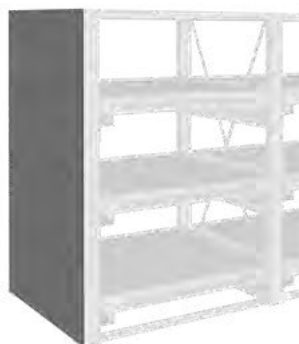

SYSTEM F AR



DISPOSITIVO DI APERTURA SINGOLA DEI PIANI ESTRAIBILI

Per la sicurezza è obbligatoria l'apertura singola dei piani estraibili. Il dispositivo consiste in un'asta da montare sulla fiancata (una per ogni campata) con un gancio da applicare ad ogni piano estraibile.

Aperto un solo piano estraibile alla volta, si evitano pericolosi spostamenti di carichi a sbalzo con possibile ribaltamento della struttura.



GANCIO DI BLOCCAGGIO PIANO ESTRAIBILE

Un gancio posto nella parte anteriore della fiancata permette di bloccare il piano in apertura ed in chiusura. Nella fase di apertura, il bloccaggio del piano permette il prelievo del materiale in totale sicurezza.



Gancio di bloccaggio piani semplici



Gancio di bloccaggio piani telescopici

SICUREZZA

PIASTRA DI APPOGGIO A PAVIMENTO

La piastra di appoggio ha la funzione di distribuire la pressione esercitata sul pavimento dalla fiancata. Una scheda tecnica fornita dalla FAMI, permette di verificare l'idoneità del pavimento destinato al montaggio della scaffalatura.

La piastra di appoggio è dotata di foro che consente l'ancoraggio al pavimento tramite tasselli di fissaggio forniti di serie. Questa operazione si rende necessaria per garantire la sicurezza dello scaffale.

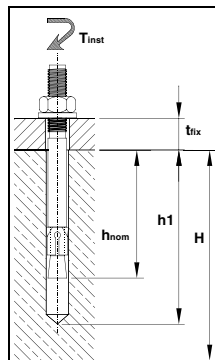

- * È obbligatorio verificare che il pavimento su cui appoggia la scaffalatura sia idoneo a sopportare la pressione e il valore di punzonamento (foratura) esercitata dalla scaffalatura stessa e la trazione esercitata dal tassello.
- ** La zona deve rimanere libera dall'azione di qualsiasi altra forza.

trazione consigliata del tassello	11,65 Kn
di diametro tassello	Ø16 mm
di diametro foro del calcestruzzo	Ø16 mm
profondità minima del foro	h ₁ 115 mm
profondità minima di posa	h _{nom} 95 mm
spessore max fissabile	t _{fix} 25 mm
coppia di serraggio max	T _{inst} 125 Nm
spessore min. del pavimento relativo al fissaggio del tassello *	H: 160 mm
distanza min. del tassello dal bordo del pavimento	B: 175 mm
zona di influenza del tassello **	A: 112,5 mm
Distanza min. del montante dal bordo del pavimento	C: 75 mm

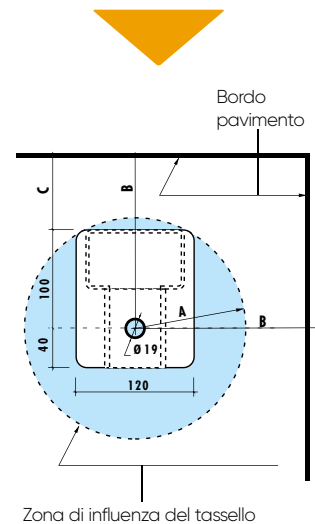

COMBINAZIONE DEI COLORI DI SERIE



grigio RAL 7000



verde RAL 6011



blu RAL 5012



5000	Portata di ogni campata
1000	Portata piano estraibile ad estrazione telescopica
800	Portata piano estraibile ad estrazione semplice
300	Portata piano di tenuta per profondità 900 mm
250	Portata piano di tenuta per profondità 1100 mm
200	Portata piano di tenuta per profondità 1300 mm

SYSTEM F AR

PIANI AD ESTRAZIONE SEMPLICE

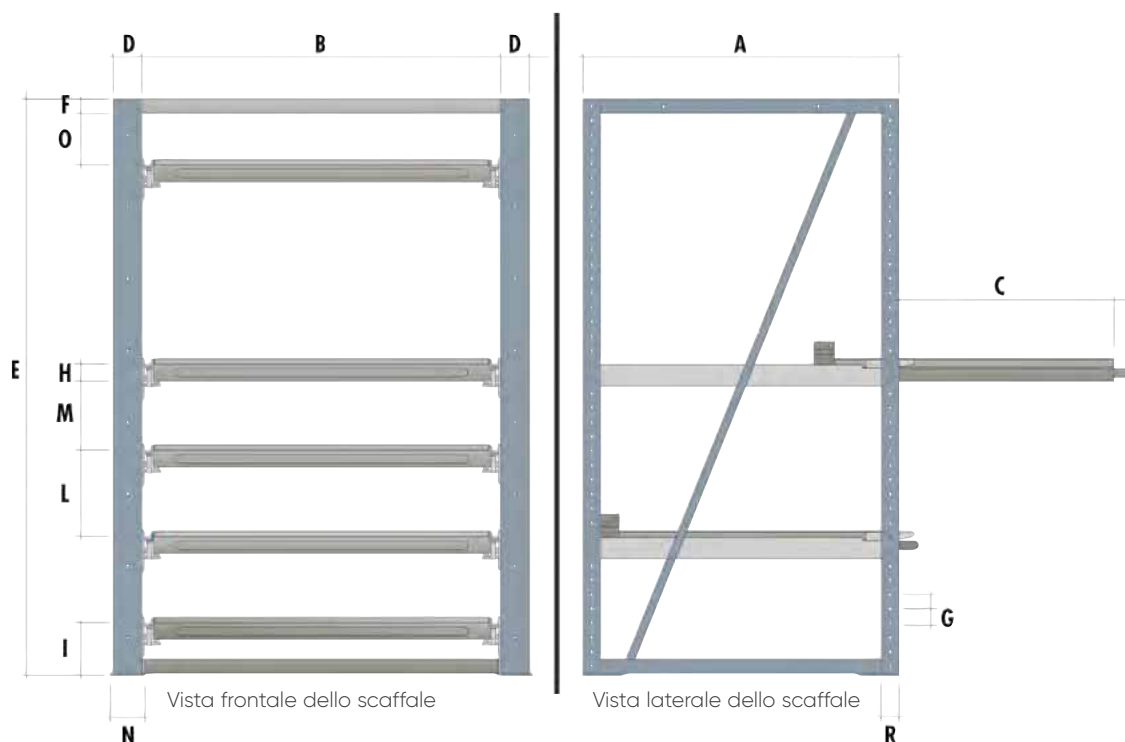

		mm
A	PROFONDITÀ DELLO SCAFFALE	900, 1100, 1300
B	UTILE CAMPATA	1250
C	ESTRAIBILITÀ	600, 750, 900
D	LARGHEZZA FIANCATE	100
E	ALTEZZA SCAFFALE	1510, 2010, 2210, 2510, 3010
F	PIANO SUPERIORE	50
G	PASSO REGOLABILE	50
H	PIANI ESTRAIBILI	58
I	ALTEZZA MINIMA DA PAVIMENTO	185
L	DISTANZA MINIMA TRA PIANI	300
M	LUCE MINIMA TRA PIANI	225
N	PIASTRA PER FIANCATA	120
O	DISTANZA MIN. DAL PIANO SUPERIORE	175
R	INGOMBRO	60
	SPESSORE LAMIERA MONTANTE	3

Per gentile concessione di Vimar S.p.A.



PIANI AD ESTRAZIONE TELESCOPICA

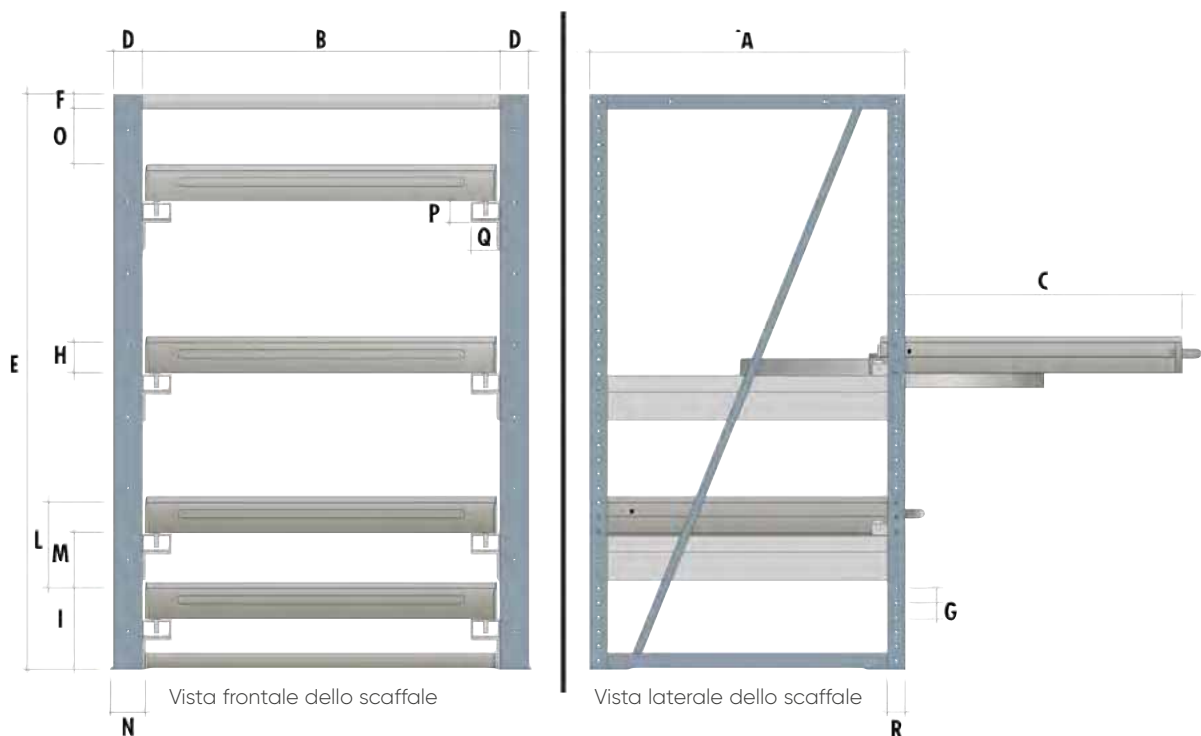

		mm
A	PROFONDITÀ DELLO SCAFFALE	900, 1100, 1300
B	UTILE CAMPATA	850, 1050, 1250
C	ESTRAIBILITÀ	770, 970, 1170
D	LARGHEZZA FIANCATE	100
E	ALTEZZA SCAFFALE	1510, 2010, 2210, 2510, 3010
F	PIANO SUPERIORE	50
G	PASSO REGOLABILE	50
H	PIANI ESTRAIBILI	107
I	ALTEZZA MINIMA DA PAVIMENTO	285
L	DISTANZA MINIMA TRA PIANI	300
M	LUCE MINIMA TRA PIANI	190
N	PIASTRA PER FIANCATA	120
O	DISTANZA MIN. DAL PIANO SUPERIORE	50
P	ALTEZZA SLITTA	80
Q	LARGHEZZA SLITTA	100
R	INGOMBRO	60
	SPESSORE LAMIERA MONTANTE	3

Per gentile concessione di Vimar S.p.A.



SYSTEM F AR





SYSTEM F AR

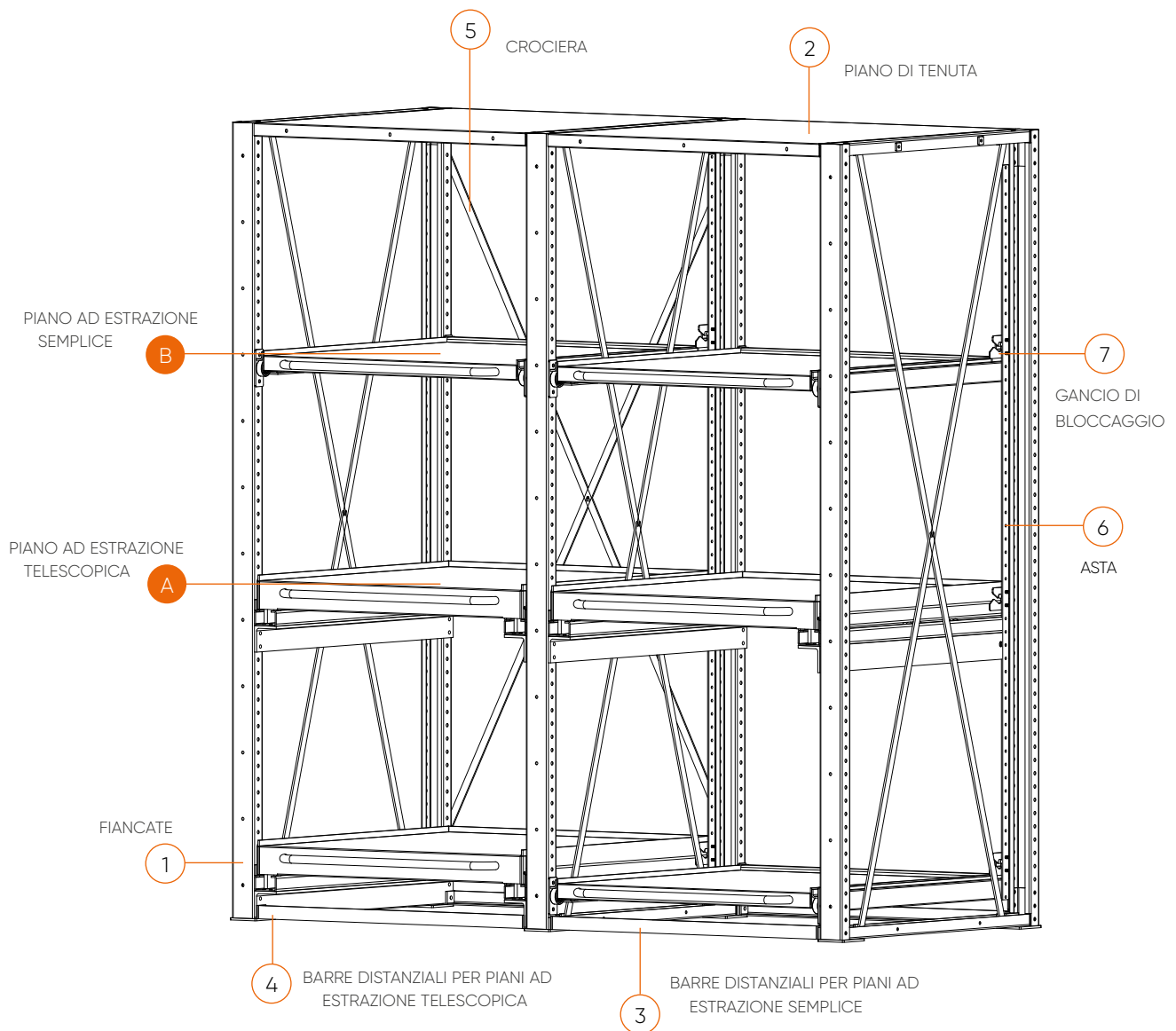

Gamma colori
ACCIAIO



RAL 5012
.04



RAL 7000
.01



RAL 6011
.02



LE PORTATE SONO NETTE E SI RIFERISCONO A PESI UNIFORMEMENTE DISTRIBUITI.

FIANCATE



1	ART.		H fiancate mm	Profondità mm
	F AR 2050 00	__	1510	
	F AR 2060 00	__	2010	
	F AR 2070 00	__	2210	900
	F AR 2080 00	__	2510	
	F AR 2090 00	__	3010	
	F AR 2100 00	__	1510	
	F AR 2110 00	__	2010	
	F AR 2120 00	__	2210	1100
	F AR 2130 00	__	2510	
	F AR 2140 00	__	3010	
	F AR 2150 00	__	1510	
	F AR 2160 00	__	2010	
	F AR 2170 00	__	2210	1300
	F AR 2180 00	__	2510	
	F AR 2190 00	__	3010	

Fiancate fornite smontate

Materiale di fissaggio composto da 2 viti ad espansione in acciaio M16x140 fornito di serie.



PIANI DI TENUTA

2	ART.			dim. mm
	F AR 4020 00	__	300	850×900×50 H
	F AR 4030 00	__	250	850×1100×50 H
	F AR 4040 00	__	200	850×1300×50 H
	F AR 4120 00	__	300	1050×900×50 H
	F AR 4130 00	__	250	1050×1100×50 H
	F AR 4140 00	__	200	1050×1300×50 H
	F AR 4220 00	__	300	1250×900×50 H
	F AR 4230 00	__	250	1250×1100×50 H
	F AR 4240 00	__	200	1250×1300×50 H

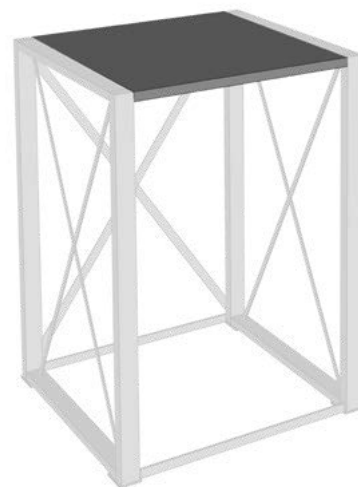

BARRE DISTANZIALI PER PIANI AD ESTRAZIONE SEMPLICE

3	ART.		Utile campata mm
	F AR 1040 00	__	1250

Servono 2 barre per ogni campata



BARRE DISTANZIALI PER PIANI AD ESTRAZIONE TELESCOPICA

4	ART.		Utile campata mm
	F AR 1010 00	__	850
	F AR 1020 00	__	1050
	F AR 1030 00	__	1250

Servono 2 barre per ogni campata



SYSTEM F AR

CROCIERE

5	ART.	H fiancate mm	Utile campata mm
	F AR 1850 00 _ _	1510	
	F AR 1860 00 _ _	2010	
	F AR 1870 00 _ _	2210	850
	F AR 1880 00 _ _	2510	
	F AR 1890 00 _ _	3010	
	F AR 1900 00 _ _	1510	
	F AR 1910 00 _ _	2010	
	F AR 1920 00 _ _	2210	1050
	F AR 1930 00 _ _	2510	
	F AR 1940 00 _ _	3010	
	F AR 1950 00 _ _	1510	
	F AR 1960 00 _ _	2010	
	F AR 1970 00 _ _	2210	1250
	F AR 1980 00 _ _	2510	
	F AR 1990 00 _ _	3010	



È obbligatorio almeno ogni 2 campate utilizzare una campata con crociera



ASTA

6	ART.	H fiancate mm
	F AR 1100 00 _ _	1510
	F AR 1110 00 _ _	2010
	F AR 1120 00 _ _	2210
	F AR 1130 00 _ _	2510
	F AR 1140 00 _ _	3010



GANCIO DI BLOCCAGGIO

7	ART.

Il gancio è fornito di serie con il piano estraibile



Apertura singola

Alla scaffalatura serie "AR" deve essere applicato il dispositivo di apertura singola dei piani estraibili. Questo dispositivo permette di estrarre un solo piano estraibile per volta ed è composto da un'asta di altezza uguale alla fiancata e di ganci di bloccaggio, che vanno fissati a vite sull'asta in corrispondenza dei piani estraibili. È necessaria un'asta per ogni campata ed un gancio per ogni piano estraibile (il gancio è fornito di serie con il piano estraibile).

Gamma colori
ACCIAIO



RAL 7000
.01



RAL 6011
.02



RAL 5012
.04

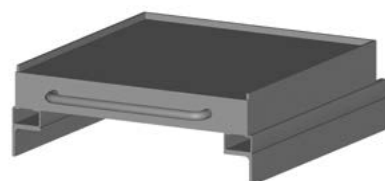

A PIANI AD ESTRAZIONE TELESCOPICA CON 3 BORDI

LARGHEZZA CAMPATA 850 mm

ART.		Utile campata mm	Profondità scaffale mm	Larghezza utile del piano mm	Profondità utile del piano mm	Estraibilità mm
F AR 7400 00 __		850	900	805	845	770
F AR 7410 00 __		850	1100	805	1045	970
F AR 7420 00 __		850	1300	805	1245	1170

LARGHEZZA CAMPATA 1050 mm

ART.		Utile campata mm	Profondità scaffale mm	Larghezza utile del piano mm	Profondità utile del piano mm	Estraibilità mm
F AR 7500 00 __		1050	900	1005	845	770
F AR 7510 00 __		1050	1100	1005	1045	970
F AR 7520 00 __		1050	1300	1005	1245	1170

LARGHEZZA CAMPATA 1250 mm

ART.		Utile campata mm	Profondità scaffale mm	Larghezza utile del piano mm	Profondità utile del piano mm	Estraibilità mm
F AR 7600 00 __		1250	900	1205	845	770
F AR 7610 00 __		1250	1100	1205	1045	970
F AR 7620 00 __		1250	1300	1205	1245	1170



PORTATA 1000 kg

le portate sono nette e si riferiscono a pesi uniformemente distribuiti



I piani estraibili vengono forniti con etichetta di portata.



LARGHEZZA CAMPATA

SYSTEM F AR

Gamma colori
ACCIAIO



RAL 7000
.01



RAL 6011
.02



RAL 5012
.04

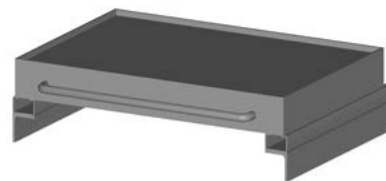

A

PIANI AD ESTRAZIONE TELESCOPICA CON 4 BORDI

LARGHEZZA CAMPATA 850 mm

ART.		Utile campata mm	Profondità scaffale mm	Larghezza utile del piano mm	Profondità utile del piano mm	Estraibilità mm
F AR 7450 00 _ _		850	900	805	845	770
F AR 7460 00 _ _		850	1100	805	1045	970
F AR 7470 00 _ _		850	1300	805	1245	1170

LARGHEZZA CAMPATA 1050 mm

ART.		Utile campata mm	Profondità scaffale mm	Larghezza utile del piano mm	Profondità utile del piano mm	Estraibilità mm
F AR 7550 00 _ _		1050	900	1005	845	770
F AR 7560 00 _ _		1050	1100	1005	1045	970
F AR 7570 00 _ _		1050	1300	1005	1245	1170

LARGHEZZA CAMPATA 1250 mm

ART.		Utile campata mm	Profondità scaffale mm	Larghezza utile del piano mm	Profondità utile del piano mm	Estraibilità mm
F AR 7650 00 _ _		1250	900	1205	845	770
F AR 7660 00 _ _		1250	1100	1205	1045	970
F AR 7670 00 _ _		1250	1300	1205	1245	1170

LARGHEZZA CAMPATA



PORTATA 1000 kg

le portate sono nette e si riferiscono a pesi uniformemente distribuiti



I piani estraibili vengono forniti con etichetta di portata.

Gamma colori
ACCIAIO

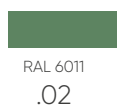
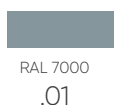

A

PIANI AD ESTRAZIONE TELESCOPICA CON 4 BORDI E COPERTURA IN MULTIPLEX

LARGHEZZA CAMPATA 850 mm

ART.		Utile campata mm	Profondità scaffale mm	Larghezza utile del piano mm	Profondità utile del piano mm	Estraibilità mm
F AR 7450 01	__	850	900	805	845	770
F AR 7460 01	__	850	1100	805	1045	970
F AR 7470 01	__	850	1300	805	1245	1170

LARGHEZZA CAMPATA 1050 mm

ART.		Utile campata mm	Profondità scaffale mm	Larghezza utile del piano mm	Profondità utile del piano mm	Estraibilità mm
F AR 7550 01	__	1050	900	1005	845	770
F AR 7560 01	__	1050	1100	1005	1045	970
F AR 7570 01	__	1050	1300	1005	1245	1170

LARGHEZZA CAMPATA 1250 mm

ART.		Utile campata mm	Profondità scaffale mm	Larghezza utile del piano mm	Profondità utile del piano mm	Estraibilità mm
F AR 7650 01	__	1250	900	1205	845	770
F AR 7660 01	__	1250	1100	1205	1045	970
F AR 7670 01	__	1250	1300	1205	1245	1170



PORTATA 1000 kg

le portate sono nette e si riferiscono a pesi uniformemente distribuiti



I piani estraibili vengono forniti con etichetta di portata.



LARGHEZZA CAMPATA

SYSTEM F AR

Gamma colori
ACCIAIO

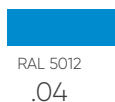
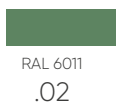
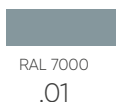

B PIANI AD ESTRAZIONE SEMPLICE CON 3 BORDI



LARGHEZZA CAMPATA 1250 mm

ART.		Utile campata mm	Profondità scaffale mm	Larghezza utile del piano mm	Profondità utile del piano mm	Estraibilità mm
F AR 6600 00 _ _		1250	900	1160	800	600
F AR 6610 00 _ _		1250	1100	1160	1000	750
F AR 6620 00 _ _		1250	1300	1160	1200	900

B PIANI AD ESTRAZIONE SEMPLICE CON 4 BORDI



LARGHEZZA CAMPATA 1250 mm

ART.		Utile campata mm	Profondità scaffale mm	Larghezza utile del piano mm	Profondità utile del piano mm	Estraibilità mm
F AR 6650 00 _ _		1250	900	1160	800	600
F AR 6660 00 _ _		1250	1100	1160	1000	750
F AR 6670 00 _ _		1250	1300	1160	1200	900



B PIANI AD ESTRAZIONE SEMPLICE CON 4 BORDI E COPERTURA IN MULTIPLEX

LARGHEZZA CAMPATA 1250 mm

ART.		Utile campata mm	Profondità scaffale mm	Larghezza utile del piano mm	Profondità utile del piano mm	Estraibilità mm
F AR 6650 01 _ _		1250	900	1160	800	600
F AR 6660 01 _ _		1250	1100	1160	1000	750
F AR 6670 01 _ _		1250	1300	1160	1200	900

**LARGHEZZA
CAMPATA**



PORTATA 800 kg

le portate sono nette e si riferiscono a pesi uniformemente distribuiti



I piani estraibili vengono forniti con etichetta di portata.



SYSTEM F AR

Gamma colori
ACCIAIO 

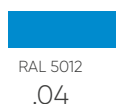
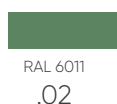
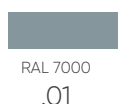

PARETI POSTERIORI

ART.		H scaffale mm	Parete posteriore con n° lamiere	Larghezza campata mm
F AR 1450 00	__	1510	3	
F AR 1460 00	__	2010	4	
F AR 1470 00	__	2210	4	850
F AR 1480 00	__	2510	5	
F AR 1490 00	__	3010	6	
F AR 1500 00	__	1510	3	
F AR 1510 00	__	2010	4	
F AR 1520 00	__	2210	4	1050
F AR 1530 00	__	2510	5	
F AR 1540 00	__	3010	6	
F AR 1550 00	__	1510	3	
F AR 1560 00	__	2010	4	
F AR 1570 00	__	2210	4	1250
F AR 1580 00	__	2510	5	
F AR 1590 00	__	3010	6	

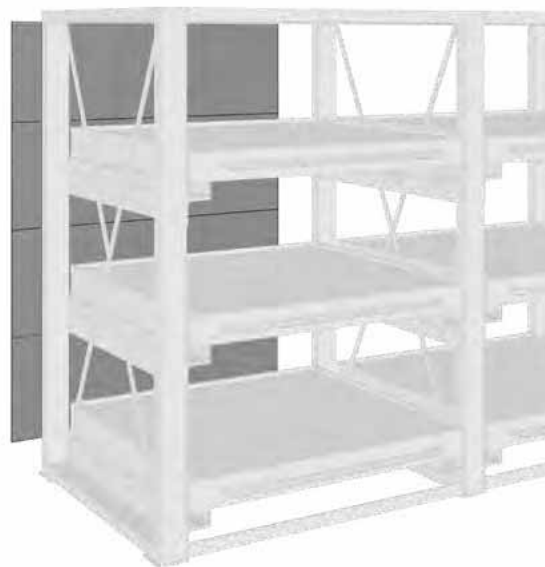

È obbligatorio almeno ogni 2 campate, montare una parete posteriore

PARETI LATERALI

ART.		H scaffale mm	Parete posteriore con n° lamiere	Larghezza campata mm
F AR 1250 00	__	1510	3	
F AR 1260 00	__	2010	4	
F AR 1270 00	__	2210	4	900
F AR 1280 00	__	2510	5	
F AR 1290 00	__	3010	6	
F AR 1300 00	__	1510	3	
F AR 1310 00	__	2010	4	
F AR 1320 00	__	2210	4	1100
F AR 1330 00	__	2510	5	
F AR 1340 00	__	3010	6	
F AR 1350 00	__	1510	3	
F AR 1360 00	__	2010	4	
F AR 1370 00	__	2210	4	1300
F AR 1380 00	__	2510	5	
F AR 1390 00	__	3010	6	

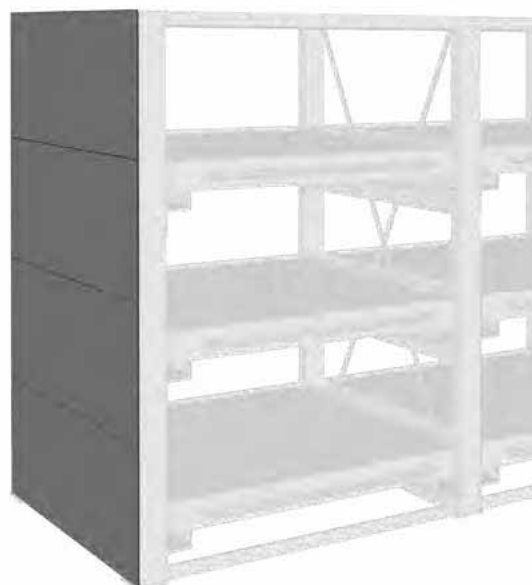

COPPIA PORTE SCORREVOLI

ART.		H scaffale mm	Spessore telaio mm	Larghezza campata mm	Larghezza scaffale mm
F AR 5000 00	__	1510	165		
F AR 5050 00	__	2010	165		
F AR 5100 00	__	2210	165	850	1900
F AR 5150 00	__	2510	165		
F AR 5200 00	__	3010	165		
F AR 5250 00	__	1510	165		
F AR 5300 00	__	2010	165		
F AR 5350 00	__	2210	165	1050	2300
F AR 5400 00	__	2510	165		
F AR 5450 00	__	3010	165		
F AR 5500 00	__	1510	165		
F AR 5550 00	__	2010	165		
F AR 5600 00	__	2210	165	1250	2700
F AR 5650 00	__	2510	165		
F AR 5700 00	__	3010	165		



Le porte scorrevoli chiudono 2 campate e sono complete di serratura a cilindro e 2 chiavi

FISSAGGIO

SET DI FISSAGGIO DI RICAMBIO PER UNA FIANCATA



ART. F AR 8999 00 99

Materiale di fissaggio composto da 2 viti ad espansione in acciaio M16x140 mm per pavimenti in calcestruzzo non fessurato maggiori o uguali alla classe: C20/25.

LE PORTATE SONO NETTE E SI RIFERISCONO A PESI UNIFORMEMENTE DISTRIBUITI





P 41

P 31

P 2,1

P 2,1

N 41

N 31

N 21

N 11

FAMI S.R.L.

VIA STAZIONE ROSSANO, 13 – 36027 ROSÀ (VI) ITALY
TEL +39 0424 585455 R.A. – FAX +39 0424 585470
COMMERCIALE@FAMISPA.COM – WWW.FAMISPA.COM

EXPORT DEPARTMENT

TEL +39 0424 585455 – FAX +39 0424 585472
EXPORT@FAMISPA.COM – WWW.FAMISPA.COM

