

# TUBI INDUSTRIALI

INDUSTRIAL RUBBER AND PVC HOSES





# CONNECT.SUPPORT.CONVEY

Da quasi 60 anni, Sati Group produce e distribuisce nastri trasportatori in gomma, tubi industriali in gomma e PVC, lastre e tappeti in gomma.

Since 60 years, Sati Group produces and distributes rubber conveyor belts, industrial rubber and PVC hoses, rubber sheeting and foam rubber.

Puntiamo da sempre sull'affidabilità del servizio, la prontezza delle consegne, la costante disponibilità a magazzino di oltre 5.000 articoli di alta qualità, oltre a un servizio personalizzato e su misura che ci consente di gestire oltre 2500 ordini al mese. Quasi sessant'anni di storia non si improvvisano. In un contesto internazionale sempre più competitivo, il patrimonio di esperienze accumulato in decenni di successi sui principali mercati internazionali ci ha insegnato l'importanza di ascoltare i clienti per intuirne in anticipo le esigenze e rispondere con efficacia anche nelle situazioni più complesse. La ricerca di nuove soluzioni è parte integrante del nostro DNA.

Da sempre cerchiamo in tutto il mondo prodotti di qualità superiore, in grado di migliorare le prestazioni e l'efficienza di ogni tipo di processo industriale. Investiamo in sviluppo, progettando e realizzando soluzioni e prodotti innovativi come le nostre linee di produzione SATIVERTICAL (nastri trasportatori bordi e tazze) e SATIFOAM (materiali espansi) in grado di fare la differenza per prestazioni e durata.

Il nostro headquarter di Castel Maggiore si estende su una superficie coperta di oltre 20.000 mq ed è dotato della più avanzata impiantistica per la produzione, l'assemblaggio e la movimentazione di tutti gli articoli a catalogo. Il nostro obiettivo è assicurare il massimo di efficacia produttiva ed efficienza logistica al cliente nel rispetto della sicurezza e del benessere di tutto il nostro team.

We based our service on the reliability, rapid deliveries, the availability of over 5000 high quality products in our warehouse and the tailor made service that allow us to handle over 2500 orders every month. Almost sixty years of history have taught us the importance of listening to our customers in order to understand their needs and to provide support in handling complex procedures and special orders. The searching of new solutions is in our DNA.

We try to find all over the world high quality products in order to increase the efficiency of every industrial process. We invest in development and we realize innovative solutions and products such as our SATIVERTICAL (sidewalls and cleats belts) and SATIFOAM (foam materials) production lines.

Our headquarter based in Castel Maggiore occupies an area of over 20.000 square meters and it is equipped with the most advanced production, assembly and handling systems. Our goal is to ensure the best logistic and production efficiency for our customers in full respect for the welfare of our team.



La nostra forza risiede anche nella sede centrale di cui disponiamo: 20.000 m<sup>2</sup> di magazzino e oltre 500 m<sup>2</sup> di uffici ci permettono di avere oltre 5000 articoli in pronta consegna e, di conseguenza, di gestire puntualmente oltre 2400 ordini clienti al mese.

Our strength also lies in our main base, where we have 20,000 sqm of warehouse and 500 sqm of office space, enabling us to offer more than 5,000 items ready for delivery and therefore to efficiently handle over 2,400 orders every month.



La logistica che funziona.  
Logistics that work.

# INDICE INDEX



## TUBI PER ACQUA E FLUIDI INERTI WATER AND INERT FLUID HOSES

7

●	ACQUA / LN 10	8
●	PRESSCORD 10 BAR	9
●	ACQUA / HD 10	10
●	POMPE ACQUA / 10	11
●	POMPE ACQUA / 20	12
●	CORDFLAT L LEGGERA / LIGHT	13
●	CORDFLAT M MEDIA / MEDIUM	14
●	CORDFLAT P PESANTE / HEAVY	15
●	CORDFLAT I INDUSTRIAL	16
●	ACQUA / SP 10	17
●	ONDULATO / SPM	18
●	CORDFLEX S.T. LIQUIDI	19
●	AGRISTEEL PL	20
●	CORDFLEX PESANTE / HEAVY	21
●	CORDFLEX S.E. LIQUIDI	22
●	CORDFLEX SUPERIOR S.E.	23
●	CORDFLEX IDROS	24
●	WATER POWER HD 250 BAR	25
●	FIRE HD 40 BAR	26



## TUBI RETINATI PER IRRORAZIONE E GIARDINAGGIO BRAIDED SPRAYING AND GARDENING PVC HOSES

27

●	FRUTCORD 25 BAR	28
●	FRUTCORD 40 BAR PREMIUM	29
●	FRUTCORD 40 BAR	30
●	FRUTCORD 50 BAR	31
●	FRUTCORD 80 BAR	32
●	FRUTCORD 100 BAR	33
●	ELBACORD NO TWIST	34
●	NEMOCORD NO TWIST	35
●	GARDENCORD VG	36



## TUBI PER ARIA COMPRESSA COMPRESSED AIR HOSES

37

●	ARIA / LN 20	38
●	PRESSCORD 20 BAR	39
●	PRESSCORD PU	40
●	PRESSCORD SUPER	41
●	ARIA / HD 20	42
●	ARIA / HD 25	43
●	ARIA / SHD 40	44



## TUBI PER OLI E CARBURANTI OIL AND FUEL HOSES

45

●	CRISTALBENZ	46
●	CARBO / LN 10	47
●	CARBO / LN 20	48
●	CARBO / LN 25	49
●	CARBO / ECO	50
●	CARBO / ISO 7840 A1	51
●	CARBO / LN DIN 73379	52
●	POWERBLUE / LN ISO 22241	53
●	CARBO / LN SAE J30 R7	54
●	CARBO / LN SAE J30 R2-R6	55
●	EASY LOCK / LN SAE 100 R6	56
●	CARBO / HD 10	57
●	ASPOCORD / HD 20	58
●	CARBO STATION	59
●	CARBO / SP 10	60
●	CORDFLEX OIL S.E.	61
●	CORDFLEX OIL ANTISTATIC	62
●	GRECATO / SP MULTIPURPOSE	63
●	ONDULCARBO / SPR	64
●	ONDULCARBO / SPM	65
●	TANK TRUCK / HD EN 12115	66
●	TANK TRUCK / SP EN 12115	67
●	SAE 100 R4	68
●	OIL / RETURN	69
●	SAE 100 R6	70
●	SAE 100 R3	71
●	DIN 20021 2 TE	72
●	DIN 20021 3 TE	73
●	SAE J 1401	74
●	SAE 100 R7	75



## GUAINE E SPIRALINE DI PROTEZIONE SPIRAL PROTECTION PVC HOSES

76

●	MOLLAFLEX SMART	77
●	MOLLAFLEX HD	78
●	HELIPOPLEN	79
●	PROTECH / PP	80
●	PROTECH / PA	81
●	PROTECH / SIL	82
●	PROTECH / HD	83
●	VIBRO 10	84



## TUBI TRECCIATI TESSILI E IN ACCIAIO TEXTILE AND STEEL WIRE HOSES

### 85

●	SAE 100 R6 ZINC	86
●	SAE 100 R4 ZINC	87
●	CARBO / LN 10 ZINC	88
●	CARBO / HD 10 ZINC	89
●	EN 857 1SC ZINC	90
●	EN 857 2SC ZINC	91
●	DIN 20021 2TE ZINC	92
●	NBR ZINC	93
●	EPDM ZINC	94
●	PTFE INOX	95
●	PTFE OND INOX	96
●	TREC OIL CARBO ECO / TT	97



## TUBI PER ACQUA CALDA E VAPORE HOT WATER AND STEAM HOSES

### 98

●	EPDM / LN 10	99
●	EPDM / LN 20 MULTIPURPOSE	100
●	EPDM / ES	101
●	EASY LOCK / LN 135°	102
●	RADIATOR	103
●	GRECATO / SP MULTIPURPOSE	104
●	ACQUA CALDA / 120°C	105
●	VAPOR / 160°C	106
●	WATER INTAKE / SP	107
●	VAPORE ARMATO	108



## TUBI PER PASSAGGIO DI PRODOTTI ALIMENTARI FOOD DELIVERY HOSES

### 109

●	EPDM FQ	110
●	PRESSCORD FQ	111
●	CLEANING LB	112
●	CLEANING / HD	113
●	CRISTALCORD PER ALIMENTI / FOR FOOD	114
●	CRISTALLO ALIMENTARE	115
●	CRISTALSIL FDA	116
●	CORDSTEEL S.E. PASSO STRETTO / SHORT PITCH	117
●	CORDSTEEL P.L. PASSO LARGO / LARGE PITCH	118
●	MULTISTEEL FG	119
●	CORDFLEX L.D. PER ALIMENTI / FOR FOOD	120
●	CORDFLEX N.T. PER ALIMENTI / FOR FOOD	121
●	CORDFLEX H.D. PER ALIMENTI / FOR FOOD	122
●	CORDFLEX H.D. PER ALIMENTI / FOR FOOD ANTISTATICO / ANTISTATIC	123
●	MULTIFLEX FG	124

●	ULTRAFOOD SP	125
●	WHITE ALIMENT / HD	126
●	WHITE ALIMENT / SP	127
●	FAT ALIMENT / HD	128
●	FAT ALIMENT / SP	129
●	VINOREX	130



## TUBI SPIRALATI PER ASPIRAZIONE ARIA, VENTILAZIONE E CONDIZIONAMENTO VACUUM AND CONDITIONING SPIRAL PVC HOSES

### 131

●	CORDFLEX AIR	132
●	CORDFLEX AIR / P	133
●	THERMOCORD HL	134
●	THERMOCORD 130°C	135
●	THERMOCORD TPR	136
●	THERMOCORD NEOPRENE 150°C - 1S	137
●	THERMOCORD NEOPRENE 150°C - 2S	138
●	THERMOCORD SILICONE 300°C - 1S	139
●	THERMOCORD SILICONE 300°C - 2S	140
●	ARTIC / ESP	141



## TUBI PER MATERIALI ABRASIVI BULK MATERIAL HOSES

### 142

●	CORDFLEX AIR PU	143
●	CORDFLEX AIR PU ANTISTATICO / ANTISTATIC	144
●	AEROCORD PU / ECO	145
●	AEROCORD PU	146
●	AEROCORD PU-H	147
●	SABBIA / HD 12	148
●	SABBIA / HD 18	149
●	ABRABETON / 12	150
●	ABRABETON / 40	151
●	CORDFLEX PU LIQUIDI	152
●	CORDFLEX PU PESANTE / HEAVY	153
●	CEMENTO / HD	154
●	CEMENTO / SP	155
●	ABRAELASTIC / SP	156
●	ABRABETON UC 85	157
●	ASPHALT / SP	158
●	STREET SWEEPER	159
●	SILO / HD	160
●	SILO / SP	161
●	ASPIRDUST / SP	162
●	FLOSTER PARA / HD	163
●	FLOSTER EPDM / HD	162



## TUBI PER GAS E SALDATURA GAS AND WELDING HOSES

165

●	OSSIGENO / LB ISO 3821	166
●	ACETILENE / LR ISO 3821	167
●	BINATO / LB+LR ISO 3821	168
●	PROPANO / LA ISO 3821	169
●	GPL / HD	170
●	GPL / SP	171
●	GAS AUTO	172
●	ARGON / LN ISO 3821	173
●	PRESSCORD METANO UNI CIG	174
●	PRESSCORD GPL UNI CIG	175



## TUBI PER ACCIAIERIE STEEL MILL HOSES

176

●	ACQUA HD 40 AUTOESTINGUENTE / SELF-EXTINGUISHING	177
●	CFV HD 10 / 20 EPDM BIANCO / WHITE EPDM	178
●	CFV SP 10 / 20 SBR NERO / BLACK SBR	179
●	CFV HD 40 AUTOESTINGUENTE / SELF-EXTINGUISHING	180



## TUBI PER PASSAGGIO PRODOTTI CHIMICI CHEMICAL DELIVERY HOSES

181

●	CHIMICO / HD	182
●	CHIMICO / SP	183
●	VERNICI / SP	184
●	CORDLINKED / HD	185
●	CORDLINKED / SP	186
●	CHIMICO / HD EN 12115	187
●	CHIMICO / SP EN 12115	188
●	CORDLINKED / SP EN 12115	189



## TUBI INDUSTRIALI PER USO NAVALE ED IMBARCAZIONI DA DIPORTO MARINE INDUSTRIAL HOSES

190

●	CARBOMARINE / LN 10	191
●	CARBOMARINE / SP	192
●	CARBOMARINE / SP-C	193
●	CARBOMARINE / IT	194
●	MARINGAS / SP	195
●	SILMARINE / SP	196
●	SANITARI / WC ULTRAFLEX	197
●	CORDSTEEL / WC	198
●	SANIFLEX / WC	199
●	SANISTEEL / WC	200
●	ARTIC THERM	201
●	ARTIC ESP	202



## SATIBLOCK® FASCETTE E COLLARI STRINGITUBO CLAMPS AND COLLARS

203

●	STF W1	204
●	STF W2	205
●	STF W4	206
●	STF W5	207
●	STC W2	208
●	STC W4	209
●	STC W5	210
●	MAGNUM W2	211
●	MAGNUM W4	212
●	STM	213
●	STS	214
●	SDB	215
●	SGT	216
●	SBS	217
●	SBV	218
●	SSS	219
●	DIN 3016 W1	220
●	BANDI BLOCK	221

## SIMBOLI / SYMBOLS



DIAMETRO INTERNO  
INSIDE DIAMETER



DIAMETRO ESTERNO  
OUTSIDE DIAMETER



SPESSORE PARETE  
WALL THICKNESS



PRESSIONE D'ESERCIZIO  
WORKING PRESSURE



PRESSIONE DI SCOPPIO  
BURST PRESSURE



ASPIRAZIONE  
VACUUM



PESO  
WEIGHT



RAGGIO DI CURVATURA  
BENDING RADIUS



LUNGHEZZA  
LENGHT



TEMPERATURA D'ESERCIZIO  
WORKING TEMPERATURE

**RUBBER** TUBI INDUSTRIALI IN GOMMA  
INDUSTRIAL RUBBER HOSES

**PVC** TUBI IN PVC FLESSIBILI  
FLEXIBLE PVC HOSES



**SATIBLOCK®**  
FASCETTE E COLLARI STRINGITUBO  
CLAMPS AND COLLARS

ALTRI DIAMETRI O PRESSIONI  
REALIZZABILI SU RICHIESTA.  
Le caratteristiche e i dati tecnici  
possono essere modificati senza preavviso.

OTHER DIAMETERS AND/OR PRESSURES ARE  
FEASIBLE UPON REQUEST.  
The characteristics and technical data  
could be changed without warning.



# TUBI PER ACQUA E FLUIDI INERTI

WATER AND INERT  
FLUID HOSES





## RUBBER



### IMPIEGO APPLICATIONS

Per mandata acqua, aria e fluidi inerti ove siano richieste caratteristiche di leggerezza e flessibilità. Impiegato in molti usi agricoli ed industriali. Resta molto flessibile anche in inverno.

For water, air and inert fluids delivery where it is necessary lightness and flexibility. Useful to agriculture and industrial sector. This hose is very flexible also during the winter season.



### STRUTTURA BODY

<b>A</b>	<b>Sottostrato Tube</b>	Liscio in gomma SBR di colore nero. Natural and synthetic black rubber.
<b>B</b>	<b>Inserti Reinforcement</b>	Tessili sintetici. High tensile synthetic textile.
<b>C</b>	<b>Copertura Cover</b>	Liscia in gomma SBR di colore nero resistente all'abrasione e agli agenti atmosferici. Weather and abrasion resistant smooth synthetic rubber.
	<b>Superficie Surface</b>	Liscia. Smooth.



### FASCETTE E COLLARI STRINGITUBO CONSIGLIATE RECOMMENDED CLAMP/COLLAR

STF - Fascette a vite Hose clamps with screw (pag. 204-207)

STC - Fascette con bullone Hose clamps with bolt (pag. 208-210)



mm	mm	bar	bar	bar	gr/mt	mm	m
5	10,5	10	30	-	92	50	100
8	15	10	30	-	173	80	100
10	16	10	30	-	190	100	100
10	17	10	30	-	204	100	100
12	18	10	30	-	186	120	100
13	19	10	30	-	210	130	100
15	21	10	30	-	236	150	50
16	23	10	30	-	297	160	50
19	26	10	30	-	344	190	50
20	30	10	30	-	540	200	50
22	30	10	30	-	460	220	50
25	33	10	30	-	530	250	50
25	35	10	30	-	700	250	50



**NORME NORMS**  
ISO 1307

**MARCATURA MARKING**  
EUROCORD® WATER RUBBER HOSE P.E. 10 BAR  
ISO 1307

**CONFEZIONAMENTO BOX**  
IMBALLO IN POLIETILENE NERO  
PACKAGING IN BLACK POLYETHYLENE



**-25°C / +70°C**  
**-13°F / +158°F**



PVC

**IMPIEGO APPLICATIONS**

Per mandata acqua, aria e fluidi inerti ove siano richieste caratteristiche di leggerezza e flessibilità. Impiegato in molti usi agricoli ed industriali.

For water, air and inert fluids delivery where it is necessary lightness and flexibility. Useful to agriculture and industrial sector.



**STRUTTURA BODY**

<b>A</b>	<b>Sottostrato Tube</b>	Liscio in PVC di colore nero. Special synthetic PVC compound.
<b>B</b>	<b>Inserti Reinforcement</b>	Tessili sintetici. High tensile synthetic textile.
<b>C</b>	<b>Copertura Cover</b>	Liscia in PVC di colore nero, resistente all'abrasione e agli agenti atmosferici. Abrasion and weather resistant special PVC compound.
	<b>Superficie Surface</b>	Liscia. Smooth.

mm	mm	bar	bar	bar	gr/mt	mm	m
8	15	10	30	-	191	-	100
10	17	10	30	-	224	-	100
12	17	10	30	-	171	-	100
13	19	10	30	-	225	-	100
15	21	10	30	-	254	-	50
16	23	10	30	-	321	-	50
19	26	10	30	-	372	-	50
20	30	10	30	-	550	-	50
22	30	10	30	-	465	-	50
25	33	10	30	-	510	-	50
25	35	10	30	-	650	-	50
25	33	10	30	-	530	250	50
25	35	10	30	-	700	250	50

**FASCETTE E COLLARI STRINGITUBO CONSIGLIATE RECOMMENDED CLAMP/COLLAR**

STF - Fascette a vite Hose clamps with screw (pag. 204-207)  
SGT - Fascette pinzabili Stepp less (pag. 216)



**NORME NORMS:**  
ISO 1307

**MARCATURA MARKING:**  
PRESSCORD® WATER HOSE WP 10BAR 16.05

**-10°C / +60°C**  
**+14°F / +140°F**

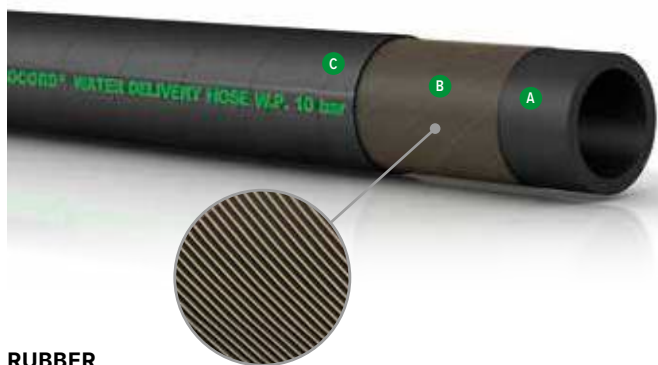

## RUBBER



### IMPIEGO APPLICATIONS

Per mandata acqua, aria e fluidi inerti ove siano richieste caratteristiche di leggerezza e flessibilità. Impiegato in molti usi agricoli ed industriali. Resta molto flessibile anche in inverno.

For water, air and inert fluids delivery where it is necessary lightness and flexibility. Useful to agriculture and industrial sector. This hose is very flexible also during the winter season.



### STRUTTURA BODY

<b>A</b>	<b>Sottostrato Tube</b>	Liscio in gomma SBR di colore nero. Natural and synthetic black rubber.
<b>B</b>	<b>Inserti Reinforcement</b>	Tessili sintetici. High tensile synthetic textile.
<b>C</b>	<b>Copertura Cover</b>	Liscia in gomma SBR di colore nero resistente all'abrasione e agli agenti atmosferici. Weather and abrasion resistant smooth synthetic rubber.
	<b>Superficie Surface</b>	Liscia ad impressione tela. Smooth with fabric impression.



### FASCETTE E COLLARI STRINGITUBO CONSIGLIATE RECOMMENDED CLAMP/COLLAR

STF - Fascette a vite Hose clamps with screw (pag. 204-207)

STC - Fascette con bullone Hose clamps with bolt (pag. 208-210)



mm	mm	bar	bar	bar	gr/mt	mm	m
25	34	10	30	-	546	254	40
30	42	10	30	-	958	300	40
32	44	10	30	-	1002	320	40
35	48	10	30	-	1207	350	40
38	52	10	30	-	1395	380	40
40	54	10	30	-	1484	400	40
45	61	10	30	-	1528	450	40
50	64	10	30	-	1639	500	40
60	78	10	30	-	3579	600	40
80	103	10	30	-	4558	800	20-40
100	126	10	30	-	6225	1000	20-40



**NORME NORMS:**  
ISO 1307

**MARCATURA MARKING:**  
EUROCORD® WATER DELIVERY HOSE W.P. 10 BAR

**CONFEZIONAMENTO BOX:**  
IMBALLO IN POLIETILENE NERO  
PACKAGING IN BLACK POLYETHYLENE



**-25°C / +70°C**  
**-13°F / +158°F**

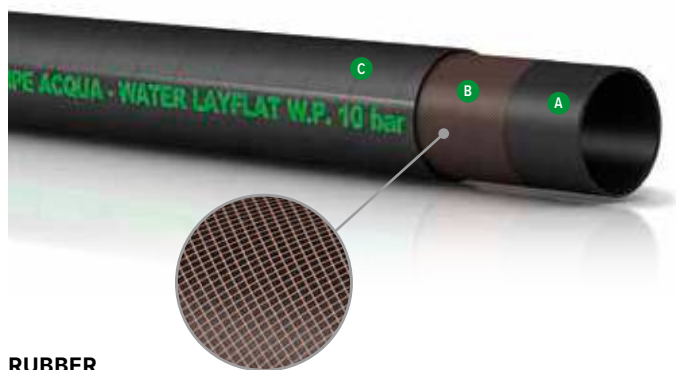

**RUBBER**

- Appiattibile.**  
**Flattenable.**

**IMPIEGO APPLICATIONS**

Per mandata e scarico di acqua e fluidi non corrosivi. Normalmente utilizzato a corredo di pompe sommerse o convogliamento di acqua nei prosciugamenti di falda. Può essere appiattito e avvolto su aspi.

For water and non corrosive fluids delivery. Used in support to submersible pumps or to conveying water in groundwater. It could be flattened or wrapped.



**STRUTTURA BODY**

<b>A</b>	<b>Sottostrato Tube</b>	Liscio in gomma SBR di colore nero. Natural and synthetic black rubber.
<b>B</b>	<b>Inserti Reinforcement</b>	Tessili sintetici. High tensile synthetic textile.
<b>C</b>	<b>Copertura Cover</b>	Liscia in gomma SBR/EPDM di colore nero resistente all'abrasione e agli agenti atmosferici. Weather and abrasion resistant smooth synthetic rubber.
	<b>Superficie Surface</b>	Liscia ad impressione tela. Smooth with fabric impression.

mm	mm	bar	bar	bar	gr/mt	mm	m
25	31	10	30	-	338	-	40
30	36	10	30	-	411	-	40
40	46	10	30	-	558	-	40
45	51	10	30	-	663	-	40
50	57	10	30	-	751	-	40
60	67	10	30	-	990	-	40
70	77	10	30	-	1081	-	40
75	85	10	30	-	1173	-	40
80	87	10	30	-	1308	-	20-40
90	97	10	30	-	1464	-	20-40
100	108	10	30	-	1660	-	20-40

**FASCETTE E COLLARI STRINGITUBO CONSIGLIATE RECOMMENDED CLAMP/COLLAR**

STC - Fascette con bullone Hose clamps with bolt (pag. 208-210)  
 BANDI BLOCK - Coppia di serraggio Tightening torque (pag. 221)



**NORME NORMS:**  
ISO 1307

**MARCATURA MARKING:**  
EUROCORD® WATER FLAT HOSE W.P. 10 BAR

**CONFEZIONAMENTO BOX:**  
IMBALLO IN POLIETILENE NERO  
PACKAGING IN BLACK POLYETHYLENE

**-25°C / +70°C**  
**-13°F / +158°F**

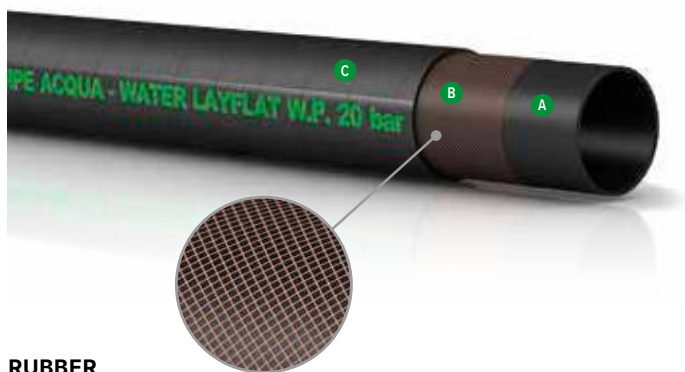

RUBBER



- **Appiattibile.**  
Flattenable.



### IMPIEGO APPLICATIONS

Per mandata e scarico di acqua e fluidi non corrosivi. Normalmente utilizzato a corredo di pompe sommerse o convogliamento di acqua nei prosciugamenti di falda. Può essere appiattito e avvolto su aspi.

For water and non corrosive fluids delivery. Used in support to submersible pumps or to conveying water in groundwater. It could be flattened or wrapped.



### STRUTTURA BODY

<b>A</b>	<b>Sottostrato Tube</b>	Liscio in gomma SBR di colore nero. Natural and synthetic black rubber.
<b>B</b>	<b>Inserti Reinforcement</b>	Tessili sintetici. High tensile synthetic textile.
<b>C</b>	<b>Copertura Cover</b>	Liscia in gomma SBR/EPDM di colore nero, resistente all'abrasione e agli agenti atmosferici. Weather resistant synthetic rubber.
	<b>Superficie Surface</b>	Liscia ad impressione tela. Smooth with fabric impression.



### FASCETTE E COLLARI STRINGITUBO CONSIGLIATE RECOMMENDED CLAMP/COLLAR

STC - Fascette con bullone Hose clamps with bolt (pag. 208-210)  
BANDI BLOCK - Coppia di serraggio Tightening torque (pag. 221)



mm	mm	bar	bar	bar	gr/mt	mm	m
25	36	20	60	-	714	-	40
30	40	20	60	-	747	-	40
32	42	20	60	-	782	-	40
40	50	20	60	-	945	-	40
42	52	20	60	-	998	-	40
45	55	20	60	-	1053	-	40
48	58	20	60	-	1080	-	40
50	60	20	60	-	1100	-	40
60	69	20	60	-	1274	-	40
70	79	20	60	-	1650	-	40
75	84	20	60	-	1717	-	40
80	90	20	60	-	1796	-	20-40
90	102	20	60	-	2444	-	20-40
102	113	20	60	-	2538	-	20-40
120	131	20	60	-	2930	-	20
153	164	20	60	-	3672	-	20



**NORME NORMS:**  
ISO 1307

**MARCATURA MARKING:**  
EUROCORD® WATER RUBBER HOSE W.P. 20 BAR

**CONFEZIONAMENTO BOX:**  
IMBALLO IN POLIETILENE NERO  
PACKAGING IN BLACK POLYETHYLENE



**-25°C / +70°C**  
**-13°F / +158°F**



PVC



- **Appiattibile.**  
Flattenable.



### IMPIEGO APPLICATIONS

Per mandata o scarico di acqua e fluidi non corrosivi. Tubazione estremamente leggera, può essere riavvolta ed appiattita dopo l'uso ed è facilmente trasportabile. Particolarmente utilizzata in agricoltura per l'irrigazione. Ottima anche come guaina di protezione.

For water and non corrosive fluids delivery. This hose is very light and could be wrapped or flattened after use. Easy to transport. Used in the agricultural sector and for the irrigation. Good also like a protection sleeve.



### STRUTTURA BODY

<b>A</b>	<b>Sottostrato Tube</b>	Liscio in PVC di colore nero. Flexible PVC lining.
<b>B</b>	<b>Inserti Reinforcement</b>	Tessili sintetici. High tensile synthetic textile.
<b>C</b>	<b>Copertura Cover</b>	Liscia in PVC di colore verde, resistente all'abrasione ed agli agenti atmosferici. Light chemicals and weather resistant PVC outer cover.
	<b>Superficie Surface</b>	Verde o grigio. Green or grey.

mm	mm	bar	bar	bar	gr/mt	mm	m
25	-	5	15	-	170	-	100
32	-	5	15	-	200	-	100
38	-	5	14	-	240	-	100
40	-	5	13	-	250	-	100
45	-	5	13	-	260	-	100
50	-	5	12	-	270	-	100
55	-	5	12	-	320	-	100
60	-	5	12	-	340	-	100
63	-	5	12	-	360	-	100
70	-	4	9	-	400	-	100
76	-	4	9	-	430	-	100
80	-	4	9	-	450	-	100
90	-	4	9	-	530	-	100
100	-	3	8	-	620	-	100
150	-	2	6	-	1100	-	100



### FASCETTE E COLLARI STRINGITUBO CONSIGLIATE RECOMMENDED CLAMP/COLLAR

STC - Fascette con bullone Hose clamps with bolt (pag. 208-210)

BANDI BLOCK - Coppia di serraggio Tightening torque (pag. 221)



NORME NORMS:  
ISO 1307



-5°C / +60°C  
+23°F / +140°F

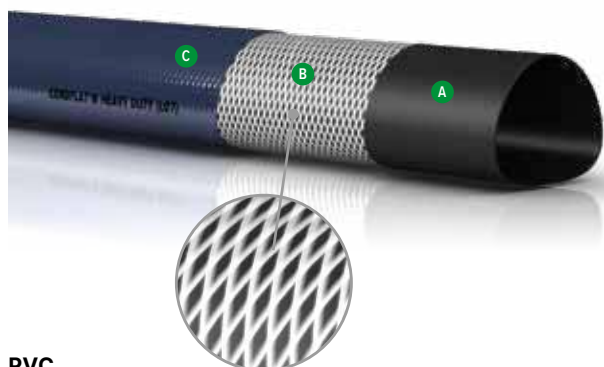

PVC



- **Appiattibile.**  
**Flattenable.**



### IMPIEGO APPLICATIONS

Per mandata o scarico di acqua e fluidi non corrosivi. Tubazione estremamente leggera, può essere riavvolta ed appiattita dopo l'uso ed è facilmente trasportabile. Particolarmente utilizzata in agricoltura per l'irrigazione. Ottima anche come guaina di protezione.

For water and non corrosive fluids delivery. This hose is very light and could be wrapped or flattened after use. Easy to transport. Used in the agricultural sector and for the irrigation. Good also like a protection sleeve.



### STRUTTURA BODY

<b>A</b>	<b>Sottostrato Tube</b>	Liscio in PVC di colore nero. Flexible PVC lining.
<b>B</b>	<b>Inserti Reinforcement</b>	Tessili sintetici. High tensile synthetic textile.
<b>C</b>	<b>Copertura Cover</b>	Liscia in PVC di colore blu, resistente all'abrasione ed agli agenti atmosferici. Light chemicals and weather resistant PVC outer cover.
	<b>Superficie Surface</b>	Blu scuro. Dark blue.



### FASCETTE E COLLARI STRINGITUBO CONSIGLIATE RECOMMENDED CLAMP/COLLAR

STC - Fascette con bullone Hose clamps with bolt (pag. 208-210)  
BANDI BLOCK - Coppia di serraggio Tightening torque (pag. 221)



mm	mm	bar	bar	bar	gr/mt	mm	m
32	-	8	20	-	220	-	50/100
38	-	7	18	-	260	-	50/100
40	-	7	18	-	280	-	50/100
45	-	7	18	-	310	-	50/100
50	-	7	18	-	360	-	50/100
60	-	6	16	-	430	-	50/100
63	-	6	16	-	440	-	50/100
70	-	6	16	-	470	-	50/100
76	-	6	16	-	520	-	50/100
80	-	6	16	-	560	-	50/100
90	-	6	14	-	640	-	50/100
100	-	4	14	-	760	-	50/100
150	-	3,5	9	-	1280	-	50/100
200	-	2,5	7	-	2000	-	50/100



NORME NORMS:  
ISO 1307



-5°C / +60°C  
+23°F / +140°F



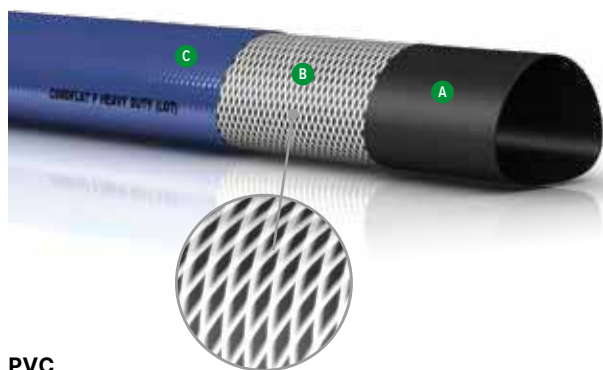

PVC



- **Appiattibile.**  
**Flattenable.**

### IMPIEGO APPLICATIONS

Per mandata o scarico di acqua e fluidi non corrosivi. Tubazione estremamente leggera, può essere riavvolta ed appiattita dopo l'uso ed è facilmente trasportabile. Particolarmente utilizzata in agricoltura per l'irrigazione. Ottima anche come guaina di protezione.

For water and non corrosive fluids delivery. This hose is very light and could be wrapped or flattened after use. Easy to transport. Used in the agricultural sector and for the irrigation. Good also like a protection sleeve.



### STRUTTURA BODY

<b>A</b>	<b>Sottostrato Tube</b>	Liscio in PVC di colore nero. Flexible PVC lining.
<b>B</b>	<b>Inserti Reinforcement</b>	Tessili sintetici. High tensile synthetic textile.
<b>C</b>	<b>Copertura Cover</b>	Liscia in PVC di colore blu, resistente all'abrasione ed agli agenti atmosferici. Light chemicals and weather resistant PVC outer cover.
	<b>Superficie Surface</b>	Blu chiaro. Light blue.

mm	mm	bar	bar	bar	gr/mt	mm	m
25	-	12	35	-	225	-	50/100
30	-	10	30	-	250	-	50/100
32	-	10	30	-	260	-	50/100
35	-	10	25	-	280	-	50/100
38	-	10	25	-	300	-	50/100
40	-	10	25	-	320	-	50/100
45	-	10	25	-	350	-	50/100
51	-	9	25	-	410	-	50/100
60	-	9	25	-	540	-	50/100
63	-	9	25	-	560	-	50/100
70	-	9	25	-	620	-	50/100
76	-	9	25	-	680	-	50/100
80	-	9	25	-	740	-	50/100
90	-	9	25	-	860	-	50/100
100	-	8	23	-	1050	-	50/100
125	-	6	18	-	1350	-	50/100
152	-	4	11	-	1750	-	50/100
200	-	2,5	8	-	2400	-	50/100

### FASCETTE E COLLARI STRINGITUBO CONSIGLIATE RECOMMENDED CLAMP/COLLAR

STC - Fascette con bullone Hose clamps with bolt (pag. 208-210)  
BANDI BLOCK - Coppia di serraggio Tightening torque (pag. 221)



NORME NORMS:  
ISO 1307

-5°C / +60°C  
+23°F / +140°F

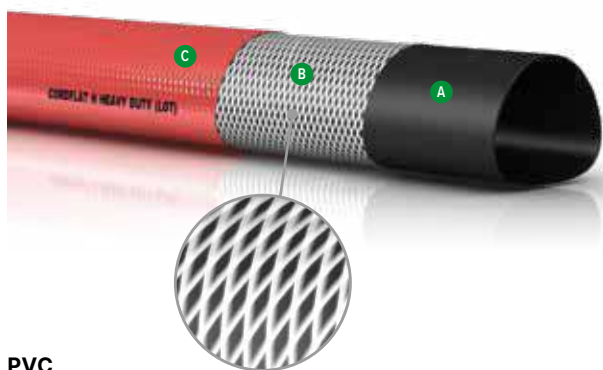

PVC



- **Appiattibile.**  
**Flattenable.**



### IMPIEGO APPLICATIONS

Per mandata o scarico di acqua e fluidi non corrosivi. Tubazione estremamente leggera, può essere riavvolta ed appiattita dopo l'uso ed è facilmente trasportabile. Particolarmente utilizzata in agricoltura per l'irrigazione. Ottima anche come guaina di protezione.

For water and non corrosive fluids delivery. This hose is very light and could be wrapped or flattened after use. Easy to transport. Used in the agricultural sector and for the irrigation. Good also like a protection sleeve.



### STRUTTURA BODY

<b>A</b>	<b>Sottostrato Tube</b>	Liscia in PVC di colore nero. Flexible PVC lining.
<b>B</b>	<b>Inserti Reinforcement</b>	Tessili sintetici. High tensile synthetic textile.
<b>C</b>	<b>Copertura Cover</b>	Liscia in PVC di colore rosso, resistente all'abrasione ed agli agenti atmosferici. Light chemicals and weather resistant PVC outer cover.
	<b>Superficie Surface</b>	Rosso. Red.



### FASCETTE E COLLARI STRINGITUBO CONSIGLIATE RECOMMENDED CLAMP/COLLAR

STC - Fascette con bullone Hose clamps with bolt (pag. 208-210)  
BANDI BLOCK - Coppia di serraggio Tightening torque (pag. 221)



mm	mm	bar	bar	bar	gr/mt	mm	m
38	-	16	48	-	450	-	50/100
40	-	16	48	-	490	-	50/100
45	-	16	48	-	520	-	50/100
51	-	16	48	-	600	-	50/100
63	-	16	48	-	840	-	50/100
76	-	13	33	-	960	-	50/100
80	-	13	13	-	1020	-	50/100
90	-	13	33	-	1150	-	50/100
100	-	13	33	-	1400	-	50/100
152	-	7	21	-	2750	-	50/100
200	-	5	15	-	3500	-	50/100
100	-	4	14	-	760	-	50/100
150	-	3,5	9	-	1280	-	50/100
200	-	2,5	7	-	2000	-	50/100



NORME NORMS:  
ISO 1307



-5°C / +60°C  
+23°F / +140°F

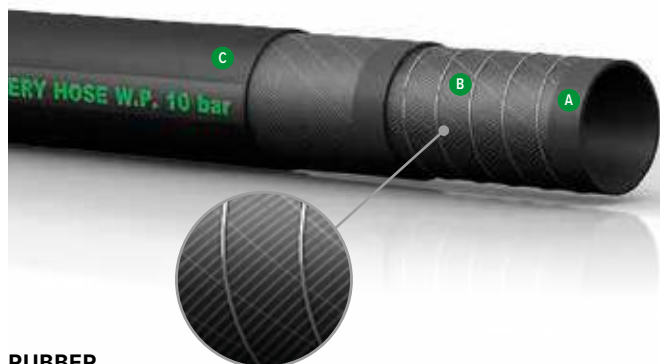

**RUBBER**



- **Appiattibile.**  
**Flattenable.**



**IMPIEGO**  
**APPLICATIONS**

Per mandata ed aspirazione di acqua e fluidi non corrosivi. Particolarmente indicato per svariati usi agricoli ed industriali.

For water and non corrosive fluids suction and delivery. Used in the agricultural and industrial sectors.



**STRUTTURA**  
**BODY**

<b>A</b>	<b>Sottostrato Tube</b>	Gomma SBR di colore nero. Natural and synthetic rubber.
<b>B</b>	<b>Inserti Reinforcement</b>	Tessili sintetici e spirale metallica incorporata. High tensile synthetic textile and steel helix wire.
<b>C</b>	<b>Copertura Cover</b>	Liscia in gomma SBR/EPDM di colore nero, resistente all'abrasione, agli agenti atmosferici ed all'invecchiamento. Abrasion and weather resistant synthetic rubber
	<b>Superficie Surface</b>	Liscia ad impressione tela. Smooth with fabric impression.



**FASCETTE E COLLARI STRINGITUBO CONSIGLIATE**  
**RECOMMENDED CLAMP/COLLAR**

STC - Fascette con bullone Hose clamps with bolt (pag. 208-210)  
BANDI BLOCK - Coppia di serraggio Tightening torque (pag. 221)



mm	mm	bar	bar	bar	gr/mt	mm	m
19	29	10	30	0,8	575	152	40
25	36	10	30	0,8	741	200	40
30	41	10	30	0,8	909	240	40
32	43	10	30	0,8	961	256	40
35	46	10	30	0,8	1038	280	40
38	49	10	30	0,8	1240	304	40
40	51	10	30	0,8	1337	320	40
42	52	10	30	0,8	1380	336	40
45	57	10	30	0,8	1490	360	40
50	63	10	30	0,8	1745	408	40
60	73	10	30	0,8	2156	480	40
63	76	10	30	0,8	2325	504	40
70	84	10	30	0,8	2741	560	40
76	90	10	30	0,8	2963	608	40
80	94	10	30	0,8	3099	640	20-40
90	102	10	30	0,8	4238	720	20-40
100	114	10	30	0,8	4186	816	20-40
102	114	10	30	0,8	4186	816	20-40
110	126	10	30	0,8	4660	880	20
120	138	10	30	0,8	5981	960	20
127	144	10	30	0,8	5418	1016	20
150	172	10	30	0,8	8550	1216	20



**NORME NORMS:**  
ISO 1307  
**MARCATURA MARKING:**  
EUROCORD® RUBBER HOSE W.P. 10 BAR ISO 1307  
**CONFEZIONAMENTO BOX:**  
IMBALLO IN POLIETILENE NERO  
PACKAGING IN BLACK POLYETHYLENE



**-25°C / +70°C**  
**-13°F / +158°F**



RUBBER



## IMPIEGO APPLICATIONS

Idoneo all'aspirazione e mandata di acqua e fluidi non corrosivi. Prodotto nelle specifiche pezzature d'impiego con manicotti lisci alle estremità per facilitarne il montaggio. Particolarmente indicato per svariati usi agricoli ed industriali.

For water and non corrosive fluids suction and delivery. Produced in various sizes with smooth cuffs ends, to help the installation. Normally used in agricultural and industrial uses.



## STRUTTURA BODY

<b>A</b>	<b>Sottostrato Tube</b>	Gomma SBR di colore nero. Natural and synthetic black rubber.
<b>B</b>	<b>Inserti Reinforcement</b>	Tessili sintetici e spirale metallica incorporata. High tensile synthetic textile and steel helix wire.
<b>C</b>	<b>Copertura Cover</b>	Gomma SBR resistente all'ozono e agli agenti atmosferici. Weather and abrasion resistant smooth synthetic rubber.
	<b>Superficie Surface</b>	Ondulata ad impressione tela con manicotti all'estremità. Corrugated with fabric impression.







## FASCETTE E COLLARI STRINGITUBO CONSIGLIATE RECOMMENDED CLAMP/COLLAR

STC - Fascette con bullone Hose clamps with bolt (pag. 208-210)  
BANDI BLOCK - Coppia di serraggio Tightening torque (pag. 221)



- **Disponibile in pezzature d'impiego.**  
Available in different sizes.
- **Manicotti lisci alle estremità.**  
With smooth cuff-ends.



 mm	 mm	<b>CUFF LENGTH</b> mm	 bar	 bar	 bar	 gr/mt	 mm	 m
60	5	100	5	15	0,6	1645	180	2
76	5,5	100	5	15	0,6	2050	218	3
80	5	100	5	15	0,6	2236	240	2-3-6
102	7	120	5	15	0,6	3091	500	2-3-4-6
110	7	120	5	15	0,6	3633	550	2-3-5
120	7	120	5	15	0,6	4193	700	2-3-6
127	7	120	5	15	0,6	4397	750	2-3
133	7	80	5	9	0,6	4944	800	2/3
152	8	150	5	15	0,6	5976	950	2-3-4-6
203	9	180	3	9	0,6	9674	1200	2-3
254	9	200	3	9	0,6	11750	1500	2/3



**NORME NORMS:**  
ISO 1307  
**MARCATURA MARKING:**  
EUROCORD® ONDULATO SP W.P. 5 BAR  
**CONFEZIONAMENTO BOX:**  
IMBALLO IN POLIETILENE NERO  
PACKAGING IN BLACK POLYETHYLENE



**-25°C / +70°C**  
**-13°F / +158°F**



PVC



**IMPIEGO  
APPLICATIONS**

Idoneo alla mandata ed aspirazione di liquidi inerti. Particolarmente indicato nel settore agricolo ed industriale a corredo di pompe di aspirazione.

For water and inert fluids suction and delivery. Normally used in the agricultural and industrial sectors in support of suction pumps.



**STRUTTURA  
BODY**

<b>A</b>	<b>Materiale Material</b>	PVC flessibile. Strong, flexible and smooth plasticized PVC.
<b>B</b>	<b>Inserti Reinforcement</b>	Spirale in PVC antiurto. Shock resistant PVC spiral.
<b>C</b>	<b>Copertura Cover</b>	In PVC resistente all'abrasione, agenti atmosferici ed ozono. Crushing, chemical agents, abrasion and weather resistant, light corrugated outside.
	<b>Superficie Surface</b>	Leggermente corrugata, verde trasparente. Transparent green.

mm	mm	bar	bar	bar	gr/mt	mm	m
20	2,7	-	28	0,8	270	85	50
25	2,9	-	22	0,8	300	112	50
30	3,1	-	21	0,8	380	135	50
32	3,2	-	20	0,8	400	144	50
35	3,2	-	19	0,8	440	157	50
38	3,3	-	18	0,8	470	171	50
40	3,5	-	18	0,8	520	180	50
45	3,5	-	17	0,8	570	202	50
50	3,8	-	15	0,8	690	225	50
60	4	-	13	0,7	900	270	50
70	4,5	-	12	0,7	1080	315	50
75	4,6	-	12	0,7	1260	337	50
80	4,8	-	12	0,6	1440	360	50
90	5,1	-	11	0,6	1620	405	25
100	5,9	-	11	0,6	1980	459	25
110	6,1	-	11	0,5	2250	495	25
120	6,3	-	10	0,4	2520	540	25
125	6,6	-	10	0,4	2880	562	25
150	7	-	9	0,3	3870	675	25
200	8,5	-	7	0,2	5850	900	25



**FASCETTE E COLLARI STRINGITUBO CONSIGLIATE  
RECOMMENDED CLAMP/COLLAR**

STF - Fascette a vite Hose clamps with screw (pag. 204-207)

STC - Fascette con bullone Hose clamps with bolt (pag. 208-210)

BANDI BLOCK - Coppia di serraggio Tightening torque (pag. 221)



NORME NORMS:  
ISO 1307



-5°C / +60°C  
+23°F / +140°F



PVC



- **Tubo universale per mandata e aspirazione liquidi.**  
Liquids suction and delivery universal hose.
- **Estremamente flessibile.**  
Very flexible.



**IMPIEGO  
APPLICATIONS**

Idoneo alla mandata ed ottima aspirazione di liquidi. La spirale metallica lo rende estremamente flessibile. Principalmente impiegato in impianti di drenaggio, macchine agricole e pompe di aspirazione.

Water and inert fluids suction and delivery. The steel spiral wire makes it very flexible. Used in agriculture applications, for the drainage systems, shipbuilding and suction pumps.



**STRUTTURA  
BODY**

<b>A</b>	<b>Materiale Material</b>	PVC flessibile. PVC universal flexible hose.
<b>B</b>	<b>Inserti Reinforcement</b>	Spirale metallica incorporata. Steel spiral wire.
<b>C</b>	<b>Copertura Cover</b>	In PVC resistente all'abrasione, agenti atmosferici ed ozono. Abrasion and weather resistant, PVC compound.
	<b>Superficie Surface</b>	Liscia nera coprente. Black, smooth.

mm	mm	bar	bar	bar	gr/mt	mm	m
12	3	7	-	0,85	180	25	60
13	3	6	-	0,85	190	27	60
14	3	6	-	0,85	200	30	60
16	3,1	6	-	0,85	225	35	60
18	3,1	6	-	0,85	280	40	60
20	3,1	5	-	0,85	340	50	60
22	3,2	5	-	0,85	370	55	60
25	3,2	5	-	0,85	510	60	60
30	3,5	4	-	0,85	600	70	60
32	3,9	4	-	0,85	650	75	30
35	4,2	4	-	0,85	730	80	30
38	4,4	4	-	0,85	800	90	30
40	4,5	3	-	0,85	870	95	30
45	5,1	3	-	0,8	1100	105	30
50	5,1	3	-	0,8	1200	125	30
60	6,5	2,5	-	0,7	1800	135	30



**FASCETTE E COLLARI STRINGITUBO CONSIGLIATE  
RECOMMENDED CLAMP/COLLAR**

STF - Fascette a vite Hose clamps with screw (pag. 204-207)

SGT - Fascette pinzabili Stepp less (pag. 216)

SBS - Fascette bifilari a molla Double wire spring (pag. 217)



NORME NORMS:  
ISO 1307



-5°C / +60°C  
+23°F / +140°F

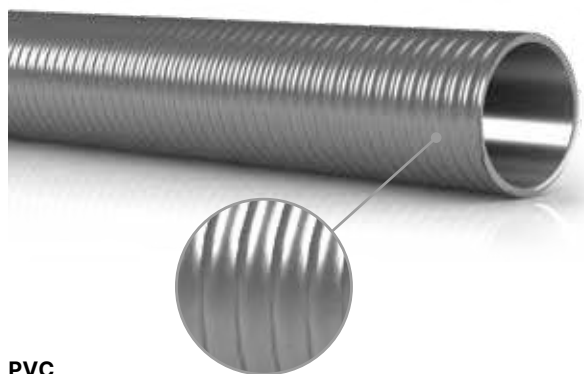

PVC



- **Struttura rinforzata per usi gravosi.**  
Reinforced structure for heavy uses.

**IMPIEGO APPLICATIONS**

Idoneo alla mandata ed aspirazione di liquidi inerti e fanghiglia. Struttura rinforzata per usi gravosi. Particolarmente indicato nel settore autospurghi e cantieristico.

For heavy-duty suction and delivery of water, salt water, light chemicals, liquids, etc. in agricultural, industrial applications and constructions.



**STRUTTURA BODY**

<b>A</b>	<b>Materiale Material</b>	PVC flessibile. Strong, flexible and smooth plasticized PVC.
<b>B</b>	<b>Inserti Reinforcement</b>	Spirale in PVC antiurto. Shock resistant PVC spiral.
<b>C</b>	<b>Copertura Cover</b>	In PVC resistente all'abrasione, agenti atmosferici ed ozono. Crushing, chemical agents, abrasion and weather resistant, light corrugated outside.
	<b>Superficie Surface</b>	Leggermente corrugata grigio metallico. Metallic grey, corrugated.

mm	mm	bar	bar	bar	gr/mt	mm	m
20	4,6	9	-	0,95	415	114	50
25	4,6	8	-	0,95	555	150	50
30	4,8	8	-	0,95	630	180	50
32	4,8	8	-	0,95	680	192	50
35	5	8	-	0,95	730	210	50
38	5	7	-	0,95	775	228	50
40	5	7	-	0,95	825	240	50
45	5,1	7	-	0,95	970	270	50
50	5,6	7	-	0,95	1165	300	50
60	5,9	7	-	0,95	1550	360	50
70	6,1	6	-	0,95	1845	420	50
75	6,2	6	-	0,95	1940	450	50
80	6,4	6	-	0,95	2135	480	50
90	6,6	6	-	0,95	2425	540	25
100	7,2	5	-	0,95	3200	600	25
110	7,8	5	-	0,95	3590	660	25
120	7,9	5	-	0,9	3880	720	25
125	8,3	5	-	0,9	4075	750	25
150	9,8	4	-	0,9	6110	900	25
200	12	3	-	0,9	8730	1200	25

**FASCETTE E COLLARI STRINGITUBO CONSIGLIATE RECOMMENDED CLAMP/COLLAR**

STC - Fascette con bullone Hose clamps with bolt (pag. 208-210)  
BANDI BLOCK - Coppia di serraggio Tightening torque (pag. 221)



**NORME NORMS:**  
ISO 1307

**-5°C / +60°C**  
**+23°F / +140°F**

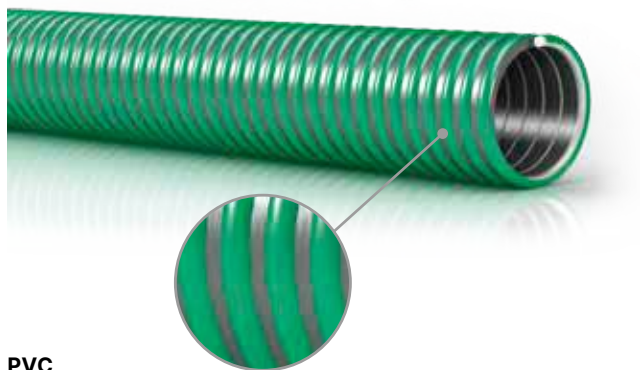

PVC



### IMPIEGO APPLICATIONS

La sua particolare struttura lo rende estremamente flessibile e maneggevole. Studiata appositamente per lo spurgo di fognature e pozzi neri, infatti è facilmente avvolgibile su carri botte. Discreta resistenza alle escursioni termiche.

Strong, flexible and smooth hose for medium duty suction and delivery of water, salt water, light chemicals, liquids, etc. in agricultural, industrial applications constructions, sewer purging, sludge, slurries, waste matter.



### STRUTTURA BODY

<b>A</b>	<b>Materiale Material</b>	PVC super elastico. Special superelastic material.
<b>B</b>	<b>Inseriti Reinforcement</b>	Spirale in PVC antiurto. Shock resistant PVC spiral.
<b>C</b>	<b>Copertura Cover</b>	In PVC resistente all'abrasione, agenti atmosferici ed ozono. Chemical agents, abrasion and weather resistant PVC compound.
	<b>Superficie Surface</b>	Leggermente corrugata verde/grigio metallico. Metallic grey with green spiral, corrugated.











### FASCETTE E COLLARI STRINGITUBO CONSIGLIATE RECOMMENDED CLAMP/COLLAR

STC - Fascette con bullone Hose clamps with bolt (pag. 208-210)  
BANDI BLOCK - Coppia di serraggio Tightening torque (pag. 221)



- **Ottima flessibilità e leggerezza.**  
Great flexibility and lightness.



 mm	 mm	 bar	 bar	 bar	 gr/mt	 mm	 m
20	4	6	-	0,9	370	65	50
25	4	6	-	0,9	440	87	50
30	4,2	5,5	-	0,9	540	120	50
32	4,2	5,5	-	0,9	600	112	50
35	4,2	5,5	-	0,9	630	125	50
38	4,2	4,5	-	0,9	700	133	50
40	4,2	4,5	-	0,9	750	140	50
45	4,4	4,5	-	0,9	860	160	50
50	4,6	4,5	-	0,9	1010	176	50
60	5	4	-	0,9	1250	210	50
70	5,2	3,5	-	0,8	1580	245	50
75	5,4	3,5	-	0,8	1700	262	50
80	5,6	3,5	-	0,8	1830	280	50
90	5,7	3,5	-	0,8	2070	315	25
100	6,1	3	-	0,8	2600	357	25
110	6,3	3	-	0,8	3100	385	25
120	6,6	3	-	0,8	3450	420	25
125	6,7	3	-	0,8	3600	437	25
150	8	2	-	0,8	4800	525	25



NORME NORMS:  
ISO 1307



-5°C / +60°C  
+23°F / +140°F



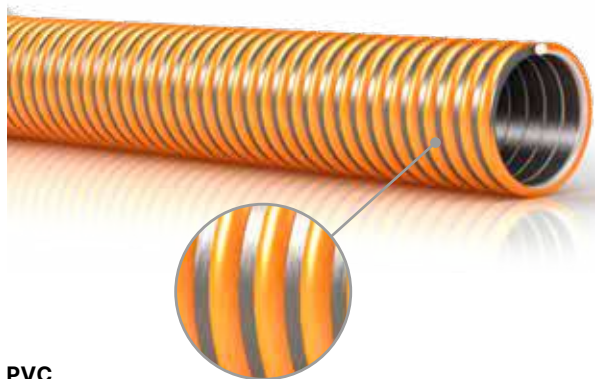

PVC



- **Resistenza a climi estremamente freddi.**  
Low temperature resistant.

**IMPIEGO  
APPLICATIONS**

Tubo liscio, leggero e flessibile per impiego medio di aspirazione e mandata di acque, prodotti chimici leggeri, liquidi ad uso domestico, edilizia, industria, spurghi, agricoltura, solidi abrasivi, specialmente per uso in climi estremamente freddi.

Strong, flexible and smooth hose for medium duty suction and delivery of water, salt water, light chemicals, liquids, etc. in agricultural, industrial applications constructions, sewer purging, sludge, slurries, waste matter, sand and gravel, especially for use in cold climates.



**STRUTTURA  
BODY**

<b>A</b>	<b>Materiale Material</b>	Materiale speciale superelastico. Special superelastic material.
<b>B</b>	<b>Inserti Reinforcement</b>	Spirali in PVC antiurto. Shock resistant PVC spiral.
<b>C</b>	<b>Copertura Cover</b>	In PVC resistente all'abrasione, agenti atmosferici ed ozono. Chemical agents, abrasion and weather resistant PVC compound.
	<b>Superficie Surface</b>	Leggermente corrugata arancione/grigia. Metallic grey with orange spiral, corrugated.

mm	mm	bar	bar	bar	gr/mt	mm	m
19	-	-	16	0,9	360	65	50
25	-	-	16	0,9	480	80	50
30	-	-	14	0,9	560	90	50
32	-	-	13	0,9	580	95	50
35	-	-	12	0,9	640	105	50
38	-	-	12	0,9	670	115	50
40	-	-	11	0,9	700	120	50
45	-	-	11	0,9	870	140	50
51	-	-	11	0,9	975	155	50
55	-	-	11	0,9	1000	160	50
60	-	-	11	0,9	1250	185	50
63	-	-	10	0,9	1360	195	50
70	-	-	8	0,8	1580	220	50
76	-	-	8	0,8	1700	240	50
80	-	-	8	0,8	1800	250	30
90	-	-	7	0,8	2100	290	30
102	-	-	7	0,8	2600	320	30
110	-	-	7	0,8	2900	380	30
127	-	-	6	0,7	3860	500	30
152	-	-	6	0,7	5100	600	30
203	-	-	4	0,6	7850	800	10

**FASCETTE E COLLARI STRINGITUBO CONSIGLIATE  
RECOMMENDED CLAMP/COLLAR**

- STC - Fascette con bullone Hose clamps with bolt (pag. 208-210)
- BANDI BLOCK - Coppia di serraggio Tightening torque (pag. 221)



**NORME NORMS:**  
ISO 1307

**-40°C / +50°C**  
**-40°F / +122°F**

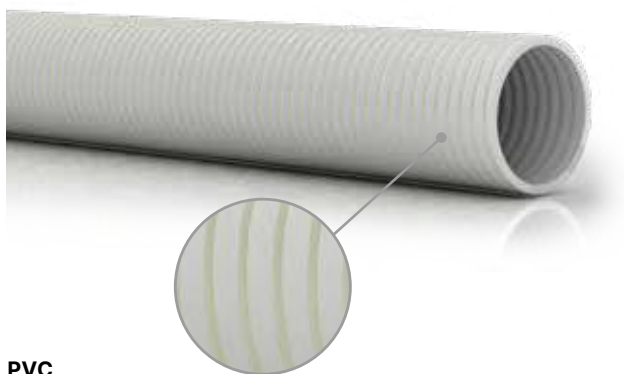

PVC



## IMPIEGO APPLICATIONS

Studiato appositamente per trasportare acqua calda all'interno delle vasche idromassaggio e piscine. La sua particolare struttura, esternamente liscia, permette facilmente l'incollaggio dei relativi raccordi.

For transport of warm water in swimming pools, Jacuzzis, etc.











## STRUTTURA BODY

<b>A</b>	<b>Materiale Material</b>	PVC resistente e flessibile. Strong, flexible and smooth white hose in plasticized PVC.
<b>B</b>	<b>Inseriti Reinforcement</b>	Spirale anti schiacciamento in PVC. Shock resistant PVC spiral.
<b>C</b>	<b>Copertura Cover</b>	PVC. PVC.
	<b>Superficie Surface</b>	Bianco. White.



- **Struttura facilmente raccordabile.**  
Easy fitted structure.



 mm	 mm	 bar	 bar	 bar	 gr/mt	 mm	 m
15	2,6	10	-	0,7	180	60	50
20	2,75	9	-	0,7	250	80	50
28	2	9	-	0,7	280	120	50
32	4	10	-	0,7	600	130	50
40	4	9	-	0,7	730	160	50
42	4	8	-	0,7	720	165	50
55	4	5	-	0,7	930	220	50



NORME NORMS:  
ISO 1307



-5°C / +60°C  
+23°F / +140°F

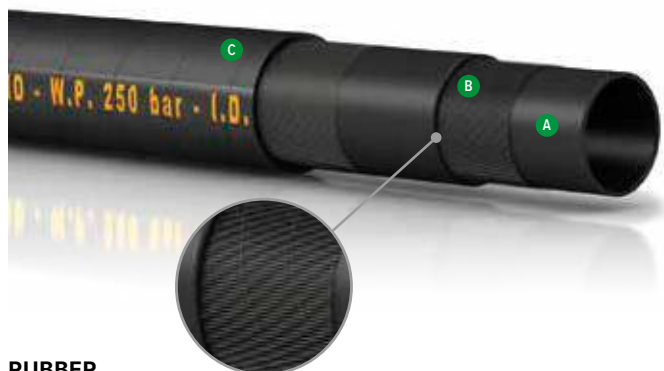

**RUBBER**



- **Per pulizie ad alta pressione.**  
For high pressure cleaning.
- **Fornibile già raccordato.**  
Available already with fittings.

**IMPIEGO APPLICATIONS**









Comunemente impiegato nelle pulizie ad alta pressione delle fognature, anche in condizioni d'impiego gravose.

For high pressure water cleaning and rinsing of sewage systems.



**STRUTTURA BODY**

<b>A</b>	<b>Sottostrato Tube</b>	Gomma speciale sintetica. Special synthetic rubber.
<b>B</b>	<b>Inseriti Reinforcement</b>	Inserzioni tessili ad alta tenacità. High tensile synthetic textile.
<b>C</b>	<b>Copertura Cover</b>	Gomma speciale sintetica, liscia, resistente all'abrasione, oli ed agli agenti atmosferici. Abrasion, oil and weather resistant smooth, special synthetic rubber.
	<b>Superficie Surface</b>	Liscia ad impressione tela. Smooth with fabric impression.

 mm	 mm	 bar	 bar	 bar	 gr/mt	 mm	 m
13	25	250	625	-	440	-	240
16	28	250	625	-	480	-	240
19	32	250	625	-	555	-	240
25	39	250	625	-	780	-	240
32	48	250	625	-	1060	-	200
38	54	250	625	-	1250	-	200

**NORME NORMS:**  
ISO 1307

**MARCATURA MARKING:**  
EUROCORD® WATER POWER HD - W.P. 250 BAR - I.D.

**CONFEZIONAMENTO BOX:**  
IMBALLO IN POLIETILENE NERO  
PACKAGING IN BLACK POLYETHYLENE

**-40°C / +50°C**  
**-40°F / +122°F**



### RUBBER



### IMPIEGO APPLICATIONS









Comunemente impiegato a corredo degli aspi nei veicoli antincendio.

For fire fighting vehicles.



### STRUTTURA BODY

<b>A</b>	<b>Sottostrato Tube</b>	Gomma naturale e sintetica. Natural and synthetic rubber.
<b>B</b>	<b>Inseriti Reinforcement</b>	Inserzioni tessili ad alta tenacità. High tensile synthetic textile.
<b>C</b>	<b>Copertura Cover</b>	Gomma sintetica resistente alla fiamma, all'abrasione, all'ozono, ed agli agenti atmosferici. Flame, abrasion, weather and ozone resistant synthetic rubber.
	<b>Superficie Surface</b>	Liscia ad impressione tela. Smooth with fabric impression.

 mm	 mm	 bar	 bar	 bar	 gr/mt	 mm	 m
12,7	21,5	40	120	-	315	120	40-46-61
19	32,5	40	120	-	715	190	40-46-61
25,4	39	40	120	-	870	200	40-46-61
32	45	40	120	-	975	280	40-46-61



**NORME NORMS:**  
ISO 1307

**MARCATURA MARKING:**  
EUROCORD® FIGHTING HOSE TS EN ISO 1947:201  
- 2 TYPE C

**CONFEZIONAMENTO BOX:**  
IMBALLO IN POLIETILENE NERO  
PACKAGING IN BLACK POLYETHYLENE



**-25°C / +70°C**  
**-13°F / +158°F**

# TUBI RETINATI PER IRRORAZIONE E GIARDINAGGIO

BRAIDED SPRAYING AND GARDENING  
PVC HOSES

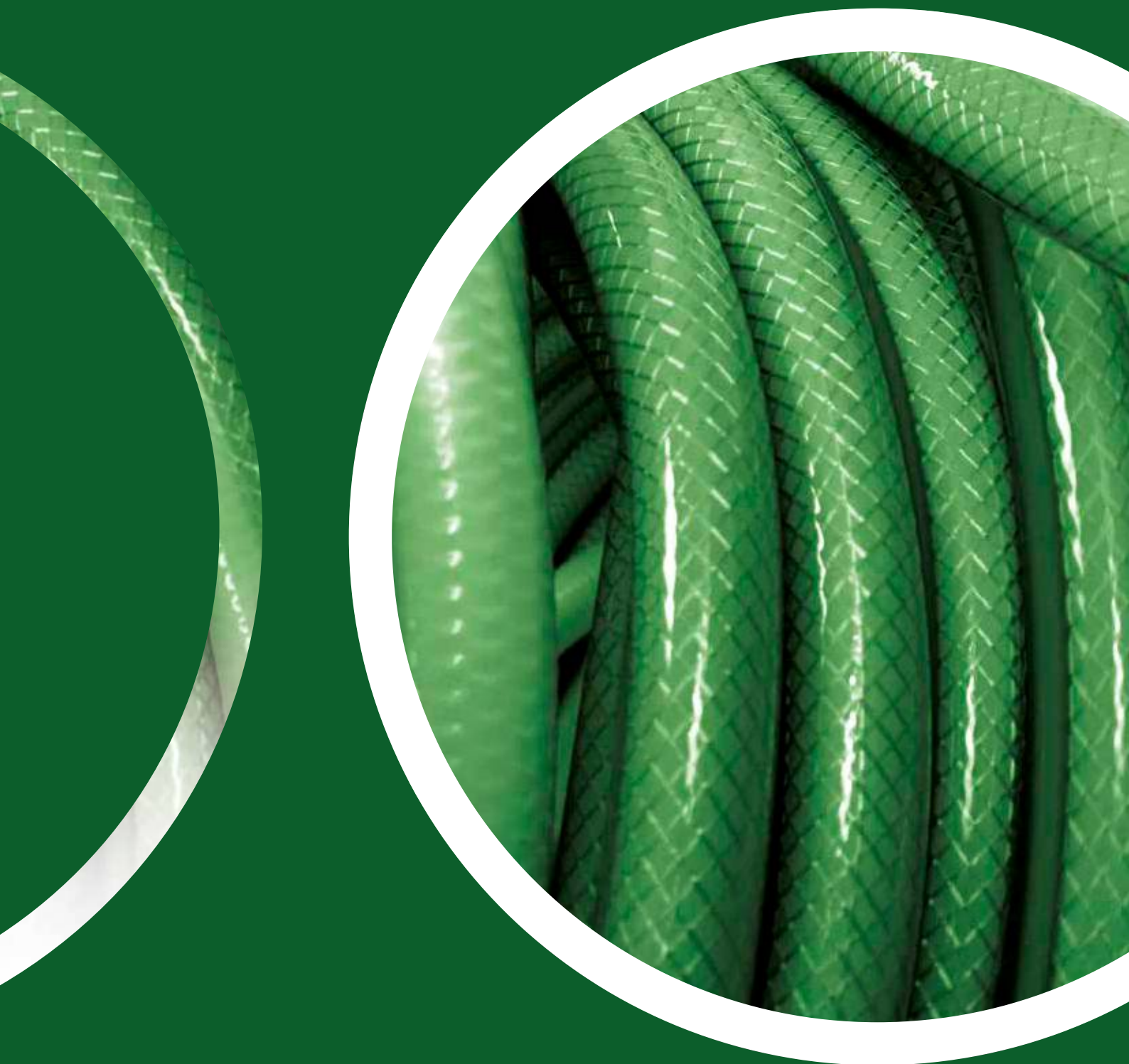



PVC



**IMPIEGO  
APPLICATIONS**

Idoneo alla mandata ad alta pressione di anticrittogamici e diserbanti. Buona resistenza agli agenti atmosferici. Particolarmente indicato a corredo di macchine atomizzatrici o pompe a mano.

Suitable for high pressure of pesticides and fertilizers in agriculture. Weather resistant. Ideal for spraying machines or hand pumps.



**STRUTTURA  
BODY**

<b>A</b> Sottostrato Tube	Nero in PVC resistente agli anticrittogamici. Special PVC compound resistant to pesticides and fertilizers.
<b>B</b> Inseriti Reinforcement	Tessili sintetici. High tensile synthetic textile.
<b>C</b> Copertura Cover	Liscia in PVC resistente all'abrasione, agenti atmosferici e ozono. Abrasion, ozone and weather resistant PVC.
Superficie Surface	Rosso - Nero con strip rossa. Red - Black with red strip.



**FASCETTE E COLLARI STRINGITUBO CONSIGLIATE  
RECOMMENDED CLAMP/COLLAR**

STF - Fascette a vite Hose clamps with screw (pag. 204-207)









SBS - Fascette bifilari a molla Double wire spring (pag. 217)

SGT - Fascette pinzabili Stepp less (pag. 216)



- Buona resistenza agli agenti atmosferici. Weather resistant.
- Ideale per atomizzatrici o pompe a mano. Perfect for spraying machines or hand pumps.



 mm	 mm	 bar	 bar	 bar	 gr/mt	 mm	 m
6	12	25	75	-	102	-	100
8	13	25	75	-	125	-	100
10	15	25	75	-	150	-	100
13	19	25	75	-	225	-	100
16	22	25	75	-	265	-	50
19	26	25	75	-	360	-	50



**NORME** NORMS:  
ISO 1307  
**MARCATURA** MARKING:  
FRUTTCORD 25 BAR (LOT)



**-10°C / +60°C**  
**+14°F / +140°F**

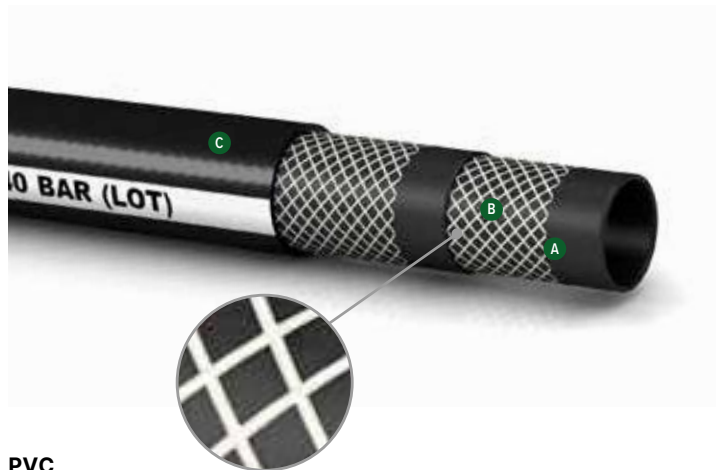

PVC



- **Buona resistenza agli agenti atmosferici.**  
Weather resistant.
- **Ideale per atomizzatrici o pompe a mano.**  
Perfect for spraying machines or hand pumps.

**IMPIEGO APPLICATIONS**

Idoneo alla mandata ad alta pressione di anticrittogamici e diserbanti. Buona resistenza agli agenti atmosferici. Particolarmente indicato a corredo di macchine atomizzatrici o pompe a mano.

Suitable for high pressure of pesticides and fertilizers in agriculture. Weather resistant. Ideal for spraying machines or hand pumps.



**STRUTTURA BODY**

<b>A</b>	<b>Sottostrato Tube</b>	Nero in PVC resistente agli anticrittogamici. Special PVC compound resistant to pesticides and fertilizers.
<b>B</b>	<b>Inserti Reinforcement</b>	Tessili sintetici. High tensile synthetic textile.
<b>C</b>	<b>Copertura Cover</b>	Liscia in PVC resistente all'abrasione, agenti atmosferici e ozono. Abrasion, ozone and weather resistant PVC.
	<b>Superficie Surface</b>	Nero con strip bianca. Black with white strip.

mm	mm	bar	bar	bar	gr/mt	mm	m
8	14	40	120	-	158	-	100
10	16	40	120	-	185	-	100
13	19	40	120	-	225	-	100
16	23	40	120	-	300	-	50
19	26	40	120	-	360	-	50
25	34	40	120	-	565	-	50
32	44	40	120	-	723	-	50

**FASCETTE E COLLARI STRINGITUBO CONSIGLIATE RECOMMENDED CLAMP/COLLAR**

- STF - Fascette a vite Hose clamps with screw (pag. 204-207)
- SGT - Fascette pinzabili Stepp less (pag. 216)



**NORME NORMS:**  
ISO 1307  
**MARCATURA MARKING:**  
FRUTTCORD 40 BAR (LOT)



**-10°C / +60°C**  
**+14°F / +140°F**



PVC



**IMPIEGO  
APPLICATIONS**

Idoneo alla mandata ad alta pressione di anticrittogamici e diserbanti. Buona resistenza agli agenti atmosferici. Particolarmente indicato a corredo di macchine atomizzatrici o pompe a mano.

Suitable for high pressure of pesticides and fertilizers in agriculture. Weather resistant. Ideal for spraying machines or hand pumps.



**STRUTTURA  
BODY**

<b>A</b> <b>Sottostrato Tube</b>	Nero in PVC resistente agli anticrittogamici. Special PVC compound resistant to pesticides and fertilizers.
<b>B</b> <b>Inserti Reinforcement</b>	Tessili sintetici. High tensile synthetic textile.
<b>C</b> <b>Copertura Cover</b>	Liscia in PVC resistente all'abrasione, agenti atmosferici e ozono. Abrasion, ozone and weather resistant PVC.
<b>Superficie Surface</b>	Blu scuro - Nero con strip blu scuro. Dark blue - Black with dark blue strip.











**FASCETTE E COLLARI STRINGITUBO CONSIGLIATE  
RECOMMENDED CLAMP/COLLAR**

STF - Fascette a vite Hose clamps with screw (pag. 204-207)  
SGT - Fascette pinzabili Stepp less (pag. 216)



- **Buona resistenza agli agenti atmosferici.**  
Weather resistant.
- **Ideale per atomizzatrici o pompe a mano.**  
Perfect for spraying machines or hand pumps.



 mm	 mm	 bar	 bar	 bar	 gr/mt	 mm	 m
8	14	40	120	-	158	-	100
10	16	40	120	-	185	-	100
13	19	40	120	-	225	-	100
16	23	40	120	-	300	-	50
19	26	40	120	-	360	-	50
25	34	40	120	-	565	-	50
32	44	40	120	-	723	-	50



**NORME NORMS:**  
ISO 1307  
**MARCATURA MARKING:**  
FRUTTCORD 40 BAR (LOT)



**-10°C / +60°C**  
**+14°F / +140°F**





PVC



- **Buona resistenza agli agenti atmosferici.**  
Weather resistant.
- **Ideale per atomizzatrici o pompe a mano.**  
Perfect for spraying machines or hand pumps.



**IMPIEGO APPLICATIONS**

Idoneo alla mandata ad alta pressione di anticrittogamici e diserbanti. Buona resistenza agli agenti atmosferici. Particolarmente indicato a corredo di macchine atomizzatrici o pompe a mano.

Suitable for high pressure of pesticides and fertilizers in agriculture. Weather resistant. Ideal for spraying machines or hand pumps.

**STRUTTURA BODY**

<b>A</b>	<b>Sottostrato Tube</b>	Nero in PVC resistente agli anticrittogamici. Special PVC compound resistant to pesticides and fertilizers.
<b>B</b>	<b>Inserti Reinforcement</b>	Tessili sintetici. High tensile synthetic textile.
<b>C</b>	<b>Copertura Cover</b>	Liscia in PVC resistente all'abrasione, agenti atmosferici e ozono. Abrasion, ozone and weather resistant PVC.
	<b>Superficie Surface</b>	Beige - Nero con strip beige. Beige - Black with beige strip.

8	14,5	50	150	-	175	-	100
10	17	50	100	-	217	-	100

**FASCETTE E COLLARI STRINGITUBO CONSIGLIATE RECOMMENDED CLAMP/COLLAR**

- STF - Fascette a vite Hose clamps with screw (pag. 204-207)
- SGT - Fascette pinzabili Stepp less (pag. 216)



**NORME NORMS:**  
ISO 1307  
**MARCATURA MARKING:**  
FRUCCORD 50 BAR (LOT)



**-10°C / +60°C**  
**+14°F / +140°F**



PVC



**IMPIEGO  
APPLICATIONS**

Idoneo alla mandata ad alta pressione di anticrittogamici e diserbanti. Buona resistenza agli agenti atmosferici. Particolarmente indicato a corredo di macchine atomizzatrici o pompe a mano.

Suitable for high pressure of pesticides and fertilizers in agriculture. Weather resistant. Ideal for spraying machines or hand pumps.



**STRUTTURA  
BODY**

<b>A</b> Sottostrato Tube	Nero in PVC resistente agli anticrittogamici. Special PVC compound resistant to pesticides and fertilizers.
<b>B</b> Inserti Reinforcement	Tessili sintetici. High tensile synthetic textile.
<b>C</b> Copertura Cover	Liscia in PVC resistente all'abrasione, agenti atmosferici e ozono. Abrasion, ozone and weather resistant PVC.
<b>Superficie Surface</b>	Verde scuro - Nero con strip verde scuro. Dark green - Black with dark green strip.











**FASCETTE E COLLARI STRINGITUBO CONSIGLIATE  
RECOMMENDED CLAMP/COLLAR**

STF - Fascette a vite Hose clamps with screw (pag. 204-207)  
SGT - Fascette pinzabili Stepp less (pag. 216)



- Buona resistenza agli agenti atmosferici. Weather resistant.
- Ideale per atomizzatrici o pompe a mano. Perfect for spraying machines or hand pumps.



 mm	 mm	 bar	 bar	 bar	 gr/mt	 mm	 m
8	15	80	200	-	185	-	100
10	18	80	200	-	245	-	100
13	22	80	200	-	260	-	100
16	25	80	160	-	402	-	50
19	29	80	160	-	580	-	50



**NORME NORMS:**  
ISO 1307  
**MARCATURA MARKING:**  
FRUTTCORD 80 BAR (LOT)



**-10°C / +60°C  
+14°F / +140°F**



PVC



- **Buona resistenza agli agenti atmosferici.**  
Weather resistant.
- **Ideale per atomizzatrici o pompe a mano.**  
Perfect for spraying machines or hand pumps.

**IMPIEGO APPLICATIONS**

Idoneo alla mandata ad alta pressione di anticrittogamici e diserbanti. Buona resistenza agli agenti atmosferici. Particolarmente indicato a corredo di macchine atomizzatrici o pompe a mano.

Suitable for high pressure of pesticides and fertilizers in agriculture. Weather resistant. Ideal for spraying machines or hand pumps.



**STRUTTURA BODY**

<b>A</b> Sottostrato Tube	Nero in PVC resistente agli anticrittogamici. Special PVC compound resistant to pesticides and fertilizers.
<b>B</b> Inseriti Reinforcement	Tessili sintetici. High tensile synthetic textile.
<b>C</b> Copertura Cover	Liscia in PVC resistente all'abrasione, agenti atmosferici e ozono. Abrasion, ozone and weather resistant PVC.
Superficie Surface	Blu scuro - Nero con strip blu scuro. Dark blue - Black with dark blue strip.

mm	mm	bar	bar	bar	gr/mt	mm	m
8	16	100	300	-	211	-	100
10	19	100	300	-	284	-	100
13	23	100	300	-	392	-	100

**FASCETTE E COLLARI STRINGITUBO CONSIGLIATE RECOMMENDED CLAMP/COLLAR**

STF - Fascette a vite Hose clamps with screw (pag. 204-207)  
SGT - Fascette pinzabili Stepp less (pag. 216)



**NORME NORMS:**  
ISO 1307

**MARCATURA MARKING:**  
FRUTTCORD 100 BAR (LOT)

**-10°C / +60°C**  
**+14°F / +140°F**

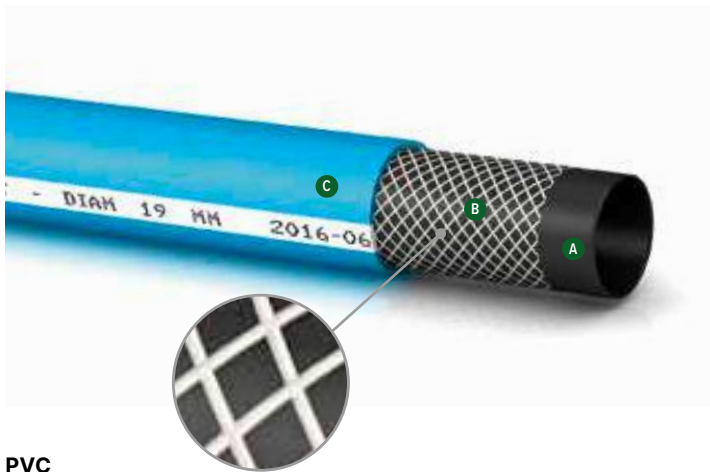

- **Estrema resistenza morbidezza e flessibilità.**  
Extremely resistance, softness and flexibility.

PVC



**IMPIEGO  
APPLICATIONS**

Tubo per giardinaggio con prestazioni eccezionali. Il particolare posizionamento degli inserti tessili tra la copertura e il sottostrato non permette al tubo di annodarsi o attorcigliarsi. Indicato nell'industria edile, cantieristica, navale, per agricoltura e floricoltura.

Gardening hose with outstanding performances. The position of the high synthetic textile reinforcement between the cover and the sub layer doesn't permit the kinking of the hose. Suitable for the construction, marine, agricultural and flower growing industries.



**STRUTTURA  
BODY**

<b>A</b>	<b>Sottostrato Tube</b>	PVC nero. Black plasticized PVC.
<b>B</b>	<b>Inserti Reinforcement</b>	Tessili sintetici. High tensile synthetic textile.
<b>C</b>	<b>Copertura Cover</b>	Liscia in PVC resistente all'abrasione, agenti atmosferici e ozono. Abrasion. ozone and weather resistant PVC.
	<b>Superficie Surface</b>	Azzurra con strip bianca. Light blue with white strip.



**FASCETTE E COLLARI STRINGITUBO CONSIGLIATE  
RECOMMENDED CLAMP/COLLAR**

STF - Fascette a vite Hose clamps with screw (pag. 204-207)



mm	mm	bar	bar	bar	gr/mt	mm	m
13	2,5	10	26	-	140	-	15/25/50
16	2,6	10	23	-	180	-	15/25/50
19	3,0	10	21	-	250	-	15/25/50
25	3,3	10	17	-	370	-	15/25/50



NORME NORMS:  
ISO 1307



-5°C / +60°C  
+23°F / +140°F

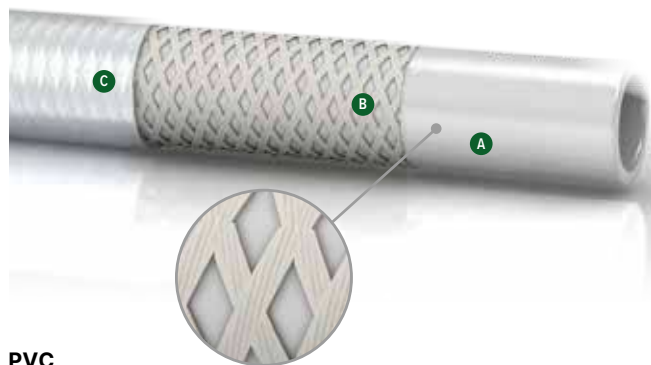

PVC



- **Anti-macchia.**  
Stain resistant.

**IMPIEGO**  
**APPLICATIONS**

Tubo per giardinaggio. Estremamente robusto e flessibile. Particolarmente indicato nell'industria e cantieristica navale, in quanto anti-macchia.

Gardening, irrigation and general water discharge.



**STRUTTURA**  
**BODY**

<b>A</b>	<b>Sottostrato Tube</b>	PVC bianco. White PVC.
<b>B</b>	<b>Inserti Reinforcement</b>	Tessili sintetici. High tensile synthetic textile.
<b>C</b>	<b>Copertura Cover</b>	Liscia in PVC resistente all'abrasione, agenti atmosferici e ozono. Abrasion, ozone and weather resistant PVC.
	<b>Superficie Surface</b>	Bianca. White plasticized PVC.

mm	mm	bar	bar	bar	gr/mt	mm	m
10	2,5	10	30	-	110	-	25/50
13	2,8	10	32	-	170	-	25/50
16	2,8	10	32	-	200	-	25/50
19	3,0	10	32	-	260	-	25/50
22	3,0	10	21	-	300	-	25/50
25	3,5	10	32	-	420	-	25/50
30	4,0	5	15	-	529	-	25/50

**FASCETTE E COLLARI STRINGITUBO CONSIGLIATE**  
**RECOMMENDED CLAMP/COLLAR**

STF - Fascette a vite Hose clamps with screw (pag. 204-207)



NORME NORMS:  
ISO 1307



-5°C / +60°C  
+23°F / +140°F

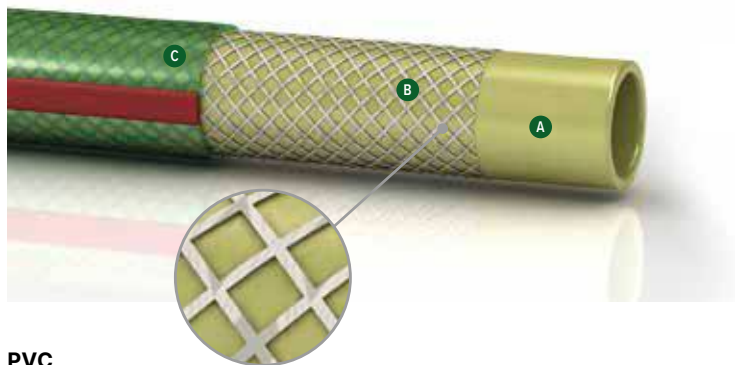

**PVC**



**IMPIEGO  
APPLICATIONS**

Tubo per giardinaggio. Estremamente robusto e flessibile. Particolarmente indicato nell'industria cantieristica, navale ed edile.

Gardening hose. Extremely strong and flexible. Suitable for the marine and construction industries.



**STRUTTURA  
BODY**









<b>A</b>	<b>Sottostrato Tube</b>	PVC giallo. Yellow plasticized PVC.
<b>B</b>	<b>Inserti Reinforcement</b>	Tessili sintetici. High tensile synthetic textile.
<b>C</b>	<b>Copertura Cover</b>	Liscia in PVC resistente all'abrasione, agenti atmosferici e ozono. Abrasion, ozone and weather resistant PVC.
	<b>Superficie Surface</b>	Verde con banda rossa. Green with red strip.



**FASCETTE E COLLARI STRINGITUBO CONSIGLIATE  
RECOMMENDED CLAMP/COLLAR**

STF - Fascette a vite Hose clamps with screw (pag. 204-207)



 mm	 mm	 bar	 bar	 bar	 gr/mt	 mm	 m
10	2,5	10	30	-	110	-	25/50
13	2,8	10	32	-	170	-	25/50
16	2,8	10	32	-	200	-	25/50
19	3	10	32	-	260	-	25/50
22	3	10	21	-	300	-	25/50
25	3,5	10	32	-	420	-	25/50
30	4	5	15	-	529	-	25/50



**NORME NORMS:**  
ISO 1307



**-5°C / +60°C**  
**+23°F / +140°F**

# TUBI PER ARIA COMPRESSA

COMPRESSED AIR HOSES

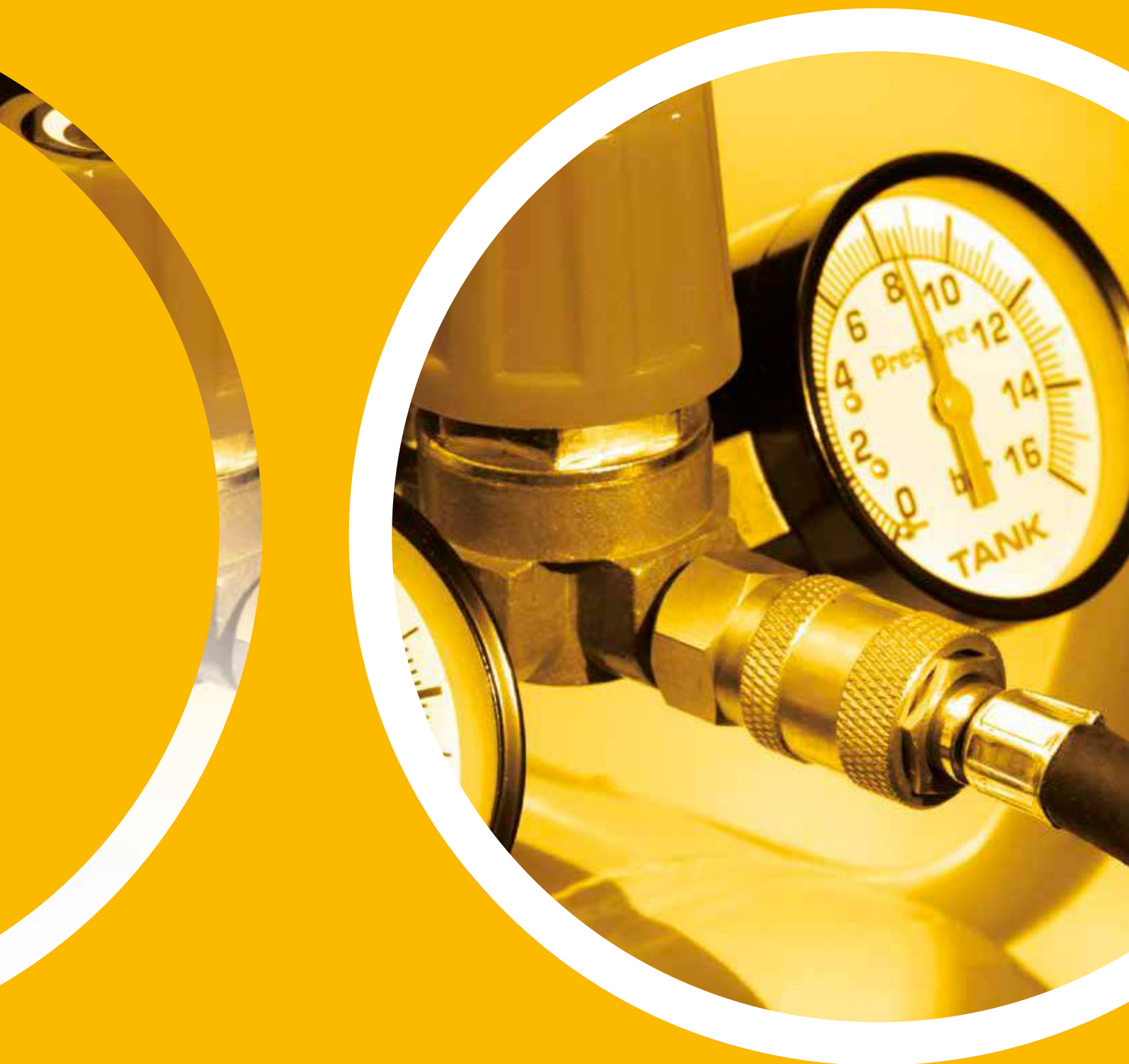



## RUBBER



### IMPIEGO APPLICATIONS

Per mandata di aria compressa, acqua e liquidi non corrosivi, ove siano richiesti caratteristiche di leggerezza e flessibilità. Impiegato in molti usi agricoli ed industriali.

Medium duty service for air and pneumatic tools specially in industrial and agriculture applications.



### STRUTTURA BODY

<b>A</b>	<b>Sottostrato Tube</b>	Liscio in gomma SBR di colore nero. Natural and synthetic black rubber.
<b>B</b>	<b>Inserti Reinforcement</b>	Tessili sintetici. High tensile synthetic textile.
<b>C</b>	<b>Copertura Cover</b>	Liscia in gomma SBR/EPDM di colore nero resistente all'abrasione e agli agenti atmosferici. Abrasion, ozone and weather resistant smooth natural and synthetic rubber.
	<b>Superficie Surface</b>	Liscia. Smooth.



### FASCETTE E COLLARI STRINGITUBO CONSIGLIATE RECOMMENDED CLAMP/COLLAR

STF - Fascette a vite Hose clamps with screw (pag. 204-207)

SGT - Fascette pinzabili Stepp less (pag. 216)



mm	mm	bar	bar	bar	gr/mt	mm	m
6	14	20	60	-	190	60	100
7	16	20	60	-	245	70	100
8	17	20	60	-	265	80	100
10	19	20	60	-	310	100	100
13	23	20	60	-	425	130	100
16	26	20	60	-	495	160	50
19	30	20	60	-	635	190	50
25	37	20	60	-	800	250	50



**NORME NORMS:**  
ISO 1307

**MARCATURA MARKING:**  
EUROCORD® RUBBER HOSE W.P. 20 BAR ISO 1307

**CONFEZIONAMENTO BOX:**  
IMBALLO IN POLIETILENE GIALLO  
PACKAGING IN YELLOW POLYETHYLENE



**-25°C / +70°C**  
**-13°F / +158°F**



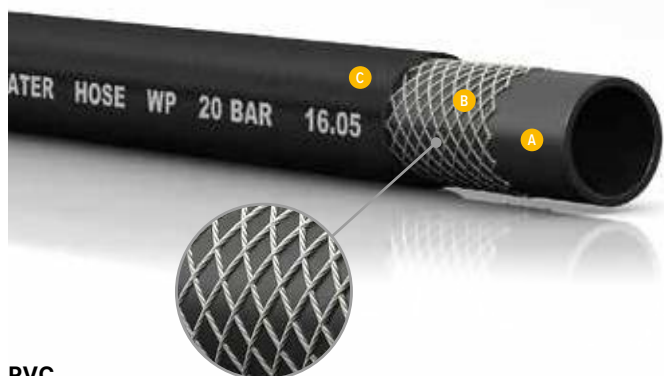

PVC



- **Massima leggerezza.**  
Maximum lightness.

**IMPIEGO APPLICATIONS**

Idoneo alla mandata di acqua ed aria compressa ove siano richieste caratteristiche di leggerezza e flessibilità. Particolarmente indicato in agricoltura, nell'industria edile, cantieristica e navale.

Medium duty service for air and pneumatic tools specially in industrial and agriculture applications.



**STRUTTURA BODY**

<b>A</b>	<b>Sottostrato Tube</b>	Liscio in PVC di colore nero. Special PVC resistant compound.
<b>B</b>	<b>Inserti Reinforcement</b>	Tessili sintetici. High tensile synthetic textile.
<b>C</b>	<b>Copertura Cover</b>	Liscia in PVC di colore nero resistente all'abrasione e agli agenti atmosferici. Abrasion and weather resistant special thermorub compound.
	<b>Superficie Surface</b>	Nero. Black.

mm	mm	bar	bar	bar	gr/mt	mm	m
6	14	20	60	-	189	-	100
8	17	20	60	-	266	-	100
10	19	20	60	-	308	-	100
13	23	20	60	-	423	-	100
16	26	20	60	-	495	-	50
19	30	20	60	-	636	-	50
25	37	20	60	-	780	-	50

**FASCETTE E COLLARI STRINGITUBO CONSIGLIATE RECOMMENDED CLAMP/COLLAR**

STF - Fascette a vite Hose clamps with screw (pag. 204-207)

SGT - Fascette pinzabili Stepp less (pag. 216)



**NORME NORMS:**  
ISO 1307

**-10°C / +60°C**  
**+14°F / +140°F**

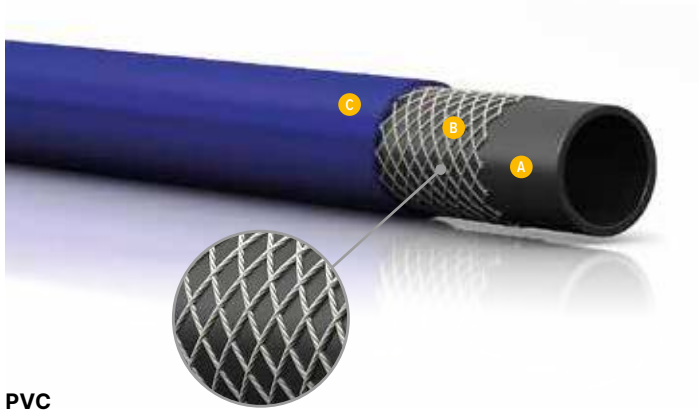

PVC



**IMPIEGO  
APPLICATIONS**

Idoneo alla mandata di acqua ed aria compressa ove siano richieste caratteristiche di leggerezza e flessibilità. Particolarmente indicato in agricoltura, nell'industria edile, cantieristica e navale.

Suitable for the water and air compressed delivery where it is necessary lightness and flexibility. Ideal for the industrial, agricultural, construction and marine industries.



**STRUTTURA  
BODY**

<b>A</b>	<b>Sottostrato Tube</b>	Liscio in PU di colore nero. Smooth black PU compound.
<b>B</b>	<b>Inserti Reinforcement</b>	Tessili sintetici. High tensile synthetic textile.
<b>C</b>	<b>Copertura Cover</b>	Liscia in PVC di colore blu resistente all'abrasione e agli agenti atmosferici. Abrasion, ozone and weather resistant PVC compound.
	<b>Superficie Surface</b>	Blu. Blue.











**FASCETTE E COLLARI STRINGITUBO CONSIGLIATE  
RECOMMENDED CLAMP/COLLAR**

STF - Fascette a vite Hose clamps with screw (pag. 204-207)  
SGT - Fascette pinzabili Stepp less (pag. 216)



- **Speciale miscela in poliuretano antiabrasivo e PVC.**  
Special anti abrasive polyuretane compound and PVC.



 mm	 mm	 bar	 bar	 bar	 gr/mt	 mm	 m
6	10	20	60	-	70	-	100
8	12	20	60	-	85	-	100
10	15	20	60	-	135	-	100
13	19	20	60	-	195	-	100



NORME NORMS:  
ISO 1307



-10°C / +60°C  
+14°F / +140°F

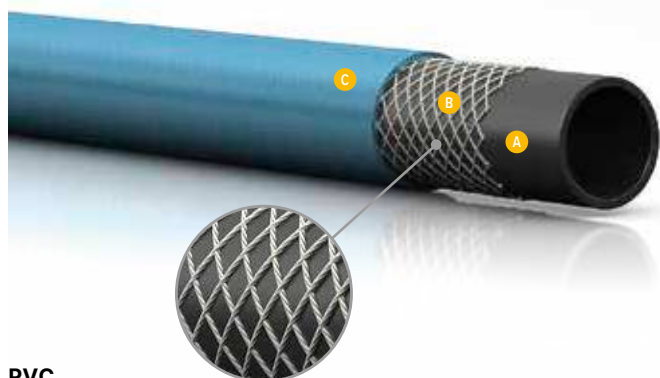

PVC

**IMPIEGO APPLICATIONS**

Idoneo alla mandata di acqua ed aria compressa ove siano richieste caratteristiche di leggerezza e flessibilità. Particolarmente indicato in agricoltura, nell'industria edile, cantieristica e navale.

Suitable for the water and air compressed delivery where it is necessary lightness and flexibility. Ideal for the industrial, agricultural, construction and marine industries.



**STRUTTURA BODY**

<b>A</b>	<b>Sottostrato</b> Tube	Mescola termoplastica di colore nero. Special thermorub compound.
<b>B</b>	<b>Inserti</b> Reinforcement	Tessili sintetici. High tensile synthetic textile.
<b>C</b>	<b>Copertura</b> Cover	Mescola termoplastica di colore blu. Abrasion, weather and oil resistant special thermorub compound.
	<b>Superficie</b> Surface	Blu chiaro. Light blue.

mm	mm	bar	bar	bar	gr/mt	mm	m
6	12	25	75	-	110	-	100
8	13	25	75	-	108	-	100
10	15	25	75	-	129	-	100
13	19	25	75	-	195	-	100

**FASCETTE E COLLARI STRINGITUBO CONSIGLIATE RECOMMENDED CLAMP/COLLAR**

STF - Fascette a vite Hose clamps with screw (pag. 204-207)  
SGT - Fascette pinzabili Stepp less (pag. 216)



**NORME NORMS:**  
ISO 1307

**-10°C / +60°C**  
**+14°F / +140°F**



**RUBBER**



**IMPIEGO APPLICATIONS**

Idoneo alla mandata di aria a corredo di compressori, attrezzature di perforazione e macchine operatrici pneumatiche in genere. Particolarmente utilizzato in cantieri edili, nelle cave e miniere.

Suitable for the air delivery of compressors, and pneumatic tools. Ideal for building sites, caves or mines.



**STRUTTURA BODY**

<b>A</b>	<b>Sottostrato Tube</b>	Gomma SBR di colore nero. Natural and synthetic rubber.
<b>B</b>	<b>Inserti Reinforcement</b>	Tessili sintetici. High tensile synthetic textile.
<b>C</b>	<b>Copertura Cover</b>	Gomma SBR/EPDM resistente all'abrasione agli agenti atmosferici e all'invecchiamento. Abrasion, ozone and weather resistant synthetic rubber.
	<b>Superficie Surface</b>	Liscia ad impressione tela. Smooth with fabric impression.











**FASCETTE E COLLARI STRINGITUBO CONSIGLIATE RECOMMENDED CLAMP/COLLAR**

STF - Fascette a vite Hose clamps with screw (pag. 204-207)

STC - Fascette con bullone Hose clamps with bolt (pag. 208-210)



 mm	 mm	 bar	 bar	 bar	 gr/mt	 mm	 m
8	17	20	60	-	247	80	40
10	19	20	60	-	286	100	40
13	23	20	60	-	397	130	40
16	26	20	60	-	435	160	40
19	30	20	60	-	550	190	40
25	37	20	60	-	757	250	40



**NORME NORMS:**  
ISO 1307

**MARCATURA MARKING:**  
EUROCORD® AIR COMPRESSED HOSE W.P. 20 BAR

**CONFEZIONAMENTO BOX:**  
IMBALLO IN POLIETILENE GIALLO  
PACKAGING IN YELLOW POLYETHYLENE



**-25°C / +70°C**  
**-13°F / +158°F**



**RUBBER**

**IMPIEGO APPLICATIONS**

Idoneo alla mandata di aria a corredo di compressori, attrezzature di perforazione e macchine operatrici pneumatiche in genere. Particolarmente utilizzato in cantieri edili, nelle cave e miniere.

Suitable for the air delivery of compressors, and pneumatic tools. Ideal for building sites, caves or mines.



**STRUTTURA BODY**

<b>A</b>	<b>Sottostrato Tube</b>	Gomma SBR di colore nero. Natural and synthetic rubber.
<b>B</b>	<b>Inserti Reinforcement</b>	Tessili sintetici. High tensile synthetic textile.
<b>C</b>	<b>Copertura Cover</b>	Gomma SBR/EPDM resistente all'abrasione agli agenti atmosferici e all'invecchiamento. Abrasion, ozone and weather resistant synthetic rubber.
	<b>Superficie Surface</b>	Liscia ad impressione tela. Smooth with fabric impression.

mm	mm	bar	bar	bar	gr/mt	mm	m
19	32	25	75	-	695	190	40
25	39	25	75	-	929	250	40
32	48	25	75	-	1423	320	40
38	54	25	75	-	1570	380	40
40	56	25	75	-	1630	400	40
50	69	25	75	-	2333	510	40
60	83	25	75	-	3637	600	40
76	96	25	75	-	3766	760	40

**FASCETTE E COLLARI STRINGITUBO CONSIGLIATE RECOMMENDED CLAMP/COLLAR**

STF - Fascette a vite Hose clamps with screw (pag. 204-207)  
STC - Fascette con bullone Hose clamps with bolt (pag. 208-210)



**NORME NORMS:**  
ISO 1307  
**MARCATURA MARKING:**  
EUROCORD® AIR COMPRESSED HOSE W.P. 25 BAR  
**CONFEZIONAMENTO BOX:**  
IMBALLO IN POLIETILENE GIALLO  
PACKAGING IN YELLOW POLYETHYLENE

**-25°C / +70°C**  
**-13°F / +158°F**



**RUBBER**



**IMPIEGO  
APPLICATIONS**

Idoneo alla mandata di aria a corredo di compressori, attrezzature di perforazione e macchine operatrici pneumatiche in genere. Particolarmente utilizzato in cantieri edili, nelle cave e miniere.

Suitable for the air delivery of compressors, and pneumatic tools. Ideal for building sites, caves or mines.



**STRUTTURA  
BODY**









<b>A</b>	<b>Sottostrato Tube</b>	Gomma NBR di colore nero idoneo alla mandata di aria e olio nebulizzato. Synthetic NBR rubber, resistant to high pressure and inert fluids.
<b>B</b>	<b>Inseriti Reinforcement</b>	Inserzioni in acciaio ad alta resistenza. High tensile synthetic textile.
<b>C</b>	<b>Copertura Cover</b>	Gomma sintetica microforata resistente all'abrasione, agenti atmosferici e all'invecchiamento. Abrasion, ozone and weather resistant synthetic rubber.
	<b>Superficie Surface</b>	Liscia ad impressione tela. Smooth with fabric impression.



**FASCETTE E COLLARI STRINGITUBO CONSIGLIATE  
RECOMMENDED CLAMP/COLLAR**

STF - Fascette a vite Hose clamps with screw (pag. 204-207)  
STC - Fascette con bullone Hose clamps with bolt (pag. 208-210)



 mm	 mm	 bar	 bar	 bar	 gr/mt	 mm	 m
12,7	23	40	160	-	640	153	40
19	30	40	160	-	666	228	40
25,4	36	40	160	-	884	305	40
32	43	40	160	-	1138	384	40
38	50	40	160	-	1600	456	40
51	66	40	160	-	2450	612	40
63,5	80	35	140	-	3560	762	40
76,2	94	30	120	-	4740	915	40
102	122	30	120	-	6232	1219	40



**NORME NORMS:**  
ISO 1307  
**MARCATURA MARKING:**  
EUROCORD® AIR COMPRESSED HOSE W.P. 40 BAR  
**CONFEZIONAMENTO BOX:**  
IMBALLO IN POLIETILENE GIALLO  
PACKAGING IN YELLOW POLYETHYLENE



**-25°C / +70°C**  
**-13°F / +158°F**

# TUBI PER OLI E CARBURANTI

OIL AND FUEL HOSES



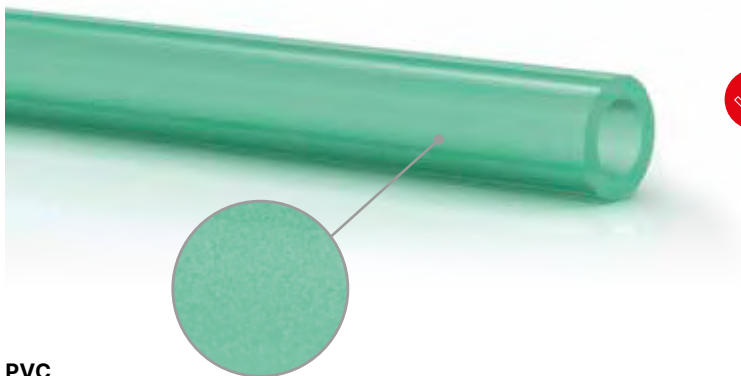

PVC



• **Fornibile su rocchetto.**  
Available also on reel.



**IMPIEGO**  
**APPLICATIONS**

Idoneo per mandata di oli minerali, carburanti e benzina verde, lubrificazione ed ingranaggio di macchinari; particolarmente indicato ove siano richieste caratteristiche di leggerezza e flessibilità.

Suitable for delivery of mineral oils, fuels, lubricant and machinery gear; particularly suitable where they are required of lightness and flexibility characteristics.



**STRUTTURA**  
**BODY**

<b>A</b>	<b>Sottostrato Tube</b>	PVC trasparente verde. Transparent green PVC.
<b>B</b>	<b>Inserti Reinforcement</b>	---
<b>C</b>	<b>Copertura Cover</b>	Liscia ad impressione tela. Smooth with fabric impression.
	<b>Superficie Surface</b>	Verde trasparente. Transparent green PVC.









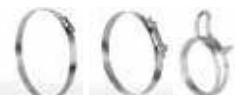

**FASCETTE E COLLARI STRINGITUBO CONSIGLIATE**  
**RECOMMENDED CLAMP/COLLAR**

STF - Fascette a vite Hose clamps with screw (pag. 204-207)

SGT - Fascette pinzabili Stepp less (pag. 216)

SBS - Fascette bifilari a molla Double wire spring (pag. 217)



 mm	 mm	 bar	 bar	 bar	 gr/mt	 mm	 m
4	7	5	15	-	31	-	25
5	9	5	15	-	53	-	25
7	12	5	15	-	91	-	25
8	13	5	15	-	100	-	25
9	14	5	15	-	111	-	25
10	15	4	12	-	120	-	25



NORME NORMS:  
ISO 1307



-5°C / +60°C  
+23°F / +140°F





**RUBBER**



- **Resistente ad oli e carburanti con contenuti di aromatici fino al 40%**  
Oils and fuels with 40% aromatic contents resistant.
- **Fornibile su rocchetto.**  
Available also on reel.



**IMPIEGO APPLICATIONS**

Idoneo per mandata di carburanti nei motori a combustione interna, lubrificazione ed ingrassaggio di macchinari; particolarmente indicato ove siano richieste caratteristiche di leggerezza e flessibilità.

For delivery of fuels in internal combustion engines for lubrication and greasing services. Particularly recommended where it is necessary flexibility and lightness.



**STRUTTURA BODY**

<b>A</b>	<b>Sottostrato Tube</b>	Liscio in gomma NBR di colore nero resistente ad oli e carburanti con contenuto di aromatici fino al 40%. Natural and synthetic black rubber.
<b>B</b>	<b>Inserti Reinforcement</b>	Tessili sintetici. High tensile synthetic textile.
<b>C</b>	<b>Copertura Cover</b>	Liscia in gomma NBR resistente ad oli e carburanti. Oil and Diesel resistant smooth synthetic rubber.
	<b>Superficie Surface</b>	Liscia. Smooth.

mm	mm	bar	bar	bar	gr/mt	mm	m
4	9	10	30	-	70	40	100
5	12	10	30	-	124	50	100
6	12	10	30	-	113	60	100
8	15	10	30	-	169	80	100
10	17	10	30	-	198	100	100
13	20	10	30	-	244	130	100
15	23	10	30	-	321	150	50
19	27	10	30	-	389	190	50
25	35	10	30	-	630	250	50

**FASCETTE E COLLARI STRINGITUBO CONSIGLIATE RECOMMENDED CLAMP/COLLAR**

STF - Fascette a vite Hose clamps with screw (pag. 204-207)

STM - Fascette stringitubo Hose clamps (pag. 213)

SGT - Fascette pinzabili Stepp less (pag. 216)



**NORME NORMS:**  
ISO 1307  
**MARCATURA MARKING:**  
EUROCORD® OIL RUBBER HOSE P.E. 10 BAR - ISO 1307  
**CONFEZIONAMENTO BOX:**  
IMBALLO IN POLIETILENE ROSSO  
PACKAGING IN RED POLYETHYLENE



**-35°C / +70°C**  
**-31°F / +158°F**



**RUBBER**



**IMPIEGO  
APPLICATIONS**

Idoneo per mandata di carburanti nei motori a combustione interna, lubrificazione ed ingrassaggio di macchinari; particolarmente indicato ove siano richieste caratteristiche di leggerezza e flessibilità.

For delivery of fuels in internal combustion engines for lubrication and greasing services. Particularly recommended where it is necessary flexibility and lightness.











- **Resistente ad oli e carburanti con contenuti di aromatici fino al 40%**  
Oils and fuels with 40% aromatic contents resistant.



**STRUTTURA  
BODY**

<b>A</b>	<b>Sottostrato Tube</b>	Liscia in gomma NBR di colore nero resistente ad oli e carburanti con contenuto di aromatici fino al 40%. Natural and synthetic black rubber.
<b>B</b>	<b>Inserti Reinforcement</b>	Tessili sintetici. High tensile synthetic textile.
<b>C</b>	<b>Copertura Cover</b>	Liscia in gomma NBR resistente ad oli e carburanti. Oil and Diesel resistant smooth synthetic rubber.
	<b>Superficie Surface</b>	Liscia. Smooth.

 mm	 mm	 bar	 bar	 bar	 gr/mt	 mm	 m
6	14	20	60	-	168	60	100
8	17	20	60	-	237	80	100
10	19	20	60	-	275	100	100



**FASCETTE E COLLARI STRINGITUBO CONSIGLIATE  
RECOMMENDED CLAMP/COLLAR**

STF - Fascette a vite Hose clamps with screw (pag. 204-207)

STM - Fascette stringitubo Hose clamps (pag. 213)

SGT - Fascette pinzabili Stepp less (pag. 216)



**NORME** NORMS: ISO 1307  
**MARCATURA** MARKING:  
EUROCORD® OIL RUBBER HOSE P.E. 20 BAR - ISO 1307  
**CONFEZIONAMENTO** BOX:  
IMBALLO IN POLIETILENE ROSSO  
PACKAGING IN RED POLYETHYLENE



**-35°C / +70°C**  
**-31°F / +158°F**



**RUBBER**



- **Resistente ad oli e carburanti con contenuti di aromatici fino al 40%**  
Oils and fuels with 40% aromatic contents resistant.

**IMPIEGO APPLICATIONS**

Idoneo per mandata di carburanti nei motori a combustione interna, lubrificazione ed ingrassaggio di macchinari; particolarmente indicato ove siano richieste caratteristiche di leggerezza e flessibilità.

For delivery of fuels in internal combustion engines for lubrication and greasing services. Particularly recommended where it is necessary flexibility and lightness.



**STRUTTURA BODY**

<b>A</b> Sottostrato Tube	Liscia in gomma NBR di colore nero resistente ad oli e carburanti con contenuto di aromatici fino al 40%. Fuel and oil resistant, smooth nbr rubber.
<b>B</b> Inserti Reinforcement	Tessili sintetici. High tensile synthetic textile.
<b>C</b> Copertura Cover	Liscia in gomma NBR resistente ad oli e carburanti. Abrasion, ozone, weather and oil resistant special synthetic rubber.
Superficie Surface	Liscia. Smooth.

mm	mm	bar	bar	bar	gr/mt	mm	m
6	14	25	75	-	168	120	100
8	16	25	75	-	228	180	100
10	18	25	75	-	275	100	100
13	21	25	75	-	300	130	50
16	25	25	75	-	392	160	50
19	29	25	75	-	490	190	50
25	36	25	75	-	539	210	50

**FASCETTE E COLLARI STRINGITUBO CONSIGLIATE RECOMMENDED CLAMP/COLLAR**

STF - Fascette a vite Hose clamps with screw (pag. 204-207)

STM - Fascette stringitubo Hose clamps (pag. 213)

SGT - Fascette pinzabili Stepp less (pag. 216)



**NORME NORMS:**  
ISO 1307  
**MARCATURA MARKING:**  
EUROCORD® OIL RUBBER HOSE P.E. 25 BAR - ISO 1307  
**CONFEZIONAMENTO BOX:**  
IMBALLO IN POLIETILENE ROSSO  
PACKAGING IN RED POLYETHYLENE



**-35°C / +70°C**  
**-31°F / +158°F**

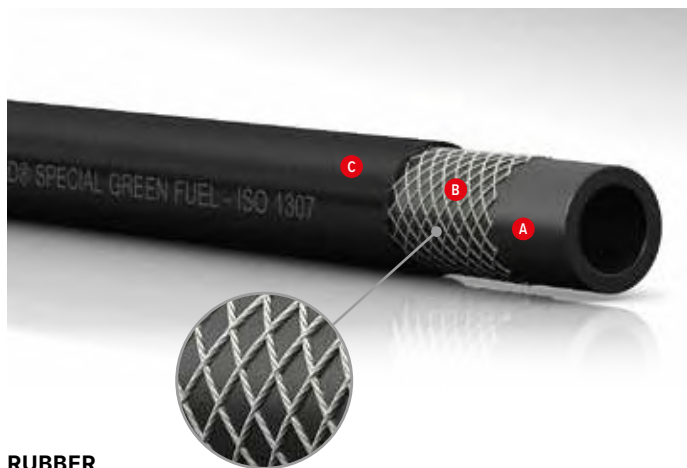

**RUBBER**



**IMPIEGO  
APPLICATIONS**

Per mandata di carburanti, gasolio, benzine senza piombo, eco diesel e lubrificanti in generale. Utilizzato sui motori a combustione interna delle autovetture, degli autoveicoli industriali, dei trattori e dei motori marini.

For delivery of fuels, diesel & fuel, unleaded petrol fuels, eco diesel and lubricants in general. Used for the cars, industrial vehicles, tractors and marine motors combustion engines.



**STRUTTURA  
BODY**

<b>A</b> <b>Sottostrato Tube</b>	Liscio in gomma nera NBR resistente agli oli minerali, ai carburanti con contenuto aromatico non superiore al 50% e alle benzine senza piombo con contenuto di MTBE non superiore al 5%. Fuel and oil resistant, smooth NBR rubber.
<b>B</b> <b>Inseriti Reinforcement</b>	Tessili sintetici. High tensile synthetic textile.
<b>C</b> <b>Copertura Cover</b>	Gomma nera (CR/NBR) resistente ai lubrificanti, ai carburanti all'abrasione ed agli agenti atmosferici. Weather and abrasion resistant smooth synthetic rubber.
<b>Superficie Surface</b>	Liscia. Smooth.



**FASCETTE E COLLARI STRINGITUBO CONSIGLIATE  
RECOMMENDED CLAMP/COLLAR**

STF - Fascette a vite Hose clamps with screw (pag. 204-207)

STM - Fascette stringitubo Hose clamps (pag. 213)

SGT - Fascette pinzabili Stepp less (pag. 216)



- **Resistente ad oli e carburanti con contenuti di aromatici fino al 50%**  
Oils and fuels with 50% aromatic contents resistant.
- **Resistente alle benzine senza piombo con MTBE fino al 5%**  
Unleaded petrol fuels with 5% MTBE resistant.
- **Fornibile su rocchetto.**  
Available also on reel.



mm	mm	bar	bar	bar	gr/mt	mm	m
4	9	10	30	-	60	40	100
5	10	10	30	-	80	50	100
6	13	10	30	-	140	60	100
7	13	10	30	-	130	70	100
8	14,5	10	30	-	160	80	100
10	16	10	30	-	170	100	100



**NORME NORMS:**  
ISO 1307

**MARCATURA MARKING:**  
EUROCORD® SPECIAL GREEN FUEL - ISO 1307

**CONFEZIONAMENTO BOX:**  
IMBALLO IN POLIETILENE TRASPARENTE  
PACKAGING IN TRANSPARENT POLYETHYLENE



**-35°C / +70°C**  
**-31°F / +158°F**



**RUBBER**



- **Resistente ad oli e carburanti con contenuti di aromatici fino al 50%**  
Oils and fuels with 50% aromatic contents resistant.
- **Resistente alle benzine senza piombo con MTBE fino al 5%**  
Unleaded petrol fuels with 5% MTBE resistant.

**IMPIEGO APPLICATIONS**

Idoneo per passaggio gasolio e carburante nei settori automotive e marine.

Suitable for transfer diesel and fuel in automotive and marine engine.



**STRUTTURA BODY**

<b>A</b>	<b>Sottostrato Tube</b>	NBR nero, liscio, resistente agli idrocarburi con contenuto aromatico fino al 50%. NBR black oil/fuel rubber, smooth, resistant to maximum 50% aromatic contents.
<b>B</b>	<b>Inserti Reinforcement</b>	Tessili sintetici ad alta tenacità. High tensile synthetic textile.
<b>C</b>	<b>Copertura Cover</b>	Liscia in gomma sintetica, resistente alla fiamma, all'abrasione, agli agenti atmosferici. Resistente al calore e agli oli. Synthetic rubber compound, flame resistant, abrasion, ozone, weather, heat and oil resistant rubber.
	<b>Superficie Surface</b>	Liscia. Smooth.

mm	mm	bar	bar	bar	gr/mt	mm	m
4	9	10	30	-	0,078	40	100
6	12	10	30	-	0,118	60	100
7	13	10	30	-	0,133	70	100
8	15	10	30	-	0,176	80	100
10	17	10	30	-	0,208	100	100
13	20	10	30	-	0,254	120	100
16	24	10	30	-	0,352	160	50
19	27	10	30	-	0,404	190	50

**FASCETTE E COLLARI STRINGITUBO CONSIGLIATE RECOMMENDED CLAMP/COLLAR**

STF - Fascette a vite Hose clamps with screw (pag. 204-207)

STM - Fascette stringitubo Hose clamps (pag. 213)

SGT - Fascette pinzabili Stepp less (pag. 216)



**NORME NORMS:**  
94/25/ CE, AMEND. DIRECT. 2003/44/CE - ISO 7840:2013- A1 AND LLOYD'S - NMMA APPROVED

**MARCATURA MARKING:** EUROCORD® EN ISO 7840:2013 A1 E E10/B10 - COMPATIBILE R.I.NA APPROVED - CE - YEAR - FUEL HOSE SAE J 1527:2011 USCG R1 - LLOYD'S APPROVED

**CONFEZIONAMENTO BOX:**  
IMBALLO IN POLIETILENE TRASPARENTE  
PACKAGING IN TRANSPARENT POLYETHYLENE



**-35°C / +110°C**  
**-31°F / +230°F**



RUBBER



### IMPIEGO APPLICATIONS

Per mandata di carburanti nei motori a combustione interna o per lubrificazione ed ingrassaggio nei vari servizi.

For delivery of fuels in internal combustion engines for lubrication and greasing services.



- **Conforme alle norme DIN 73379.**  
DIN 73379 approved.



### STRUTTURA BODY

<b>A</b>	<b>Sottostrato Tube</b>	Gomma NBR liscia nera, resistente agli oli ed ai carburanti. Fuel and oil resistant, smooth NBR rubber.
<b>B</b>	<b>Inseriti Reinforcement</b>	Inserzioni tessili ad alta tenacità. High tensile synthetic textile.
<b>C</b>	<b>Copertura Cover</b>	Gomma speciale CR liscia nera, resistente agli oli, ai carburanti, all'abrasione ed agli agenti atmosferici. Abrasion, flame, ozone, weather and oil resistant special CR rubber.
	<b>Superficie Surface</b>	Liscia. Smooth.



### FASCETTE E COLLARI STRINGITUBO CONSIGLIATE RECOMMENDED CLAMP/COLLAR

- STF - Fascette a vite Hose clamps with screw (pag. 204-207)  
STM - Fascette stringitubo Hose clamps (pag. 213)  
SGT - Fascette pinzabili Stepp less (pag. 216)



mm	mm	bar	bar	bar	gr/mt	mm	m
3,5	9,5	10	30	-	85	45	50
4	10	10	30	-	90	45	50
4,5	10,5	10	30	-	100	50	50
4,5	11,5	10	30	-	120	50	50
5	11	10	30	-	105	55	50
5	12	10	30	-	130	55	50
5,5	11,5	10	30	-	110	60	50
6	12	10	30	-	115	60	50
6	13	10	30	-	105	60	50
7	12	10	30	-	105	60	50
7	13	10	30	-	130	70	50
7,3	13,3	10	30	-	135	70	50
7,3	14,3	10	30	-	165	70	50
7,5	14,5	10	30	-	135	80	50
8	14	10	30	-	145	80	50
8	15	10	30	-	175	80	50
9	15	10	30	-	155	80	50
9,5	15,3	10	30	-	155	80	50
10	16	10	30	-	170	80	50
10	17	10	30	-	205	80	50
11	17	10	30	-	185	80	50
11	18	10	30	-	220	80	50
11,5	18,5	10	30	-	230	80	50
12,5	20	10	30	-	265	80	50
14	22	10	30	-	315	100	50
16	24	10	30	-	350	100	50



**NORME NORMS:**  
DIN 73379 TYPE 2A - ISO 1307

**MARCATURA MARKING:**  
EUROCORD® DIN 73379 2A FUEL&OIL MM ... NBR/CR

**CONFEZIONAMENTO BOX:**  
IMBALLO IN POLIETILENE ROSSO  
PACKAGING IN RED POLYETHYLENE



**-30°C / +90°C**  
**-22°F / +194°F**



**RUBBER**

**IMPIEGO APPLICATIONS**









Tubo flessibile per mandata in pressione di fluidi a base di urea acquosa AUS 32 (ADBLUE) in concentrazione non superiore al 33%. Può essere utilizzato in attrezzature ed impianti di vario genere.

Flexible hose for delivery of AUS 32 (ADBLUE) up to 33%.



**STRUTTURA BODY**

<b>A</b>	<b>Sottostrato Tube</b>	Liscio, nero, in miscela a base di alta qualità di EPDM. Smooth black EPDM rubber.
<b>B</b>	<b>Inserti Reinforcement</b>	Tessili sintetici. High tensile synthetic textile.
<b>C</b>	<b>Copertura Cover</b>	Liscia in gomma EPDM di colore nero resistente alla temperatura, all'abrasione, agli agenti atmosferici e ozono. Abrasion, heat, ozone and weather resistant, smooth EPDM rubber.
	<b>Superficie Surface</b>	Liscia. Smooth.

 mm	 mm	 bar	 bar	 bar	 gr/mt	 mm	 m
13	20	10	30	-	280	130	50-100
19	27	10	30	-	340	190	50-100
25	35	10	30	-	550	250	50-100

**FASCETTE E COLLARI STRINGITUBO CONSIGLIATE RECOMMENDED CLAMP/COLLAR**

STF - Fascette a vite Hose clamps with screw (pag. 204-207)

STM - Fascette stringitubo Hose clamps (pag. 213)

SGT - Fascette pinzabili Stepp less (pag. 216)



**NORME NORMS:**  
ISO 1307 - ISO 22241-2

**MARCATURA MARKING:**  
EUROCORD® POWERBLUE WP 10 BAR ISO 22241-2

**CONFEZIONAMENTO BOX:**  
IMBALLO IN POLIETILENE TRASPARENTE  
PACKAGING IN TRANSPARENT POLYETHYLENE

**-40°C / +100°C**  
con picchi fino a  
with peaks up to  
+120°C

**-22°F / +194°F**  
con picchi fino a  
with peaks up to  
+230°F

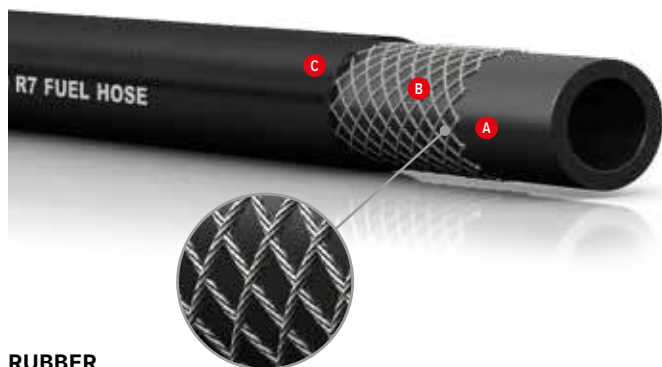

RUBBER



## IMPIEGO APPLICATIONS

Idoneo alla mandata di fluidi idraulici, oli minerali, lubrificanti, diesel fuel, benzine.

Can be used as a fuel line. Suitable for the delivery of unleaded fuels and diesel oils especially in the automotive sectors.



## STRUTTURA BODY

<b>A</b>	<b>Sottostrato Tube</b>	Gomma sintetica di colore nero. Black synthetic rubber.
<b>B</b>	<b>Inserti Reinforcement</b>	1 treccia di filato sintetico ad alta resistenza. 1 spiral textile.
<b>C</b>	<b>Copertura Cover</b>	Gomma sintetica resistente agli agenti atmosferici, all'abrasione, ad oli e carburanti. Black and smooth synthetic rubber, ozone, abrasion and oil resistant.
	<b>Superficie Surface</b>	Liscia. Smooth.



## FASCETTE E COLLARI STRINGITUBO CONSIGLIATE RECOMMENDED CLAMP/COLLAR

STF - Fascette a vite Hose clamps with screw (pag. 204-207)

STM - Fascette stringitubo Hose clamps (pag. 213)

SGT - Fascette pinzabili Stepp less (pag. 216)



mm	mm	bar	bar	bar	gr/mt	mm	m
5	11	10	30	-	95	50	100
6	12	10	30	-	120	60	100
7	13	10	30	-	130	70	100
8	14	10	30	-	150	80	100
10	16	10	30	-	200	100	100
13	20	10	30	-	290	130	50
16	24	10	30	-	352	160	50
19	27	10	30	-	405	190	50
25	35	10	30	-	660	250	50



**NORME NORMS:**  
ISO 1307 - SAE J30 R7

**MARCATURA MARKING:**  
EUROCORD® SAE J30 R7 FUEL HOSE

**CONFEZIONAMENTO BOX:**  
IMBALLO IN POLIETILENE ROSSO  
PACKAGING IN RED POLYETHYLENE



**-30°C / +120°C**  
**-22°F / +248°F**





**RUBBER**

**IMPIEGO APPLICATIONS**

Idoneo per la mandata di carburanti senza piombo (EN 228:2017) e gasolio (EN 590:2017) per auto, camion e trattori. Adatto per B100 (100% biodiesel = RME), B20, B7 (EN 590:2017), E5 (EN 228:2017), E10, E85 e E100. Il rivestimento utilizzato soddisfa inoltre la RMA class A.

Suitable for the delivery of unleaded fuels (EN 228:2017) and diesel oils (EN 590:2017) for cars, trucks and tractors. Suitable for B100 (100% biodiesel = RME), B20, B7 (EN 590:2017), E5 (EN 228:2017), E10, E85 and E100. The used liner fulfills RMA class A.



**STRUTTURA BODY**

<b>A</b>	<b>Sottostrato Tube</b>	Gomma NBR di colore nero. Black NBR rubber.
<b>B</b>	<b>Inserti Reinforcement</b>	Tessili. Spiral textile.
<b>C</b>	<b>Copertura Cover</b>	Gomma nera liscia sintetica resistente ad ozono, abrasione e oli. Black and smooth syntetic rubber, ozone, abrasion and oil resistant.
	<b>Superficie Surface</b>	Liscia. Smooth.

mm	mm	bar	bar	bar	gr/mt	mm	m
5	11	12	36	-	95	30	50
6	12	12	36	-	120	36	50
7	13	12	36	-	130	42	50
8	14	12	36	-	150	48	50
10	16	12	36	-	200	60	50

**FASCETTE E COLLARI STRINGITUBO CONSIGLIATE RECOMMENDED CLAMP/COLLAR**

- STF - Fascette a vite Hose clamps with screw (pag. 204-207)
- STM - Fascette stringitubo Hose clamps (pag. 213)
- SGT - Fascette pinzabili Stepp less (pag. 216)



**NORME NORMS:**  
SAE J30R2 - SAE J30R6

**MARCATURA MARKING:**  
EUROCORD® SAE J30 R2 SAE J30R6 W.P 12 BAR

**CONFEZIONAMENTO BOX:**  
IMBALLO IN POLIETILENE ROSSO  
PACKAGING IN RED POLYETHYLENE

**-30°C / +100°C**  
**-22°F / +212°F**

# EASY LOCK/LN SAE 100 R6

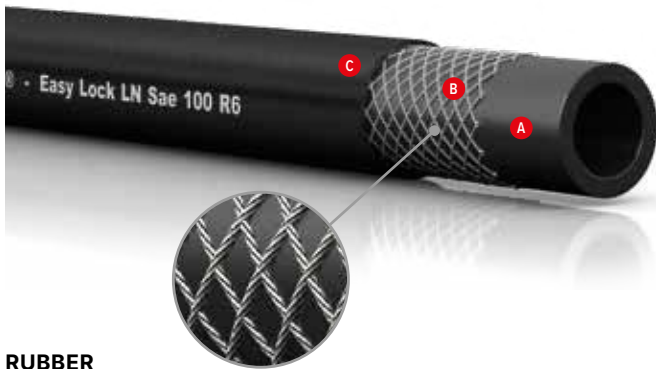

RUBBER



## IMPIEGO APPLICATIONS

Per passaggio a bassa pressione dei fluidi idraulici a base di oli minerali, greggio, acqua ed aria compressa, etc.

For hydraulic control lines, discharge under low pressure of hydraulic fluids, fuel oil, grease, air and water.



## STRUTTURA BODY

<b>A</b> Sottostrato Tube	Gomma speciale sintetica, resistente agli oli idraulici. Hydraulic oil resistant special synthetic rubber.
<b>B</b> Inseriti Reinforcement	1 treccia sintetica, resistente agli oli idraulici. 1 high tensile synthetic textile braid.
<b>C</b> Copertura Cover	Gomma speciale sintetica resistente a gli oli, ozono, abrasione ed agenti atmosferici. Oil, abrasion, ozone and weather resistant special synthetic rubber.
Superficie Surface	Liscia. Smooth.



- Studiato appositamente per sistemi di raccordatura Push Lock. Suitable for Push Lock connection systems.



mm	mm	bar	bar	bar	gr/mt	mm	m
4,8	10,7	34	136	-	90	50	>10
6,4	12,3	28	112	-	110	65	>10
8	13,9	28	112	-	130	80	>10
9,5	15,5	28	112	-	150	80	>10
12,7	19,5	28	112	-	220	100	>10
16	22,6	24	96	-	260	125	>10
19	25,8	21	84	-	310	150	>10
25,4	33,234	20	80	-	460	170	>10



**NORME NORMS:**  
SAE 100 R6 - ISO 1307 - EN854 TYPE R6 - TS6388  
EN854 TIP36 - ISO4079-1 R6

**MARCATURA MARKING:**  
EUROCORD® EASY LOCK LN SAE 100 R6

**CONFEZIONAMENTO BOX:**  
IMBALLO IN POLIETILENE ROSSO  
PACKAGING IN RED POLYETHYLENE



**-40°C / +100°C**  
**-40°F / +212°F**



**RUBBER**



- **Antistatico.**  
**Antistatic.**

**IMPIEGO APPLICATIONS**

Idoneo alla mandata di oli minerali, gasolio, benzine e carburanti. Particolarmente indicato allo scarico e carico in sola mandata delle autoferrocisterne, nelle raffinerie e stazioni di servizio.

Suitable for mineral oils, diesel fuels, and fuels in general delivery. Particularly used for the unloading and loading of gas stations.

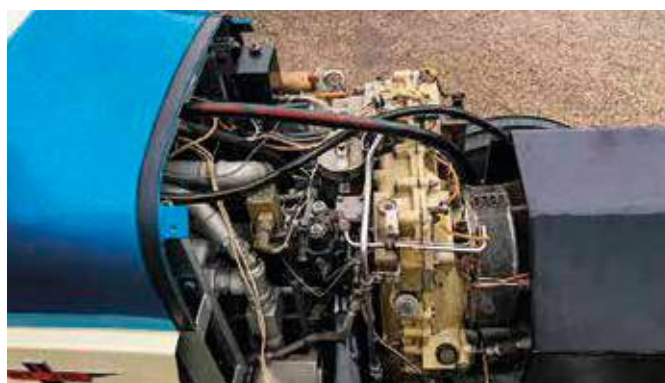

**STRUTTURA BODY**

<b>A</b>	<b>Sottostrato Tube</b>	Gomma NBR di colore nero, resistente ai carburanti, con contenuto aromatico non superiore al 50%. Oil and petrol resistant, black NBR.
<b>B</b>	<b>Inserti Reinforcement</b>	Tessili e sintetici con cordicella di rame per garantire la dissipazione dell'elettricità statica. High tensile synthetic textile and antistatic copper wire.
<b>C</b>	<b>Copertura Cover</b>	Gomma NBR/SBR resistente ai carburanti, agli oli, all'ozono e agli agenti atmosferici. Abrasion, ozone, weather and oil resistant special synthetic rubber.
	<b>Superficie Surface</b>	Liscia ad impressione tela. Smooth with fabric impression.

19	27	10	30	-	380	190	40
22	30	10	30	-	424	220	40
25	35	10	30	-	615	250	40
30	40	10	30	-	693	300	40
32	42	10	30	-	751	320	40
35	45	10	30	-	880	350	40
40	50	10	30	-	914	400	40
45	56	10	30	-	1137	450	40
50	62	10	30	-	1280	500	40
60	72	10	30	-	1598	600	40

**FASCETTE E COLLARI STRINGITUBO CONSIGLIATE RECOMMENDED CLAMP/COLLAR**

- STF - Fascette a vite Hose clamps with screw (pag. 204-207)
- STC - Fascette con bullone Hose clamps with bolt (pag. 208-210)



**NORME NORMS:**  
ISO 1307  
**MARCATURA MARKING:**  
EUROCORD® OIL DELIVERY HOSE W.P. 10 BAR  
**CONFEZIONAMENTO BOX:**  
IMBALLO IN POLIETILENE ROSSO  
PACKAGING IN RED POLYETHYLENE



**-35°C / +70°C**  
**-31°F / +158°F**

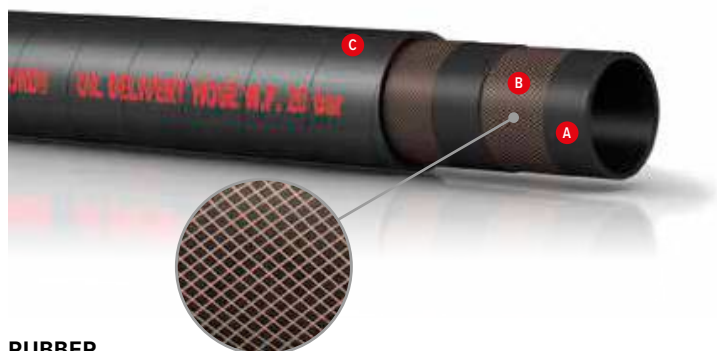

**RUBBER**



- **Antistatico.**  
Antistatic.



**IMPIEGO  
APPLICATIONS**

Per mandata e leggera aspirazione di oli minerali, gasolio, benzine e carburanti. La sua particolare struttura è stata studiata per essere avvolta su aspi per carico e scarico di combustibili da autobotti. Struttura resistente allo schiacciamento e alle ovalizzazioni.

For the delivery and light suction of petroleum products from tanker vehicles. Can be wounded on reels. Excellent resistance to crushing.



**STRUTTURA  
BODY**

<b>A</b>	<b>Sottostrato Tube</b>	Liscio in gomma NBR di colore nero, resistente ai carburanti, con contenuto aromatico non superiore al 50%. Smooth black NBR rubber, resistant to oil and petrol with aromatic content up to 50%.
<b>B</b>	<b>Inseri Reinforcement</b>	Fibre sintetiche ad alta resistenza e cordicella di rame incorporata per garantire la dissipazione dell'elettricità statica. High tensile synthetic textile and antistatic copper wire.
<b>C</b>	<b>Copertura Cover</b>	Gomma nera PVC/ NBR resistente all'abrasione, agli oli, ai carburanti, agli agenti atmosferici, all'ozono. Smooth black PVC/nbr rubber resistant to oils, petrol, abrasion, ozone and weather conditions..
	<b>Superficie Surface</b>	Liscia ad impressione tela. Smooth with fabric impression.



**FASCETTE E COLLARI STRINGITUBO CONSIGLIATE  
RECOMMENDED CLAMP/COLLAR**

STF - Fascette a vite Hose clamps with screw (pag. 204-207)  
STC - Fascette con bullone Hose clamps with bolt (pag. 208-210)



mm	mm	bar	bar	bar	gr/mt	mm	m
19	32	20	60	-	668	190	40
25	38	20	60	-	804	254	40
32	45	20	60	-	1008	320	40
38	52,5	20	60	-	1282	380	40
40	54,5	20	60	-	1338	400	40
45	58	20	60	-	1416	445	40
50	64,5	20	60	-	1535	508	40



**NORME NORMS:**  
ISO 1307  
**MARCATURA MARKING:**  
EUROCORD® OIL DELIVERY HOSE W.P. 20 BAR  
**CONFEZIONAMENTO BOX:**  
IMBALLO IN POLIETILENE ROSSO  
PACKAGING IN RED POLYETHYLENE



**-20°C / +70°C**  
**-4°F / +158°F**



**RUBBER**



- **Conforme normativa EN 1360 Type 1. EN1360 type 1 approved.**

**IMPIEGO APPLICATIONS**

Specifico per erogazione di carburanti nelle stazioni di servizio (benzina, benzina verde e gasolio).

For all types of gasoline dispensing applications. (Regular, premium gasoline and diesel).



**STRUTTURA BODY**

<b>A</b>	<b>Sottostrato Tube</b>	Gomma nitrilica nera, resistente ai prodotti petroliferi. Oil, gasoline and diesel resistant smooth, black, nitrile rubber.
<b>B</b>	<b>Inseriti Reinforcement</b>	Inserzioni tessili ad alta tenacità e cordicella di rame antistatica. High tensile synthetic textile and antistatic copper wire.
<b>C</b>	<b>Copertura Cover</b>	Gomma speciale resistente agli oli, alla fiamma, all'ozono, all'abrasione e agli agenti atmosferici. Flame, oil, fuel, abrasion, ozone, heat and weather resistant, synthetic rubber.
	<b>Superficie Surface</b>	Liscia. Smooth.

mm	mm	bar	bar	bar	gr/mt	mm	m
12,7	21,5	16	48	-	295	50	>6
16	26	16	48	-	425	70	>6
19	29	16	48	-	475	95	>6
25,4	36,5	16	48	-	690	130	>6

<p><b>NORME NORMS:</b> EN 1360 TYPE 1 - ISO 1307</p> <p><b>MARCATURA MARKING:</b> EUROCORD® CARBO STATION EN 1360 TYPE - 1</p> <p><b>CONFEZIONAMENTO BOX:</b> IMBALLO IN POLIETILENE ROSSO PACKAGING IN RED POLYETHYLENE</p>	<p><b>-30°C / +55°C</b> <b>-22°F / +158°F</b></p>

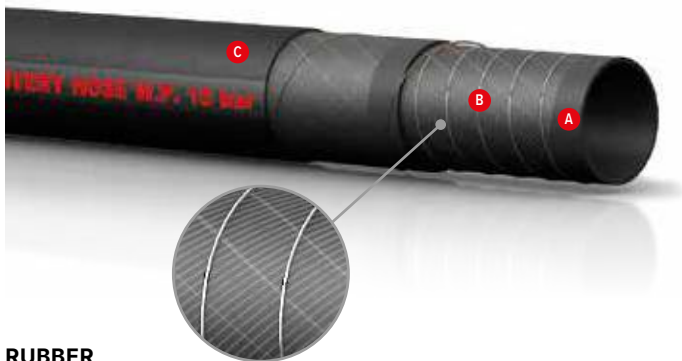

## RUBBER



### IMPIEGO APPLICATIONS

Idoneo alla mandata e aspirazione di oli minerali, gasolio, benzine e carburanti. Particolarmente indicato allo scarico e carico di autoferrocisterne, nelle stazioni di servizio e raffinerie.

Suitable for the mineral oils, diesel fuels, and fuels in general suction and delivery. Particularly used for the unloading and loading of tankers.



### STRUTTURA BODY

<b>A</b>	<b>Sottostrato Tube</b>	Gomma NBR di colore nero resistente ai carburanti con contenuto di aromatico non superiore al 50%. Oil and petrol resistant, black NBR.
<b>B</b>	<b>Inseriti Reinforcement</b>	Spirale metallica incorporata con inserti tessili sintetici e cordicella di rame per garantire la dissipazione dell'elettricità statica. High tensile synthetic textile, steel wire helix and antistatic copper wire.
<b>C</b>	<b>Copertura Cover</b>	Gomma NBR/SBR resistente ai carburanti, all'ozono e agli agenti atmosferici. Oil, weather, ozone, abrasion resistant special synthetic rubber.
	<b>Superficie Surface</b>	Liscia ad impressione tela. Smooth with fabric impression.



### FASCETTE E COLLARI STRINGITUBO CONSIGLIATE RECOMMENDED CLAMP/COLLAR

STF - Fascette a vite Hose clamps with screw (pag. 204-207)

STC - Fascette con bullone Hose clamps with bolt (pag. 208-210)



mm	mm	bar	bar	bar	gr/mt	mm	m
19	29	10	30	0,8	540	75	40
25	36	10	30	0,8	710	100	40
30	41	10	30	0,8	871	120	40
32	44	10	30	0,8	1014	130	40
35	46	10	30	0,8	993	140	40
38	49	10	30	0,8	1070	150	40
40	52	10	30	0,8	1249	160	40
45	57	10	30	0,8	1522	190	40
48	58	10	30	0,8	1314	200	40
51	63	10	30	0,8	1752	250	40
60	73	10	30	0,8	2132	310	40
70	83	10	30	0,8	2605	400	40
80	94	10	30	0,8	2983	475	20-40
90	104	10	30	0,8	3326	522	20
98	104	10	30	0,8	3326	522	20
100	117	10	30	0,8	4133	610	20-40
120	138	10	30	0,8	7400	720	20



**NORME NORMS:**  
ISO 1307

**MARCATURA MARKING:**  
EUROCORD® OIL SUCTION DELIVERY HOSE W.P.  
10 BAR

**CONFEZIONAMENTO BOX:**  
IMBALLO IN POLIETILENE ROSSO  
PACKAGING IN RED POLYETHYLENE



**-35°C / +70°C**  
**-31°F / +158°F**

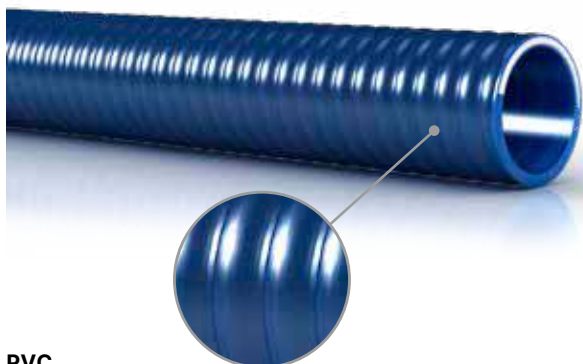

PVC



**IMPIEGO  
APPLICATIONS**

Idoneo all'aspirazione e mandata di prodotti petroliferi. La sua particolare struttura lo rende molto resistente in condizioni di lavoro estreme (es. spurgo industriale). È facilmente avvolgibile su aspi.

For medium duty suction and delivery of industrial oils and fuels for use in cold climates. Crushing, chemical agents, abrasion and weather resistant.



**STRUTTURA  
BODY**

<b>A</b>	<b>Sottostrato Tube</b>	Speciale miscela in PVC resistente a oli e carburanti. Strong, flexible and smooth oil resistant PVC/nbr compound.
<b>B</b>	<b>Inserti Reinforcement</b>	Spirale in PVC anti-schiacciamento. Anti crushing PVC spiral.
<b>C</b>	<b>Copertura Cover</b>	In PVC leggermente corrugata. Light corrugated outside.
	<b>Superficie Surface</b>	Blu opaco. Blue matt.

mm	mm	bar	bar	bar	gr/mt	mm	m
20	4,6	8	-	0,8	450	80	50
25	4,6	8	-	0,8	580	100	50
30	4,8	8	-	0,8	650	120	50
32	4,8	8	-	0,8	670	128	50
35	5	7	-	0,8	720	140	50
38	5	7	-	0,8	770	152	50
40	5	7	-	0,8	815	160	50
45	5,1	7	-	0,8	960	180	50
50	5,6	7	-	0,8	1150	200	50
60	5,9	6	-	0,8	1530	240	50
63	6	6	-	0,8	1580	252	50
70	6,1	6	-	0,8	1820	280	50
75	6,2	5	-	0,8	1920	300	50
80	6,4	4	-	0,8	2100	320	50/30
90	6,6	4	-	0,8	2400	360	30/25
100	7,2	3	-	0,8	3200	400	30/25
120	7,9	3	-	0,7	3800	480	30/25
152	9,8	2,5	-	0,7	6150	608	30/25



**FASCETTE E COLLARI STRINGITUBO CONSIGLIATE  
RECOMMENDED CLAMP/COLLAR**

STC - Fascette con bullone Hose clamps with bolt (pag. 208-210)  
BANDI BLOCK - Coppia di serraggio Tightening torque (pag. 221)



NORME NORMS:  
ISO 1307



-25°C / +60°C  
-13°F / +140°F

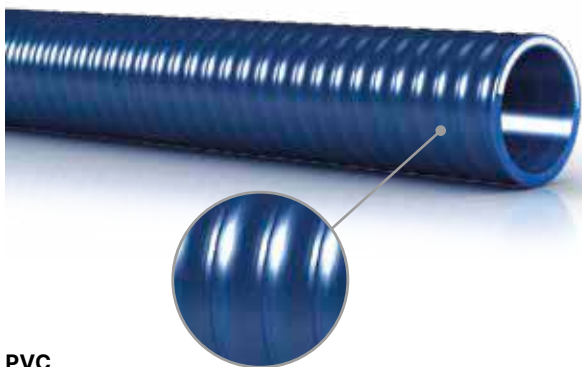

PVC



- **Antistatico.**  
Antistatic.



## IMPIEGO APPLICATIONS

Idoneo all'aspirazione e mandata di prodotti petroliferi. La sua particolare struttura lo rende molto resistente in condizioni di lavoro estreme (es. spurgo industriale). È facilmente avvolgibile su aspi.

For industrial oils and fuel suction and delivery. Its particularly structure makes it resistant to extreme working conditions. it is easy to roll up it on reels.



## STRUTTURA BODY

<b>A</b>	<b>Sottostrato Tube</b>	Speciale miscela in PVC resistente a oli e carburanti. Strong, flexible and smooth oil resistant PVC/nbr compound.
<b>B</b>	<b>Inseriti Reinforcement</b>	Spirale in PVC anti-schiacciamento e Cordicella di rame per la dissipazione dell'elettricità statica. Anti crushing PVC spiral and longitudinal copper wire.
<b>C</b>	<b>Copertura Cover</b>	In PVC leggermente corrugata. Light corrugated outside.
	<b>Superficie Surface</b>	Blu opaco. Blue matt.



## FASCETTE E COLLARI STRINGITUBO CONSIGLIATE RECOMMENDED CLAMP/COLLAR

STC - Fascette con bullone Hose clamps with bolt (pag. 208-210)  
BANDI BLOCK - Coppia di serraggio Tightening torque (pag. 221)



mm	mm	bar	bar	bar	gr/mt	mm	m
20	4,6	8	-	0,8	450	80	50
25	4,6	8	-	0,8	580	100	50
30	4,8	8	-	0,8	650	120	50
32	4,8	8	-	0,8	670	128	50
35	5	7	-	0,8	720	140	50
38	5	7	-	0,8	770	152	50
40	5	7	-	0,8	815	160	50
45	5,1	7	-	0,8	960	180	50
50	5,6	7	-	0,8	1150	200	50
60	5,9	6	-	0,8	1530	240	50
63	6	6	-	0,8	1580	252	50
70	6,1	6	-	0,8	1820	280	50
75	6,2	5	-	0,8	1920	300	50
80	6,4	4	-	0,8	2100	320	50
90	6,6	4	-	0,8	2400	360	25
100	7,2	3	-	0,8	3200	400	25
120	7,9	3	-	0,7	3800	480	25
152	9,8	2,5	-	0,7	6150	608	25



NORME NORMS:  
ISO 1307



-25°C / +60°C  
-13°F / +140°F



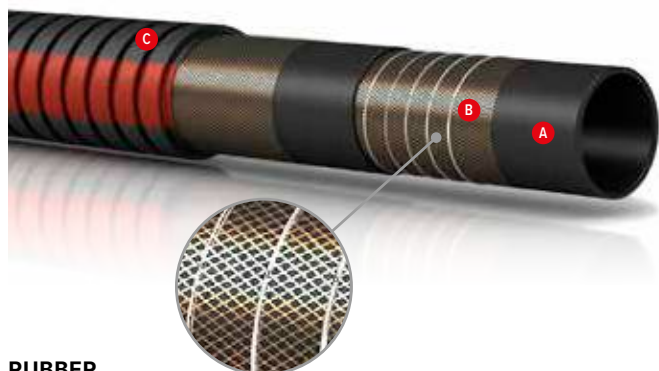

**RUBBER**



- **Ideale per settore automobilistico e per veicoli industriali.**  
**Ideal for the automotive sector and for the industrial vehicles.**



**IMPIEGO**  
**APPLICATIONS**

Per aspirazione e mandata di olii paraffinici, aria, acqua e glicole. Particolarmente indicato negli impieghi in cui vengano richiesti ridotti raggi di curvatura; trova ampia applicazione nel settore automobilistico e dei veicoli industriali come flessibile multiuso.

For paraffinic oils, air, water and glycol suction and delivery. Particularly used where it is necessary a small band radius. Suitable for the automotive sector and for the industrial vehicles.



**STRUTTURA**  
**BODY**









<b>A</b>	<b>Sottostrato Tube</b>	Gomma nera NBR resistente a oli e carburanti contenuto aromatico non superiore al 50%. Oil and petrol resistant, black NBR, with aromatic content up to 50%.
<b>B</b>	<b>Inserti Reinforcement</b>	Tessili sintetici ad alta tenacità e spirale metallica incorporata, cordicella di rame. High tensile synthetic textile, steel wire helix and antistatic copper wire.
<b>C</b>	<b>Copertura Cover</b>	Gomma EPDM. Oil, weather, ozone, abrasion resistant special synthetic rubber.
	<b>Superficie Surface</b>	Greccato ad impressione tela. Greccato with fabric impression.



**FASCETTE E COLLARI STRINGITUBO CONSIGLIATE**  
**RECOMMENDED CLAMP/COLLAR**

- STF - Fascette a vite Hose clamps with screw (pag. 204-207)
- SDB - Fascette a tensione costante SAE Constant tension clamps SAE (pag. 215)
- STC - Fascette con bullone Hose clamps with bolt (pag. 208-210)
- STS - Fascette a tensione costante SAE Constant tension clamps SAE (pag. 214)



 mm	 mm	 bar	 bar	 bar	 gr/mt	 mm	 m
19	29	10	30	0,8	540	75	40
25	36	10	30	0,8	710	100	40
30	41	10	30	0,8	871	120	40
32	44	10	30	0,8	1014	130	40
35	46	10	30	0,8	993	140	40
38	49	10	30	0,8	1070	150	40
40	52	10	30	0,8	1249	160	40
45	57	10	30	0,8	1522	190	40
48	58	10	30	0,8	1314	200	40
51	63	10	30	0,8	1752	250	40
60	73	10	30	0,8	2132	310	40
70	83	10	30	0,8	2605	400	40
80	94	10	30	0,8	2983	475	20-40
90	104	10	30	0,8	3326	522	20
98	104	10	30	0,8	3326	522	20
100	117	10	30	0,8	4133	610	20-40
120	138	10	30	0,8	7400	720	20



**NORME NORMS:**  
ISO 1307

**MARCATURA MARKING:**  
EUROCORD® OIL SUCTION DELIVERY HOSE W.P. 10 BAR

**CONFEZIONAMENTO BOX:**  
IMBALLO IN POLIETILENE NERO  
PACKAGING IN BLACK POLYETHYLENE



**-35°C / +100°C**  
**-31°F / +212°F**

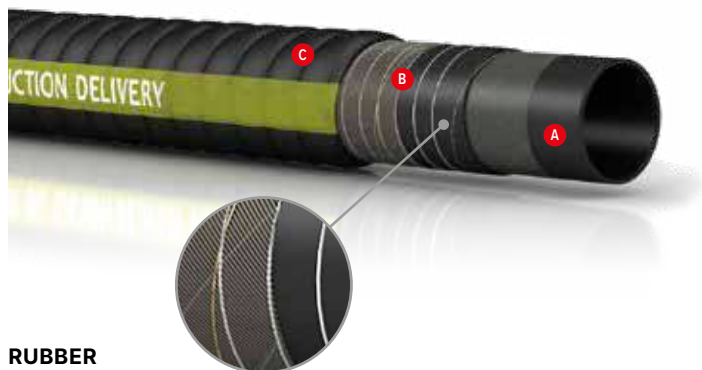

**RUBBER**



**IMPIEGO  
APPLICATIONS**

Idoneo alla mandata ed aspirazione di oli minerali, gasolio, benzine e carburanti. Particolarmente indicato allo scarico e carico di autoferrocisterne, nelle stazioni di servizio e raffinerie.

Suitable for the mineral oils, diesel fuels, and fuels in general suction and delivery. Particularly used for the unloading and loading of gas stations.



**STRUTTURA  
BODY**









<b>A</b> <b>Sottostrato Tube</b>	Gomma NBR di colore nero resistente ai carburanti con contenuto di aromatico non superiore al 50%. Synthetic NBR oil and petrol resistant for aromatic content up to 50%.
<b>B</b> <b>Inseri Reinforcement</b>	Spirale metallica incorporata con inserti tessili sintetici e cordicella di rame per garantire la dissipazione dell'elettricità statica. High tensile synthetic textile, steel wire helix and antistatic copper wire.
<b>C</b> <b>Copertura Cover</b>	Gomma NBR/SBR resistente ai carburanti, all'ozono e agli agenti atmosferici. Oil, weather, ozone, abrasion resistant, corrugated special synthetic rubber.
<b>Superficie Surface</b>	Ondulata ad impressione tela. Corrugated with fabric impression.



**FASCETTE E COLLARI STRINGITUBO CONSIGLIATE  
RECOMMENDED CLAMP/COLLAR**

STC - Fascette con bullone Hose clamps with bolt (pag. 208-210)



 mm	 mm	 bar	 bar	 bar	 gr/mt	 mm	 m
40	51	5	15	0,5	1076	160	40
45	56	5	15	0,5	1195	180	40
50	61	5	15	0,5	1344	200	40
50	64	5	15	0,5	1764	220	40
80	94	5	15	0,5	2615	320	20
102	116	5	15	0,5	3439	400	20



**NORME NORMS:**  
ISO 1307

**MARCATURA MARKING:**  
EUROCORD® OIL SUCTION DELIVERY

**CONFEZIONAMENTO BOX: IMBALLO IN  
POLIETILENE ROSSO  
PACKAGING IN RED POLYETHYLENE**



**-35°C / +70°C  
-31°F / +158°F**



**RUBBER**



- **Fornito con manicotti flessibili alle estremità per facilitarne la raccordatura.**  
Provided with soft cuffs-ends.
- **Disponibile in pezzature d'impiego.**  
Available in different sizes.

**IMPIEGO APPLICATIONS**

Idoneo alla mandata ed aspirazione di oli minerali, gasolio, benzine e carburanti. Particolarmente indicato allo scarico e carico di autoferrocisterne, nelle stazioni di servizio e raffinerie. La tubazione è fornita con manicotti flessibili all'estremità per facilitare la raccordatura con fascetta.

Suitable for the mineral oils, diesel fuels, and fuels in general suction and delivery. Particularly used for the unloading and loading of gas stations..



**STRUTTURA BODY**

<b>A</b>	<b>Sottostrato Tube</b>	Gomma NBR di colore nero resistente ai carburanti con contenuto di aromatico non superiore al 50%. Synthetic NBR oil and petrol resistant for aromatic content up to 50%.
<b>B</b>	<b>Inserti Reinforcement</b>	Spirale metallica incorporata con inserti tessili sintetici e cordicella di rame per garantire la dissipazione dell'elettricità statica. High tensile synthetic textile, steel wire helix and antistatic copper wire.
<b>C</b>	<b>Copertura Cover</b>	Gomma NBR/SBR resistente ai carburanti, all'ozono e agli agenti atmosferici. Oil, weather, ozone, abrasion resistant, corrugated special synthetic rubber.
	<b>Superficie Surface</b>	Ondulata ad impressione tela. Corrugated with fabric impression.

mm	mm	bar	bar	bar	gr/mt	mm	m
40	51	5	15	0,5	1076	160	2-3-4
50	62	5	15	0,5	1744	200	2-3-4
80	93	5	15	0,5	2582	320	2-3-4
102	116	5	15	0,5	3335	400	2-3-4

**FASCETTE E COLLARI STRINGITUBO CONSIGLIATE RECOMMENDED CLAMP/COLLAR**

STC - Fascette con bullone Hose clamps with bolt (pag. 208-210)



**NORME NORMS:**  
ISO 1307  
**MARCATURA MARKING:**  
EUROCORD® OIL SUCTION DELIVERY  
**CONFEZIONAMENTO BOX:**  
IMBALLO IN POLIETILENE ROSSO  
PACKAGING IN RED POLYETHYLENE



**-35°C / +70°C**  
**-31°F / +158°F**

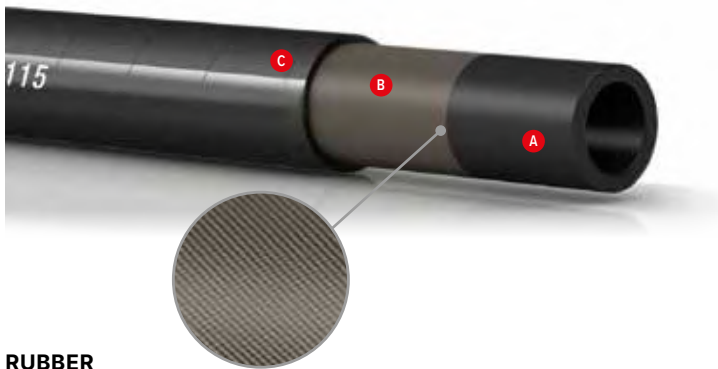

**RUBBER**



**IMPIEGO  
APPLICATIONS**

Idoneo all'aspirazione ed alla mandata di prodotti petroliferi con contenuto aromatico fino al 50%.

For discharge of petroleum products with aromatic content up to 50%.



**STRUTTURA  
BODY**









<b>A</b>	<b>Sottostrato Tube</b>	Gomma NBR di colore nero, conduttiva, resistente ai prodotti petroliferi. Oil and petrol resistant, conductive NBR.
<b>B</b>	<b>Inserti Reinforcement</b>	Tessili ad alta tenacità e cordicella in rame antistatica. High tensile synthetic textile, antistatic copper wire.
<b>C</b>	<b>Copertura Cover</b>	Gomma speciale sintetica, resistente agli oli, alla fiamma, all'ozono, all'abrasione, agli agenti atmosferici e all'acqua di mare. Oil, weather, ozone, abrasion and flame resistant, special synthetic rubber.
	<b>Superficie Surface</b>	Liscia ad impressione tela. Smooth with fabric impression.



**FASCETTE E COLLARI STRINGITUBO CONSIGLIATE  
RECOMMENDED CLAMP/COLLAR**

STF - Fascette a vite Hose clamps with screw (pag. 204-207)



 mm	 mm	 bar	 bar	 bar	 gr/mt	 mm	 m
19	31	16	64	-	673	125	40
25,4	37	16	64	-	842	150	40
32	44	16	64	-	1037	175	40
38	51	16	64	-	1408	225	40
50,8	67	16	64	-	2205	275	40
63,5	79	16	64	-	2739	300	40
76,2	92	16	64	-	3304	350	40
101,6	118	16	64	-	4542	450	40



**NORME NORMS:**  
EN 12115  
**MARCATURA MARKING:**  
EUROCORD® TANK TRUCK HD EN 12115

**CONFEZIONAMENTO BOX:**  
IMBALLO IN POLIETILENE TRASPARENTE  
PACKAGING IN TRANSPARENT POLYETHYLENE



**20°C / +70°C**  
**-4°F / +158°F**



**RUBBER**



**IMPIEGO  
APPLICATIONS**

Idoneo all'aspirazione ed alla mandata di prodotti petroliferi con contenuto aromatico fino al 50%.

For discharge of petroleum products with aromatic content up to 50%.



**STRUTTURA  
BODY**









<b>A</b>	<b>Sottostrato Tube</b>	Gomma NBR di colore nero, conduttiva, resistente ai prodotti petroliferi. Oil and petrol resistant, conductive NBR.
<b>B</b>	<b>Inserti Reinforcement</b>	Tessili ad alta tenacità con spirale in acciaio e due cordicelle di rame antistatiche. High tensile synthetic textile, antistatic copper wire.
<b>C</b>	<b>Copertura Cover</b>	Gomma speciale sintetica, resistente agli oli, alla fiamma, all'ozono, all'abrasione, agli agenti atmosferici e all'acqua di mare. Oil, weather, ozone, abrasion and flame resistant, special synthetic rubber.
	<b>Superficie Surface</b>	Liscia ad impressione tela. Smooth with fabric impression.



**FASCETTE E COLLARI STRINGITUBO CONSIGLIATE  
RECOMMENDED CLAMP/COLLAR**

STF - Fascette a vite Hose clamps with screw (pag. 204-207)



 mm	 mm	 bar	 bar	 bar	 gr/mt	 mm	 m
19	31	16	64	0,92	673	125	40
25,4	37	16	64	0,92	842	150	40
32	44	16	64	0,92	1037	175	40
38	51	16	64	0,92	1408	225	40
50,8	67	16	64	0,92	2205	275	40
63,5	79	16	64	0,92	2739	300	40
76,2	92	16	64	0,80	3304	350	40
101,6	118	16	64	0,80	4542	450	40



**NORME NORMS:**  
EN 12115  
**MARCATURA MARKING:** EUROCORD® TANK  
TRUCK SP EN 12115  
**CONFEZIONAMENTO BOX:**  
IMBALLO IN POLIETILENE TRASPARENTE  
PACKAGING IN TRANSPARENT POLYETHYLENE



**20°C / +70°C**  
**-4°F / +158°F**

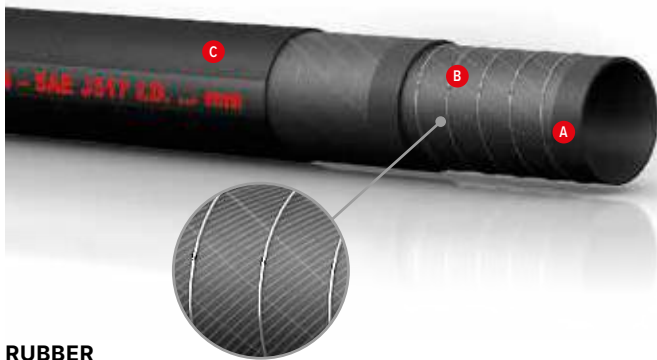

**RUBBER**



**IMPIEGO  
APPLICATIONS**

Idoneo alla mandata ed aspirazione di oli idraulici negli impianti oleodinamici. Particolarmente utilizzato a livello agricolo ed industriale; montato e raccordato sulle macchine agricole, macchine industriali, presse, etc.

Suitable for hydraulic oils suction and delivery in hydraulic plants. Particularly used in agricultural and industrial sectors.



- **Ideale per settore oleodinamico, agricolo e industriale.**  
Ideal for the oleodinamic, industrial and agricultural sectors.
- **Conforme normativa SAE J517 100R4.**  
SAE J517 100R4 approved.



**STRUTTURA  
BODY**

<b>A</b>	<b>Sottostrato Tube</b>	Gomma nera NBR resistente agli oli idraulici. Oil and petrol resistant, conductive NBR.
<b>B</b>	<b>Inseriti Reinforcement</b>	Spirale metallica con inserti tessili sintetici e cordicella di rame. High tensile synthetic textile, antistatic copper wire.
<b>C</b>	<b>Copertura Cover</b>	Gomma NEOPRENE resistente all'ozono, agli agenti atmosferici ed ai carburanti. Oil, weather, ozone, abrasion and Diesel resistant, special synthetic neoprene rubber.
	<b>Superficie Surface</b>	Liscia ad impressione tela. Smooth with fabric impression.



**FASCETTE E COLLARI STRINGITUBO CONSIGLIATE  
RECOMMENDED CLAMP/COLLAR**

STF - Fascette a vite Hose clamps with screw (pag. 204-207)  
STC - Fascette con bullone Hose clamps with bolt (pag. 208-210)



mm	mm	bar	bar	bar	gr/mt	mm	m
19	29	21	84	0,8	541	50	40
22	32	17	68	0,8	616	60	40
25,4	35	17	68	0,8	683	65	40
28	39	17	68	0,8	834	78	40
30	41	17	68	0,8	866	82	40
32	42	14	56	0,8	848	85	40
35	46	14	56	0,8	1021	90	40
38	49	10	40	0,8	1202	95	40
40	52	10	40	0,8	1256	100	40
42	54	10	40	0,8	1455	110	40
45	57	10	40	0,8	1555	110	40
50,8	62	7	28	0,8	1525	135	40
60	72	4	16	0,8	2009	175	40
63,5	75,5	4	16	0,8	2277	180	40
70	84	4	16	0,8	2725	240	40
76,2	88	4	16	0,8	2618	225	40
80	94	4	16	0,8	2950	240	20
90	103	3	12	0,8	3291	270	20-40
101,6	115	2	8	0,8	3775	400	20-40



**NORME NORMS:**  
ISO 1307  
**MARCATURA MARKING:**  
EUROCORD® SAE 100 R4 - SAE J517 I. D. A..MM  
**CONFEZIONAMENTO BOX:**  
IMBALLO IN POLIETILENE ROSSO  
PACKAGING IN RED POLYETHYLENE



**-40°C / +100°C**  
**-40°F / +212°F**

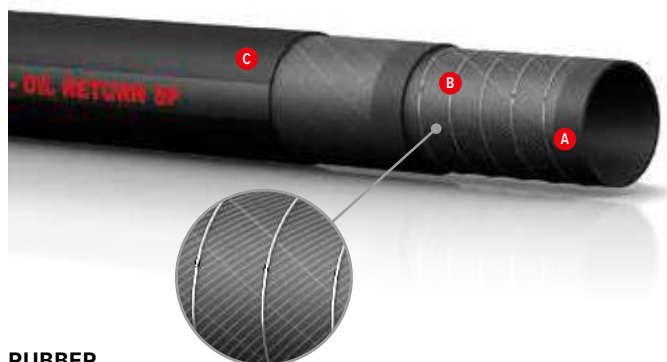

**RUBBER**



- **Ideale per settore oleodinamico, agricolo e industriale.**  
Ideal for the oleodinamic, industrial and agricultural sectors.

**IMPIEGO APPLICATIONS**

Idoneo alla mandata ed aspirazione di oli idraulici negli impianti oleodinamici. Particolarmente utilizzato a livello agricolo ed industriale; montato e raccordato sulle macchine agricole, macchine industriali, presse, etc.

Suitable for hydraulic oils suction and delivery in hydraulic plants. Particularly used in agricultural and industrial sectors.



**STRUTTURA BODY**

<b>A</b>	<b>Sottostrato Tube</b>	Gomma NBR/SBR resistente agli oli idraulici. Hydraulic oil resistant special synthetic rubber.
<b>B</b>	<b>Inserti Reinforcement</b>	Spirale metallica con inserti tessili sintetici. High tensile synthetic textile and steel wire helix.
<b>C</b>	<b>Copertura Cover</b>	Gomma SBR resistente all'ozono, agli agenti atmosferici. Oil, heat, abrasion, ozone and weather resistant special synthetic rubber.
	<b>Superficie Surface</b>	Liscia ad impressione tela. Smooth with fabric impression.

mm	mm	bar	bar	bar	gr/mt	mm	m
19	-	10	30	0,8	555	75	61
25	-	10	30	0,8	726	100	61
30	-	10	30	0,8	824	120	61
32	-	10	30	0,8	941	150	61
35	-	10	30	0,8	1004	170	61
38	-	10	30	0,8	1169	180	61
42	-	10	30	0,8	1254	190	61
51	-	10	30	0,8	1806	250	61
60	-	10	30	0,8	2050	300	61

**FASCETTE E COLLARI STRINGITUBO CONSIGLIATE RECOMMENDED CLAMP/COLLAR**

- STF - Fascette a vite Hose clamps with screw (pag. 204-207)
- STC - Fascette con bullone Hose clamps with bolt (pag. 208-210)



**NORME NORMS:**  
ISO 1307  
**MARCATURA MARKING:**  
EUROCORD® TYPE SAE 100R4 - OIL RETURN SP  
**CONFEZIONAMENTO BOX:**  
IMBALLO IN POLIETILENE ROSSO  
PACKAGING IN RED POLYETHYLENE



**-40°C / +100°C**  
**-40°F / +212°F**

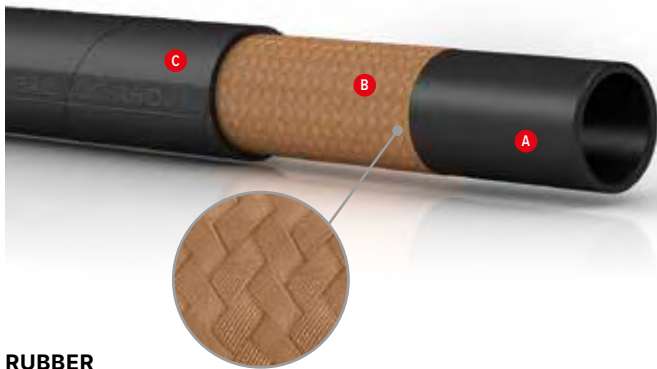

**RUBBER**



- **Conforme alle norme SAE J517 100R6 EN 854 tipo R6. SAE J517 100R6 approved.**



**IMPIEGO APPLICATIONS**

Idoneo alla mandata di fluidi idraulici, oli minerali, lubrificanti, diesel fuel. Conforme alle norme SAE J517 100R6 EN 854 tipo R6.

Suitable to the hydraulic fluids, mineral oils, lubricants and diesel fuels delivery. SAE J517 100R6 EN854 type R6 approved.



**STRUTTURA BODY**

<b>A</b>	<b>Sottostrato Tube</b>	Liscio in gomma NBR di colore nero. Oil and petrol resistant, conductive NBR.
<b>B</b>	<b>Inserti Reinforcement</b>	1 treccia di filato sintetico ad alta resistenza. 1 high tensile synthetic textile, antistatic copper wire.
<b>C</b>	<b>Copertura Cover</b>	Gomma NEOPRENE resistente all'ozono, agli agenti atmosferici ed ai carburanti. Oil, weather, ozone, abrasion and Diesel resistant, special synthetic neoprene rubber.
	<b>Superficie Surface</b>	Liscia ad impressione tela. Smooth with fabric impression.

mm	inch	mm	bar	bar	bar	gr/mt	mm	m
4,8	3/16	11,9	34	-	-	99	50	10-100
6,4	1/4	13,5	28	-	-	100	65	10-100
7,9	5/16	15,1	28	-	-	125	75	10-100
9,5	3/8	16,7	28	-	-	150	75	10-100
12,7	1/2	20,6	28	-	-	200	100	10-100
15,9	5/8	23,8	24	-	-	250	125	10-100
19	3/4	27,8	21	-	-	300	150	10-100
25,4	1	33,4	12	-	-	450	135	10-100



**NORME NORMS:**  
SAE J517 100 R6 - EN 854 TYPE R6 - ISO 1307  
**MARCATURA MARKING:**  
EUROCORD® EN 854 - SAE 100 R 6 -DIAMETER-  
PRODUCTION QUARTER  
**CONFEZIONAMENTO BOX: IMBALLO IN POLIETILENE ROSSO**  
PACKAGING IN RED POLYETHYLENE



**-40°C / +100°C**  
**-40°F / +212°F**



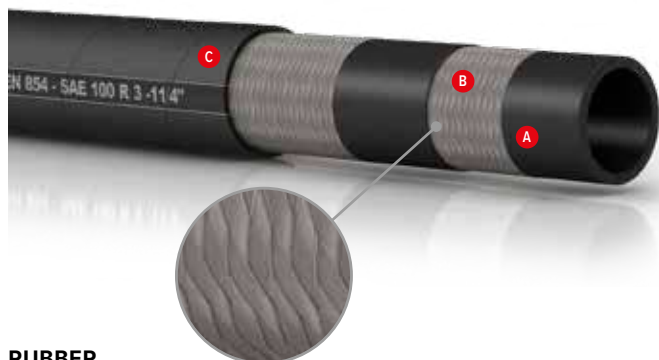

**RUBBER**



- **Conforme alle norme SAE J517 100R3 EN 854 tipo R3.**  
SAE J517 100R3 EN 854 approved.

**IMPIEGO APPLICATIONS**

Idoneo alla mandata di fluidi idraulici, oli minerali, lubrificanti, diesel fuel. Conforme alle norme SAE J517 100R3 EN 854 tipo R3.

Suitable to the hydraulic fluids, mineral oils, lubricants and diesel fuels delivery. SAE J517 100R3 EN854 type R3 approved.



**STRUTTURA BODY**

<b>A</b>	<b>Sottostrato Tube</b>	Liscio in gomma NBR di colore nero. Oil and petrol resistant, conductive NBR.
<b>B</b>	<b>Inserti Reinforcement</b>	2 trecce di filati sintetici ad alta resistenza. 2 high tensile synthetic textile, antistatic copper wire.
<b>C</b>	<b>Copertura Cover</b>	Gomma CR resistente agli agenti atmosferici, all'abrasione, ad oli e carburanti. Oil, abrasion, ozone and weather resistant black synthetic rubber.
	<b>Superficie Surface</b>	Liscia ad impressione tela. Smooth with fabric impression.

mm	inch	mm	bar	bar	bar	gr/mt	mm	m
4,8	3/16	12,7	-	-	-	160	60	10-100
6,4	1/4	14,3	-	-	-	180	80	10-100
7,9	5/16	17,5	-	-	-	265	100	10-100
9,5	3/8	19,1	-	-	-	295	100	10-100
12,7	1/2	23,7	-	-	-	425	125	10-100
15,9	5/8	27	-	-	-	500	140	10-100
19	3/4	31,8	-	-	-	700	150	10-100
25,4	1	38,1	-	-	-	845	205	10-100
31,8	1 1/4	44,5	-	-	-	990	255	10-100



**NORME NORMS:**  
SAE J517 100 R3 - EN 854 TYPE R3 - ISO 1307  
**MARCATURA MARKING:**  
EUROCORD® EN 854 - SAE 100 R 3 - DIAMETER-  
PRODUCTION QUARTER  
**CONFEZIONAMENTO BOX:**  
IMBALLO IN POLIETILENE ROSSO  
PACKAGING IN RED POLYETHYLENE



**-40°C / +100°C**  
**-40°F / +212°F**

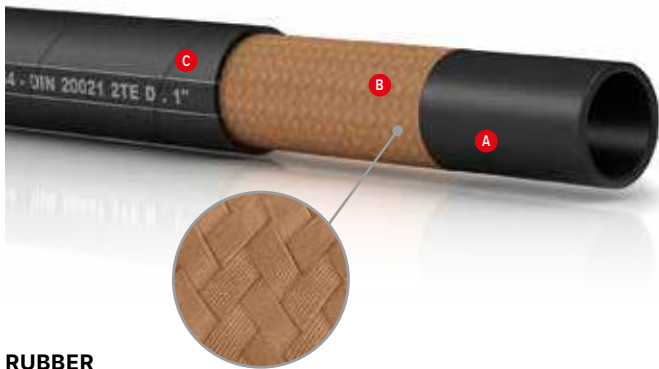

**RUBBER**



• **Conforme alle norme EN 854 DIN 20021.**  
EN 854 DIN 20021 approved.



**IMPIEGO  
APPLICATIONS**

Idoneo alla mandata di fluidi idraulici, oli minerali, lubrificanti, diesel fuel. Conforme alle norme EN 854 DIN 20021.

For hydraulic control lines, discharge under low pressure of hydraulic fluids, fuel oil, grease, air and water.  
EN 854 DIN 20021 approved.



**STRUTTURA  
BODY**

<b>A</b> <b>Sottostrato Tube</b>	Liscio in gomma CR speciale resistente agli oli idraulici. Hydraulic Oil resistant special synthetic rubber.
<b>B</b> <b>Inserti Reinforcement</b>	1 treccia tessile ad alta tenacità. 1 high tensile synthetic textile braid.
<b>C</b> <b>Copertura Cover</b>	Gomma CR resistente agli agenti atmosferici, all'abrasione, ad oli e carburanti. Oil, abrasion, ozone and weather resistant special synthetic rubber.
<b>Superficie Surface</b>	Liscia ad impressione tela. Smooth with fabric impression.

mm	inch	mm	bar	bar	bar	gr/mt	mm	m
4,8	3/16	11,8	80	320	-	114	25	10-80
6,4	1/4	13,4	75	300	-	144	40	10-80
7,9	5/16	14,9	68	272	-	165	50	10-80
9,5	3/8	16,5	63	252	-	185	60	10-80
12,7	1/2	19,8	58	232	-	237	70	10-80
15,9	5/8	23,9	50	200	-	322	90	10-80
19	3/4	27	45	180	-	382	110	10-80
25,4	1	34,4	40	160	-	557	150	10-80



**NORME NORMS:**  
EN 854 TYPE 2TE - DIN 20021 2TE - ISO 4079-1  
2TE - ISO 1307

**MARCATURA MARKING:**  
EUROCORD® EN 854 - DIN 20021 2TE (DIAM. INCH)

**CONFEZIONAMENTO BOX:**  
IMBALLO IN POLIETILENE ROSSO  
PACKAGING IN RED POLYETHYLENE



**-40°C / +100°C**  
**-40°F / +212°F**

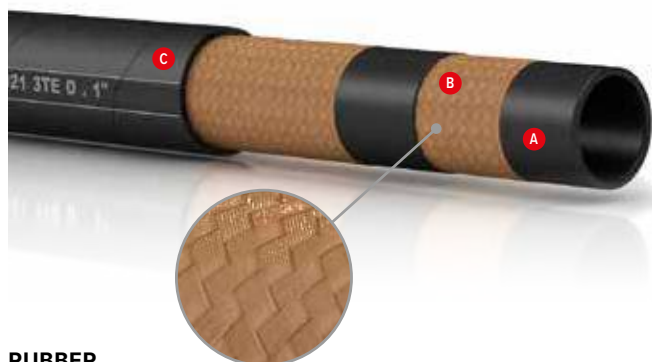

**RUBBER**



- **Conforme alle norme EN 854 DIN 20021**  
EN 854 DIN 20021 approved.

**IMPIEGO APPLICATIONS**

Idoneo alla mandata di fluidi idraulici, oli minerali, lubrificanti, diesel fuel. Conforme alle norme EN 854 DIN 20021.

For hydraulic control lines, discharge under low pressure of hydraulic fluids, fuel oil, grease, air and water.  
EN 854 DIN 20021 approved.



**STRUTTURA BODY**

<b>A</b>	<b>Sottostrato Tube</b>	Liscio in gomma CR speciale resistente agli oli idraulici. Hydraulic Oil resistant special synthetic rubber.
<b>B</b>	<b>Inserti Reinforcement</b>	2 trecce tessili ad alta tenacità. 2 high tensile synthetic textile braid.
<b>C</b>	<b>Copertura Cover</b>	Gomma CR resistente agli agenti atmosferici, all'abrasione, ad oli e carburanti. Oil, abrasion, ozone and weather resistant special synthetic rubber.
	<b>Superficie Surface</b>	Liscia ad impressione tela. Smooth with fabric impression.

mm	inch	mm	bar	bar	bar	gr/mt	mm	m
4,8	3/16	12,8	160	640	-	156	40	10-80
6,4	1/4	14,4	145	580	-	187	45	10-80
7,9	5/16	16,9	130	520	-	244	55	10-80
9,5	3/8	18,5	110	440	-	269	70	10-80
12,7	1/2	21,7	93	372	-	335	85	10-80
15,9	5/8	25,9	80	320	-	434	105	10-80
19	3/4	29	70	280	-	500	130	10-80
25,4	1	36	55	220	-	667	150	10-80
31,8	1 1/4	42,3	45	180	-	827	190	10-80
38,1	1 1/2	49,6	40	160	-	1048	240	10-80

**NORME NORMS:**  
EN 854 TYPE 3TE - DIN 20021 3TE - ISO 4079-1  
3TE - ISO 1307

**MARCATURA MARKING:**  
EUROCORD® EN 854 - DIN 20021 3TE (DIAM. INCH)

**CONFEZIONAMENTO BOX:**  
IMBALLO IN POLIETILENE ROSSO  
PACKAGING IN RED POLYETHYLENE

**-40°C / +100°C**  
**-40°F / +212°F**

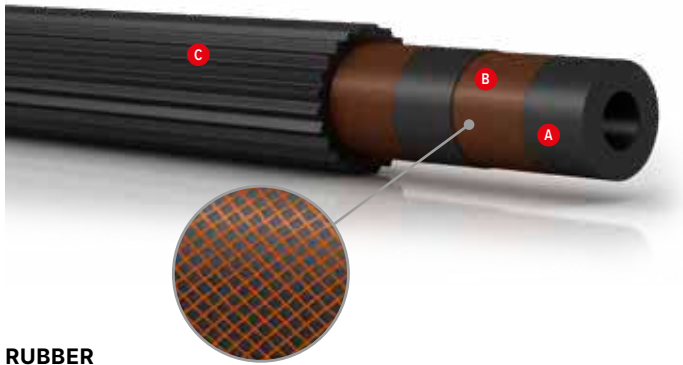

**RUBBER**



- **Conforme alle norme SAE J 1401.**  
SAE J 1401 approved.



**IMPIEGO  
APPLICATIONS**

Adatto per sistemi frenanti e fluidi idraulici degli autoveicoli.  
Conforme alle norme SAE J 1401.

Suitable for the hydraulic brake systems in the automotive sector.  
SAE J 1401 approved.



**STRUTTURA  
BODY**

<b>A</b>	<b>Sottostrato Tube</b>	Liscio in gomma NBR di colore nero. Hydraulic brake fluid resistant special synthetic rubber.
<b>B</b>	<b>Inserti Reinforcement</b>	Una treccia tessile ad alta tenacità. High tensile synthetic textile.
<b>C</b>	<b>Copertura Cover</b>	Gomma CR resistente agli agenti atmosferici, all'abrasione, ad oli e carburanti. Abrasion, ozone and weather resistant special synthetic rubber.
	<b>Superficie Surface</b>	Rigata. Braided.

mm	inch	mm	bar	bar	bar	gr/mt	mm	m
3,2	1/8	10,5	276	490	-	91	30	10-80
5	3/16	13	276	345	-	129	50	10-80



**NORME NORMS:**  
ISO 1307 - SAE J 1401  
**CONFEZIONAMENTO BOX:**  
IMBALLO IN POLIETILENE ROSSO  
PACKAGING IN RED POLYETHYLENE



**-45°C / +80°C**  
**-49°F / +176°F**

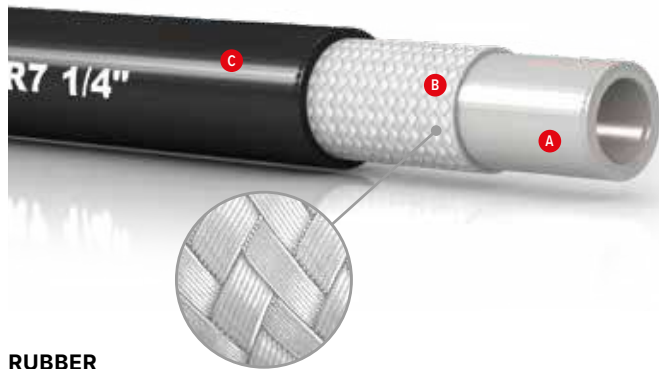

RUBBER



- **Conforme alle norme SAE J517 FEB98 100R7.**  
SAE J 517 FEB98 100R7 approved.
- **Tubo termoplastico indicato nel settore nautico.**  
Thermoplastic hose suitable for the marine sector.

**IMPIEGO APPLICATIONS**

Tubo flessibile per alta pressione termoplastico per applicazioni oleodinamiche, particolarmente indicato nel settore nautico.

Flexible and thermoplastic hose for high pressure used for hydraulic applications, particularly suitable in marine sector.

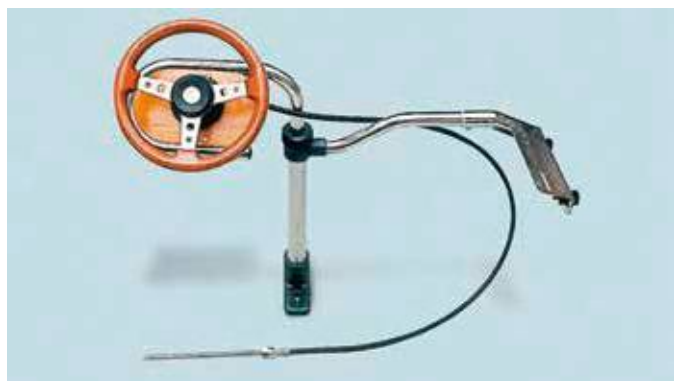

**STRUTTURA BODY**

<b>A</b>	<b>Sottostrato Tube</b>	Miscela speciale in poliestere non colorato. Special polyester compound.
<b>B</b>	<b>Inserti Reinforcement</b>	2 trecce in fibre sintetiche ad alta resistenza. 2 high resistant braids of synthetic fibers.
<b>C</b>	<b>Copertura Cover</b>	Nero liscio semilucido microforato in miscela speciale poliuretana antiolio, antiabrasione, resistente agli agenti atmosferici e all'acqua di mare, con marcatura longitudinale ad inchiostro bianco. Black smooth perforated. It has a special oil resistant and anti abrasion polyurethane compound.
	<b>Superficie Surface</b>	Liscia. Smooth.

mm	inch	mm	bar	bar	bar	gr/mt	mm	m
5	3/16	9,3	220	880	-	60	26	10-80
6,6	1/4	12,5	215	860	-	100	30	10-80
8	5/16	14,3	195	780	-	140	40	10-80
9,7	3/8	16,5	187	750	-	170	70	10-80
13	1/2	20,5	157	630	-	230	90	10-80

**NORME NORMS:**  
EN 855:1996 R7  
ISO 3949:2004/R7-1 - SAE J517 FEB98 100R7

**MARCATURA MARKING:**  
EUROCORD® SAE 100 R7 1/4"

**CONFEZIONAMENTO BOX:**  
IMBALLO IN POLIETILENE TRASPARENTE  
PACKAGING IN TRANSPARENT POLYETHYLENE

**-40°C / +100°C**  
**-40°F / +212°F**

# GUAINE E SPIRALINE DI PROTEZIONE

SPIRAL PROTECTION  
PVC HOSES

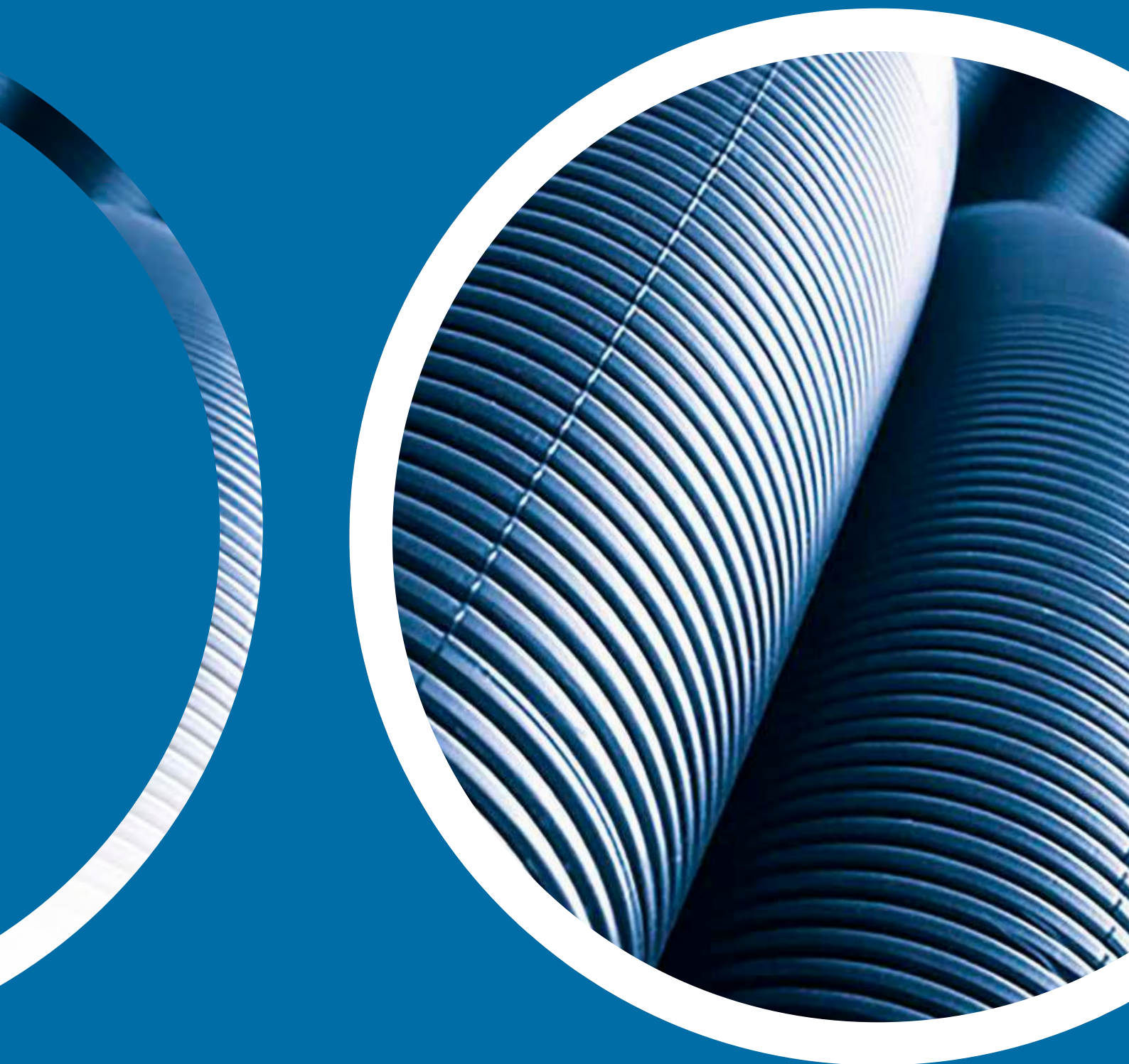



PVC

- 
**Resistente all'abrasione.**  
**Abrasion resistant.**

**IMPIEGO APPLICATIONS**







Guaina di protezione in PVC rigido, per tubi oleodinamici e cablaggi tubi multipli. Resistente all'abrasione secondo ISO 4649 <150 mm<sup>2</sup>.

PVC rigid antiabrasion spiral for the protection of hydraulic hoses and multiple electric conduits. Abrasion resistant according to ISO 4649 <150 mm<sup>2</sup>.



**STRUTTURA BODY**

<b>A</b>	<b>Materiale</b> Material	PVC rigido. PVC rigid.
<b>B</b>	<b>Inserti</b> Reinforcement	--
<b>C</b>	<b>Copertura</b> Cover	--
	<b>Superficie</b> Surface	Nero. Black.

NOMINALE NOMINAL mm	 mm	 mm	 mm	 gr/mt	 mm	 m
13×16	13	15,4	1,2	50	10	20-50
16×20	16	18,4	1,2	62	12	20-50
20×25	20	23,6	1,8	120	14,5	20-50
24×29	23,5	27,3	1,9	160	15	20-50
27×32	27	30,8	1,9	195	16	20-50
30×35	30	34,4	2,2	230	18	20-50
35×40	35,5	40	2,2	280	20,5	20-50
44×50	43,5	48	2,3	400	23	20
56×63	56	61,5	2,7	570	26	20
65×75	66	73	3,5	770	30	20
80×90	82	90	3,8	1070	34	20
100×111	103	111	4,3	1550	46	20
120×131	124	132	5,4	2050	50	20

**NORME NORMS:**  
ISO 1307

**AUTOESTINGUENZA SELF-EXTINGUISHING:**  
UL 94 VO

**DUREZZA HARDNESS:**  
SH. 78 ± 3

**MARCATURA MARKING:**  
MOLLAFLEX (Ø INT X Ø EST) MADE IN ITALY

**-5°C / +60°C**  
**+23°F / +140°F**



PVC



## IMPIEGO APPLICATIONS

Guaina di protezione antiabrasiva in materiale plastico speciale, idoneo alla protezione di tubi oleodinamici e cablaggi in macchinari agricoli ed industriali.

PVC rigid antiabrasion spiral for the protection of hydraulic hoses and multiple electric conduits.









## STRUTTURA BODY

<b>A</b>		PVC rigido. PVC rigid.
<b>Materiale</b>	<b>Material</b>	
<b>B</b>	--	
<b>Inserti</b>	<b>Reinforcement</b>	
<b>C</b>	--	
<b>Copertura</b>	<b>Cover</b>	
<b>Superficie</b>	<b>Surface</b>	Colori vari. Various colors.



- **Resistente all'abrasione.**  
Abrasion resistant.



NOMINALE NOMINAL mm							
	mm	mm	mm	gr/mt	mm	m	
7,5×10	7,5	10	1.2	35	-	20-50	
9,5×12,5	9,5	12,5	1.5	48	-	20-50	
13×16	13	16	1.5	60	-	20-50	
16×20	16	20	2.0	75	-	20-50	
20×25	20	25	2.5	140	-	20-50	
24×29	24	29	2.5	180	-	20-50	
27×32	27	32	2.5	220	-	20-50	
30×35	30	35	2.5	250	-	20-50	
35×40	35	40	2.5	310	-	20-50	
44×50	44	50	3.0	430	-	20	
56×63	56	63	3.5	610	-	20	
65×75	65	75	5.0	820	-	20	
80×90	80	90	5.0	1110	-	20	
100×110	100	110	5.0	1650	-	20	
150×159	150	162	6	2380	-	20	



**NORME** NORMS:  
ISO 1307

**DUREZZA** HARDNESS:  
SH. 78 ± 3

**MARCATURA** MARKING:  
MOLLAFLEX (Ø INT X Ø EST) MADE IN ITALY



**-20°C / +70°C**  
**+4°F / +158°F**



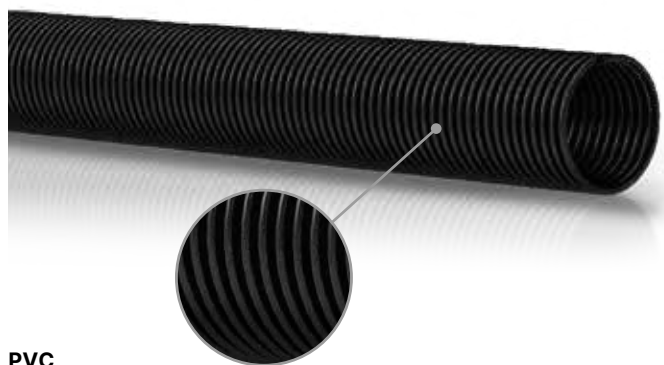

PVC



- **Idonea alla protezione di altre tubazioni.**  
Suitable for hoses protection.



**IMPIEGO**  
APPLICATIONS

È normalmente utilizzato come guaina di protezione di altre tubazioni. Viene anche utilizzato per passaggio di aria nel settore automobilistico.

Used as protective covering for other hoses, for air delivery in the car sector.



**STRUTTURA**  
BODY

<b>A</b>	<b>Materiale</b> Material	Polipropilene corrugato. Polypropylene outside corrugated.
<b>B</b>	<b>Inserti</b> Reinforcement	--
<b>C</b>	<b>Copertura</b> Cover	--
	<b>Superficie</b> Surface	Nero. Black.

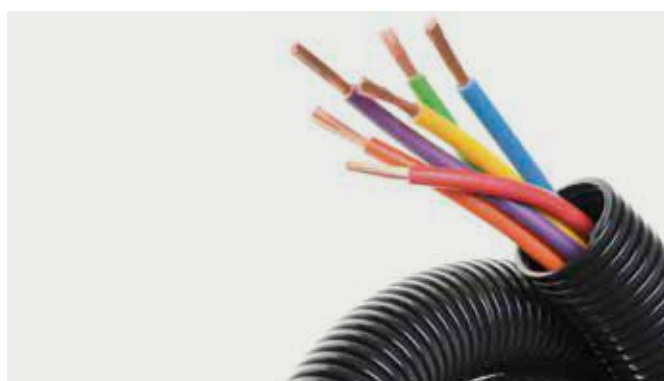

mm	mm	bar	bar	bar	gr/mt	mm	m
7,2	10	-	-	-	18	10	50
9,4	11,4	-	-	-	20	11	50
10,4	13,4	-	-	-	22	13	100
11,4	15,1	-	-	-	25	15	50
14,4	18,1	-	-	-	35	18	50
17	21,2	-	-	-	40	21	50
20	24,5	-	-	-	50	24	100
26,5	30,5	-	-	-	69	30	50
28	32,2	-	-	-	74	32	50
30,5	35	-	-	-	85	35	50
35	40,5	-	-	-	100	40	50
40,5	47,5	-	-	-	110	47	50
50,5	57,8	-	-	-	175	57	50
61	68	-	-	-	225	68	50
70	78	-	-	-	265	78	50
80	89,5	-	-	-	310	89	25
90,5	99,5	-	-	-	350	99	25
100	110,5	-	-	-	410	110	25
120	129	-	-	-	515	129	25
140	155	-	-	-	650	155	25



**NORME** NORMS:  
ISO 1307



**-5°C / +100°C**  
**+23°F / +212°F**



PVC



**IMPIEGO  
APPLICATIONS**

È ampiamente utilizzata a protezione sui macchinari di tubi idraulici, tubi di gomma, tubi in PVC e cablaggi. Questo tipo di guaina può essere utilizzato anche in campi industriali.

The tight woven construction can provide excellent abrasion resistance and high degree of burst resistance. It is widely used to protect hydraulic pipes, rubber hose, plastic pipes, wire harness from damage, this kind of sleeve can also be used in industrial and construction fields where outstanding hose productions are needed.





**STRUTTURA  
BODY**

<b>Materiale Material</b>	Guaina in polipropilene, materiale resistente agli acidi e agli alcali. La costruzione a trama stretta può fornire un'eccellente resistenza all'abrasione e un alto grado di resistenza allo scoppio. Polypropylene textile hose sleeve is produced from polypropylene which is very hard-wearing and recyclable. Polypropylene is generally acid and alkali resistant.
<b>Superficie Surface</b>	Nero. Black.



- **Guaina di protezione in polipropilene per la protezione di tubazioni.**  
Polypropylene textile hose to the hoses protection.



 <b>FLAT - m</b>	 <b>mm</b>	 <b>m</b>
30	18	100
35	21	100
40	24	100
45	28	100
50	31	100
55	35	100
60	37	100
65	41	100
80	50	50
90	56	50
100	62	50
120	76	50
150	95	50



Possibilità fornitura in altri colori e dimensioni.  
It is possible to receive the delivery in other colors or sizes.  
Lunghezze speciali fornibili su richiesta.  
Special lengths are only possible on request.  
Possibilità personalizzazione con loghi su richiesta.  
Personalization with logos possible on request.



**INFIAMMABILITÀ MELTING POINT:**  
VW-1  
**PUNTO DI FUSIONE FLAMMABILITY:**  
+125°C  
**SPESSORE STANDARD STANDARD THICKNESS:**  
1,2 mm



**-40°C / + 80°C**  
**-40°F / +176°F**



PVC



- **Calza di protezione in nylon per la protezione di tubazioni.**  
Nylon protective sleeve is made by nylon multifilament for hoses protection.



**IMPIEGO APPLICATIONS**

Comunemente utilizzata per proteggere ambienti e macchinari da possibili fuoriuscite di olio idraulico dal tubo. È ampiamente utilizzata per proteggere tubi idraulici, tubi in gomma, tubi in PVC, questo tipo di calza può essere utilizzato anche in campi industriali sempre a protezione di tubazioni flessibili.



It is used to protect people, environment and machinery against any possible hydraulic hose oil leakage or spill. It is widely used to protect hydraulic pipes, rubber hose, plastic pipes, wear harness from damage, this kind of sleeve can also be used in industrial and construction fields where outstanding hose productions are needed.



**STRUTTURA BODY**

<b>Materiale Material</b>	Guaina di protezione realizzata attraverso un multifilamento in nylon. La costruzione a trama stretta fornisce un'eccellente resistenza all'abrasione e un elevato grado di resistenza allo scoppio. Nylon protective sleeve is made by nylon multifilament. The tight woven construction can provide excellent abrasion resistance and high degree of burst resistance.
<b>Superficie Surface</b>	Nero. Black.



 FLAT - m	 mm	 m
20	12	100
25	14	100
30	17	100
35	20	50
40	23	50
45	26	50
50	31	50
60	37	50
70	44	50
80	50	50
90	56	50
100	62	50
115	72	50
145	90	50
176	110	50



**INFIAMMABILITÀ MELTING POINT:**  
VW-1  
**PUNTO DI FUSIONE FLAMMABILITY:**  
+260°C  
**SPESSORE STANDARD STANDARD THICKNESS:**  
1,2 mm



**-60°C / + 160°C**  
**-76°F / +320°F**

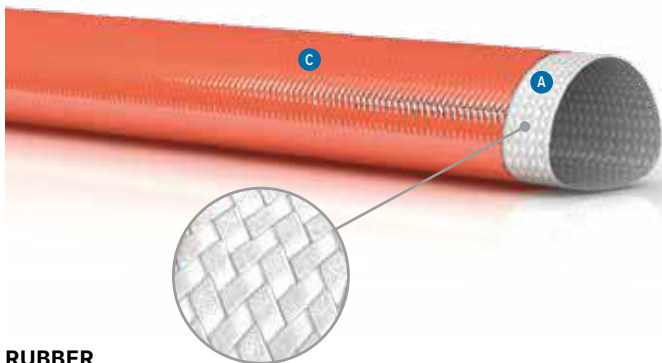

**RUBBER**



**IMPIEGO APPLICATIONS**

Utilizzata per isolare i tracciatori di linee a vapore nelle raffinerie di olio, come isolante termico ed elettrico per l'industria di cavi e fili, nelle creazioni in vetro, per le coperture delle estremità rifinite in metallo, fonderie e acciaierie e qualunque altra applicazione dove è richiesta una barriera protettiva per l'alta temperatura.

It is used to insulate steam tracer lines in oil refineries, as thermal and electrical insulation for the wire and cable industry, in glass manufacturing, for covering tines in metal refining, foundries and steel mills, and wherever else a high temperature barrier might be required.



**STRUTTURA BODY**

**A**

**Sottostrato Tube**

La calza in fibra di vetro con silicone è costituita da fili di fibra di vetro "E" ed è utilizzata in situazioni ambientali quando le temperature superano i 1000° F (538°C). Grazie a questa costruzione unica, la fibra di vetro si adatta facilmente ai tubi e ai cavi in modo aderente. Fornisce uno spessore parete più grande per cui offre un migliore isolamento dal calore.

Protech/SIL is a braided sleeving which is manufactured from E-fiberglass yarn. It is used in demanding environments where temperatures reach up to 1000 degrees F (538 degrees C.). Due to its unique construction, wall thickness at a nominal weight increase thereby providing better insulation against heat.

**B**

**Inseriti Reinforcement**

--

**C**

**Copertura Cover**

Silicone.  
Silicon.

**Superficie Surface**

Esterna lucida.  
Shiny exterior.



- **Resistente alle alte temperature.**  
High temperature resistant.

Filamento in fibra di vetro Fiberglass filament	Tipo Type "E"
Diametro fibra di vetro Fiberglass diameter	9 Micron
Resistenza alla fiamma Fire resistance	Autoestinguente (V2) Self-extinguishes
Resistente alla lacerazione Rip resistance	19 kN/m
Carico di rottura Tensile strength	10 MPa
Allungamento alla rottura Continuous operating temperature	260%
Rigidità dielettrica Dielectric strength	26 kV/mm
Densità a 23°C Density at 23°C	1,16 g/cm <sup>2</sup>

	PARETE DI VETRO FIBERGLASS	PARETE IN SILICONE SILICON COVER		
mm	mm	mm	gr/mt	m
10	2,5	1,0	-	20
12	2,5	1,0	-	20
15	2,5	1,0	-	20
20	2,5	1,0	-	20
25	2,5	1,0	-	20
30	2,5	1,0	-	20
35	2,5	1,0	-	20
38	2,5	1,0	-	20
40	2,5	1,0	-	20
42,5	2,5	1,0	-	20
45	2,5	1,0	-	15
50	2,5	1,0	-	15
60	2,5	1,0	-	15
65	2,5	1,0	-	15
70	2,5	1,0	-	15
75	2,5	1,0	-	15
80	2,5	1,0	-	15
85	2,5	1,0	-	15
90	2,5	1,0	-	15
100	2,5	1,0	-	15
115	2,5	1,0	-	15
125	2,5	1,0	-	15



**NORME NORMS:**  
R.I.N.A APPROVED ACCORDING TO ISO  
15540:199(E) AND ISO 15541-199 (E) - UL 1441 VW-1



**+260°C**  
**+500°F**

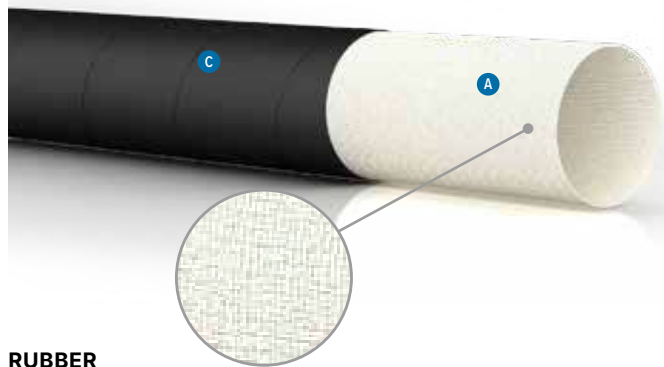

**RUBBER**



- **Guaina di protezione per cavi elettrici.**  
Protection sleeve for electrical cables.

**IMPIEGO APPLICATIONS**

Guaina per protezioni di cavi elettrici e tubazioni delle macchine saldatrici e in tutte le applicazioni ove viene richiesta una protezione particolarmente gravosa.

Cable protection in industrial applications and welding machines.



**STRUTTURA BODY**

<b>A</b>	<b>Sottostrato Tube</b>	Gomma NR CBR di colore nero. Special synthetic rubber.
<b>B</b>	<b>Inserti Reinforcement</b>	Tessili sintetici ad alta resistenza. High tensile synthetic textile
<b>C</b>	<b>Copertura Cover</b>	Gomma NR/SBR di colore nero, resistente all'abrasione agli agenti atmosferici ed all'invecchiamento. Abrasion, ozone and weather resistant special synthetic rubber.
	<b>Superficie Surface</b>	Liscia ad impressione tela. Smooth with fabric impression.

mm	mm	bar	bar	bar	gr/mt	mm	m
16	19	-	-	-	105	-	40
19	22	-	-	-	125	-	40
20	23	-	-	-	131	-	40
22	25	-	-	-	143	-	40
25	28	-	-	-	164	-	40
28	31	-	-	-	180	-	40
30	33	-	-	-	192	-	40
32	35	-	-	-	204	-	40
35	38	-	-	-	223	-	40
38	41	-	-	-	241	-	40
40	43	-	-	-	253	-	40
42	45	-	-	-	266	-	40
51	54	-	-	-	319	-	40
57	60	-	-	-	357	-	40

**NORME NORMS:**  
ISO 1307

**-30°C / +80°C**  
**-22°F / +176°F**

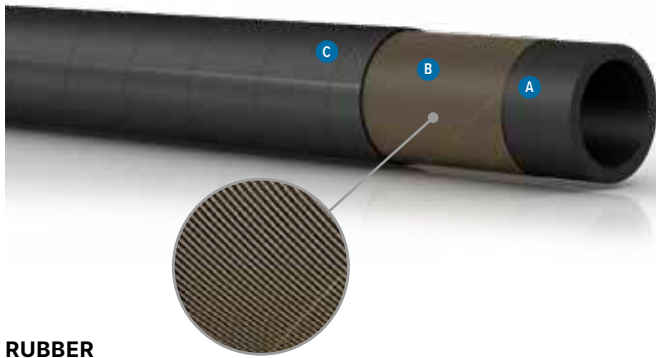

**RUBBER**



**IMPIEGO  
APPLICATIONS**







Per vibratori pneumatici o elettrici, per il livellamento delle gettate di calcestruzzo. Le gomme utilizzate conferiscono al tubo eccezionali caratteristiche di allungamento e trazione, la struttura particolarmente spessorata garantisce di evitare, anche in casi di raggi di curvatura molto stretti, la formazione di cuspidi.

Utilized on submerged vibrators to prevent air bubbles in the concrete liquid projected by hand vibrating. Excellent traction and elongation characteristics thanks to its special rubber. The thickened structure avoid hose kinking.



**STRUTTURA  
BODY**

<b>A</b>	<b>Sottostrato Tube</b>	Gomma NR/SBR di colore nero. Special synthetic rubber.
<b>B</b>	<b>Inserti Reinforcement</b>	Tessili sintetici ad alta resistenza. High tensile synthetic textile
<b>C</b>	<b>Copertura Cover</b>	Gomma NR/SBR di colore nero, resistente all'abrasione agli agenti atmosferici ed all'invecchiamento. Abrasion, ozone and weather resistant special synthetic rubber.
	<b>Superficie Surface</b>	Liscia ad impressione tela. Smooth with fabric impression.

 mm	 mm	 bar	 bar	 bar	 gr/mt	 mm	 m
19	30	10	30	-	587	190	40-60
22	30	10	30	-	430	220	40-60
25	36	10	30	-	682	250	40-60
25	39	10	30	-	926	250	40-60
25	42	10	30	-	1190	250	40-60
28	44	10	30	-	1245	280	40-60
38	54	10	30	-	1318	380	40-60
40	54	10	30	-	1419	400	40-60



**NORME NORMS:**  
ISO 1307  
**CONFEZIONAMENTO BOX:**  
IMBALLO IN POLIETILENE GIALLO  
PACKAGING IN YELLOW POLYETHYLENE



**-40°C / +70°C**  
**-40°F / +158°F**

# TUBI TRECCIATI TESSILI E IN ACCIAIO

TEXTILE AND STEEL WIRE HOSES

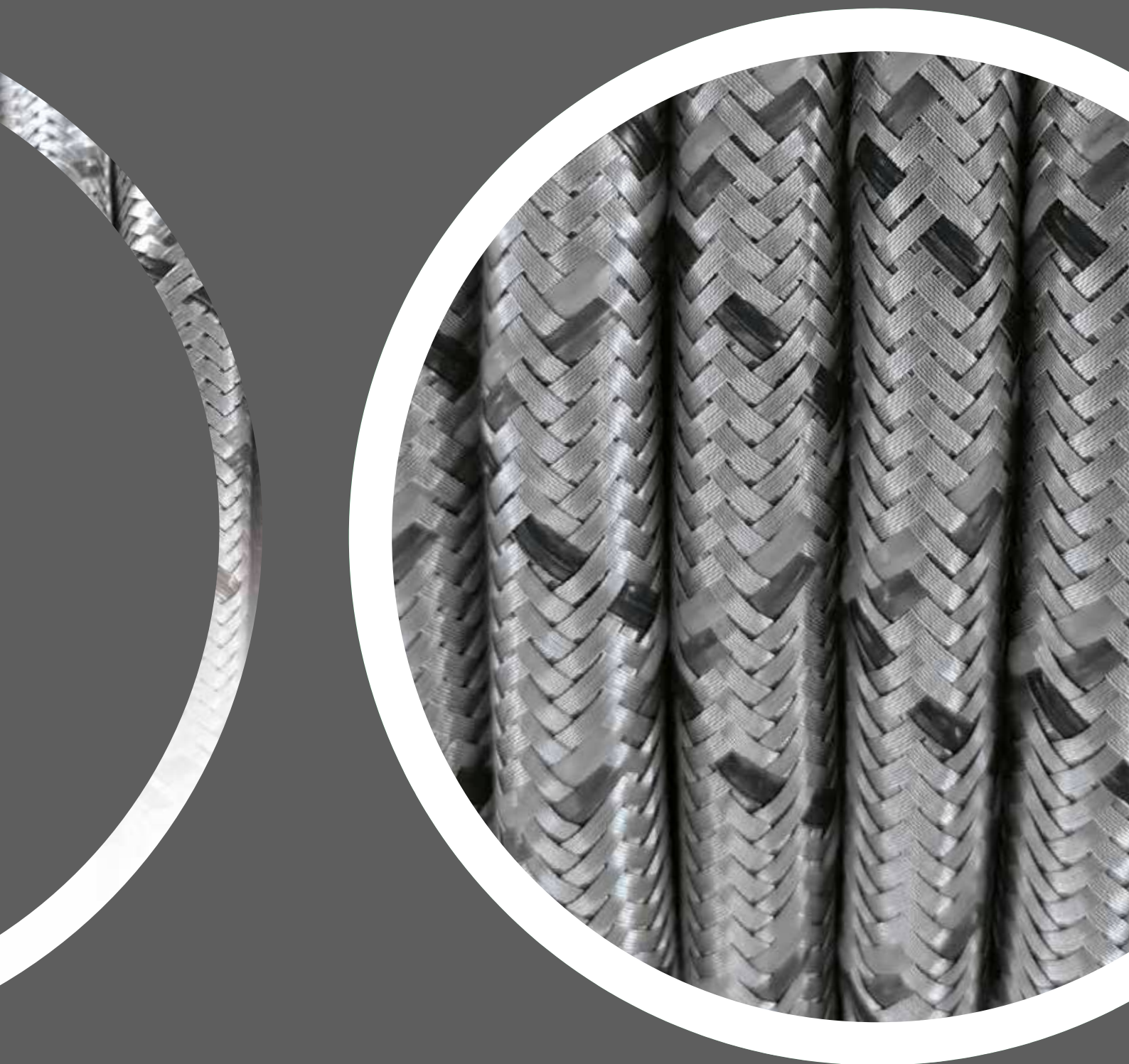
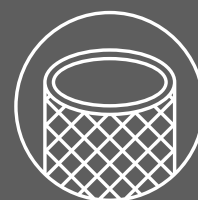

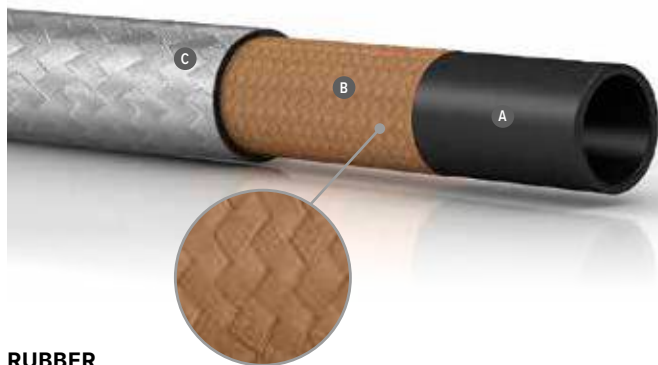

RUBBER



- **Tubo trecciato per mandata fluidi idraulici.**  
Galvanized steel wire hose for the hydraulic fluids delivery.
- **Ideale nel settore oleodinamico.**  
Ideal for the hydraulic sector.



## IMPIEGO APPLICATIONS

Tubo in gomma trecciato in acciaio zincato idoneo per mandata di fluidi idraulici, oli minerali, lubrificanti, diesel fuel, nafte ed aria.

Galvanized steel wire rubber hose suitable for delivery of hydraulic fluid, oils, lubricants and air.

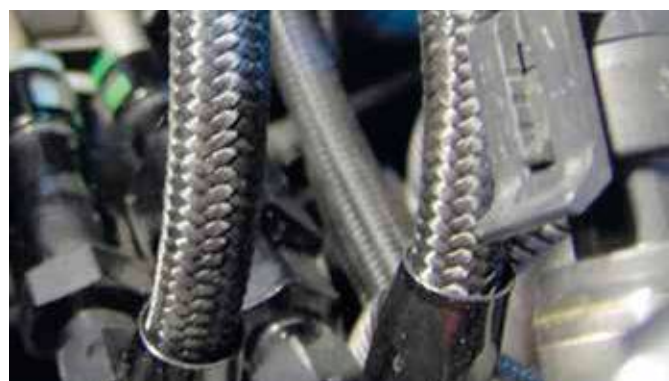

## STRUTTURA BODY

<b>A</b>	Liscio in gomma NBR di colore nero. Black, smooth NBR rubber.
<b>B</b>	Trecce di filato sintetico ad alta resistenza. High tensile synthetic textile braid.
<b>C</b>	Liscia impressione tela in gomma CR resistente all'abrasione agli oli e agli agenti atmosferici. Smooth, fabric finished, black, abrasion, oils and weather resistant CR rubber.
<b>Superficie Surface</b>	Trecciata in acciaio zincato. Galvanized braided finished.

mm	mm	bar	bar	bar	gr/mt	mm	m
4,8	11,9	34	136	-	99	50	10-100
6,4	13,5	28	112	-	100	65	10-100
7,9	15,1	28	112	-	125	75	10-100
9,5	16,7	28	112	-	150	75	10-100
12,7	20,6	28	112	-	200	100	10-100
15,9	23,8	24	96	-	250	125	10-100
19	27,8	21	84	-	300	150	10-100
25,4	33,4	12	48	-	450	135	10-100



**NORME NORMS:**  
SAE J 517 - SAE 100 R6 - EN 854 TYPE R6 - ISO 1307

**CONFEZIONAMENTO BOX:**  
IMBALLO IN CARTONE  
CARTON BOXES



**-40°C / +100°C**  
**-40°F / +212°F**



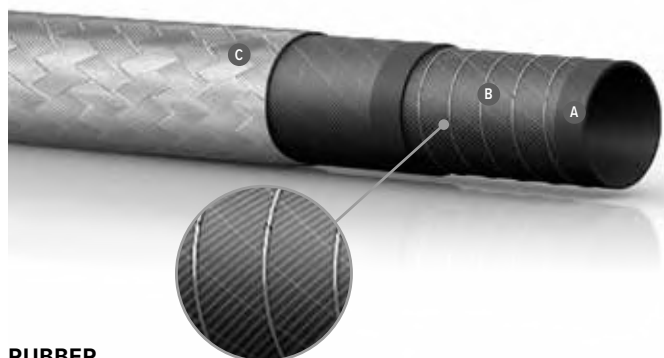

RUBBER



- **Tubo trecciato per mandata fluidi idraulici.**  
Galvanized steel wire hose for the hydraulic fluids delivery.
- **Ideale nel settore oleodinamico.**  
Ideal for the hydraulic sector.

**IMPIEGO APPLICATIONS**

Tubo in gomma spiraleto trecciato in acciaio zincato idoneo per aspirazione e mandata di fluidi idraulici, oli minerali e carburanti.

Galvanized steel wire rubber hose suitable for suction and delivery of hydraulic fluids, mineral oils and fuels.

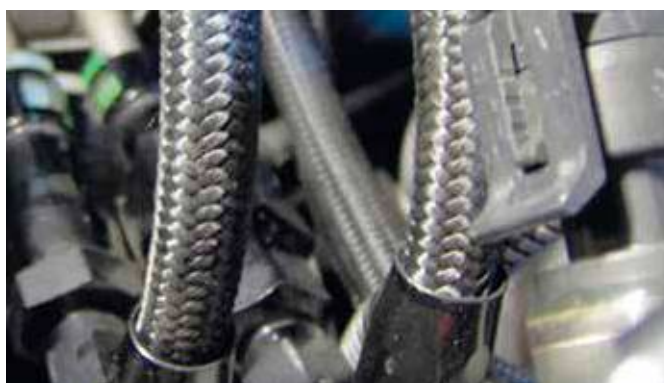

**STRUTTURA BODY**

<b>A</b>	<b>Sottostrato Tube</b>	Liscio in gomma nera NBR resistente ai prodotti petroliferi con contenuto aromatico non superiore al 40%. Black, smooth, petroleum products up to 40% aromatic content resistant NBR rubber.
<b>B</b>	<b>Inserti Reinforcement</b>	Spirale metallica incorporata con tessuti sintetici ad alta resistenza, cordicella di rame. Steel wire helix with high strength synthetic textile plies. Copper wire.
<b>C</b>	<b>Copertura Cover</b>	Liscia impressione tela in gomma nera CR/NBR resistente all'abrasione, ai carburanti, agli oli ed agli agenti atmosferici e al calore. Oil, heat, abrasion, ozone and weather resistant special synthetic rubber.
	<b>Superficie Surface</b>	Trecciata in acciaio zincato. Galvanized braided finished.

mm	mm	bar	bar	bar	gr/mt	mm	m
19	30,2	21	84	0,8	840	115	40
22	31,2	10	30	0,8	910	130	40
25,4	36,2	17	68	0,8	1080	150	40
28	40,2	10	68	0,8	1160	170	40
32	43,2	14	56	0,8	1440	190	40
35	47,2	10	30	0,8	1630	210	40
38	50,2	10	40	0,8	1670	230	40
40	53,2	10	30	0,8	1800	240	40
42	57,2	10	30	0,8	2030	255	40
45	58,2	10	30	0,8	2190	270	40
50,8	63,2	10	30	0,8	2310	305	40
60	73,2	10	30	0,8	2970	360	40
63,5	76,7	10	30	0,8	3250	380	40
70	85,2	10	30	0,8	3950	420	40
76,2	89,2	10	30	0,8	4210	460	40
90	104,2	10	30	0,8	5010	540	20-40
102	116,2	10	30	0,8	5680	610	20-40



**NORME NORMS:**  
SAE J 517 - SAE 100 R4 - ISO 1307  
**CONFEZIONAMENTO BOX:**  
IMBALLO IN CARTONE  
CARTON BOXES



**-40°C / +93°C**  
**-40°F / +199,4°F**

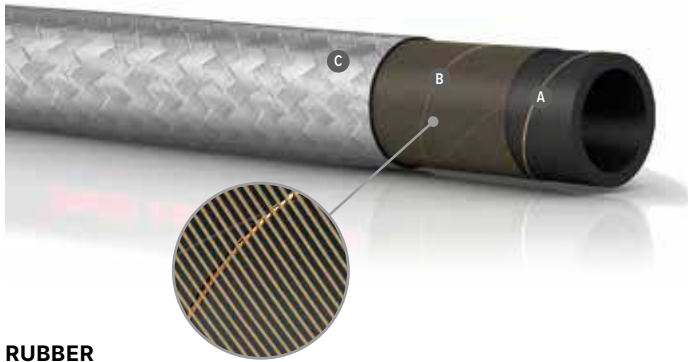

**RUBBER**



- **Tubo trecciato per mandata carburanti nei motori a combustione interna.**  
Galvanized steel wire hose for the fuel delivery in internal combustion engines.
- **Ottima leggerezza e flessibilità.**  
Excellent lightness and flexibility.



**IMPIEGO  
APPLICATIONS**









Idoneo per mandata di carburanti nei motori a combustione interna, lubrificazione ed ingrassaggio di macchinari; particolarmente indicato ove siano richieste caratteristiche di leggerezza e flessibilità.

For delivery of fuels in internal combustion engines for lubrication and greasing services. Particularly used where it is necessary lightness and flexibility.



**STRUTTURA  
BODY**

<b>A</b> <b>Sottostrato Tube</b>	Liscio in gomma NBR di colore nero resistente ad oli e carburanti con contenuto di aromatici fino al 40%. Fuel and oil resistant up to 40%, smooth NBR rubber.
<b>B</b> <b>Inserti Reinforcement</b>	Tessili sintetici. High tensile synthetic textile.
<b>C</b> <b>Copertura Cover</b>	Liscia in gomma NBR resistente ad oli e carburanti. Abrasion, ozone, weather and oil resistant special synthetic rubber.
<b>Superficie Surface</b>	Rivestimento in calza di acciaio inox. Galvanized steel wire braided cover.

 mm	 mm	 bar	 bar	 bar	 gr/mt	 mm	 m
4	10,2	10	30	-	300	40	100
5	13,2	10	30	-	350	50	100
6	13,2	10	30	-	440	50	100
8	16,2	10	30	-	540	65	100
10	18,2	10	30	-	660	80	100
13	21,2	10	30	-	740	105	100
15	24,2	10	30	-	770	120	50
19	28,2	10	30	-	755	130	50
25	36,2	10	30	-	950	150	50



**NORME NORMS:**  
ISO 1307  
**CONFEZIONAMENTO BOX:**  
IMBALLO IN CARTONE  
CARTON BOXES



**-35°C / +70°C**  
**-31°F / +158°F**

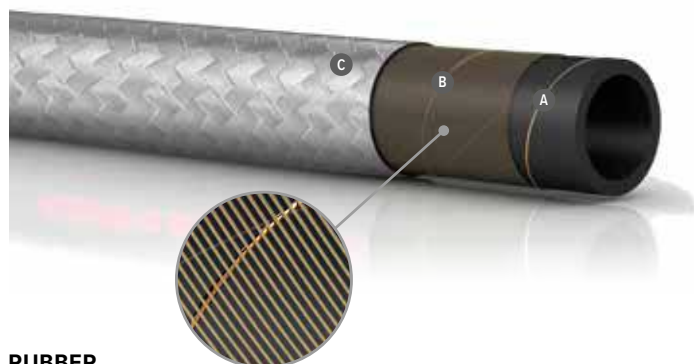

**RUBBER**



- **Tubo trecciato per mandata oli e carburanti.**  
Galvanized steel wire hose for the oils and fuels delivery.

**IMPIEGO APPLICATIONS**

Idoneo alla mandata di oli minerali, gasolio, benzine e carburanti. Particolarmente indicato allo scarico e carico in sola mandata delle autoferrocisterne, nelle raffinerie e stazioni di servizio.

For delivery of petroleum products with aromatic content up to 50%.



**STRUTTURA BODY**

<b>A</b> Sottostrato Tube	Gomma NBR di colore nero, resistente ai carburanti, con contenuto aromatico non superiore al 50%. Oil and petrol resistant up to 50%, black NBR.
<b>B</b> Inseri Reinforcement	Tessili e sintetici con cordicella di rame per garantire la dissipazione dell'elettricità statica. High tensile synthetic textile and antistatic copper wire.
<b>C</b> Copertura Cover	Gomma NBR/SBR resistente ai carburanti, agli oli, all'ozono e agli agenti atmosferici. Abrasion, ozone, weather and oil resistant special synthetic rubber.
Superficie Surface	Rivestimento in calza di acciaio zincato. Galvanized steel wire braided cover.

mm	mm	bar	bar	bar	gr/mt	mm	m
19	28,2	10	30	-	430	-	40
25	39,2	10	30	-	560	-	40
30	41,2	10	30	-	800	-	40
32	43,2	10	30	-	850	-	40
35	46,2	10	30	-	930	-	40
38	49,2	10	30	-	970	-	40
40	51,2	10	30	-	1050	-	40
45	57,2	10	30	-	1200	-	40
50	63,2	10	30	-	1350	-	40
60	73,2	10	30	-	1700	-	40

**NORME NORMS:**  
ISO 1307

**CONFEZIONAMENTO BOX:**  
IMBALLO IN CARTONE  
CARTON BOXES

**-35°C / +70°C**  
**-31°F / +158°F**

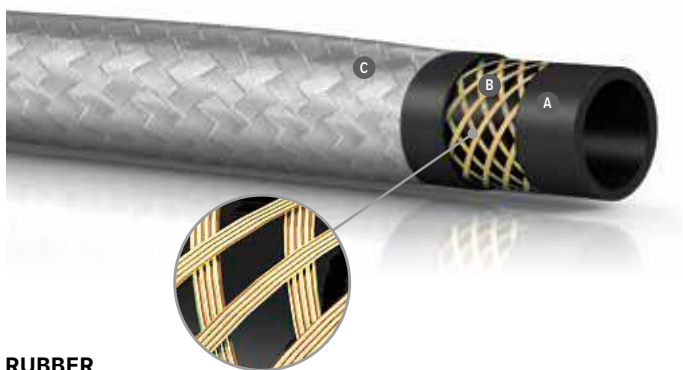

**RUBBER**



- **Tubo trecciato idoneo per mandata ad alta pressione di fluidi idraulici.**  
Galvanized steel wire hose for the high pressure delivery of hydraulic fluids.



**IMPIEGO APPLICATIONS**









Tubo in gomma con rinforzo in acciaio trecciato idoneo per mandata ad alta pressione di fluidi idraulici a base di oli minerali e lubrificanti vegetali e minerali.

Rubber hose suitable for delivery of high pressure hydraulic fluids, using hydraulic oils mineral and vegetable lubricants.



**STRUTTURA BODY**

<b>A</b> <b>Sottostrato Tube</b>	Gomma sintetica resistente ai fluidi idraulici a base di oli minerali e vegetali. Syntetic rubber, extruded whole without joints of uniform thickness.
<b>B</b> <b>Inserti Reinforcement</b>	1 treccia in acciaio ad alta resistenza. 1 high strength steel wire braid.
<b>C</b> <b>Copertura Cover</b>	Liscia impressione tela in gomma nera resistente all'abrasione, ai carburanti, agli oli ed agli agenti atmosferici. Smooth, fabric finished, oil abrasion and weather resistant special synthetic rubber.
<b>Superficie Surface</b>	Trecciata in acciaio zincato. Galvanized braided finished.

 mm	 mm	 bar	 bar	 bar	 gr/mt	 mm	 m
6,4	13,5	225	1100	-	280	75	LUNGHEZZA VARIABILE VARIABLE SIZE
8	14,7	215	1050	-	320	85	
9,5	16,9	180	880	-	390	90	
12,7	20,1	160	700	-	510	130	
16	23,6	130	650	-	620	150	
19	27,1	105	520	-	740	180	
25,4	34,9	88	430	-	1040	230	
31,8	44,7	63	250	-	1270	420	
38,1	52	50	200	-	1596	500	



**NORME NORMS:**  
ISO 1307  
**CONFEZIONAMENTO BOX:**  
IMBALLO IN CARTONE  
CARTON BOXES



**-40°C / +100°C**  
**-40°F / +212°F**

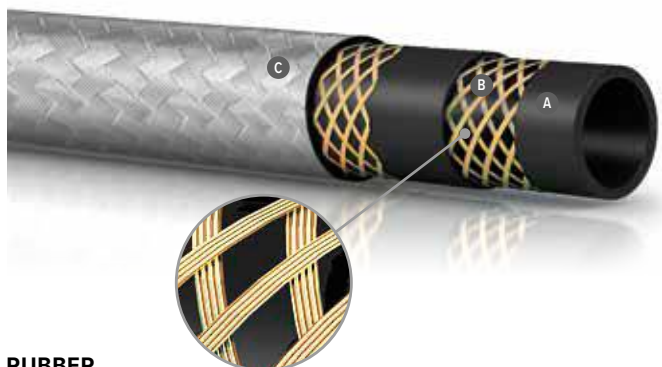

**RUBBER**



- **Tubo trecciato per mandata ad alta pressione di fluidi idraulici.**  
Galvanized steel wire hose for the high pressure delivery of hydraulic fluids.

**IMPIEGO APPLICATIONS**

Tubo in gomma con rinforzo in acciaio trecciato idoneo per mandata ad alta pressione di fluidi idraulici a base di oli minerali e lubrificanti vegetali e minerali.

Rubber hose suitable for delivery of high pressure hydraulic fluids, using hydraulic oils mineral and vegetable lubricants.



**STRUTTURA BODY**

<b>A</b> <b>Sottostrato Tube</b>	Gomma sintetica resistente ai fluidi idraulici a base di oli minerali e vegetali. Mineral vegetable and hydraulic synthetic rubber.
<b>B</b> <b>Inserti Reinforcement</b>	2 trecce in acciaio ad alta resistenza. 2 high strength steel wire braid.
<b>C</b> <b>Copertura Cover</b>	Liscia impressione tela in gomma nera resistente all'abrasione ai carburanti, agli oli ed agli agenti atmosferici. Smooth, fabric finished, oil abrasion and weather resistant special synthetic rubber.
<b>Superficie Surface</b>	Trecciata in acciaio zincato. Galvanized braided finished.

mm	mm	bar	bar	bar	gr/mt	mm	m
6,4	14,5	400	1850	-	390	75	LUNGHEZZA VARIABILE VARIABLE SIZE
8	16	350	1700	-	460	85	
9,5	18,3	330	1550	-	550	90	
12,7	21,6	275	1270	-	740	130	
16	24,7	250	1150	-	910	170	
19	28,8	215	1000	-	1070	200	
25,4	37	165	840	-	1510	250	
31,8	49,5	125	500	-	2035	420	
38,1	55,8	90	360	-	2300	500	

**NORME NORMS:**  
ISO 1307

**MARCATURA MARKING:**  
EUROCORD® OIL DELIVERY HOSE W.P. 10 BAR

**CONFEZIONAMENTO BOX:**  
IMBALLO IN CARTONE  
CARTON BOXES

**-40°C / +100°C**  
**-40°F / +212°F**

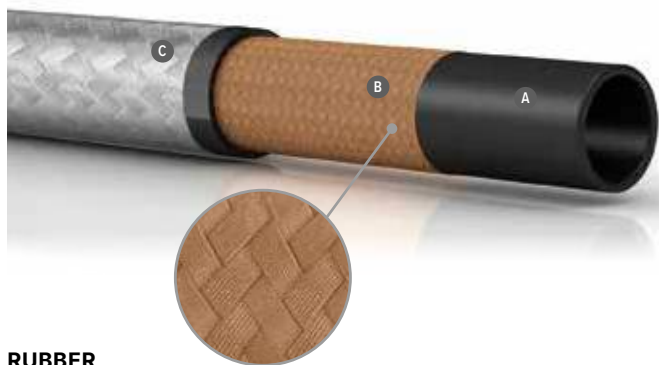

RUBBER



- **Tubo trecciato per mandata fluidi idraulici.**  
Galvanized steel wire hose for the hydraulic fluids delivery.



## IMPIEGO APPLICATIONS

Tubo in gomma trecciato in acciaio zincato idoneo per mandata di fluidi idraulici, oli, lubrificanti, nafte ed aria.

Galvanized steel wire rubber hose suitable for delivery of hydraulic fluid, oils, lubricants and air.



## STRUTTURA BODY

<b>A</b> Sottostrato Tube	Liscio in gomma nera antiabrasiva (NR/NBR). Black, smooth NR/NBR rubber.
<b>B</b> Inserti Reinforcement	Tessili sintetici ad alta tenacità. High strength synthetic textile braid.
<b>C</b> Copertura Cover	Liscia ad impressione tela in gomma CR resistente all'abrasione, agli oli e agli agenti atmosferici. Smooth, fabric finished, black, abrasion, oils and weathering resistant CR rubber.
<b>Superficie Surface</b>	Trecciata in acciaio zincato. Galvanized braided finished.

mm	inch	mm	bar	bar	bar	gr/mt	mm	m
4,8	3/16	13	80	320	-	220	25	10-80
6,4	1/4	14,6	75	300	-	260	40	10-80
7,9	5/16	16,1	68	272	-	290	50	10-80
9,5	3/8	17,7	63	252	-	320	60	10-80
12,7	1/2	21	58	232	-	410	70	10-80
15,9	5/8	25,1	50	200	-	540	90	10-80
19	3/4	28,2	45	180	-	630	110	10-80
25,4	1	35,6	40	160	-	890	150	10-80



**NORME NORMS:**  
EN 854 TYPE 2TE - DIN 20021 2TE - ISO 4079/1  
2TE - ISO 1307

**CONFEZIONAMENTO BOX:**  
IMBALLO IN CARTONE  
CARTON BOXES



**-40°C / +100°C**  
**-40°F / +212°F**

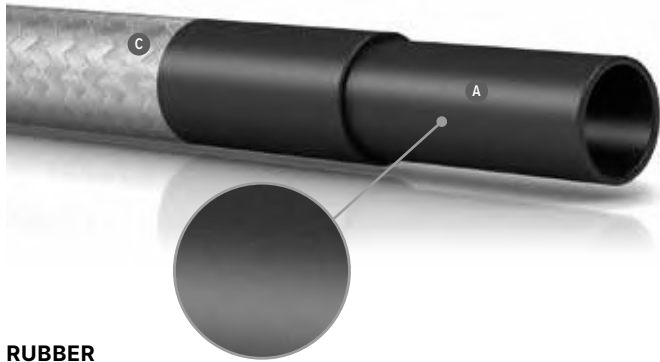

**RUBBER**



- **Tubo NBR trecciato flessibile.**  
Flexible NBR galvanized steel wire hose.



**IMPIEGO  
APPLICATIONS**

Tubo flessibile per mandata di oli minerali, lubrificanti e gasolio.

For delivery of transmission oil, fuel oil, gasoline.



**STRUTTURA  
BODY**

<b>A</b> Sottostrato Tube	Liscio, nero, monoestruso in gomma NBR durezza shore 80 A+/-5. Black, smooth, monolayer NBR rubber with hardness 80 shore A+/-5.
<b>B</b> Inserti Reinforcement	--
<b>C</b> Copertura Cover	Trecciatura di filo di acciaio zincato con due fili di identificazione: rosso e nero. Galvanized steel wire braiding with two identification wires: red and black.
<b>Superficie Surface</b>	Trecciata. Galvanized wire braid.

mm	inch	mm	bar	bar	bar	gr/mt	mm	m
6	1/4	11	25	75	-	-	-	50-100
8	5/16	13	25	75	-	-	-	50-100
10	3/8	15	25	75	-	-	-	50-100
13	1/2	19	20	60	-	-	-	50-100
16	5/8	22	20	60	-	-	-	40-50
19	3/4	25	15	45	-	-	-	40-50
25	1	33	15	45	-	-	-	40-50



**FASCETTE E COLLARI STRINGITUBO CONSIGLIATE  
RECOMMENDED CLAMP/COLLAR**

STF - Fascette a vite Hose clamps with screw (pag. 204-207)



**NORME NORMS:**  
EN 854 TYPE 2TE - DIN 20021 2TE - ISO 4079/1  
2TE - ISO 1307  
**CONFEZIONAMENTO BOX:**  
IMBALLO IN CARTONE  
CARTON BOXES



**-35°C / +90°C**  
**-31°F / +194°F**

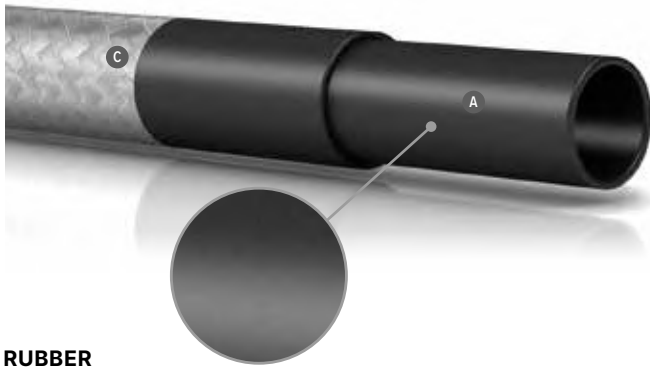

**RUBBER**



- **Tubo EPDM trecciato flessibile.**  
Flexible EPDM galvanized steel wire hose.



**IMPIEGO  
APPLICATIONS**

Tubo flessibile per mandata in pressione di acqua calda e liquidi non corrosivi in attrezzature ed impianti di vario genere.

For the delivery of water and liquids with light chemical content.



**STRUTTURA  
BODY**

<b>A</b>	<b>Sottostrato Tube</b>	Liscio nero in gomma EPDM durezza shore 80 A +/-5. Smooth black EPDM rubber.
<b>B</b>	<b>Inserti Reinforcement</b>	Tessili sintetici. High tensile synthetic textile.
<b>C</b>	<b>Copertura Cover</b>	Trecciatura di filo di acciaio zincato con due fili di identificazione: rosso e blu. Galvanized steel wire braiding with two identification wires: red and blue.
	<b>Superficie Surface</b>	Trecciata. Braided.

mm	inch	mm	bar	bar	bar	gr/mt	mm	m
10	3/8	15	25	75	-	-	-	40-100
13	1/2	19	25	75	-	-	-	40-100
16	5/8	23	20	60	-	-	-	40-50
19	3/4	26	20	60	-	-	-	40-50
25	1	33	15	45	-	-	-	40-50
32	1 1/4	43	10	30	-	-	-	40
35	1 3/8	48	10	30	-	-	-	40
38	1 1/2	51	10	30	-	-	-	40
40	1 9/16	53	10	30	-	-	-	40
45	1 49/64	61	10	30	-	-	-	40
51	2	64	10	30	-	-	-	40
60	2 23/64	82	10	30	-	-	-	40



**NORME NORMS:**  
ISO 1307  
**CONFEZIONAMENTO BOX:**  
IMBALLO IN CARTONE  
CARTON BOXES



**-30°C / +100°C**  
**-22°F / +212°F**



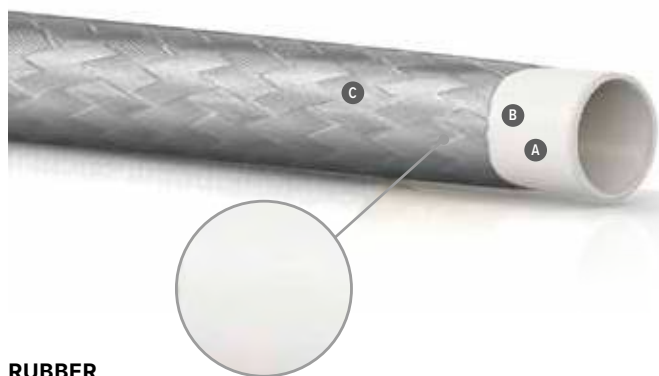

**RUBBER**

**IMPIEGO APPLICATIONS**

Tubo in P.T.F.E. trecciato in acciaio inox idoneo per impianti idraulici, circuiti di lubrificazione, passaggio carburanti e vapori ad alta temperatura. Particolarmente utilizzato nel settore alimentare, chimico e farmaceutico.

Stainless wire braided one-layer P.T.F.E hose suitable for hydraulic and lubricant system, fuel and steam high temperature delivery. Particularly suitable for food, chemical and pharmaceutical industries.



**STRUTTURA BODY**

<b>A</b>	<b>Sottostrato Tube</b>	P.T.F.E. estruso. P.T.F.E one layer.
<b>B</b>	<b>Inserti Reinforcement</b>	Trecciatura di filo acciaio inox AISI 304. Stainless AISI 304 wire braid.
<b>C</b>	<b>Copertura Cover</b>	Trecciatura di filo acciaio inox AISI 304. Stainless AISI 304 wire braid.
	<b>Superficie Surface</b>	Trecciata. Braided.

3	1/8	6,2	276	828	-	-	51	LUNGHEZZA VARIABILE VARIABLE SIZE
5	3/16	7,6	264	793	-	-	64	
6	1/4	8,8	224	672	-	-	76	
8	5/16	11	207	621	-	-	102	
9,5	3/8	12,1	183	552	-	-	133	
10,3	13/32	13,7	140	480	-	-	135	
12,5	1/2	20,2	161	483	-	-	152	
16	5/8	18,8	114	345	-	-	178	
19	3/4	23,1	103	310	-	-	203	
22,2	7/8	26,2	92	276	-	-	229	
25	1	29,2	80	241	-	-	305	
29	1	33,1	44	176	-	-	410	

**NORME NORMS:**  
ISO 1307

**CONFEZIONAMENTO BOX:**  
IMBALLO IN CARTONE  
CARTON BOXES

**-70°C / +260°C**  
**-94°F / +500°F**

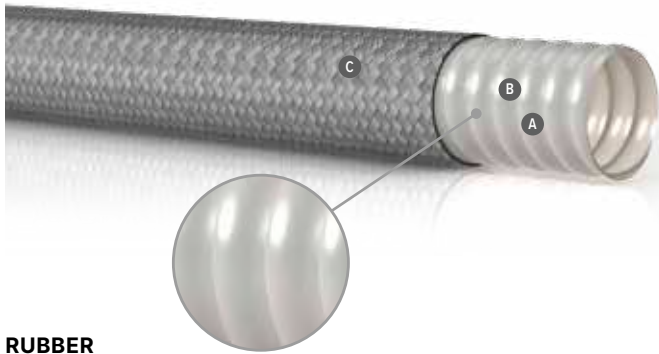

**RUBBER**



**IMPIEGO  
APPLICATIONS**

Tubo convoluto in P.T.F.E. trecciato in acciaio inox idoneo per impianti idraulici, circuiti di lubrificazione, passaggio carburanti e vapori ad alta temperatura. Particolarmente utilizzato nel settore alimentare, chimico e farmaceutico.

Stainless wire braided one-layer P.T.F.E convoluted hose suitable for hydraulic and lubricant system, fuel and steam high temperature delivery. Particularly suitable for food, chemical and pharmaceutical industries.



**STRUTTURA  
BODY**

<b>A</b>	<b>Sottostrato Tube</b>	P.T.F.E. corrugato. Convoluted P.T.F.E.
<b>B</b>	<b>Inserti Reinforcement</b>	Trecciatura di filo acciaio inox AISI 304. Stainless AISI 304 wire braid.
<b>C</b>	<b>Copertura Cover</b>	Trecciatura di filo acciaio inox AISI 304. Stainless AISI 304 wire braid.
	<b>Superficie Surface</b>	Trecciata. Braided.

6	1/4	10,6	-	800	0,7	-	18	LUNGHEZZA VARIABILE VARIABLE SIZE
7,5	5/16	14	-	650	0,7	-	19	
9,7	3/8	16,4	-	500	0,7	-	20	
13	1/2	19	-	309	0,7	-	25	
15,5	5/8	21	-	350	0,8	-	50	
19,6	3/4	26	-	250	0,8	-	64	
24,4	1	33,7	-	200	1	-	90	
32,5	1 1/4	40,3	-	170	1	-	110	
38	1 1/2	48,4	-	120	1	-	150	
50,9	2	61,4	-	100	1,1	-	190	



**NORME NORMS:**  
ISO 1307  
**CONFEZIONAMENTO BOX:**  
IMBALLO IN CARTONE  
CARTON BOXES



**-70°C / +260°C**  
**-94°F / +500°F**

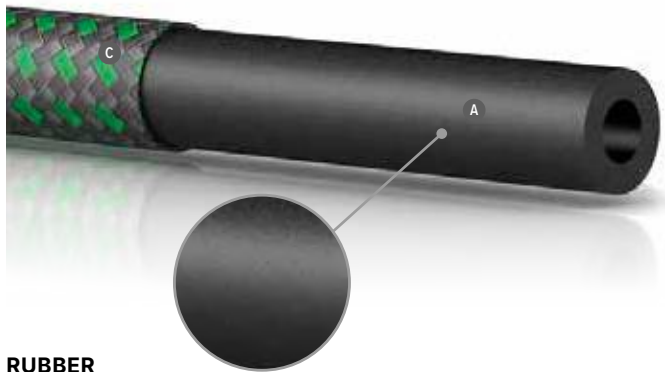

**RUBBER**



- **Ideale per motori a combustione interna.**  
Ideal for the internal combustion engine.
- **Fornibile su rocchetto.**  
Available also on reel.



**IMPIEGO  
APPLICATIONS**

Idoneo alla mandata di benzine ecologiche, lubrificanti, oli minerali e carburanti. Particolarmente utilizzato sui motori a combustione interna.

For delivery of fuel oil, gasoline, etc. Widely used in internal combustion engines.



**STRUTTURA  
BODY**

<b>A</b>	<b>Sottostrato Tube</b>	Liscio in gomma NBR resistente a prodotti petroliferi con un contenuto aromatico non superiore al 40%. Oil and fuel resistant NBR rubber resistant to petroleum products with aromatic content of not over 40%.
<b>B</b>	<b>Inserti Reinforcement</b>	--
<b>C</b>	<b>Copertura Cover</b>	Treccia tessile ad alta tenacità nera vulcanizzata, impregnata con soluzione neoprenica che garantisce al tubo una certa autoestinguenza e anti-putrescibilità. Textile braid impregnated with neoprene solution.
	<b>Superficie Surface</b>	Trecciata. Braided.

mm	inch	mm	bar	bar	bar	gr/mt	mm	m
3	1/8	7	10	30	-	40	25	100
4	1/6	8	10	30	-	50	35	100
5	3/16	10	10	30	-	80	40	100
6	1/4	11	10	30	-	100	50	100
6	1/4	13	10	30	-	140	50	100
7	5/18	13	10	30	-	130	55	100
7,5	5/16	14,5	10	30	-	160	60	100
8	5/16	13	10	30	-	110	65	100
8	5/16	15	10	30	-	160	65	100
10	3/8	15	10	30	-	140	80	100
10	3/8	17	10	30	-	190	80	100
13	1/2	20	10	30	-	240	130	100
16	5/8	23	10	30	-	280	160	100
19	3/4	27	10	30	-	380	190	100
25	1	33	10	30	-	500	250	100

**FASCETTE E COLLARI STRINGITUBO CONSIGLIATE  
RECOMMENDED CLAMP/COLLAR**

STF - Fascette a vite Hose clamps with screw (pag. 204-207)



**NORME NORMS:**  
ISO 1307  
**CONFEZIONAMENTO BOX:**  
IMBALLO IN CARTONE  
CARTON BOXES



**-40°C / +85°C**  
**-40°F / +185°F**

# TUBI PER ACQUA CALDA E VAPORE

HOT WATER AND STEAM HOSES





**RUBBER**

**IMPIEGO APPLICATIONS**

Tubo flessibile per mandata in pressione di aria, acqua calda e liquidi leggermente corrosivi in attrezzature ed impianti di vario genere.

For delivery of hot water with light chemical content in industrial applications.



**STRUTTURA BODY**

<b>A</b>	<b>Sottostrato Tube</b>	Liscio, nero, in gomma EPDM. EPDM rubber.
<b>B</b>	<b>Inserti Reinforcement</b>	Tessili sintetici. High tensile synthetic textile.
<b>C</b>	<b>Copertura Cover</b>	Liscia in gomma EPDM di colore nero resistente alla temperatura, all'abrasione, agli agenti atmosferici e ozono. Abrasion, heat, ozone and weather resistant, smooth EPDM rubber.
	<b>Superficie Surface</b>	Liscia. Smooth.

mm	mm	bar	bar	bar	gr/mt	mm	m
5	10,5	10	30	-	82	50	50-100
5	11	10	30	-	93	50	50-100
6	12	10	30	-	102	60	50-100
7	13	10	30	-	120	70	50-100
8	15	10	30	-	160	80	50-100
10	17	10	30	-	185	100	50-100
12	18	10	30	-	155	120	50-100
13	19	10	30	-	180	130	50-100
15	21	10	30	-	205	150	50-100
15	23	10	30	-	360	150	50-100
19	26	10	30	-	310	190	50-100
20	30	10	30	-	480	200	50-100
22	30	10	30	-	390	220	50-100
25	33	10	30	-	550	250	50-100
25	35	10	30	-	610	250	50-100

**FASCETTE E COLLARI STRINGITUBO CONSIGLIATE RECOMMENDED CLAMP/COLLAR**

STF - Fascette a vite Hose clamps with screw (pag. 204-207)

SGT - Fascette pinzabili Stepp less (pag. 216)



**NORME NORMS:**  
ISO 1307

**MARCATURA MARKING:**  
EUROCORD® HOT WATER 100°C - ISO 1307

**CONFEZIONAMENTO BOX:**  
IMBALLO IN POLIETILENE TRASPARENTE  
PACKAGING IN TRANSPARENT POLYETHYLENE

**-40°C / +125°C**  
**-40°F / +257°F**



**RUBBER**



### IMPIEGO APPLICATIONS

Tubo flessibile per mandata in pressione di aria, acqua calda e liquidi leggermente corrosivi in attrezzature ed impianti di vario genere.

For delivery of hot water with very light chemical content in industrial applications.



### STRUTTURA BODY

<b>A</b>	<b>Sottostrato Tube</b>	Liscio, nero, in gomma EPDM. EPDM rubber.
<b>B</b>	<b>Inserti Reinforcement</b>	Tessili sintetici. High tensile synthetic textile.
<b>C</b>	<b>Copertura Cover</b>	Liscia in gomma EPDM di colore nero resistente alla temperatura, all'abrasione, agli agenti atmosferici e ozono. Abrasion, heat, ozone and weather resistant, smooth EPDM rubber.
	<b>Superficie Surface</b>	Liscia. Smooth.



### FASCETTE E COLLARI STRINGITUBO CONSIGLIATE RECOMMENDED CLAMP/COLLAR

STF - Fascette a vite Hose clamps with screw (pag. 204-207)

SGT - Fascette pinzabili Stepp less (pag. 216)



mm	mm	bar	bar	bar	gr/mt	mm	m
5	10,5	20	60	-	82	50	50-100
5	11	20	60	-	93	50	50-100
6	12	20	60	-	102	60	50-100
7	13	20	60	-	120	70	50-100
8	16	20	60	-	175	80	50-100
10	18	20	60	-	220	100	50-100
13	21	20	60	-	320	130	50-100
19	28	20	60	-	440	190	50
25	35	20	60	-	650	250	50



**NORME NORMS:**  
ISO 1307

**MARCATURA MARKING:**  
EUROCORD® HOT WATER 100°C - ISO 1307

**CONFEZIONAMENTO BOX:**  
IMBALLO IN POLIETILENE TRASPARENTE  
PACKAGING IN TRANSPARENT POLYETHYLENE



**-40°C / +110°C**  
**-40°F / +230°F**



**RUBBER**



- **Struttura idonea per il montaggio come flessibile su estintori.**  
Suitable structure for the installation on the fire extinguishers.

**IMPIEGO APPLICATIONS**

Tubo idoneo alla conduzione di schiume e gas estinguenti. La particolare ata appositamente per essere montata come flessibile su estintori fissi e mobili.

For fire extinguishers.



**STRUTTURA BODY**

<b>A</b> Sottostrato Tube	Liscia in gomma EPDM di colore nero resistente alla temperatura, all'abrasione, agli agenti atmosferici e all'ozono. Ozone, abrasion, and weather resistant special synthetic EPDM rubber.
<b>B</b> Inserti Reinforcement	Tessili sintetici ad alta resistenza. High tensile synthetic textile.
<b>C</b> Copertura Cover	Liscia in gomma EPDM di colore nero resistente alla temperatura, all'abrasione, agli agenti atmosferici e all'ozono. Ozone, abrasion, and weather resistant special synthetic EPDM rubber.
Superficie Surface	Liscia. Smooth.

mm	mm	bar	bar	bar	gr/mt	mm	m
10	19	20	60	-	290	100	100
12,5	20,5	20	60	-	260	125	100
13	22,5	20	60	-	340	130	100
16	26	20	60	-	440	160	50
19	29	20	60	-	500	190	50

**FASCETTE E COLLARI STRINGITUBO CONSIGLIATE RECOMMENDED CLAMP/COLLAR**

STF - Fascette a vite Hose clamps with screw (pag. 204-207)

SGT - Fascette pinzabili Stepp less (pag. 216)



**NORME NORMS:**  
ISO 1307  
**MARCATURA MARKING:**  
EUROCORD® EPDM EXTINGUISHER P.E. 20 BAR - ISO 1307  
**CONFEZIONAMENTO BOX:**  
IMBALLO IN POLIETILENE TRASPARENTE  
PACKAGING IN TRANSPARENT POLYETHYLENE



**-40°C / +120°C**  
**-40°F / +248°F**

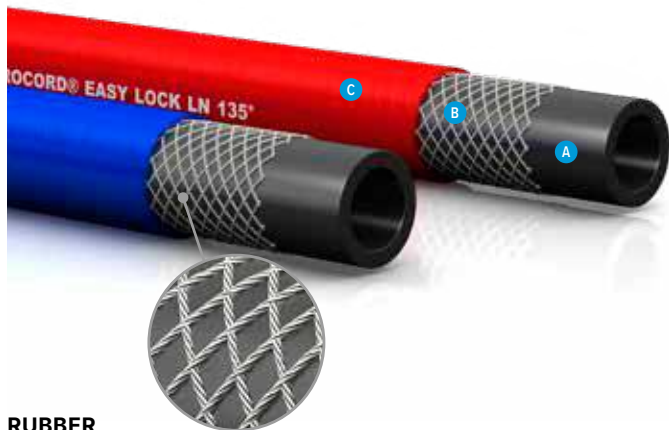

RUBBER



- **Studiato appositamente per sistemi di raccordatura Push Lock.**  
Suitable for Push Lock connection systems.



## IMPIEGO APPLICATIONS

Per mandata acqua calda e fredda e prodotti chimici leggermente corrosivi. Particolarmente indicato per sistemi di raccordatura Push Lock.

For delivery of hot and cold water and slightly corrosive chemical products. Suitable for Push Lock connection systems.



## STRUTTURA BODY

<b>A</b>	<b>Sottostrato Tube</b>	Gomma speciale sintetica, resistente alle alte temperature. High temperature resistant special synthetic rubber.
<b>B</b>	<b>Inserti Reinforcement</b>	1 treccia sintetica, resistente agli oli idraulici. 1 high tensile synthetic textile braid.
<b>C</b>	<b>Copertura Cover</b>	Gomma speciale rossa e blu resistente a gli oli, ozono, abrasione ed agenti atmosferici. Red and blue cover. Oil, abrasion ozone and weather resistant special synthetic rubber.
	<b>Superficie Surface</b>	Liscia. Smooth.

mm	mm	bar	bar	bar	gr/mt	mm	m
4,8	10,7	34	136	-	90	50	>10
6,4	12,3	28	112	-	110	65	>10
8	13,9	28	112	-	130	80	>10
9,5	15,5	28	112	-	150	80	>10
12,7	19,5	28	112	-	220	100	>10
16	22,6	24	96	-	260	125	>10
19	25,8	21	84	-	310	150	>10
25,4	33,234	20	80	-	460	170	>10



**NORME NORMS:**  
SAE 100 R6 - ISO 1307 - EN854 TYPE R6 - TS6388  
EN854 TIP36 - ISO4079-1 R6

**MARCATURA MARKING:**  
EUROCORD® EASY LOCK LN 135°

**CONFEZIONAMENTO BOX:**  
IMBALLO IN POLIETILENE TRASPARENTE  
PACKAGING IN TRANSPARENT POLYETHYLENE



**-40°C / +135°C**  
**-40°F / +275°F**



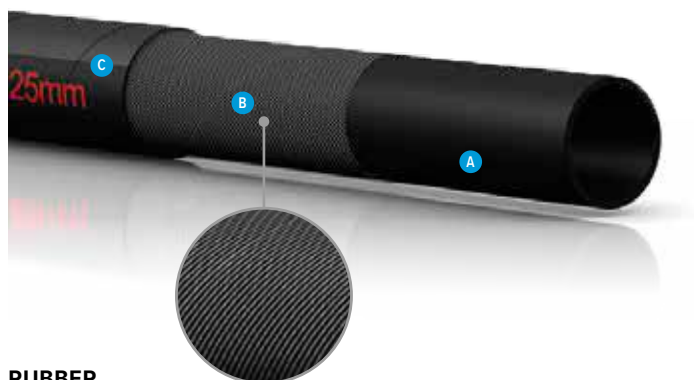

**RUBBER**



- **Ideale per settore automobilistico e per veicoli industriali.**  
Ideal for the automotive sector and for industrial vehicles.
- **Disponibile anche in barre dritte da 1 m.**  
Available also in straight pieces (1 m).

**IMPIEGO APPLICATIONS**

Idoneo alla mandata di soluzione di acqua calda e liquido antigelo. Particolarmente utilizzato come collegamento flessibile nel circuito di raffreddamento dei motori degli autoveicoli.

Suitable for hot water and anti freeze liquid delivery. Particularly used like flexible connection on motors cooling systems.



**STRUTTURA BODY**

<b>A</b>	<b>Sottostrato Tube</b>	Gomma EPDM di colore nero. Heat, ozone and weather resistant, EPDM rubber.
<b>B</b>	<b>Inserti Reinforcement</b>	Tessili sintetici. High tensile synthetic textile.
<b>C</b>	<b>Copertura Cover</b>	Gomma EPDM di colore nero resistente agli agenti atmosferici ed all'invecchiamento. Heat, ozone and weather resistant, EPDM rubber.
	<b>Superficie Surface</b>	Liscia ad impressione tela. Smooth with fabric impression.

mm	mm	bar	bar	bar	gr/mt	mm	m
18	24	4	12	-	281	180	40
20	26	4	12	-	307	200	40
22	28	4	12	-	334	220	40
25	32	4	12	-	423	250	40
28	36	4	12	-	573	280	40
30	38	4	12	-	609	300	40
32	40	4	12	-	645	320	40
35	43	4	12	-	699	350	40
38	46	4	12	-	753	380	40
40	48	4	12	-	789	400	40
42	50	4	12	-	825	420	40
45	54	4	12	-	990	450	40
48	57	4	12	-	1095	480	40
50	60	4	12	-	1200	510	40
55	65	4	12	-	1346	550	40
60	70	4	12	-	1493	600	40
65	75	4	12	-	1700	650	40
70	81	4	12	-	1906	700	20

**FASCETTE E COLLARI STRINGITUBO CONSIGLIATE RECOMMENDED CLAMP/COLLAR**

STF - Fascette a vite Hose clamps with screw (pag. 204-207)

SDB - Fascette a tensione costante SAE Constant tension clamps SAE (pag. 215)

STC - Fascette con bullone Hose clamps with bolt (pag. 208-210)



**NORME NORMS:**  
ISO 1307  
**MARCATURA MARKING:**  
EUROCORD® RADIATOR HOT WATER 100°C  
**CONFEZIONAMENTO BOX:**  
IMBALLO IN POLIETILENE TRASPARENTE  
PACKAGING IN TRANSPARENT POLYETHYLENE



**-40°C / +100°C**  
**-40°F / +212°F**

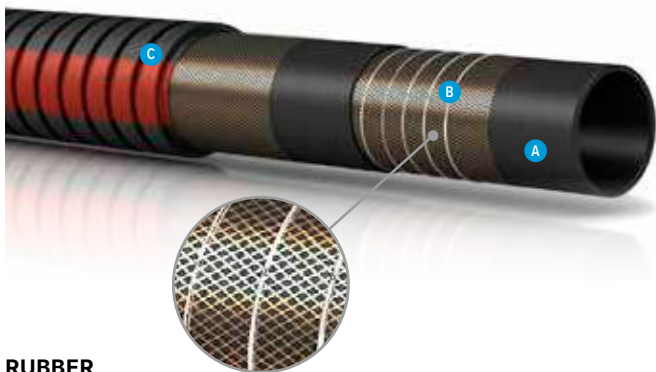

**RUBBER**



- **Ideale per settore automobilistico e per veicoli industriali.**  
**Ideal for the automotive sector and for the industrial vehicles.**



**IMPIEGO**  
**APPLICATIONS**

Per aspirazione e mandata di olii paraffinici, aria, acqua e glicole. Particolarmente indicato negli impieghi in cui vengano richiesti ridotti raggi di curvatura; trova ampia applicazione nel settore automobilistico e dei veicoli industriali come flessibile multiuso.

For paraffinic oils, air, water and glycol suction and delivery. Particularly used where it is necessary a small band radius. Suitable for the automotive sector and for the industrial vehicles.



**STRUTTURA**  
**BODY**

<b>A</b>	<b>Sottostrato Tube</b>	Gomma nera NBR resistente a oli e carburanti contenuto aromatico non superiore al 50%. Oil and petrol resistant, black NBR, with aromatic content up to 50%.
<b>B</b>	<b>Inseri Reinforcement</b>	Tessili sintetici ad alta tenacita e spirale metallica incorporata, cordicella di rame. High tensile synthetic textile, steel wire helix and antistatic copper wire.
<b>C</b>	<b>Copertura Cover</b>	Gomma EPDM. Oil, weather, ozone, abrasion resistant special synthetic rubber.
	<b>Superficie Surface</b>	Greccato ad impressione tela. Greccato with fabric impression.



**FASCETTE E COLLARI STRINGITUBO CONSIGLIATE**  
**RECOMMENDED CLAMP/COLLAR**

- STF - Fascette a vite Hose clamps with screw (pag. 204-207)
- SDB - Fascette a tensione costante SAE Constant tension clamps SAE (pag. 215)
- STC - Fascette con bullone Hose clamps with bolt (pag. 208-210)
- STS - Fascette a tensione costante SAE Constant tension clamps SAE (pag. 214)



mm	mm	bar	bar	bar	gr/mt	mm	m
19	29	10	30	0,8	540	75	40
25	36	10	30	0,8	710	100	40
30	41	10	30	0,8	871	120	40
32	44	10	30	0,8	1014	130	40
35	46	10	30	0,8	993	140	40
38	49	10	30	0,8	1070	150	40
40	52	10	30	0,8	1249	160	40
45	57	10	30	0,8	1522	190	40
48	58	10	30	0,8	1314	200	40
51	63	10	30	0,8	1752	250	40
60	73	10	30	0,8	2132	310	40
70	83	10	30	0,8	2605	400	40
80	94	10	30	0,8	2983	475	20-40
90	104	10	30	0,8	3326	522	20
98	104	10	30	0,8	3326	522	20
100	117	10	30	0,8	4133	610	20-40
120	138	10	30	0,8	7400	720	20



**NORME NORMS:**  
ISO 1307  
**MARCATURA MARKING:**  
EUROCORD® OIL SUCTION DELIVERY HOSE W.P.  
10 BAR  
**CONFEZIONAMENTO BOX:**  
IMBALLO IN POLIETILENE NERO  
PACKAGING IN BLACK POLYETHYLENE



**-35°C / +100°C**  
**-31°F / +212°F**

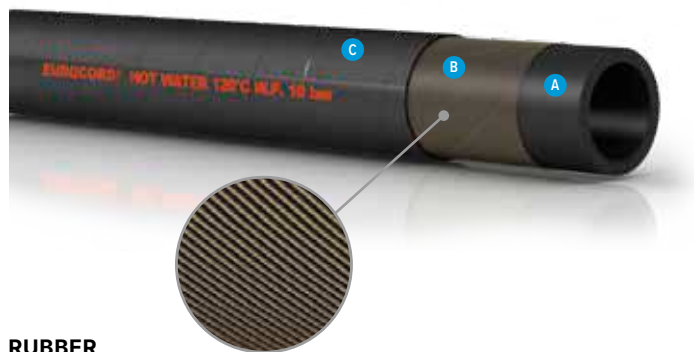

**RUBBER**

**IMPIEGO APPLICATIONS**

Idoneo per mandata di acqua calda mista a vapore e fluidi caldi non corrosivi. Particolarmente indicato nelle operazioni di pulizia e di lavaggio con lance a mano e collegamenti flessibili di caldaie con termoconvertitori.

Suitable for delivery of hot water mixed with steam and non corrosive hot fluids. Particularly indicated for cleaning and washing operations with hand lances; as flexible connection hoses of boilers with thermoconverters.



**STRUTTURA BODY**

<b>A</b>	<b>Sottostrato Tube</b>	Liscio in gomma EPDM di colore nero. EPDM rubber.
<b>B</b>	<b>Inserti Reinforcement</b>	Tessili sintetici. High tensile synthetic textile.
<b>C</b>	<b>Copertura Cover</b>	Gomma EPDM di colore nero resistente al calore, agli agenti atmosferici ed all'invecchiamento. Heat, ozone and weather resistant, EPDM rubber.
	<b>Superficie Surface</b>	Liscia ad impressione tela. Smooth with fabric impression.

mm	mm	bar	bar	bar	gr/mt	mm	m
10	20	10	30	-	346	100	40
12	22	10	30	-	392	120	40
13	23	10	30	-	415	130	40
15	25	10	30	-	461	150	40
16	26	10	30	-	484	160	40
17	27	10	30	-	507	170	40
18	28	10	30	-	529	180	40
20	30	10	30	-	575	200	40
22	32	10	30	-	621	225	40
25	35	10	30	-	667	250	40
28	38	10	30	-	736	280	40
30	41	10	30	-	897	300	40
32	45	10	30	-	1162	320	40
35	48	10	30	-	1260	350	40
38	51	10	30	-	1329	380	40
40	54	10	30	-	1423	400	40
45	61	10	30	-	1864	450	40
50	68	10	30	-	2231	510	40
60	82	10	30	-	3443	600	40

**FASCETTE E COLLARI STRINGITUBO CONSIGLIATE RECOMMENDED CLAMP/COLLAR**

STF - Fascette a vite Hose clamps with screw (pag. 204-207)

STC - Fascette con bullone Hose clamps with bolt (pag. 208-210)



**NORME NORMS:**  
ISO 1307

**MARCATURA MARKING:**  
EUROCORD® HOT WATER 120°C W.P. 10 BAR

**CONFEZIONAMENTO BOX:**  
IMBALLO IN POLIETILENE TRASPARENTE  
PACKAGING IN TRANSPARENT POLYETHYLENE

**-40°C / +125°C**  
**-40°F / +257°F**



**RUBBER**



**IMPIEGO  
APPLICATIONS**

Idoneo alla mandata di vapore saturo. Particolarmente utilizzato nelle operazioni di pulizia, lavaggio, sterilizzazione, con lance a mano nelle industrie in genere.

Particularly used in industrial cleaning and washing operations with hand lances.



- **Per mandata vapore saturo.**  
For saturated steam delivery.



**STRUTTURA  
BODY**

<b>A</b>	<b>Sottostrato Tube</b>	Liscio in gomma EPDM di colore nero. EPDM rubber, resistant to saturated steam.
<b>B</b>	<b>Inseriti Reinforcement</b>	Tessili sintetici ad alta resistenza. High tensile synthetic textile.
<b>C</b>	<b>Copertura Cover</b>	Gomma EPDM di colore nero resistente al calore, agli agenti atmosferici ed all'invecchiamento. Heat, steam, ozone and weather resistant, pin-pricked special synthetic rubber.
	<b>Superficie Surface</b>	Liscia ad impressione tela. Smooth with fabric impression.

mm	mm	bar	bar	bar	gr/mt	mm	m
12	23	6	60	-	320	127	40
15	26	6	60	-	387	150	40
18	30	6	60	-	485	180	40
19	31	6	60	-	511	190	40
25	37	6	60	-	604	254	40
30	45	6	60	-	958	300	40
32	46	6	60	-	914	320	40
35	50	6	60	-	1102	350	40
40	56	6	60	-	1339	400	40
45	64	6	60	-	1503	445	40
50	67	6	60	-	1638	508	40
60	82	6	60	-	1803	600	40



**FASCETTE E COLLARI STRINGITUBO CONSIGLIATE  
RECOMMENDED CLAMP/COLLAR**

STF - Fascette a vite Hose clamps with screw (pag. 204-207)

STC - Fascette con bullone Hose clamps with bolt (pag. 208-210)



**NORME NORMS:**  
ISO 1307

**MARCATURA MARKING:**  
EUROCORD® STEAM RESISTANT 160°C W.P. 6 BAR

**CONFEZIONAMENTO BOX:**  
IMBALLO IN POLIETILENE TRASPARENTE  
PACKAGING IN TRANSPARENT POLYETHYLENE



**-40°C / +165°C**  
**-40°F / +329°F**

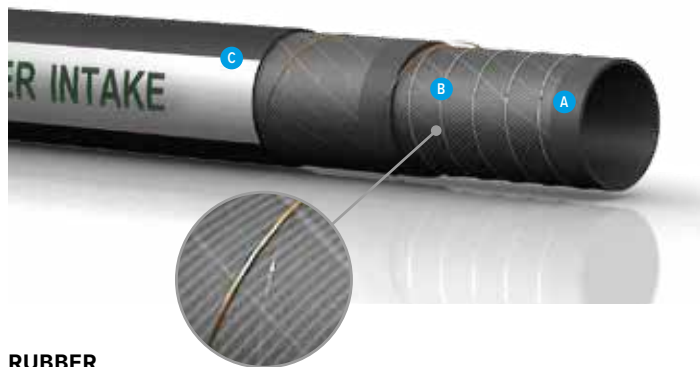

**RUBBER**

**IMPIEGO APPLICATIONS**

Tubo idoneo alla mandata ed aspirazione di acqua calda. Può essere accordato come flessibile per le pompe di calore e di autoclavi.

It can be connected like flexible for heat pumps or autoclaves.



**STRUTTURA BODY**

<b>A</b>	<b>Sottostrato Tube</b>	Gomma nera EPDM. EPDM rubber.
<b>B</b>	<b>Inserti Reinforcement</b>	Tessili sintetici ad alta tenacità. High tensile synthetic textile.
<b>C</b>	<b>Copertura Cover</b>	Gomma EPDM resistente all'abrasione al calore ed agli agenti atmosferici. Abrasion, heat, steam, ozone and weather resistant, EPDM special synthetic rubber.
	<b>Superficie Surface</b>	Liscia ad impressione tela. Smooth with fabric impression.

mm	mm	bar	bar	bar	gr/mt	mm	m
16	26	10	30	0,92	487	64	40-61
19	29	10	30	0,92	557	76	40-61
20	30	10	30	0,92	580	80	40-61
25	35	10	30	0,92	700	100	40-61
30	40	10	30	0,92	800	120	40-61
32	43	10	30	0,92	1000	128	40-61
35	46	10	30	0,92	1090	140	40-61
38	49	10	30	0,92	1200	152	40-61
40	51	10	30	0,92	1310	160	40-61
45	57	10	30	0,92	1610	180	40-61
50,8	63	10	30	0,92	1790	203	40-61
60	72	10	30	0,92	1986	270	40-61
70	82	10	30	0,92	2426	300	40-61
76	90	10	30	0,92	3075	300	40-61
80	94	10	30	0,92	3230	320	40-61
102	116	10	30	0,92	4050	400	40-61

**FASCETTE E COLLARI STRINGITUBO CONSIGLIATE RECOMMENDED CLAMP/COLLAR**

STF - Fascette a vite Hose clamps with screw (pag. 204-207)  
STC - Fascette con bullone Hose clamps with bolt (pag. 208-210)



**NORME NORMS:**  
ISO 1307

**MARCATURA MARKING:**  
WATER INTAKE

**CONFEZIONAMENTO BOX:**  
IMBALLO IN POLIETILENE PORPORA  
PACKAGING IN PURPLE POLYETHYLENE

**-40°C / +125°C**  
**-40°F / +257°F**



**RUBBER**



**IMPIEGO  
APPLICATIONS**

Idoneo alla mandata di vapore saturo per servizi di pulizia e sterilizzazione di serbatoi e tubazioni.

For saturated steam delivery for cleaning services, tankers sterilization and piping systems.



**STRUTTURA  
BODY**

<b>A</b>	<b>Sottostrato Tube</b>	Gomma EPDM di colore nero. EPDM rubber. Resistant to saturated steam..
<b>B</b>	<b>Inseriti Reinforcement</b>	Cord metallici ad alta resistenza. High tensile steel wire cords.
<b>C</b>	<b>Copertura Cover</b>	Gomma sintetica di colore rosso, resistente all'abrasione e agli agenti atmosferici. Abrasion, heat, steam, oil, ozone and weather resistant. Pinpricked special synthetic rubber.
	<b>Superficie Surface</b>	Liscia ad impressione tela microforata. Smooth with microperforated fabric impression.











**FASCETTE E COLLARI STRINGITUBO CONSIGLIATE  
RECOMMENDED CLAMP/COLLAR**

STF - Fascette a vite Hose clamps with screw (pag. 204-207)  
STC - Fascette con bullone Hose clamps with bolt (pag. 208-210)



- **Per mandata di vapore saturo.**  
For Saturated steam delivery.
- **Producibile anche nella versione con copertura oil secondo normativa EN ISO6134 class B.**  
Available also with oil cover according to EN ISO6134 class B.



 mm	 mm	 bar	 bar	 bar	 gr/mt	 mm	 m
10	21	17	170	-	450	180	40
13	25	17	170	-	651	156	40
19	32	17	170	-	730	228	40
25	38	17	170	-	926	305	40
32	46	17	170	-	1612	386	40
38	54	17	170	-	2812	456	40
51	67	17	170	-	2419	610	40



NORME NORMS: ISO 1307  
MARCATURA MARKING:  
EUROCORD® STEAM RESISTANT 200°C W.P:17 BAR  
CONFEZIONAMENTO BOX: IMBALLO IN POLIETILENE TRASPARENTE PACKAGING IN TRANSPARENT POLYETHYLENE



**-40°C / +208°C**  
**-40°F / +406°F**

# TUBI PER PASSAGGIO DI PRODOTTI ALIMENTARI

FOOD DELIVERY HOSES





**RUBBER**



**IMPIEGO  
APPLICATIONS**

Tubo flessibile per mandata in pressione di acqua calda e liquidi leggermente corrosivi, in attrezzature ed impianti di vario genere. Utilizzato particolarmente come tubazione flessibile per il carico delle lavastoviglie industriali.

Particularly used like flexible hose for the loading of industrial dishwashers.



**STRUTTURA  
BODY**

<b>A</b>	<b>Sottostrato Tube</b>	Liscio, nero, a base di gomma sintetica EPDM atossica. EPDM Atoxic rubber.
<b>B</b>	<b>Inseriti Reinforcement</b>	Tessili sintetici. High tensile synthetic textile.
<b>C</b>	<b>Copertura Cover</b>	Liscia in gomma EPDM di colore nero resistente alla temperatura, all'abrasione e agli agenti atmosferici. Abrasion, heat, ozone and weather resistant, smooth EPDM rubber.
	<b>Superficie Surface</b>	Liscia. Smooth.











**FASCETTE E COLLARI STRINGITUBO CONSIGLIATE  
RECOMMENDED CLAMP/COLLAR**

STF - Fascette a vite Hose clamps with screw (pag. 204-207)  
SGT - Fascette pinzabili Stepp less (pag. 216)



- Prodotto secondo normativa FDA title 21 Parts 170 to 199 item 177.2600  
Produced according FDA-title 21 Parts 170 to 199 item 177.2600.



 mm	 mm	 bar	 bar	 bar	 gr/mt	 mm	 m
5	10,5	10	30	-	82	50	50-100
8	15	10	30	-	160	80	50-100
8	17	25	75	-	220	80	50-100
10	17	10	30	-	190	100	50-100
11	19	10	30	-	260	110	50-100
12	19,5	10	30	-	270	120	50-100
13	20	10	30	-	270	130	50-100



**NORME NORMS:**  
ISO 1307

**MARCATURA MARKING:**  
EUROCORD® EPDM FOOD QUALITY W.P. 10 BAR 100°C

**CONFEZIONAMENTO BOX:**  
IMBALLO IN POLIETILENE TRASPARENTE  
PACKAGING IN TRANSPARENT POLYETHYLENE

**DICHIARAZIONE DI CONFORMITÀ DISPONIBILE**  
DECLARATION OF COMPLIANCE IS AVAILABLE



**-30°C / +100°C**  
**-22°F / +212°F**



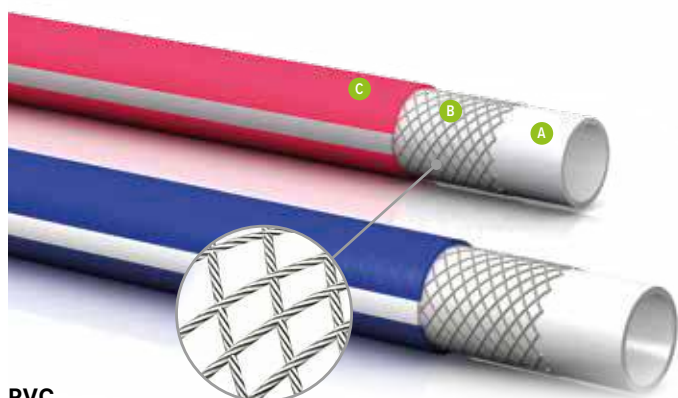

**PVC**

**IMPIEGO APPLICATIONS**

Tubo flessibile per mandata in pressione di acqua calda e liquidi leggermente corrosivi, in attrezzature ed impianti di vario genere. Utilizzato particolarmente come tubazione flessibile per il carico delle lavastoviglie industriali.

Flexible hose for the hot water and light corrosive liquids delivery. Suitable for equipment and plants in general. Particularly used like flexible hose for the loading of industrial dishwashers.



**STRUTTURA BODY**

<b>A</b>	<b>Sottostrato Tube</b>	PVC bianco atossico. Non-toxic white PVC, high tensile synthetic textile.
<b>B</b>	<b>Inserti Reinforcement</b>	Inserzioni tessili ad alta tenacità. High tensile synthetic textile.
<b>C</b>	<b>Copertura Cover</b>	PVC resistente agli agenti atmosferici, ozono ed abrasione. Abrasion, ozone and weather resistant special PVC compound.
	<b>Superficie Surface</b>	Blu o rosso. Blue or red.

mm	mm	bar	bar	bar	gr/mt	mm	m
13	20	10	30	-	225	-	50-100

**FASCETTE E COLLARI STRINGITUBO CONSIGLIATE RECOMMENDED CLAMP/COLLAR**

STF - Fascette a vite Hose clamps with screw (pag. 204-207)  
SGT - Fascette pinzabili Stepp less (pag. 216)



**NORME NORMS:**  
ISO 1307, EU 10/2011

**DICHIARAZIONE DI CONFORMITÀ DISPONIBILE**  
DECLARATION OF COMPLIANCE IS AVAILABLE

**-10°C / +60°C**  
**+14°F / +140°F**



**RUBBER**



**IMPIEGO**  
**APPLICATIONS**

Tubo idoneo passaggio acqua calda in stabilimenti, produzione alimentare, macelli o dove richiesta idoneità al contatto alimentare.

Suitable for hot water delivery in food processing plants or abattoirs.



**STRUTTURA**  
**BODY**

**A**

**Sottostrato Tube**

Gomma sintetica di colore bianco, qualità alimentare secondo FDA (CFR 21 CAP. 177.2600) e 93/11EEC inodore. idoneo al passaggio liquidi alimentari.  
White synthetic rubber, food quality according to FDA (CFR 21 CAP. 177.2600) and 93/11/EEC, odorless, suitable for food liquids delivery.

**B**

**Inseriti Reinforcement**

Inserzioni di filati sintetici ad alta resistenza.  
High tensile synthetic textile.

**C**

**Copertura Cover**

Gomma sintetica di colore blu resistente all'abrasione ai grassi animali, agli agenti atmosferici, all'ozono.  
Abrasion, heat, ozone and weather resistant, smooth EPDM rubber.

**Superficie Surface**

Liscia.  
Smooth.



**FASCETTE E COLLARI STRINGITUBO CONSIGLIATE**  
**RECOMMENDED CLAMP/COLLAR**









STF - Fascette a vite Hose clamps with screw (pag. 204-207)

SGT - Fascette pinzabili Stepp less (pag. 216)



- Prodotto secondo normativa FDA title 21 Parts 170 to 199 item 177.2600  
Produced according FDA - title 21 Parts 170 to 199 item 177.2600.



 mm	 mm	 bar	 bar	 bar	 gr/mt	 mm	 m
13	23	15	45	-	400	60	100
16	26	15	45	-	460	85	50
19	30	15	45	-	600	100	50
25	36	15	45	-	780	125	50



**NORME NORMS:**  
ISO 1307

**MARCATURA MARKING:**  
EUROCORD® CLEANING LB W.P. 20 BAR  - 93/11EEC & FDA APPROVED

**CONFEZIONAMENTO BOX:**  
IMBALLO IN POLIETILENE TRASPARENTE  
PACKAGING IN TRANSPARENT POLYETHYLENE

**DICHIARAZIONE DI CONFORMITÀ DISPONIBILE**  
DECLARATION OF COMPLIANCE IS AVAILABLE



**-30°C / +90°C**  
con picchi fino a  
with peaks up to  
+110°C

**-22°F / +194°F**  
con picchi fino a  
with peaks up to  
+230°F



**RUBBER**



- **FDA idoneo al passaggio di alimenti acquosi.**  
Produced according FDA-title 21 Parts 170 to 199 item 177.2600.
- **Qualità alimentare secondo BG VV XXI:2002 (kat.2) FDA inodore.**  
Food quality according to BG VV XXI:2002 (kat.2) FDA odourless.

**IMPIEGO  
APPLICATIONS**

Tubo idoneo al passaggio di vapore ed acqua calda. Solitamente utilizzato per lavare capannoni, macelli o qualsiasi ambiente di lavoro. La copertura colorata lo rende antimacchia.

For vapor and hot water transmission. Particularly used for cleaning in food processing plants (daires, abattoirs, etc.). Thanks to the coloured cover it is stain resistant.



**STRUTTURA  
BODY**

<b>A</b> Sottostrato Tube	Gomma EPDM di colore bianco qualità alimentare secondo norma Bg VV XXI:2002 (kat.2), FDA (CFR 21 § 177.2600) inodore, idonea al passaggio di liquidi alimentari, detersivi e vapore. White synthetic rubber, food quality according to FDA (CFR 21 CAP. 177.2600) and 93/11/EEC, odorless, suitable for food liquids delivery.
<b>B</b> Inserti Reinforcement	Tessili sintetici ad alta tenacità. High tensile synthetic textile.
<b>C</b> Copertura Cover	Gomma EPDM di colore blu ad impressione tela resistente all'abrasione, agli agenti atmosferici, all'invecchiamento e all'ozono. Oil, heat, abrasion, ozone and weather resistant, special synthetic rubber.
Superficie Surface	Liscia ad impressione tela. Smooth with fabric impression.

mm	mm	bar	bar	bar	bar	gr/mt	mm	m
		steam	water					
13	23	6	18	60	-	-	130	40
16	26	6	18	60	-	-	160	40
19	31	6	18	60	-	-	190	40
25	37	6	18	60	-	-	250	40
32	47	6	18	60	-	-	320	40
38	54	6	18	60	-	-	380	40
51	66	6	18	60	-	-	510	40

**FASCETTE E COLLARI STRINGITUBO CONSIGLIATE  
RECOMMENDED CLAMP/COLLAR**

- STF - Fascette a vite Hose clamps with screw (pag. 204-207)
- STC - Fascette con bullone Hose clamps with bolt (pag. 208-210)



**NORME NORMS:**  
ISO 1307

**MARCATURA MARKING:**  
EUROCORD® CLEANING STEAM 165°C  
ACCORDING FDA

**CONFEZIONAMENTO BOX:**  
IMBALLO IN POLIETILENE TRASPARENTE  
PACKAGING IN TRANSPARENT POLYETHYLENE

**DICHIARAZIONE DI CONFORMITÀ DISPONIBILE**  
DECLARATION OF COMPLIANCE IS AVAILABLE



**-40°C / +125°C**  
vapore fino a  
steam up to +165°C  
**-40°F / +257°F**  
vapore fino a  
steam up to +329°F

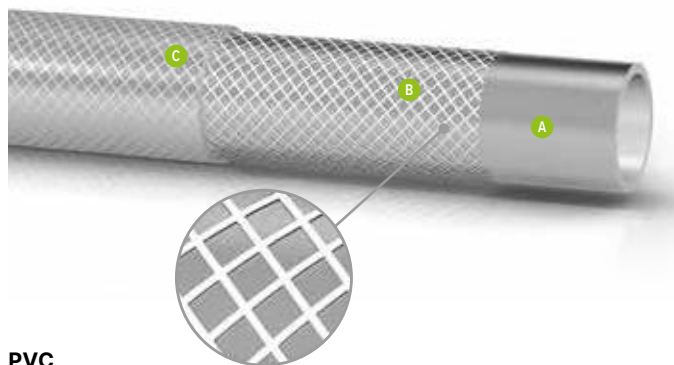

PVC



- **Idoneo alla mandata di liquidi alimentari secondo Regolamento Europeo n. 10/2011 per simulanti A-B-C.**  
**For the delivery of food liquis according to EU Regulation 10/2011 for A-B-C simulants.**



**IMPIEGO**  
**APPLICATIONS**

Tubo multiuso alimentare idoneo alla mandata di liquidi alimentari secondo il Regolamento Europeo n. 10/2011 per simulanti A-B-C. Particolarmente indicato nell'industria alimentare, enologica, cantieristica e navale.

Multipurpose food hose, suitable to the food liquids delivery according to EU Regulation 10/2011 for A-B-C simulants. Particularly used for the food industry, wine industry or marine industry.



**STRUTTURA**  
**BODY**

<b>A</b>	<b>Sottostrato Tube</b>	PVC trasparente atossico. Non-toxic transparent PVC.
<b>B</b>	<b>Inserti Reinforcement</b>	Inserzioni tessili ad alta tenacità. High tensile synthetic textile.
<b>C</b>	<b>Copertura Cover</b>	PVC trasparente. Transparent PVC.
	<b>Superficie Surface</b>	Trasparente. Transparent.



**FASCETTE E COLLARI STRINGITUBO CONSIGLIATE**  
**RECOMMENDED CLAMP/COLLAR**

STF - Fascette a vite Hose clamps with screw (pag. 204-207)  
SGT - Fascette pinzabili Stepp less (pag. 216)



mm	mm	bar	bar	bar	gr/mt	mm	m
5	3,0	20	60	-	81	-	100
6	3,0	20	60	-	83	-	100
7	3,0	20	60	-	119	-	100
8	3,0	20	60	-	117	-	100
10	3,0	15	45	-	138	-	100
12	3,0	10	30	-	159	-	100
13	3,0	10	30	-	169	-	100
15	3,0	10	30	-	190	-	50
16	3,0	10	30	-	201	-	50
19	3,5	10	30	-	280	-	50
22	4,0	8	24	-	374	-	50
25	4,0	8	24	-	417	-	50
30	4,0	7	21	-	490	-	50
32	4,5	7	21	-	560	-	50
35	5,0	7	21	-	686	-	50
38	5,0	5	15	-	743	-	50
40	5,0	5	15	-	777	-	50
45	5,0	5	15	-	840	-	50
50	5,0	5	15	-	949	-	50



**NORME NORMS:**  
REG. UE 10/2011 FOR SIMULANT TYPE A-B-C  
ISO 1307  
**DICHIARAZIONE DI CONFORMITÀ DISPONIBILE**  
DECLARATION OF COMPLIANCE IS AVAILABLE



**-5°C / +60°C**  
**+23°F / +140°F**

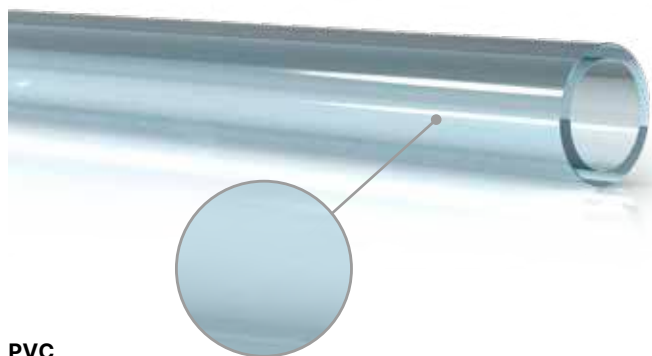

PVC



- **Idoneo alla mandata di liquidi alimentari secondo Regolamento Europeo n. 10/2011 per simulanti A-B-C.**  
For the delivery of food liquids according to EU Regulation 10/2011 for A-B-C simulants.

**IMPIEGO APPLICATIONS**

Tubo multiuso alimentare idoneo alla mandata di liquidi alimentari secondo il Regolamento Europeo n. 10/2011 per simulanti A-B-C. Particolarmente indicato nell'industria alimentare, enologica, cantieristica e navale.

Multipurpose food hose, suitable to the food liquids delivery according to EU Regulation 10/2011 for A-B-C simulants. Particularly used for the food industry, wine industry or marine industry.



**STRUTTURA BODY**

<b>A</b>	<b>Materiale Material</b>	PVC trasparente atossico. Non-toxic transparent PVC.
<b>B</b>	<b>Inserti Reinforcement</b>	---
<b>C</b>	<b>Copertura Cover</b>	PVC trasparente. Transparent PVC.
	<b>Superficie Surface</b>	Azzurro trasparente. Transparent light blue.

mm	mm	bar	bar	bar	gr/mt	mm	m
2	4	-	-	-	12	-	200
3	5	-	-	-	15	-	200
4	7	-	-	-	32	-	200
5	8	-	-	-	40	-	200
6	9	-	-	-	45	-	200
7	10	-	-	-	57	-	100
8	12	-	-	-	78	-	100
10	14	-	-	-	95	-	100
12	17	-	-	-	148	-	100
14	19	-	-	-	170	-	100
16	22	-	-	-	225	-	100
18	24	-	-	-	260	-	50
20	27	-	-	-	320	-	50
22	30	-	-	-	395	-	50
25	33	-	-	-	473	-	50
30	40	-	-	-	680	-	50

**FASCETTE E COLLARI STRINGITUBO CONSIGLIATE RECOMMENDED CLAMP/COLLAR**

STF - Fascette a vite Hose clamps with screw (pag. 204-207)

SGT - Fascette pinzabili Stepp less (pag. 216)

SBS - Fascette bifilari a molla Double wire spring (pag. 217)



**NORME NORMS:**  
REG. UE 10/2011 FOR SIMULANT TYPE A-B-C  
ISO 1307  
**DICHIARAZIONE DI CONFORMITÀ DISPONIBILE**  
DECLARATION OF COMPLIANCE IS AVAILABLE



**-5°C / +60°C**  
**+23°F / +140°F**

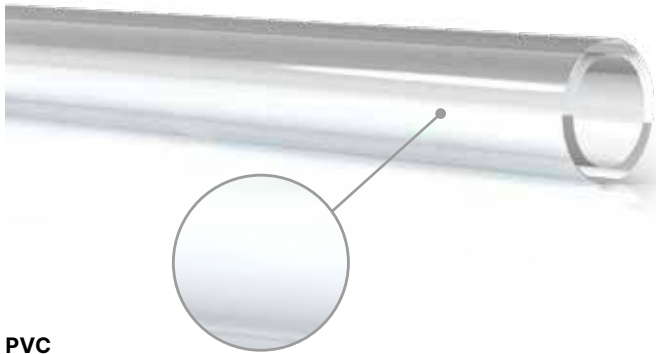

**PVC**



**IMPIEGO  
APPLICATIONS**

Tubo in silicone trasparente idoneo alla mandata di liquidi alimentari secondo FDA (CFR 21 cap. 177.2600) ove richiesta resistenza ad alte temperature.

Transparent silicone hose suitable for the delivery of food liquids accordin to FDA (CFR 21 cap. 177.2600) where is necessary an high temperature resistance.



- **Resistenza alle alte temperature.**  
High temperature resistant.



**STRUTTURA  
BODY**

<b>A</b>	<b>Materiale Material</b>	Silicone atossico. Neutral non toxical silicone hose.
<b>B</b>	<b>Inserti Reinforcement</b>	---
<b>C</b>	<b>Copertura Cover</b>	Silicone traslucido. Translucent silicone.
	<b>Superficie Surface</b>	Trasparente. Transparent.



**FASCETTE E COLLARI STRINGITUBO CONSIGLIATE  
RECOMMENDED CLAMP/COLLAR**

- STF - Fascette a vite Hose clamps with screw (pag. 204-207)
- SGT - Fascette pinzabili Stepp less (pag. 216)
- SBS - Fascette bifilari a molla Double wire spring (pag. 217)



mm	mm	bar	bar	bar	gr/mt	mm	m
2	4	-	-	-	12	-	100
3	5	-	-	-	16	-	100
3	6	-	-	-	27	-	100
4	6	-	-	-	20	-	100
4	7	-	-	-	32	-	100
4	8	-	-	-	48	-	100
5	8	-	-	-	39	-	100
5	9	-	-	-	56	-	100
6	8	-	-	-	56	-	100
6	9	-	-	-	45	-	100
6	10	-	-	-	64	-	100
6	12	-	-	-	108	-	100
7	10	-	-	-	51	-	50
7	11	-	-	-	72	-	50
8	12	-	-	-	80	-	50
9	12	-	-	-	63	-	50
10	14	-	-	-	96	-	50
12	16	-	-	-	112	-	50
12	18	-	-	-	180	-	50
14	18	-	-	-	126	-	50
15	20	-	-	-	176	-	50
18	24	-	-	-	253	-	25



**NORME NORMS:**  
REG. UE 10/2011 FOR SIMULANT TYPE A-B-C  
ISO 1307

**DICHIARAZIONE DI CONFORMITÀ DISPONIBILE  
DECLARATION OF COMPLIANCE IS AVAILABLE**



**-60°C / +150°C**  
con picchi fino a  
with peaks up to  
+200°C

**-76°F / +302°F**  
con picchi fino a  
with peaks up to  
+392°F



PVC



- **Ottima mandata ed aspirazione liquidi alimentari.**  
Great suction and delivery of food liquids.
- **Versione super elastica.**  
Super elastic version.



**IMPIEGO**  
APPLICATIONS

Idoneo alla mandata ed aspirazione di liquidi alimentari secondo il Regolamento Europeo n. 10/2011 per simulanti A-B-C. Particolarmente indicato nell'industria alimentare, nel settore agricolo ed industriale a corredo di pompe di aspirazione.

For suction and delivery of food liquids according to EU Regulation 10/2011 for A-B-C simulants. Particularly used in the food, agricultural and industrial sectors in support of suction pumps.



**STRUTTURA**  
BODY

<b>A</b>	<b>Materiale Material</b>	PVC flessibile. Strong, very flexible and smooth non-toxic, transparent plasticized PVC.
<b>B</b>	<b>Inserti Reinforcement</b>	Spirale in acciaio annegata nella parete del tubo. Steel wire spiral incorporated in hose wall.
<b>C</b>	<b>Copertura Cover</b>	PVC trasparente. Transparent PVC.
	<b>Superficie Surface</b>	Liscia, trasparente. Smooth, transparent.

mm	mm	bar	bar	bar	gr/mt	mm	m
10	3,1	12	-	0,9	180	23	60
12	3,1	12	-	0,9	190	24	60
14	3,1	12	-	0,9	230	28	60
16	3,1	12	-	0,9	260	32	60
18	3,5	11	-	0,9	296	28	60
20	3,5	10	-	0,9	340	30	60
22	3,7	10	-	0,9	400	33	60
25	4,0	10	-	0,9	520	38	60
30	4,2	9	-	0,9	630	45	60
32	4,2	9	-	0,9	660	48	30
35	4,3	9	-	0,9	750	52	30
38	4,5	9	-	0,9	800	57	30
40	4,8	9	-	0,9	950	60	30
45	4,9	9	-	0,9	1150	67	30
50	5,4	7	-	0,9	1300	75	30
60	6,0	6	-	0,9	1750	120	30
63	6,1	6	-	0,9	1800	130	30
70	6,7	5	-	0,9	2100	140	30
80	6,3	4	-	0,8	2500	160	30
90	6,5	4	-	0,8	2900	180	30
100	7,5	3	-	0,8	3650	200	30
110	7,0	3	-	0,8	3950	220	20
120	8,0	3	-	0,8	4300	240	20
125	8,0	3	-	0,8	4600	250	20



**FASCETTE E COLLARI STRINGITUBO CONSIGLIATE**  
RECOMMENDED CLAMP/COLLAR

STF - Fascette a vite Hose clamps with screw (pag. 204-207)

STC - Fascette con bullone Hose clamps with bolt (pag. 208-210)



**NORME NORMS:**  
REG. UE 10/2011 FOR SIMULANT TYPE A-B-C  
ISO 1307  
**DICHIARAZIONE DI CONFORMITÀ DISPONIBILE**  
DECLARATION OF COMPLIANCE IS AVAILABLE



**-5°C / +60°C**  
**+23°F / +140°F**



PVC



### IMPIEGO APPLICATIONS

Tubo universale in PVC idoneo alla mandata ed ottima aspirazione di liquidi alimentari secondo il Regolamento Europeo n. 10/2011 per simulanti A-B-C. La spirale metallica lo rende estremamente flessibile e la trasparenza permette di vedere il passaggio del liquido.

Universal pvc hose suitable for suction and delivery of food liquids according to EU Regulation 10/2011 for A-B-C simulants. The steel wire spiral makes it extremely flexible and the transparency lets see the liquid passage.



- **Ottima mandata ed aspirazione liquidi alimentari.**  
Great suction and delivery of food liquids.
- **Tubo universale.**  
Universal hose.



### STRUTTURA BODY

<b>A</b>	<b>Materiale Material</b>	PVC flessibile. Strong, very flexible and smooth non-toxic, transparent plasticized PVC.
<b>B</b>	<b>Inseri Reinforcement</b>	Spirale in acciaio annegata nella parete del tubo. Steel wire spiral incorporated in hose wall.
<b>C</b>	<b>Copertura Cover</b>	PVC trasparente. Transparent PVC.
	<b>Superficie Surface</b>	Liscia, trasparente. Smooth, transparent.



### FASCETTE E COLLARI STRINGITUBO CONSIGLIATE RECOMMENDED CLAMP/COLLAR

STF - Fascette a vite Hose clamps with screw (pag. 204-207)

STC - Fascette con bullone Hose clamps with bolt (pag. 208-210)



mm	mm	bar	bar	bar	gr/mt	mm	m
10	3,0	7	-	0,85	160	20	60/30
12	3,0	7	-	0,85	180	25	60/30
13	3,0	6	-	0,85	190	27	60/30
14	3,0	6	-	0,85	200	30	60/30
16	3,1	6	-	0,85	225	35	60/30
18	3,1	6	-	0,85	280	40	60/30
19	3,1	5	-	0,85	310	42	60/30
20	3,1	5	-	0,85	340	50	60/30
22	3,2	5	-	0,85	370	55	60/30
25	3,2	5	-	0,85	510	60	60/30
30	3,5	4	-	0,85	600	70	60/30
32	3,9	4	-	0,85	650	75	30
35	4,2	4	-	0,85	730	80	30
38	4,4	4	-	0,85	800	90	30
40	4,5	3	-	0,85	870	95	30
45	5,1	3	-	0,8	1100	105	30
50/51	5,1	3	-	0,8	1200	125	30
60	6,5	2,5	-	0,7	1800	135	30
63	6,5	2,5	-	0,7	1950	150	30
63	6,5	2,5	-	0,7	2000	140	30
70	7	2	-	0,7	2200	180	30
75	7	2	-	0,7	2500	195	30
80	7,5	2	-	0,7	2700	220	30
90	7,5	2	-	0,6	3000	260	30
102	8	2	-	0,6	3400	300	30



**NORME NORMES :**  
REG. UE 10/2011 FOR SIMULANT TYPE A-B-C  
ISO 1307

**DICHIARAZIONE DI CONFORMITÀ DISPONIBILE**  
DECLARATION OF COMPLIANCE IS AVAILABLE



**-5°C / +60°C**  
**+23°F / +140°F**



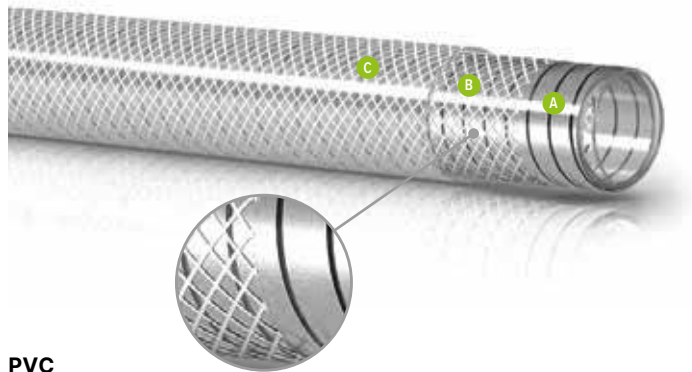

PVC



- **Conforme Regolamento Europeo n. 10/2011 per simulanti A-B-C-D1.**  
**Accordant to EU Regulation 10/2011 for A-B-C-D1 simulants.**

**IMPIEGO APPLICATIONS**

Idoneo alla mandata e massima aspirazione di liquidi inerti o alimentari secondo il Regolamento Europeo n. 10/2011 per simulanti A-B-C-D1. Particolarmente indicato nell'industria alimentare, enologica, cantieristica e navale.

For suction and maximum delivery of the food liquids delivery according to EU Regulation 10/2011 for A-B-C-D1 simulants. Particularly used for the food industry, wine industry or marine industry.



**STRUTTURA BODY**

<b>A</b>	<b>Materiale Material</b>	PVC flessibile. Flexible PVC.
<b>B</b>	<b>Inserti Reinforcement</b>	Spirale metallica annegata e inserti tessili sintetici. Steel spiral and synthetic textile reinforcement.
<b>C</b>	<b>Copertura Cover</b>	PVC trasparente. Transparent PVC.
	<b>Superficie Surface</b>	Leggermente corrugata. Slightly corrugated.

mm	mm	bar	bar	bar	gr/mt	mm	m
19	28	14	42	0,8	450	80	60
25	35,5	14	42	0,8	670	90	60
30	40,6	14	42	0,8	770	105	60
32	42,5	14	42	0,8	800	110	60
35	48	12	36	0,8	1100	125	60
38	51	12	36	0,8	1150	135	30
40	53	12	36	0,8	1200	140	30
45	58	10	30	0,8	1400	155	30
50	63	10	30	0,8	1600	170	30

**FASCETTE E COLLARI STRINGITUBO CONSIGLIATE RECOMMENDED CLAMP/COLLAR**

- STF - Fascette a vite Hose clamps with screw (pag. 204-207)
- STC - Fascette con bullone Hose clamps with bolt (pag. 208-210)



**NORME NORMES :**  
 REG. UE 10/2011 FOR SIMULANT TYPE A-B-C-D1  
 ISO 1307

**DICHIARAZIONE DI CONFORMITÀ DISPONIBILE**  
 DECLARATION OF COMPLIANCE IS AVAILABLE

**-5°C / +60°C**  
**+23°F / +140°F**

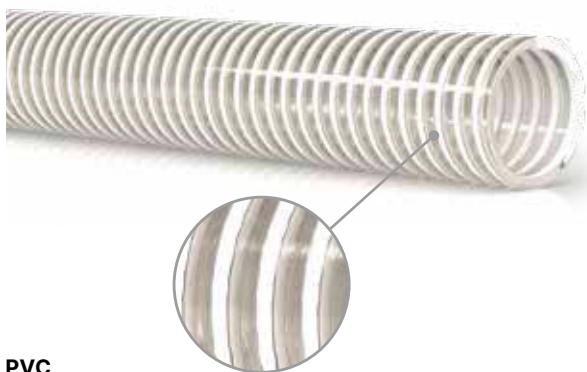

PVC



**IMPIEGO  
APPLICATIONS**

Idoneo alla mandata ed aspirazione di liquidi alimentari secondo il Regolamento Europeo n. 10/2011 per simulanti A-B-C. Particolarmente indicato nell'industria alimentare, nel settore agricolo ed industriale a corredo di pompe di aspirazione.

For suction and delivery of food liquids according to EU Regulation 10/2011 for A-B-C simulants. Particularly used in the food, agricultural and industrial sectors in support of suction pumps.



- **Conforme Regolamento Europeo n. 10/2011 per simulanti A-B-C.**  
Accordant to EU Regulation 10/2011 for A-B-C simulants.



**STRUTTURA  
BODY**

<b>A</b>	<b>Materiale Material</b>	PVC flessibile. Strong, flexible, and smooth non-toxic plasticized PVC.
<b>B</b>	<b>Inseriti Reinforcement</b>	Spirale bianca antiurto. Shock resistant PVC spiral.
<b>C</b>	<b>Copertura Cover</b>	PVC trasparente. Transparent PVC.
	<b>Superficie Surface</b>	Leggermente corrugata. Slightly corrugated.

mm	mm	bar	bar	bar	gr/mt	mm	m
20	2,4	-	23	-	195	80	50
25	2,5	-	21	-	230	100	50
30	2,8	-	19	-	280	120	50
32	2,8	-	18	-	290	128	50
35	3,5	-	17	-	380	140	50
38	3,2	-	17	-	420	152	50
40	3,3	-	16	-	470	160	50
45	3,3	-	15	-	530	180	50
50	3,6	-	14	-	640	200	50
60	3,6	-	12	-	800	240	50



**FASCETTE E COLLARI STRINGITUBO CONSIGLIATE  
RECOMMENDED CLAMP/COLLAR**

- STF - Fascette a vite Hose clamps with screw (pag. 204-207)
- STC - Fascette con bullone Hose clamps with bolt (pag. 208-210)
- SSS - Fascetta salta spirale Spiral piepe clamp (pag. 219)



**NORME NORMS:**  
REG. UE 10/2011 FOR SIMULANT TYPE A-B-C  
ISO 1307  
**DICHIARAZIONE DI CONFORMITÀ DISPONIBILE**  
DECLARATION OF COMPLIANCE IS AVAILABLE



**-5°C / +60°C**  
**+23°F / +140°F**

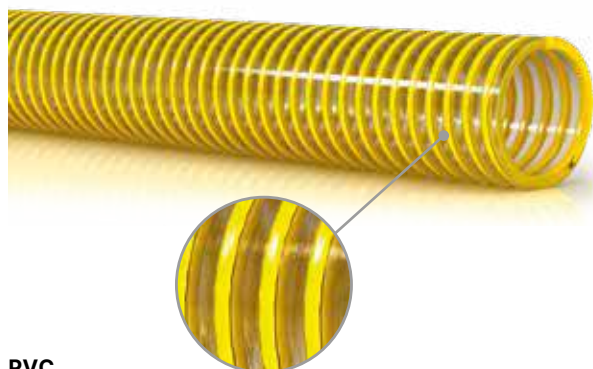

PVC



- **Conforme Regolamento Europeo n. 10/2011 per simulanti A-B-C.**  
Accordant to EU Regulation 10/2011 for A-B-C simulants.

**IMPIEGO APPLICATIONS**

Idoneo alla mandata ed aspirazione di liquidi alimentari secondo il Regolamento Europeo n. 10/2011 per simulanti A-B-C. Particolarmente indicato nell'industria alimentare, nel settore agricolo ed industriale a corredo di pompe di aspirazione.

For suction and delivery of food liquids according to EU Regulation 10/2011 for A-B-C simulants. Particularly used in the food, agricultural and industrial sectors in support of suction pumps.



**STRUTTURA BODY**

<b>A</b>	<b>Materiale Material</b>	PVC flessibile. Strong, flexible, and smooth non-toxic plasticized PVC.
<b>B</b>	<b>Inserti Reinforcement</b>	Spirale gialla antiurto. Shock resistant PVC spiral.
<b>C</b>	<b>Copertura Cover</b>	PVC trasparente. Transparent PVC.
	<b>Superficie Surface</b>	Leggermente corrugata. Slightly corrugated.

mm	mm	bar	bar	bar	gr/mt	mm	m
20	2,7	-	28	0,8	240	85	50
25	2,9	-	22	0,8	300	112	50
30	3,1	-	21	0,8	345	135	50
32	3,2	-	20	0,8	370	144	50
35	3,2	-	19	0,8	415	157	50
38	3,3	-	18	0,8	470	171	50
40	3,5	-	18	0,8	505	180	50
45	3,5	-	17	0,8	570	202	50
50	3,8	-	15	0,8	690	225	50
60	4,0	-	13	0,7	825	270	50
70	4,5	-	12	0,7	1080	315	50
75	4,6	-	12	0,7	1260	337	50
80	4,8	-	12	0,6	1400	360	50
90	5,1	-	11	0,6	1620	405	25
100	5,9	-	11	0,6	1850	459	25
110	6,1	-	11	0,5	2250	495	25
120	6,3	-	10	0,4	2700	540	25
125	6,6	-	10	0,4	2880	562	25
150	7,0	-	9	0,3	3870	675	25
200	8,5	-	7	0,2	5950	900	10

**FASCETTE E COLLARI STRINGITUBO CONSIGLIATE RECOMMENDED CLAMP/COLLAR**

- STF - Fascette a vite Hose clamps with screw (pag. 204-207)
- STC - Fascette con bullone Hose clamps with bolt (pag. 208-210)



**NORME NORMS:**  
REG. UE 10/2011 FOR SIMULANT TYPE A-B-C  
ISO 1307  
**DICHIARAZIONE DI CONFORMITÀ DISPONIBILE**  
DECLARATION OF COMPLIANCE IS AVAILABLE



**-5°C / +60°C**  
**+23°F / +140°F**

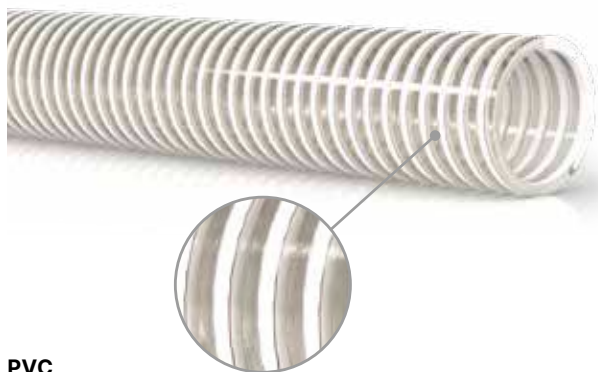

PVC



**IMPIEGO  
APPLICATIONS**

Idoneo alla mandata ed aspirazione di liquidi alimentari secondo il Regolamento Europeo n. 10/2011 per simulanti A-B-C. Particolarmente indicato nell'industria alimentare, nel settore agricolo ed industriale a corredo di pompe di aspirazione.

For suction and delivery of food liquids according to EU Regulation 10/2011 for A-B-C simulants. Particularly used in the food, agricultural and industrial sectors in support of suction pumps.



**STRUTTURA  
BODY**

<b>A</b>	<b>Materiale Material</b>	PVC flessibile. Strong, flexible, and smooth non-toxic plasticized PVC.
<b>B</b>	<b>Inseriti Reinforcement</b>	Spirale bianca antiurto. Shock resistant PVC spiral.
<b>C</b>	<b>Copertura Cover</b>	PVC trasparente. Transparent PVC.
	<b>Superficie Surface</b>	Leggermente corrugata. Slightly corrugated.











**FASCETTE E COLLARI STRINGITUBO CONSIGLIATE  
RECOMMENDED CLAMP/COLLAR**

STF - Fascette a vite Hose clamps with screw (pag. 204-207)  
STC - Fascette con bullone Hose clamps with bolt (pag. 208-210)



- **Conforme Regolamento Europeo n. 10/2011 per simulanti A-B-C. Accordant to EU Regulation 10/2011 for A-B-C simulants.**



 mm	 mm	 bar	 bar	 bar	 gr/mt	 mm	 m
20	3,0	-	25	0,8	300	90	50
25	3,2	-	24	0,8	350	110	50
30	3,4	-	21	0,8	440	125	50
32	3,5	-	21	0,8	460	130	50
35	3,6	-	20	0,8	520	140	50
38	3,9	-	19	0,8	570	155	50
40	4,0	-	19	0,8	590	165	50
45	4,0	-	19	0,8	670	195	50
50	4,3	-	16	0,8	830	215	50
60	4,7	-	15	0,7	950	260	50
70	4,9	-	13	0,7	1150	310	50
80	5,1	-	13	0,6	1530	350	50
90	5,3	-	13	0,6	1750	415	25
100	5,5	-	12	0,6	2150	450	25



**NORME NORMS:**  
REG. UE 10/2011 FOR SIMULANT TYPE A-B-C  
ISO 1307

**DICHIARAZIONE DI CONFORMITÀ DISPONIBILE  
DECLARATION OF COMPLIANCE IS AVAILABLE**



**-5°C / +60°C  
+23°F / +140°F**



PVC



- **Conforme Regolamento Europeo n. 10/2011 per simulanti A-B-C.**  
**Accordant to EU Regulation 10/2011 for A-B-C simulants.**
- **Versione antistatica.**  
**Antistatic compound.**

**IMPIEGO APPLICATIONS**

Idoneo alla mandata ed aspirazione di liquidi alimentari secondo il Regolamento Europeo n. 10/2011 per simulanti A-B-C. Particolarmente indicato nell'industria alimentare, nel settore agricolo ed industriale a corredo di pompe di aspirazione. Versione antistatica con cordicella di rame per la dissipazione dell'elettricità statica.

For suction and delivery of food liquids according to EU Regulation 10/2011 for A-B-C simulants. Particularly used in the food, agricultural and industrial sectors in support of suction pumps. Antistatic version with copper wire for static electricity dissipation.



**STRUTTURA BODY**

<b>A</b>	<b>Materiale Material</b>	PVC flessibile. Strong, flexible, and smooth non-toxic plasticized PVC.
<b>B</b>	<b>Inserti Reinforcement</b>	Spirale bianca antiurto. Shock resistant PVC spiral.
<b>C</b>	<b>Copertura Cover</b>	PVC trasparente. Transparent PVC.
	<b>Superficie Surface</b>	Leggermente corrugata. Slightly corrugated.

mm	mm	bar	bar	bar	gr/mt	mm	m
20	3,0	-	25	0,8	300	90	50
25	3,2	-	24	0,8	350	110	50
30	3,4	-	21	0,8	440	125	50
32	3,5	-	21	0,8	460	130	50
35	3,6	-	20	0,8	520	140	50
38	3,9	-	19	0,8	570	155	50
40	4,0	-	19	0,8	590	165	50
45	4,0	-	19	0,8	670	195	50
50	4,3	-	16	0,8	830	215	50
60	4,7	-	15	0,7	950	260	50
70	4,9	-	13	0,7	1150	310	50
80	5,1	-	13	0,6	1530	350	50
90	5,3	-	13	0,6	1750	415	25
100	5,5	-	12	0,6	2150	450	25

**FASCETTE E COLLARI STRINGITUBO CONSIGLIATE RECOMMENDED CLAMP/COLLAR**

STF - Fascette a vite Hose clamps with screw (pag. 204-207)

STC - Fascette con bullone Hose clamps with bolt (pag. 208-210)



**NORME NORMS:**  
 REG. UE 10/2011 FOR SIMULANT TYPE A-B-C  
 ISO 1307

**DICHIARAZIONE DI CONFORMITÀ DISPONIBILE**  
 DECLARATION OF COMPLIANCE IS AVAILABLE

**-5°C / +60°C**  
**+23°F / +140°F**

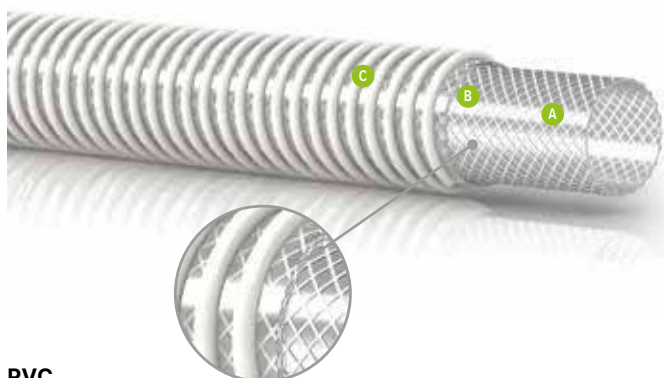

PVC



- **Conforme Regolamento Europeo n. 10/2011 per simulanti A-B-C-D1.**  
**Accordant to EU Regulation 10/2011 for A-B-C-D1 simulants.**



**IMPIEGO  
APPLICATIONS**

Idoneo alla mandata e massima aspirazione di liquidi inerti o alimentari secondo il Regolamento Europeo n. 10/2011 per simulanti A-B-C-D1. Particolarmente indicato nell'industria alimentare, enologica, cantieristica e navale.

For suction and maximum delivery of the food liquids delivery according to EU Regulation 10/2011 for A-B-C-D1 simulants. Particularly used for the food industry, wine industry or marine industry.



**STRUTTURA  
BODY**

<b>A</b>	<b>Sottostrato Tube</b>	PVC flessibile. Flexible PVC.
<b>B</b>	<b>Inserti Reinforcement</b>	Spirale bianca antiurto e inserti tessili sintetici. Shock resistant PVC spiral and synthetic textile reinforcement.
<b>C</b>	<b>Copertura Cover</b>	PVC trasparente. Transparent PVC.
	<b>Superficie Surface</b>	Leggermente corrugata. Slightly corrugated.



**FASCETTE E COLLARI STRINGITUBO CONSIGLIATE  
RECOMMENDED CLAMP/COLLAR**

STF - Fascette a vite Hose clamps with screw (pag. 204-207)  
 STC - Fascette con bullone Hose clamps with bolt (pag. 208-210)



mm	mm	bar	bar	bar	gr/mt	mm	m
38	50	7,5	23	0,95	630	64	50
40	54	7,5	21	0,95	700	70	50
51	66	7	21	0,95	1100	100	50
60	75	7	21	0,9	1250	120	50
63	78	7	21	0,9	1400	130	50
76	92	7	21	0,9	1680	150	50
80	97	7	18	0,9	2100	160	50
102	121	5,5	16	0,9	2590	200	25
127	151	5	15	0,8	4000	265	25
152	181	5	15	0,8	5680	330	25
203	231	4	12	0,7	7450	450	25



**NORME NORMS:**  
 REG. UE 10/2011 FOR SIMULANT TYPE A-B-C-D1  
 ISO 1307  
**DICHIARAZIONE DI CONFORMITÀ DISPONIBILE**  
 DECLARATION OF COMPLIANCE IS AVAILABLE



**-25°C / +60°C**  
**+13°F / +140°F**

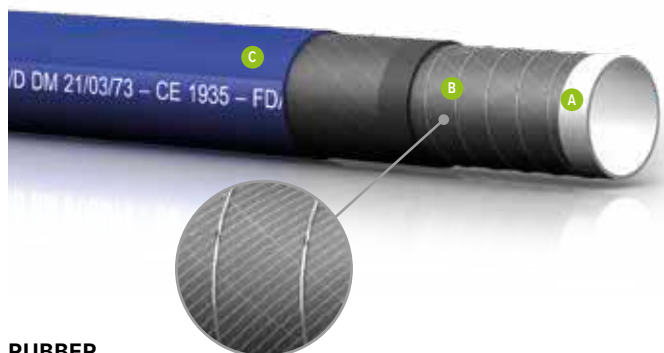

**RUBBER**



- **Prodotto secondo normativa DM 21/03/73 - CE 1935 - FDA -3° - BFR - PHTALATES FREE. Produced according norms DM 21/03/73 - CE 1935 - FDA -3° - BFR - PHTALATES FREE.**
- **Idoneo all'aspirazione e mandata di olio d'oliva. For suction and delivery of olive oil.**
- **Idoneo all'aspirazione e mandata di latte e prodotti alimentari grassi. For suction and delivery of milk and fatty foodstuff.**

**IMPIEGO APPLICATIONS**

Per aspirazione e mandata di olio di oliva e prodotti alimentari grassi (latte, etc.).

Mandrel built food hose suitable for suction and delivery of olive oil and fatty foodstuffs (milk, etc.).



**STRUTTURA BODY**

<b>A</b>	<b>Sottostrato Tube</b>	Liscio in gomma NBR bianca alimentare resistente ai grassi vegetali ad animali. White NBR rubber, resistant to vegetable oils and animal fats.
<b>B</b>	<b>Inserti Reinforcement</b>	Spirale in acciaio armonico zincato incorporata tra inserzioni di fibre sintetiche ad alta resistenza. High tensile textile plies and galvanized steel helix wire.
<b>C</b>	<b>Copertura Cover</b>	Gomma blu resistente all'abrasione, ai grassi vegetali, agli agenti atmosferici ed all'ozono. Blue, smooth rubber, vegetable fats resistant, abrasion, ozone and weather resistant.
	<b>Superficie Surface</b>	Liscia ad impressione tela. Smooth with fabric impression.

mm	mm	bar	bar	bar	gr/mt	mm	m
19	29	10	30	0,9	0,50	57	20/40/60
25	35	10	30	0,9	0,65	75	20/40/60
30	40	10	30	0,9	0,74	90	20/40/60
32	42	10	30	0,9	0,80	96	20/40/60
35	45	10	30	0,9	0,85	105	20/40/60
38	49	10	30	0,9	0,95	114	20/40/60
40	50	10	30	0,9	0,98	120	20/40/60
51	62	10	30	0,9	1,30	153	20/40/60
60	72	10	30	0,9	1,50	180	20/40/60
70	82	10	30	0,8	2,10	280	20/40/60
76	89	10	30	0,8	2,35	300	20/40/60
80	94	10	30	0,8	2,45	320	20/40/60
90	103	5	15	0,8	3,00	360	20/40/60
102	115	5	15	0,8	3,40	400	20/40/60
120	136	5	15	0,8	4,70	480	20/40/60
125	141	5	15	0,8	4,85	500	20/40/60

**NORME NORMS:**  
F.D.A, 3° SANITARY STANDARDS AND WITH BFR RECOMMENDATIONS XXI CAT.2, REG CE 1935/04 AND 2023/06 DM 21/03/73. FREE FROM PHTALATES - BPA - BISPHENOL A F.D.A - 3-A

**MARCATURA MARKING:**  
EUROCORD® ULTRAFOOD MULTIPURPOSE S/D DM 21/03/73 - CE 1935 - FDA - 3° - BFR - PHTALATES FREE

**DICHIARAZIONE DI CONFORMITÀ DISPONIBILE**  
DECLARATION OF COMPLIANCE IS AVAILABLE

**-20°C / +90°C**  
**-4°F / +194°F**



**RUBBER**



- **Garantisce l'assoluta atossicità e inalterabilità di prodotti alimentari. It guarantees the absolute non-toxicity and the inalterability of food products.**



**IMPIEGO APPLICATIONS**

Per mandata di acqua potabile, vini, liquori, succhi di frutta, bibite analcoliche e liquidi alimentari non contenenti grassi. Conforme alle norme del D.M. 21/3/73.

For suction and delivery of beverages such as wine, liqueur, beer, fruit juices, mineral water, etc. DM 21/3/73 norms approved.



**STRUTTURA BODY**

<b>A</b>	<b>Sottostrato Tube</b>	Liscio in gomma bianca alimentare EPDM/SBR NR studiata per garantire assoluta atossicità ed inalterabilità del sapore e profumo del prodotto conforme alla normativa F.D.A. title 21 - item 177.2600. White colour, non-toxic, taste and odour free EPDM/SBR NR rubber, according to FDA title 21 - item 177.2600.
<b>B</b>	<b>Inserti Reinforcement</b>	Fibre sintetiche ad alta resistenza. High tensile synthetic textile.
<b>C</b>	<b>Copertura Cover</b>	Gomma rossa (EPDM/SBR/NR) resistente all'abrasione e agli agenti atmosferici ed all'ozono. Weather, ozone and abrasion resistant, special synthetic rubber.
	<b>Superficie Surface</b>	Liscia ad impressione tela. Smooth with fabric impression.



**FASCETTE E COLLARI STRINGITUBO CONSIGLIATE RECOMMENDED CLAMP/COLLAR**

STF - Fascette a vite Hose clamps with screw (pag. 204-207)  
STC - Fascette con bullone Hose clamps with bolt (pag. 208-210)



mm	mm	bar	bar	bar	gr/mt	mm	m
13	-	10	30	-	-	130	40
16	-	10	30	-	-	160	40
18	-	10	30	-	-	180	40
19	-	10	30	-	-	190	40
25	-	10	30	-	-	250	40
30	-	10	30	-	-	300	40
32	-	10	30	-	-	320	40
35	-	10	30	-	-	350	40
38	-	10	30	-	-	380	40
40	-	10	30	-	-	400	40
45	-	10	30	-	-	450	40
51	-	10	30	-	-	510	40
60	-	10	30	-	-	600	40
70	-	10	30	-	-	700	40
80	-	10	30	-	-	800	40/20
102	-	10	30	-	-	1020	20



**NORME NORMS:**  
ISO 1307  
**MARCATURA MARKING:**  
EUROCORD® FOOD QUALITY HOSE ACCORDING F.D.A  
**CONFEZIONAMENTO BOX:**  
IMBALLO IN POLIETILENE TRASPARENTE  
PACKAGING IN TRANSPARENT POLYETHYLENE  
**DICHIARAZIONE DI CONFORMITÀ DISPONIBILE**  
DECLARATION OF COMPLIANCE IS AVAILABLE



**-40°C / +120°C**  
**-40°F / +248°F**



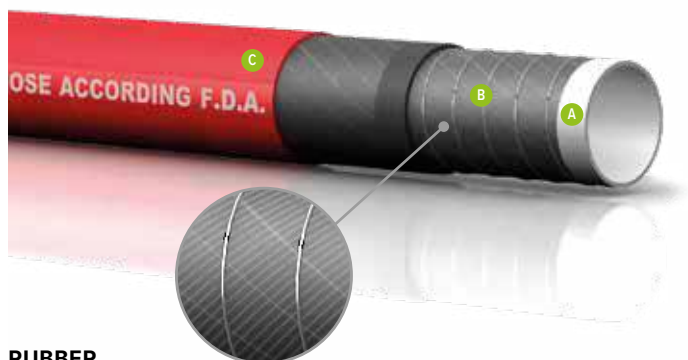

**RUBBER**



- **Garantisce l'assoluta atossicità e inalterabilità di prodotti alimentari. It guarantees the absolute non-toxicity and the inalterability of food products.**

**IMPIEGO APPLICATIONS**

Per mandata di acqua potabile, vini, liquori, succhi di frutta, bibite analcoliche e liquidi alimentari non contenenti grassi. Conforme alle norme del D.M. 21/3/73.

For suction and delivery of beverages such as wine, liqueur, beer, fruit juices, mineral water, etc. DM 21/3/73 norms approved.



**STRUTTURA BODY**

<b>A</b>	<b>Sottostrato Tube</b>	Liscio in gomma bianca alimentare EPDM/SBR NR studiata per garantire assoluta atossicità ed inalterabilità del sapore e profumo del prodotto conforme alla normativa F.D.A. title 21 - item 177.2600. White colour, non-toxic, taste and odour free EPDM/SBR NR rubber, according to FDA title 21 - item 177.2600.
<b>B</b>	<b>Inserti Reinforcement</b>	Spirale metallica e fibre tessili sintetiche ad alta tenacità. High tensile synthetic textile.
<b>C</b>	<b>Copertura Cover</b>	Gomma rossa (EPDM/SBR NR) resistente all'abrasione e agli agenti atmosferici ed all'ozono. Weather, ozone and abrasion resistant, special synthetic rubber.
	<b>Superficie Surface</b>	Liscia ad impressione tela. Smooth with fabric impression.

mm	mm	bar	bar	gr/mt	mm	m
19	-	10	30	0,7	95	40
25	-	10	30	0,7	125	40
30	-	10	30	0,7	150	40
32	-	10	30	0,7	160	40
35	-	10	30	0,7	175	40
38	-	10	30	0,7	190	40
40	-	10	30	0,7	200	40
45	-	10	30	0,7	225	40
51	-	10	30	0,7	250	40
60	-	10	30	0,7	300	40
70	-	10	30	0,7	350	40
80	-	10	30	0,7	400	40/20
90	-	10	30	0,7	450	40/20
102	-	10	30	0,7	500	20
110	-	10	30	0,7	550	20
120	-	10	30	0,7	600	20

**FASCETTE E COLLARI STRINGITUBO CONSIGLIATE RECOMMENDED CLAMP/COLLAR**

STF - Fascette a vite Hose clamps with screw (pag. 204-207)

STC - Fascette con bullone Hose clamps with bolt (pag. 208-210)



**NORME NORMS:**  
ISO 1307

**MARCATURA MARKING:**  
EUROCORD® FOOD QUALITY HOSE ACCORDING F.D.A.

**CONFEZIONAMENTO BOX:**  
IMBALLO IN POLIETILENE TRASPARENTE  
PACKAGING IN TRANSPARENT POLYETHYLENE

**DICHIARAZIONE DI CONFORMITÀ DISPONIBILE**  
DECLARATION OF COMPLIANCE IS AVAILABLE



**-40°C / +120°C**  
**-40°F / +248°F**



RUBBER



### IMPIEGO APPLICATIONS

Idoneo alla mandata di liquidi alimentari grassi: latte e suoi derivati, oli, grassi animali e vegetali, etc.

For delivery of vegetable and fatty foods and liquids



- **Specifico per mandata di liquidi alimentari grassi.**  
Specific for the delivery of fatty food liquids.



### STRUTTURA BODY

<b>A</b>	<b>Sottostrato Tube</b>	Liscio in gomma sintetica atossica di colore bianco resistente ai prodotti contenenti grassi, conforme alla normativa F.D.A. - TITLE 21- ITEM 177.2600. White, non-toxic, taste and odour free, vegetable oil resistant, food grade NBR rubber.
<b>B</b>	<b>Inseriti Reinforcement</b>	Tessili sintetici ad alta resistenza. High tensile synthetic textile.
<b>C</b>	<b>Copertura Cover</b>	Gomma blu (EPDM/SBR NR) resistente all'abrasione e agli agenti atmosferici ed all'ozono. Oil weather, ozone and abrasion resistant, special synthetic rubber.
	<b>Superficie Surface</b>	Liscia ad impressione tela. Smooth with fabric impression.



### FASCETTE E COLLARI STRINGITUBO CONSIGLIATE RECOMMENDED CLAMP/COLLAR

STF - Fascette a vite Hose clamps with screw (pag. 204-207)

STC - Fascette con bullone Hose clamps with bolt (pag. 208-210)



mm	mm	bar	bar	bar	gr/mt	mm	m
13	-	10	30	-	-	130	40
16	-	10	30	-	-	160	40
19	-	10	30	-	-	200	40
25	-	10	30	-	-	250	40
30	-	10	30	-	-	300	40
32	-	10	30	-	-	320	40
35	-	10	30	-	-	350	40
38	-	10	30	-	-	380	40
40	-	10	30	-	-	400	40
45	-	10	30	-	-	450	40
51	-	10	30	-	-	510	40
60	-	10	30	-	-	600	40
70	-	10	30	-	-	700	40
80	-	10	30	-	-	800	40-20
102	-	10	30	-	-	1020	20
120	-	10	30	-	-	1200	20



**NORME NORMS:**  
ISO 1307

**MARCATURA MARKING:**  
EUROCORD® FOOD QUALITY HOSE ACCORDING F.D.A.

**CONFEZIONAMENTO BOX:**  
IMBALLO IN POLIETILENE TRASPARENTE  
PACKAGING IN TRANSPARENT POLYETHYLENE

**DICHIARAZIONE DI CONFORMITÀ DISPONIBILE**  
DECLARATION OF COMPLIANCE IS AVAILABLE



**-40°C / +80°C**  
**-40°F / +176°F**

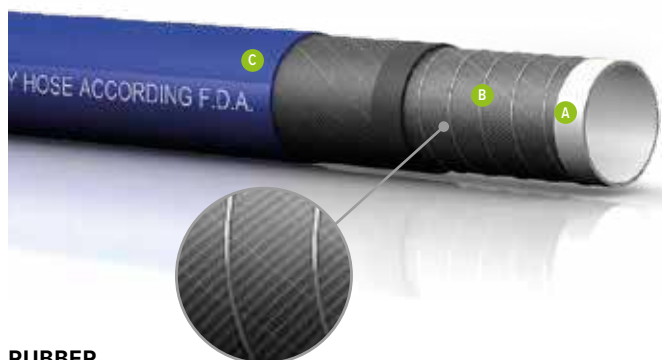

**RUBBER**



- **Specifico per mandata di liquidi alimentari grassi. Specific for the delivery of fatty food liquids.**

**IMPIEGO  
APPLICATIONS**

Idoneo alla mandata e aspirazione di liquidi alimentari grassi: latte e suoi derivati, oli, grassi animali e vegetali, etc.

For suction and delivery of vegetable and fatty foods and liquids.



**STRUTTURA  
BODY**

<b>A</b>	<b>Sottostrato Tube</b>	Liscio in gomma sintetica atossica di colore bianco resistente ai prodotti contenenti grassi, conforme alla normativa F.D.A. - TITLE 21- ITEM 177.2600. White, non-toxic, taste and odour free, vegetable oil resistant, food grade NBR rubber.
<b>B</b>	<b>Inserti Reinforcement</b>	Tessili sintetici ad alta resistenza e spirale di metallo. High tensile synthetic textile and steel wire helix.
<b>C</b>	<b>Copertura Cover</b>	Gomma blu (EPDM/SBR NR) resistente all'abrasione e agli agenti atmosferici ed all'ozono. Weather, ozone and abrasion resistant, special synthetic rubber.
	<b>Superficie Surface</b>	Liscia ad impressione tela. Smooth with fabric impression.

mm	mm	bar	bar	bar	gr/mt	mm	m
19	-	10	30	0,7	-	95	40
25	-	10	30	0,7	-	120	40
30	-	10	30	0,7	-	150	40
32	-	10	30	0,7	-	150	40
35	-	10	30	0,7	-	175	40
38	-	10	30	0,7	-	200	40
40	-	10	30	0,7	-	210	40
51	-	10	30	0,7	-	250	40
60	-	10	30	0,7	-	360	40
76	-	10	30	0,7	-	450	40
80	-	10	30	0,7	-	480	40-20
102	-	10	30	0,7	-	600	20

**FASCETTE E COLLARI STRINGITUBO CONSIGLIATE  
RECOMMENDED CLAMP/COLLAR**

- STF - Fascette a vite Hose clamps with screw (pag. 204-207)
- STC - Fascette con bullone Hose clamps with bolt (pag. 208-210)



**NORME NORMS:**  
ISO 1307  
**MARCATURA MARKING:**  
EUROCORD® FOOD QUALITY HOSE ACCORDING F.D.A.

**CONFEZIONAMENTO BOX:**  
IMBALLO IN POLIETILENE TRASPARENTE  
PACKAGING IN TRANSPARENT POLYETHYLENE

**DICHIARAZIONE DI CONFORMITÀ DISPONIBILE  
DECLARATION OF COMPLIANCE IS AVAILABLE**



**-40°C / +80°C  
-40°F / +176°F**

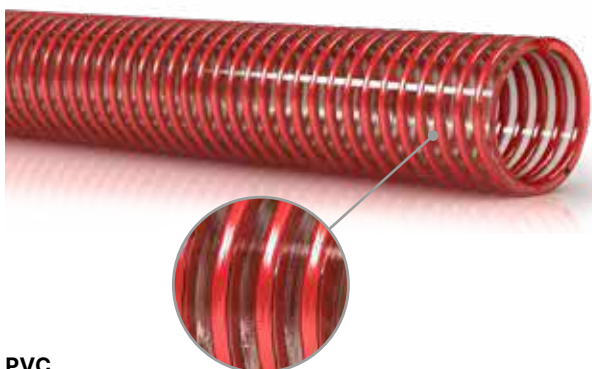

PVC



- **Eccezionalmente resistente ad urti e usi gravosi.**  
Extremely resistant to shock and heavy duty use.



**IMPIEGO APPLICATIONS**

Idoneo alla mandata ed aspirazione di liquidi alimentari secondo il Regolamento Europeo n. 10/2011 per simulanti A-B-C. Particolarmente indicato nell'industria alimentare, nel settore agricolo ed industriale a corredo di pompe di aspirazione.

Suitable for suction and delivery of food liquids according to EU Regulation 10/2011 for A-B-C simulants. Particularly used for the food, agricultural, insutrial sectors in support of suction pumps.



**STRUTTURA BODY**

<b>A</b>	<b>Materiale Material</b>	PVC. Strong, flexible, and smooth non-toxic plasticized PVC.
<b>B</b>	<b>Inseriti Reinforcement</b>	Spirale rossa antiurto. Shock resistant PVC spiral.
<b>C</b>	<b>Copertura Cover</b>	PVC trasparente, resistente all'abrasione. Crushing, abrasion and weather resistant, light corrugated outside.
	<b>Superficie Surface</b>	Liscia. Smooth.

mm	mm	bar	bar	bar	gr/mt	m	
20	3	-	28	0,9	335	100	50
25	3	-	24	0,9	400	125	50
30	3,5	-	21	0,9	535	150	50
32	3,5	-	21	0,9	580	160	50
35	3,7	-	21	0,9	630	175	50
38	3,7	-	21	0,9	680	190	50
40	3,7	-	21	0,9	710	200	50
45	4,2	-	21	0,9	815	225	50
51	5	-	17	0,95	1165	300	50
60	5,5	-	17	0,95	1550	360	50
63	5,6	-	17	0,95	1700	378	50
70	5,7	-	14	0,95	1845	420	50
76	6	-	14	0,95	1940	450	50
80	6,4	-	14	0,95	2135	480	50
90	6,7	-	14	0,95	2425	540	25
102	7,2	-	12	0,95	3200	600	25
110	7,7	-	12	0,9	3590	660	25
120	7,8	-	12	0,9	3880	720	25
152	8,7	-	10,5	0,9	6100	900	25



**FASCETTE E COLLARI STRINGITUBO CONSIGLIATE RECOMMENDED CLAMP/COLLAR**

STC - Fascette con bullone Hose clamps with bolt (pag. 208-210)



**NORME** NORMS:  
REG. UE 10/2011 FOR SIMULANT TYPE A-B-C  
ISO 1307  
DICHIARAZIONE DI CONFORMITÀ DISPONIBILE  
DECLARATION OF COMPLIANCE IS AVAILABLE



**-5°C / +60°C**  
**+23°F / +140°F**

# TUBI SPIRALATI PER ASPIRAZIONE ARIA, VENTILAZIONE E CONDIZIONAMENTO

VACUUM AND CONDITIONING SPIRAL  
PVC HOSES

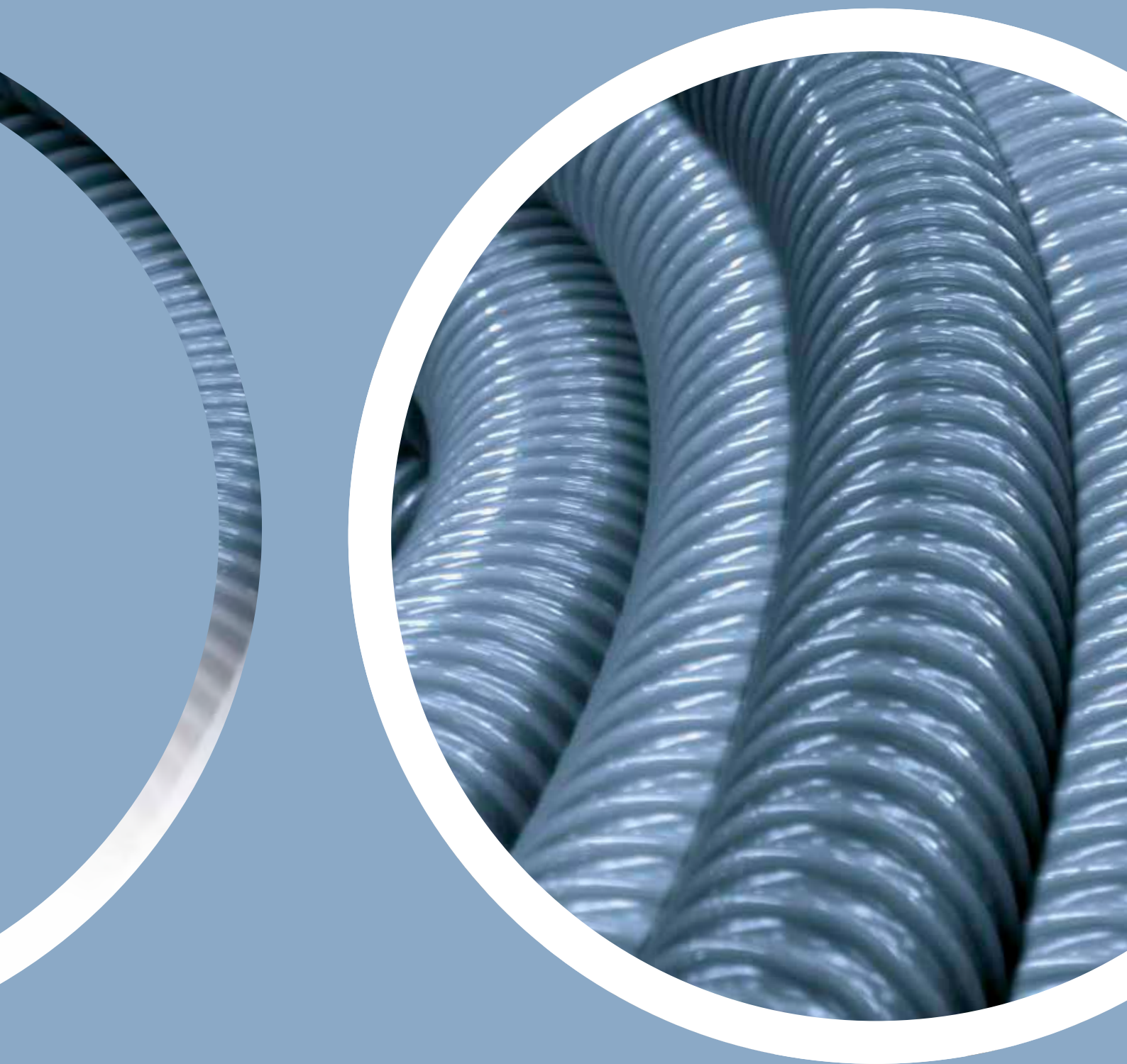



PVC



**IMPIEGO  
APPLICATIONS**

Idoneo per aspirazione e passaggio di aria, fumi, polveri, trucioli e filamenti. Particolarmente indicato nell'industria tessile, ceramica e del legno.

Suitable for the industrial ventilation and airflow systems, for dust, air, gases, powders. Particularly used in the textile, ceramic and wood industries.



- **Ottimo per industria tessile, ceramica e legno.**  
Great for the textile, ceramic and wood industries.



**STRUTTURA  
BODY**

<b>A</b>	<b>Materiale Material</b>	PVC estremamente leggero e flessibile. Extremely light and flexible plasticized PVC.
<b>B</b>	<b>Inseri Reinforcement</b>	Spirale antiurto in PVC. Shock resistant PVC spiral.
<b>C</b>	<b>Copertura Cover</b>	PVC grigio resistente all'ozono ed agli agenti atmosferici. Crushing, chemical agents, abrasion and weather resistant.
	<b>Superficie Surface</b>	Corrugata. Outside corrugated.



**FASCETTE E COLLARI STRINGITUBO CONSIGLIATE  
RECOMMENDED CLAMP/COLLAR**

- STF - Fascette a vite Hose clamps with screw (pag. 204-207)
- STC - Fascette con bullone Hose clamps with bolt (pag. 208-210)
- SSS - Fascetta salta spirale Spiral pipe clamp (pag. 219)



mm	mm	bar	bar	bar	gr/mt	mm	m
20	24,8	1	-	0,5	115	28	30
25	30	0,5	-	0,5	165	35	30
30	35,2	0,5	-	0,5	215	42	30
32	38	0,5	-	0,5	225	45	30
35	41	0,5	-	0,5	235	47	30
38	44,2	0,5	-	0,5	255	50	30
40	46,5	0,5	-	0,5	270	55	30
45	52,2	0,5	-	0,5	350	60	30
50	57	0	-	0,45	435	65	30
60	68	0	-	0,45	525	80	30
70	78,4	0	-	0,45	620	95	30
75	84	0	-	0,4	670	100	30
80	89	0	-	0,4	755	110	30
90	99	0	-	0,4	805	125	30
100	110	0	-	0,4	950	140	30
110	120,4	0	-	0,4	1065	150	30
120	131	0	-	0,35	1165	170	30
127	138	0	-	0,35	1210	173	30
130	141	0	-	0,35	1240	175	30
140	151	0	-	0,35	1455	190	30
150	162	0	-	0,35	1650	200	30
160	172	0	-	0,3	1800	220	20
180	193	0	-	0,3	2130	250	20
200	214	0	-	0,3	2330	280	20
250	264	0	-	0,3	3240	300	10
300	316	0	-	0,3	3980	330	10



**NORME NORMS:**  
ISO 1307



**-5°C / +60°C**  
**+23°F / +140°F**

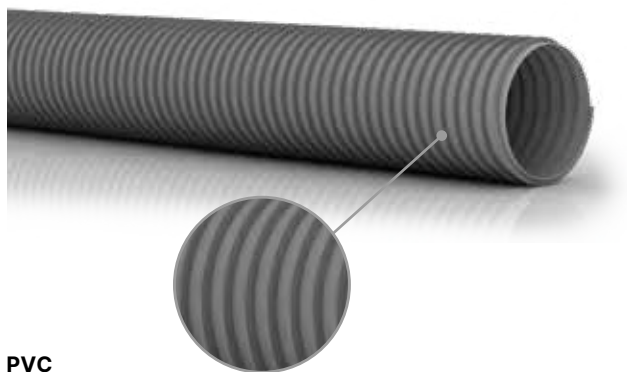

PVC



- **Ottimo per industria tessile, ceramica e legno.**  
Great for the textile, ceramic and wood industries.

**IMPIEGO APPLICATIONS**

Idoneo per aspirazione e passaggio di aria, fumi, polveri leggermente abrasive, trucioli e filamenti. Particolarmente indicato nell'industria tessile, ceramica e del legno.

Suitable for the industrial ventilation and airflow systems, for dust, air, gases, powders. Particularly used in the textile, ceramic and wood industries.



**STRUTTURA BODY**

<b>A</b>	<b>Materiale Material</b>	PVC leggero e flessibile. Extremely light and flexible plasticized PVC.
<b>B</b>	<b>Inserti Reinforcement</b>	Spirale antiurto in PVC. Shock resistant PVC spiral.
<b>C</b>	<b>Copertura Cover</b>	PVC grigio resistente all'ozono ed agli agenti atmosferici. Crushing, chemical agents, abrasion and weather resistant.
	<b>Superficie Surface</b>	Corrugata. Outside corrugated.

mm	mm	bar	bar	bar	gr/mt	mm	m
20	26	2	-	0,6	115	20	30
25	31,6	2	-	0,55	155	25	30
30	36,6	2	-	0,55	210	30	30
32	39	1,5	-	0,55	230	32	30
35	43	1,5	-	0,55	260	35	30
38	46	1,5	-	0,55	300	38	30
40	49	1,5	-	0,55	320	40	30
45	53	1,5	-	0,5	395	45	30
50	59	1,5	-	0,5	485	50	30
60	71	1,5	-	0,5	580	60	30
70	81	1,5	-	0,5	680	70	30
75	86	1,5	-	0,5	755	75	30
80	92	1,5	-	0,5	870	80	30
90	103	1,5	-	0,5	1020	90	30
100	124	1	-	0,5	1210	100	30
110	125	1	-	0,45	1360	110	30
120	135	1	-	0,45	1455	120	30
125	140	1	-	0,45	1550	125	30
130	144	1	-	0,45	1650	130	30
140	154	1	-	0,45	1800	140	30
150	164	1	-	0,4	1965	150	30
160	175	0,5	-	0,3	2280	160	20
180	195	0,5	-	0,3	2500	180	20
203	220	0,5	-	0,2	3055	203	20
250	270	0,25	-	0,15	3900	250	10
300	325	0,25	-	0,1	5500	300	10

**FASCETTE E COLLARI STRINGITUBO CONSIGLIATE RECOMMENDED CLAMP/COLLAR**

- STF - Fascette a vite Hose clamps with screw (pag. 204-207)
- STC - Fascette con bullone Hose clamps with bolt (pag. 208-210)
- SSS - Fascetta salta spirale Spiral piepe clamp (pag. 219)



**NORME NORMS:**  
ISO 1307

**-15°C / +65°C**  
**+5°F / +149°F**

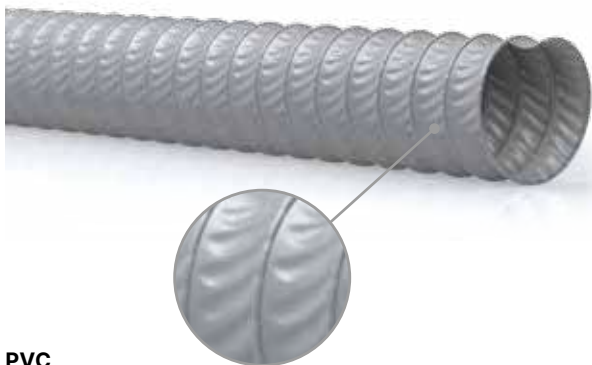

PVC



**IMPIEGO  
APPLICATIONS**

Tubazione estremamente flessibile e leggera, idonea per ventilazione meccanica collegamento bocchette e diffusori.

Extremely light and flexible hose for ventilation and air conditioning.



**STRUTTURA  
BODY**

<b>A</b>	<b>Materiale Material</b>	Tessuto poliestere spalmato di resine poliolefiniche additivate. Polyester hose with resins polyolefin with additives.
<b>B</b>	<b>Inseriti Reinforcement</b>	Spirale elicoidale in filo di acciaio armonico. Helical spiral in harmonic steel wire.
<b>C</b>	<b>Copertura Cover</b>	Corrugata. Outside corrugated.
	<b>Superficie Surface</b>	Grigio metallico. Metallic grey.



**FASCETTE E COLLARI STRINGITUBO CONSIGLIATE  
RECOMMENDED CLAMP/COLLAR**

STF - Fascette a vite Hose clamps with screw (pag. 204-207)

STC - Fascette con bullone Hose clamps with bolt (pag. 208-210)



- **Estrema flessibilità e leggerezza.**  
Extremely flexible and light.



mm	mm	bar	bar	bar	gr/mt	mm	m
51	-	-	-	-	-	0,6 x Di	10
63	-	-	-	-	-	0,6 x Di	10
70	-	-	-	-	-	0,6 x Di	10
80	-	-	-	-	-	0,6 x Di	10
89	-	-	-	-	-	0,6 x Di	10
102	-	-	-	-	-	0,6 x Di	10
110	-	-	-	-	-	0,6 x Di	10
121	-	-	-	-	-	0,6 x Di	10
127	-	-	-	-	-	0,6 x Di	10
133	-	-	-	-	-	0,6 x Di	10
140	-	-	-	-	-	0,6 x Di	10
152	-	-	-	-	-	0,6 x Di	10
160	-	-	-	-	-	0,6 x Di	10
180	-	-	-	-	-	0,6 x Di	10
203	-	-	-	-	-	0,6 x Di	10
254	-	-	-	-	-	0,6 x Di	10
305	-	-	-	-	-	0,6 x Di	10
356	-	-	-	-	-	0,6 x Di	10
406	-	-	-	-	-	0,6 x Di	10
457	-	-	-	-	-	0,6 x Di	10



**COMPRESSIBILITÀ ASSIALE AXIAL  
COMPRIMIBILITY:**  
8:1



**-20°C / +90°C**  
con picchi fino a  
with peaks up to  
+100°C  
**-4°F / +194°F**  
con picchi fino a  
with peaks up to  
+212°F



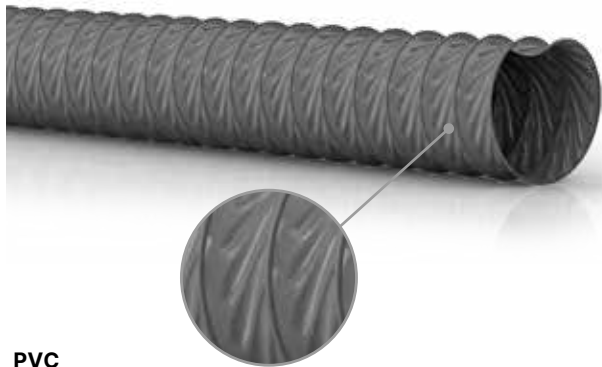

PVC



- **Estrema flessibilità e leggerezza.**  
Extremely flexible and light.

**IMPIEGO APPLICATIONS**

Tubazione estremamente flessibile e leggera. Idonea per passaggio di aria, fumi e polveri; particolarmente indicato nel condizionamento navale e civile.

Extremely light and flexible hose for the ventilation and air conditioning. Suitable for air, dust, fumes passage.



**STRUTTURA BODY**

<b>A</b>	<b>Materiale Material</b>	Tessuto di poliammide spalmato su due lati di PVC. Polyamide fabric, coated on two sides of PVC.
<b>B</b>	<b>Inseriti Reinforcement</b>	Spirale incorporata in acciaio armonico ricoperata di PVC. Harmonic steel incorporated spiral, coated of PVC.
<b>C</b>	<b>Copertura Cover</b>	Corrugata. Outside corrugated.
	<b>Superficie Surface</b>	Grigio scuro metallico. Metallic dark grey.

mm	mm	bar	bar	bar	gr/mt	mm	m
40	-	0,90	-	0,24	120	0,7 x Di	10
45	-	0,80	-	0,20	130	0,7 x Di	10
50	-	0,80	-	0,20	145	0,7 x Di	10
60	-	0,80	-	0,16	170	0,7 x Di	10
65	-	0,70	-	0,14	182	0,7 x Di	10
70	-	0,70	-	0,14	198	0,7 x Di	10
80	-	0,60	-	0,10	227	0,7 x Di	10
90	-	0,50	-	0,09	254	0,7 x Di	10
100	-	0,50	-	0,09	285	0,7 x Di	10
110	-	0,50	-	0,08	310	0,7 x Di	10
120	-	0,50	-	0,08	342	0,7 x Di	10
125	-	0,40	-	0,08	356	0,7 x Di	10
130	-	0,40	-	0,08	370	0,7 x Di	10
140	-	0,25	-	0,06	398	0,7 x Di	10
150	-	0,25	-	0,06	427	0,7 x Di	10
160	-	0,20	-	0,06	527	0,7 x Di	10
180	-	0,20	-	0,06	590	0,7 x Di	10
200	-	0,20	-	0,05	660	0,7 x Di	10
250	-	0,10	-	0,04	825	0,7 x Di	10
300	-	0,06	-	0,03	990	0,7 x Di	10
350	-	0,05	-	0,02	1155	0,7 x Di	10
400	-	0,04	-	0,01	1320	0,7 x Di	10
450	-	0,03	-	0,01	1485	0,7 x Di	10

**FASCETTE E COLLARI STRINGITUBO CONSIGLIATE RECOMMENDED CLAMP/COLLAR**

- STF - Fascette a vite Hose clamps with screw (pag. 204-207)
- STC - Fascette con bullone Hose clamps with bolt (pag. 208-210)



**COMPRESSIBILITÀ ASSIALE AXIAL**  
COMPRESSIBILITY:  
8:1

**-20°C / +90°C**  
con picchi fino a  
with peaks up to  
+100°C

**-4°F / +194°F**  
con picchi fino a  
with peaks up to  
+212°F

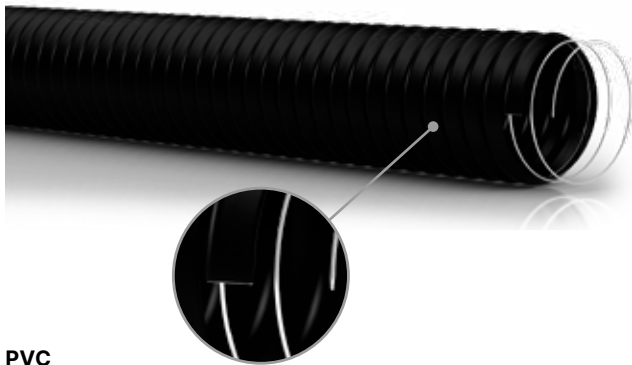

PVC



**IMPIEGO  
APPLICATIONS**

Tubo flessibile realizzato con foglia di termoplastico elastomero di spessore 0,8 mm e spirale incorporata in filo di acciaio armonico. Idoneo per aspirazione gas e fumi anche in presenza di solventi e acidi. Trasporto pneumatico e aspirazione granuli. Particolarmente indicato in presenza di fumi aggressivi.

Indicated by aggressive fumes. Suction of gas and fumes plants, even with solvents and acids. Pneumatic conveyance, granule suction.



**STRUTTURA  
BODY**

<b>A</b>	<b>Materiale Material</b>	Tubo flessibile realizzato con foglia di termoplastico elastomero di spessore 0,8 mm. Flexible hose made of thermoplastic elastomer additivated with flame retardant and polyolefine (th. 0,80 mm).
<b>B</b>	<b>Inseriti Reinforcement</b>	Spirale incorporata in filo di acciaio armonico. Embedded steel wire helix.
<b>C</b>	<b>Copertura Cover</b>	Corrugata. Corrugated.
	<b>Superficie Surface</b>	Nero. Black.

mm	mm	bar	bar	bar	gr/mt	mm	m
40	-	0,50	-	0,25	228	28	10
50	-	0,40	-	0,20	295	35	10
60	-	0,40	-	0,16	342	42	10
70	-	0,35	-	0,14	399	49	10
80	-	0,28	-	0,10	456	56	10
100	-	0,20	-	0,09	515	70	10
120	-	0,20	-	0,08	610	80	10
130	-	0,20	-	0,08	684	90	10
150	-	0,10	-	0,06	772	105	10
160	-	0,10	-	0,06	850	110	10
180	-	0,09	-	0,05	935	128	10
200	-	0,08	-	0,05	1024	140	10
250	-	0,05	-	0,04	1280	175	10
300	-	0,03	-	0,03	1540	210	10
350	-	0,02	-	0,02	2340	245	10
400	-	0,02	-	0,02	2630	280	10
450	-	0,01	-	0,01	2960	315	10
500	-	0,01	-	0,01	3290	350	10



**FASCETTE E COLLARI STRINGITUBO CONSIGLIATE  
RECOMMENDED CLAMP/COLLAR**

- STF - Fascette a vite Hose clamps with screw (pag. 204-207)
- STC - Fascette con bullone Hose clamps with bolt (pag. 208-210)
- SSS - Fascetta salta spirale Spiral pipe clamp (pag. 219)



NORME NORMS:  
ISO 1307



**-20°C / +125°C**  
con picchi fino a  
with peaks up to  
+135°C  
**-4°F / +257°F**  
con picchi fino a  
with peaks up to  
+275°F



PVC



- **Ottima resistenza alle basse ed alte temperature.**  
Excellent high and low temperature resistance.
- **Ottima flessibilità.**  
Excellent flexibility.

**IMPIEGO APPLICATIONS**

Idoneo per aspirazione e soffiaggio di aria e fumi caldi. Ottima resistenza alle alte e basse temperature ed ai solventi.

For suction and delivery of air and hot fumes. Excellent high and low temperature resistance



**STRUTTURA BODY**

<b>A</b>	<b>Materiale Material</b>	Tubo flessibile realizzato con uno strato di tessuto in fibra di vetro spalmato di neoprene. Flexible hose composed by a layer of glass-fiber fabric smeared of neoprene inside.
<b>B</b>	<b>Inseriti Reinforcement</b>	Spirale interna e visibile in acciaio armonico ramato, cordoncino esterno in fibra di vetro. Visible spiral in coppered harmonic steel, external in glass-fiber.
<b>C</b>	<b>Copertura Cover</b>	Corrugata. Outside corrugated.
	<b>Superficie Surface</b>	Nero. Black.

mm	mm	bar	bar	bar	gr/mt	mm	m
19	-	1,7	-	-	80	6	4
25	-	1,6	-	-	120	8	4
38	-	1,3	-	-	168	12	4
51	-	1,2	-	-	250	16	4
63	-	1,1	-	-	300	20	4
76	-	1,1	-	-	410	25	4
89	-	1,0	-	-	490	29	4
95	-	0,9	-	-	550	33	4
102	-	0,9	-	-	650	35	4
114	-	0,9	-	-	720	40	4
127	-	0,8	-	-	800	46	4
152	-	0,7	-	-	980	50	4
178	-	0,6	-	-	1190	60	4
203	-	0,5	-	-	1330	68	4
254	-	0,4	-	-	1650	100	4
305	-	0,1	-	-	2000	116	4

**FASCETTE E COLLARI STRINGITUBO CONSIGLIATE RECOMMENDED CLAMP/COLLAR**

STF - Fascette a vite Hose clamps with screw (pag. 204-207)

STC - Fascette con bullone Hose clamps with bolt (pag. 208-210)



**-55°C / +130°C**  
con picchi fino a  
with peaks up to  
+150°C

**-67°F / +266°F**  
con picchi fino a  
with peaks up to  
+302°F

# THERMOCORD

## NEOPRENE 150°C - 2S (2 STRATI/LAYERS)



PVC



- **Ottima flessibilità.**  
Excellent flexibility.



### IMPIEGO APPLICATIONS

Aspirazione e ventilazione industriale. Raffreddamento apparati elettronici e sale macchine navi. Aspirazione aria diesel, riscaldamento per autoveicoli.

Suitable for cooling of electronical machines and ship engine rooms. For diesel air suction and cars heating.



### STRUTTURA BODY

<b>A</b>	<b>Sottostrato Tube</b>	Tubo flessibile realizzato con doppio strato di tessuto in fibra di vetro spalmato di neoprene. Flexible hose composed by two layers of neoprene coated fiberglass fabric.
<b>B</b>	<b>Inseri Reinforcement</b>	Spirale incorporata in filo d'acciaio armonico ramato, doppio cordoncino esterno in fibra di vetro. Embedded copper-plated steel wire helix and external double fiberglass cord.
<b>C</b>	<b>Copertura Cover</b>	Corrugata. Outside corrugated.
	<b>Superficie Surface</b>	Nero. Black.



### FASCETTE E COLLARI STRINGITUBO CONSIGLIATE RECOMMENDED CLAMP/COLLAR

STF - Fascette a vite Hose clamps with screw (pag. 204-207)

STC - Fascette con bullone Hose clamps with bolt (pag. 208-210)



mm	mm	bar	bar	bar	gr/mt	mm	m
19	-	3	-	-	110	9	4
25	-	2,8	-	-	185	12	4
38	-	2,6	-	-	305	18	4
51	-	2,6	-	-	360	24	4
63	-	2,4	-	-	485	31	4
76	-	2,2	-	-	580	38	4
89	-	2,0	-	-	690	44	4
95	-	1,9	-	-	730	49	4
102	-	1,9	-	-	770	52	4
114	-	1,5	-	-	845	60	4
127	-	1,4	-	-	925	69	4
152	-	1,2	-	-	1200	75	4
178	-	1,0	-	-	1430	90	4
203	-	0,7	-	-	1650	101	4
254	-	0,5	-	-	2090	150	4
305	-	0,3	-	-	2550	200	4



**-55°C / +130°C**  
con picchi fino a  
with peaks up to  
+150°C

**-67°F / +266°F**  
con picchi fino a  
with peaks up to  
+302°F

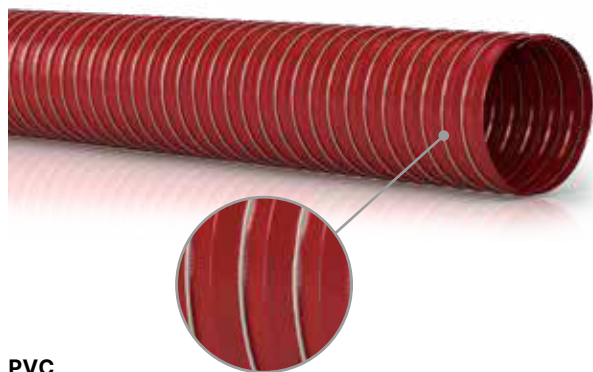

PVC



- **Ottima resistenza alle alte temperature.**  
Excellent high temperature resistance.
- **Ottima flessibilità.**  
Excellent flexibility.

**IMPIEGO  
APPLICATIONS**

Idoneo per aspirazione, estrazione e soffiaggio d'aria anche con particelle polverose in presenza di alte temperature.

For suction, extraction and blowing air with dust particles also at high temperatures.



**STRUTTURA  
BODY**

<b>A</b>	<b>Materiale Material</b>	Tubo flessibile realizzato con uno strato di tessuto in fibra di vetro spalmato di silicone. Flexible hose composed by a layer of glass-fiber fabric smeared of neoprene inside.
<b>B</b>	<b>Inseriti Reinforcement</b>	Spirale interna e visibile in acciaio armonico ramato, cordoncino esterno in fibra di vetro. Visible spiral in coppered harmonic steel, external in glass-fiber.
<b>C</b>	<b>Copertura Cover</b>	Corrugata. Outside corrugated.
	<b>Superficie Surface</b>	Rosso mattone. Brick red.

mm	mm	bar	bar	bar	gr/mt	mm	m
19	-	1,7	-	-	80	6	4
25	-	1,6	-	-	120	8	4
38	-	1,3	-	-	168	12	4
51	-	1,2	-	-	250	16	4
63	-	1,1	-	-	300	20	4
76	-	1,1	-	-	410	25	4
89	-	1,0	-	-	490	29	4
95	-	0,9	-	-	550	33	4
102	-	0,9	-	-	650	35	4
114	-	0,9	-	-	720	40	4
127	-	0,8	-	-	800	46	4
152	-	0,7	-	-	980	50	4
178	-	0,6	-	-	1190	60	4
203	-	0,5	-	-	1330	68	4
254	-	0,4	-	-	1650	100	4
305	-	0,1	-	-	2000	116	4

**FASCETTE E COLLARI STRINGITUBO CONSIGLIATE  
RECOMMENDED CLAMP/COLLAR**

- STF - Fascette a vite Hose clamps with screw (pag. 204-207)
- STC - Fascette con bullone Hose clamps with bolt (pag. 208-210)



**COMPRESSIBILITÀ ASSIALE AXIAL  
COMPRESSIBILITY:**  
30%  
**A RICHIESTA È POSSIBILE FORNIRE:  
VERSIONE AUTOESTINGUENTE V-O (UL 94),  
BLU O GRIGIO.**  
**AVAILABLE ON REQUEST: SELF-EXTINGUISHING  
VERSION V-O (UL94), BLUE OR GREY.**



**-60°C / +270°C**  
con picchi fino a  
with peaks up to  
**+300°C**  
**-76°F / +518°F**  
con picchi fino a  
with peaks up to  
**+572°F**

# THERMOCORD

## SILICONE 300°C - 2S (2 STRATI/LAYERS)

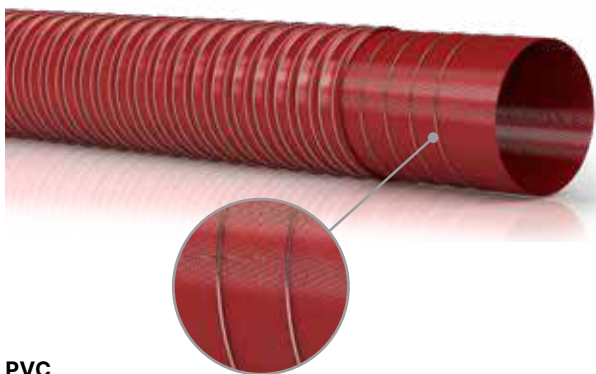

PVC



### IMPIEGO APPLICATIONS

Aspirazione, estrazione e soffiaggio d'aria anche con particelle polverose i presenza di alte temperature.

For suction, extraction and blowing air with dust particles also at high temperatures.



- **Ottima resistenza alle alte temperature.**  
Excellent high temperature resistance.
- **Ottima flessibilità.**  
Excellent flexibility.



### STRUTTURA BODY







<b>A</b>	<b>Sottostrato Tube</b>	Tubo flessibile realizzato con doppio strato di tessuto in fibra di vetro spalmato di silicone. Flexible hose composed by two layers of silicone coated fiberglass fabric.
<b>B</b>	<b>Inseri Reinforcement</b>	Spirale incorporata in filo d'acciaio armonico ramato, doppio cordoncino esterno in fibra di vetro. Embedded copper-plated steel wire helix and external double fiberglass cord.
<b>C</b>	<b>Copertura Cover</b>	Corrugata. Outside corrugated.
	<b>Superficie Surface</b>	Rosso mattone. Brick red.



### FASCETTE E COLLARI STRINGITUBO CONSIGLIATE RECOMMENDED CLAMP/COLLAR

STF - Fascette a vite Hose clamps with screw (pag. 204-207)  
STC - Fascette con bullone Hose clamps with bolt (pag. 208-210)



 mm	 mm	 bar	 bar	 bar	 gr/mt	 mm	 m
19	-	3	-	-	110	9	4
25	-	2,8	-	-	185	12	4
38	-	2,6	-	-	305	18	4
51	-	2,6	-	-	360	24	4
63	-	2,4	-	-	485	31	4
76	-	2,2	-	-	580	38	4
89	-	2,0	-	-	690	44	4
95	-	1,9	-	-	730	49	4
102	-	1,9	-	-	770	52	4
114	-	1,5	-	-	845	60	4
127	-	1,4	-	-	925	69	4
152	-	1,2	-	-	1200	75	4
178	-	1,0	-	-	1430	90	4
203	-	0,7	-	-	1650	101	4
254	-	0,5	-	-	2090	150	4
305	-	0,3	-	-	2550	200	4



**COMPRESSIBILITÀ ASSIALE AXIAL  
COMPRESSIBILITY:**

30%

**A RICHIESTA È POSSIBILE FORNIRE:**

VERSIONE AUTOESTINGUENTE V-0 (UL 94),  
BLU O GRIGIO.

AVAILABLE ON REQUEST: SELF-EXTINGUISHING  
VERSION V-0 (UL94), BLUE OR GREY.



**-60°C / +270°C**  
con picchi fino a  
with peaks up to  
+300°C

**-76°F / +518°F**  
con picchi fino a  
with peaks up to  
+572°F

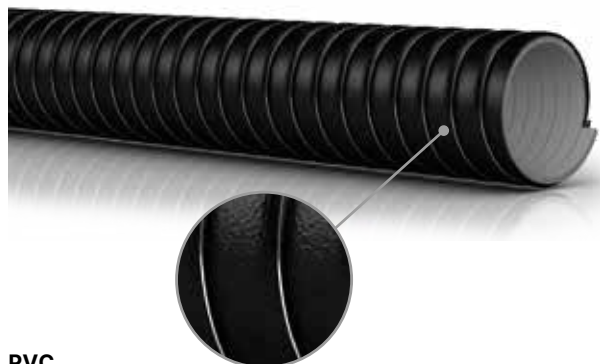

**PVC**

**IMPIEGO APPLICATIONS**

Utilizzato nel condizionamento dell'aria, ventilazione meccanica semplice e a doppio flusso, riduzione della condensa e delle dispersioni di calore, impianti di condizionamento dell'aria per mezzi di trasporto, per uso agricolo, industriale e navale.

Air conditioning, mechanical ventilation simple or double flow, reduction of condensation and heat dispersion, air conditioning plants for transport, agricultural, industrial and marine use.

**STRUTTURA BODY**

<b>A</b> Materiale Material	Tubo flessibile realizzato con film di resine poliolefiniche additivate, rivestimento termoisolante in polietilene reticolato ed espanso a celle chiuse, protezione esterna film di resine poliolefiniche additivate. Addivated polyolefin resin film cover: flexible hose made of addivated polyolefin resins film, thermos, insulating coating in netted and closed cell foam polyethylene, external protection in addivated polyolefin resins film.
<b>B</b> Inseriti Reinforcement	Spirale incorporata in filo d'acciaio armonico. Ambedded steel wire helix.
<b>C</b> Copertura Cover	Leggermente ondulata. Slightly wavy.
<b>Superficie Surface</b>	Nero esterno, grigio interno. Outside black, inside light grey.

<b>POLIETILENE RETICOLATO ESPANSO TIPO CL1 NETTED POLYETHYLENE FOAM TYPE CL1</b>			
<b>PROPRIETÀ FISICO-MECCANICHE Physical-mechanical properties</b>	<b>U.M. S.M.</b>	<b>METODO Rules</b>	<b>VALORI Values</b>
DENSITÀ Density	kg/m <sup>3</sup>	ISO 845	30
CLASSE DI COMBUSTIONE Class of combustion		CSF RF2/75° RF 3/77	CL 1
COEFFICIENTE DI CONDUCEBILITÀ TERMICA A 0°C (λ) Coefficient of thermal conductivity at 0°C (λ)	W/mk kcal/min °C	UNI 7745 ASTM C177 UNI 7745 ASRM C177	0,0344 0,0294
COEFFICIENTE DI CONDUCEBILITÀ TERMICA A 40°C (λ) Coefficient of thermal conductivity at 40°C (λ)	W/mk kcal/min °C	UNI 7745 ASTM C177 UNI 7745 ASRM C177	0,0372 0,0032
COEFF. DI RESISTENZA ALTA DIFFUSIONE DEL VAPORE ACQUEO Coefficient of resistance to water steam diffusion	μ	DIN 52615	>65.000
PERMEABILITÀ AL VAPORE D'ACQUA Permeability to water steam	Ng/Pa s m	DIN 52616	0,12
ASSORBIMENTO D'ACQUA DOPO 24 gg Water absorbtion after 24 days	Vol. %	DIN 53433	<3
RESISTENZA ALLA COMPRESIONE AL 10% Compressive strenght at 10%	g/cm <sup>2</sup>	ISO 3386/1	190,00
STABILITÀ DIMENSIONALE Dimension stability	°C	DIN 53431	100
TEMPERATURA MAX D'USO Max operating temperature	°C	--	-80 +100
TEMPERATURA D'IMPIEGO CON SOLLECITAZIONE MECCANICA Operating temperature with mechanical stress	°C	--	-40 +100

mm	mm	bar	bar	bar	gr/mt	mm	m
50	-	0,70	-	0,18	96	35	10
60	-	0,70	-	0,15	115	42	10
70	-	0,60	-	0,13	128	49	10
80	-	0,50	-	0,09	154	56	10
102	-	0,40	-	0,08	200	70	10
127	-	0,40	-	0,07	254	92	10
152	-	0,20	-	0,05	308	105	10
160	-	0,15	-	0,05	331	110	10
180	-	0,15	-	0,05	438	130	10
203	-	0,15	-	0,04	492	140	10
254	-	0,08	-	0,03	600	175	10

**VELOCITÀ ARIA AIR SPEED:**  
MAX 20 m/sec

**REAZIONE AL FUOCO:**  
FILM INTERNO ED ESTERNO CLASSE 1 - M1,  
PES ESPANSO CLASSE 1 - M1

**FIRE REACTION:**  
INTERNAL AND EXTERNAL FILM CLASS 1 - M1,  
PES CLOSED-CELL FOAM 1 - M1

**-40°C / +100°C**  
**-40°F / +212°F**

# TUBI PER MATERIALI ABRASIVI

BULK MATERIAL HOSES







PVC

- **Idoneo al contatto di alimenti per i quali sono previsti i simulanti D2 e E secondo Reg. Europeo n.10/2011\*.**  
Suitable for the food contact in according with EU Regulation 10/2011 for D2 and E simulants\*.
- **Eccellente resistenza all'abrasione.**  
Excellent resistance to abrasion.

**IMPIEGO APPLICATIONS**

Idoneo all'aspirazione di prodotti abrasivi: sabbia, grano, trucioli e polveri in genere. Idonei anche al contatto con alimenti oleosi e/o grassi, secchi per i quali sono previsti i simulanti D2 e E secondo Reg. Europeo n. 10/2011\*. Particolarmente indicato nelle carrozzerie, nell'industria del legno, della ceramica e farmaceutica.

Suitable also for the fatty, oily or dry aliments in according with EU Regulation 10/2011 for D2 and E simulants. Particularly used for the car bodies and in the wood, ceramic and pharmaceutical industries.



**STRUTTURA BODY**

<b>A</b>	<b>Materiale Material</b>	Poliuretano. Polyurethane.
<b>B</b>	<b>Inserti Reinforcement</b>	Spirali di rinforzo in PVC antiurto. Shock resistant PVC spiral.
<b>C</b>	<b>Copertura Cover</b>	Corrugata. Outside corrugated.
	<b>Superficie Surface</b>	Trasparente avorio. Transparent ivory.

mm	mm	PU mm	bar	bar	gr/mt	mm	m
20	25	0,35	-	0,5	100	20	20
25	30,4	0,35	-	0,5	150	25	20
30	36,0	0,35	-	0,5	190	30	20
32	38,0	0,35	-	0,5	200	32	20
35	41,4	0,35	-	0,4	215	35	20
38	44,6	0,40	-	0,4	230	38	20
40	46,6	0,40	-	0,4	250	40	20
45	51,8	0,45	-	0,4	280	45	20
50	57,0	0,50	-	0,4	310	50	20
60	67,4	0,50	-	0,4	390	60	20
63	70,6	0,50	-	0,4	430	63	20
70	78,4	0,55	-	0,4	500	70	20
75	83,8	0,55	-	0,4	550	75	20
80	89,0	0,55	-	0,4	610	80	20
90	99,4	0,55	-	0,4	715	90	20
100	110,4	0,60	-	0,4	820	100	20
110	120,4	0,60	-	0,3	890	110	20
120	131,0	0,60	-	0,3	950	120	20
125	136,6	0,65	-	0,3	1000	125	20
150	162,8	0,70	-	0,3	1365	150	20
160	173,0	0,70	-	0,3	1550	160	20
180	193,4	0,70	-	0,3	1900	180	20
200	213,6	0,80	-	0,3	2100	200	10

**FASCETTE E COLLARI STRINGITUBO CONSIGLIATE RECOMMENDED CLAMP/COLLAR**

- STF - Fascette a vite Hose clamps with screw (pag. 204-207)
- STC - Fascette con bullone Hose clamps with bolt (pag. 208-210)
- SSS - Fascetta salta spirale Spiral piepe clamp (pag. 219)



\* CONTATTO RIPETUTO MASSIMO DI 2 ORE ALLA TEMPERATURA MASSIMA DI 70°C MAX 70°C FOR 2 HOURS

**NORME NORMS:**  
REG. UE 10/2011  
ISO 1307

**DICHIARAZIONE DI CONFORMITÀ DISPONIBILE**  
DECLARATION OF COMPLIANCE IS AVAILABLE

**-25°C / +85°C**  
**-13°F / +185°F**

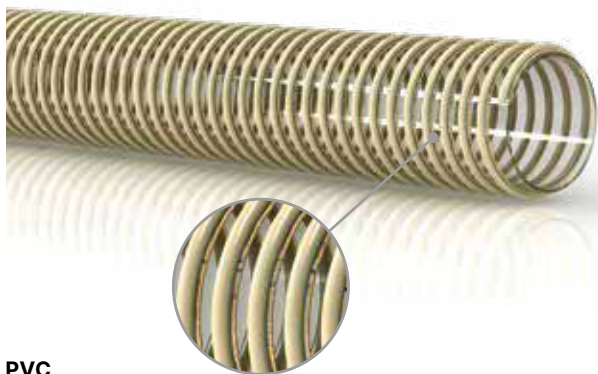

PVC



- **Idoneo al contatto di alimenti per i quali sono previsti i simulanti D2 e E secondo Reg. Europeo n.10/2011\*.**  
**Suitable for the food contact in according with EU Regulation 10/2011 for D2 and E simulants\*.**
- **Versione antistatica.**  
**Antistatic compound.**



**IMPIEGO**  
**APPLICATIONS**

Versione antistatica. Idoneo all'aspirazione di prodotti abrasivi: sabbia, grano, trucioli e polveri in genere. Idonei anche al contatto con alimenti oleosi e/o grassi, secchi per i quali sono previsti i simulanti D2 e E secondo Regolamento Europeo N. 10/2011. Particolarmente indicato nelle carrozzerie, nell'industria del legno, della ceramica e farmaceutica.

Antistatic version. Suitable also for the fatty, oily or dry aliments in according with EU Regulation 10/2011 for D2 and E simulants. Particularly used for the car bodies and in the wood, ceramic and pharmaceutical industries.



**STRUTTURA**  
**BODY**









<b>A</b>	<b>Sottostrato Tube</b>	Poliuretano. Polyurethane.
<b>B</b>	<b>Inserti Reinforcement</b>	Spirale di rinforzo in PVC antiurto. Shock resistant PVC spiral.
<b>C</b>	<b>Copertura Cover</b>	Corrugata. Outside corrugated.
	<b>Superficie Surface</b>	Trasparente avorio. Transparent ivory.



**FASCETTE E COLLARI STRINGITUBO CONSIGLIATE**  
**RECOMMENDED CLAMP/COLLAR**

- STF - Fascette a vite Hose clamps with screw (pag. 204-207)  
 STC - Fascette con bullone Hose clamps with bolt (pag. 208-210)  
 SSS - Fascetta salta spirale Spiral piepe clamp (pag. 219)



 mm	 mm	 mm	 bar	 bar	 gr/mt	 mm	 m
20	25	0,35	-	0,5	100	20	20
25	30,4	0,35	-	0,5	150	25	20
30	36,0	0,35	-	0,5	190	30	20
32	38,0	0,35	-	0,5	200	32	20
35	41,4	0,35	-	0,4	215	35	20
38	44,6	0,40	-	0,4	230	38	20
40	46,6	0,40	-	0,4	250	40	20
45	51,8	0,45	-	0,4	280	45	20
50	57,0	0,50	-	0,4	310	50	20
60	67,4	0,50	-	0,4	390	60	20
63	70,6	0,50	-	0,4	430	63	20
70	78,4	0,55	-	0,4	500	70	20
75	83,8	0,55	-	0,4	550	75	20
80	89,0	0,55	-	0,4	610	80	20
90	99,4	0,55	-	0,4	715	90	20
100	110,4	0,60	-	0,4	820	100	20
110	120,4	0,60	-	0,3	890	110	20
120	131,0	0,60	-	0,3	950	120	20
125	136,6	0,65	-	0,3	1000	125	20
150	162,8	0,70	-	0,3	1365	150	20
160	173,0	0,70	-	0,3	1550	160	20
180	193,4	0,70	-	0,3	1900	180	20
200	213,6	0,80	-	0,3	2100	200	10



**NORME NORMS:**  
 REG. UE 10/2011 - ISO 1307  
 A RICHIESTA DISPONIBILE NELLA VERSIONE ANTISTATICA CHIMICAMENTE.  
 UPON REQUEST IT COULD BE PROVIDED WITH ANTISTATIC COMPOUND.  
**DICHIARAZIONE DI CONFORMITÀ DISPONIBILE**  
 DECLARATION OF COMPLIANCE IS AVAILABLE



**-25°C / +85°C**  
**-13°F / +185°F**

\* CONTATTO RIPETUTO MASSIMO DI 2 ORE ALLA TEMPERATURA MASSIMA DI 70°C MAX 70°C FOR 2 HOURS

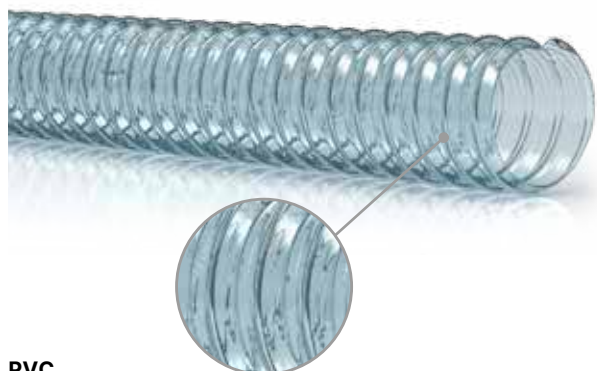

PVC



- **Ottimo per industria legno, ceramica e farmaceutica.**  
Great for the wood, ceramic and pharmaceutical industries.
- **Eccellente resistenza all'abrasione.**  
Excellent resistance to abrasion.

**IMPIEGO APPLICATIONS**

Idoneo all'aspirazione di polveri abrasive in genere. Particolarmente indicato nelle carrozzerie, nell'industria del legno, ceramica e farmaceutica.

Suitable for suction of abrasive dust. Particularly used for the car bodies and in wood, ceramic and pharmaceutical industries.



**STRUTTURA BODY**

<b>A</b>	<b>Materiale Material</b>	Poliuretano. Polyurethane.
<b>B</b>	<b>Inserti Reinforcement</b>	Spirale di acciaio armonico zincato. Built-in steel spiral.
<b>C</b>	<b>Copertura Cover</b>	Corrugata. Outside corrugated.
	<b>Superficie Surface</b>	Trasparente con spirale zincata. Transparent, galvanized steel spiral.

mm	mm	bar	bar	bar	gr/mt	mm	m
50	-	-	-	0,2	285	35	20
60	-	-	-	0,15	255	42	20
70	-	-	-	0,13	300	55	20
80	-	-	-	0,1	340	60	20
90	-	-	-	0,09	380	67	20
100	-	-	-	0,09	410	75	20
120	-	-	-	0,07	550	90	20
125	-	-	-	0,06	565	92	20
130	-	-	-	0,06	580	95	20
140	-	-	-	0,05	680	100	20
150	-	-	-	0,05	765	110	20
160	-	-	-	0,05	815	120	20
180	-	-	-	0,04	860	130	20
200	-	-	-	0,04	955	150	20
250	-	-	-	0,03	1150	180	10
300	-	-	-	0,02	1385	220	10
350	-	-	-	0,02	2030	250	10

**FASCETTE E COLLARI STRINGITUBO CONSIGLIATE RECOMMENDED CLAMP/COLLAR**

- STF - Fascette a vite Hose clamps with screw (pag. 204-207)
- STC - Fascette con bullone Hose clamps with bolt (pag. 208-210)
- SSS - Fascetta salta spirale Spiral pipe clamp (pag. 219)



**NORME NORMS:**  
ISO 1307

**COMPRESSIBILITÀ ASSIALE AXIAL COMPRESSIBILITY:**  
8:1

**-40°C / +90°C**  
**-40°F / +194°F**

\* CONTATTO RIPETUTO MASSIMO DI 2 ORE ALLA TEMPERATURA MASSIMA DI 70°C MAX 70°C FOR 2 HOURS



PVC



- **Idoneo al contatto di alimenti per i quali sono previsti isumulanti A, B, C D2 e E\*.**  
**Suitable for the contac with food with the presence of A-B-C-D2 and E simulants.**



**IMPIEGO  
APPLICATIONS**

Idoneo all'aspirazione di polveri abrasive in genere. Idoneo al contatto con alimenti acquosi, acidi ed alcolici (fino al 20%), oleosi e/o grassi e secchi per i quali sono previsti i simulanti A, B, C, D2 ed E\*. Particolarmente indicato nelle carrozzerie, nell'industria del legno, ceramica e farmaceutica.

Suitable for suction of abrasive dust and for contact with food with a presence of oils and fats according to EU Regulation 10/2011 simulants A, B, C, D2 and E\*. Product recommended in panel beaters, wood industry, ceramic industry and in pharmaceutical industry.



**STRUTTURA  
BODY**

<b>A</b>	<b>Materiale Material</b>	Poliuretano. Polyurethane.
<b>B</b>	<b>Inserti Reinforcement</b>	Spirale di acciaio armonico ramato. Built-in steel spiral.
<b>C</b>	<b>Copertura Cover</b>	Corrugata. Outside corrugated.
	<b>Superficie Surface</b>	Trasparente con spirale ramata. Transparent, copper plated steel spiral.



**FASCETTE E COLLARI STRINGITUBO CONSIGLIATE  
RECOMMENDED CLAMP/COLLAR**

- STF - Fascette a vite Hose clamps with screw (pag. 204-207)
- STC - Fascette con bullone Hose clamps with bolt (pag. 208-210)
- SSS - Fascetta salta spirale Spiral piepe clamp (pag. 219)



\* CONTATTO RIPETUTO MASSIMO DI 2 ORE ALLA TEMPERATURA MASSIMA DI 70°C MAX 70°C FOR 2 HOURS

mm	mm	bar	bar	bar	gr/mt	mm	m
25	-	1	-	0,3	110	25	20
30	-	1	-	0,3	125	30	20
32	-	1	-	0,3	130	32	20
35	-	1	-	0,3	140	35	20
38	-	1	-	0,3	145	38	20
40	-	1	-	0,3	150	40	20
45	-	1	-	0,3	200	45	20
50	-	1	-	0,3	210	50	20
51	-	1	-	0,3	220	51	20
55	-	1	-	0,3	240	55	20
60	-	1	-	0,3	250	60	20
63	-	1	-	0,3	260	63	20
65	-	1	-	0,3	270	65	20
70	-	1	-	0,3	320	70	20
75	-	1	-	0,25	350	75	20
76	-	1	-	0,25	370	76	20
80	-	1	-	0,25	420	80	20
90	-	1	-	0,25	450	90	20
100	-	1	-	0,25	490	100	20
110	-	1	-	0,25	550	110	20
120	-	1	-	0,25	600	120	20
127	-	0,5	-	0,25	600	127	20
130	-	0,5	-	0,12	640	130	20
140	-	0,5	-	0,12	680	140	20
152	-	0,5	-	0,12	860	152	20
160	-	0,5	-	0,1	900	160	20
180	-	0,5	-	0,05	920	180	20
203	-	0,5	-	0,05	1020	203	20
254	-	0,5	-	0,03	1300	254	10
305	-	0,5	-	0,03	1500	305	10
355	-	0,5	-	0,02	1650	355	10



**NORME NORMS:**  
 REG. UE 10/2011 - ISO 1307  
**COMPRIMIBILITÀ ASSIALE AXIAL COMPRIMIBILITY:**  
 8:1  
**DICHIARAZIONE DI CONFORMITÀ DISPONIBILE**  
 DECLARATION OF COMPLIANCE IS AVAILABLE



**-40°C / +90°C**  
**-40°F / +194°F**

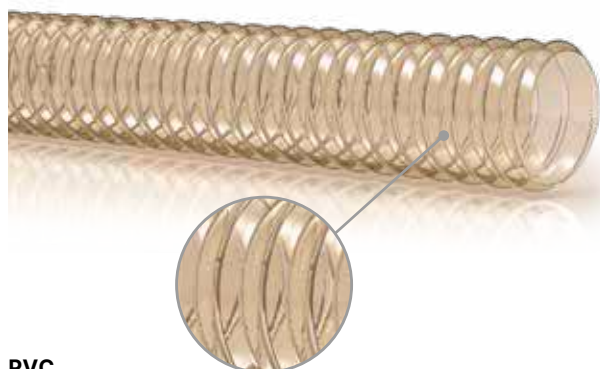

PVC



- **Idoneo al contatto di alimenti per i quali sono previsti isimulanti A, B, C D2 e E\*.**  
Suitable for the contact with food with the presence of A-B-C-D2 and E simulants.

**IMPIEGO APPLICATIONS**

Idoneo all'aspirazione di polveri abrasive in genere. Idoneo al contatto con alimenti acquosi, acidi ed alcolici (fino al 20%), oleosi e/o grassi e secchi per i quali sono previsti i simulanti A, B, C, D2 ed E\*. Particolarmente indicato nelle carrozzerie, nell'industria del legno, ceramica e farmaceutica.

Suitable for suction of abrasive dust and for contact with food with a presence of oils and fats according to EU Regulation 10/2011 simulants A, B, C, D2 and E\*. Product recommended in panel beaters, wood industry, ceramic industry and in pharmaceutical industry.



**STRUTTURA BODY**

<b>A</b>	<b>Materiale Material</b>	Poliuretano. Polyurethane.
<b>B</b>	<b>Inserti Reinforcement</b>	Spirale di acciaio armonico ramato e parete rinforzata. Galvanized steel copper spiral wire.
<b>C</b>	<b>Copertura Cover</b>	Corrugata. Outside corrugated.
	<b>Superficie Surface</b>	Trasparente con spirale ramata. Transparent, copper plated steel spiral.

mm	mm	bar	bar	bar	gr/mt	mm	m
25	-	1	-	0,3	180	25	20
30	-	1	-	0,3	200	30	20
32	-	1	-	0,3	240	32	20
38	-	1	-	0,3	250	38	20
40	-	1	-	0,3	270	40	20
45	-	1	-	0,3	280	45	20
50	-	1	-	0,3	330	50	20
60	-	1	-	0,3	440	60	20
63	-	1	-	0,3	460	63	20
70	-	1	-	0,25	490	70	20
75	-	1	-	0,25	530	75	20
80	-	1	-	0,25	500	80	20
90	-	1	-	0,25	680	90	20
100	-	1	-	0,25	700	100	20
110	-	1	-	0,25	720	110	20
120	-	1	-	0,25	1000	120	20
127	-	0,5	-	0,25	1100	127	20
130	-	0,5	-	0,12	1100	130	20
140	-	0,5	-	0,12	1150	140	20
152	-	0,5	-	0,12	1250	152	20
160	-	0,5	-	0,1	1280	160	20
180	-	0,5	-	0,05	1350	180	20
203	-	0,5	-	0,05	1500	203	20
254	-	0,5	-	0,03	2300	254	10
305	-	0,5	-	0,03	3200	305	10

**FASCETTE E COLLARI STRINGITUBO CONSIGLIATE RECOMMENDED CLAMP/COLLAR**

- STF - Fascette a vite Hose clamps with screw (pag. 204-207)
- STC - Fascette con bullone Hose clamps with bolt (pag. 208-210)
- SSS - Fascetta salta spirale Spiral pipe clamp (pag. 219)



\* CONTATTO RIPETUTO MASSIMO DI 2 ORE ALLA TEMPERATURA MASSIMA DI 70°C MAX 70°C FOR 2 HOURS

**NORME NORMS:**  
ISO 1307

**COMPRESSIBILITÀ ASSIALE AXIAL COMPRIMIBILITY:**  
8:1

**DICHIARAZIONE DI CONFORMITÀ DISPONIBILE**  
DECLARATION OF COMPLIANCE IS AVAILABLE

**-40°C / +90°C**  
**-40°F / +194°F**

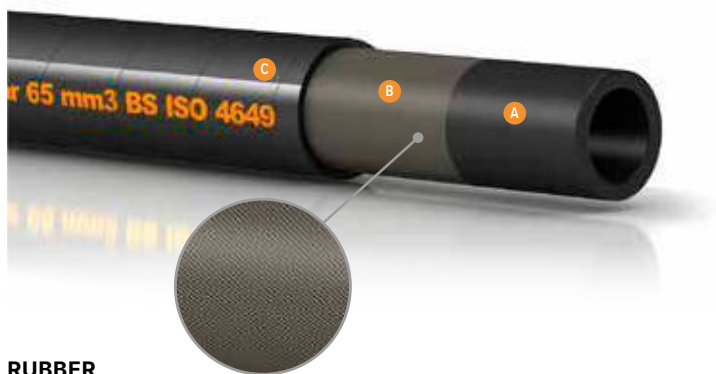

**RUBBER**



- **Ideale per impianti di sabbiatura.**  
Suitable for sandblast plants.



**IMPIEGO  
APPLICATIONS**









Per mandata di sabbia silicea, graniglia metallica e materiali altamente abrasivi o taglienti. Particolarmente utilizzato negli impianti di sabbiatura.

For silica sand, blasting metal, stone and concrete surfaces. Particularly used for sandblast plants.



**STRUTTURA  
BODY**

<b>A</b>	<b>Sottostrato Tube</b>	Gomma NR antiabrasiva antistatica di colore nero. Abrasion resistant, antistatic natural rubber.
<b>B</b>	<b>Inserti Reinforcement</b>	Tessili sintetici. High tensile synthetic textile.
<b>C</b>	<b>Copertura Cover</b>	Gomma NR di colore nero antistatica resistente all'abrasione, agli agenti atmosferici ed all'invecchiamento. Abrasion, ozone and weather resistant pin-pricked natural and synthetic antistatic rubber.
	<b>Superficie Surface</b>	Liscia ad impressione tela. Smooth with fabric impression.

 mm	 mm	 bar	 bar	 bar	 gr/mt	 mm	 m
10	21	12	36	-	321	110	40
13	21	12	36	-	256	117	40
13	25	12	36	-	434	127	40
16	30	12	36	-	583	160	40
19	34	12	36	-	696	190	40
25	40	12	36	-	837	254	40
30	45	12	36	-	987	300	40
32	48	12	36	-	1138	320	40
35	54	12	36	-	1507	350	40
40	60	12	36	-	1803	400	40
50	72	12	36	-	2347	508	40
60	82	12	36	-	2816	600	40
80	105	12	36	-	4247	800	40
90	115	12	36	-	4650	900	20-40
100	126	12	36	-	4650	1000	20-40



**NORME NORMS:**  
ISO 1307 - BS ISO 4649  
**MARCATURA MARKING:**  
EUROCORD® SABBIA HD WP 12 BAR 65 MM³ BS  
ISO 4649  
**CONFEZIONAMENTO BOX:**  
IMBALLO IN POLIETILENE NERO  
PACKAGING IN BLACK POLYETHYLENE



**-40°C / +70°C**  
**-40°F / +158°F**

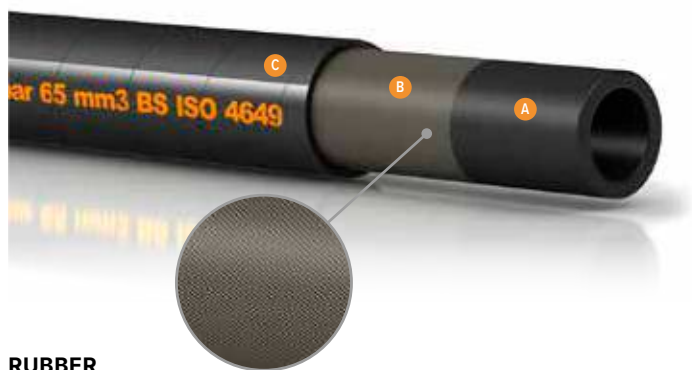

**RUBBER**



- **Ideale per impianti di sabbiatura.**  
Suitable for sandblast plants.

**IMPIEGO APPLICATIONS**

Per mandata di sabbia silicea, graniglia metallica e materiali altamente abrasivi o taglienti. Particolarmente utilizzato negli impianti di sabbiatura.

For silica sand, blasting metal, stone and concrete surfaces. Particularly used for sandblast plants.



**STRUTTURA BODY**

<b>A</b>	<b>Sottostrato Tube</b>	Gomma NR antiabrasiva antistatica di colore nero. Abrasion resistant, antistatic natural rubber.
<b>B</b>	<b>Inserti Reinforcement</b>	Tessili sintetici. High tensile synthetic textile.
<b>C</b>	<b>Copertura Cover</b>	Gomma NR di colore nero antistatica resistente all'abrasione, agli agenti atmosferici ed all'invecchiamento. Abrasion, ozone and weather resistant pin-pricked natural and synthetic antistatic rubber.
	<b>Superficie Surface</b>	Liscia ad impressione tela. Smooth with fabric impression.

mm	mm	bar	bar	bar	gr/mt	mm	m
13	25	18	60	-	434	127	40
16	30	18	60	-	583	160	40
19	34	18	60	-	696	190	40
25	40	18	60	-	837	254	40
30	45	18	60	-	987	300	40
32	48	18	60	-	1138	320	40
35	54	18	60	-	1507	350	40
40	60	18	60	-	1803	400	40
50	70	18	60	-	2347	508	40
60	82	18	60	-	2816	600	40
80	105	18	60	-	4247	800	40



**NORME NORMS:**  
ISO 1307 - BS ISO 4649  
**MARCATURA MARKING:**  
EUROCORD® SABBIA HD WP 18 BAR 65 MM³ BS ISO 4649  
**CONFEZIONAMENTO BOX:**  
IMBALLO IN POLIETILENE NERO  
PACKAGING IN BLACK POLYETHYLENE



**-40°C / +70°C**  
**-40°F / +158°F**



**RUBBER**



**IMPIEGO  
APPLICATIONS**

Idoneo al trasporto a bassa pressione di prodotti abrasivi e fluidi in genere, in particolare betoncino, intonaco, gesso, ghiaia e malta.

Suitable for the low pressure transport of abrasive products and fluids in general. In particular for spraying plaster, grout, sand, sypsum, ready mixed concrete.



**STRUTTURA  
BODY**









<b>A</b>	<b>Sottostrato Tube</b>	Liscio in gomma nera antiabrasiva (NR/SBR). Abrasion resistant, antistatic natural rubber.
<b>B</b>	<b>Inserti Reinforcement</b>	Tessili sintetici ad alta tenacità. High tensile synthetic textile.
<b>C</b>	<b>Copertura Cover</b>	Gomma nera antiabrasiva (NR/SBR) resistente agli agenti atmosferici. Abrasion, ozone and weather resistant pin-pricked natural and synthetic rubber.
	<b>Superficie Surface</b>	Liscia ad impressione tela. Smooth with fabric impression.



**FASCETTE E COLLARI STRINGITUBO CONSIGLIATE  
RECOMMENDED CLAMP/COLLAR**

STC - Fascette con bullone Hose clamps with bolt (pag. 208-210)



 mm	 mm	 bar	 bar	 bar	 gr/mt	 mm	 m
51	68	12	36	-	1968	508	40
50	70	12	36	-	2271	508	40
50	74	12	36	-	2800	508	40
60	80	12	36	-	2659	600	40
60	82	12	36	-	2720	600	40
63	84	12	36	-	2790	630	40
65*	84	12	36	-	2820	650	40
65*	85	12	36	-	2841	650	40



**NORME NORMS:**  
ISO 1307  
**MARCATURA MARKING:**  
EUROCORD® ABRABETON W.P. 12 BAR  
**CONFEZIONAMENTO BOX:**  
IMBALLO IN POLIETILENE TRASPARENTE  
PACKAGING IN TRANSPARENT POLYETHYLENE



**-40°C / +70°C  
-40°F / +158°F**

\* VERSIONE 4 TELE 4 PLYES VERSION





**RUBBER**

**IMPIEGO APPLICATIONS**

Idoneo al trasporto a bassa pressione di prodotti abrasivi e fluidi in genere, in particolare betoncino, intonaco, gesso, ghiaia e malta.

Suitable for the low pressure transport of abrasive products and fluids in general. In particular for spraying plaster, grout, sand, sypsum, ready mixed concrete.



**STRUTTURA BODY**

<b>A</b>	<b>Sottostrato Tube</b>	Liscio in gomma nera antiabrasiva (NR/SBR). Abrasion resistant, antistatic natural rubber.
<b>B</b>	<b>Inserti Reinforcement</b>	Tessili sintetici ad alta tenacità. High tensile synthetic textile.
<b>C</b>	<b>Copertura Cover</b>	Gomma nera antiabrasiva (NR/SBR) resistente agli agenti atmosferici. Abrasion, ozone and weather resistant pin-pricked natural and synthetic rubber.
	<b>Superficie Surface</b>	Liscia ad impressione tela. Smooth with fabric impression.

mm	mm	bar	bar	bar	gr/mt	mm	m
20	31	40	120	-	360	200	40
25	37	40	120	-	683	254	40-61
30	42	40	120	-	930	300	40
30	45	40	120	-	1046	300	40
35	48	40	120	-	1136	350	40
40	55	40	120	-	1370	400	40
50	66	40	120	-	1746	508	40
50	68	40	120	-	1968	508	40
50	70	40	120	-	2271	508	40
50	74	40	120	-	2800	508	40

**FASCETTE E COLLARI STRINGITUBO CONSIGLIATE RECOMMENDED CLAMP/COLLAR**

STC - Fascette con bullone Hose clamps with bolt (pag. 208-210)



**NORME NORMS:**  
ISO 1307  
**MARCATURA MARKING:**  
EUROCORD® ABRABETON W.P. 40 BAR  
**CONFEZIONAMENTO BOX:**  
IMBALLO IN POLIETILENE TRASPARENTE  
PACKAGING IN TRANSPARENT POLYETHYLENE



**-40°C / +70°C**  
**-40°F / +158°F**

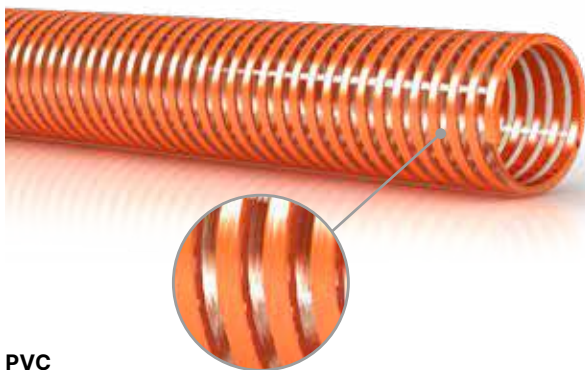

PVC



- **Ottima resistenza a liquidi e fanghi abrasivi.**  
Excellent resistance in abrasive applications.



### IMPIEGO APPLICATIONS

Sottotrato in poliuretano studiato appositamente per aspirazione e mandata di liquidi e fanghi abrasivi. Particolarmente indicato a corredo di silos o pompe di aspirazione nei cantieri e nelle cave.

For heavy-duty suction and delivery of water, slurries, dust and gravel, etc. In industrial and constructions.



### STRUTTURA BODY

<b>A</b>	<b>Materiale Material</b>	PVC/PU. Strong, flexible plasticized PVC with antiabrasive polyurethane inside layer.
<b>B</b>	<b>Inserti Reinforcement</b>	Spirale in PVC. Shock resistant PVC spiral.
<b>C</b>	<b>Copertura Cover</b>	In PVC/PU, resistente agli urti, ad agenti chimici, all'abrasione e agli agenti atmosferici. Leggermente corrugato. Crushing, chemical agents, abrasion and weather resistant, light corrugated outside.
	<b>Superficie Surface</b>	Liscia arancione trasparente. Transparent.



### FASCETTE E COLLARI STRINGITUBO CONSIGLIATE RECOMMENDED CLAMP/COLLAR

STC - Fascette con bullone Hose clamps with bolt (pag. 208-210)  
BANDI BLOCK - Coppia di serraggio Tightening torque (pag. 221)



mm	mm	bar	bar	bar	gr/mt	mm	m
25	32,8	-	6,5	0,8	270	100	25
30	37,6	-	6,0	0,8	360	120	25
32	40,7	-	6,0	0,8	380	128	25
35	44,1	-	5,5	0,8	400	140	25
38	47,1	-	5,0	0,8	430	152	25
40	49,5	-	5,0	0,8	480	160	25
45	55,5	-	5,0	0,8	550	180	25
50	60,5	-	4,5	0,8	600	200	25
60	71,3	-	4,0	0,8	800	240	20
63	74,3	-	4,0	0,8	850	252	20
70	80,0	-	4,0	0,8	1000	280	20
76	88,5	-	4,0	0,8	1100	304	20
80	93,5	-	4,0	0,8	1260	320	20
90	103,7	-	3,0	0,8	1400	360	20
100	114,9	-	3,0	0,8	1600	400	20
120	135,3	-	2,0	0,7	2500	480	20
127	144,7	-	2,0	0,7	2700	508	20
150	168,1	-	1,0	0,6	3400	600	20



NORME NORMS:  
ISO 1307



-5°C / +60°C  
+23°F / +140°F

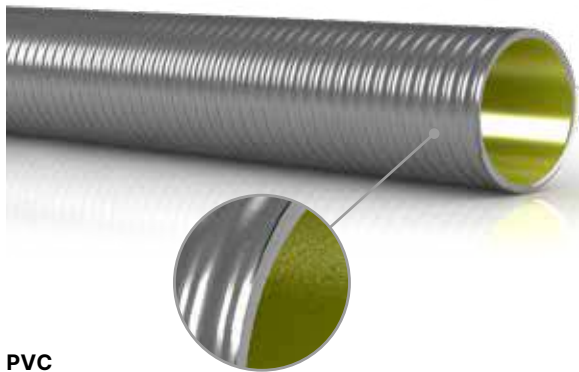

PVC



- **Struttura rinforzata per usi gravosi.**  
Reinforced structure for heavy uses.



**IMPIEGO**  
**APPLICATIONS**









Studiato appositamente per il passaggio di materiale fortemente abrasivo, particolarmente indicato come parte terminale del tubo per calcestruzzo. Ottima resistenza alle escursioni termiche.

For heavy-duty suction and delivery of water, slurries, dust and gravel, etc. in industrial and constructions. Excellent resistance in abrasive applications.



**STRUTTURA**  
**BODY**

<b>A</b>	<b>Materiale Material</b>	PVC flessibile con sottostrato in PU-poliuretano. Strong, flexible plasticized PVC with antiabrasive polyurethane inside layer.
<b>B</b>	<b>Inserti Reinforcement</b>	Spirale in PVC antiurto. Shock resistant PVC spiral.
<b>C</b>	<b>Copertura Cover</b>	In PVC resistente all'abrasione, agenti atmosferici ed ozono. Crushing, chemical agents, abrasion and weather resistant, light corrugated outside.
	<b>Superficie Surface</b>	Leggermente corrugata grigio metallico, interno giallo. Metallic grey, inner yellow.

							
mm	mm	bar	bar	bar	gr/mt	mm	m
25	4,2	20	-	0,9	500	162	50
32	4,6	17	-	0,9	600	208	50
38	5,0	16	-	0,9	700	247	50
40	5,0	16	-	0,9	770	275	50
45	5,0	15	-	0,9	950	300	50
50	5,2	15	-	0,9	1050	330	50
55	5,3	15	-	0,9	1200	357	50
60	5,3	15	-	0,9	1300	400	50
63	5,6	14	-	0,9	1400	409	50
65	5,7	14	-	0,9	1450	422	50
70	5,7	13	-	0,9	1550	455	50
75	6,0	13	-	0,9	1750	495	50
80	6,2	13	-	0,9	1950	540	50
90	6,2	12	-	0,9	2150	585	25
100	6,3	12	-	0,9	2700	700	25
110	6,9	11	-	0,9	3000	770	25
120	7,3	10	-	0,9	3300	880	25
125	7,8	10	-	0,9	3600	970	25
150	8,8	10	-	0,8	5200	1210	25
160	9,2	9	-	0,7	5650	1280	25
200	10,5	8	-	0,7	8000	1600	25



**FASCETTE E COLLARI STRINGITUBO CONSIGLIATE**  
**RECOMMENDED CLAMP/COLLAR**

STC - Fascette con bullone Hose clamps with bolt (pag. 208-210)



NORME NORMS:  
ISO 1307



-5°C / +60°C  
+23°F / +140°F



**RUBBER**



**IMPIEGO  
APPLICATIONS**

Per mandata in pressione di cemento in polvere, sabbia umida, malte liquide, calcari polverulenti e in genere prodotti abrasivi di piccola granulometria. Utilizzato per il carico e lo scarico per caduta o per sistema pneumatico di silos di stoccaggio e di autocisterne.

For discharge of dry bulk materials, sand, gravel, dry cement, etc. Particularly used for the loading and unloading of silos and tankers.



**STRUTTURA  
BODY**

<b>A</b> <b>Sottostrato Tube</b>	Liscio in gomma nera antiabrasiva conduttiva R< 5×10 Ω/m. Abrasion resistant, antistatic natural rubber R< 5×10 Ω/m.
<b>B</b> <b>Inseriti Reinforcement</b>	Inserzioni di fibre sintetiche ad alta resistenza. High tensile synthetic textile and antistatic copper wire.
<b>C</b> <b>Copertura Cover</b>	Gomma nera antistatica, resistente all'abrasione ed agli agenti atmosferici. Abrasion, ozone and weather resistant pin-pricked natural and synthetic rubber.
<b>Superficie Surface</b>	Liscia ad impressione tela. Smooth with fabric impression.









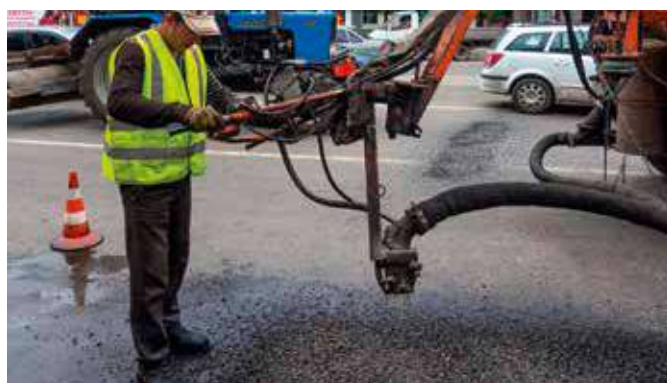

**FASCETTE E COLLARI STRINGITUBO CONSIGLIATE  
RECOMMENDED CLAMP/COLLAR**

STC - Fascette con bullone Hose clamps with bolt (pag. 208-210)



- **Buona resistenza ed ideale per prodotti abrasivi di piccola granulometria.**  
**Great resistance and particularly used for small abrasive products.**



 mm	 mm	 bar	 bar	 bar	 gr/mt	 mm	 m
102	110	10	30	-	1783	-	20
102	118	10	30	-	3288	-	20



**NORME NORMS:**  
ISO 1307  
**MARCATURA MARKING:**  
EUROCORD® CEMENTO HD W.P. 10 BAR  
**CONFEZIONAMENTO BOX:**  
IMBALLO IN POLIETILENE TRASPARENTE  
PACKAGING IN TRANSPARENT POLYETHYLENE



**-40°C / +70°C**  
**-40°F / +158°F**



**RUBBER**



- **Buona resistenza ed ideale per prodotti abrasivi di piccola granulometria.**  
Great resistance and particularly used for small abrasive products.

**IMPIEGO APPLICATIONS**

Per aspirazione e mandata in pressione di cemento in polvere, sabbia umida, malte liquide, calcari polverulenti e in genere prodotti abrasivi di piccola granulometria. Utilizzato per il carico e lo scarico per caduta o per sistema pneumatico di silos di stoccaggio e di autocisterne.

For discharge of dry bulk materials, sand, gravel, dry cement, etc. Particularly used for the loading and unloading of silos and tankers.

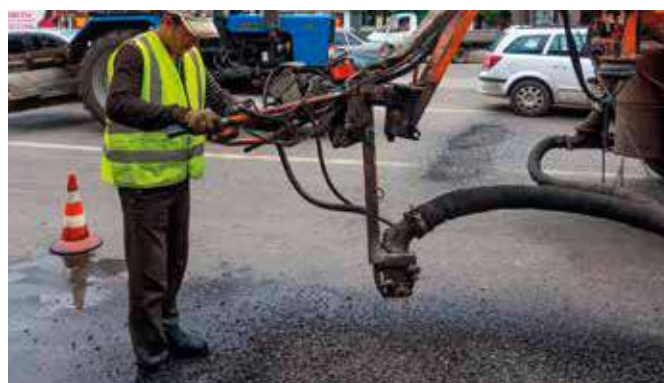

**STRUTTURA BODY**

<b>A</b> Sottostrato Tube	Liscio in gomma nera antiabrasiva conduttiva R< 5×10 Ω/m. Abrasion resistant, antistatic natural rubber R< 5×10 Ω/m.
<b>B</b> Inserti Reinforcement	Inserzioni di fibre sintetiche ad altra resistenza e spirale metallica inserita. High tensile synthetic textile, steel wire helix and antistatic copper wire.
<b>C</b> Copertura Cover	Gomma nera antistatica, resistente all'abrasione ed agli agenti atmosferici. Abrasion, ozone and weather resistant pin-pricked natural and synthetic rubber.
Superficie Surface	Liscia ad impressione tela. Smooth with fabric impression.

mm	mm	bar	bar	bar	gr/mt	mm	m
25	40	10	30	0,8	907	155	40
32	45	10	30	0,8	1076	190	40
38	52	10	30	0,8	1434	230	40
50	66	10	30	0,8	2008	305	40
63	78	10	30	0,8	2442	380	40
76	92	10	30	0,8	3128	460	40
90	107	10	30	0,8	3815	540	40
100	120	10	30	0,8	4608	610	40

**FASCETTE E COLLARI STRINGITUBO CONSIGLIATE RECOMMENDED CLAMP/COLLAR**

STC - Fascette con bullone Hose clamps with bolt (pag. 208-210)



**NORME NORMS:**  
ISO 1307

**MARCATURA MARKING:**  
EUROCORD® CEMENTO SP W.P. 10 BAR

**CONFEZIONAMENTO BOX:**  
IMBALLO IN POLIETILENE TRASPARENTE  
PACKAGING IN TRANSPARENT POLYETHYLENE

**-40°C / +70°C**  
**-40°F / +158°F**

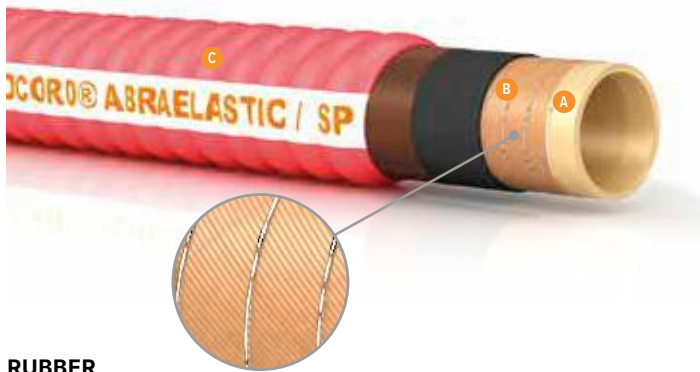

**RUBBER**



**IMPIEGO  
APPLICATIONS**

Tubo studiato per il passaggio di materiali abrasivi. Buona resistenza a tutti i materiali altamente abrasivi tipo graniglia metallica, cemento, cereali, granuli plastici, polveri abrasive. Buona resistenza alle flessioni e sollecitazioni. Ottima resistenza agli agenti atmosferici. Tubo molto leggero ed estremamente flessibile, la particolare struttura permette ridotti raggi di curvatura. Grande elasticità e soprattutto, grazie al sottostrato in gomma naturale, grande resistenza all'abrasione.

Great resistance to banding stress, great resistance to atmospheric agents. Very light and flexible hose, its structure permits low banding radius. Excellent flexibility thanks to its natural rubber inner layer.



**STRUTTURA  
BODY**

<b>A</b> <b>Sottostrato Tube</b>	Gomma para naturale (NR) color nocciola chiaro. Abrasion resistant natural rubber (beige colour).
<b>B</b> <b>Inseriti Reinforcement</b>	Tessili ad alta tenacità e spirale metallica incorporata. High tensile synthetic textile, steel wire helix.
<b>C</b> <b>Copertura Cover</b>	Ondulata in gomma para naturale (NR) colore rosso. Abrasion, ozone and weather resistant corrugated special sythetic rubber.
<b>Superficie Surface</b>	Ondulata, di colore rosso, ad impressione tela. Corrugated, red color, with fabric impression.



**FASCETTE E COLLARI STRINGITUBO CONSIGLIATE  
RECOMMENDED CLAMP/COLLAR**

STC - Fascette con bullone Hose clamps with bolt (pag. 208-210)



- **Buona resistenza ed ideale per prodotti abrasivi di piccola granulometria.**  
Excellent flexibility and lightness.



mm	mm	bar	bar	bar	gr/mt	mm	m
50	63	7	21	0,8	1218	180	40
70	80	5	15	0,8	1750	290	40
76	86	5	15	0,8	1820	310	40
101	114	3	9	0,8	3091	450	40
115	128	3	9	0,8	4060	520	40
120	133	3	9	0,8	4193	510	40
152	167	3	9	0,8	5976	670	40



**NORME NORMS:**  
ISO 1307  
**MARCATURA MARKING:**  
EUROCORD® ABRAELASTIC SP  
**CONFEZIONAMENTO BOX:**  
IMBALLO IN POLIETILENE NERO  
PACKAGING IN BLACK POLYETHYLENE



**-40°C / +70°C**  
**-40°F / +158°F**



**RUBBER**



- **Generalmente fornito con raccordi victaulic.**  
Generally supplied with victaulic fittings.



**IMPIEGO APPLICATIONS**

Idoneo al pompaggio ad alta pressione di calcestruzzo nei punti di colata. Viene generalmente fornito già tagliato nelle pezzature di impiego e con raccordi victaulic.

For high pressure concrete pumping and placing used in the end of boom of concrete pump. Generally supplied already cutted and with victaulic fittings.



**STRUTTURA BODY**

<b>A</b> <b>Sottostrato Tube</b>	Liscio in gomma speciale naturale SBR conduttiva, resiste all'abrasione. Abrasion resistant antistatic natural and SBR rubber.
<b>B</b> <b>Inserti Reinforcement</b>	Cordine d'acciaio ad alta tenacità. High tensile steel cords.
<b>C</b> <b>Copertura Cover</b>	Gomma speciale sintetica microforata resistente agli agenti atmosferici, all'abrasione ed all'ozono. Abrasion, ozone and weather resistant pin-pricked special synthetic rubber.
<b>Superficie Surface</b>	Liscia ad impressione tela. Smooth with fabric impression.

mm	mm	bar	bar	bar	gr/mt	mm	m
50,8	70	85	200	-	3410	508	20
63,5	88	85	200	-	4970	635	20
76,2	102	85	200	-	6581	762	20
101,6	126	85	200	-	9376	1016	20
127	155	85	200	-	10951	1270	20
152,4	184	85	175	-	13494	1524	20



**NORME NORMS:**  
ISO 1307  
**MARCATURA MARKING:**  
EUROCORD® ABRABETON PUMP WP 85 BAR  
**CONFEZIONAMENTO BOX:**  
IMBALLO IN POLIETILENE TRASPARENTE  
PACKAGING IN TRANSPARENT POLYETHYLENE



**-40°C / +70°C**  
**-40°F / +158°F**

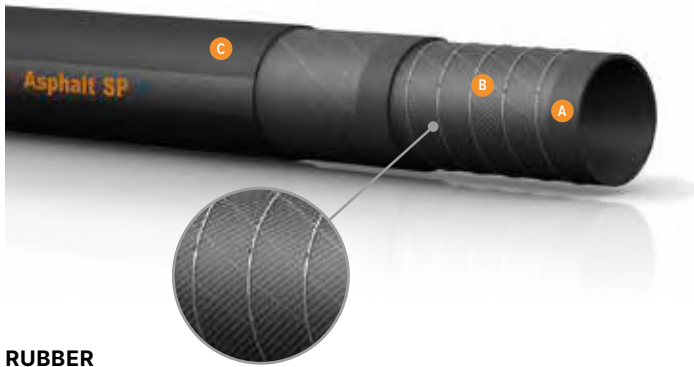

**RUBBER**



- **Per carico e scarico di bitume caldo fino a 180°C.**  
For suction and discharge of hot asphalt up to 180°C.



**IMPIEGO APPLICATIONS**

Per il carico e lo scarico di bitume caldo fino a 180° nei camion, nei vagoni cisterna, nelle costruzioni stradali, etc.

For suction and discharge of tar and hot asphalt on tank trucks & tank cars, etc. in road constructions up to 180°C.

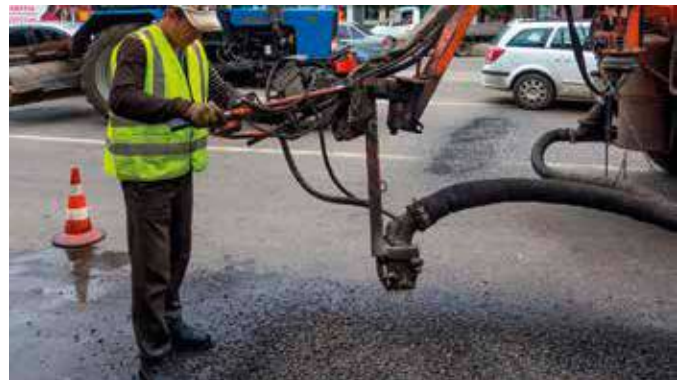

**STRUTTURA BODY**

<b>A</b>	<b>Sottostrato Tube</b>	Gomma speciale sintetica acrilica resistente al calore. Heat resistant, special synthetic acrylic rubber.
<b>B</b>	<b>Inseriti Reinforcement</b>	Inserzioni tessili ad alta tenacità con doppia spirale d'acciaio e cordicella di rame antistatica. High tensile synthetic textile, 2 steel wire helix and antistatic copper wire.
<b>C</b>	<b>Copertura Cover</b>	Gomma speciale sintetica con ottima resistenza al bitume caldo, all'abrasione, agli oli ed agli agenti atmosferici. Abrasion, heat, weather, oil and asphalt resistant special synthetic rubber.
	<b>Superficie Surface</b>	Liscia ad impressione tela. Smooth with fabric impression.



**FASCETTE E COLLARI STRINGITUBO CONSIGLIATE RECOMMENDED CLAMP/COLLAR**

STC - Fascette con bullone Hose clamps with bolt (pag. 208-210)



mm	mm	bar	bar	bar	gr/mt	mm	m
25,4	43	18	54	-0,92	1238	115	40-46-61
32	50	18	54	-0,92	1496	150	40-46-61
38	56	18	54	-0,92	1830	180	40-46-61
44,5	64	18	54	-0,92	2344	220	40-46-61
50,8	71	18	54	-0,92	2776	250	40-46-61
63,5	83	10	30	-0,92	3129	320	40-46-61
70	91	10	30	-0,92	3807	360	40-46-61
76,2	97	10	30	-0,92	4107	400	40-46-61
101,6	126	10	30	-0,92	6168	520	40-46-61
127	153	10	30	-0,92	8152	680	40-46-61
152,4	179	10	30	-0,92	10229	850	40-46-61



**NORME NORMS:**  
ISO 1307  
**MARCATURA MARKING:**  
EUROCORD® ASPHALT SP  
**CONFEZIONAMENTO BOX:**  
IMBALLO IN POLIETILENE NERO  
PACKAGING IN BLACK POLYETHYLENE



**-40°C / +180°C**  
**-40°F / +356°F**





**RUBBER**



- **Gomma speciale resistente all'abrasione.**  
Special abrasive resistant rubber.

**IMPIEGO APPLICATIONS**









Comunemente utilizzato sulle macchine per la pulizia stradale. Il tubo viene prodotto manicottato.

Used on street cleaning machines. Extremely flexible. The hose is produced with cuffs-ends.



**STRUTTURA BODY**

<b>A</b>	<b>Sottostrato Tube</b>	Gomma speciale sintetica, resistente all'abrasione. Abrasion resistant special syntethic rubber.
<b>B</b>	<b>Inserti Reinforcement</b>	Inserti tessili. Special synthetic textile.
<b>C</b>	<b>Copertura Cover</b>	Gomma speciale sintetica, resistente all'abrasione. Abrasion resistant special syntethic rubber.
	<b>Superficie Surface</b>	Ondulata. Corrugated.

 mm	 mm	 bar	 bar	 bar	 gr/mt	 mm	 m
152	162	-	-	-	3450	150	A richiesta On request
203	215	-	-	-	4300	200	A richiesta On request
254	270	-	-	-	5900	250	A richiesta On request

ALTRI DIAMETRI E LUNGHEZZE POSSONO ESSERE PRODOTTI SU RICHIESTA / OTHER MEASURES ON REQUEST

**FASCETTE E COLLARI STRINGITUBO CONSIGLIATE RECOMMENDED CLAMP/COLLAR**

STC - Fascette con bullone Hose clamps with bolt (pag. 208-210)



**NORME NORMS:**  
ISO 1307  
**MARCATURA MARKING:**  
EUROCORD® STREET SWEEPER  
POSSIBILITÀ DI PERSONALIZZAZIONE DELLA MISURA DEL MANICOTTO  
CUSTOMIZABLE CUFF-ENDS LENGHTS



**-25°C / +70°C**  
**-13°F / +158°F**

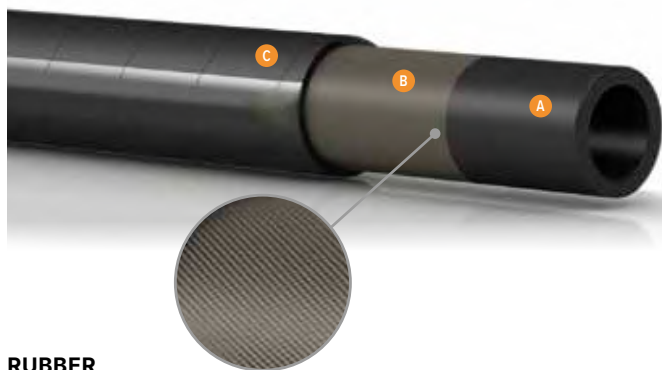

**RUBBER**



- **Idoneo per prodotti abrasivi.**  
Suitable for abrasive products.



**IMPIEGO  
APPLICATIONS**

Per aspirazione e mandata di prodotti abrasivi secchi, studiato per impianti che lavorano in aspirazione, gravità e sistemi pneumatici.

Suitable for abrasive products. Suitable for plants that work in suction, gravity and pneumatic systems.



**STRUTTURA  
BODY**









**A**  
**Sottostrato Tube** Liscio in gomma nera NR antiabrasiva (50 mm<sup>3</sup> DIN 53516), antistatico (R<106 Ω/m).  
Blend of synthetic and natural elastomer, black smooth, high abrasion resistant (50 mm<sup>3</sup> DIN 53516), antistatic (R<106 Ω/m).

**B**  
**Inserti Reinforcement** Tessili sintetici ad alta tenacità.  
High textile syntetic fabric.

**C**  
**Copertura Cover** Gomma nera antiabrasiva (NR/SBR), antistatica, resistente agli agenti atmosferici. Blend of synthetic and natural elastomer, black, smooth with cloth impression, antistatic, abrasion, weather and ozone restistant.

**Superficie Surface** Liscia ad impressione tela.  
Smooth with fabric impression.



 mm	 mm	 bar	 bar	 bar	 gr/mt	 mm	 m
75	93	9	6	18	550	2,95	40
100	132	11	6	18	810	5,47	40



**FASCETTE E COLLARI STRINGITUBO CONSIGLIATE  
RECOMMENDED CLAMP/COLLAR**

STC - Fascette con bullone Hose clamps with bolt (pag. 208-210)



**NORME NORMS:**  
ISO 1307 - DIN 53516

**MARCATURA MARKING:**  
EUROCORD® SILO HD

**CONFEZIONAMENTO BOX:**  
IMBALLO IN POLIETILENE TRASPARENTE  
PACKAGING IN TRANSPARENT POLYETHYLENE



**-30°C / +85°C**  
**-22°F / +185°F**

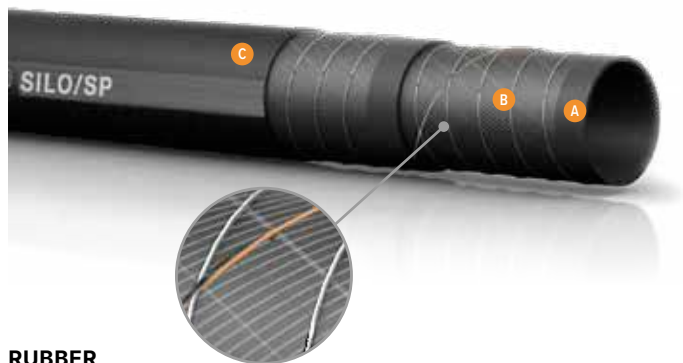

**RUBBER**



- **Idoneo per prodotti abrasivi.**  
Suitable for abrasive products.

**IMPIEGO APPLICATIONS**

Per aspirazione e mandata di prodotti abrasivi secchi, studiato per impianti che lavorano in aspirazione, gravità e sistemi pneumatici.

Suitable for abrasive products. Suitable for plants that work in suction, gravity and pneumatic systems.



**STRUTTURA BODY**

<b>A</b> Sottostrato Tube	Liscio in gomma nera NR antiabrasiva (50 mm <sup>3</sup> DIN 53516), antistatico (R<106 Ω/m). Blend of synthetic and natural elastomer, black smooth, high abrasion resistant (50 mm <sup>3</sup> DIN 53516), antistatic (R<106 Ω/m).
<b>B</b> Inseriti Reinforcement	Tessili sintetici ad alta tenacità, spirale in acciaio, cavo in rame. Textile cord, steel helix, antistatic wire, rubber layer.
<b>C</b> Copertura Cover	Gomma nera antiabrasiva (NR/SBR), antistatica, resistente agli agenti atmosferici. Blend of synthetic and natural elastomer, black, smooth with cloth impression, antistatic, abrasion, weather and ozone resistant.
Superficie Surface	Liscia ad impressione tela. Smooth with fabric impression.

75	93	9	6	18	550	2,95	40
100	132	11	6	18	810	5,47	40

**FASCETTE E COLLARI STRINGITUBO CONSIGLIATE RECOMMENDED CLAMP/COLLAR**

STC - Fascette con bullone Hose clamps with bolt (pag. 208-210)



**NORME NORMS:**  
ISO 1307 - DIN 53516  
**MARCATURA MARKING:**  
EUROCORD® SILO SP  
**CONFEZIONAMENTO BOX:**  
IMBALLO IN POLIETILENE TRASPARENTE  
PACKAGING IN TRANSPARENT POLYETHYLENE



**-30°C / +85°C**  
**-22°F / +185°F**



**RUBBER**



- **Raggi di curvatura eccezionalmente stretti.**  
Exceptionally tight banding radiuses.



**IMPIEGO APPLICATIONS**

Per aspirazione di aria e fumi industriali. Particolarmente indicato dove vengono richiesti ridotti raggi di curvatura, leggerezza e flessibilità. Trova ampia applicazione negli impianti di aspirazione industriale.

Particularly used where small banding radius, flexibility and lightness are requested. It can be used on industrial suction plants.



**STRUTTURA BODY**









<b>A</b>	<b>Sottostrato Tube</b>	Liscio in gomma nera EPDM. Natural and synthetic rubber.
<b>B</b>	<b>Inserti Reinforcement</b>	Tessili sintetici ad alta tenacità e spirale metallica incorporata. Synthetic textile and steel helix wire.
<b>C</b>	<b>Copertura Cover</b>	Gomma nera EPDM resistente agli agenti atmosferici, ozono e abrasione. Abrasion, ozone, weather and heat resistant synthetic rubbercorrugated.
	<b>Superficie Surface</b>	Ondulata ad impressione tela. Corrugated with fabric impression.



**FASCETTE E COLLARI STRINGITUBO CONSIGLIATE RECOMMENDED CLAMP/COLLAR**

STC - Fascette con bullone Hose clamps with bolt (pag. 208-210)



 mm	 mm	 bar	 bar	 bar	 gr/mt	 mm	 m
30	3,5	-	-	0,6	-	120	40
32	3,5	-	-	0,6	-	130	40
35	3,5	-	-	0,6	-	140	40
38	3,5	-	-	0,6	-	150	40
40	3,5	-	-	0,6	-	160	40
45	3,5	-	-	0,6	-	180	40
50	3,5	-	-	0,6	-	200	40
60	3,5	-	-	0,6	-	240	40
70	3,5	-	-	0,6	-	280	40
75	3,5	-	-	0,6	-	300	40
80	3,5	-	-	0,6	-	320	40
90	3,5	-	-	0,6	-	360	40
102	3,5	-	-	0,6	-	400	40



**NORME NORMS:**  
ISO 1307  
**MARCATURA MARKING:**  
EUROCORD® SILO HD  
**CONFEZIONAMENTO BOX:**  
IMBALLO IN POLIETILENE NERO  
PACKAGING IN BLACK POLYETHYLENE



**-20°C / +70°C**  
**- 4°F / +158°F**

# FLOSTER PARA / HD

## PARA LIGHT BROWN NATURAL RUBBER



- 
**Ottimo allungamento.**  
Great elongation.

**RUBBER**

**IMPIEGO APPLICATIONS**







Manichetta in gomma utilizzata per convogliare il materiale sfuso all'uscita della tramoggia (sabbia, cemento, ghiaia, cereali).

Discharge of abrasive materials, such as sand, gravel, cement, grain and powder without pressure.



**STRUTTURA BODY**

<b>A</b>	<b>Materiale Material</b>	Tubo prodotto su mandrino in solgomma monostrato di colore nocciola chiaro in gomma NR (Natural Rubber). Abrasion resistant beige natural rubber.
<b>B</b>	<b>Inserti Reinforcement</b>	---
	<b>Superficie Surface</b>	Liscia ad impressione tela. Smooth with fabric impression.
	<b>Durezza Hardness</b>	45 shore a ± 5
	<b>Carico di rottura Breaking strenght</b>	150 kg/cm <sup>2</sup>
	<b>Allungamento a rottura Breaking elongation</b>	500%

 mm	 mm	 bar	 gr/mt	 mm	 m
50 × 58	4	-	0,71	-	12
60 × 68	4	-	0,84	-	12
70 × 78	4	-	0,98	-	12
76 × 84	4	-	1,05	-	12
80 × 88	4	-	1,10	-	12
90 × 98	4	-	0,90	-	12
102 × 110	4	-	1,33	-	12
114 × 122	4	-	1,48	-	12
120 × 128	4	-	1,57	-	12
130 × 138	4	-	1,69	-	12
140 × 148	4	-	1,82	-	12
152 × 160	4	-	1,96	-	12
168 × 176	4	-	2,16	-	12
193 × 201	4	-	2,48	-	9
200 × 208	4	-	2,56	-	12
220 × 228	4	-	2,81	-	6
254 × 262	4	-	3,24	-	12
273 × 281	4	-	3,47	-	10
305 × 313	4	-	3,90	-	12
323 × 331	4	-	4,14	-	6
350 × 358	4	-	4,45	-	6
400 × 408	4	-	5,10	-	7
500 × 508	4	-	6,19	-	6
612 × 620	4	-	7,80	-	6

**FASCETTE E COLLARI STRINGITUBO CONSIGLIATE RECOMMENDED CLAMP/COLLAR**

STC - Fascette con bullone Hose clamps with bolt (pag. 208-210)



 **NORME NORMS:**  
ISO 1307

**CONFEZIONAMENTO BOX:**  
ROTOLI TAGLIATI A MISURA  
ROLLS CUT TO SIZE

 **-40°C / +70°C**  
**-40°F / +158°F**



### RUBBER



#### IMPIEGO APPLICATIONS

Utilizzata comunemente come rivestimento di tamburi metallici nel settore dei nastri trasportatori, o come protezione di superfici metalliche. Particolarmente indicata per offrire una discreta resistenza all'abrasione ed alla lacerazione, discrete caratteristiche fisico meccaniche.

Commonly used as a coating on metal drums in the conveyor belt sector or to protect metal surfaces. In particular, it is indicated to offer fair resistance against abrasion and laceration. It has fair physical and mechanical characteristics.



#### STRUTTURA BODY

**A**  
**Materiale Material** Tubo prodotto su mandrino bistrato; Sottostrato in gomma naturale (NR) copertura in gomma BR/EPDM di colore nero.  
Abrasion resistant 2 tone natural rubber light brown inside black outside.

**B**  
**Inserti Reinforcement** ---

**Superficie Surface** Liscia ad impressione tela.  
Smooth with fabric impression.

**Colore Color** Interno nocciola chiaro, esterno nero.  
Light hazelnut interior, black exterior.

**Durezza Hardness** 45 shore a ± 5

**Carico di rottura Breaking strenght** 150 kg/cm<sup>2</sup>

**Allungamento a rottura Breaking elongation** 400%









#### FASCETTE E COLLARI STRINGITUBO CONSIGLIATE RECOMMENDED CLAMP/COLLAR

STC - Fascette con bullone Hose clamps with bolt (pag. 208-210)



- Copertura particolarmente resistente ad agenti atmosferici.  
Wear resistant cover.



 mm	 mm	 bar	 gr/mt	 mm	 m
50 × 58	4	-	0,75	-	12
60 × 68	4	-	0,88	-	12
70 × 78	4	-	1,02	-	12
76 × 84	4	-	1,07	-	12
80 × 88	4	-	1,16	-	12
90 × 98	4	-	1,27	-	12
102 × 110	4	-	1,44	-	12
114 × 122	4	-	1,60	-	12
120 × 128	4	-	1,68	-	12
130 × 138	4	-	1,83	-	12
140 × 148	4	-	1,95	-	12
152 × 160	4	-	2,11	-	12
168 × 176	4	-	2,32	-	12
193 × 201	4	-	2,68	-	9
200 × 208	4	-	2,76	-	12
220 × 228	4	-	3,03	-	6
254 × 262	4	-	3,50	-	12
273 × 281	4	-	3,74	-	10
305 × 313	4	-	4,20	-	12
323 × 331	4	-	4,42	-	6
350 × 358	4	-	4,81	-	6
400 × 408	4	-	5,52	-	7
500 × 508	4	-	6,81	-	6
612 × 620	4	-	8,50	-	6



**NORME NORMS:**  
ISO 1307  
**CONFEZIONAMENTO BOX:**  
ROTOLI TAGLIATI A MISURA  
ROLLS CUT TO SIZE



**-40°C / +70°C**  
**-40°F / +158°F**

# TUBI PER GAS E SALDATURA

GAS AND HOSES



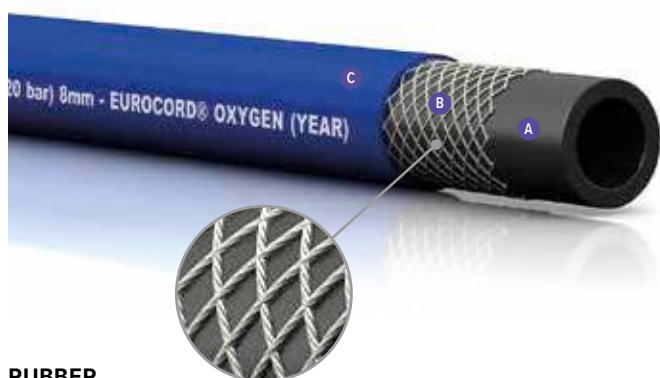

RUBBER



- **Massima leggerezza e flessibilità.**  
Maximum lightness and flexibility.
- **Conforme alla normativa europea EN ISO 3821.**  
EN ISO 3821 approved.



### IMPIEGO APPLICATIONS

Per conduzione di ossigeno negli apparecchi di saldatura ove siano richieste caratteristiche di leggerezza e flessibilità. Il tubo è corrispondente alla normativa europea EN ISO 3821.

For oxigen conduction on soldering equipments where lightness and flexibility are requested. The hose is EN ISO 3821 approved.



### STRUTTURA BODY

<b>A</b>	<b>Sottostrato Tube</b>	Liscio in gomma sintetica di colore nero. Black smooth synthetic rubber.
<b>B</b>	<b>Inserti Reinforcement</b>	Tessili sintetici. High tensile synthetic textile.
<b>C</b>	<b>Copertura Cover</b>	Gomma sintetica di colore blu resistente all'abrasione e agli agenti atmosferici. Abrasion, weather and flame resistant special blue synthetic rubber.
	<b>Superficie Surface</b>	Liscia. Smooth.

mm	mm	bar	bar	bar	gr/mt	mm	m
5	10,5	20	60	-	110	50	100
6	13	20	60	-	140	60	100
8	15	20	60	-	180	80	100
8	16	20	60	-	190	80	100
8	17	20	60	-	270	80	100
10	17	20	60	-	240	100	100



### FASCETTE E COLLARI STRINGITUBO CONSIGLIATE RECOMMENDED CLAMP/COLLAR

STF - Fascette a vite Hose clamps with screw (pag. 204-207)  
SGT - Fascette pinzabili Stepp less (pag. 216)



**NORME NORMS:**  
ISO 1307 - UNI EN 559 DIN EN ISO 3821  
**MARCATURA MARKING:**  
ISO 3821 - 2 MPA (20 BAR) - (DIAM) - EUROCORD®  
OXYGEN (YEAR)  
**CONFEZIONAMENTO BOX:**  
IMBALLO IN POLIETILENE TRASPARENTE  
PACKAGING IN TRANSPARENT POLYETHYLENE



**-30°C / +80°C**  
**-22°F / +176°F**



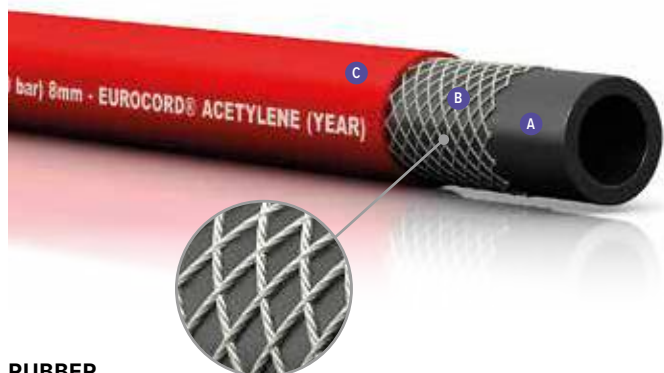

RUBBER



- **Massima leggerezza e flessibilità.**  
Maximum lightness and flexibility.
- **Conforme alla normativa europea EN ISO 3821.**  
EN ISO 3821 approved.

**IMPIEGO**  
APPLICATIONS

Per conduzione di ossigeno negli apparecchi di saldatura ove siano richieste caratteristiche di leggerezza e flessibilità. Il tubo è corrispondente alla normativa europea EN ISO 3821.

For oxigen conduction on soldering equipments where lightness and flexibility are requested. The hose is EN ISO 3821 approved.



**STRUTTURA**  
BODY

<b>A</b>	<b>Sottostrato Tube</b>	Liscio in gomma sintetica di colore nero. Black smooth synthetic rubber.
<b>B</b>	<b>Inserti Reinforcement</b>	Tessili sintetici. High tensile synthetic textile.
<b>C</b>	<b>Copertura Cover</b>	Gomma sintetica di colore rosso resistente all'abrasione e agli agenti atmosferici. Abrasion, weather and flame resistant special red synthetic rubber.
	<b>Superficie Surface</b>	Liscia. Smooth.

mm	mm	bar	bar	bar	gr/mt	mm	m
5	10,5	20	60	-	110	50	100
6	13	20	60	-	140	60	100
8	15	20	60	-	180	80	100
8	16	20	60	-	190	80	100
8	17	20	60	-	270	80	100
10	17	20	60	-	240	100	100

**FASCETTE E COLLARI STRINGITUBO CONSIGLIATE**  
RECOMMENDED CLAMP/COLLAR

STF - Fascette a vite Hose clamps with screw (pag. 204-207)

SGT - Fascette pinzabili Stepp less (pag. 216)



**NORME NORMS:**  
ISO 1307 - UNI EN 559 - DIN EN ISO 3821

**MARCATURA MARKING:**  
ISO 3821 - 2 MPA (20 BAR) - (DIAM) - EUROCORD®  
ACETYLENE (YEAR)

**CONFEZIONAMENTO BOX:**  
IMBALLO IN POLIETILENE TRASPARENTE  
PACKAGING IN TRANSPARENT POLYETHYLENE



**-30°C / +80°C**  
**-22°F / +176°F**



**RUBBER**



- **Massima leggerezza e flessibilità.**  
Maximum lightness and flexibility.
- **Conforme alla normativa europea EN ISO 3821.**  
EN ISO 3821 approved.



**IMPIEGO**  
**APPLICATIONS**

Per conduzione di ossigeno negli apparecchi di saldatura ove siano richieste caratteristiche di leggerezza e flessibilità. Il tubo è corrispondente alla normativa europea EN ISO 3821.

For oxigen conduction on soldering equipments where lightness and flexibility are requested. The hose is EN ISO 3821 approved.



**STRUTTURA**  
**BODY**

<b>A</b>	<b>Sottostrato Tube</b>	Liscio in gomma sintetica di colore nero. Black smooth synthetic rubber.
<b>B</b>	<b>Inserti Reinforcement</b>	Tessili sintetici. High tensile synthetic textile.
<b>C</b>	<b>Copertura Cover</b>	Gomma sintetica di colore blu e rosso resistente all'abrasione e agli agenti atmosferici. Abrasion, weather and flame resistant special synthetic rubber.
	<b>Superficie Surface</b>	Liscia. Smooth.



**FASCETTE E COLLARI STRINGITUBO CONSIGLIATE**  
**RECOMMENDED CLAMP/COLLAR**

STF - Fascette a vite Hose clamps with screw (pag. 204-207)  
SGT - Fascette pinzabili Stepp less (pag. 216)



mm	mm	bar	bar	bar	gr/mt	mm	m
5+5	10,5	20	60	-	270	40	100
6+6	13	20	60	-	289	48	100
8+8	15	20	60	-	420	64	100
10+10	17	20	60	-	490	80	100



**NORME NORMS:**  
ISO 1307 - UNI EN 559 - DIN EN ISO 3821  
**MARCATURA MARKING:**  
ISO 3821 - 2 MPA (20 BAR) - (DIAM) - EUROCORD®  
BINATO (YEAR)  
**CONFEZIONAMENTO BOX:**  
IMBALLO IN POLIETILENE TRASPARENTE  
PACKAGING IN TRANSPARENT POLYETHYLENE



**-30°C / +80°C**  
**-22°F / +176°F**



**RUBBER**



- **Massima leggerezza e flessibilità.**  
Maximum lightness and flexibility.
- **Conforme alla normativa europea EN ISO 3821.**  
EN ISO 3821 approved.

**IMPIEGO APPLICATIONS**

Idoneo per la conduzione di propano negli apparecchi di saldatura ove siano richieste caratteristiche di leggerezza e flessibilità. Il tubo è corrispondente alla normativa europea EN ISO 3821.

For propane conduction on soldering equipments where lightness and flexibility are requested. The hose is EN ISO 3821 approved.



**STRUTTURA BODY**

<b>A</b>	<b>Sottostrato Tube</b>	Liscio in gomma NBR di colore nero. Black smooth synthetic rubber.
<b>B</b>	<b>Inserti Reinforcement</b>	Tessili sintetici. High tensile synthetic textile.
<b>C</b>	<b>Copertura Cover</b>	Gomma SBR/EPDM di colore arancione resistente all'abrasione e agli agenti atmosferici. Abrasion, weather and flame resistant special synthetic rubber.
	<b>Superficie Surface</b>	Liscia. Smooth.

mm	mm	bar	bar	bar	gr/mt	mm	m
6	12	20	60	-	130	60	100
8	14	20	60	-	160	80	100
8	15	20	60	-	180	80	100
8	16	20	60	-	190	80	100
8	17	20	60	-	270	80	100

**FASCETTE E COLLARI STRINGITUBO CONSIGLIATE RECOMMENDED CLAMP/COLLAR**

- STF - Fascette a vite Hose clamps with screw (pag. 204-207)
- SGT - Fascette pinzabili Stepp less (pag. 216)



**NORME NORMS:**  
ISO 1307 - UNI EN 559 DIN EN ISO 3821

**MARCATURA MARKING:**  
ISO 3821 - 2 MPA (20 BAR) - (DIAM) - EUROCORD® PROPANO (YEAR)

**CONFEZIONAMENTO BOX:**  
IMBALLO IN POLIETILENE TRASPARENTE  
PACKAGING IN TRANSPARENT POLYETHYLENE



**-30°C / +80°C**  
**-22°F / +176°F**

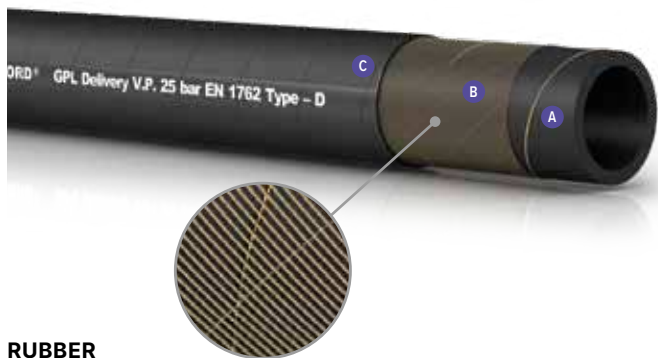

**RUBBER**



**IMPIEGO  
APPLICATIONS**

Normalmente impiegato a corredo delle autocisterne per lo scarico del GPL nelle stazioni di servizio. Conforme alla normativa EN 1762.

Normally used in support of tankers for the LPG delivery on the service stations. EN 1762 approved.



**STRUTTURA  
BODY**

<b>A</b> Sottostrato Tube	Gomma NBR conduttiva di colore nero, resistente al GPL. LPG resistant, conductive black NBR rubber.
<b>B</b> Inserti Reinforcement	Tessili sintetici ad alta tenacità, cordicella di rame. High tensile synthetic textile and antistatic copper wire.
<b>C</b> Copertura Cover	Gomma sintetica speciale microforata di colore nero resistente agli oli, alla fiamma, all'ozono, all'abrasione ed agli agenti atmosferici. Ozone, weather, heat, flame and oil resistant, special pin-pricked synthetic rubber.
Superficie Surface	Liscia ad impressione tela. Smooth with fabric impression.



**FASCETTE E COLLARI STRINGITUBO CONSIGLIATE  
RECOMMENDED CLAMP/COLLAR**

STF - Fascette a vite Hose clamps with screw (pag. 204-207)  
STC - Fascette con bullone Hose clamps with bolt (pag. 208-210)



- **Conforme alla normativa EN 1762.**  
EN1762 approved.



mm	mm	bar	bar	bar	gr/mt	mm	m
13	23	25	100	-	382	100	40
16	26	25	100	-	450	125	40
19	31	25	100	-	590	160	40
25	38	25	100	-	780	200	40
32	45	25	100	-	987	250	40
38	52	25	100	-	1256	320	40
50	67	25	100	-	1854	400	40



**NORME** NORMS:  
EN 1762 TYPE-D  
**MARCATURA** MARKING:  
EUROCORD® GPL DELIVERY W.P. 25 BAR EN 1762 TYPE-D  
**CONFEZIONAMENTO** BOX:  
IMBALLO IN POLIETILENE NERO  
PACKAGING IN BLACK POLYETHYLENE



**-30°C / +70°C**  
**-22°F / +158°F**

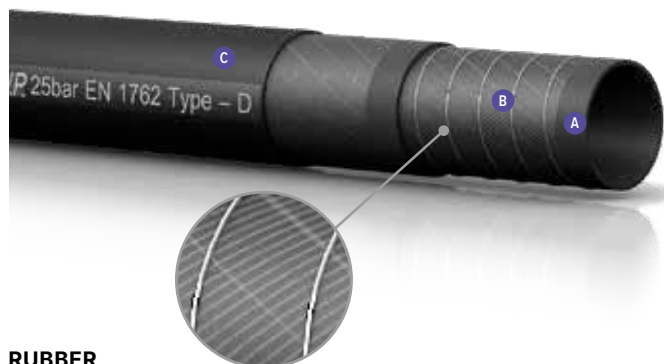

**RUBBER**



- **Conforme alla normativa EN 1762. EN1762 approved.**

**IMPIEGO APPLICATIONS**

Normalmente impiegato a corredo delle autocisterne per lo scarico del GPL nelle stazioni di servizio. Conforme alla normativa EN 1762.

Normally used in support of tankers for the LPG delivery on the service stations. EN 1762 approved.



**STRUTTURA BODY**

<b>A</b> Sottostrato Tube	Gomma NBR conduttiva di colore nero, resistente al GPL. LPG resistant, conductive black NBR rubber.
<b>B</b> Inserti Reinforcement	Tessili sintetici ad alta tenacità, cordicella di rame. High tensile synthetic textile and antistatic copper wire.
<b>C</b> Copertura Cover	Gomma sintetica speciale microforata di colore nero resistente agli oli, alla fiamma, all'ozono, all'abrasione ed agli agenti atmosferici. Ozone, weather, heat, flame and oil resistant, special pin-pricked synthetic rubber.
Superficie Surface	Liscia ad impressione tela. Smooth with fabric impression.

mm	mm	bar	bar	bar	gr/mt	mm	m
13	23	25	100	0,8	434	90	40
16	26	25	100	0,8	499	95	40
19	31	25	100	0,8	669	100	40
25	38	25	100	0,8	868	150	40
32	45	25	100	0,8	1136	200	40
38	52	25	100	0,8	1584	280	40
50	67	25	100	0,8	2268	350	40

**FASCETTE E COLLARI STRINGITUBO CONSIGLIATE RECOMMENDED CLAMP/COLLAR**

STF - Fascette a vite Hose clamps with screw (pag. 204-207)

STC - Fascette con bullone Hose clamps with bolt (pag. 208-210)



**NORME NORMS:**  
EN 1762 TYPE-D  
**MARCATURA MARKING:**  
EUROCORD® GPL DELIVERY W.P. 25 BAR EN 1762 TYPE-D  
**CONFEZIONAMENTO BOX:**  
IMBALLO IN POLIETILENE NERO  
PACKAGING IN BLACK POLYETHYLENE



**-30°C / +70°C**  
**-22°F / +158°F**



**RUBBER**



**IMPIEGO  
APPLICATIONS**

Idoneo per passaggio a bassa pressione di gas liquefatti in fase gassosa nei kit delle autovetture. La sua leggerezza e flessibilità facilita il montaggio in spazi ristretti.

Suitable for the low pressure of liquefied gas on the car kit. Its lightness and flexibility help the installation on small places.



**STRUTTURA  
BODY**

<b>A</b> <b>Sottostrato Tube</b>	Liscio ed impermeabile in gomma sintetica NBR di colore nero. LPG resistant, conductive black NBR rubber.
<b>B</b> <b>Inserti Reinforcement</b>	Tessili sintetici ad alta resistenza. High tensile synthetic textile.
<b>C</b> <b>Copertura Cover</b>	Gomma sintetica CSM resistente all'abrasione, al calore, agli agenti atmosferici e ozono. Ozone, weather, heat, flame and oil resistant, special pin-pricked synthetic rubber.
<b>Superficie Surface</b>	Liscia. Smooth.



**FASCETTE E COLLARI STRINGITUBO CONSIGLIATE  
RECOMMENDED CLAMP/COLLAR**

STF - Fascette a vite Hose clamps with screw (pag. 204-207)

STM - Fascette stringitubo Hose clamps (pag. 213)

SGT - Fascette pinzabili Stepp less (pag. 216)



- **Leggero e flessibile.**  
Light and flexible.
- **Facile montaggio in spazi ristretti.**  
Easy to install in small places.



mm	mm	bar	bar	bar	gr/mt	mm	m
4	10	4,5	10	-	85	40	50
5	10,5	4,5	10	-	90	50	50
6	13	4,5	10	-	135	60	50
8	15	4,5	10	-	165	80	50
10	17	4,5	10	-	200	100	50
11	19	4,5	10	-	250	110	50
12	19	4,5	10	-	225	120	50
14	22	4,5	10	-	300	140	50
17	24	4,5	10	-	300	170	50
19	27	4,5	10	-	385	190	50



**NORME NORMS:**  
ECE REG.110.00, ANNEX 4B, CLASS 2, ECE R67,01, ANNEX 8, CLASS 2, ISO 1307

**MARCATURA MARKING:**  
EUROCORD® LPG E 13 67R  
CLASS 2 CNG E 13 110R CLASS 2 (LOT)

**CONFEZIONAMENTO BOX:**  
IMBALLO IN POLIETILENE TRASPARENTE  
PACKAGING IN TRANSPARENT POLYETHYLENE



**-40°C / +125°C**  
**-40°F / +257°F**



**RUBBER**

**IMPIEGO APPLICATIONS**

Per conduzione di argon ove siano richieste caratteristiche di leggerezza e di flessibilità. Il tubo è corrispondente alla normativa europea EN ISO 3821.

For argon delivery in welding machines. According to European Reg. EN ISO3821.



**STRUTTURA BODY**

<b>A</b>	<b>Sottostrato Tube</b>	Liscio in gomma EPDM di colore nero. Smooth black EPDM rubber.
<b>B</b>	<b>Inserti Reinforcement</b>	Tessili sintetici. High tensile synthetic textile.
<b>C</b>	<b>Copertura Cover</b>	Gomma EPDM nera, resistente all'abrasione e agli agenti atmosferici. Weather, ozone and abrasion resistant EPDM rubber.
	<b>Superficie Surface</b>	Liscia. Smooth.

mm	mm	bar	bar	bar	gr/mt	mm	m
5	11	20	60	-	120	50	100
6,3	12,3	20	60	-	140	60	100
13	21	20	60	-	298	130	50
15	25	20	60	-	440	150	50

**FASCETTE E COLLARI STRINGITUBO CONSIGLIATE RECOMMENDED CLAMP/COLLAR**

STF - Fascette a vite Hose clamps with screw (pag. 204-207)

SGT - Fascette pinzabili Stepp less (pag. 216)



**NORME NORMS:**  
UNI EN 559, DIN EN ISO 3821, ISO 1307  
**MARCATURA MARKING:**  
ISO 3821 2 MPA (20 BAR) - (DIAM) - EUROCORD® ARGON (YEAR)  
**CONFEZIONAMENTO BOX:**  
IMBALLO IN POLIETILENE TRASPARENTE  
PACKAGING IN TRANSPARENT POLYETHYLENE



**-20°C / +70°C**  
**-4°F / +158°F**



PVC



**IMPIEGO**  
**APPLICATIONS**

Per mandata di gas metano per uso domestico. Da utilizzare preferibilmente come collegamento della rete di distribuzione del gas alle apparecchiature domestiche. Prodotto secondo le norme UNI 7140:2013 per la sicurezza delle apparecchiature domestiche a gas.

For delivery of natural gas for domestic use. Preferably used for the connection of the gas distribution network to domestic appliances. Product according to UNI 7140: 2013 standards for the safety of domestic gas appliances.



**STRUTTURA**  
**BODY**

<b>A</b>	<b>Sottostrato Tube</b>	Liscio in PVC di colore nero. Smooth black PVC.
<b>B</b>	<b>Inserti Reinforcement</b>	Fibre in poliestere tessili, sintetici. High tensile synthetic textile.
<b>C</b>	<b>Copertura Cover</b>	PVC di colore bianco. White PVC.
	<b>Superficie Surface</b>	Liscia. Smooth.



**FASCETTE E COLLARI STRINGITUBO CONSIGLIATE**  
**RECOMMENDED CLAMP/COLLAR**

STF - Fascette a vite Hose clamps with screw (pag. 204-207)  
SGT - Fascette pinzabili Stepp less (pag. 216)



- **Ideale per mandata di gas metano per uso domestico.**  
**Suitable for delivery of natural gas for domestic use.**



mm	mm	bar	bar	bar	gr/mt	mm	m
13	20	0,2	30	-	195	-	50



**NORME** NORMS:  
UNI 7140 CL 1 TIPO A1  
**MARCATURA** MARKING:  
UNI 7140 CL 1 TIPO A1



**-40°C / +90°C**  
**-40°F / +194°F**



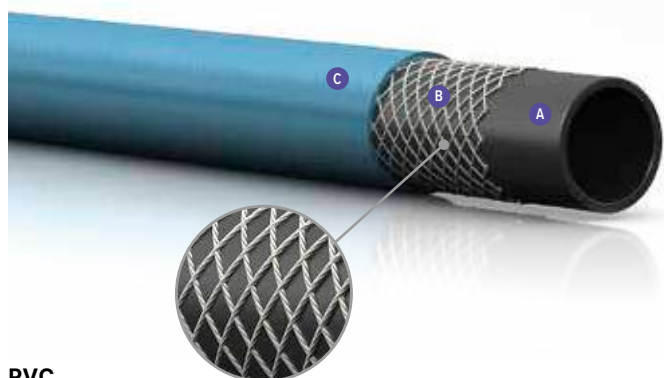

PVC



- **Ideale per mandata di gas GPL per uso domestico.**  
Suitable for delivery of LPG for domestic use.

**IMPIEGO APPLICATIONS**

Per mandata di gas GPL per uso domestico. Da utilizzare preferibilmente come collegamento tra la bombola e le apparecchiature domestiche a gas. Prodotto secondo le norme UNI CIG 7140 per la sicurezza delle apparecchiature domestiche a gas.

For delivery of LPG gas for domestic use. To be used preferably as a connection between the cylinder and domestic gas appliances. Produced according to UNI CIG 7140 standards for the safety of domestic gas appliances.



**STRUTTURA BODY**

<b>A</b>	<b>Sottostrato Tube</b>	Liscio in PVC di colore nero. Smooth black PVC.
<b>B</b>	<b>Inserti Reinforcement</b>	Fibre in poliestere tessili, sintetici. High tensile synthetic textile.
<b>C</b>	<b>Copertura Cover</b>	PVC di colore azzurro. Light blue PVC.
	<b>Superficie Surface</b>	Liscia. Smooth.

mm	mm	bar	bar	bar	gr/mt	mm	m
8	13	0,2	30	-	195	-	100

**FASCETTE E COLLARI STRINGITUBO CONSIGLIATE RECOMMENDED CLAMP/COLLAR**

- STF - Fascette a vite Hose clamps with screw (pag. 204-207)
- SGT - Fascette pinzabili Stepp less (pag. 216)



**NORME NORMS:**  
UNI 7140 CL 1 TIPO A1  
ISO 1307 REG. UE 10/2011 SIMULANT A,B,C, D2 E E  
**MARCATURA MARKING:**  
UNI CIG 7140



**-40°C / +90°C**  
**-40°F / +194°F**

**TUBI PER  
ACCIAIERIE**  
STEEL MILL HOSES

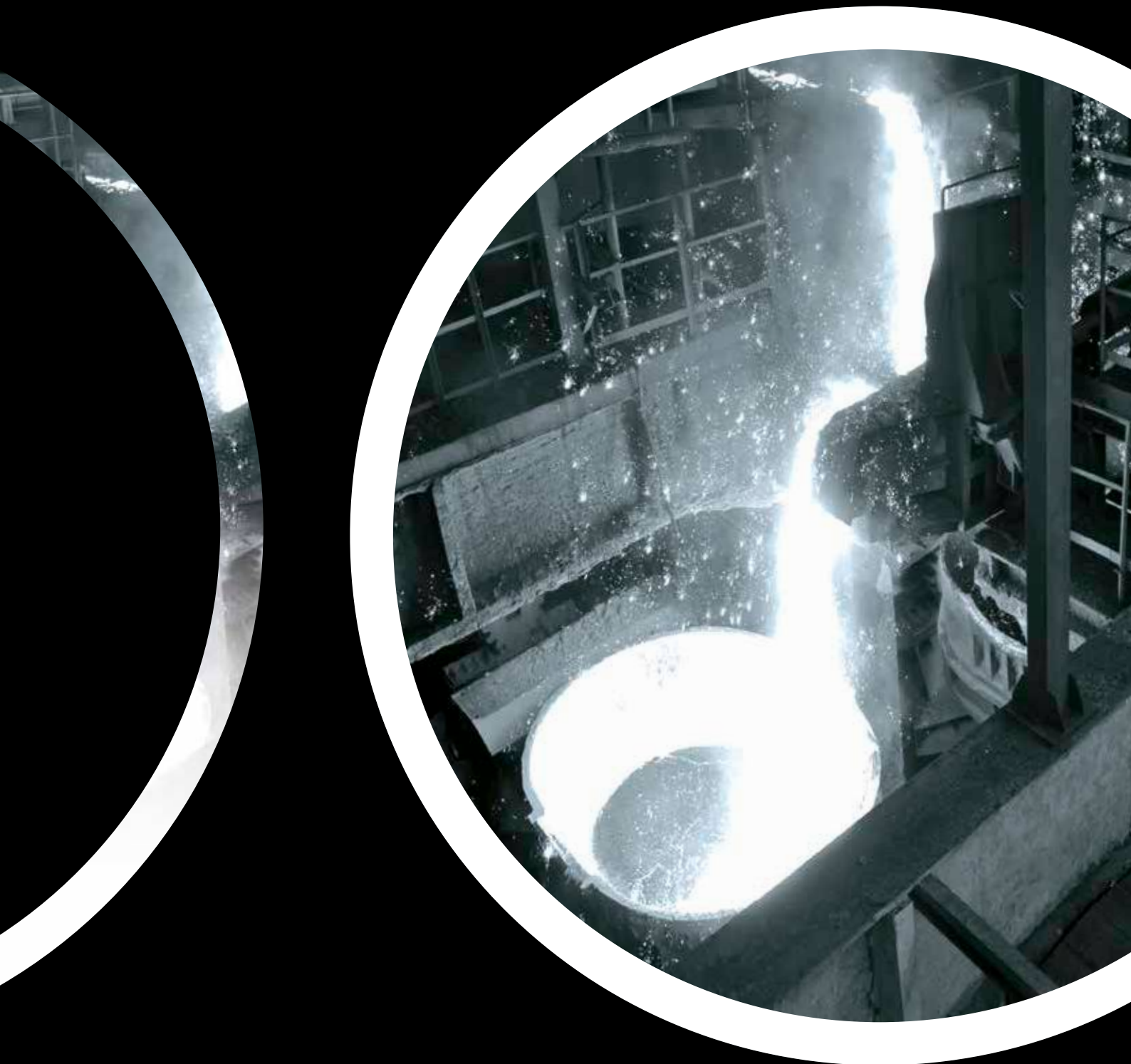
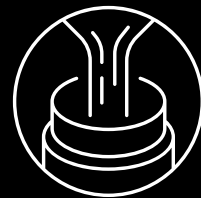

# ACQUA HD 40

## AUTOESTINGUENTE

## SELF-EXTINGUISHING

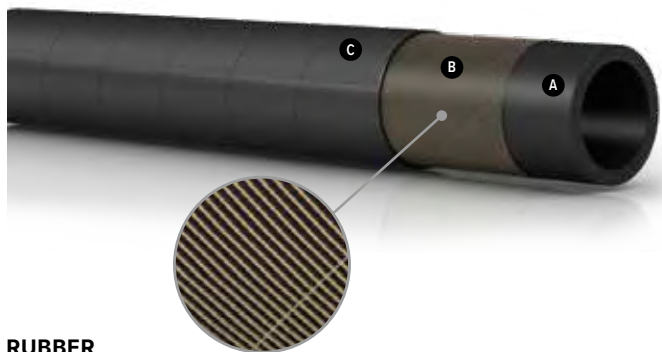

**RUBBER**



### IMPIEGO APPLICATIONS

Sola mandata di liquidi o di gas tecnici quali azoto, idrogeno, ossigeno ed altro; per applicazioni dove è richiesta la non propagazione della fiamma.

For the delivery only of liquids or of technical gas as nitrogen, hydrogen, oxygen and others; for applications where the flame must not propagate.



### STRUTTURA BODY

<b>A</b> Sottostrato Tube	Mescola nera autoestinguente secondo ASTM C542, a base CR. Black self-extinguishing compound according to ASTM C542, CR rubber.
<b>B</b> Inserti Reinforcement	Tessuti sintetici ad alta tenacità. High tensile synthetic textile.
<b>C</b> Copertura Cover	Mescola nera autoestinguente secondo ASTM C542, a base CR. Black self-extinguishing compound according to ASTM C542, CR rubber.
Superficie Surface	Liscia ad impressione tela. Smooth with fabric impression.











### FASCETTE E COLLARI STRINGITUBO CONSIGLIATE RECOMMENDED CLAMP/COLLAR

STF - Fascette a vite Hose clamps with screw (pag. 204-207)

STC - Fascette con bullone Hose clamps with bolt (pag. 208-210)



 mm	 mm	 bar	 bar	 bar	 gr/mt	 mm	 m
10	17	40	120	-	250	60	-
13	22	40	120	-	370	90	-
32	47	40	120	-	1350	190	-
38	54	40	120	-	1720	240	-



NORME NORMS: ISO 1307  
MARCATURA MARKING: --  
CONFEZIONAMENTO BOX:  
IMBALLO IN POLIETILENE NERO  
PACKAGING IN BLACK POLYETHYLENE



-30°C / +80°C  
-22°F / +176°F

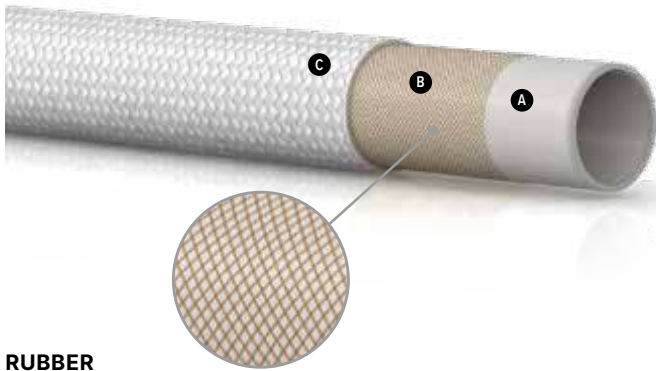

**RUBBER**



- **Struttura in fibra di vetro tipo E-550°C.**  
**Fiber glass structure type E-550°C.**
- **Consente un alto isolamento elettrico.**  
**Allow an high electric isolation.**



**IMPIEGO**  
**APPLICATIONS**

Sola mandata di liquidi o di gas su impianti dove è richiesto un alto isolamento elettrico ed una protezione esterna da fonti di calore radiante; applicazione tipica su forni elettrici di fusione acciaio.

For the delivery only of liquids or gas on plants where a high electric isolation and an external protection from radiant heat is requested; typical application on electric ovens of steel fusion.



**STRUTTURA**  
**BODY**

<b>A</b>	Mescola bianca in EPDM isolante. White insulating EPDM compound.
<b>B</b>	Tessuti sintetici ad alta tenacità. High tensile synthetic textile.
<b>C</b>	Tessuto grezzo in fibra di vetro, tipo E-550°C. Raw fabric in glass-fibre, type E-550°C.
<b>Superficie</b>	In fibra di vetro. Glass fiber braid.



**FASCETTE E COLLARI STRINGITUBO CONSIGLIATE**  
**RECOMMENDED CLAMP/COLLAR**

STF - Fascette a vite Hose clamps with screw (pag. 204-207)  
 STC - Fascette con bullone Hose clamps with bolt (pag. 208-210)



mm	mm	bar	bar	bar	gr/mt	mm	m
13	23	10	30	-	410	85	-
13	22	20	60	-	360	85	-
19	30	20	60	-	620	120	-
25	37	20	60	-	870	150	-
32	46	20	60	-	1290	190	-
38	53	20	60	-	1650	240	-
50	70	20	60	-	2850	300	-



**NORME NORMS:**  
 ISO 1307  
**MARCATURA MARKING:** --  
**CONFEZIONAMENTO BOX:**  
 IMBALLO IN POLIETILENE NERO  
 PACKAGING IN BLACK POLYETHYLENE



**-30°C / +120°C**  
**-22°F / +248°F**

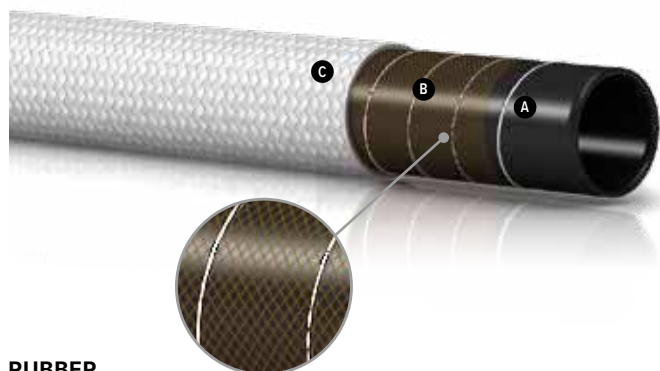

**RUBBER**



- **Struttura in fibra di vetro tipo E-550°C.**  
Fiber glass structure type E-550°C.
- **Consente un alto isolamento elettrico.**  
Allow an high electric isolation.

**IMPIEGO APPLICATIONS**

Tubo per mandata ed aspirazione di liquidi inerti su impianti dove è richiesta una protezione esterna da fonti di calore radiante; applicazione tipica su forni elettrici di fusione acciaio.

For the delivery only of liquids or gas on plants where a high electric isolation and an external protection from radiant heat is requested; typical application on electric ovens of steel fusion.



**STRUTTURA BODY**

<b>A</b>	<b>Sottostrato Tube</b>	Mescola nera SBR. Black SBR rubber.
<b>B</b>	<b>Inserti Reinforcement</b>	Tessuti sintetici ad alta tenacità. Spirale in acciaio incorporata. High tensile synthetic textile and steel wire helix.
<b>C</b>	<b>Copertura Cover</b>	Tessuto grezzo in fibra di vetro, tipo E-550°C. Raw fabric in glass-fibre, type E-550°C.
	<b>Superficie Surface</b>	In fibra di vetro. Glass fiber braid.

mm	mm	bar	bar	bar	gr/mt	mm	m
13	22	10	30	-	360	90	-
19	30	10	30	-	610	120	-
25	39	10	30	-	1020	150	-
32	46	10	30	-	1240	190	-
38	53	10	30	-	1550	230	-
50	68	10	30	-	2420	300	-
60	78	10	30	-	2830	360	-
75	93	10	30	-	3440	450	-
100	120	10	30	-	5050	600	-
125	148	10	30	-	7150	750	-
150	177	10	30	-	10150	900	-
200	232	10	30	-	15740	1200	-
250	286	10	30	-	21960	1500	-
75	93	20	60	-	3540	450	-
102	125	20	60	-	5980	600	-
127	149	20	60	-	6940	750	-
152	179	20	60	-	10270	900	-

**FASCETTE E COLLARI STRINGITUBO CONSIGLIATE RECOMMENDED CLAMP/COLLAR**

STF - Fascette a vite Hose clamps with screw (pag. 204-207)

STC - Fascette con bullone Hose clamps with bolt (pag. 208-210)



**NORME** NORMS: ISO 1307  
**MARCATURA** MARKING: --  
**CONFEZIONAMENTO** BOX: IMBALLO IN POLIETILENE NERO  
PACKAGING IN BLACK POLYETHYLENE



**-30°C / +90°C**  
**-22°F / +194°F**

# CFV HD 40

## AUTOESTINGUENTE SELF-EXTINGUISHING

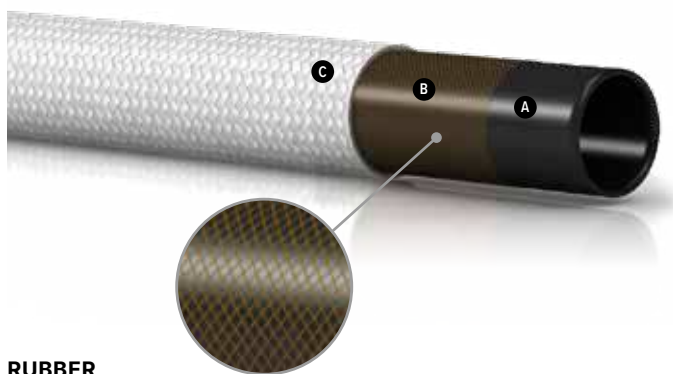

**RUBBER**



- **Struttura autoestinguente.**  
Self-extinguishes structure.
- **Consente protezione a fonti di calore.**  
Allow the protection from heat sources.



### IMPIEGO APPLICATIONS

Sola mandata di liquidi o di gas tecnici quali azoto, idrogeno, ossigeno ed altro; per applicazioni dove è richiesta la non propagazione della fiamma ed una protezione esterna da fonti di calore radiante; applicazione tipica su impianti siderurgici.

For the delivery only of liquids or gas on plants where a high electric isolation and an external protection from radiant heat is requested; typical application on electric ovens of steel fusion.



### STRUTTURA BODY

<b>A</b> Sottostrato Tube	Miscela nera autoestinguente secondo ASTM C542, a base CR. Black self-extinguishing compound according to ASTM C542, CR rubber.
<b>B</b> Inserti Reinforcement	Tessuti sintetici ad alta tenacità. High tensile synthetic textile.
<b>C</b> Copertura Cover	Tessuto grezzo in fibra di vetro, tipo E-550°C. Raw fabric in glass-fibre, type E-550°C.
<b>Superficie Surface</b>	In fibra di vetro. Glass fiber braid.



### FASCETTE E COLLARI STRINGITUBO CONSIGLIATE RECOMMENDED CLAMP/COLLAR

STF - Fascette a vite Hose clamps with screw (pag. 204-207)

STC - Fascette con bullone Hose clamps with bolt (pag. 208-210)



mm	mm	bar	bar	bar	gr/mt	mm	m
13	23	40	120	-	450	85	-
19	31	40	120	-	780	120	-
25	38	40	120	-	1050	150	-
32	47	40	120	-	1520	190	-
38	54	40	120	-	1850	240	-
50	70	40	120	-	2960	300	-
75	95	40	120	-	4200	450	-



**NORME NORMS:**  
ISO 1307

**MARCATURA MARKING: --**  
**CONFEZIONAMENTO BOX:**  
IMBALLO IN POLIETILENE NERO  
PACKAGING IN BLACK POLYETHYLENE



**-30°C / +80°C**  
**-22°F / +176°F**

# TUBI PER PASSAGGIO PRODOTTI CHIMICI

CHEMICAL DELIVERY HOSES



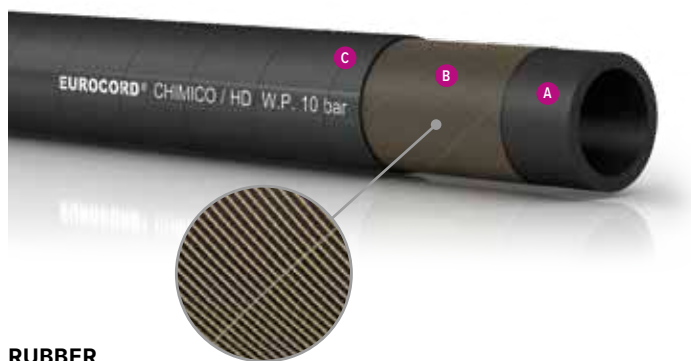

RUBBER



### IMPIEGO APPLICATIONS

Idoneo alla mandata di solventi, acidi organici e inorganici, sali, basi, chetoni ad alta concentrazione.

For discharge wide range of chemicals sea and industrial water.



### STRUTTURA BODY

<b>A</b>	<b>Sottostrato Tube</b>	Liscio in gomma EPDM di colore nero resistente ai solventi ed ai prodotti chimici. Chemical resistant black EPDM rubber.
<b>B</b>	<b>Inserti Reinforcement</b>	Tessuti tessili sintetici ad alta resistenza. High tensile synthetic textile.
<b>C</b>	<b>Copertura Cover</b>	Gomma EPDM/SBR resistente ai solventi, ai prodotti chimici all'abrasione e agli agenti atmosferici. Weather, ozone and abrasion resistant EPDM rubber.
	<b>Superficie Surface</b>	Liscia ad impressione tela. Smooth with fabric impression.



### FASCETTE E COLLARI STRINGITUBO CONSIGLIATE RECOMMENDED CLAMP/COLLAR









STF - Fascette a vite Hose clamps with screw (pag. 204-207)

STC - Fascette con bullone Hose clamps with bolt (pag. 208-210)



- **Ottima resistenza ai prodotti chimici.**  
Excellent chemicals products resistance.



 mm	 mm	 bar	 bar	 bar	 gr/mt	 mm	 m
10	18	10	30	-	180	100	40
12	20	10	30	-	210	120	40
15	25	10	30	-	250	150	40
18	28	10	30	-	280	180	40
20	29	10	30	-	320	200	40
25	34	10	30	-	420	250	40
30	42	10	30	-	700	300	40
35	48	10	30	-	850	350	40
40	55	10	30	-	1050	400	40
45	62	10	30	-	1370	450	40
51	66	10	30	-	1490	510	40
60	76	10	30	-	2400	600	40



**NORME NORMS:**  
ISO 1307

**MARCATURA MARKING:**  
EUROCORD® CHIMICO HD W.P. 10 BAR

**CONFEZIONAMENTO BOX:**  
IMBALLO IN POLIETILENE TRASPARENTE  
PACKAGING IN TRANSPARENT POLYETHYLENE



**-40°C / +120°C**  
**-40°F / +248°F**



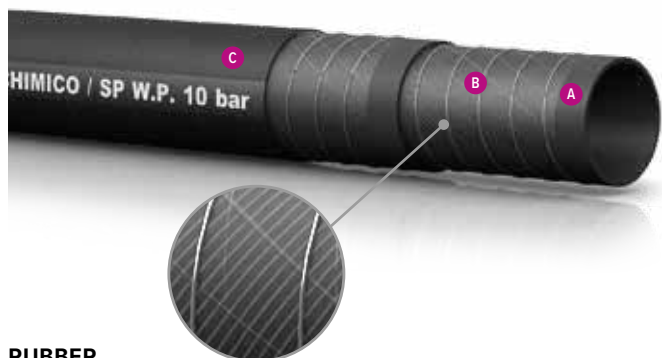

**RUBBER**



- **Doppia spirale che garantisce maggiore flessibilità.**  
Extremely flexible thanks to the double spiral.
- **Raggi di curvatura eccezionalmente stretti.**  
Exceptionally tight banding radiuses.

**IMPIEGO APPLICATIONS**

Per aspirazione e mandata di solventi, acidi organici e inorganici, sali, basi, chetoni ad alta concentrazione. La doppia spirale garantisce alla struttura del tubo una particolare flessibilità che lo rende molto maneggevole e gli permette raggi di curvatura eccezionalmente stretti.

For discharge wide range of chemicals sea and industrial water. The double spiral guarantees an excellent flexibility to the structure of the hose. it is very handy and it permits exceptionally tight banding radiuses.



**STRUTTURA BODY**

<b>A</b>	<b>Sottostrato Tube</b>	Liscio in gomma EPDM di colore nero resistente ai solventi ed ai prodotti chimici. Chemical resistant black EPDM rubber.
<b>B</b>	<b>Inserti Reinforcement</b>	Doppia spirale metallica e tessuti tessili sintetici. High tensile synthetic textile.
<b>C</b>	<b>Copertura Cover</b>	Gomma EPDM/SBR resistente ai solventi, ai prodotti chimici all'abrasione e agli agenti atmosferici. Weather, ozone and abrasion resistant EPDM rubber.
	<b>Superficie Surface</b>	Liscia ad impressione tela. Smooth with fabric impression.

mm	mm	bar	bar	bar	gr/mt	mm	m
30	42	10	30	0,7	720	180	40
35	48	10	30	0,7	860	210	40
40	53	10	30	0,7	1020	240	40
45	59	10	30	0,7	1250	270	40
51	64	10	30	0,7	1650	306	40
60	74	10	30	0,7	2150	360	40
70	86	10	30	0,7	2620	420	40
80	96	10	30	0,7	3400	480	40
102	120	10	30	0,7	4900	600	40
127	147	10	30	0,7	7550	762	40
152	175	10	30	0,7	12100	912	40
203	228	10	30	0,7	18000	1218	40

**FASCETTE E COLLARI STRINGITUBO CONSIGLIATE RECOMMENDED CLAMP/COLLAR**

- STF - Fascette a vite Hose clamps with screw (pag. 204-207)
- STC - Fascette con bullone Hose clamps with bolt (pag. 208-210)



**NORME** NORMS: ISO 1307  
**MARCATURA** MARKING: EUROCORD® CHIMICO SP W.P. 10 BAR  
**CONFEZIONAMENTO** BOX: IMBALLO IN POLIETILENE TRASPARENTE PACKAGING IN TRANSPARENT POLYETHYLENE



**-40°C / +120°C**  
**-40°F / +248°F**



**RUBBER**



**IMPIEGO  
APPLICATIONS**

Idoneo per mandata e aspirazione di vernici i cui solventi non abbiano contenuti aromatici, clorurati e idrocarburi alifatici.

Suitable for delivery and suction of paints with solvents non containing aromatic, aliphatic and chlorinated hydrocarbons.



**STRUTTURA  
BODY**









<b>A</b>	<b>Sottostrato Tube</b>	Liscio in gomma nera resistente alle vernici. Black, smooth, paints resistant special rubber.
<b>B</b>	<b>Inseriti Reinforcement</b>	Spirale metallica incorporata e tessuti tessili sintetici ad alta resistenza. Steel wire helix with high strength synthetic textile plies.
<b>C</b>	<b>Copertura Cover</b>	Gomma nera resistente all'abrasione, alle vernici, all'ozono e ad agenti atmosferici. Black, abrasion, paints, weathering and ozone, resistant rubber.
	<b>Superficie Surface</b>	Liscia ad impressione tela. Smooth with fabric impression.



**FASCETTE E COLLARI STRINGITUBO CONSIGLIATE  
RECOMMENDED CLAMP/COLLAR**

STC - Fascette con bullone Hose clamps with bolt (pag. 208-210)  
BANDI BLOCK - Coppia di serraggio Tightening torque (pag. 221)



 mm	 mm	 bar	 bar	 bar	 gr/mt	 mm	 m
13	23	10	15	0,8	450	55	40
16	26	10	15	0,8	500	65	40
19	30	10	15	0,8	600	75	40
25	36	10	15	0,8	750	100	40



**NORME NORMS:**  
ISO 1307 - ISO 22241-2

**MARCATURA MARKING:**  
EUROCORD® VERNICI/SP

**CONFEZIONAMENTO BOX:**  
IMBALLO IN POLIETILENE TRASPARENTE  
PACKAGING IN TRANSPARENT POLYETHYLENE



**-40°C / +100°C**  
**-40°F / +212°F**



**RUBBER**



- **Sottostrato in U.H.M.W.P.E. atossica approvata FDA.**  
UHMW-PE atoxic inner layer  
FDA approved.

**IMPIEGO APPLICATIONS**

Idoneo per mandata di tutti i liquidi alimentari e vari prodotti chimici; tale polivalenza lo rende particolarmente adatto all'industria farmaceutica, chimica ed alimentare.

For discharge of all corrosive chemicals, especially high aromatic solvents.



**STRUTTURA BODY**

<b>A</b>	<b>Sottostrato Tube</b>	In U.H.M.W.P.E. (Ultra High Molecular Weight Polyetilene) semitrasparente, atossica approvata F.D.A. Translucent, food grade UHMW-PE liner FDA approved.
<b>B</b>	<b>Inserti Reinforcement</b>	Tessuti in rayon ad alta resistenza, cavetto di rame per la dissipazione dell'elettricità statica. High tensile synthetic textile and antistatic copper wires.
<b>C</b>	<b>Copertura Cover</b>	Liscia ad impressione tela, in gomma sintetica gialla resistente agli agenti atmosferici, all'ozono e all'abrasione. Weather, ozone, abrasion resistant EPDM rubber.
	<b>Superficie Surface</b>	Liscia ad impressione tela. Smooth with fabric impression.

19	31	10	40	-	510	190	40
25	37	10	40	-	710	250	40
30	42	10	40	-	820	300	40
32	44	10	40	-	870	320	40
35	47	10	40	-	930	350	40
38	52	10	40	-	1130	380	40
40	54	10	40	-	1300	400	40
45	59	10	40	-	1470	450	40
51	65	10	40	-	1600	510	40
60	75	10	40	-	1930	600	40
63,5	78,5	10	40	-	2180	635	40
70	86	10	40	-	2460	700	40
76	94	10	40	-	2960	760	40
80	98	10	40	-	3100	800	20-40
102	122	10	40	-	3250	1020	20-40

**FASCETTE E COLLARI STRINGITUBO CONSIGLIATE RECOMMENDED CLAMP/COLLAR**

STF - Fascette a vite Hose clamps with screw (pag. 204-207)

STC - Fascette con bullone Hose clamps with bolt (pag. 208-210)



**NORME NORMS:**  
EN 12115 - TYPE SD  
**MARCATURA MARKING:**  
EUROCORD® CORDLINKED HD W.P. 10 BAR  
**CONFEZIONAMENTO BOX:**  
IMBALLO IN POLIETILENE TRASPARENTE  
PACKAGING IN TRANSPARENT POLYETHYLENE



**-40°C / +80°C**  
**-40°F / +176°F**

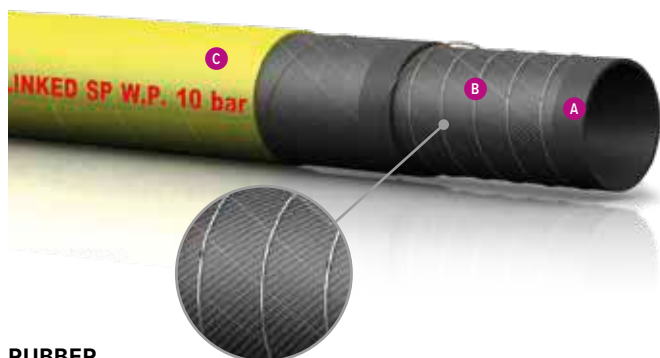

**RUBBER**



- **Sottostrato in U.H.M.W.P.E. atossica approvata FDA.**  
UHMW-PE atoxic inner layer  
FDA approved.



**IMPIEGO  
APPLICATIONS**

Idoneo per mandata di tutti i liquidi alimentari e vari prodotti chimici; tale polivalenza lo rende particolarmente adatto all'industria farmaceutica, chimica ed alimentare.

For suction and discharge of all corrosive chemicals, especially high aromatic solvents.



**STRUTTURA  
BODY**

<b>A</b> <b>Sottostrato Tube</b>	In U.H.M.W.P.E. (Ultra High Molecular Weight Polietilene) semitrasparente, atossica approvata F.D.A. Translucent, food grade UHMW-PE liner FDA approved.
<b>B</b> <b>Inseri Reinforcement</b>	Tessuti in rayon ad alta resistenza, cavetto di rame per la dissipazione dell'elettricità statica, spirale in metallo. High tensile synthetic textile and antistatic copper wires.
<b>C</b> <b>Copertura Cover</b>	Gomma sintetica gialla resistente agli agenti atmosferici, all'ozono e all'abrasione. Weather, ozone, abrasion resistant EPDM rubber.
<b>Superficie Surface</b>	Liscia ad impressione tela. Smooth with fabric impression.



**FASCETTE E COLLARI STRINGITUBO CONSIGLIATE  
RECOMMENDED CLAMP/COLLAR**

STF - Fascette a vite Hose clamps with screw (pag. 204-207)

STC - Fascette con bullone Hose clamps with bolt (pag. 208-210)



mm	mm	bar	bar	bar	gr/mt	mm	m
19	30	10	40	0,7	510	120	40
25	36	10	40	0,7	760	150	40
30	42	10	40	0,7	1140	175	40
32	46	10	40	0,7	1190	180	40
35	49	10	40	0,7	1300	200	40
38	52	10	40	0,7	1460	220	40
40	54	10	40	0,7	1520	220	40
45	59	10	40	0,7	1710	260	40
51	66	10	40	0,7	2030	280	40
60	75	10	40	0,7	2550	350	40
63,5	78,5	10	40	0,7	2660	360	40
70	86	10	40	0,7	2930	420	40
76	94	10	40	0,7	3460	420	40
80	96	10	40	0,7	3500	460	20-40
102	120	10	40	0,7	4740	590	20-40



**NORME NORMS:**  
EN 12115 - TYPE SD  
**MARCATURA MARKING:**  
EUROCORD® CORDLINKED SP W.P. 10 BAR  
**CONFEZIONAMENTO BOX:**  
IMBALLO IN POLIETILENE TRASPARENTE  
PACKAGING IN TRANSPARENT POLYETHYLENEE



**-40°C / +80°C**  
**-40°F / +176°F**



**RUBBER**



- **Per scarico prodotti chimici.**  
**For chemical products discharge.**

**IMPIEGO**  
**APPLICATIONS**

Idoneo alla mandata di solventi, acidi organici e inorganici, sali, basi, chetoni ad alta concentrazione.

For discharge wide range of chemicals sea and industrial water.



**STRUTTURA**  
**BODY**

<b>A</b>	<b>Sottostrato Tube</b>	Gomma nera in EPDM resistente agli agenti chimici. Chemical resistant black EPDM rubber.
<b>B</b>	<b>Inserti Reinforcement</b>	Tessili ad alta tenacità e 2 cordicelle in rame antistatiche. High tensile synthetic textile and 2 antistatic copper wire.
<b>C</b>	<b>Copertura Cover</b>	Gomma EPDM nera, resistente all'abrasione e agli agenti atmosferici. Weather, ozone and abrasion resistant EPDM rubber.
	<b>Superficie Surface</b>	Liscia ad impressione tela. Smooth with fabric impression.

mm	mm	bar	bar	bar	gr/mt	mm	m
25	37	16	64	-	746	150	40/61
32	44	16	64	-	934	175	40/61
38	51	16	64	-	1200	225	40/61
50	67	16	64	-	1943	275	40/61
63,5	79	16	64	-	2306	300	40/61
76	92	16	64	-	2713	350	40/61
102	118	16	64	-	3721	450	40/61

**FASCETTE E COLLARI STRINGITUBO CONSIGLIATE**  
**RECOMMENDED CLAMP/COLLAR**

STC - Fascette con bullone Hose clamps with bolt (pag. 208-210)



**NORME NORMS:**  
EN 12115 - TYPE D  
**MARCATURA MARKING:**  
EUROCORD® CHIMICO HD W.P. 10 BAR  
**CONFEZIONAMENTO BOX:**  
IMBALLO IN POLIETILENE NERO  
PACKAGING IN BLACK POLYETHYLENE



**-40°C / +120°C**  
**-40°F / +248°F**

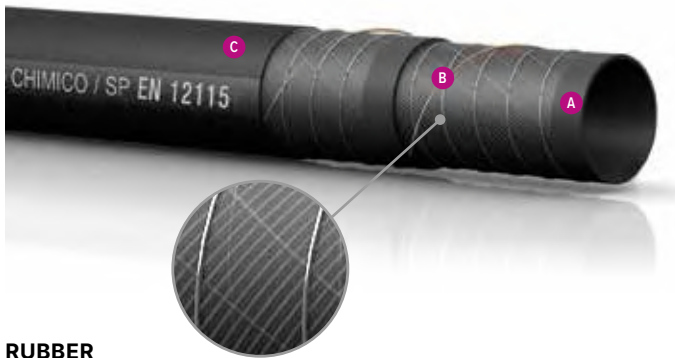

RUBBER



### IMPIEGO APPLICATIONS

Per aspirazione e mandata di acidi, alcaloidi, sali, composti organici (alcolici, chetoni, estere, etc.) incluse sostanze aromatiche, idrocarburi clorati e acidi ossidanti.

For suction and delivery of acids, alkaloids, salts, organic compounds (alcoholic, ketone, ester, etc.) including aromatics substances, chlorinated hydrocarbons and oxidizing acids.



### STRUTTURA BODY

<b>A</b>	<b>Sottostrato Tube</b>	Gomma nera in EPDM resistente agli agenti chimici. Chemical resistant black EPDM rubber.
<b>B</b>	<b>Inserti Reinforcement</b>	Tessili ad alta tenacità 2 spirali in acciaio, 2 cordicelle in rame antistatiche. High tensile synthetic textile, 2 steel wire helix and 2 antistatic coppers wire.
<b>C</b>	<b>Copertura Cover</b>	Gomma EPDM nera, conduttiva, resistente all'abrasione e agli agenti atmosferici. Weather, ozone and abrasion resistant EPDM rubber.
	<b>Superficie Surface</b>	Liscia ad impressione tela. Smooth with fabric impression.



### FASCETTE E COLLARI STRINGITUBO CONSIGLIATE RECOMMENDED CLAMP/COLLAR

STC - Fascette con bullone Hose clamps with bolt (pag. 208-210)



- Per aspirazione e mandata di acidi.  
For suction and delivery of acids.



mm	mm	bar	bar	bar	gr/mt	mm	m
30	42	10	30	0,7	720	180	40
35	48	10	30	0,7	860	210	40
40	53	10	30	0,7	1020	240	40
45	59	10	30	0,7	1250	270	40
51	64	10	30	0,7	1650	306	40
60	74	10	30	0,7	2150	360	40
70	86	10	30	0,7	2620	420	40
80	96	10	30	0,7	3400	480	40
102	120	10	30	0,7	4900	600	40
127	147	10	30	0,7	7550	762	40
152	175	10	30	0,7	12100	912	40
203	228	10	30	0,7	18000	1218	40



**NORME NORMS:**  
EN 12115-TYPE SD  
**MARCATURA MARKING:**  
EUROCORD® CHIMICO SP W.P. 10 BAR  
**CONFEZIONAMENTO BOX:**  
IMBALLO IN POLIETILENE NERO  
PACKAGING IN BLACK POLYETHYLENE



**-40°C / +120°C**  
**-40°F / +248°F**

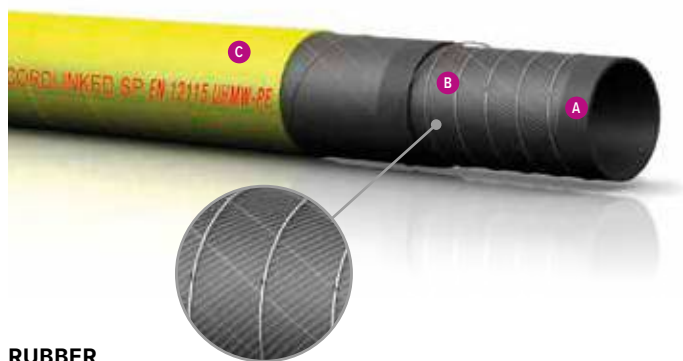

RUBBER



- **Idoneo per prodotti chimici corrosivi.**  
Suitable for chemical corrosive products.

### IMPIEGO APPLICATIONS

Idoneo per mandata e aspirazione di agenti chimici corrosivi e specialmente per solventi aromatici.

For discharge of all corrosive chemicals, especially high aromatic solvents.



### STRUTTURA BODY

<b>A</b>	<b>Sottostrato Tube</b>	In U.H.M.W.P.E. (Ultra High Molecular Weight Polyetilene) semitrasparente, atossica, resistente ad una vasta gamma di agenti chimici corrosivi e approvata F.D.A. Translucent, food grade UHMW-PE liner suitable for wide range of corrosive chemicals and solvents.
<b>B</b>	<b>Inserti Reinforcement</b>	Tessuti in rayon ad alta resistenza, 2 cordingelle di rame per la dissipazione dell'elettricità statica, spirale in metallo. High tensile synthetic textile and antistatic copper wires.
<b>C</b>	<b>Copertura Cover</b>	Gomma sintetica gialla resistente agli agenti atmosferici, all'ozono e all'abrasione. Weather, ozone, abrasion resistant EPDM rubber.
	<b>Superficie Surface</b>	Liscia ad impressione tela. Smooth with fabric impression.

### FASCETTE E COLLARI STRINGITUBO CONSIGLIATE RECOMMENDED CLAMP/COLLAR

STC - Fascette con bullone Hose clamps with bolt (pag. 208-210)



19	31	10	40	0,7	510	190	40
25	37	10	40	0,7	710	250	40
30	42	10	40	0,7	820	300	40
32	44	10	40	0,7	870	320	40
35	47	10	40	0,7	930	350	40
38	52	10	40	0,7	1130	380	40
40	54	10	40	0,7	1300	400	40
45	59	10	40	0,7	1470	450	40
51	65	10	40	0,7	1600	510	40
60	75	10	40	0,7	1930	600	40
63,5	78,5	10	40	0,7	2180	635	40
70	86	10	40	0,7	2460	700	40
76	94	10	40	0,7	2960	760	40
80	98	10	40	0,7	3100	800	20-40
102	122	10	40	0,7	3250	1020	20-40

**NORME NORMS:**  
EN 12115 - TYPE SD

**MARCATURA MARKING:**  
EUROCORD® CORDLINKED SP EN 12115 UHMW-PE

**CONFEZIONAMENTO BOX:**  
IMBALLO IN POLIETILENE NERO  
PACKAGING IN BLACK POLYETHYLENE

**-40°C / +80°C**  
**-40°F / +176°F**

# TUBI INDUSTRIALI PER USO NAVALE ED IMBARCAZIONI DA DIPORTO

HOSES MARINE  
INDUSTRIAL HOSES







**RUBBER**

- **Extra flessibile.**  
Extra flexible.
- **Omologato**  
Homologated



**IMPIEGO**  
**APPLICATIONS**

Tubo idoneo per adduzione di carburanti diesel e benzine ecologiche nelle imbarcazioni e navi da diporto. Tubazione estremamente flessibile e leggera con ottimi raggi di curvatura.

Suitable for transfer diesel and fuel for marine craft. extra flexible.



**STRUTTURA**  
**BODY**

<b>A</b>	<b>Sottostrato Tube</b>	Liscio in gomma nera (NBR) resistente ai carburanti con contenuto aromatico non superiore al 50%. NBR black oil/fuel rubber, smooth, resistant to maximum 50% aromatic contents.
<b>B</b>	<b>Inserti Reinforcement</b>	Tessili, sintetici ad alta tenacità. Synthetic textile.
<b>C</b>	<b>Copertura Cover</b>	Mescola in gomma sintetica resistente alla fiamma, ai lubrificanti, ai carburanti all'abrasione, all'acqua di mare ed agli agenti atmosferici. Synthetic rubber compound, flame resistant, abrasion, ozone, weather, heat and oil resistant rubber.
	<b>Superficie Surface</b>	Liscia. Smooth.

6	16	-	>14	-	0,240	60	40
8	17	-	>14	-	0,240	80	40
10	19	-	>14	-	0,280	100	40
12	22	-	>10	-	0,300	120	40
16	26	-	>10	-	0,460	160	40
19	30	-	>10	-	0,590	190	40



Disponibili anche in rocchetti.  
Also available in coils.

6	16	20
8	17	20
10	19	20

**FASCETTE E COLLARI STRINGITUBO CONSIGLIATE**  
**RECOMMENDED CLAMP/COLLAR**

STF - Fascette a vite Hose clamps with screw (pag. 204-207)

STM - Fascette stringitubo Hose clamps (pag. 213)

SGT - Fascette pinzabili Stepp less (pag. 216)



**MARCATURA MARKING:**  
EUROCORD® EN ISO 7840:2013 A1 E E10/B10  
COMPATIBILE R.I.NA APPROVED - CE - YEAR - SAE J 1527:2011 USCG R1 - LLOYD'S APPROVED  
**CONFEZIONAMENTO BOX:**  
IMBALLO IN POLIETILENE BLU  
PACKAGING IN BLUE POLYETHYLENE



**-35°C / +80°C**  
**+31°F / +176°F**

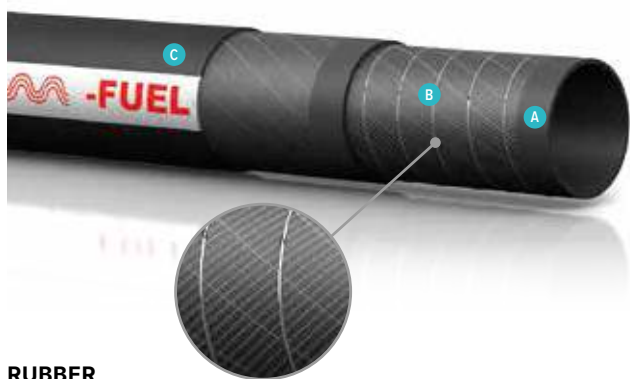

**RUBBER**



- **Flessibile.**  
Flexible.
- **Raggio di curvatura basso.**  
Low bending radius.

- **Omologato**  
Homologated



**IMPIEGO**  
**APPLICATIONS**

Idoneo per mandata e aspirazione di carburanti nelle imbarcazioni e navi da diporto. Particolarmente utilizzato per usi gravosi. Si caratterizza per la sua leggerezza e flessibilità.

Suitable for delivery and suction of fuels on boats and in the light marine industry. Suitable for heavy duties. Flexibility and lightness are a characteristic of this hose.

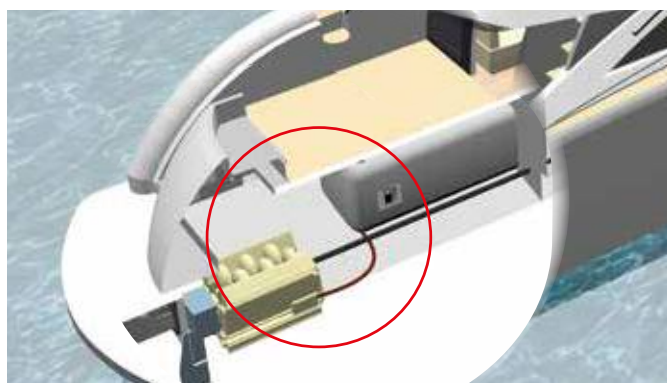

**STRUTTURA**  
**BODY**

<b>A</b>	<b>Sottostrato Tube</b>	Liscio in gomma nera (NBR) resistente ai carburanti con contenuto aromatico non superiore al 50%. NBR black oil/fuel rubber, smooth, resistant to maximum 50% aromatic contents.
<b>B</b>	<b>Inseriti Reinforcement</b>	Tessili, sintetici ad alta tenacità e spirale metallica incorporata. Synthetic yarns fabrics and steel wire.
<b>C</b>	<b>Copertura Cover</b>	Mescola in gomma sintetica resistente alla fiamma, ai lubrificanti, ai carburanti all'abrasione, all'acqua di mare ed agli agenti atmosferici. Synthetic rubber compound, flame resistant, abrasion, ozone, weather, heat and oil resistant rubber.
	<b>Superficie Surface</b>	Liscia. Smooth.



**FASCETTE E COLLARI STRINGITUBO CONSIGLIATE**  
**RECOMMENDED CLAMP/COLLAR**

- STF - Fascette a vite Hose clamps with screw (pag. 204-207)
- STC - Fascette con bullone Hose clamps with bolt (pag. 208-210)
- BANDI BLOCK - Coppia di serraggio Tightening torque (pag. 221)



mm	mm	bar	bar	bar	gr/mt	mm	m
19	31	2,5	10	-0,35	758	90	20
20	32	2,5	10	-0,35	787	100	20
22	34	2,5	10	-0,35	837	110	20
25	37	2,5	10	-0,35	918	125	20
30	42	2,5	10	-0,8	1.087	150	20
32	44	2,5	10	-0,8	1.148	160	20
35	47	2,5	10	-0,8	1.335	175	20
38	50	2,5	10	-0,8	1.433	190	20
40	52	2,5	10	-0,8	1.498	200	20
45	59	2,5	10	-0,8	1.954	223	20
51	63	2,5	10	-0,8	1.942	254	20
60	72	2,5	10	-0,8	2.226	300	20
63	76	2,5	10	-0,8	2.406	318	20



**MARCATURA MARKING:**  
EUROCORD® CARBOMARINE I.D. ... EN ISO 7840:2013 A1 E E10/B10  
COMPATIBILE R.I.N.A APPROVED - CE - YEAR -  
~ - FUEL HOSE - SAE J 1527:2011 USCG A1 - LLOYD'S APPROVED

**CONFEZIONAMENTO BOX:**  
IMBALLO IN POLIETILENE BLU  
PACKAGING IN BLUE POLYETHYLENE





**-20°C / +100°C**  
**+4°F / +212°F**



RUBBER



- **Extra flessibile.**  
Extra flexible.
- **Raggio di curvatura basso.**  
Low bending radius.
- **Omologato**  
Homologated   **NMMA**
- **Versione ondulata più flessibile.**  
More flexible corrugated version.

**IMPIEGO**  
APPLICATIONS

Idoneo per mandata e aspirazione di carburanti nelle imbarcazioni e navi da diporto. Particolarmente utilizzato per usi gravosi. Si caratterizza per la sua leggerezza e flessibilità.

Suitable for delivery and suction of fuels on boats and in the light marine industry. Suitable for heavy duties. Flexibility and lightness are a characteristic of this hose.

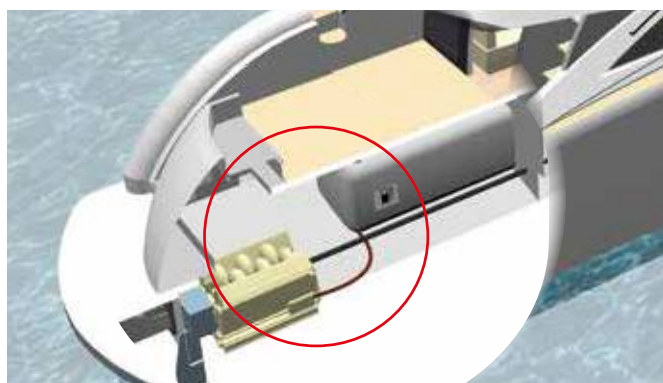

**STRUTTURA**  
BODY

<b>A</b>	<b>Sottostrato Tube</b>	Liscio in gomma nera (NBR) resistente ai carburanti con contenuto aromatico non superiore al 50%. NBR black oil/fuel rubber, smooth, resistant to maximum 50% aromatic contents.
<b>B</b>	<b>Inserti Reinforcement</b>	Tessili, sintetici ad alta tenacità e spirale metallica incorporata. Synthetic yarns fabrics and steel wire.
<b>C</b>	<b>Copertura Cover</b>	Mescola in gomma sintetica resistente alla fiamma, ai lubrificanti, ai carburanti all'abrasione, all'acqua di mare ed agli agenti atmosferici. Synthetic rubber compound, flame resistant, abrasion, ozone, weather, heat and oil resistant rubber.
	<b>Superficie Surface</b>	Liscia corrugata. Smooth corrugated.

 mm	 mm	 bar	 bar	 bar	 gr/mt	 mm	 m
19	26	5	15	-0,8	585	49	20
20	28	5	15	-0,8	616	52	20
22	31	5	15	-0,8	677	57	20
25	35	5	15	-0,8	770	65	20
30	40	5	15	-0,8	910	89	20
32	42	5	15	-0,8	970	95	20
35	46	5	15	-0,8	1096	105	20
38	50	5	15	-0,8	1190	115	20
40	52	5	15	-0,8	1252	129	20
45	59	5	15	-0,8	1409	145	20
51	61	5	15	-0,8	1540	165	20
60	72	5	15	-0,8	1811	194	20
63	76	5	15	-0,8	1902	203	20

**FASCETTE E COLLARI STRINGITUBO CONSIGLIATE**  
RECOMMENDED CLAMP/COLLAR

- STF - Fascette a vite Hose clamps with screw (pag. 204-207)
- STC - Fascette con bullone Hose clamps with bolt (pag. 208-210)
- BANDI BLOCK - Coppia di serraggio Tightening torque (pag. 221)



**MARCATURA MARKING:**  
EUROCORD® CARBOMARINE I.D. ... EN ISO 7840:2013 A1 E E10/B10  
COMPATIBILE R.I.N.A APPROVED - CE - YEAR -  
- FUEL HOSE - SAE J 1527:2011 USCG A1 - LLOYD'S APPROVED  
**CONFEZIONAMENTO BOX:**  
IMBALLO IN POLIETILENE BLU  
PACKAGING IN BLUE POLYETHYLENE



**-20°C / +100°C**  
**+4°F / +212°F**



**RUBBER**



• **Struttura a lunga durata.**  
Long life structure.

• **Omologato**  
Homologated



**IMPIEGO**  
**APPLICATIONS**

Idoneo per adduzione di carburanti diesel e benzine ecologiche nelle imbarcazioni e navi da diporto. Particolarmente utilizzato per usi gravosi. Si caratterizza per la sua leggerezza e flessibilità.

Suitable for transfer diesel and fuel for marine craft. Long Life structure.

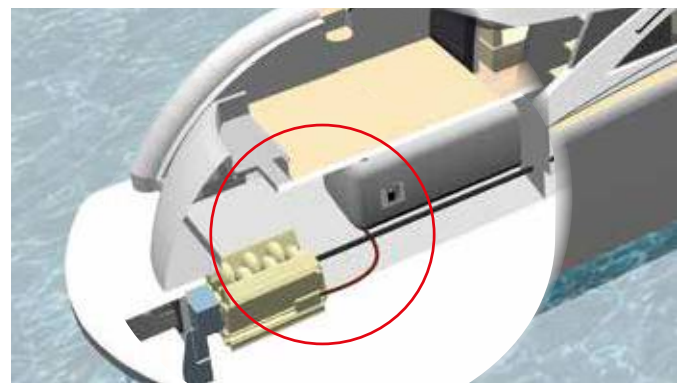

**STRUTTURA**  
**BODY**

<b>A</b>	<b>Sottostrato Tube</b>	Liscio in gomma nera (NBR) resistente ai carburanti con contenuto aromatico non superiore al 50%. NBR black oil/fuel rubber, smooth, resistant to maximum 50% aromatic contents.
<b>B</b>	<b>Inseriti Reinforcement</b>	Tessili, sintetici ad alta tenacità. Synthetic textile.
<b>C</b>	<b>Copertura Cover</b>	Mescola in gomma sintetica resistente alla fiamma, ai lubrificanti, ai carburanti all'abrasione, all'acqua di mare ed agli agenti atmosferici. Synthetic rubber compound, flame resistant, abrasion, ozone, weather, heat and oil resistant rubber.
	<b>Superficie Surface</b>	Liscia. Smooth.

mm	mm	bar	bar	bar	gr/mt	mm	m
19	31	2,5	10	-	705	190	20
20	32	2,5	10	-	733	200	20
22	34	2,5	10	-	789	220	20
25	37	2,5	10	-	853	254	20
30	42	2,5	10	-	1.012	300	20
32	44	2,5	10	-	1.068	320	20
35	47	2,5	10	-	1.152	350	20
38	50	2,5	10	-	1.235	380	20
40	52	2,5	10	-	1.340	400	20
45	58	2,5	10	-	1.723	445	20
50	63	2,5	10	-	1.577	508	20
60	72	2,5	10	-	1.831	600	20
63	76	2,5	10	-	1.989	630	20



**FASCETTE E COLLARI STRINGITUBO CONSIGLIATE**  
**RECOMMENDED CLAMP/COLLAR**

- STF - Fascette a vite Hose clamps with screw (pag. 204-207)
- STC - Fascette con bullone Hose clamps with bolt (pag. 208-210)
- BANDI BLOCK - Coppia di serraggio Tightening torque (pag. 221)



**MARCATURA MARKING:**  
EUROCORD® CARBOMARINE I.D. ... EN ISO 7840:2013 A1 E E10/B10  
COMPATIBILE R.I.NA APPROVED - CE - YEAR -  
~ - FUEL HOSE - SAE J 1527:2011 USCG A1 - LLOYD'S APPROVED

**CONFEZIONAMENTO BOX:**  
IMBALLO IN POLIETILENE BLU  
PACKAGING IN BLUE POLYETHYLENE



**-20°C / +100°C**  
**+4°F / +212°F**



**RUBBER**



- **Super flessibile.**  
Super flexible.
- **Raggio di curvatura molto basso.**  
Very low bending radius.
- **Omologato**  
Homologated



**IMPIEGO APPLICATIONS**

Idoneo per scarico di gas combustivi e di raffreddamento degli scambiatori di calore sulle navi ed imbarcazioni da diporto. Grazie alla sua particolare struttura risulta essere molto flessibile e con ottimi raggi di curvatura.

Suitable for discharging of exhaust gas, using at heating and cooling systems of craft. Very flexible.

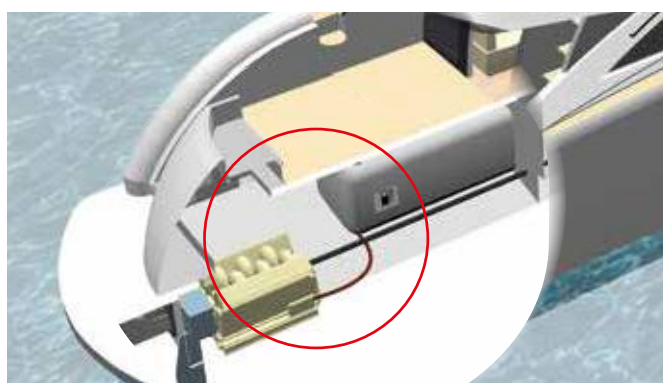

**STRUTTURA BODY**

<b>A</b>	<b>Sottostrato Tube</b>	Liscio in gomma nera resistente ai gas combustivi e all'acqua di mare. Black, sea water and gas burning resistant rubber.
<b>B</b>	<b>Inserti Reinforcement</b>	2 Spirali metalliche incorporate ed inserti tessili, sintetici ad alta tenacità. High tensile synthetic yarns and double steel helix wire.
<b>C</b>	<b>Copertura Cover</b>	Gomma nera resistente all'abrasione, all'acqua di mare, agli agenti atmosferici. Black, abrasion, ozone, weather, heat and sea water.
	<b>Superficie Surface</b>	Corrugata ad impressione tela. Corrugated fabric finished.

mm	mm	bar	bar	bar	gr/mt	mm	m
20	-	3	9	0,3	336	80	20
25	-	3	9	0,3	473	100	20
30	-	3	9	0,3	573	120	20
32	-	3	9	0,3	633	130	10/20
35	-	3	9	0,3	657	140	20
38	-	3	9	0,3	707	150	10/20
40	-	3	9	0,3	741	160	10/20
45	-	3	9	0,3	884	180	10/20
51	-	3	9	0,3	999	200	10/20
55	-	3	9	0,3	1096	220	20
60	-	3	9	0,3	1189	240	10/20
63	-	3	9	0,3	1253	250	10/20
65	-	3	9	0,3	1281	260	20
70	-	3	9	0,3	1374	280	20
76	-	3	9	0,3	1719	300	10/20
80	-	3	9	0,3	1828	320	20
90	-	3	9	0,3	2046	360	10/20
100	-	3	9	0,3	2502	400	20
102	-	3	9	0,3	2540	400	10/20
110	-	3	9	0,3	2706	440	10/20
115	-	3	9	0,3	2800	460	10/20
120	-	3	9	0,3	2942	480	20
127	-	3	9	0,3	3107	500	10/20
130	-	3	9	0,3	3178	520	20
140	-	3	9	0,3	3860	570	20
152	-	3	9	0,3	4856	825	10/20
168	-	3	9	0,3	5450	925	20
180	-	3	9	0,3	5703	1000	10
203	-	3	9	0,3	6859	1200	10

**FASCETTE E COLLARI STRINGITUBO CONSIGLIATE RECOMMENDED CLAMP/COLLAR**

- STF - Fascette a vite Hose clamps with screw (pag. 204-207)
- STC - Fascette con bullone Hose clamps with bolt (pag. 208-210)
- BANDI BLOCK - Coppia di serraggio Tightening torque (pag. 221)



**MARCATURA MARKING:**  
EUROCORD® MARINGAS/SP I.D. ... R.I.N.A  
APPROVED N. DIP042318XT/001 - ISO 13363:2006 -  
TYPE 1 CLASS A & B - TYPE CLASS A & B  
SAE J 2066:03 LLOYD'S APPROVED N. 02/0029  
**CONFEZIONAMENTO BOX:**  
IMBALLO IN POLIETILENE BLU  
PACKAGING IN BLUE POLYETHYLENE



**-30°C / +100°C**  
con picchi fino a  
with peaks up to  
+115°C  
**-22°F / +212°F**  
con picchi fino a  
with peaks up to  
+239°F



**RUBBER**



**IMPIEGO  
APPLICATIONS**

Tubo flessibile idoneo al passaggio dell'acqua di raffreddamento ed i gas combusti dei motori a scoppio delle imbarcazioni e navi da diporto.

Used as marine engine intake and wet exhaust hose in boats and ships.



- **Resistente a temperature molto elevate.**  
Resistant to very high temperature.
- **Raggio di curvatura molto basso.**  
Very low bending radius.

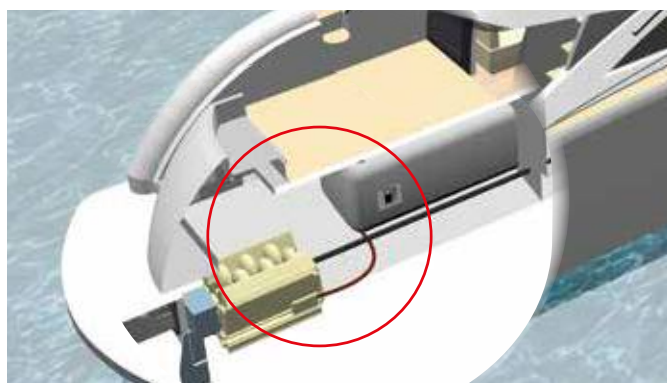

**STRUTTURA  
BODY**

<b>A</b>	<b>Sottostrato Tube</b>	Liscio in gomma siliconica blu, resistente al calore e all'acqua di mare. Smooth, blue silicone rubber, heat and salt water resistant.
<b>B</b>	<b>Inseriti Reinforcement</b>	Tessili, resistenti alle alte temperature, 2 spirali d'acciaio incorporate tra i tessuti. High temperature resistant plies, 2 steel wire spirals.
<b>C</b>	<b>Copertura Cover</b>	Ondulata, in gomma siliconica blu, resistente al calore ed agli agenti atmosferici. Smooth, blue silicone rubber, heat and salt water resistant.

mm	mm	bar	bar	bar	gr/mt	mm	m
19	-	-	25	-	0,43	90	20
20	-	-	25	-	0,45	95	20
25	-	-	20	-	0,54	100	20
28	-	-	20	-	0,59	105	20
30	-	-	18	-	0,63	110	20
32	-	-	18	-	0,66	115	20
35	-	-	15	-	0,72	125	20
38	-	-	15	-	0,88	130	20
40	-	-	15	-	0,97	135	20
42	-	-	15	-	1,02	135	20
45	-	-	12	-	1,08	140	20
48	-	-	12	-	1,14	150	20
51	-	-	12	-	1,20	160	20
54	-	-	10	-	1,27	160	20
60	-	-	8	-	1,39	165	20
63,5	-	-	8	-	1,59	170	20
65	-	-	8	-	1,62	170	20
67	-	-	8	-	1,67	175	20
70	-	-	8	-	1,74	180	20
73	-	-	8	-	1,88	200	20
76	-	-	8	-	1,94	220	20
80	-	-	8	-	2,04	225	20
90	-	-	7	-	3,26	250	20
102	-	-	6	-	3,65	280	20
114	-	-	6	-	4,04	290	20
127	-	-	6	-	4,46	300	20
133	-	-	6	-	4,93	350	20
140	-	-	6	-	5,74	360	20
152	-	-	6	-	6,19	400	20
203	-	-	5	-	10,29	450	10
254	-	-	5	-	14,92	1200	10
305	-	-	5	-	18,69	1450	10
350	-	-	5	-	21,58	1750	6
404	-	-	4	-	26,72	2000	6



**MARCATURA MARKING:**  
EUROCORD® SILMARINE/SP MARINE EXHAUST SAE  
J2006 R2



**-60°C / +200°C**  
**-76°F / +392°F**

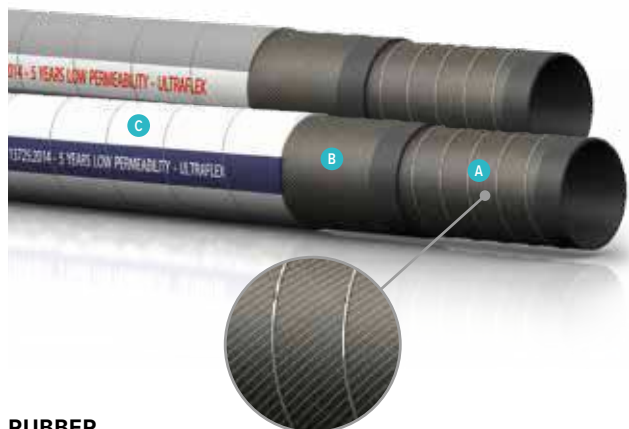

**RUBBER**



- **Forte resistenza agli odori.**  
Very strong odorless.
- **Forte permeabilità.**  
Strong permeability.
- **Lunga durata.**  
Long life.

**IMPIEGO  
APPLICATIONS**

Tubo idoneo allo scarico di acqua e liquidi organici all'interno delle imbarcazioni da diporto. La sua struttura estremamente flessibile gli permette di avere ottimi raggi di curvatura. È quindi adatto a spazi stretti e di difficile passaggio.

Suitable for craft marine toilets. The special inner avoid the spreading of bad odours from the toilet drain. It's extremely flexible for guarantee special bending radius inside the structure of the craft. Suitable for narrow spaces.

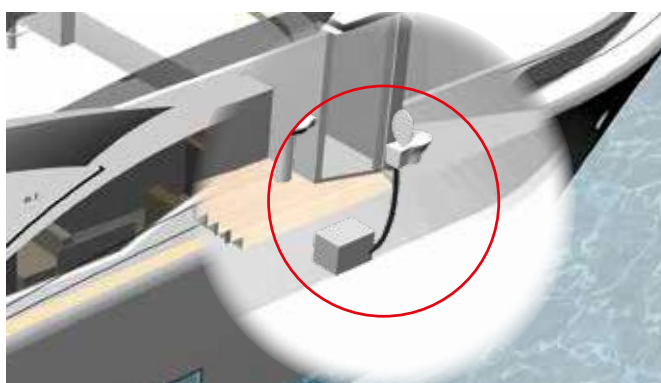

**STRUTTURA  
BODY**

<b>A</b>	<b>Sottostrato Tube</b>	Gomma butilica nera. Black, butyl rubber.
<b>B</b>	<b>Inserti Reinforcement</b>	Tessili, sintetici ad alta tenacità e spirale metallica incorporata. Synthetic textile fabrics and steel wire.
<b>C</b>	<b>Copertura Cover</b>	In gomma EPDM di colore grigio o bianco resistente agli agenti atmosferici, all'invecchiamento e all'ozono. Gray or white EPDM, abrasion, ozone, weather, resistant rubber.

mm	mm	bar	bar	bar	gr/mt	mm	m
16	24	-	-	0,8	345	50	40/30
19	27	-	-	0,8	410	60	40/30
25,4	33	-	-	0,8	525	80	40/30
30	38	-	-	0,8	605	95	40/30
38	46,5	-	-	0,8	930	120	40/30
40	48,5	-	-	0,8	975	130	40/30
51	59	-	-	0,8	1215	175	40/30

**FASCETTE E COLLARI STRINGITUBO CONSIGLIATE  
RECOMMENDED CLAMP/COLLAR**

- STF - Fascette a vite Hose clamps with screw (pag. 204-207)
- STC - Fascette con bullone Hose clamps with bolt (pag. 208-210)



**MARCATURA MARKING:**  
EUROCORD® SANITARI WC TESTED ISO 8099:2000 & UNI EN 13725:2014 - 5 YEARS LOW PERMEABILITY - ULTRAFLEX

**CONFEZIONAMENTO BOX:**  
IMBALLO IN POLIETILENE TRASPARENTE  
PACKAGING IN TRANSPARENT POLYETHYLENE



**-40°C / +120°C**  
**-40°F / +248°F**

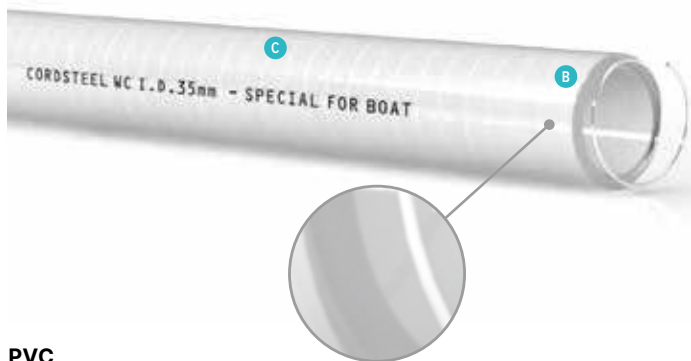

- **Estremamente flessibile.**  
Extremely flexible.

PVC



**IMPIEGO**  
APPLICATIONS

Tubo idoneo allo scarico di acqua e liquidi organici all'interno delle imbarcazioni da diporto. La sua struttura estremamente flessibile gli permette di avere ottimi raggi di curvatura. È quindi adatto a spazi stretti e di difficile passaggio.

Suitable for craft marine toilets. The special inner avoid the spreading of bad odours from the toilet drain. It is extremely flexible for guarantee special bending radius inside the structure of the boat. Suitable for narrow spaces.

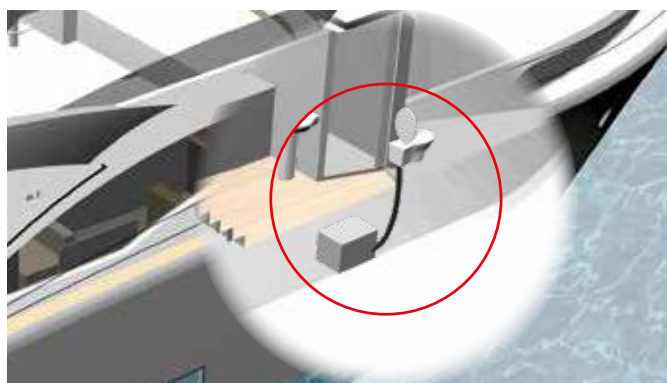

**STRUTTURA**  
BODY

<b>B</b>	Inserti Reinforcement	Spirale metallica incorporata. Built in steel spiral.
<b>C</b>	Copertura Cover	Bianco. White.

mm	mm	bar	bar	bar	gr/mt	mm	m
12	3,0	7	-	0,85	180	25	30/60
14	3,0	6	-	0,85	200	30	30/60
16	3,1	6	-	0,85	225	35	30/60
18	3,1	6	-	0,85	280	40	30/60
20	3,1	5	-	0,85	340	50	30/60
22	3,2	5	-	0,85	370	55	30/60
25	3,2	5	-	0,85	510	60	30/60
30	3,5	4	-	0,85	600	70	30/60
32	3,9	4	-	0,85	650	75	30
35	4,2	4	-	0,85	730	80	30
38	4,4	4	-	0,85	800	90	30
40	4,5	3	-	0,85	870	95	30
45	5,1	3	-	0,80	1100	105	30
50	5,1	3	-	0,80	1200	125	30
60	6,5	2,5	-	0,70	1800	135	30
63	6,5	2,5	-	0,70	1950	150	30
70	7	2	-	0,70	2200	180	30
76	7	2	-	0,70	2500	195	30
80	7,5	2	-	0,70	2700	220	30
90	7,5	2	-	0,60	3000	260	30
102	8	2	-	0,60	3400	300	30



**FASCETTE E COLLARI STRINGITUBO CONSIGLIATE**  
RECOMMENDED CLAMP/COLLAR

STF - Fascette a vite Hose clamps with screw (pag. 204-207)

STC - Fascette con bullone Hose clamps with bolt (pag. 208-210)



**MARCATURA MARKING:**  
CORDSTEEL WC I.D MM - SPECIAL FOR BOAT

**CONFEZIONAMENTO BOX:**  
IMBALLO IN POLIETILENE BIANCO  
PACKAGING IN WHITE POLYETHYLENE



**-5°C / +60°C**  
**+23°F / +140°F**



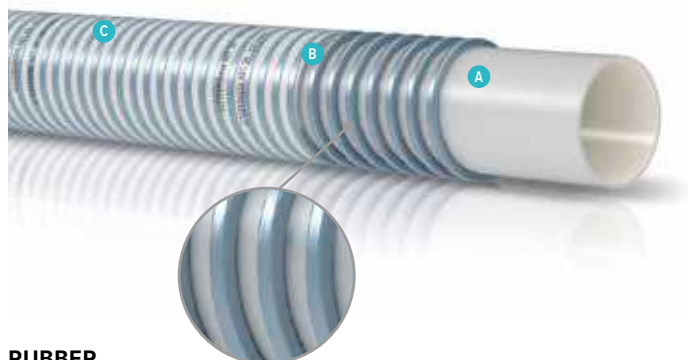

**RUBBER**



- **Nuova generazione di tubi inodore.**  
New generation of odorless hoses.
- **Rinforzo con spirale in PVC.**  
PVC spiral reinforcement.

**IMPIEGO APPLICATIONS**

Studiato appositamente come flessibile di scarico acque nere nelle toilettes di barche, caravan, etc. Grazie al materiale speciale con cui viene prodotto, è una valida alternativa al tubo in gomma, con i seguenti vantaggi: maggior flessibilità e leggerezza, maggior economicità, massima impermeabilità ai cattivi odori.

The low odour permeability of Saniflex delivery hose makes it ideal for conveying products where odour is a problem; i.e. toilet hoses on boats, trailers, caravans. Advantages compared to standard rubber hoses: more economical; higher odour-resistant; lighter and extra flexible.

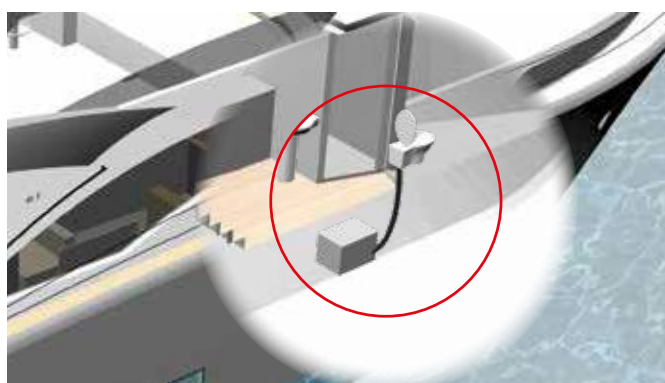

**STRUTTURA BODY**

<b>A</b> <b>Mescola interna</b> Internal composition	Mescola speciale in PVC che impedisce la propagazione dei cattivi odori. Special PVC compound that prevents bad odours.
<b>B</b> <b>Inserti Reinforcement</b>	PVC antiurto. Hard PVC antishock.
<b>C</b> <b>Copertura Cover</b>	Resistente al deterioramento causato da ozono e UV. Resistant to ozone and UV caused damages the outer material is slightly UV stabilised.

mm	mm	bar	bar	bar	gr/mt	mm	m
16	22,5	7	17	0,7	260	64	25
20	27	6	15	0,7	340	80	25
25	33	6	15	0,6	445	100	25
30	38	6	15	0,6	560	120	25
35	43,6	6	15	0,55	693	140	25
38	46	6	15	0,55	790	150	25
40	49	5	12	0,5	875	160	25
50	58	4	10	0,4	1100	250	25
60	68,4	3	8	0,35	1350	300	25

**FASCETTE E COLLARI STRINGITUBO CONSIGLIATE RECOMMENDED CLAMP/COLLAR**

- STF - Fascette a vite Hose clamps with screw (pag. 204-207)
- STC - Fascette con bullone Hose clamps with bolt (pag. 208-210)



**MARCATURA MARKING:**  
SANIFLEX WC LOW PERMEABILITY  
**CONFEZIONAMENTO BOX:**  
IMBALLO IN POLIETILENE BIANCO  
PACKAGING IN WHITE POLYETHYLENE



**-15°C / +65°C**  
**+5°F / +149°F**

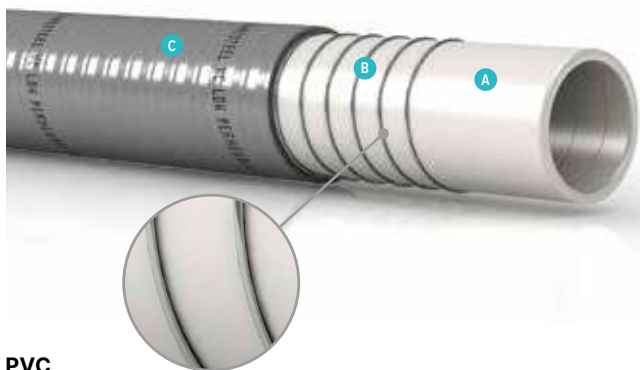

PVC



**IMPIEGO  
APPLICATIONS**

Studiato appositamente come flessibile di scarico acque nere nelle toilettes di barche, caravan, etc. Grazie al materiale speciale con cui viene prodotto, è una valida alternativa al tubo in gomma, con i seguenti vantaggi: maggior flessibilità e leggerezza, maggior economicità, massima impermeabilità ai cattivi odori.

The low odour permeability of Sanisteel delivery hose makes it ideal for conveyor products where odour is a problem; i.e. toilet hoses on boats, trailers, caravans. Advantages compared to standard rubber hoses: more economical; higher odour-resistant; lighter and extra flexible.



**STRUTTURA  
BODY**

<b>A</b> <b>Mescola interna</b> Internal composition	Mescola speciale in PVC che impedisce la propagazione dei cattivi odori. Special PVC compound that prevents bad odours.
<b>B</b> <b>Inserti Reinforcement</b>	In acciaio antiurto e ultraflessibile. Steel wire ultra-flexible.
<b>C</b> <b>Copertura Cover</b>	Resistente al deterioramento causato da ozono e UV. Resistant to ozone and UV caused damages the outer material is slightly UV stabilised.



**FASCETTE E COLLARI STRINGITUBO CONSIGLIATE  
RECOMMENDED CLAMP/COLLAR**

STF - Fascette a vite Hose clamps with screw (pag. 204-207)

STC - Fascette con bullone Hose clamps with bolt (pag. 208-210)



- **Nuova generazione di tubi inodore.**  
New generation of odorless hoses.
- **Rinforzo in filo d'acciaio.**  
Steel wire reinforcement.

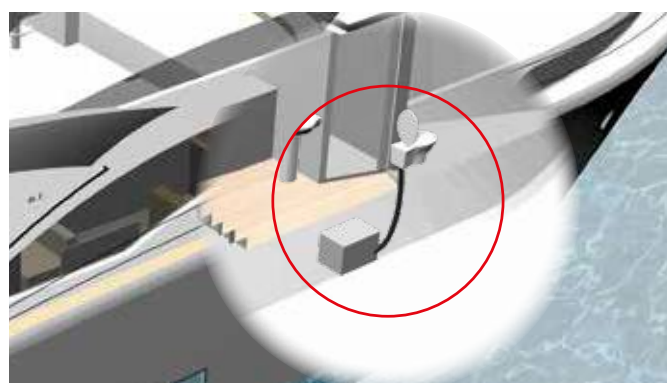

mm	mm	bar	bar	bar	gr/mt	mm	m
20	27	8,5	24	0,9	340	30	25
25	33	8,5	24	0,9	520	38	25
30	38,4	8	24	0,9	630	60	25
38	47	8	24	0,9	800	76	25
40	50	8	24	0,9	950	80	25
50	60	8	24	0,9	1020	100	25



**MARCATURA MARKING:**  
SANISTEEL WC LOW PERMEABILITY  
**CONFEZIONAMENTO BOX:**  
IMBALLO IN POLIETILENE BIANCO  
PACKAGING IN WHITE POLYETHYLENE



**-5°C / +60°C**  
**+23°F / +140°F**

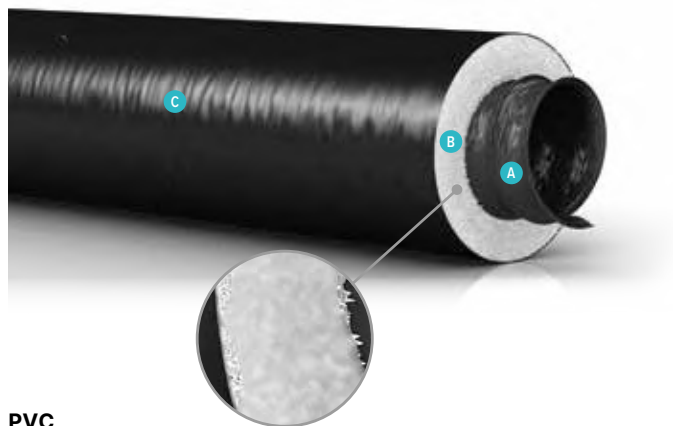

PVC



- **Molto flessibile.**  
Very flexible.

**IMPIEGO APPLICATIONS**

Ventilazione meccanica a semplice e doppio flusso. Riduzione della condensa e delle dispersioni di calore. Utilizzato per condizionamento dell'aria. Indicato nel settore industriale e navale.

Air conditioning. Single and double-flow mechanical ventilation. Suitable for air conditioning. It is used in marine and industrial sectors.

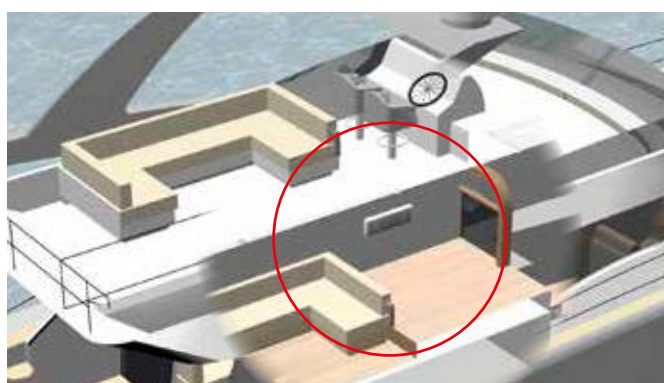

**STRUTTURA BODY**

<b>A</b>	<b>Sottostrato Tube</b>	Resine poliolefiniche additivate. Addivated polyolefin resin film.
<b>B</b>	<b>Inserti Reinforcement</b>	Spirale in filo di acciaio armonico. Steel wire helix.
<b>C</b>	<b>Copertura Cover</b>	Rivestimento termoisolante in fibra di poliestere (sp. 25 mm - 16 kg/m <sup>3</sup> ). Protezione esterna antivapore in resina poliolefinica additivata e rivestimento termoisolante in fibra di poliestere. Outer anti-steam protection in addivated polyolefin resin. Thermo-insulating covering in polyester fibre (thickness 25 mm - 16 kg/m <sup>3</sup> ).

mm	VELOCITÀ ARIA 8 mt/sec.		VELOCITÀ ARIA 10 mt/sec.		m
	PORTATA ARIA m <sup>3</sup> /h	PERDITA DI CARICO in Pa	PORTATA ARIA m <sup>3</sup> /h	PERDITA DI CARICO in Pa	
80	152	1-	190	31	10
102	250	15	333	24	10
127	383	12	368	18	10
160	575	8	773	14	10
203	900	6,5	1151	10,5	10
254	1445	4,7	1843	7,5	10
318	2278	3,7	3105	6	10
356	3058	3	3850	5,2	10
406	3845	2,7	4590	4,4	10
508	5111	2	8223	3	10

Esempi di calcolo delle portate e delle perdite di carico. Example of calculation of flow rates and pressure drop.

Per calcolare le portate e le perdite di carico degli altri diametri richiedere il nostro diagramma delle perdite di carico.

To calculate the flow and pressure drop of the other diameter, request our pressure drop diagram.

**REAZIONE AL FUOCO:**  
CLASSE 1 - M1

**FIRE REACTION:**  
CLASS 1 - M1

**-20°C / +90°C**  
con picchi fino a with peaks up to +110°C

**-4°F / +194°F**  
con picchi fino a with peaks up to +230°F

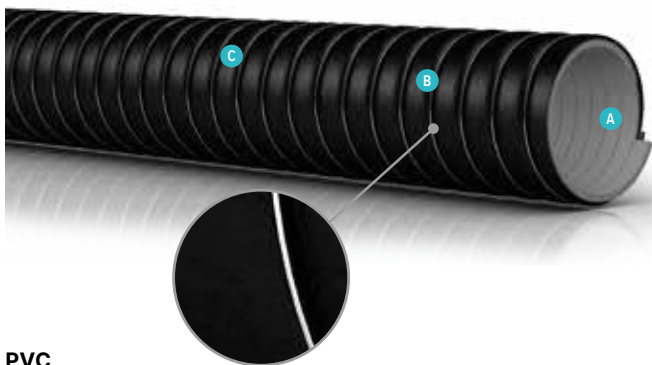

PVC



- **Molto flessibile.**  
Very flexible.
- **Bassa rumorosità.**  
Low noise.



**IMPIEGO**  
APPLICATIONS

Utilizzato nel condizionamento dell'aria, ventilazione meccanica semplice e a doppio flusso, riduzione della condensa e delle dispersioni di calore, impianti di condizionamento dell'aria per mezzi di trasporto, per uso agricolo, industriale e navale.

Air conditioning, Mechanical ventilation simple or double flow, Reduction of condensation and heat dispersion, air conditioning plants for transport, agricultural, industrial and marine use.



**STRUTTURA**  
BODY

<b>A</b>	<b>Sottostrato Tube</b>	Resine poliolefiniche additivate. Addivated polyolefin resin film.
<b>B</b>	<b>Inseriti Reinforcement</b>	Spirale in filo di acciaio armonico. Steel wire helix.
<b>C</b>	<b>Copertura Cover</b>	Rivestimento termoisolante in polietilene reticolato ed espanso a celle chiuse, protezione esterna film di resine poliolefiniche additivate. Flexible hose made of addivated polyolefin resins film, thermos - insulating coating in netted and closed cell foam polyethylene, external protection in addivated polyolefin resins film and embedded steel wire helix.

mm	mm	bar	bar	bar	gr/mt	mm	m
50	-	-	0,70	0,18	96	35	10
60	-	-	0,70	0,15	115	42	10
70	-	-	0,60	0,13	128	49	10
80	-	-	0,50	0,09	154	56	10
102	-	-	0,40	0,08	200	70	10
127	-	-	0,40	0,07	254	92	10
152	-	-	0,20	0,05	308	105	10
160	-	-	0,15	0,05	331	110	10
180	-	-	0,15	0,05	438	130	10
203	-	-	0,15	0,04	492	140	10
254	-	-	0,08	0,03	600	175	10

\*Pressure and vacuum data based on +20° room temperature.

**POLIETILENE RETICOLATO ESPANSO TIPO CL1**  
NETTED POLYETHYLENE FOAM TYPE CL1

PROPRIETÀ FISICO-MECCANICHE Physical-mechanical properties	U.M. S.M.	METODO Rules	VALORI Values
DENSITÀ Density	kg/m³	CSE RF 2/75° RF 3/77	30
CLASSE DI COMBUSTIONE Class of combustion		UNI 7745 ASTM C177 UNI7745 ASRM C177	CL1
COEFFICIENTE DI CONDUCEBILITÀ TERMICA A 0°C (λ) Coefficient of thermal conductivity at 0°C (λ)	W/mk kcal/min °C	UNI 7745 ASTM C177 UNI7745 ASRM C177	0,0344 0,0294
COEFFICIENTE DI CONDUCEBILITÀ TERMICA A 40°C (λ) Coefficient of thermal conductivity at 40°C (λ)	W/mk kcal/min °C	DIN 52615	0,0372 0,032
COEFF. DI RESISTENZA ALTA DIFFUSIONE DEL VAPORE ACQUO Coefficient of resistance to water steam diffusion	μ	DIN 52616	>65.000
PERMEABILITÀ AL VAPORE D'ACQUA Permeability to water steam	Ng/Pa s m	DIN 53433	0,12
ASSORBIMENTO D'ACQUA DOPO 24 gg Water absorbtion after 24 days	Vol. %	ISO 3386/1	<3
RESISTENZA ALLA COMPRESIONE AL 10% Compressive strenght at 10%	g/cm²	DIN53431	190,00
STABILITÀ DIMENSIONALE Dimension stability	°C		100
TEMPERATURA MAX D'USO Max operating temperature	°C		-80 +100
TEMPERATURA D'IMPIEGO CON SOLLECITAZIONE MECCANICA Operating temperature with mechanical stress	°C		-40 +100



**REAZIONE AL FUOCO:**  
FILM INTERNO ED ESTERNO CLASSE 1 - M1, PES ESPANSO CLASSE 1 - M1  
**FIRE REACTION:**  
INTERNAL AND EXTERNAL FILM CLASS 1 - M1, PES CLOSED-CELL FOAM 1 - M1



**-40°C / +100°C**  
**-40°F / +212°F**

**SATIBLOCK®**

**FASCETTE E COLLARI  
STRINGITUBO**

CLAMPS AND COLLAR

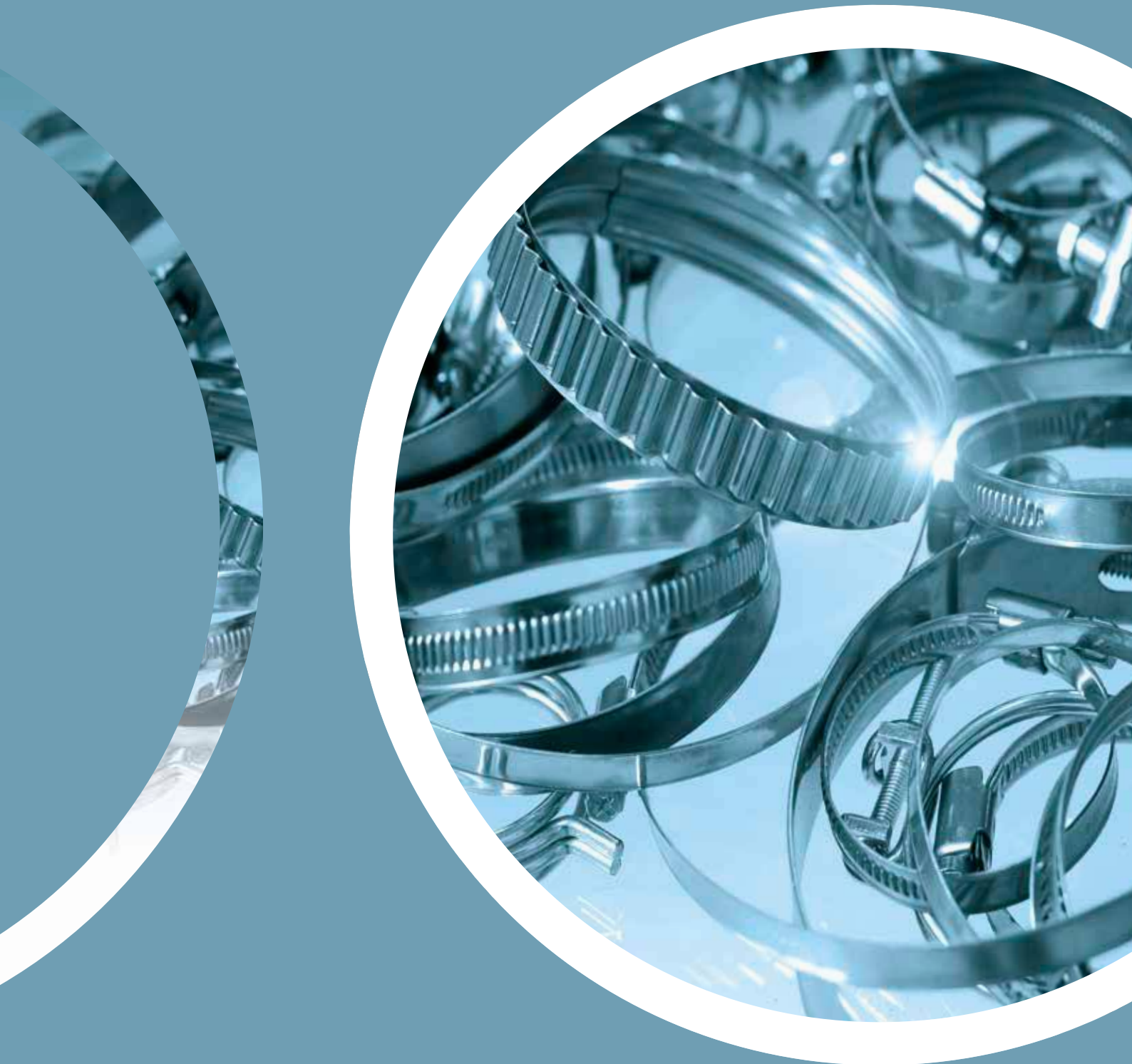

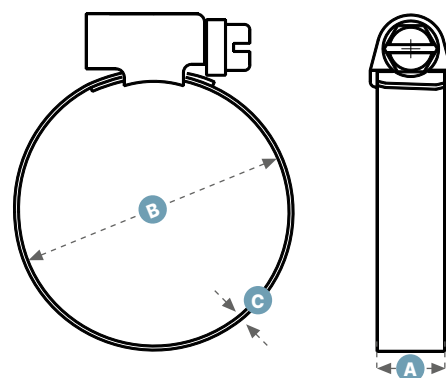

## IMPIEGO APPLICATIONS

Industria in genere  
Macchine agricole  
Edilizia  
Irrigazione

Industry in general  
Agriculture machine  
Construction  
Irrigation



## DESCRIZIONE DESCRIPTION

Fascetta ad altissima tenuta, compatta e resistente. La banda interna liscia ed i bordi rialzati, conferiscono assoluta sicurezza al tubo. Conforme alla normativa DIN 3017.

High resistant clamp, compact and durable. Rolle-up band edges and smooth band underside are able to guarantee total protection to the hose. Conforme to DIN 3017.



## MATERIALE MATERIAL

<b>Banda Band</b>	Acciaio inossidabile Stainless steel <b>AISI 201</b>
<b>Cassetto Housing</b>	Acciaio zincato Zinc-plated steel
<b>Vite Screw</b>	Acciaio zincato Zinc-plated steel

LARG. NASTRO BAND WIDTH	DIAM. DIAM.	SPESSORE THICKNESS	COPPIA DI SERRAGGIO RACCOMANDATA RECOMMENDED TIGHTENING TORQUE (PAG. 221)	SCATOLE BOX
<b>A</b> mm	<b>B</b> mm	<b>C</b> mm	<b>Nm</b>	<b>pz/nrm</b>

### 9 mm

W1A09008012000	9	8-12	0,8	2,6	100
W1A09010016000	9	10-16	0,8	2,6	100
W1A09012020000	9	12-20	0,8	2,6	100
W1A09016025000	9	16-25	0,8	4,0	100
W1A09016027000	9	16-27	0,8	4,0	100
W1A09020032000	9	20-32	0,8	4,0	100
W1A09025040000	9	25-40	0,8	4,0	100
W1A09035050000	9	32-50	0,8	4,0	50
W1A09040060000	9	40-60	0,8	4,0	50
W1A09050070000	9	50-70	0,8	4,0	50
W1A09060080000	9	60-80	0,8	4,0	50
W1A09070090000	9	70-90	0,8	4,0	25
W1A09080100000	9	80-100	0,8	4,0	25
W1A09090110000	9	90-110	0,8	4,0	25
W1A09100120000	9	100-120	0,8	4,0	25
W1A09110130000	9	110-130	0,8	4,0	25
W1A09120140000	9	120-140	0,8	4,0	25
W1A09130150000	9	130-150	0,8	4,0	25

### 12 mm

W1B12016025000	12	16-25	1,0	6,5	100
W1B12016027000	12	16-27	1,0	6,5	100
W1B12020032000	12	20-32	1,0	6,5	100
W1B12025040000	12	25-40	1,0	6,5	100
W1B12035050000	12	32-50	1,0	6,5	50
W1B12040060000	12	40-60	1,0	6,5	50
W1B12050070000	12	50-70	1,0	6,5	50
W1B12060080000	12	60-80	1,0	6,5	50
W1B12070090000	12	70-90	1,0	6,5	25
W1B12080100000	12	80-100	1,0	6,5	25
W1B12090110000	12	90-110	1,0	6,5	25
W1B12100120000	12	100-120	1,0	6,5	25
W1B12110130000	12	110-130	1,0	6,5	25
W1B12120140000	12	120-140	1,0	6,5	25
W1B12130150000	12	130-150	1,0	6,5	25
W1B12140160000	12	140-160	1,0	6,5	25
W1B12150170000	12	150-170	1,0	6,5	25
W1B12160180000	12	160-180	1,0	6,5	25
W1B12170190000	12	170-190	1,0	6,5	25
W1B12180200000	12	180-200	1,0	6,5	25

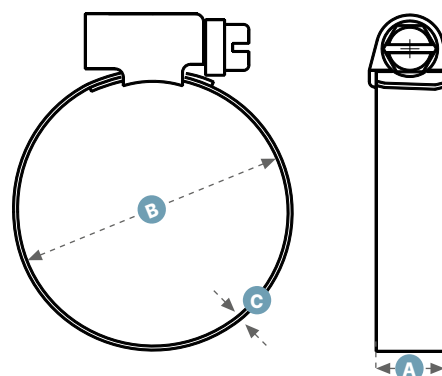

## IMPIEGO APPLICATIONS

Macchine agricole	Agriculture machine
Edilizia	Construction
Irrigazione	Irrigation
Automotive	Automotive

## DESCRIZIONE DESCRIPTION

Fascetta ad altissima tenuta, compatta e resistente. La banda interna liscia ed i bordi rialzati, conferiscono assoluta sicurezza al tubo. conforme alla normativa DIN 3017.

High resistant clamp, compact and durable. Rolle-up band edges and smooth band underside are able to guarantee total protection to the hose. Conforme to DIN 3017.

## MATERIALE MATERIAL

<b>Banda Band</b>	Acciaio inossidabile Stainless steel <b>AISI 430</b>
<b>Cassetto Housing</b>	Acciaio inossidabile Stainless steel <b>AISI 430</b>
<b>Vite Screw</b>	Acciaio zincato Zinc-plated steel

	LARG. NASTRO BAND WIDTH	DIAM. DIAM.	SPESSORE THICKNESS	COPPIA DI SERRAGGIO RACCOMANDATA RECOMMENDED TIGHTENING TORQUE (PAG. 221)	SCATOLE BOX	
	<b>A</b> mm	<b>B</b> mm	<b>C</b> mm	<b>Nm</b>	<b>pz/nrm</b>	
<b>9</b> mm	W2A09008012000	9	8-12	0,8	2,6	100
	W2A09010016000	9	10-16	0,8	2,6	100
	W2A09012020000	9	12-20	0,8	2,6	100
	W2A09016025000	9	16-25	0,8	4,0	100
	W2A09016027000	9	16-27	0,8	4,0	100
	W2A09020032000	9	20-32	0,8	4,0	100
	W2A09025040000	9	25-40	0,8	4,0	100
	W2A09035050000	9	32-50	0,8	4,0	50
	W2A09040060000	9	40-60	0,8	4,0	50
	W2A09050070000	9	50-70	0,8	4,0	50
	W2A09060080000	9	60-80	0,8	4,0	50
	W2A09070090000	9	70-90	0,8	4,0	25
	W2A09080100000	9	80-100	0,8	4,0	25
	W2A09090110000	9	90-110	0,8	4,0	25
	W2A09100120000	9	100-120	0,8	4,0	25
	W2A09110130000	9	110-130	0,8	4,0	25
W2A09120140000	9	120-140	0,8	4,0	25	
W2A09130150000	9	130-150	0,8	4,0	25	
<b>12</b> mm	W2B12012020000	12	12-20	1,0	6,5	100
	W2B12016025000	12	16-25	1,0	6,5	100
	W2B12016027000	12	16-27	1,0	6,5	100
	W2B12020032000	12	20-32	1,0	6,5	100
	W2B12025040000	12	25-40	1,0	6,5	100
	W2B12035050000	12	32-50	1,0	6,5	50
	W2B12040060000	12	40-60	1,0	6,5	50
	W2B12050070000	12	50-70	1,0	6,5	50
	W2B12060080000	12	60-80	1,0	6,5	50
	W2B12070090000	12	70-90	1,0	6,5	25
	W2B12080100000	12	80-100	1,0	6,5	25
	W2B12090110000	12	90-110	1,0	6,5	25
	W2B12100120000	12	100-120	1,0	6,5	25
	W2B12110130000	12	110-130	1,0	6,5	25
	W2B12120140000	12	120-140	1,0	6,5	25
	W2B12130150000	12	130-150	1,0	6,5	25
	W2B12140160000	12	140-160	1,0	6,5	25
	W2B12150170000	12	150-170	1,0	6,5	25
W2B12160180000	12	160-180	1,0	6,5	25	
W2B12170190000	12	170-190	1,0	6,5	25	
W2B12180200000	12	180-200	1,0	6,5	25	

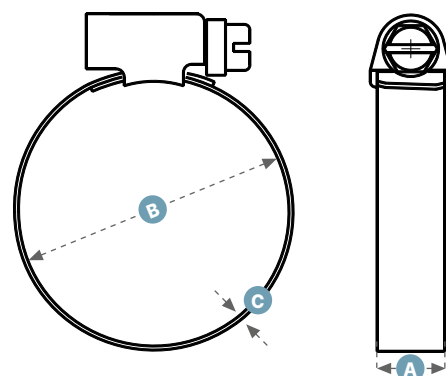

## IMPIEGO APPLICATIONS

Nautica  
Alimentare

Marine  
Food



## DESCRIZIONE DESCRIPTION

Fascetta ad altissima tenuta, compatta e resistente. La banda interna liscia ed i bordi rialzati, conferiscono assoluta sicurezza al tubo, conforme alla normativa DIN 3017.

High resistant clamp, compact and durable. Rolle-up band edges and smooth band underside are able to guarantee total protection to the hose. Conforme to DIN 3017.



## MATERIALE MATERIAL

<b>Banda Band</b>	Acciaio inossidabile Stainless steel <b>AISI 304</b>
<b>Cassetto Housing</b>	Acciaio inossidabile Stainless steel <b>AISI 304</b>
<b>Vite Screw</b>	Acciaio inossidabile Stainless steel <b>AISI 304</b>

LARG. NASTRO BAND WIDTH	DIAM. DIAM.	SPESSORE THICKNESS	COPPIA DI SERRAGGIO RACCOMANDATA RECOMMENDED TIGHTENING TORQUE (PAG. 221)	SCATOLE BOX
<b>A</b>	<b>B</b>	<b>C</b>	<b>Nm</b>	<b>pz/nrm</b>

**9**  
mm

W4A09008012000	9	8-12	0,8	2,6	100
W4A09010016000	9	10-16	0,8	2,6	100
W4A09012020000	9	12-20	0,8	2,6	100
W4A09016025000	9	16-25	0,8	4,0	100
W4A09016027000	9	16-27	0,8	4,0	100
W4A09020032000	9	20-32	0,8	4,0	100
W4A09025040000	9	25-40	0,8	4,0	100
W4A09035050000	9	32-50	0,8	4,0	50
W4A09040060000	9	40-60	0,8	4,0	50
W4A09050070000	9	50-70	0,8	4,0	50
W4A09060080000	9	60-80	0,8	4,0	50
W4A09070090000	9	70-90	0,8	4,0	25
W4A09080100000	9	80-100	0,8	4,0	25
W4A09090110000	9	90-110	0,8	4,0	25
W4A09100120000	9	100-120	0,8	4,0	25
W4A09110130000	9	110-130	0,8	4,0	25
W4A09120140000	9	120-140	0,8	4,0	25
W4A09130150000	9	130-150	0,8	4,0	25

**12**  
mm

W4B12012020000	12	12-20	1,0	6,5	100
W4B12016025000	12	16-25	1,0	6,5	100
W4B12016027000	12	16-27	1,0	6,5	100
W4B12020032000	12	20-32	1,0	6,5	100
W4B12025040000	12	25-40	1,0	6,5	100
W4B12035050000	12	32-50	1,0	6,5	50
W4B12040060000	12	40-60	1,0	6,5	50
W4B12050070000	12	50-70	1,0	6,5	50
W4B12060080000	12	60-80	1,0	6,5	50
W4B12070090000	12	70-90	1,0	6,5	25
W4B12080100000	12	80-100	1,0	6,5	25
W4B12090110000	12	90-110	1,0	6,5	25
W4B12100120000	12	100-120	1,0	6,5	25
W4B12110130000	12	110-130	1,0	6,5	25
W4B12120140000	12	120-140	1,0	6,5	25
W4B12130150000	12	130-150	1,0	6,5	25
W4B12140160000	12	140-160	1,0	6,5	25
W4B12150170000	12	150-170	1,0	6,5	25
W4B12160180000	12	160-180	1,0	6,5	25
W4B12170190000	12	170-190	1,0	6,5	25
W4B12180200000	12	180-200	1,0	6,5	25



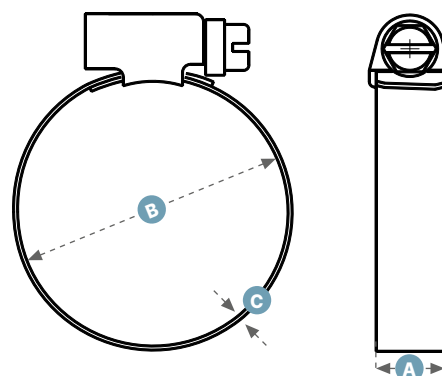

## IMPIEGO APPLICATIONS

Nautica	Marine
Petrochimica	Petrochemical
Alimentare	Food

## DESCRIZIONE DESCRIPTION

Fascetta ad altissima tenuta, compatta e resistente. La banda interna liscia ed i bordi rialzati, conferiscono assoluta sicurezza al tubo. Conforme alla normativa DIN 3017.

High resistant clamp, compact and durable. Rolle-up band edges and smooth band underside are able to guarantee total protection to the hose. Conforme to DIN 3017.

## MATERIALE MATERIAL

<b>Banda</b> Band	Acciaio inossidabile Stainless steel <b>AISI 316</b>
<b>Cassetto</b> Housing	Acciaio inossidabile Stainless steel <b>AISI 316</b>
<b>Vite</b> Screw	Acciaio inossidabile Stainless steel <b>AISI 316</b>

	LARG. NASTRO BAND WIDTH	DIAM. DIAM.	SPESSORE THICKNESS	COPPIA DI SERRAGGIO RACCOMANDATA RECOMMENDED TIGHTENING TORQUE (PAG. 221)	SCATOLE BOX	
	<b>A</b> mm	<b>B</b> mm	<b>C</b> mm	<b>Nm</b>	<b>pz/nrm</b>	
<b>9</b> mm	W5A09008012000	9	8-12	0,8	2,6	100
	W5A09010016000	9	10-16	0,8	2,6	100
	W5A09012020000	9	12-20	0,8	2,6	100
	W5A09016025000	9	16-25	0,8	4,0	100
	W5A09016027000	9	16-27	0,8	4,0	100
	W5A09020032000	9	20-32	0,8	4,0	100
	W5A09025040000	9	25-40	0,8	4,0	100
	W5A09035050000	9	32-50	0,8	4,0	50
	W5A09040060000	9	40-60	0,8	4,0	50
	W5A09050070000	9	50-70	0,8	4,0	50
	W5A09060080000	9	60-80	0,8	4,0	50
	W5A09070090000	9	70-90	0,8	4,0	25
	W5A09080100000	9	80-100	0,8	4,0	25
	W5A09090110000	9	90-110	0,8	4,0	25
	W5A09100120000	9	100-120	0,8	4,0	25
	W5A09011013000	9	110-130	0,8	4,0	25
W5A09012014000	9	120-140	0,8	4,0	25	
W5A09013015000	9	130-150	0,8	4,0	25	
<b>12</b> mm	W5B12012020000	12	12-20	1,0	6,5	100
	W5B12016025000	12	16-25	1,0	6,5	100
	W5B12016027000	12	16-27	1,0	6,5	100
	W5B12020032000	12	20-32	1,0	6,5	100
	W5B12025040000	12	25-40	1,0	6,5	100
	W5B12035050000	12	32-50	1,0	6,5	50
	W5B12040060000	12	40-60	1,0	6,5	50
	W5B12050070000	12	50-70	1,0	6,5	50
	W5B12060080000	12	60-80	1,0	6,5	50
	W5B12070090000	12	70-90	1,0	6,5	25
	W5B12080100000	12	80-100	1,0	6,5	25
	W5B12090110000	12	90-110	1,0	6,5	25
	W5B12100120000	12	100-120	1,0	6,5	25
	W5B12110130000	12	110-130	1,0	6,5	25
	W5B12120140000	12	120-140	1,0	6,5	25
	W5B12130150000	12	130-150	1,0	6,5	25
W5B12140160000	12	140-160	1,0	6,5	25	
W5B12150170000	12	150-170	1,0	6,5	25	
W5B12160180000	12	160-180	1,0	6,5	25	
W5B12170190000	12	170-190	1,0	6,5	25	
W5B12180200000	12	180-200	1,0	6,5	25	

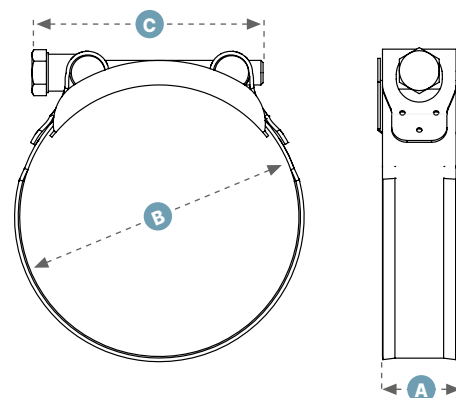

## IMPIEGO APPLICATIONS

Industria in genere Macchine agricole Edilizia Irrigazione	Industry in general Agriculture machine Construction Irrigation
---	--



## DESCRIZIONE DESCRIPTION

Collari ad altissima prestazione. Adatti particolarmente per tubazioni di grosso diametro, molto robuste e rigide. I bordi rialzati, conferiscono assoluta sicurezza al tubo.

High performance collars, compact and durable. Rolle-up band edges are able to guarantee total protection to the hose.



## MATERIALE MATERIAL

<b>Banda Band</b>	Acciaio inossidabile Stainless steel <b>AISI 430</b>
<b>Guida Guide</b>	Acciaio inossidabile Stainless steel <b>AISI 430</b>
<b>Vite Screw</b>	Acciaio zincato Zinc-plated steel

LARG. NASTRO BAND WIDTH	DIAM. DIAM.	SPESSORE THICKNESS	COPPIA DI SERRAGGIO RACCOMANDATA RECOMMENDED TIGHTENING TORQUE (PAG. 221)	SCATOLE BOX
<b>A</b> mm	<b>B</b> mm	<b>C</b> mm	<b>Nm</b>	<b>pz/nrm</b>

### 21 mm

WC221026028000	21	26-28	M6x50	10,4	50
WC221029031000	21	29-31	M6x50	10,4	50
WC221032035000	21	32-35	M6x50	10,4	50
WC221036039000	21	36-39	M6x50	10,4	50
WC221040043000	21	40-43	M6x50	10,4	50
WC221044047000	21	44-47	M6x50	10,4	50
WC221048051000	21	48-51	M6x60	10,4	50
WC221052055000	21	52-55	M6x60	10,4	50
WC221056059000	21	56-59	M6x60	10,4	50
WC221060063000	21	60-63	M6x60	10,4	50
WC221064067000	21	64-67	M6x55	10,4	50

### 24 mm

WC224068073000	24	68-73	M8x70	24,6	25
WC224074079000	24	74-79	M8x70	24,6	25
WC224080085000	24	80-85	M8x70	24,6	25
WC224086091000	24	86-91	M8x80	24,6	25
WC224092097000	24	92-97	M8x80	24,6	25
WC224098103000	24	98-103	M8x80	24,6	25
WC224104112000	24	104-112	M8x90	24,6	25
WC224113121000	24	113-121	M8x90	24,6	25
WC224122130000	24	122-130	M8x90	24,6	25

### 26 mm

WC226131139000	26	131-139	M10x100	50,1	20
WC226140148000	26	140-148	M10x100	50,1	20
WC226149161000	26	149-161	M10x100	50,1	20
WC226162174000	26	162-174	M10x100	50,1	20
WC226175187000	26	175-187	M10x100	50,1	10
WC226188200000	26	188-200	M10x100	50,1	10
WC226201213000	26	201-213	M10x100	50,1	10
WC226214226000	26	214-226	M10x100	50,1	10
WC226227239000	26	227-239	M10x100	50,1	10
WC226240252000	26	240-252	M10x100	50,1	10

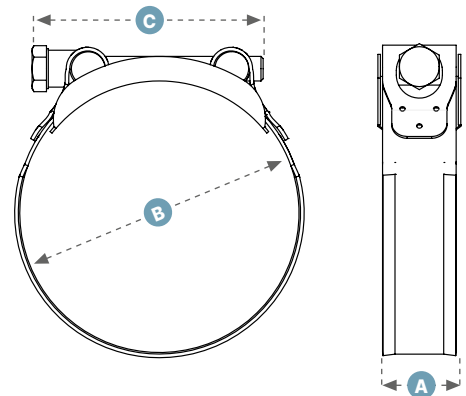

**IMPIEGO APPLICATIONS**

- Nautica Marine
- Petrochimica Petrochemical
- Alimentare Food

**DESCRIZIONE DESCRIPTION**

Collari ad altissima prestazione. Adatti particolarmente per tubazioni di grosso diametro, molto robuste e rigide. I bordi rialzati, conferiscono assoluta sicurezza al tubo.

High performance collars, compact and durable. Rolle-up band edges are able to guarantee total protection to the hose.

**MATERIALE MATERIAL**

<b>Banda Band</b>	Acciaio inossidabile Stainless steel <b>AISI 304</b>
<b>Guida / Guide</b>	Acciaio inossidabile Stainless steel <b>AISI 304</b>
<b>Vite Screw</b>	Acciaio inossidabile Stainless steel <b>AISI 304</b>

	LARG. NASTRO BAND WIDTH	DIAM. DIAM.	SPESSORE THICKNESS	COPPIA DI SERRAGGIO RACCOMANDATA RECOMMENDED TIGHTENING TORQUE (PAG. 221)	SCATOLE BOX	
	<b>A</b> mm	<b>B</b> mm	<b>C</b> mm	<b>Nm</b>	<b>pz/nrm</b>	
<b>21 mm</b>	WC421026028000	21	26-28	M6×50	5,9/10,4	50
	WC421029031000	21	29-31	M6×50	5,9/10,4	50
	WC421032035000	21	32-35	M6×50	5,9/10,4	50
	WC421036039000	21	36-39	M6×50	5,9/10,4	50
	WC421040043000	21	40-43	M6×50	5,9/10,4	50
	WC421044047000	21	44-47	M6×50	5,9/10,4	50
	WC421048051000	21	48-51	M6×60	5,9/10,4	50
	WC421052055000	21	52-55	M6×60	5,9/10,4	50
	WC421056059000	21	56-59	M6×60	5,9/10,4	50
	WC421060063000	21	60-63	M6×60	5,9/10,4	50
WC421064067000	21	64-67	M6×60	5,9/10,4	50	
<b>24 mm</b>	WC424068073000	24	68-73	M8×70	14,5/25,5	25
	WC424074079000	24	74-79	M8×70	14,5/25,5	25
	WC424080085000	24	80-85	M8×70	14,5/25,5	25
	WC424086091000	24	86-91	M8×80	14,5/25,5	25
	WC424092097000	24	93-97	M8×80	14,5/25,5	25
	WC424098103000	24	98-103	M8×80	14,5/25,5	25
	WC424104112000	24	104-112	M8×90	14,5/25,5	25
	WC424113121000	24	113-121	M8×90	14,5/25,5	25
	WC424122130000	24	122-130	M8×90	14,5/25,5	25
	<b>26 mm</b>	WC426131139000	26	131-139	M8×100	14,5/25,5
WC426140148000		26	140-148	M8×100	14,5/25,5	20
WC426149161000		26	149-161	M8×100	14,5/25,5	20
WC426162174000		26	162-174	M8×100	14,5/25,5	20
WC426175187000		26	175-187	M8×100	14,5/25,5	10
WC426188200000		26	188-200	M8×100	14,5/25,5	10
WC426201213000		26	201-213	M8×100	14,5/25,5	10
WC426214226000		26	214-226	M8×100	14,5/25,5	10
WC426227239000		26	227-239	M8×100	14,5/25,5	10
WC426240252000		26	240-252	M8×100	14,5/25,5	10

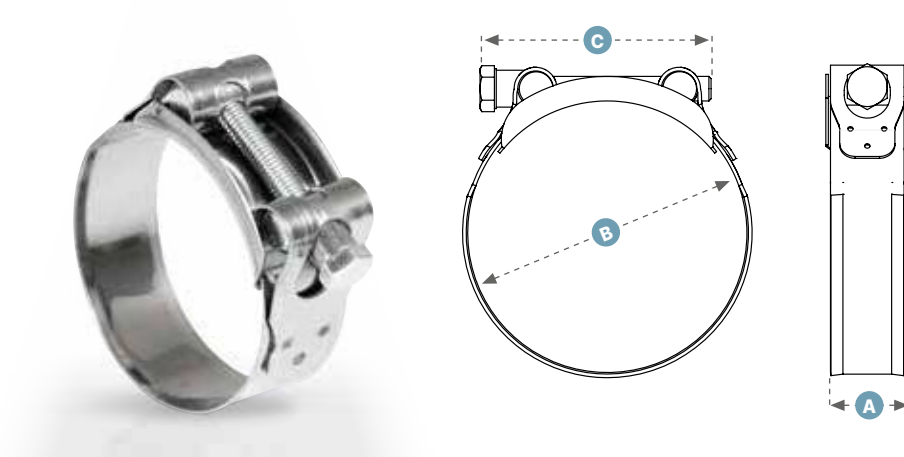

## IMPIEGO APPLICATIONS

Nautica	Marine
Petrolchimica	Petrochemical
Alimentare	Food



## DESCRIZIONE DESCRIPTION

Collari ad altissima prestazione. Adatti particolarmente per tubazioni di grosso diametro, molto robuste e rigide. I bordi rialzati, conferiscono assoluta sicurezza al tubo.

High performance collars, compact and durable. Rolle-up band edges are able to guarantee total protection to the hose.



## MATERIALE MATERIAL

<b>Banda Band</b>	Acciaio inossidabile Stainless steel <b>AISI 316</b>
<b>Guida Guide</b>	Acciaio inossidabile Stainless steel <b>AISI 316</b>
<b>Vite Screw</b>	Acciaio inossidabile Stainless steel <b>AISI 316</b>

LARG. NASTRO BAND WIDTH	DIAM. DIAM.	SPESORE THICKNESS	COPPIA DI SERRAGGIO RACCOMANDATA RECOMMENDED TIGHTENING TORQUE (PAG. 221)	SCATOLE BOX
<b>A</b>	<b>B</b>	<b>C</b>		
mm	mm	mm	Nm	pz/nrm

### 21 mm

WC521023025000	21	23-25	M6	10	50
WC521026028000	21	26-28	M6	10	50
WC521029031000	21	29-31	M6	10	50
WC521032035000	21	32-35	M6	10	50
WC521036039000	21	36-39	M6	10	50
WC521040043000	21	40-43	M6	10	50
WC521044047000	21	44-47	M6	10	50
WC521048051000	21	48-51	M6	10	50
WC521052055000	21	52-55	M6	10	50
WC521056059000	21	56-59	M6	10	50
WC521060063000	21	60-63	M6	10	50
WC521064067000	21	64-67	M6	10	50

### 24 mm

WC524068073000	24	68-73	M8	24	25
WC524074079000	24	74-79	M8	24	25
WC524080085000	24	80-85	M8	24	25
WC524086091000	24	86-91	M8	24	25
WC524092097000	24	92-97	M8	24	25
WC524098103000	24	98-103	M8	24	25
WC524104112000	24	104-112	M8	24	25
WC524113121000	24	113-121	M8	24	25
WC524122130000	24	122-130	M8	24	25

### 26 mm

WC526131139000	26	131-139	M8	24	20
WC526140148000	26	140-148	M8	24	20
WC526149161000	26	149-161	M8	24	20
WC526162174000	26	162-174	M8	24	20
WC526175187000	26	175-187	M8	24	10
WC526188200000	26	188-200	M8	24	10
WC526201213000	26	201-213	M8	24	10
WC526214226000	26	214-226	M8	24	10
WC526227239000	26	227-239	M8	24	10
WC526240252000	26	240-252	M8	24	10

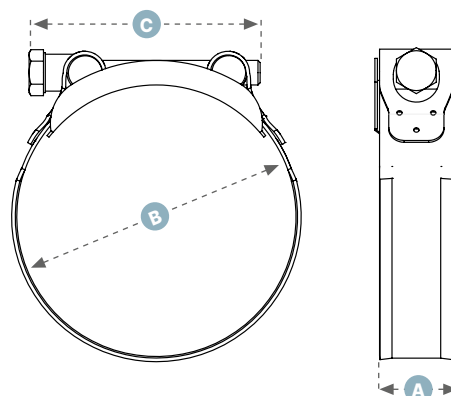

**IMPIEGO APPLICATIONS**

Nautica Marine  
 Petrolchimica Petrochemical  
 Alimentare Food

**DESCRIZIONE DESCRIPTION**

Collari ad altissima prestazione. Adatti particolarmente per tubazioni di grosso diametro, molto robuste e rigide. I bordi rialzati, conferiscono assoluta sicurezza al tubo.

High performance collars, compact and durable. Rolle-up band edges are able to guarantee total protection to the hose.

**MATERIALE MATERIAL**

<b>Banda Band</b>	Acciaio inossidabile Stainless steel <b>AISI 430</b>
<b>Guida Guide</b>	Acciaio inossidabile Stainless steel <b>AISI 430</b>
<b>Vite Screw</b>	Acciaio inossidabile Stainless steel <b>AISI 430</b>

LARG. NASTRO BAND WIDTH	DIAM. DIAM.	SPESSORE THICKNESS	COPPIA DI SERRAGGIO RACCOMANDATA RECOMMENDED TIGHTENING TORQUE (PAG. 221)	SCATOLE BOX
<b>A</b>	<b>B</b>	<b>C</b>	<b>Nm</b>	<b>pz/nrm</b>
mm	mm	mm		

**26**  
mm

WC2C26245260000	26	245-260	M10	24	1
WC2C26250265000	26	250-265	M10	24	1
WC2C26255270000	26	255-270	M10	24	1
WC2C26260275000	26	260-275	M10	24	1
WC2C26265280000	26	265-280	M10	24	1
WC2C26270285000	26	270-285	M10	24	1
WC2C26275290000	26	275-290	M10	24	1
WC2C26280295000	26	280-295	M10	24	1
WC2C26285300000	26	285-300	M10	24	1
WC2C26290305000	26	290-305	M10	24	1
WC2C26295310000	26	295-310	M10	24	1
WC2C26295310000	26	300-315	M10	24	1
WC2C26305320000	26	305-320	M10	24	1
WC2C26310325000	26	310-325	M10	24	1
WC2C26315330000	26	315-330	M10	24	1
WC2C26320335000	26	320-335	M10	24	1
WC2C26325340000	26	325-340	M10	24	1
WC2C26335350000	26	335-350	M10	24	1
WC2C26340355000	26	340-355	M10	24	1
WC2C26345360000	26	345-360	M10	24	1
WC2C26350365000	26	350-365	M10	24	1
WC2C26360375000	26	360-375	M10	24	1
WC2C26375390000	26	375-390	M10	24	1
WC2C26390405000	26	390-405	M10	24	1
WC2C26395410000	26	395-410	M10	24	1
WC2C26400415000	26	400-415	M10	24	1
WC2C26410425000	26	405-420	M10	24	1
WC2C26410425000	26	410-425	M10	24	1
WC2C26415430000	26	415-430	M10	24	1
WC2C26425440000	26	425-440	M10	24	1
WC2C26430445000	26	430-445	M10	24	1
WC2C26435450000	26	435-450	M10	24	1
WC2C26440455000	26	440-455	M10	24	1
WC2C26450465000	26	450-465	M10	24	1
WC2C26465480000	26	465-480	M10	24	1
WC2C26490505000	26	490-505	M10	24	1
WC2C26500515000	26	500-515	M10	24	1
WC2C26510525000	26	510-525	M10	24	1
WC2C26515530000	26	515-530	M10	24	1
WC2C26520535000	26	520-535	M10	24	1
WC2C26535550000	26	535-550	M10	24	1
WC2C26550565000	26	550-565	M10	24	1
WC2C26590605000	26	590-605	M10	24	1
WC2C26600615000	26	600-615	M10	24	1
WC2C26610625000	26	610-625	M10	24	1
WC2C26695710000	26	695-710	M10	24	1
WC2C26700715000	26	700-715	M10	24	1
WC2C26790805000	26	790-805	M10	24	1

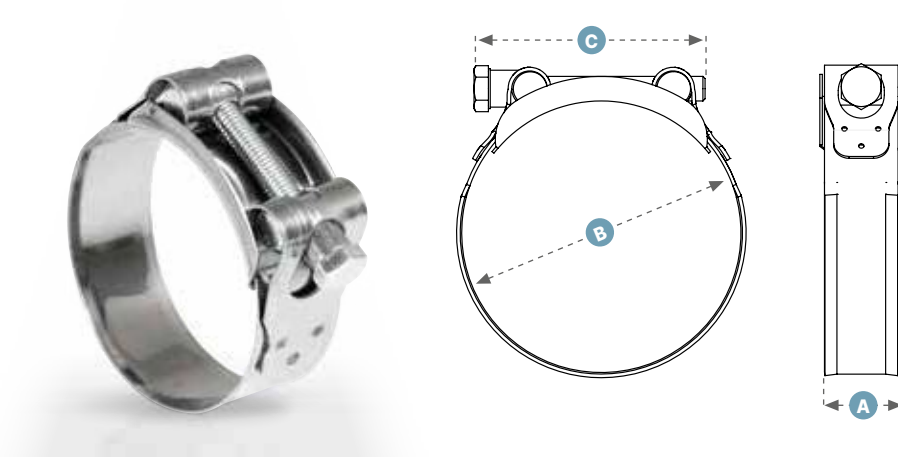

**IMPIEGO  
APPLICATIONS**

Nautica Marine  
Alimentare Food



**DESCRIZIONE  
DESCRIPTION**

Collari ad altissima prestazione. Adatti particolarmente per tubazioni di grosso diametro, molto robuste e rigide. I bordi rialzati, conferiscono assoluta sicurezza al tubo.

High performance collars, compact and durable. Rolle-up band edges are able to guarantee total protection to the hose.



**MATERIALE  
MATERIAL**

<b>Banda Band</b>	Acciaio inossidabile Stainless steel <b>AISI 304</b>
<b>Guida Guide</b>	Acciaio inossidabile Stainless steel <b>AISI 304</b>
<b>Vite Screw</b>	Acciaio inossidabile Stainless steel <b>AISI 304</b>

LARG. NASTRO BAND WIDTH	DIAM. DIAM.	SPESSORE THICKNESS	COPPIA DI SERRAGGIO RACCOMANDATA RECOMMENDED TIGHTENING TORQUE (PAG. 221)	SCATOLE BOX
<b>A</b>	<b>B</b>	<b>C</b>	<b>Nm</b>	<b>pz/nrm</b>
mm	mm	mm		

**26  
mm**

WC4C26245260000	26	245-260	M8	24	1
WC4C26250265000	26	250-265	M8	24	1
WC4C26255270000	26	255-270	M8	24	1
WC4C26260275000	26	260-275	M8	24	1
WC4C26265280000	26	265-280	M8	24	1
WC4C26270285000	26	270-285	M8	24	1
WC4C26275290000	26	275-290	M8	24	1
WC4C26280295000	26	280-295	M8	24	1
WC4C26285300000	26	285-300	M8	24	1
WC4C26290305000	26	290-305	M8	24	1
WC4C26295310000	26	295-310	M8	24	1
WC4C26295310000	26	300-315	M8	24	1
WC4C26305320000	26	305-320	M8	24	1
WC4C26310325000	26	310-325	M8	24	1
WC4C26315330000	26	315-330	M8	24	1
WC4C26320335000	26	320-335	M8	24	1
WC4C26325340000	26	325-340	M8	24	1
WC4C26335350000	26	335-350	M8	24	1
WC4C26340355000	26	340-355	M8	24	1
WC4C26345360000	26	345-360	M8	24	1
WC4C26350365000	26	350-365	M8	24	1
WC4C26360375000	26	360-375	M8	24	1
WC4C26375390000	26	375-390	M8	24	1
WC4C26390405000	26	390-405	M8	24	1
WC4C26395410000	26	395-410	M8	24	1
WC4C26400415000	26	400-415	M8	24	1
WC4C26410425000	26	405-420	M8	24	1
WC4C26410425000	26	410-425	M8	24	1
WC4C26415430000	26	415-430	M8	24	1
WC4C26425440000	26	425-440	M8	24	1
WC4C26430445000	26	430-445	M8	24	1
WC4C26435450000	26	435-450	M8	24	1
WC4C26440455000	26	440-455	M8	24	1
WC4C26450465000	26	450-465	M8	24	1
WC4C26465480000	26	465-480	M8	24	1
WC4C26490505000	26	490-505	M8	24	1
WC4C26500515000	26	500-515	M8	24	1
WC4C26510525000	26	510-525	M8	24	1
WC4C26515530000	26	515-530	M8	24	1
WC4C26520535000	26	520-535	M8	24	1
WC4C26535550000	26	535-550	M8	24	1
WC4C26550565000	26	550-565	M8	24	1
WC4C26590605000	26	590-605	M8	24	1
WC4C26600615000	26	600-615	M8	24	1
WC4C26610625000	26	610-625	M8	24	1
WC4C26695710000	26	695-710	M8	24	1
WC4C26700715000	26	700-715	M8	24	1
WC4C26790805000	26	790-805	M8	24	1

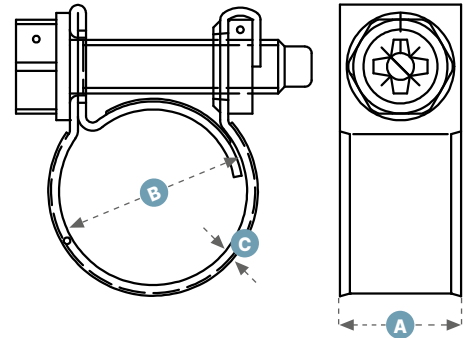

## IMPIEGO APPLICATIONS

Industria in genere	Industry in general
Macchine agricole	Agriculture machine
Ciclomotori	Motorcycles
Automotive	Automotive



## DESCRIZIONE DESCRIPTION

Il collare benzina mini ha un nastro a bordi rialzati per non danneggiare il tubo. La linguetta inferiore è munita di rinforzo. Un altro dettaglio pratico è la testa esagonale della vite, dotata di intaglio e adatta per l'utilizzo di un cacciavite flessibile. È particolarmente indicato per tubi di piccolo diametro e di spessore ridotto.

This clamp features rolled-up band edges that are gentle on hoses. The band tongue that fits under the hose is profiled for added strength.



## MATERIALE MATERIAL

<b>Banda Band</b>	Acciaio zincato Zinc-plated steel
<b>Chiave Bolt</b>	<b>7 mm</b>
<b>Vite Screw</b>	Acciaio zincato Zinc-plated steel <b>AISI 430</b>

LARG. NASTRO BAND WIDTH	DIAM. DIAM.	SPESSORE THICKNESS	COPPIA DI SERRAGGIO RACCOMANDATA RECOMMENDED TIGHTENING TORQUE (PAG. 221)	SCATOLE BOX
<b>A</b>	<b>B</b>	<b>C</b>	<b>Nm</b>	<b>pz/nrm</b>
mm	mm	mm		

**9  
mm**

WCM007009	9	7-9	0,6	1,2	2000
WCM009010	9	9-10	0,6	1,2	2000
WCM100000	9	8,5-11	0,6	1,2	2000
WCM110000	9	9,5-12	0,6	1,2	2000
WCM120000	9	11-13	0,6	1,2	3000
WCM130000	9	11,5-14	0,6	1,2	3000
WCM140000	9	13-15	0,6	1,2	3000
WCM150000	9	14-16	0,6	1,2	3000
WCM160000	9	15-17	0,6	1,2	3000
WCM170000	9	16-18	0,6	1,2	2500
WCM180000	9	17-19	0,6	1,2	2500
WCM190000	9	18-21	0,6	1,2	2500
WCM200000	9	19-21	0,6	1,2	2500
WCM290000	9	24-29	0,6	1,2	1200

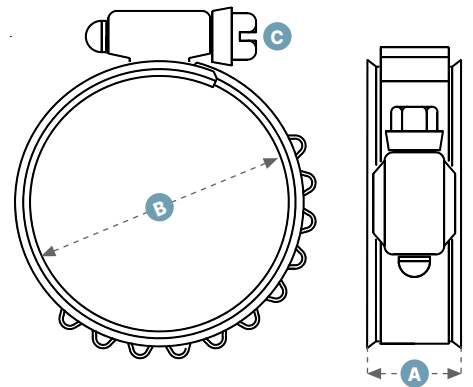

**IMPIEGO  
APPLICATIONS**

Industria in genere	Industry in general
Macchine agricole	Agriculture machine
Edilizia	Construction
Nautica	Marine
Militare	Military
Automotive	Automotive



**DESCRIZIONE  
DESCRIPTION**

Le fascette con anello interno SAE tipo T WTS hanno una perfetta tenuta in applicazioni su manicotti soggetti a dilatazioni termiche e rilassamento del tubo. La particolare costruzione garantisce una tensione costante grazie all'effetto combinato dell'anello interno e della banda convoluta. La finitura superficiale con elettrolucidatura garantisce una migliore resistenza alla corrosione.

With a convoluted heat-treated band that provides spring-like tensioning effects for thermal cycling hose applications. This clamp concentrates band-sealing pressure, increasing performance up to 30% compared to standard smooth liners. Flanged edges protect soft hose compounds from abrasion and wear.



**MATERIALE  
MATERIAL**

<b>Banda</b> Band	Acciaio inossidabile Stainless steel <b>AISI 304</b>
<b>Cassetto</b> Housing	Acciaio inossidabile Stainless steel <b>SERIES 300</b>
<b>Vite</b> Screw	Acciaio inossidabile Stainless steel <b>SERIES 300</b>

	LARG. NASTRO BAND WIDTH	DIAM. DIAM.	SPESSORE THICKNESS	COPPIA DI SERRAGGIO RACCOMANDATA RECOMMENDED TIGHTENING TORQUE (PAG. 221)	SCATOLE BOX
	<b>A</b> mm	<b>B</b> mm	<b>C</b> mm	<b>Nm</b>	<b>pz/nrm</b>

**16  
mm**

WTS028038	16,51	28-38	8	5,6	400
WTS030041	16,51	30-41	8	5,6	400
WTS035048	16,51	35-48	8	5,6	400
WTS040054	16,51	40-54	8	5,6	300
WTS041060	16,51	41-60	8	5,6	300
WTS046067	16,51	46-67	8	5,6	200
WTS050073	16,51	50-73	8	5,6	200
WTS057079	16,51	57-79	8	5,6	200
WTS064086	16,51	64-86	8	5,6	200
WTS070092	16,51	70-92	8	5,6	200
WTS076098	16,51	76-98	8	5,6	200
WTS083105	16,51	83-105	8	5,6	200
WTS089111	16,51	89-111	8	5,6	200
WTS095118	16,51	95-118	8	5,6	200
WTS108130	16,51	108-130	8	5,6	200
WTS121143	16,51	121-143	8	5,6	100
WTS146148	16,51	146-168	8	5,6	100
WTS159181	16,51	159-181	8	5,6	100
WTS184206	16,51	184-206	8	5,6	100



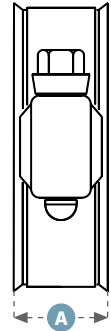
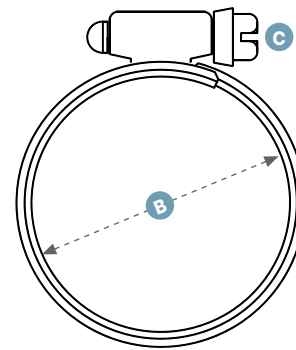

### IMPIEGO APPLICATIONS

Industria in genere	Industry in general
Macchine agricole	Agriculture machine
Edilizia	Construction
Ciclomotori	Motorcycles
Automotive	Automotive



### DESCRIZIONE DESCRIPTION

Le fascette con anello interno SAE tipo F WDB sono particolarmente indicate per i circuiti di raffreddamento. L'anello interno garantisce una tenuta sicura su tubi in materiali morbidi creando un effetto oring tra fascetta, tubo e portagomma.

For air to air and coolant applications. The inner shield provides superb sealing characteristics and is safe for all soft hoses. It can also be found in the marine, agriculture, construction and off-highway markets.

LARG. NASTRO BAND WIDTH	DIAM. DIAM.	SPESSORE THICKNESS	COPPIA DI SERRAGGIO RACCOMANDATA RECOMMENDED TIGHTENING TORQUE (PAG. 221)	SCATOLE BOX
<b>A</b>	<b>B</b>	<b>C</b>	<b>Nm</b>	<b>pz/nrm</b>
<b>mm</b>	<b>mm</b>	<b>mm</b>		

# 16 mm

WDB015034	16,51	15,9-34,9	8	3,4-4,5	400
WDB017041	16,51	17,5-41,4	8	3,4-4,5	400
WDB023047	16,51	23,8-47,6	8	3,4-4,5	400
WDB030054	16,51	30,2-54,0	8	3,4-4,5	400
WDB036060	16,51	36,5-60,3	8	3,4-4,5	300
WDB042066	16,51	42,9-66,7	8	3,4-4,5	300
WDB049073	16,51	49,2-73,0	8	3,4-4,5	300
WDB055079	16,51	55,6-79,4	8	3,4-4,5	300
WDB061085	16,51	61,9-85,7	8	3,4-4,5	300
WDB068092	16,51	68,3-92,1	8	3,4-4,5	300
WDB074098	16,51	74,6-98,4	8	3,4-4,5	200
WDB087111	16,51	87,3-111,1	8	3,4-4,5	200
WDB100123	16,51	100,0-123,8	8	3,4-4,5	200
WDB112136	16,51	112,7-136,5	8	3,4-4,5	200



### MATERIALE MATERIAL

<b>Banda</b> Band	Acciaio inossidabile Stainless steel <b>AISI 304</b>
<b>Cassetto</b> Housing	Acciaio inossidabile Stainless steel <b>SERIES 300</b>
<b>Vite</b> Screw	Acciaio inossidabile Stainless steel <b>SERIES 300</b>

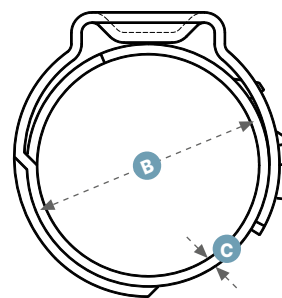

## IMPIEGO APPLICATIONS

Nautica	Marine
Petrolchimica	Petrochemical
Ciclomotori	Motorcycles
Automotive	Automotive
Alimentare	Food
Beverage	Beverage



## DESCRIZIONE DESCRIPTION

Le fascette pinzabili antigrinza WGT offrono facilità e velocità di montaggio e grazie alla loro costruzione, permettono un contatto a 360° con il tubo eliminando possibili punti di trafilamento. La fascetta è realizzata in acciaio inox AISI 304. Ideali per applicazioni su linee benzina, beverage, medicale e industria in genere.

These clamps offer 360° seamless fastening. Due to their seamless design and uniform compression sealing, these clamps are often used in the beverage, automotive, marine, and motorcycle industries. They are manufactured using 304 Stainless Steel and are perfect for poly and braided tubing.



## MATERIALE MATERIAL

<b>Banda Band</b>	<b>Acciaio inossidabile Stainless steel AISI 304</b>
-------------------	--

LARG. NASTRO BAND WIDTH	DIAM. DIAM.	SPESORE THICKNESS	SCATOLE BOX
<b>A</b>	<b>B</b>	<b>C</b>	
<b>mm</b>	<b>mm</b>	<b>mm</b>	<b>pz/nrm</b>

**5  
mm**

WGT05070	5	5,8-7,0	0,48	2500
WGT05080	5	6,8-8,0	0,48	2500
WGT05087	5	7,0-8,7	0,48	2500
WGT05090	5	7,3-9,0	0,48	2500
WGT05095	5	7,8-9,5	0,48	2500
WGT05100	5	8,3-10,0	0,48	2500
WGT05105	5	8,8-10,5	0,48	2500
WGT05109	5	9,2-10,9	0,48	2500
WGT05113	5	9,6-11,3	0,48	2500
WGT05118	5	10,1-11,8	0,48	2500

**7  
mm**

WGT07123	7	9,8-12,3	0,56	2500
WGT07128	7	10,3-12,8	0,56	2500
WGT07133	7	10,8-13,3	0,56	2500
WGT07138	7	11,3-13,8	0,56	2500
WGT07140	7	11,5-14,0	0,56	2500
WGT07145	7	12,0-14,5	0,56	2500
WGT07148	7	12,3-14,8	0,56	2500
WGT07153	7	12,8-15,3	0,56	2500
WGT07127	7	13,2-15,7	0,56	2500
WGT07162	7	13,7-16,2	0,56	2500
WGT07164	7	13,9-16,4	0,56	2500
WGT07170	7	14,5-17,0	0,56	2500
WGT07180	7	15,5-18,0	0,56	2500
WGT07185	7	16,0-18,5	0,56	2500
WGT07192	7	16,0-19,2	0,56	A RICHIESTA ON DEMAND
WGT07198	7	16,6-19,8	0,56	A RICHIESTA ON DEMAND
WGT07210	7	17,8-21,0	0,56	A RICHIESTA ON DEMAND
WGT07226	7	19,4-22,6	0,56	A RICHIESTA ON DEMAND
WGT07235	7	20,3-23,5	0,56	A RICHIESTA ON DEMAND
WGT07241	7	20,9-24,1	0,56	A RICHIESTA ON DEMAND
WGT07256	7	22,4-25,6	0,56	A RICHIESTA ON DEMAND
WGT07271	7	23,9-27,1	0,56	A RICHIESTA ON DEMAND
WGT07286	7	25,4-28,6	0,56	A RICHIESTA ON DEMAND
WGT07301	7	26,9-30,1	0,56	A RICHIESTA ON DEMAND
WGT07308	7	27,6-30,8	0,56	A RICHIESTA ON DEMAND
WGT07316	7	28,4-31,6	0,56	A RICHIESTA ON DEMAND
WGT07331	7	29,9-33,1	0,56	A RICHIESTA ON DEMAND
WGT07346	7	31,4-34,6	0,56	A RICHIESTA ON DEMAND
WGT07361	7	32,9-36,1	0,56	A RICHIESTA ON DEMAND
WGT07376	7	34,4-37,6	0,56	A RICHIESTA ON DEMAND
WGT07381	7	34,9-38,1	0,56	A RICHIESTA ON DEMAND
WGT07396	7	36,4-39,6	0,56	A RICHIESTA ON DEMAND
WGT07410	7	37,8-41,0	0,56	A RICHIESTA ON DEMAND
WGT07455	7	42,3-45,5	0,56	A RICHIESTA ON DEMAND

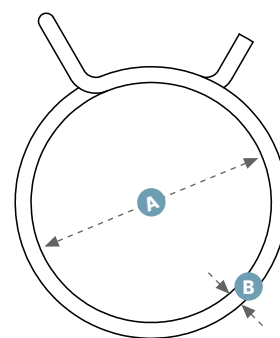

## IMPIEGO APPLICATIONS

Industria in genere	Industry in general
Ciclomotori	Motorcycles
Automotive	Automotive



## DESCRIZIONE DESCRIPTION

Fascette realizzate con un doppio filo di acciaio zincato; l'elasticità del materiale è in grado di compensare piccole variazioni diametrali. Ideali su tubi di spessori molto sottili e per tenute non gravose. Si raccomanda di utilizzare raccordi con rilievi sufficienti a contrastare il carico della fascetta ed evitare lo sfilamento del tubo.

Clamps made in double zinc-plated steel wire. Recommended on hoses of very thin thickness and for light-duty works.



## MATERIALE MATERIAL

Banda Band	Filo acciaio zincato Wire zinc-plated steel
------------	---

	DIAM. DIAM.	Ø FILO Ø WIRE	SCATOLE BOX	SCATOLE BOX	SCATOLE BOX
	A mm	B mm	pz/nrm	pz/nrm	pz/nrm
WBS056007	6,6-7	1,0	25000	8300	2500
WBS070075	7-7,5	1,0	20000	8300	2000
WBS073078	7,3-7,8	1,0	20000	8300	2000
WBS078083	7,8-8,3	1,0	20000	8300	2000
WBS083088	8,3-8,8	1,0	12000	6600	1200
WBS088093	8,8-9,3	1,0	15000	5000	1500
WBS093098	9,3-9,8	1,0	15000	5000	1500
WBS098104	9,8-10,4	1,2	10000	3300	1000
WBS104110	10,4-11	1,2	10000	3300	1000
WBS110116	11-11,6	1,2	9000	3300	900
WBS116122	11,6-12,2	1,5	6000	2000	600
WBS122129	12,2-12,9	1,5	5000	2000	500
WBS124131	12,4-13,10	1,2	7000	2000	700
WBS129136	12,9-13,6	1,5	4500	2000	400
WBS133141	13,3-14,1	1,5	4000	1300	400
WBS136144	13,6-14,4	1,5	4000	1300	400
WBS144151	14,4-15,10	1,8	3000	1300	300
WBS148159	14,8-15,9	1,6	3500	1300	300
WBS151159	15,10-15,9	1,8	3000	1000	300
WBS154162	15,4-16,2	1,8	3000	1000	300
WBS159168	15,9-16,8	1,8	3000	1000	300
WBS168177	16,8-17,7	1,8	3000	1000	300
WBS177187	17,7-18,7	1,9	2200	700	200
WBS187195	18,7-19,5	2,0	2000	700	200
WBS196205	19,6-20,5	2,0	1500	700	200
WBS206216	20,6-21,6	2,0	1500	700	200
WBS215226	21,5-22,6	2,2	1300	500	100
WBS220231	22,0-23,1	2,2	1300	500	100
WBS224236	22,4-23,6	2,2	1200	400	100
WBS235247	23,5-24,7	2,2	1200	400	100
WBS245258	24,5-25,8	2,5	1000	300	100
WBS251264	25,1-26,4	2,5	900	300	100
WBS256269	25,6-26,9	2,5	800	300	100
WBS267281	26,7-28,1	2,5	750	250	100
WBS279294	27,9-29,4	2,5	750	250	100
WBS293309	29,3-30,9	2,8	750	200	100
WBS304320	30,4-32	2,8	500	200	100
WBS318334	31,8-33,4	2,8	500	200	100
WBS332348	33,2-34,8	2,8	450	200	100
WBS339357	33,9-35,7	2,8	500	200	100
WBS346364	34,6-36,4	3,0	450	200	100
WBS362380	36,2-38	3,0	450	200	100
WBS377397	37,7-39,7	3,2	400	200	100
WBS385405	38,5-40,5	3,2	400	200	100
WBS389408	38,9-40,8	3,2	350	-	-
WBS394414	39,4-41,4	3,2	350	-	-
WBS407423	40,7-42,3	3,2	350	-	-
WBS410432	41-43,2	3,2	300	-	-
WBS428450	42,8-45	3,2	300	-	-
WBS446468	44,6-46,8	3,2	300	-	-
WBS465489	46,5-48,9	3,2	300	-	-
WBS488509	48,8-50,9	3,5	200	-	-
WBS506532	50,6-53,2	3,5	200	-	-
WBS527554	52,7-55,4	3,5	200	-	-
WBS560588	56-58,8	3,5	150	-	-
WBS582610	58,2-61	3,5	150	-	-

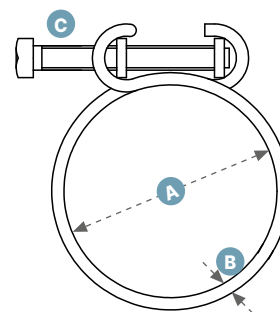

## IMPIEGO APPLICATIONS

Industria in genere  
Automotive

Industry in general  
Automotive



## DESCRIZIONE DESCRIPTION

Fascette consigliate per serrare tubi con spirali in rilievo. Sono realizzate con un doppio filo di acciaio zincato e garantiscono un serraggio ottimale anche in presenza di tubi molto morbidi e con spessori sottili.

Recommended for hoses with spirals in relief. The clamps are made with a double zinc-plated steel wire and they grant optimal clamping also on soft and thin hoses.



## MATERIALE MATERIAL

Banda Band      Acciaio zincato  
Zinc-plated steel

LARG. NASTRO  
BAND WIDTH

DIAM.  
DIAM.

SPESORE  
THICKNESS

SCATOLE  
BOX

	A mm	B mm	C mm	pz/nrm
WBV012000	9,5-12	1,5	M3	2500
WBV013000	10,5-13	1,5	M3	2500
WBV014000	11,5-14	1,5	M3	2500
WBV015000	12,5-15	1,5	M3	2500
WBV016000	13-16	1,8	M3	3000
WBV017000	13,5-17	1,8	M3	3000
WBV018000	15-18	1,8	M3	3000
WBV019000	15,5-19	1,8	M3	2500
WBV020000	17-20	1,8	M3	2500
WBV021000	17,5-21	1,8	M3	2000
WBV022000	18,5-22	2,0	M4	1500
WBV023000	19-23	2,0	M4	1500
WBV025000	21,5-25	2,0	M4	1500
WBV027000	23,5-27	2,2	M4	1500
WBV029000	25-29	2,2	M4	1000
WBV031000	27-31	2,2	M4	1000
WBV033000	29-33	2,2	M4	1000
WBV035000	30,5-35	2,2	M4	1000
WBV037000	33-37	2,2	M4	1000
WBV040000	35,5-40	2,2	M4	800
WBV043000	38,5-43	2,2	M4	800
WBV046000	41-46	2,5	M5	500
WBV049000	43,5-49	2,5	M5	500
WBV053000	46,5-53	2,5	M5	400
WBV056000	50,5-56	2,5	M5	400
WBV060000	53,5-60	2,5	M6	400
WBV064000	56,5-64	2,8	M6	A RICHIESTA ON DEMAND
WBV068000	60-68	2,8	M6	A RICHIESTA ON DEMAND
WBV072000	64-72	2,8	M6	A RICHIESTA ON DEMAND
WBV076000	68,5-76	2,8	M6	A RICHIESTA ON DEMAND
WBV080000	72,5-80	3,0	M6	A RICHIESTA ON DEMAND
WBV084000	76,5-84	3,0	M6	A RICHIESTA ON DEMAND
WBV088000	80-88	3,0	M6	A RICHIESTA ON DEMAND
WBV096000	88-96	3,0	M6	A RICHIESTA ON DEMAND
WBV100000	92-100	3,0	M6	A RICHIESTA ON DEMAND
WBV104000	95-104	3,0	M6	A RICHIESTA ON DEMAND
WBV108000	98-108	3,0	M6	A RICHIESTA ON DEMAND
WBV112000	103-112	3,0	M6	A RICHIESTA ON DEMAND
WBV116000	109-116	3,0	M6	A RICHIESTA ON DEMAND
WBV120000	111-120	3,0	M6	A RICHIESTA ON DEMAND
WBV124000	115-124	3,0	M6	A RICHIESTA ON DEMAND
WBV128000	120-128	3,0	M6	A RICHIESTA ON DEMAND
WBV132000	124-132	3,0	M6	A RICHIESTA ON DEMAND
WBV140000	125-140	3,0	M6	A RICHIESTA ON DEMAND
WBV150000	134-150	3,0	M6	A RICHIESTA ON DEMAND
WBV160000	145-160	3,0	M6	A RICHIESTA ON DEMAND
WBV165000	150-165	3,0	M6	A RICHIESTA ON DEMAND
WBV170000	155-170	3,0	M6	A RICHIESTA ON DEMAND
WBV180000	165-180	3,0	M6	A RICHIESTA ON DEMAND
WBV190000	175-190	3,0	M6	A RICHIESTA ON DEMAND

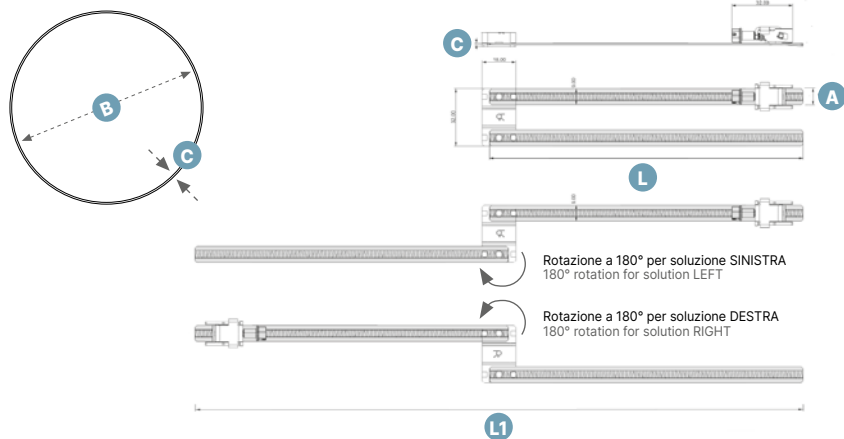
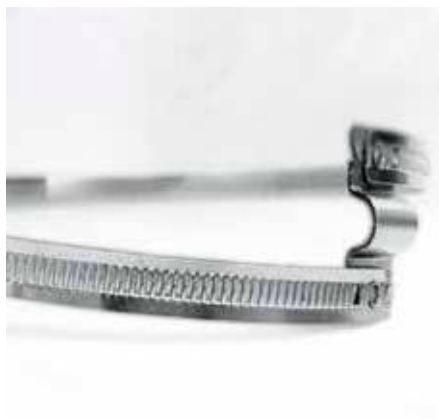

	LARG. NASTRO BAND WIDTH	DIAM. DIAM.	SPESSORE THICKNESS	LUNGHEZZA FASCETTA CHIUSA-APERTA LENGHT CLOSED LENGHT OPEN	COPPIA DI SERRAGGIO RACCOMANDATA RECOMMENDED TIGHTENING TORQUE (PAG. 221)	SCATOLE BOX
	<b>A</b>	<b>B</b>	<b>C</b>	<b>L - L1</b>	<b>Nm</b>	<b>pz/nrm</b>
	mm	mm	mm	mm		
<b>WSS06013500000</b>	9,0	60 - 135	0,6	211 - 425	3,5	25
<b>WSS10017500000</b>	9,0	100-175	0,6	274 - 550	3,5	25
<b>WSS12522500000</b>	9,0	125-225	0,6	355 - 710	3,5	25
<b>WSS15828500000</b>	9,0	158 - 285	0,6	450 - 900	3,5	25
<b>WSS17531500000</b>	9,0	175 - 315	0,6	500 - 1000	3,5	25
<b>WSS19535000000</b>	9,0	195 - 350	0,6	550 - 1100	3,5	25
<b>WSS21338500000</b>	9,0	213 - 385	0,6	610 - 1220	3,5	25
<b>WSS24043500000</b>	9,0	240 - 435	0,6	700 - 1400	3,5	25
<b>WSS27048500000</b>	9,0	270 - 485	0,6	775 - 1550	3,5	25
<b>WSS29553500000</b>	9,0	295 - 535	0,6	850 - 1700	3,5	25



## IMPIEGO APPLICATIONS

Industria in genere	Industry in general
Macchine agricole	Agriculture machine
Edilizia	Construction
Alimentare	Food



## DESCRIZIONE DESCRIPTION

Rivoluzionaria fascetta per il serraggio del tubo spiralato, la fascetta SSS, grazie al nuovo sistema brevettato può essere utilizzata sia per tubi con spirale destrorsa che sinistrorsa. Effettuando l'operazione di rotazione sul perno centrale del ponticello di una delle due bande, l'operatore può ottenere la fascetta da utilizzare su tubo con spirale destra oppure sinistra. Inoltre, la banda zigrinata sull'intera lunghezza della fascetta permette di coprire un vasto range di diametri diminuendo drasticamente la gestione dei codici di approvvigionamento a magazzino. Infine, l'assenza di saldature, garantisce una performance eccellente di tenuta della fascetta.

Revolutionary hose clamp for the tightening of the spiral pipe, thanks to the new system patented it can be used for both the right and left spiral tubes. With the rotation operation on the central pin of the bridge by one of the two bands, the operator can obtain the band to be used on the tube with right or left spiral, moreover, the knurled band on the whole length of the band allows to cover a wide range of diameters drastically reducing the management of the codes to warehouse. Finally the absence of welding guarantees an excellent performance of Tightening torque (pag. 221).



## MATERIALE MATERIAL

<b>Banda Band</b>	Acciaio inossidabile Stainless steel <b>AISI 430</b>
<b>Cassetto Housing</b>	Acciaio inossidabile Stainless steel <b>AISI 430</b>
<b>Vite Screw</b>	Acciaio zincato Zinc-plated steel

## CARATTERISTICHE FISICO MECCANICHE PHYSICAL AND MECHANICAL PROPERTIES

	<b>W2</b>
STRUTTURA Structure	Ferrit.
CARICO DI ROTTURA Breaking Load Rp 0,2 (N/mm <sup>2</sup> ) min	280
Rm (N/mm <sup>2</sup> ) min.	450-600
MODULO DI ELASTICITÀ A 20°C Elasticity in tensions at 20°C (kN/mm <sup>2</sup> )	220
ALLUNGAMENTO Elongation (min)	20
COEFFICIENTE DI DILATAZIONE TERMICA Coefficient of thermal expansions 20 ÷ 200°C	10
CONDUTTIVITÀ TERMICA A 20°C Thermal conductivity at 20°C (W/m x K)	25
RESISTENZA ALLA CORROSIONE Corrosion resistance	PREN* 16.00 - 18.00

## INFORMAZIONI TECNICHE TECHNICAL INFORMATION

TEMPERATURA DI ESERCIZIO Working temp.	-80°C to 538°C
INFIAMMABILITÀ Flammability	Ignifugo Fireproof
PROPRIETÀ ELETTROMAGNETICHE Electromagnetic prop.	Magnetico Magnetic
ALTRE Others	Resistente ai raggi UV UV resistant

## TABELLA MATERIALI IN ACCORDO NORMA DIN 3017 E PRINCIPALI STANDARD INTERNAZIONALI TABLE OF MATERIALS ACCORDING TO DIN 3017 AND MAIN INTERNATIONAL STANDARDS

MATERIALE Material	ITALY UNI	DE WNDIN	UK B.S	FRANCE AFNOR	USA AISI-SAE
RESISTENZA NEBBIA SALINA Hour corrosion in salt spray (min.h)					72 H

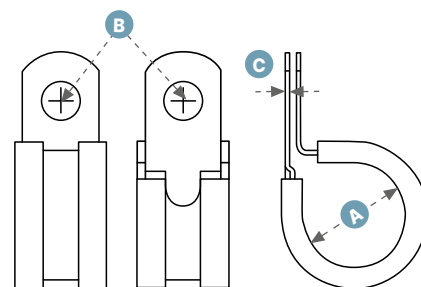

### IMPIEGO APPLICATIONS

Industria in genere	Industry in general
Macchine agricole	Agriculture machine
Nautica	Marine
Automotive	Automotive



### DESCRIZIONE DESCRIPTION

Realizzati in acciaio zincato sagomato e ricoperto in materiale antivibrante, per assicurare e garantire protezione ottimale dei cavi/tubi contenuti nei passacavi stessi e l'assorbimento di eventuali vibrazioni. Banda rinforzata in corrispondenza del foro d'attacco. Conforme alla normativa DIN 3016.

Reinforcement band and strip in shaped galvanized steel coated with anti-vibration rubber to ensure optimal protection of the cables/ pipes contained in the cable glands with the absorption of any vibrations. Manufactured according to DIN3016.



### MATERIALE MATERIAL

<b>Banda Band</b>	Acciaio zincato Zinc-plated steel
<b>Rivestimento Coating</b>	Gomma EPDM EPDM rubber

DIAM. DIAM.	FORO ATTACCO HOLE DIAM.	SPESSORE BANDA BAND THICKNESS	SCATOLE BOX
<b>A</b>	<b>B</b>	<b>C</b>	
mm	mm	mm	pz/nrm

## 15 mm

WCGC115006	6	6,4	0,6	100
WCGC115008	8	6,4	0,6	100
WCGC115010	10	6,4	0,6	100
WCGC115012	12	6,4	0,6	100
WCGC115014	14	6,4	0,6	100
WCGC115015	15	6,4	0,8	100
WCGC115016	16	6,4	0,8	100
WCGC115018	18	6,4	0,8	100
WCGC115020	20	6,4	0,8	100
WCGC115022	22	6,4	0,8	100
WCGC115024	24	6,4	0,8	100
WCGC115025	25	6,4	0,8	100
WCGC115028	28	6,4	0,8	100
WCGC115030	30	6,4	0,8	100
WCGC115032	32	6,4	0,8	100
WCGC115035	35	6,4	0,8	100
WCGC115038	38	6,4	0,8	100
WCGC115040	40	6,4	0,8	100

## 20 mm

WCGC120010	10	8,4	0,8	50
WCGC120011	11	8,4	0,8	50
WCGC120012	12	8,4	0,8	50
WCGC120013	13	8,4	0,8	50
WCGC120014	14	8,4	0,8	50
WCGC120015	15	8,4	0,8	50
WCGC120016	16	8,4	0,8	50
WCGC120017	17	8,4	0,8	50
WCGC120018	18	8,4	0,8	50
WCGC120020	20	8,4	0,8	50
WCGC120022	22	8,4	0,8	50
WCGC120024	24	8,4	0,8	50
WCGC120025	25	8,4	0,8	50
WCGC120026	26	8,4	1,0	50
WCGC120028	28	8,4	1,0	50
WCGC120030	30	8,4	1,0	50
WCGC120032	32	8,4	1,0	50
WCGC120034	34	8,4	1,0	50
WCGC120035	35	8,4	1,0	50
WCGC120036	36	8,4	1,0	50
WCGC120038	38	8,4	1,0	50
WCGC120040	40	8,4	1,0	50
WCGC120042	42	8,4	1,0	50
WCGC120044	44	8,4	1,0	50
WCGC120046	46	8,4	1,0	50
WCGC120048	48	8,4	1,0	50
WCGC120050	50	8,4	1,0	50
WCGC120052	52	8,4	1,0	50
WCGC120054	54	8,4	1,0	50
WCGC120056	56	8,4	1,0	50
WCGC120058	58	8,4	1,0	50
WCGC120060	60	8,4	1,0	50
WCGC120062	62	8,4	1,0	50

### SNA

NASTRI BANDI-BLOCK  
BANDS BANDI-BLOCK

Realizzati in acciaio austenitico, in rotoli da 30 e 50 m confezionati in scatole di cartone.

Austenitic stainless steel Bands in 30 and 50 m rolls, packed in stout cardboard box.



Industria in genere  
Irrigazione  
Nautica  
Petrochimica

Industry in general  
Irrigation  
Marine  
Petrochemical

MATERIALE MATERIAL	CODICE CODE	LARGHEZZA WIDTH	SPESSORE THICKNESS	CARICO MEDIO DI ROTTURA AVERAGE BREAKING STRENGTH	SCATOLE BOX	PESO WEIGHT
		mm	mm	kg	mt/cad	kg/cad
Acciaio inox Stainless steel AISI 201	WNA095201	9,50	0,65	410	30	1,5
	WNA127201	12,70	0,75	680	30	2,3
	WNA158201	15,80	0,75	850	30	2,9
	WNA195201	19,05	0,75	1020	30	3,5
Acciaio inox Stainless steel AISI 304	WNA095304	9,50	0,65	390	30	1,5
	WNA127304	12,70	0,75	500	30	2,3
	WNA158304	15,80	0,75	650	30	2,9
	WNA195304	19,05	0,75	950	30	3,5
Acciaio inox Stainless steel AISI 316	WNA095316	9,50	0,65	340	30	1,5
	WNA127316	12,70	0,75	540	30	2,3
	WNA158316	15,80	0,75	680	30	2,9
	WNA195316	19,05	0,75	820	30	3,5

### SNG

GRAFFE BANDI-BLOCK  
BUCKLES BANDI-BLOCK

Realizzate in acciaio inox austenitico, confezionate in scatole di cartone da 100 pz.

Austenitic stainless steel Buckles, packed in cardboard box of 100 pieces.



MATERIALE MATERIAL	CODICE CODE	LARGHEZZA WIDTH	PER NASTRI FOR BAND	CARICO MEDIO DI ROTTURA AVERAGE BREAKING STRENGTH	SCATOLE BOX	PESO WEIGHT
		mm		kg	mt/cad	kg/cad
Acciaio inox Stainless steel AISI 304	WNG095304	9,50	AISI 201	390	100	0,5
	WNG127304	12,70	AISI 201	500	100	1,0
	WNG158304	15,80	AISI 201	650	100	1,3
	WNG195304	19,05	AISI 201	950	100	1,6
Acciaio inox Stainless steel AISI 316	WNG095316	9,50	AISI 316	340	100	0,5
	WNG127316	12,70	AISI 316	540	100	1,0
	WNG158316	15,80	AISI 316	680	100	1,3
	WNG195316	19,05	AISI 316	820	100	1,6

### SNU

UTENSILE MANUALE  
TOOL BANDI-BLOCK

Con questo utensile si può eseguire l'installazione completa, cioè il fissaggio con trazione ed il taglio della parte eccedente del nastro.

The tool allows for the full installation, that is fixing by pulling and cutting band exceeding part.



CODICE CODE	PER NASTRI FOR BAND	SCATOLE BOX	PESO WEIGHT
		pz/cad	kg/cad
WNU001	AISI 201 AISI 304 AISI 316	1	2,0





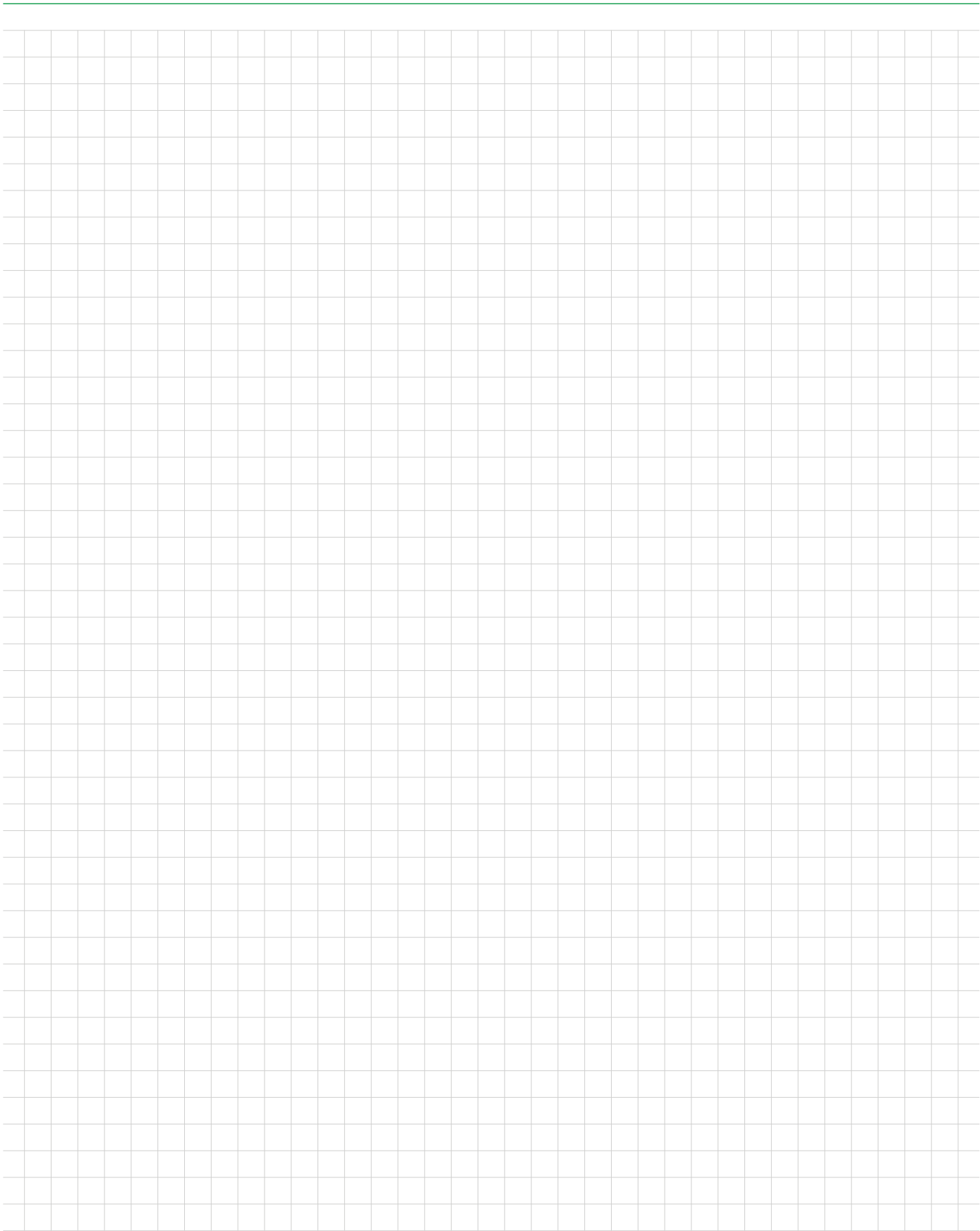



### BELTS DIVISION

RUBBER CONVEYOR BELTS



 **SATIBELT**

 **SATIVERTICAL**

### SHEETS DIVISION

RUBBER SHEETS AND FOAM



 **SATISHEET**

 **SATIFOAM**

### HOSES DIVISION

RUBBER AND PVC HOSES



 **SATIHOSE**

 **SATIHOSE**

MARINE

 **SATIBLOCK**



- **INTERA GAMMA PRODOTTI**  
FULL PRODUCT RANGE
- **SCHEDE TECNICHE**  
TECHNICAL DATA SHEETS
- **SOLUZIONI PER SETTORE**  
SECTORS SOLUTIONS
- **NOVITÀ**  
NEWS

VISIT OUR WEBSITE

**[www.satigroup.it](http://www.satigroup.it)**





**SATI GROUP S.P.A.**

Via Bonazzi, 24  
40013 Castel Maggiore  
Bologna - Italy  
T +39 051 700321  
[www.satigroup.it](http://www.satigroup.it)

Ufficio vendite italia  
[commerciale@satigroup.it](mailto:commerciale@satigroup.it)  
Ufficio vendite estero  
[export@satigroup.it](mailto:export@satigroup.it)

P. IVA 00672251204